

Operating Instructions

Panorama[®]

PATIENT MONITORING NETWORK

mindray

Operating Instructions

Panorama[®]

PATIENT MONITORING NETWORK

A decorative graphic featuring a sun with rays rising over a horizon, with a dark, wavy line curving across the scene.

mindray

DPM™ is a trademark of Mindray DS USA, Inc.

Masimo SET® is a U.S. registered trademark of Masimo Corp.

Mindray® is a trademark or registered trademark of Shenzhen Mindray Bio-Medical Electronics Co., Ltd.

Nellcor® is U.S. registered trademark of Tyco International Ltd.

Panorama® is a U.S. registered trademark of Mindray DS USA, Inc.

Passport® is a U.S. registered trademark of Mindray DS USA, Inc.

Spectrum® is a U.S. registered trademark of Mindray DS USA, Inc.

Symbol® is a U.S. registered trademark of Symbol Technologies, Inc.

Vigilance® is a U.S. registered trademark of Edwards Lifesciences Corporation.

View 12™ is a trademark of Mindray DS USA, Inc.

PureLight® is a U.S. registered trademark of the Nonin Medical, Inc.

Copyright © Mindray DS USA, Inc., 2009. All rights reserved. Contents of this publication may not be reproduced in any form without permission of Mindray DS USA, Inc.

Foreword	ix
Warnings, Cautions, and Notes	ix
Indications for Use	xvii
Unpacking Information	xviii
Symbols and Descriptions	xix
Technical Support	xx
System Overview	1 - 1
Licensing Key	1 - 2
Supported Devices	1 - 3
Panorama Central Station	1 - 3
Panorama ViewStation and WorkStation	1 - 3
Panorama Telemetry Server	1 - 4
Panorama Wireless Transceiver	1 - 4
Panorama Gateway	1 - 5
Panorama Web Viewer	1 - 5
Passport 2 Bedside Monitor	1 - 6
Passport V Bedside Monitor	1 - 8
Spectrum Bedside Monitor	1 - 10
Spectrum OR Bedside Monitor	1 - 12
DPM6 and DPM7 Bedside Monitors	1 - 14
V Series Monitors	1 - 16
Panorama Telepack	1 - 18
Network Printer	1 - 20
Troubleshooting	1 - 21
Getting Started	2 - 1
The Panorama Central Station	2 - 2
The ViewStation and the WorkStation	2 - 4
The Main Screen	2 - 7
Patient Tiles	2 - 7
Menu Bar	2 - 10
Tabs	2 - 14
Sidebar Buttons	2 - 15
Common Controls and Elements	2 - 16
Quick Reference Guide	2 - 21
Auto-Admitting a Patient	2 - 21
Standby	2 - 21
Discharge	2 - 22
Display	2 - 23
Patient Alarms	2 - 24
Viewing List Trends	2 - 25
Viewing Events	2 - 26
Viewing Disclosure Data	2 - 26
Troubleshooting	2 - 27
Alarm Behavior	3 - 1
General Alarm Behavior	3 - 2
Physiological Alarms	3 - 2
Alarm Behaviors	3 - 2
Alarm Options	3 - 3
Physiological Alarm Responses	3 - 4
Technical Alarms	3 - 6
Alarm Behaviors	3 - 6
Alarm Options	3 - 6

Alarm Responses	3 - 6
System Alarms	3 - 6
Alarm Behaviors	3 - 6
Arrhythmia and ST Analysis.....	4 - 1
Lead Placement Procedures	4 - 2
Skin Preparation	4 - 2
Electrode Patches.....	4 - 2
Lead Placement Methods: AHA and IEC	4 - 3
Arrhythmia Algorithm	4 - 11
ST Segment Analysis	4 - 13
Arrhythmia Alarms	4 - 14
Lethal Arrhythmia Alarms.....	4 - 15
Non-Lethal Arrhythmia Alarms	4 - 16
Troubleshooting	4 - 20
Patient Setup Functions	5 - 1
Demographics Tab.....	5 - 2
Communications with the Panorama Gateway	5 - 2
Accessing the Demographics Tab	5 - 3
Entering Data in the Demographics Tab	5 - 4
Sidebar Buttons	5 - 20
Troubleshooting.....	5 - 21
Transfer Tab	5 - 23
Accessing the Transfer Tab	5 - 23
Room To Room Transfer Without Device	5 - 23
Central To Central Transfer Without Device	5 - 25
Sidebar Buttons	5 - 29
Troubleshooting.....	5 - 32
Discharge Tab	5 - 37
Accessing the Discharge Tab	5 - 37
Discharging a Patient from the Central Station and the Bedside Monitor	5 - 37
Discharging a Patient from the Central Station.....	5 - 38
Discharging a Patient from a Telepack Device.....	5 - 39
Sidebar Button - Normal Screen	5 - 39
Troubleshooting.....	5 - 39
Display Tab.....	5 - 41
Accessing the Display Tab	5 - 41
Components of the Display Tab.....	5 - 42
Configuring the Display Tab	5 - 47
Sidebar Buttons	5 - 50
Troubleshooting.....	5 - 50
Standby Tab	5 - 51
Accessing the Standby Tab	5 - 51
Placing a Patient in Standby Mode	5 - 51
Removing a Patient from Standby Mode	5 - 52
Sidebar Button - Normal Screen	5 - 52
Troubleshooting.....	5 - 53
Wave Gain Tab (Patient)	5 - 54
Accessing the Wave Gain Tab (Patient).....	5 - 54
Changing a Patient's Wave Gain Settings	5 - 55
Sidebar Buttons	5 - 56
Troubleshooting.....	5 - 56
Print Setup Tab (Patient)	5 - 57

Accessing the Print Setup Tab.....	5 - 57
Changing a Patient's Print Setup.....	5 - 58
Sidebar Buttons.....	5 - 58
Troubleshooting.....	5 - 59
Patient Alarm Functions	6 - 1
Patient Alarm Setup Tab (Optional).....	6 - 2
Accessing the Patient Alarm Setup Tab.....	6 - 2
Entering a Password.....	6 - 2
Sidebar Buttons.....	6 - 3
Troubleshooting.....	6 - 3
Alarm Limits Tab (Patient).....	6 - 4
Accessing the Alarm Limits Tab.....	6 - 4
Configuring Patient Alarm Limits.....	6 - 5
Simultaneous Alarm Limit Editing.....	6 - 7
Sidebar Buttons.....	6 - 7
Generating a Patient Alarm Report.....	6 - 9
Testing Alarm Limits.....	6 - 9
Troubleshooting.....	6 - 10
Alarm Responses Tab (Patient).....	6 - 12
Accessing the Alarm Responses Tab.....	6 - 12
Configuring Alarm Responses.....	6 - 14
Sidebar Buttons.....	6 - 15
Troubleshooting.....	6 - 18
Views	7 - 1
Bedside Tab.....	7 - 2
Accessing the Bedside Tab.....	7 - 2
Bedside Tab (All Waveforms View).....	7 - 3
Generating an All Strips Report.....	7 - 8
Bedside Tab (All ECG View).....	7 - 9
Trends Tab.....	7 - 14
Accessing the Trends Tab.....	7 - 14
Trends Tab (List View).....	7 - 14
Trends Tab (Graphic View).....	7 - 20
Generating a Graphic Trend Report.....	7 - 22
Events Tab.....	7 - 24
Accessing the Events Tab.....	7 - 24
Events Tab (List View).....	7 - 25
Event Filtering.....	7 - 28
Events Tab (Waveforms View).....	7 - 34
Accessing the Waveforms View.....	7 - 34
Disclosure Tab.....	7 - 41
Accessing the Disclosure Tab.....	7 - 41
Disclosure Tab (Waveforms View).....	7 - 46
ST Tab.....	7 - 54
Accessing the ST Tab.....	7 - 54
Generating an ST Report.....	7 - 59
Troubleshooting.....	7 - 59
Report Functions	8 - 1
Patient Reports Tab.....	8 - 2
Accessing the Patient Reports Tab.....	8 - 2
All Strips Report.....	8 - 2
Full Disclosure Report.....	8 - 6

ST Report.....	8 - 14
Trend List Report.....	8 - 17
Event List Report.....	8 - 21
Patient Alarm Report.....	8 - 25
Troubleshooting.....	8 - 27
System Reports Tab.....	8 - 29
Accessing the System Reports Tab.....	8 - 29
All Strips (All Patients) Report.....	8 - 30
Equipment Report.....	8 - 34
Paging Report.....	8 - 35
Print Status Tab.....	8 - 38
Print Status Tab List Box.....	8 - 38
Removing Print Jobs from the Print Queue.....	8 - 38
Sidebar Buttons.....	8 - 39
Troubleshooting.....	8 - 39
Additional Reports.....	8 - 40
Accessing Additional Reports.....	8 - 40
Event Zoom In Report.....	8 - 40
Full Disclosure Zoom In Report.....	8 - 43
Printing a Full Disclosure Zoom In Report.....	8 - 46
Graphic Trend Report.....	8 - 47
12-lead Report.....	8 - 51
Telepack Error Log Report.....	8 - 53
System Alarm Report.....	8 - 55
Troubleshooting.....	8 - 58
System Setup Functions.....	9 - 1
Parameter Color Tab.....	9 - 2
Accessing the Parameter Color Tab.....	9 - 2
Selecting a Color for Parameter Data.....	9 - 2
Sidebar Button - Normal Screen.....	9 - 2
Troubleshooting.....	9 - 3
Touch Screen Tab.....	9 - 4
Accessing the Touch Screen Tab.....	9 - 4
Sidebar Button - Normal Screen.....	9 - 6
Troubleshooting.....	9 - 6
Installation Setup Tab.....	9 - 7
Accessing the Installation Setup Tab.....	9 - 7
Entering a Password.....	9 - 7
Sidebar Button - Normal Screen.....	9 - 8
Troubleshooting.....	9 - 8
Care Group Tab.....	9 - 9
Accessing the Care Group Tab.....	9 - 9
Editing Care Group Labels.....	9 - 9
Assigning a Patient Tile to a Care Group.....	9 - 10
Sidebar Button - Normal Screen.....	9 - 10
Troubleshooting.....	9 - 10
Volume Tab.....	9 - 11
Accessing the Volume Tab.....	9 - 11
Sidebar Button - Normal Screen.....	9 - 13
Troubleshooting.....	9 - 13
System Alarms Tab.....	9 - 14
System Alarms (Options) Tab.....	9 - 14

System Event Filtering.....	9 - 18
System Alarms (Alarm Limits) Tab	9 - 23
System Alarms (Alarm Responses) Tab.....	9 - 26
Passwords Tab	9 - 29
Accessing the Installation Setup Tab.....	9 - 29
Modifying a Default Password.....	9 - 30
Sidebar Button - Normal Screen	9 - 31
Troubleshooting.....	9 - 31
Equipment Setup Tab.....	9 - 33
Accessing the Equipment Setup Tab.....	9 - 33
Entering New Equipment.....	9 - 34
Modifying Equipment Included in the Equipment List	9 - 35
Deleting Equipment in the Equipment List	9 - 36
Sidebar Buttons	9 - 36
Troubleshooting.....	9 - 36
More Tab.....	9 - 39
Accessing Additional (More) Tabs	9 - 39
Previous Tab	9 - 40
Accessing Previous Tabs.....	9 - 40
Date/Time Tab	9 - 41
Accessing the Date/Time Tab.....	9 - 41
Set Date/Time.....	9 - 42
Sidebar Button - Normal Screen	9 - 44
Troubleshooting.....	9 - 44
Print Setup Tab (System).....	9 - 45
Accessing the Print Setup Tab (Central Station)	9 - 45
Accessing the Print Setup Tab (ViewStation and WorkStation)	9 - 46
Setting the System Default Print Setup.....	9 - 46
Troubleshooting.....	9 - 46
Unit Priorities Tab.....	9 - 47
Accessing the Unit Priorities Tab.....	9 - 47
Setting a Default Order in the Unit Priorities Tab.....	9 - 47
Sidebar Buttons	9 - 48
Troubleshooting.....	9 - 49
Unit Choices Tab	9 - 50
Accessing the Unit Choices Tab (Central Station)	9 - 50
Accessing the Unit Choices Tab (ViewStation and WorkStation)	9 - 50
Configuring Default Report Waveform Parameters	9 - 57
Sidebar Buttons	9 - 58
Troubleshooting.....	9 - 58
Wave Gain Tab (System).....	9 - 59
Accessing the Wave Gain Tab.....	9 - 59
Changing the System Default Wave Gain Settings.....	9 - 59
Sidebar Button - Normal Screen	9 - 60
Troubleshooting.....	9 - 61
Wireless Tab.....	9 - 62
Accessing the Wireless Tab	9 - 62
Entering Wireless Settings (Telepack-2.4)	9 - 63
Entering Wireless Settings (Telepack-608).....	9 - 66
Sidebar Buttons	9 - 68
Error Log Sidebar Button.....	9 - 69
Device ID.....	9 - 70

Connect Field.....	9 - 70
Troubleshooting.....	9 - 72
Telepack (Optional).....	10 - 1
Introduction.....	10 - 2
Button Indicators.....	10 - 3
Nurse Call Button.....	10 - 3
Attendant Present Buttons.....	10 - 3
LEAD SELECT Button.....	10 - 3
CHECK Button.....	10 - 4
RECORD Button.....	10 - 4
Indicator Lights.....	10 - 4
ECG Lead Diagram LED Indicator Lights.....	10 - 4
Link Status LED Indicator Light.....	10 - 6
Battery Status LED Indicator Light.....	10 - 6
Operating Instructions.....	10 - 7
Initial Setup of Telepack.....	10 - 7
Securing the Telepack Device.....	10 - 9
Telepack with Nonin SpO ₂ Module (Optional).....	10 - 10
Introduction.....	10 - 10
Installing the SpO ₂ Module on the Telepack.....	10 - 10
Removing the SpO ₂ Module from the Telepack.....	10 - 11
Installing the Patient Cable.....	10 - 12
Attaching the Finger Clip Sensor.....	10 - 13
Removing the Patient Cable.....	10 - 14
Approved Telepack Accessories.....	10 - 15
Troubleshooting.....	10 - 17
User Maintenance.....	11 - 1
Touch Screen User Maintenance.....	11 - 2
Care and Cleaning of the Touch Screen.....	11 - 2
Telepack User Maintenance.....	11 - 3
Storing the Telepack.....	11 - 3
Cleaning and Disinfecting the Telepack Device.....	11 - 3
Cleaning the SpO ₂ Module.....	11 - 5
Cleaning the SpO ₂ Finger Clip Sensor.....	11 - 6
Disposal of the Telepack Device.....	11 - 6
Disposing of Batteries.....	11 - 7
Parameter Specifications.....	12 - 1
Parameter Specifications.....	12 - 2
Heart Rate: HR.....	12 - 2
Respiration: Resp.....	12 - 2
NIBP.....	12 - 3
SpO ₂	12 - 4
Nonin SpO ₂	12 - 5
IBP: mmHg.....	12 - 5
CO ₂	12 - 6
O ₂	12 - 6
INSP/ET O ₂	12 - 6
N ₂ O.....	12 - 7
Anesthetic Agents: Iso, Enf, Des, Sev, Hal, Agent.....	12 - 7
Premature Ventricular Contraction (PVC).....	12 - 8
Temp: T1, T2, T3, Delta T, and T Blood.....	12 - 8
ST.....	12 - 9

Cardiac Output	12 - 10
Cardiac Index	12 - 10
Continuous Cardiac Output (CCO)	12 - 10
Continuous Cardiac Output STAT (CCO STAT)	12 - 10
Continuous Cardiac Index (CCI)	12 - 11
Continuous Cardiac Index STAT (CCI STAT)	12 - 11
System Vascular Resistance (SVR)	12 - 11
System Vascular Resistance Index (SVRI)	12 - 11
Mixed Venous Saturation (SvO ₂)	12 - 12
Central Venous Oxygen Saturation (ScvO ₂)	12 - 12
Pulmonary Artery Wedge Pressure (PAWP)	12 - 12
Battery Percentage	12 - 12
Invalid Data Display	12 - 13
Alarms and Events	13 - 1
Physiological Alarms and Events	13 - 2
Alarm Limit Settings	13 - 2
Physiological Alarm Event Messages	13 - 14
Physiological Alarms and Events: Arrhythmias	13 - 17
Technical Alarms and Events	13 - 19
System Event Messages and Error Codes	13 - 25
Operator Position	13 - 26
Alarm Verification	13 - 26
Network Tab (Optional)	14 - 1
Network Tab	14 - 2
Accessing the Network Tab	14 - 2
Sorting the Contents of the Network Tab List Box	14 - 2
Assigning Patient Tiles in the Network Tab	14 - 2
Removing a Patient Tile Assignment in the Network Tab	14 - 4
Removing All Patient Tile Assignments in the Network Tab	14 - 4
Refreshing the Network Tab List Box	14 - 4
Troubleshooting	14 - 5
Paging Tab (Optional)	15 - 1
Paging Password Tab	15 - 2
Accessing the Paging Tab	15 - 2
Entering a Password	15 - 2
Sidebar Buttons	15 - 3
Troubleshooting	15 - 3
Paging Tab	15 - 4
Accessing the Paging Tab	15 - 4
Adding a Pager	15 - 4
Assigning a Patient Tile	15 - 5
Adding All Patient Tiles to a Pager	15 - 6
Removing a Patient Tile Assignment	15 - 6
Removing All Patient Tiles from a Pager	15 - 6
Editing a Pager	15 - 7
Removing a Pager	15 - 7
Resending a Failed Page	15 - 8
Generating a Paging Report	15 - 9
Troubleshooting	15 - 9
Performance Specifications	16 - 1
ECG Performance Requirements	16 - 2
ECG Derived Heart Rate Meter Performance Requirements	16 - 4

Alarm Response	16 - 4
ST Segment Analysis	16 - 4
Arrhythmia Analysis	16 - 5
NIBP Performance Characteristics	16 - 5
IBP Pressure Range	16 - 6
IBP Heart Rate Meter	16 - 6
Temperature Performance Requirements	16 - 6
ECG Respiration Performance Requirements	16 - 6
SpO ₂	16 - 6
Nonin SpO ₂	16 - 7
CO ₂ Performance Requirements	16 - 7
CO ₂ Alarm	16 - 7
Panorama Central Station and Panorama Telemetry Server	16 - 8
Real Time Clock	16 - 8
Power Supply	16 - 9
Operating Temperature	16 - 9
Operating Humidity	16 - 9
Operating Altitude	16 - 9
Storage Temperature	16 - 9
Storage Humidity	16 - 9
Storage Altitude	16 - 9
Standards	16 - 10
Information Display and Control	16 - 11
Electromagnetic Compatibility	16 - 12
Physical Characteristics	16 - 16
Keyboard	16 - 16
Mouse	16 - 16
Displays	16 - 16
21" CRT Display	16 - 16
20" CRT Display	16 - 17
19" Flat Panel	16 - 17
18.1" Flat Panel	16 - 17
Touch Screen	16 - 18
Network Printer	16 - 18
Requirements	16 - 18
Access Points/Antennas	16 - 18
Panorama Wireless Transceiver/Splitters/Antennas/Cable Repeaters	16 - 19
Panorama Wireless Transceiver	16 - 19
Panorama Antenna	16 - 19
Cable Repeater	16 - 20
Splitter	16 - 20
Environmental Characteristics for the Panorama Wireless Transceiver/Splitters/Antennas	16 - 20
Telepack Specifications	16 - 22
Safety Designations	16 - 22
Panorama Server Analysis	16 - 22
Environmental Characteristics	16 - 23
Electromagnetic Compatibility	16 - 23
FCC Labeling	16 - 28
Compliance	16 - 28
Specific Absorption Rate	16 - 29
Nonin SpO ₂ Module Specifications	16 - 30
Environmental Characteristics	16 - 30

Measurement Specifications.....	16 - 30
Electromagnetic Compatibility	16 - 31
Panorama Instrument Radio-608	16 - 34
Approved Accessory.....	16 - 34
FCC Label	16 - 34
Glossary.....	17 - 1
Terms, Acronyms, and Abbreviations	17 - 2

This page intentionally left blank.

Foreword

The Panorama Operating Instructions are intended to provide the information required to operate the Panorama Patient Monitoring Network. For additional information and technical assistance, please contact an area or regional Representative.

A general understanding of the features and functions of the Panorama Patient Monitoring Network and its components is a prerequisite for the proper use of this equipment. Therefore, do not operate this equipment before reading these instructions thoroughly, including all appropriate warnings and cautions.

CAUTION: **US Federal law restricts the sale of this device to, by or on the order of a physician.**

NOTE: **Figures in this manual are provided for reference purposes only. Screens will likely differ based on the monitoring device configuration, licenses available, parameters selected and patient configuration of the Panorama Patient Monitoring Network.**

Warnings, Cautions, and Notes

Please read and adhere to all of the warnings and cautions listed throughout this manual.

A **WARNING** is provided to alert the user to potentially serious outcomes (death, injury or serious adverse events) to the patient or the user.

A **CAUTION** is provided to alert the user that special care should be taken for the safe and effective use of the device. They will include actions to be taken to avoid effects on patients or users that will not be potentially life threatening or result in serious injury, but about which the user should be aware.

A **NOTE** is provided when additional general information is available.

Warnings

- WARNING:** Only qualified and trained personnel or Service Personnel should attempt to service the equipment. Service is defined as any activity requiring the cover to be removed for internal adjustments, parts replacements, repairs or software upgrades of any kind to insure compatibility.
- WARNING:** To insure compatibility with the operating system and applications software, use only approved components to repair any part of the Panorama Patient Monitoring Network. Use of unauthorized software, devices, accessories, or cables may render the application unsuitable for medical patient monitoring. It may also result in increased electromagnetic emissions or decreased Immunity of the system.
- WARNING:** Route cables neatly. Ensure cables are not in the way of patient or hospital personnel.
- WARNING:** Do not incinerate batteries, possible explosion may occur.
- WARNING:** Some of the equipment on the Panorama Patient Monitoring Network must utilize the hospital emergency power system. Failure to do so will result in loss of monitoring during extended periods of power failure. The back-up power time period, for the Panorama Patient Monitoring Network, is limited.
- WARNING:** The 18.1" flat panel may tip over, if the display head is inclined to an angle greater than 45° backward tilt. If the user elects to have the display head inclined to an angle greater than 45° backward tilt, the flat panel must be attached to a secure mounting surface via three screw locations on the bottom of the base.
- WARNING:** Do not put MPSO (Multiple Portable Socket Outlets, i.e., multiple outlet extension cords) used with the Panorama Patient Monitoring Network equipment on the floor. Connect only approved accessories and components to the same MPSO as the Panorama Patient Monitoring Network equipment. Do not overload MPSOs. Use only MPSOs that comply with the requirements of IEC 60601-1-1.
- WARNING:** Incorrect setting or silencing of patient alarms can jeopardize patient safety.
- WARNING:** Operator should check that the current alarm presets are appropriate prior to use on each patient.
- WARNING:** When the Suspend Non-Lethal alarms sidebar button is enabled, the Panorama Central Station will not monitor any priority 2 and priority 3 non-lethal arrhythmias, and will not display numeric physiological or technical alarms for the selected patient tile.
- WARNING:** When the Suspend All Alarms sidebar button is enabled, the Panorama Central Station will not monitor any lethal or non-lethal arrhythmias and will not display numeric physiological or technical alarms for the selected patient tile.

-
- WARNING:** The Telepack should not be used adjacent to or stacked with other equipment. If adjacent or stacked use is necessary, the Telepack should be observed to verify normal operation in the configuration in which it will be used.
- WARNING:** The Telepack with Nonin SpO₂ module should only be used with Nonin-manufactured PureLight® pulse oximeter sensors. Using other manufacturers' sensors can result in inaccurate pulse oximeter performance.
- WARNING:** Do not use the Telepack with Nonin SpO₂ module in an explosive atmosphere or in the presence of flammable anesthetics or gases.
- WARNING:** Loss of SpO₂ monitoring when using the Telepack with Nonin SpO₂ module can result if any objects hinder the pulse measurement. Ensure that no blood flow restrictions (e.g. blood pressure cuff) hinder pulse measurements.
- WARNING:** The Telepack with Nonin SpO₂ module does not meet defibrillation-proof requirement per IEC 60601-1: 1990, clause 17.h.
- WARNING:** Operation of the Telepack with Nonin SpO₂ module below the minimum amplitude of 0.3% modulation may cause inaccurate SpO₂ results.
- WARNING:** Do not use the Telepack and/or the Telepack with Nonin SpO₂ module during MRI (Magnetic Resonance Imaging) scanning. Induced current could potentially cause burns. Accuracy of measurements on this unit and the MRI unit may also be affected.
- WARNING:** Do not use a damaged SpO₂ sensor.
- WARNING:** Using unapproved accessories, sensors, and cables may result in increased emission and/or decreased immunity of this device.
- WARNING:** As with all medical equipment, carefully route cables and connections to reduce the possibility of entanglement or strangulation.
- WARNING:** PACEMAKER PATIENTS - Indication of the heart-rate may be adversely affected by cardiac pacemaker pulses or by cardiac arrhythmias. Keep pacemaker patients under close surveillance. Refer to "ECG Performance Requirements" on page 16-2 for disclosure of the pacer rejection capability.
- WARNING:** PACEMAKER PATIENTS - Rate meters may continue to count the pacemaker rate during occurrences of cardiac arrest or some arrhythmias. Do not rely entirely upon rate meter alarms. Keep pacemaker patients under close surveillance.
- WARNING:** Changing the patient alarm limits at the WorkStation will automatically change the patient alarm limits at the Panorama Central Station AND the bedside monitor (if applicable) for the selected patient file.

Cautions

- CAUTION:** For proper operation do not obstruct the fan air holes.
- CAUTION:** For proper operation use only hospital grade power cords.
- CAUTION:** For proper operation, do not use the Panorama Patient Monitoring Network equipment with a frayed or damaged power cord.
- CAUTION:** For proper operation never place fluids on top of this equipment. In case of accidental spillage, wipe clean immediately and have the system serviced to ensure no hazard exists.
- CAUTION:** Do not block the speakers. Set the volume levels so that alarms can be heard at all times, as described in this Operation Manual.
- CAUTION:** Dispose of single use items in accordance with hospital policy.
- CAUTION:** The bedside device should be disconnected from the Panorama Central Station when changing the CO₂ units of measurement.
- CAUTION:** For proper monitoring of patient information, do not block the operators' clear view of the Panorama Patient Monitoring Network data display(s).
- CAUTION:** If passwords are changed from the factory defaults, users **MUST** ensure that they document new passwords in the space provided in this manual. For additional information refer to "Passwords Tab" on page 9-29. Failure to recall user defined passwords will render the system **UNUSABLE**.
- CAUTION:** The Panorama Telepack and Instrument Radio are wireless devices and may be subject to intermittent signal dropout. Panorama wireless devices are designed to perform with a maximum cumulative signal dropout of one minute in a 24-hour period under ideal conditions. A crowded wireless environment or interference from other medical or non-medical devices, either intentional (e.g., VOIP phones, pagers, asset tracking systems, etc.) or unintentional (e.g., AC motors, microwave ovens, paper shredders, etc.), may result in a significantly increased amount of signal dropout experienced by any one or multiple wireless device(s).
- CAUTION:** Operation of the wireless product requires the prior coordination with a frequency coordinator designated by the FCC for the Wireless Medical Telemetry Service.
- CAUTION:** Changes or modifications not expressly approved by Mindray DS USA, Inc. could void the user's authority to operate the equipment.
- CAUTION:** The Telepack and the Telepack with Nonin SpO₂ module should not be used when the Electro Surgical Unit (ESU) is active.
- CAUTION:** To avoid potential system issues, deactivate the touch screen before cleaning.

-
- CAUTION:** DO NOT spray glass cleaner directly on a display as it could possibly leak inside a non-sealed unit and cause damage.
- CAUTION:** Follow your hospital protocol for handling of blood and body fluids.
- CAUTION:** The use of the Telepack may affect the functioning of other medical electrical equipment operating in the same frequency band.
- CAUTION:** Conductive parts of electrodes and associated connectors for applied parts and neutral electrode should not contact other conductive parts and earth.
- CAUTION:** The Telepack may not function properly, if it was subjected to extreme mechanical forces.
- CAUTION:** The Telepack may not function if the batteries installed in the device are corroded. Use only approved batteries (P/N 0146-00-0077-01) in the Telepack and observe proper polarity. Installing batteries with the incorrect polarity may cause the batteries to become excessively warm.
- CAUTION:** The Telepack should not be attached to the patient when the device is being programmed into the system.
- CAUTION:** Ensure that the ECG lead cable is plugged into the port firmly, the end cap of the battery is firmly secured and the serial port is also secured with the protective plug to prevent fluids from entering into the Telepack.
- CAUTION:** When disconnecting ECG leads from the patient, do not pull on the leadsets. This will decrease the life of the leadsets. Grasp the connectors on the leadset and pull gently.
- CAUTION:** Ensure that the lead wires are not inadvertently caught in the bed rails. If this happens, the insulation may get cut or the leadset may break.
- CAUTION:** Using more than one type of electrode on the same patient should be avoided because of variations in electrical resistance.
- CAUTION:** The LEDs on the Telepack may not be clearly visible under brightly lit conditions. The lighting should be adjusted to ensure that all LED indicators are clearly visible.
- CAUTION:** The user should monitor the Panorama Central Station for messages from the Telepack that indicate a low battery condition.
- CAUTION:** Periodically press the CHECK button on the Telepack to verify the battery condition.
- CAUTION:** Some pacemakers may contain a respiratory sensor that may produce artifact on an ECG waveform.
- CAUTION:** Prior to sterilization, lead sets must be removed from the Telepack. The Telepack and/or the Telepack with Nonin SpO₂ must not be sterilized.
- CAUTION:** Visually inspect the battery compartment for any foreign object prior to use.

- CAUTION:** Ensure that the batteries are removed when the Telepack is being stored.
- CAUTION:** Tissue damage or inaccurate SpO₂ measurements may be caused by incorrect sensor application or use, such as wrapping too tightly, applying supplemental tape, failing to inspect the sensor site periodically, or failing to position appropriately. Carefully read the sensor directions for use, the Panorama Operating Instructions, and all precautionary information before use.
- CAUTION:** The accuracy of the SpO₂ measurement may be affected if the total cable length (including extension cables) is greater than 3.28 yards (3 meters).
- CAUTION:** Inaccurate SpO₂ measurements may be caused by:
- Incorrect sensor application or use
 - Significant levels of dysfunctional hemoglobins, (e.g., carboxyhemoglobin or methemoglobin)
 - Intra-vascular dyes such as indocyanine green or methylene blue
 - Exposure to excessive illumination such as surgical lamps (especially ones with a xenon light source), bilirubin lamps, fluorescent lights, infrared heating lamps, or excessive ambient light. In such cases, cover the sensor site with opaque material.
 - Excessive patient movement
 - Venous pulsations
 - Electro-surgical interference
 - Placement of a sensor on an extremity that has a blood pressure cuff, arterial catheter, or intra-vascular line.
 - Cold extremities due to reduced circulation.
 - Nail polish or fungus
- CAUTION:** In certain situations in which perfusion and signal strength are low, such as in patients with thick or pigmented skin, inaccurately low SpO₂ readings will result. Verification of oxygenation should be made, especially in patients with chronic lung disease, before instituting any therapy or intervention.
- CAUTION:** Many patients suffer from poor peripheral perfusion due to hypothermia, hypovolemia, severe vasoconstriction, reduced cardiac output, etc. These symptoms may cause a loss in vital sign readings.
- CAUTION:** Prolonged and continuous monitoring may increase the risk of skin erosion and pressure necrosis at the site of the sensor. Check the SpO₂ sensor site frequently to ensure proper positioning, alignment and skin integrity at least every eight (8) hours; with the Adult and Pediatric re-usable finger sensor, check every four (4) hours; for patients of poor perfusion or with skin sensitive to light, check every 2 - 3 hours; more frequent examinations may be required for different patients. Change the sensor site if signs of circulatory compromise occur.

- CAUTION:** The Telepack with Nonin SpO₂ module has motion tolerant software that minimizes the likelihood of motion artifact being misinterpreted as good pulse quality. In some circumstances, however, the Telepack with Nonin SpO₂ module may still interpret motion as good pulse quality. This applies to all available outputs (i.e. SpO₂, HR, Pleth, PPG).
- CAUTION:** A functional tester cannot be used to assess the accuracy of the pulse oximeter probe or a pulse oximeter monitor.
- CAUTION:** The Telepack with Nonin SpO₂ module complies with International Standard IEC 60601-1-2:2005 for electromagnetic compatibility for medical electrical equipment and/or systems. This standard is designed to provide reasonable protection against harmful interference in a typical medical installation. However, because of the proliferation of radio-frequency transmitting equipment and other sources of electrical noise in healthcare and other environments, it is possible that high levels of such interference due to close proximity or strength of a source might disrupt the performance of this device. Medical electrical equipment needs special precautions regarding EMC, and all equipment must be installed and put into service according to the EMC information specified in this manual.
- CAUTION:** Use the designated cleaning plug (P/N 0003-00-0055) when cleaning and disinfecting the Nonin SpO₂ module. If fluids enter the device, it may affect the functionality of the module or render it unusable.
- CAUTION:** In compliance with the European Directive on Waste Electrical and Electronic Equipment (WEEE) 2002/96/EC, do not dispose of this product as unsorted municipal waste.
- CAUTION:** It is important to notify Service personnel when the system event message "System Service required - Contact Mindray or Authorized Mindray Distributor (300)." is displayed. This message indicates that while data was being written to or read from the system hard drive, an error was detected. Until service personnel correct this issue, patient data may be lost (for example, demographic information, alarm configurations, and historical patient data). Real time parameter monitoring and alarm checking will not be affected by this message. This message will be displayed until reset by service personnel.
- CAUTION:** DANGER OF EXPLOSION IF BATTERY IS INCORRECTLY REPLACED. REPLACE ONLY WITH THE SAME OR EQUIVALENT TYPE RECOMMENDED BY THE MANUFACTURER. DISPOSE OF USED BATTERIES ACCORDING TO THE MANUFACTURER'S INSTRUCTIONS.
- ATTENTION:** IL Y A DANGER D'EXPLOSION S'IL Y A REMPLACEMENT INCORRECT DE LA BATTERIE, REMPLACER UNIQUEMENT AVEC UNE BATTERIE DU MÊME TYPE OU D'UN TYPE ÉQUIVALENT RECOMMANDÉ PAR LE CONSTRUCTEUR. METTRE AU REBUT LES BATTERIES USAGÉES CONFORMÉMENT AUX INSTRUCTIONS DU FABRICANT.)

CAUTION: If the Panorama system experiences a communication loss, all Telepack ST and/or arrhythmia alarms that were active at the time of communication loss will not produce central station alarm notifications once communication is restored. This is due to the automatic relearn function of the ST and/or arrhythmia algorithm after communication is restored.

Indications for Use

Panorama Patient Monitoring Network

The indications for use for the Panorama Patient Monitoring Network include:

- A.** Viewing real time patient clinical and demographic data
- B.** Graphical and numeric trending of clinical data
- C.** Storing and printing of clinical and demographic data
- D.** Setting independent alarm limits for data sent by the bedside monitor.

The clinical data displayed by the Panorama Patient Monitoring Network is obtained from one or more compatible physiological monitors and includes: ECG waveforms, Invasive and Non-Invasive Blood Pressure, Blood Oxygenation (SpO₂), Heart Rate, Respiration Rate, Temperature, CO₂ inspired and end tidal, Ventricular Arrhythmia analysis and ST Segment analysis.

The Panorama Patient Monitoring Network is intended for use in a fixed location, in the healthcare facility setting, as a central viewing station. The Panorama Patient Monitoring Network is not intended to be directly connected to the patient at any time or installed in a patient's vicinity.

Panorama Telemetry System

The Panorama Telemetry System is intended for use under the direct supervision of a licensed healthcare practitioner. The system is designed to acquire and monitor physiological data for ambulating patients within a defined coverage area. The system processes the physiological data to detect various ECG arrhythmia events and select physiological parameter limit violations.

























The Panorama Telemetry System is intended for installation in a hospital or clinical environment to provide clinicians with patient physiological data, while allowing for patient mobility.

The physiological parameters monitored include ECG, Heart Rate from ECG, Lethal and Non-Lethal Arrhythmia Detection and ST Segment Analysis. Received data is sent to the Panorama Server for ECG processing via Ethernet. This information can be displayed, trended, stored and printed at the Panorama Central Station.

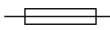
Unpacking Information

The Panorama Patient Monitoring Network must be installed by a certified Service Technician or authorized distributor. Please contact your authorized Service Representative for additional information.

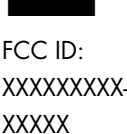
Symbols and Descriptions

SYMBOL	DESCRIPTION	SYMBOL	DESCRIPTION
	Attention, Consult Accompanying Documents / Refer to Manual		Touchscreen
	Alternating Current (AC)		Alarm On
	Direct Current (DC)		Defibrillator proof - type CF equipment
	Keyboard		Alarm Off
	Mouse		Alarm Mute
	Input/Output		Earth Ground
	Speaker		Patient Network Panorama Patient Network Ethernet
	Speaker Output		Central Network Panorama Central Network Ethernet
	Monitor		Telemetry Network Panorama Telemetry Network Wireless
	Electrical Hazard		Fuse (IEC)
	Battery type and position		Classified by Underwriter's Laboratories Inc.
	Do not dispose of this product as unsorted municipal waste.		Mark of compliance with U.S. and Canadian safety standards requirement.
	Federal Communication Commission Registration Identification Number		Non-Ionizing Electromagnetic Radiation

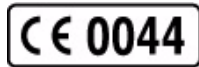
SYMBOL**DESCRIPTION**

A symbol designating compliance of the Panorama Central Station Monitoring system with the Medical Device Directive (MDD) 93/42/EEC, as a Class IIb device.

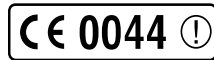

A symbol designating compliance of the Telepack with the Medical Device Directive (MDD) 93/42/EEC, as a Class IIb medical device and compliance with the Radio and Telecommunications Terminal Equipment Directive (R&TTE) 1995/5/EC as a Class 2 device.



A symbol designating compliance of the Panorama Central Station tower and the Panorama Telemetry Server with the Electromagnetic Compatibility Directive and compliance of the Panorama Patient Monitoring Network accessories to the Medical Device Directive (MDD) as Class I devices.



Electrostatically sensitive



Type BF applied part

Protection against ingress of liquids (please refer to your device):

IPX 0

Not protected (ordinary)

IPX 4

Protection against splashing water

Technical Support

For technical assistance please contact your area or regional Service Representative.

Additional information relating to the installation, servicing and repair of the Panorama Patient Monitoring Network is provided in the following documents:

Panorama WMTS Installation Guide (P/N 0070-00-0571)

Panorama Service Manual (P/N 0070-00-0634)

Panorama Printer Configuration Manual (P/N 0070-00-0561)

System Overview

This section provides a high level view of the authorized components of the Panorama Patient Monitoring Network.

- Licensing Key
- Supported Devices
- Troubleshooting

1.1 Licensing Key

The Panorama Central Station uses a licensing key to regulate the operation of the system.

The licensing key controls the following settings on the Panorama Central Station:

- Number of monitoring channels; up to 16
- Number of ST licenses
- Number of arrhythmia licenses
- Number of displays
- Storage hours of full disclosure (1 hour (default), 24 hours, 48 hours, 72 hours)
- 12-lead data management using a View 12™ card
- Activates the communication between the Panorama Central Station(s), the ViewStation(s), and the WorkStation(s)
- Paging

For additional information regarding licensing keys, please have a system administrator contact a Service Representative.

1.2 Supported Devices

The Panorama Patient Monitoring Network consists of two local area networks (LAN): a Panorama Central Network (C-LAN) and a Panorama Patient Network (E-LAN). The C-LAN manages stored patient data and controls the data flow between systems. The E-LAN manages real-time data by controlling the flow of data that is transmitted to/from the bedside monitors, and the Panorama Wireless Network.

The Network may include some or all of the following devices:

- Panorama Central Station
- Panorama ViewStation
- Panorama WorkStation
- Panorama Telemetry Server
- Panorama Wireless Transceiver
- Panorama Gateway
- Panorama Web Viewer
- Passport 2 Bedside Monitor
- Passport V Bedside Monitor
- Spectrum Bedside Monitor
- Spectrum OR Bedside Monitor
- DPM6 and DPM7 Bedside Monitors
- V Series Monitors
- Panorama Telepack
- Network Printer

1.2.1 Panorama Central Station

The Panorama Central Station is a device that monitors patients, collects and stores data, and performs alarm notification. Multiple Panorama Central Stations can be networked with other Panorama Central Stations using Ethernet via the C-LAN. Communication between the C-LAN and the Panorama Patient Network is managed through the Panorama Central Station. A maximum of two displays can be used with each Panorama Central Station.

1.2.2 Panorama ViewStation and WorkStation

The Panorama ViewStation provides the capability to display patient data (including digital data and waveforms) with assigned monitoring equipment, to be viewed at a remote location. Patient data is transmitted from a bedside or ambulatory monitoring device to a central station on the C-LAN and is then transmitted to the ViewStation and the WorkStation, if these remote workstations exist on the network. The central station, which transmits the patient data, is referred to as the **host** central station.

All the patient information that can be displayed at the host central station can be seen at the ViewStation and WorkStation once the patient is assigned to a patient tile at the remote workstation. Minor configuration changes, such as Display and Wave Gain settings, can be made directly from the ViewStation. However, changes to patient configuration settings such as alarm settings or patient demographic information must be performed at the host central station. More significant configuration changes can be made at the WorkStation, such as changing alarm limits, alarm responses, and altering patient demographic information.

The ViewStation and the WorkStation may use either a single or dual display. Single display setups can accommodate eight (8) or twelve (12) patient tiles. Dual display setups can accommodate up to eight (8) patient tiles per display, showing a maximum of sixteen (16) patient tiles between the two displays.

1.2.3 Panorama Telemetry Server

The Panorama Telemetry Server is provided when the Panorama Wireless Network is required. It acts as a bridge to connect wireless monitoring devices, such as Telepacks or wireless bedside monitors, to the Panorama Central Station. The Panorama Telemetry Server receives data from the wireless monitoring devices and converts it into a protocol recognized by the Panorama Central Station. For wireless communication in the Wireless Medical Telemetry Service (WMTS) band, a Panorama Wireless Transceiver and radios are required, which transmit and/or receive data to/from remote devices using WMTS communication. For wireless communication in the Industrial Scientific Medical (ISM) band, access points and radios are required, which transmit and/or receive data to/from remote devices using ISM communication.

The Panorama Telemetry Server communicates with the following remote devices:

- Panorama Telepack-608 and Panorama Telepack-608 with Nonin SpO₂ module
- Panorama Instrument Radio-2.4 and Panorama Instrument Radio-608

CAUTION: The Panorama Telepack and Instrument Radio are wireless devices and may be subject to intermittent signal dropout. Panorama wireless devices are designed to perform with a maximum cumulative signal dropout of one minute in a 24-hour period under ideal conditions. A crowded wireless environment or interference from other medical or non-medical devices, either intentional (e.g., VOIP phones, pagers, asset tracking systems, etc.) or unintentional (e.g., AC motors, microwave ovens, paper shredders, etc.), may result in a significantly increased amount of signal dropout experienced by any one or multiple wireless device(s).

1.2.4 Panorama Wireless Transceiver

NOTE: The Panorama Wireless Transceiver is used for WMTS installations only.

The Panorama Wireless Transceiver and its components serve as a bridge between the hardwired and the wireless infrastructures. A patient using instrument telemetry can transition from hardwired to wireless, and back, while being monitored from the same screen location at the central station. Communication for both hardwired and wireless monitoring is capable of supporting coverage over large areas, or on different floors of the hospital.

The Panorama Wireless Transceiver and its components control the local wireless network, and are responsible for:

- Providing protocol conversion for telemetry equipped Mindray products.
- Receiving control information and patient data from telemetry equipped Mindray products.

- Sending control information to telemetry equipped Mindray products.
- Acting as a conduit for moving data between the wireless network and the hardwired network via Panorama Telemetry Server.

The Panorama Wireless Transceiver device contains four LED indicator lights. The indicator lights function as follows:

DEVICE LABEL	LED COLOR	DESCRIPTION
Power	Green	Power is applied.
Fault	Red	There is a fault in the device configuration.
Configured	Yellow	The device is configured for use.
Status	Blue	The link between the Telemetry Server and the Wireless Transceiver is not functioning.

CAUTION: Operation of the wireless product requires the prior coordination with a frequency coordinator designated by the FCC for the Wireless Medical Telemetry Service.

1.2.5 Panorama Gateway

The Panorama Gateway enables hospitals to maintain a continuous and comprehensive history of a patient's clinical information through the use of electronic medical records (EMR).

Bi-directional communication through the Panorama Gateway enables Admit data transfer between the C-LAN and the HIS/CIS.

Additional Information

For additional information regarding the Panorama Gateway, refer to "Communications with the Panorama Gateway" on page 5-2.

1.2.6 Panorama Web Viewer

The Panorama Web Viewer software application provides remote intranet access to any admitted patient on the Panorama Patient Monitoring Network.

Additional Information

For additional information regarding the Panorama Web Viewer application, refer to the Panorama Web Viewer Operating Instructions (P/N 0070-00-0681-XX).

1.2.7 Passport 2 Bedside Monitor

Passport 2 bedside monitors are used to monitor patient data and may use either a hardwired or a wireless (2.4 GHz or 608 MHz) configuration. The Passport 2 sends data to the Panorama Central Station for analysis and storage via an Ethernet connection or remotely via the Panorama Telemetry Server. The data collected by the Passport 2 is based on the type of lead wire set and sensors used.

If an alarm in the following table does not have an associated footnote, it may occur using any lead wire set.

Parameters/Waveforms

PARAMETERS	SETTINGS	PANORAMA ALARMS
ECG/Heart Rate	Leads I, II, III are available with a 3-wire lead set. Leads I, II, III, aVR, aVL, aVF, V are available with a 5-wire lead set. Leads I, II, III, aVR, aVL, aVF, V1, V2, V3, V4, V5, V6 are available with a View 12™ card. (View 12 supported by Passport 2 hardwired and WMTS 608)	Low Heart Rate High Heart Rate
ST	ST analysis is in use at the bedside device.	ST Single ST Dual
PVC/min.	Arrhythmia analysis is in use at the bedside device.	Asystole Bigeminy Brady ² Couplet Irregular Heart Rate ² Pause ¹ High PVC Run Trigeminy V-Fib V-Rhythm V-Tach
Respiration (Source: ECG, CO ₂ and Gas ³ Module)	Respiration is in use at the bedside and is derived from a valid source.	Low Respiration High Respiration Apnea
SpO ₂	SpO ₂ sensor is in use at the bedside device.	Low SpO ₂ High SpO ₂
IBP1/IBP2 (Systolic, Diastolic, Mean)	IBPx option is in use at the bedside device. IBP parameter labels include IBP, Art, UA, LV, PA, CVP, ICP, LA and RA. The label used is based on the label selected at the bedside monitor.	Low IBPx Systolic High IBPx Systolic Low IBPx Diastolic High IBPx Diastolic Low IBPx Mean High IBPx Mean
NOTE: x = 1 or 2		
INSP/ET CO ₂	Gas Module is in use at the bedside device.	High CO ₂ Inspired Low CO ₂ End Tidal High CO ₂ End Tidal

¹ Alarm will only be detected when using a View 12™ card.

² Alarm will not be detected when using a View 12™ card.

³ Waveform not supported when using a WMTS 608 bedside device.

Parameters/Waveforms (Continued)

PARAMETERS	SETTINGS	PANORAMA ALARMS
INSP/ET O ₂ ³	Gas Module is in use at the bedside monitor.	O ₂ Inspired O ₂ End Tidal
INSP/ET N ₂ O ³	Gas Module is in use at the bedside monitor.	N ₂ O Inspired N ₂ O End Tidal
INSP/ET Iso ³	Gas Module is in use at the bedside monitor.	Agent Iso Inspired Agent Iso End Tidal
INSP/ET Enf ³	Gas Module is in use at the bedside monitor.	Agent Enf Inspired Agent Enf End Tidal
INSP/ET Des ³	Gas Module is in use at the bedside monitor.	Agent Des Inspired Agent Des End Tidal
INSP/ET Sev ³	Gas Module is in use at the bedside monitor.	Agent Sev Inspired Agent Sev End Tidal
INSP/ET Hal ³	Gas Module is in use at the bedside monitor.	Agent Hal Inspired Agent Hal End Tidal
INSP/ET Agent ³	Gas Module is in use at the bedside monitor.	Agent Inspired Alarm Agent ET Alarm
NIBP (Systolic, Diastolic, Mean, Elapsed Time)	NIBP always displayed even if parameter not monitored.	Low NIBP Systolic High NIBP Systolic Low NIBP Diastolic High NIBP Diastolic Low NIBP Mean High NIBP Mean
Temp 1	Temperature sensor is in use at the bedside monitor.	Low Temperature 1 High Temperature 1

¹ Alarm will only be detected when using a View 12™ card.

² Alarm will not be detected when using a View 12™ card.

³ Waveform not supported when using a WMTS 608 bedside device.

Additional Information

For additional information regarding Passport 2 bedside monitors, refer to the Passport 2 Operating Instructions (P/N 0070-00-0649-XX).

For information regarding the parameters that can be monitored by the Passport 2, refer to "Parameter Specifications" on page 12-1.

1.2.8 Passport V Bedside Monitor

Passport V bedside monitors are used to monitor patient data using a hardwired configuration. The Passport V sends data to the Panorama Central Station for analysis and storage via an Ethernet connection. The data collected by the Passport V is based on the type of lead wire set and sensors used.

If an alarm in the following table does not have an associated footnote, it may occur using any lead wire set.

Parameters/Waveforms

PARAMETERS	SETTINGS	PANORAMA ALARMS
ECG/Heart Rate	Leads I, II, III are available with a 3-wire lead set. Leads I, II, III, aVR, aVL, aVF, V are available with a 5-wire lead set.	Low Heart Rate High Heart Rate
ST	ST analysis is in use at the bedside device.	ST Single ST Dual
PVC/min.	Arrhythmia analysis is in use at the bedside device.	Asystole Bigeminy Brady Couplet Irregular Heart Rate High PVC Run Trigeminy V-Fib V-Rhythm V-Tach
Respiration (Source: ECG, CO ₂ and Gas Module)	Respiration is in use at the bedside and is derived from a valid source.	Low Respiration High Respiration Apnea
SpO ₂	SpO ₂ sensor is in use at the bedside device.	Low SpO ₂ High SpO ₂
IBP1/IBP2 (Systolic, Diastolic, Mean)	IBPx option is in use at the bedside device. IBP parameter labels include IBP, Art, UA, LV, PA, CVP, ICP, LA and RA. The label used is based on the label selected at the bedside monitor.	Low IBPx Systolic High IBPx Systolic Low IBPx Diastolic High IBPx Diastolic Low IBPx Mean High IBPx Mean
NOTE: x = 1 or 2		
INSP/ET CO	Gas Module is in use at the bedside device.	High CO ₂ Inspired Low CO ₂ End Tidal High CO ₂ End Tidal
INSP/ET O ₂	Gas Module is in use at the bedside monitor.	O ₂ Inspired O ₂ End Tidal
INSP/ET N ₂ O	Gas Module is in use at the bedside monitor.	N ₂ O Inspired N ₂ O End Tidal
INSP/ET Iso	Gas Module is in use at the bedside monitor.	Agent Iso Inspired Agent Iso End Tidal
INSP/ET Enf	Gas Module is in use at the bedside monitor.	Agent Enf Inspired Agent Enf End Tidal

Parameters/Waveforms (Continued)

PARAMETERS	SETTINGS	PANORAMA ALARMS
INSP/ET Des	Gas Module is in use at the bedside monitor.	Agent Des Inspired Agent Des End Tidal
INSP/ET Sev	Gas Module is in use at the bedside monitor.	Agent Sev Inspired Agent Sev End Tidal
INSP/ET Hal	Gas Module is in use at the bedside monitor.	Agent Hal Inspired Agent Hal End Tidal
INSP/ET Agent	Gas Module is in use at the bedside monitor.	Agent Inspired Alarm Agent ET Alarm
NIBP (Systolic, Diastolic, Mean, Elapsed Time)	NIBP always displayed even if parameter not monitored.	Low NIBP Systolic High NIBP Systolic Low NIBP Diastolic High NIBP Diastolic Low NIBP Mean High NIBP Mean
Temp 1	Temperature sensor is in use at the bedside monitor.	Low Temperature 1 High Temperature 1

Additional Information

For additional information regarding Passport V bedside monitors, refer to the Passport V Operating Instructions (P/N 0070-00-0704-XX).

For information regarding the parameters that can be monitored by the Passport V, refer to "Parameter Specifications" on page 12-1.

1.2.9 Spectrum Bedside Monitor

Spectrum bedside monitors are used to monitor patient data and may use either a hardwired or a wireless (2.4 GHz or 608 MHz) configuration. Currently, the Spectrum sends data to the Panorama Central Station for viewing and storage via an Ethernet connection. The data collected by a Spectrum is dependent on the type of lead wire set and sensors used. If an alarm in the following table does not have an associated footnote, it may occur using any lead wire set.

NOTE: The CO/CI, Temp 2, and T Blood parameters are only available if they are being monitored by the Spectrum/Spectrum OR External Parameter Module (EPM). These parameters are not available if they are monitored by an Edwards Vigilance® monitor.

Parameters/Waveforms

PARAMETERS	SETTINGS	PANORAMA ALARMS
ECG/Heart Rate	Leads I, II, III are available with a 3-wire lead set. Leads I, II, III, aVR, aVL, aVF, V are available with a 5-wire lead set. Leads I, II, III, aVR, aVL, aVF, V1, V2, V3, V4, V5, V6 are available with a View 12™ card.	Low Heart Rate High Heart Rate
ST	ST analysis is in use at the bedside device.	ST Single ST Dual
PVC/min.	Arrhythmia analysis is in use at the bedside device.	Asystole Bigeminy Brady ² Couplet Irregular Heart Rate ² Pause ¹ High PVC Run Trigeminy V-Fib V-Rhythm V-Tach
Respiration (Source: ECG, CO ₂ and Gas ³ Module)	Respiration is in use at the bedside and is derived from a valid source.	Low Respiration High Respiration Apnea
SpO ₂	SpO ₂ sensor is in use at the bedside device.	Low SpO ₂ High SpO ₂
IBP1/IBP2/IBP3/IBP4 (Systolic, Diastolic, Mean)	IBPx option is in use at the bedside device. IBP parameter labels include IBP, Art, UA, LV, PA, CVP, ICP, LA and RA. The label used is based on the label selected at the bedside monitor.	Low IBPx Systolic High IBPx Systolic Low IBPx Diastolic High IBPx Diastolic Low IBPx Mean High IBPx Mean
NOTE:	x = 1, 2, 3 or 4 (IBP3 and 4 are only available if the Spectrum/Spectrum OR External Parameter Module (EPM) is installed)	

¹ Alarm will only be detected when using a View 12™ card.

² Alarm will not be detected when using a View 12™ card.

³ Waveform not supported when using a WMTS 608 bedside device.

Parameters/Waveforms

PARAMETERS	SETTINGS	PANORAMA ALARMS
INSP/ET CO ₂ ³	Gas Module is in use at the bedside device.	High CO ₂ Inspired Low CO ₂ End Tidal High CO ₂ End Tidal
INSP/ET O ₂ ³	Gas Module is in use at the bedside monitor.	O ₂ Inspired O ₂ End Tidal
INSP/ET N ₂ O ³	Gas Module is in use at the bedside monitor.	N ₂ O Inspired N ₂ O End Tidal
INSP/ET Iso ³	Gas Module is in use at the bedside monitor.	Agent Iso Inspired Agent Iso End Tidal
INSP/ET Enf ³	Gas Module is in use at the bedside monitor.	Agent Enf Inspired Agent Enf End Tidal
INSP/ET Des ³	Gas Module is in use at the bedside monitor.	Agent Des Inspired Agent Des End Tidal
INSP/ET Sev ³	Gas Module is in use at the bedside monitor.	Agent Sev Inspired Agent Sev End Tidal
INSP/ET Hal ³	Gas Module is in use at the bedside monitor.	Agent Hal Inspired Agent Hal End Tidal
INSP/ET Agent ³	Gas Module is in use at the bedside monitor.	Agent Inspired Alarm Agent ET Alarm
NIBP (Systolic, Diastolic, Mean, Elapsed Time)	NIBP always displayed even if parameter not monitored.	Low NIBP Systolic High NIBP Systolic Low NIBP Diastolic High NIBP Diastolic Low NIBP Mean High NIBP Mean
Temp 1/Temp 2	Temperature sensor is in use at the bedside monitor.	Low Temperature 1 High Temperature 1 Low Temperature 2 High Temperature 2
Delta T	At least two temperature sensors in use at the bedside. Spectrum/Spectrum OR External Parameter Module (EPM) is installed.	Low Delta T Alarm High Delta T Alarm
Temp Blood	Spectrum/Spectrum OR External Parameter Module (EPM) is in use at the bedside.	Low T blood Alarm High T blood Alarm
Pulmonary Artery Wedge Pressure (PAWP)	One IBP must be labeled PA.	New PAWP Measurement
CO	Spectrum/Spectrum OR External Parameter Module (EPM) is in use at the bedside.	New CO Measurement

¹ Alarm will only be detected when using a View 12™ card.

² Alarm will not be detected when using a View 12™ card.

³ Waveform not supported when using a WMTS 608 bedside device.

Additional Information

For additional information regarding Spectrum bedside monitors, refer to the Spectrum Operating Instructions (P/N 0070-00-0648-XX).

1.2.10 Spectrum OR Bedside Monitor

Similar to the Spectrum, Spectrum OR bedside monitors are used to monitor patient data and send it to the Panorama Central Station for viewing and storage via an Ethernet connection. The Spectrum OR requires a hardwired configuration. The data collected by a Spectrum OR is dependent on the type of lead wire set and sensors used.

NOTE: The **CO/CI, Temp 2, and T Blood** parameters are only available if they are being monitored by the Spectrum/Spectrum OR External Parameter Module (EPM). These parameters are not available if they are monitored by an Edwards Vigilance® monitor.

Parameters/Waveforms

PARAMETERS	SETTINGS	PANORAMA ALARMS
ECG/Heart Rate	Leads I, II, III are available with a 3-wire lead set. Leads I, II, III, aVR, aVL, aVF, V are available with a 5-wire lead set.	Low Heart Rate High Heart Rate
ST	ST analysis is in use at the bedside device.	ST Single ST Dual
PVC/min.	Arrhythmia analysis is in use at the bedside device.	Asystole Bigeminy Brady ² Couplet Irregular Heart Rate ² Pause ¹ High PVC Run Trigeminy V-Fib V-Rhythm V-Tach
Respiration (Source: ECG, CO ₂ and Gas Module)	Respiration is in use at the bedside and is derived from a valid source.	Low Respiration High Respiration Apnea
SpO ₂	SpO ₂ sensor is in use at the bedside device.	Low SpO ₂ High SpO ₂
IBP1/IBP2/IBP3/IBP4 (Systolic, Diastolic, Mean)	IBPx option is in use at the bedside device. IBP parameter labels include IBP, Art, UA, LV, PA, CVP, ICP, LA and RA. The label used is based on the label selected at the bedside monitor.	Low IBPx Systolic High IBPx Systolic Low IBPx Diastolic High IBPx Diastolic Low IBPx Mean High IBPx Mean
NOTE: x = 1, 2, 3 or 4 (IBP3 and 4 are only available if the Spectrum/Spectrum OR External Parameter Module (EPM) is installed)		
INSP/ET CO ₂	Gas Module is in use at the bedside device.	High CO ₂ Inspired Low CO ₂ End Tidal High CO ₂ End Tidal Rate
INSP/ET O ₂	Gas Module is in use at the bedside device.	O ₂ Inspired O ₂ End Tidal
INSP/ET N ₂ O	Gas Module is in use at the bedside device.	N ₂ O Inspired N ₂ O End Tidal

Parameters/Waveforms

PARAMETERS	SETTINGS	PANORAMA ALARMS
INSP/ET Iso	Gas Module is in use at the bedside device.	Agent Iso Inspired Agent Iso End Tidal
INSP/ET Enf	Gas Module is in use at the bedside device.	Agent Enf Inspired Agent Enf End Tidal
INSP/ET Des	Gas Module is in use at the bedside device.	Agent Des Inspired Agent Des End Tidal
INSP/ET Sev	Gas Module is in use at the bedside device.	Agent Sev Inspired Agent Sev End Tidal
INSP/ET Hal	Gas Module is in use at the bedside device.	Agent Hal Inspired Agent Hal End Tidal
INSP/ET Agent	Gas Module is in use at the bedside device.	Agent Inspired Alarm Agent ET Alarm
NIBP (Systolic, Diastolic, Mean, Elapsed Time)	NIBP always displayed even if parameter not monitored.	Low NIBP Systolic High NIBP Systolic Low NIBP Diastolic High NIBP Diastolic Low NIBP Mean High NIBP Mean
Temp 1/Temp 2	Temperature sensor is in use at the bedside monitor.	Low Temperature 1 High Temperature 1 Low Temperature 2 High Temperature 2
Delta T	At least two temperature sensors in use at the bedside. Spectrum/Spectrum OR External Parameter Module (EPM) is installed.	Low Delta T Alarm High Delta T Alarm
Temp Blood	Spectrum/Spectrum OR External Parameter Module (EPM) is in use at the bedside.	Low T blood Alarm High T blood Alarm
Pulmonary Artery Wedge Pressure (PAWP)	One IBP must be labeled PA.	New PAWP Measurement
CO	Spectrum/Spectrum OR External Parameter Module (EPM) is in use at the bedside.	New CO Measurement

Additional Information

For additional information regarding Spectrum OR bedside monitors, refer to the Spectrum OR Operating Instructions (P/N 0070-00-0670-XX).

For information regarding the parameters that can be monitored by the Spectrum OR, refer to the "Parameter Specifications" on page 12-1.

1.2.11 DPM6 and DPM7 Bedside Monitors

DPM6 and DPM7 offer patient monitoring capabilities in a modular design with high resolution, touchscreen displays. Highlighted features include ETCO₂, 5-agent multi-gas analysis with auto-ID, extensive data storage and independent display support (DPM7 only).

Parameters/Waveforms

PARAMETERS	SETTINGS	PANORAMA ALARMS
ECG/Heart Rate	Leads I, II, III are available with a 3-wire lead set. Leads I, II, III, aVR, aVL, aVF, V are available with a 5-wire lead set.	Low Heart Rate High Heart Rate
ST	ST analysis is in use at the bedside monitor.	ST
PVC/min.	Arrhythmia analysis is in use at the bedside monitor.	Asystole Bigeminy Brady Couplet Irregular Heart Rate High PVC Run Trigeminy V-Fib V-Rhythm V-Tach
Respiration (Source: ECG, CO ₂ and Gas Module)	Respiration is in use at the bedside monitor and is derived from a valid source.	Low Respiration High Respiration Apnea
SpO ₂ /Desat	SpO ₂ sensor is in use at the bedside monitor.	Low SpO ₂ (Desat) High SpO ₂
Ao, Art, Art2, BAP, CVP, FAP, ICP, LAP, LV, PA, RAP, UAP, and UVP.	The label used is based on the label selected at the bedside monitor.	Low Systolic High Systolic Low Diastolic High Diastolic Low Mean High Mean
INSP/ET CO ₂	Gas Module is in use at the bedside monitor.	High CO ₂ Inspired Low CO ₂ End Tidal High CO ₂ End Tidal Rate
INSP/ET O ₂	Gas Module is in use at the bedside monitor.	O ₂ Inspired O ₂ End Tidal
INSP/ET N ₂ O	Gas Module is in use at the bedside monitor.	N ₂ O Inspired N ₂ O End Tidal
INSP/ET Iso	Gas Module is in use at the bedside monitor.	Agent Iso Inspired Agent Iso End Tidal
INSP/ET Enf	Gas Module is in use at the bedside monitor.	Agent Enf Inspired Agent Enf End Tidal
INSP/ET Des	Gas Module is in use at the bedside monitor.	Agent Des Inspired Agent Des End Tidal
INSP/ET Sev	Gas Module is in use at the bedside monitor.	Agent Sev Inspired Agent Sev End Tidal
INSP/ET Hal	Gas Module is in use at the bedside monitor.	Agent Hal Inspired Agent Hal End Tidal

Parameters/Waveforms

PARAMETERS	SETTINGS	PANORAMA ALARMS
INSP/ET Agent	Gas Module is in use at the bedside monitor.	Agent Inspired Alarm Agent ET Alarm
NIBP (Systolic, Diastolic, Mean, Elapsed Time)	NIBP always displayed even if parameter not monitored.	Low NIBP Systolic High NIBP Systolic Low NIBP Diastolic High NIBP Diastolic Low NIBP Mean High NIBP Mean
Temp 1/Temp 2	Temperature sensor is in use at the bedside monitor.	Low Temperature 1 High Temperature 1 Low Temperature 2 High Temperature 2
CCO/CCI	—	High CCO Alarm Low CCO Alarm High CCI Alarm Low CCI Alarm
SVR/SVRI	—	High SVR Alarm Low SVR Alarm High SVRI Alarm Low SVRI Alarm
Delta T	At least two temperature sensors in use at the bedside monitor.	High Delta T Alarm

Panorama System Compatibility

The DPM6/7 user interface on the Panorama system varies from the user interface on the DPM6/7 monitors as follows:

- If CVP, ICP, UVP, LAP, or RAP are selected as labels, only the mean values will be displayed; the alarm limit sliders for Systole & Diastole will not appear.
- CVP on the bedside monitor will show a more precise value than at the Panorama system side (e.g. 6.8 mmHg vs. 7 mmHg).
- ST templates and ST reference values will not be available.
- ST Tab and Digital Data graphic user interface varies from the bedside.
- ST Single Alarms and ST Dual Alarms are not supported.
- ECG settings of the DPM6/7 monitors will not be available on the Panorama system.

Additional Information

For additional information regarding the DPM6 bedside monitor, refer to the DPM6 Operating Instructions (P/N H-046-000184-00).

For additional information regarding the DPM7 bedside monitor, refer to the DPM7 Operating Instructions (P/N H-046-000186-00).

For information regarding the parameters that can be monitored by the DPM6 and DPM7, refer to the “Parameter Specifications” on page 12-1.

1.2.12 V Series Monitors

V Series monitors offer patient monitoring capabilities in a modular design with high resolution, touchscreen displays. V Series monitors are used to monitor patient data using a hardwired configuration. V Series monitors send data to the Panorama Central Station for analysis and storage via an Ethernet connection. The data collected by the V Series monitors is based on the type of lead wire set and sensors used. .

Parameters/Waveforms

PARAMETERS	SETTINGS	PANORAMA ALARMS
ECG/Heart Rate	Leads I, II, III are available with a 3-wire lead set. Leads I, II, III, aVR, aVL, aVF, V are available with a 5-wire lead set. Leads I, II, III, aVR, aVL, aVF, V, V2 are available with a 6-wire lead set. 12 lead (I, II, III, aVR, aVL, aVF, V-6) requires a V Series Patient Server (VPS).	Low Heart Rate High Heart Rate
ST Single / ST Dual	ST analysis is in use at the bedside monitor.	ST
PVC/min.	Arrhythmia analysis is in use at the bedside monitor.	Asystole Bigeminy Brady Couplet Irregular Heart Rate High PVC Run Trigeminy V-Fib V-Rhythm V-Tach
Respiration (Source: ECG, CO ₂ and Gas Module)	Respiration is in use at the bedside monitor and is derived from a valid source.	Low Respiration High Respiration Apnea
SpO ₂ /Desat	SpO ₂ sensor is in use at the bedside monitor.	Low SpO ₂ (Desat) High SpO ₂
IBP1/IBP2/IBP3/ IBP4/IBP5/IBP6/ IBP7/IBP8 (Systolic, Diastolic, Mean)	IBPx option is in use at the bedside device. IBP parameter labels include IBP, ART1, ART2, UA, LV, PA, CVP, ICP, IAP, LA, RA. The label used is based on the label selected at the bedside monitor.	Low Systolic High Systolic Low Diastolic High Diastolic Low Mean High Mean
NIBP (Systolic, Diastolic, Mean, Elapsed Time)	NIBP always displayed even if parameter not monitored.	Low NIBP Systolic High NIBP Systolic Low NIBP Diastolic High NIBP Diastolic Low NIBP Mean High NIBP Mean
Temp 1/Temp 2/ Temp 3/TBlood	Temperature sensor is in use at the bedside monitor.	Low Temperature 1 High Temperature 1 Low Temperature 2 High Temperature 2 Low Temperature 3 High Temperature 3
R-On-T PVC	—	Physiological

Parameters/Waveforms

PARAMETERS	SETTINGS	PANORAMA ALARMS
CCO/CCI	—	High CCO Alarm Low CCO Alarm High CCI Alarm Low CCI Alarm
CCO STAT / CCI STAT	—	High CCO STAT Alarm Low CCO STAT Alarm High CCI STAT Alarm Low CCI STAT Alarm
SVR/SVRI	—	High SVR Alarm Low SVR Alarm High SVRI Alarm Low SVRI Alarm
SVO2/ScVO2	—	High SVO2 Alarm Low SVO2 Alarm High ScVO2 Alarm Low ScVO2 Alarm
Delta T	At least two temperature sensors in use at the bedside monitor.	High Delta T Alarm

Additional Information

For additional information regarding the V Series bedside monitor, refer to the V Series Operating Instructions (P/N 0070-00-0727-XX).

For information regarding the parameters that can be monitored by the V Series, refer to the "Parameter Specifications" on page 12-1.

1.2.13 Panorama Telepack

The Panorama Telepack is a portable, wireless patient telemetry unit that can operate for an extended period of time on a disposable battery source. It can measure 3 or 5 Lead ECG and can also report on SpO₂ data when the optional SpO₂ module is attached. Telepack models are available for transmission at either 2.4 GHz (802.11 b/g) or 608MHz (WMTS band), depending on the region of use. Unless otherwise specified, "Telepack" refers to the Panorama Telepack-2.4 (2.4 GHz) and Telepack-608 (608 MHz) models.

The Telepack provides basic remote ECG monitoring of a patient, which includes heart rate, ST, PVC, and arrhythmia. The Telepack sends data to the Panorama Central Station for analysis and storage. The type of data that can be collected by a Telepack is dependent on the type of lead wire set and options configured for the connected patient.

Panorama Telepack-2.4

The Telepack-2.4 utilizes the 2.4 GHz wireless band (802.11 b/g). The Telepack-2.4 does not require a Panorama Server. It communicates directly to the appropriate Panorama Central Station via a wireless Access Point network installed throughout the specified coverage area. These Access Points interface with the Panorama Central Station using Ethernet components.

Panorama Telepack-608

The WMTS Telepack utilizes the 608MHz wireless bands using a frequency division multiple access method. The Telepack has the capability to transmit to the Panorama Server through an antenna network installed throughout the specified coverage area.

Panorama Telepack with Nonin SpO₂ Module

The Telepack may also monitor SpO₂ if the Nonin SpO₂ module is connected to the Telepack device. The module measures functional oxygen saturation of arterial hemoglobin (% SpO₂) and pulse rate (bpm) for adult patients.

NOTE: **The Panorama Central Station is used to program, configure, monitor and collect data for the Panorama Telepacks.**

Parameters/Waveforms

PARAMETERS	SETTINGS	PANORAMA ALARMS
ECG/Heart Rate	Waveform leads I, II, III are available with a 3-wire lead set. Waveform leads I, II, III, aVR, aVL, aVF, V are available with a 5-wire lead set.	Low Heart Rate High Heart Rate
ST	ST analysis is enabled	ST Single ST Dual

*) *Alarm only available when the Telepack with Nonin SpO₂ module is connected*

Parameters/Waveforms

PARAMETERS	SETTINGS	PANORAMA ALARMS
PVC/min.	Arrhythmia analysis is enabled	Asystole Bigeminy Brady ² Couplet Irregular Heart Rate High PVC Run Trigeminy V-Fib V-Rhythm V-Tach
SpO ₂	Telepack with Nonin SpO ₂ Module	Low SpO ₂ * High SpO ₂ *

*) Alarm only available when the Telepack with Nonin SpO₂ module is connected

Additional Information

For information regarding how to program and configure a Panorama Telepack, refer to the "Wireless Tab" on page 9-62.

For additional information regarding Panorama Telepacks, refer to "Telepack (Optional)" on page 10-1.

For additional information regarding the Nonin SpO₂ Module, refer to the "Telepack with Nonin SpO₂ Module (Optional)" on page 10-10.

For information regarding the care and maintenance of a Panorama Telepack, refer to "User Maintenance" on page 11-1.

For information regarding the parameters monitored by a Panorama Telepack, refer to "Parameter Specifications" on page 12-1.

1.2.14 Network Printer

The Network Printer provides a vehicle for printing collected data from the Panorama Patient Monitoring Network. One Panorama Central Station is capable of supporting up to two printers.

The following network printers are approved for use with the Panorama Central Station:

- HP LaserJet 4050n
- HP LaserJet 4100n
- HP LaserJet 4200n
- HP LaserJet 4250n
- HP LaserJet 4350n
- HP LaserJet P4015n

NOTE: **The HP LaserJet 4250n/4350n printer is intended for use with Panorama software version 8.2.5 or higher.**

Additional Information

For information regarding the setup and configuration of a printer with the Panorama Central Station, refer to the Panorama Printer Configuration Manual (P/N 0070-00-0561).

1.3 Troubleshooting

This section lists some of the potential issues that may occur with the monitor.

MESSAGE/ISSUES *	REASON	SOLUTION
Wandering ECG	Respiration artifact.	Try a different base line lead configuration.
Noisy ECG traces	Loose or dry electrodes. Defective electrode wires. Patient cable or leads are routed too close to other electrical devices.	Apply new electrodes. Replace wires as necessary. Eliminate 60Hz interference. Use ECG cable with built-in filter block.
Low Amplitude ECG	Electrode could be positioned over a bone or muscle mass.	Reposition electrodes. Select ECG SIZE button.
Excessive Electrosurgical Interference	Inadequate skin prep prior to application of electrode.	Repeat skin prep and electrode placement procedures. Add additional gel to electrodes.
Intermittent Signal	Connections not tight and properly secured. Electrodes dry. Cable or lead wires damaged.	Ensure proper connection. (Electrode to lead, lead to cable, cable to monitor.) Reprep skin and apply fresh moist electrodes. Check with continuity tester.
Excessive alarms: heart rate, lead fault	Electrodes dry. Alarm limits set too close to patient's normal heart rate. Rwave wrong size. Excessive patient movement or muscle tremor.	Reprep skin and apply fresh, moist electrodes. Readjust. Must be twice the amplitude of other part of wave form. Reposition electrodes and secure with tape if necessary.
Low Amplitude ECG Signal	Gain set too low. (Set through SIZE button.) Skin improperly prepared. Possibly not patient's normal complex. Electrode could be positioned over a bone or muscle mass.	Readjust as required. Abrade skin. Check with 12 lead electrocardiogram. Reposition electrodes.
Waveforms Not Moving	FREEZE button may have been pressed.	Select the FREEZE button to unfreeze the trace.
Temperature Probes not Working	Poor contact from probes to body.	Check the body surface contact at the probe tip. Reposition or apply thermoconductive gel.
Display Appears to be Off	Mains power switch may not be on. Unit may not be plugged into an AC outlet. If used as a portable, battery pack may be drained.	Check main power switch on side panel. Check power cord (Is it plugged in?). If battery pack is drained, plug into an AC outlet to recharge the battery. A period of 16 hours is required for a full charge.

* Messages are shown in all bold text.

MESSAGE/ISSUES *	REASON	SOLUTION
Disabled Alarm Tone, QRS Tone or Other Function	MUTE button pressed.	Check for alarm mute symbol and message.
	Beep volume low.	Increase beep volume.
ECG Base Line With No Wave form	The Gain control is not set high enough. Set through SIZE button.	Readjust as required.
	Lead wires and patient cable not fully inserted into proper receptacle.	Check insertion.
	Cable or lead wires damaged.	Check with lead continuity tester.
Base Line Wander	Patient moving excessively.	Secure lead wires and cable to patient.
	Patient's respiration.	Reposition electrodes
	Electrodes dry.	Reprep skin and apply fresh moist electrodes.
Damped Invasive Wave form	Static build up around patient.	Check with hospital engineer.
	Air bubbles in tubing.	Eliminate air from tubing.
	Kinked catheter.	Slightly alter position of catheter.
	Catheter against wall of blood vessel.	Check for leaks at connector.
No waveform for an invasive BP	Blood in tubing.	Pump pressure bag up to 300 mmHg.
	Improper attachment of transducer to monitor.	Check transducer connection.
Recorder Report is Blank	Faulty transducer.	Try a different transducer.
	Thermal paper may be installed incorrectly. (upside down)	Remove paper and reinstall with paper feeding off of the spool from the bottom.
Resp. Wave form Too Large	Scales set inappropriately.	Change lead selection.
Resp. Wave form Too Small	Patient breathing shallow or turned on side. Scale set inappropriately.	Change lead selection
False Apnea Alarm	Apnea delay may be improperly set. Patient may be having frequent episodes of CVA.	Choose another apnea delay.
	Scale size may be too low.	Reposition electrodes to better detect respirations.
CHK Lead	Due to increased impedance. Chest hair under electrodes.	Prep chest.
	Dried electrode gel.	Change electrodes.
	Electrode off.	Replace electrode.
	Lead off.	Replace lead.
	Cracked lead wires.	Replace lead wires.
CVA	Poor skin prep.	Clean and abrade skin before applying electrodes.
	Can be caused by shallow breathing or an apnea event.	Check the patient Adjust scales or leads if necessary.

* Messages are shown in all bold text.

MESSAGE/ISSUES *	REASON	SOLUTION
No Resp. Wave form or Rate Displayed	Patient not connected to a patient safety cable.	Turn respiration on ("OFF" will be displayed in Resp. window). Check that proper patient cable is used.
	Patient connected using Patient ESIS Choke/Cable.	Use 3-wire lead Patient Cable - non ESIS.
BAD CARD	View 12™ card is not the correct version or the card data has become corrupt.	Obtain replacement card.
Artifact	View 12™ card is detecting muscle artifact or electrical interference from auxiliary devices.	Check leads, follow skin preparation procedure. Check for electrical interferences, replace wires as necessary.

* *Messages are shown in all bold text.*

This page intentionally left blank.

Getting Started

This section provides an overview of the Panorama Central Station, the ViewStation and the WorkStation.

- The Panorama Central Station
- The ViewStation and the WorkStation
- The Main Screen
- Common Controls and Elements
- Quick Reference Guide
- Troubleshooting

2.1 The Panorama Central Station

The Panorama Central Station collects patient data from both wireless and hardwired devices and displays it based on its configured settings. Data is collected from the bedside monitors (i.e., Passport, Spectrum, DPM6/7, and V Series monitors) and Panorama Telepacks (2.4 GHz and 608 Mhz). The type of data that is collected and viewed is determined by the monitoring device and the selected parameters.

The Panorama Central Station uses either a single or dual display. Single display setups can accommodate eight (8) or 12 patient tiles. Dual display setups can accommodate up to eight (8) patient tiles per display, showing a maximum of 16 patient tiles between the two displays.

The full screen display (shown in FIGURE 2-1) includes patient tiles for viewing patient data and a menu bar for navigating the system.

NOTE: The Paging menu button will only be displayed if the Paging option has been installed.

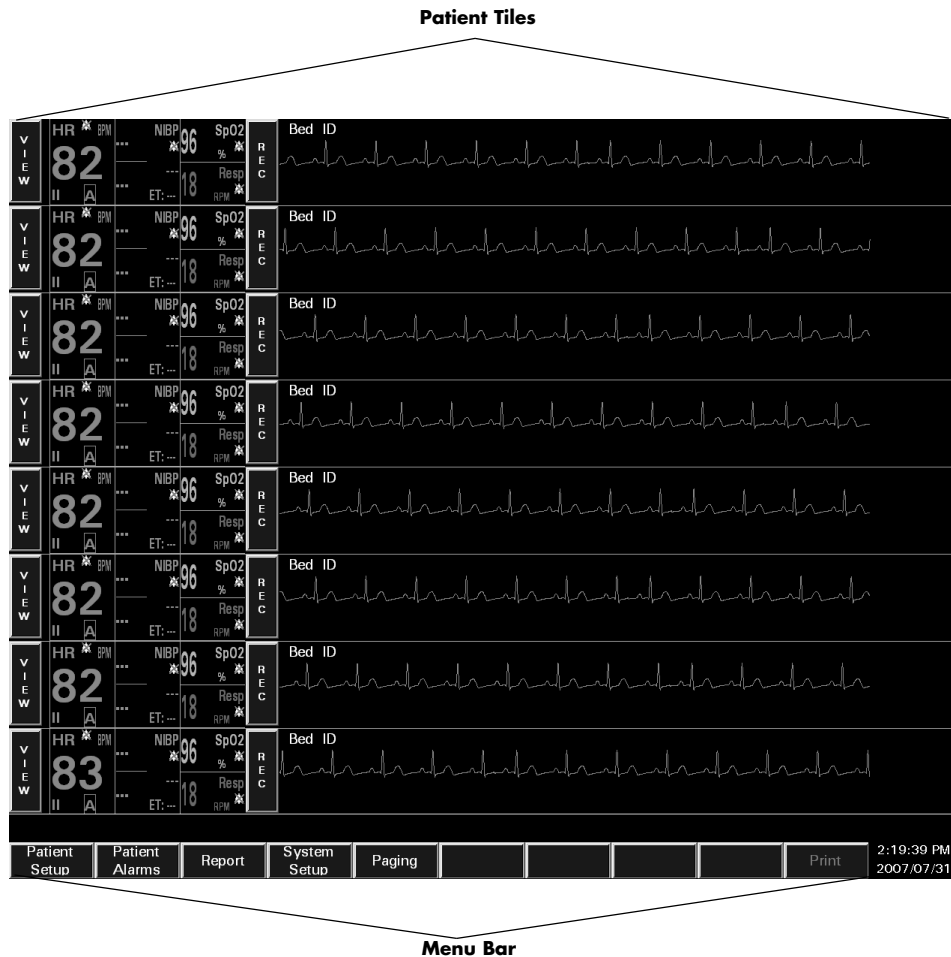

FIGURE 2-1 Full Screen Display (Central Station with Paging Option Installed)

The Panorama Central Station uses a split-screen display (shown in FIGURE 2-2) to allow users to simultaneously enter patient information, and monitor patient data. The top half of the screen displays patient data, while the bottom half of the screen is converted to a work space for entering and modifying patient information.

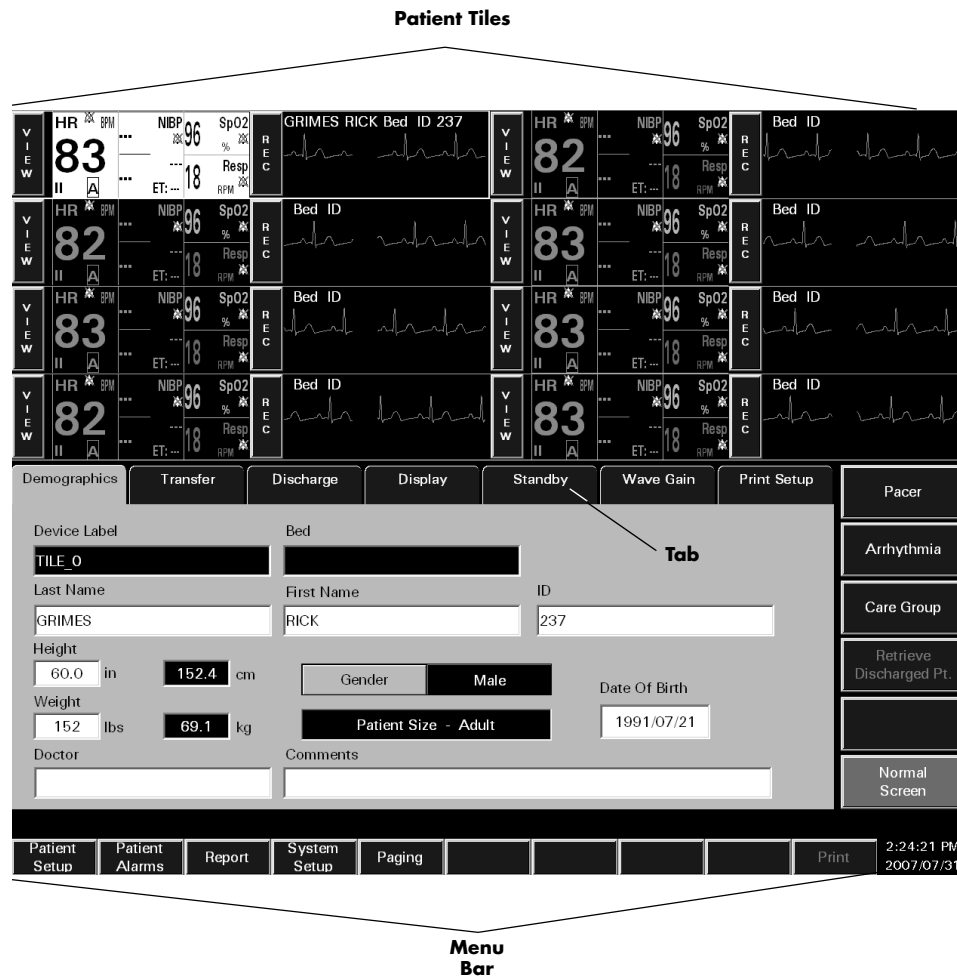

FIGURE 2-2 Split-Screen Display (Central Station with Paging Option Installed)

2.2 The ViewStation and the WorkStation

The ViewStation and the WorkStation may display patient tiles from other Panorama Central Stations on the network from a remote location(s). The host central station's Panorama Central Network (C-LAN) configuration settings, and the software that is installed at the remote location, determine the level of functionality available for each patient tile. A hospital area or department may also choose to restrict remote location access to its patient tiles by configuring its C-LAN configuration settings to off.

NOTE: C-LAN configuration settings are established by the System Administrator and are based on the needs of the individual hospital or hospital area.

The host central station C-LAN configuration settings available are:

HOST CENTRAL STATION C-LAN NETWORK SETTING	REMOTE LOCATION PATIENT TILE
Full	Patient tiles from the host central station will have full interactive functionality when using a WorkStation or view-only functionality when using a ViewStation.
View Only	Patient tiles from the host central station will have view-only functionality regardless of the software installed at the remote location.
Off	Patient tiles from the host central station cannot be seen from any remote location.

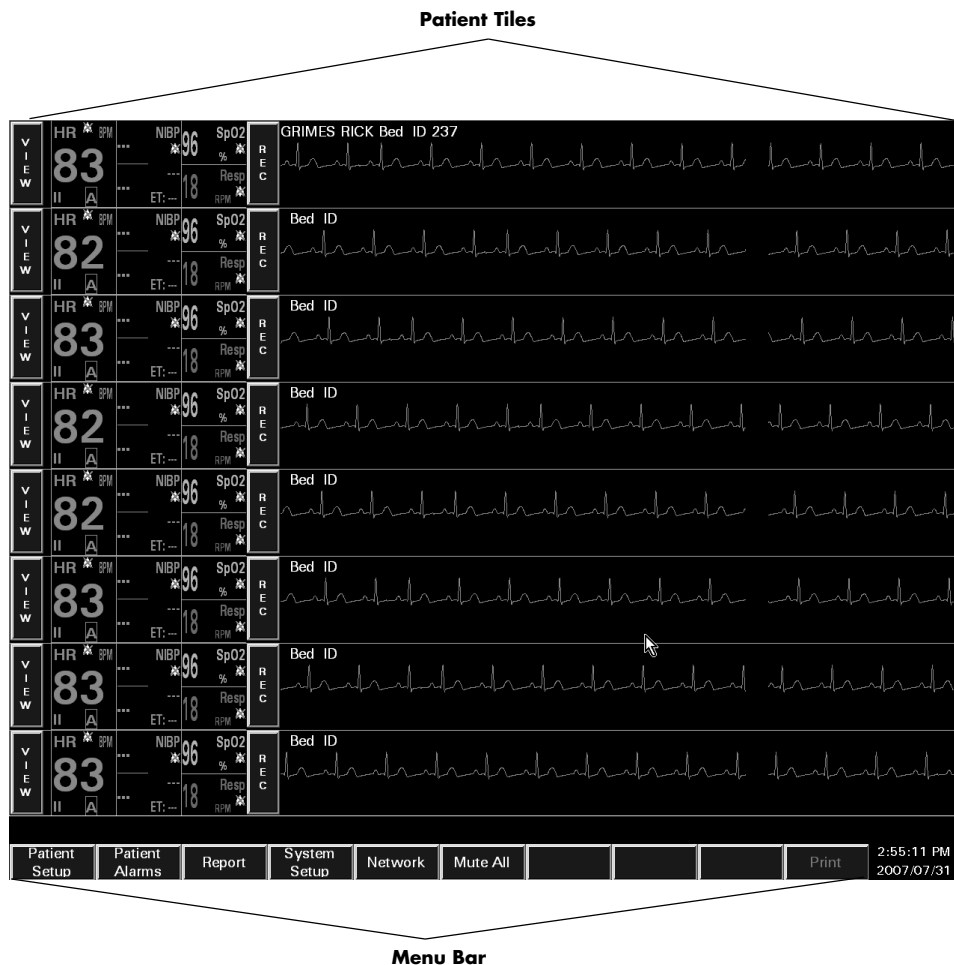

FIGURE 2-3 Full Screen Display (ViewStation and WorkStation)

The full screen display (shown in FIGURE 2-3) includes patient tiles for viewing patient data and a menu bar for navigating the system.

NOTE: The **Network** and **Mute All** menu bar buttons are only displayed at the ViewStation and the WorkStation.

The ViewStation and the WorkStation use a split-screen display (shown in FIGURE 2-4) to allow users to view patient information and monitor patient data. The top half of the screen displays patient data, while the bottom half of the screen is used to view patient data in more detail.



FIGURE 2-4 Split-Screen Display (ViewStation)

2.3 The Main Screen

The Main Screen for the Panorama Central Station, the ViewStation, and the WorkStation is used to monitor patient data and to navigate the system.

The Main Screen includes the following elements:

- Patient Tiles (shown in FIGURE 2-1/FIGURE 2-2)
- Menu Bar (shown in FIGURE 2-1/FIGURE 2-2)
- Tabs (shown in FIGURE 2-2)

2.3.1 Patient Tiles

Patient tiles (shown in FIGURE 2-5) are the core elements of the Panorama system. Patient tiles display patient information and data that is obtained from an external monitoring device. One patient and one monitoring device are assigned to each patient tile. The number of active patient tiles displayed at the Panorama Central Station is dependent on the number of patient tiles that were purchased with the system.

Each patient tile is divided into the following sections:

- VIEW/MUTE Button
- Care Group Indicator
- Digital Data Tile
- REC Button
- Patient Status Line
- Waveform Data Tile

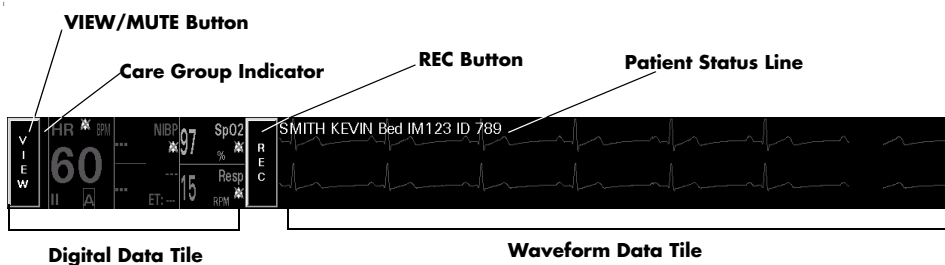

FIGURE 2-5 Patient Tile

For information regarding admitting a patient to the Panorama Central Station, refer to “Auto-Admitting a Patient” on page 2-21. For information regarding the assignment of monitoring devices to a patient tile, refer to the “Equipment Setup Tab” on page 9-33.

VIEW/MUTE Button

The **VIEW/MUTE** buttons share the same location within the patient tile. The button that is displayed is dependant on the operating state of the patient tile. During normal operating conditions, the **VIEW** button (shown in FIGURE 2-5) is displayed in the patient tile. During an alarm condition, the **MUTE** button is displayed in the patient tile.

NOTE: **The MUTE button is not available at the ViewStation or the WorkStation.**

The **VIEW** button is available in a patient tile when no alarm conditions exist. When the **VIEW** button is selected, the full-screen display changes to the split-screen mode and provides access to the **Bedside, Trends, Events, Disclosure** and **ST** tabs.

TAB	PURPOSE
Bedside	Provides an expanded view of a patient's digital and waveform data.
Trends	Provides list and graphic views of a patient's historical digital data.
Events	Provides a list of the events that have occurred for a patient tile. If waveform data is associated with an event it may also be viewed in the Events tab.
Disclosure	Provides a view of a patient's historical waveform data. Data may be displayed in a compressed or magnified view.
ST	Allows for the configuration and display of a patient's ST data.

The **MUTE** button is available in the patient tile when an alarm condition exists. The **MUTE** button silences the audio portion of a patient alarm for the configured time period.

Care Group Indicator

The Care Group indicator (shown in FIGURE 2-5) is a rectangular bar that represents the care group to which a patient tile is assigned. Colors can be assigned to care group indicators. A black indicator is displayed if a patient tile is not assigned to a care group.

For additional information regarding care groups, refer to the "Care Group Tab" on page 9-9.

NOTE: **Colorized Care Group indicators are not available at the ViewStation or the WorkStation.**

Digital Data Tile

The digital data tile (shown in FIGURE 2-5) may include the following patient information:

- Digital data measurements
Examples of digital data parameters include: Heart Rate, Respiration, SpO₂, Temperature, NIBP, PVC, and ST. The parameters available to a patient tile are dependent on the selected monitoring device.





Digital data is shown in the color assigned to the parameter.

- Alarms on/Alarms off icon
- ST analysis icon
- Arrhythmia analysis icon
- Heart Rate parameter lead

For information regarding supported devices and the parameters measured by each, refer to “Supported Devices” on page 1-3. For information regarding the parameters displayed in the digital data tile, refer to “Parameter Specifications” on page 12-2.

The following table lists the icons that may be shown in a digital data tile.

Digital Data Icons

ICON	MEANING
	All of the alarms for the selected patient are enabled.
	At least one alarm for the selected parameter is disabled.
	Arrhythmia analysis is active for the selected patient. This icon is only applicable to the Heart Rate tile.
	ST analysis is active for the selected patient. This icon is only applicable to the Heart Rate tile.
	Lead labels for the Heart Rate parameter include I, II, III, aVR, aVL, aVF, V, V1, V2, V3, V4, V5, and V6, depending on the lead set used. This icon is only applicable to the Heart Rate tile. For additional information, refer to “Parameter Specifications” on page 12-2. Lead labels are always shown in the Heart Rate tile when an ECG lead is used.

During an alarm condition, the parameter’s digital data tile flashes in the color that is associated with its assigned alarm priority.

- The digital data flashes in red when a Priority 1 alarm occurs.
- The digital data tile flashes in yellow when a Priority 2 alarm occurs.
- The data is displayed in yellow (constant, not flashing) when a Priority 3 alarm occurs.

REC Button

The **REC** button (shown in FIGURE 2-5) prints an All Strips Report for the selected patient tile. Selecting the **REC** button sends a print request to the **Print Status** tab and prints an All Strips Report. The All Strips Report provides real-time monitoring data for the selected patient. For additional information, refer to the “All Strips Report” on page 8-2.

Patient Status Line

The Patient Status line (shown in FIGURE 2-5) displays patient demographic information, physiological event messages and technical event messages. Demographic information (Last Name, First Name, Bed, ID) is only shown if it was provided. Demographic information is displayed as configured in the **Unit Choices** tab.

The following guidelines regulate the display of messages in the Patient Status line:

- A patient's demographic information, if available, is displayed in white text.
- All Alarm Priority 1 physiological messages are displayed in red text.
- Alarm Priority 2/3 physiological messages are displayed in yellow text.
- Mute Time messages, if alarms have been silenced, are displayed in the color associated with the alarm priority.
- Technical event messages are displayed in white text.

Waveform Data Tile

The Waveform Data tile (shown in FIGURE 2-5) displays the waveform data that was selected for the patient tile. The Waveform Data portion of a patient tile is capable of displaying up to two of the following waveform data parameters: ECG, Pleth, Respiration, IBP, O₂, and Agent. The available parameters are dependant on the selected monitoring device. For information regarding supported devices, and parameters measured, refer to "Supported Devices" on page 1-3.

Waveforms display in a patient tile using the following guidelines:

- Each waveform tile includes its own baseline.
- Waveforms are shown in a patient's configured color, wave gain, pacer enhancement and filter settings. If individual configurations are not set, the system default settings are used.

For information regarding the selection of patient waveform data, refer to the "Display Tab" on page 5-41. For information regarding the parameters that can be shown in the waveform tile, refer to "Parameter Specifications" on page 12-2.

2.3.2

Menu Bar

The Panorama Central Station, ViewStation, and the WorkStation menu bars (shown in FIGURE 2-6, FIGURE 2-7, and FIGURE 2-8) are used to view the system status, provide navigation for the application, and view the system time and date. All menu bars are fixed at the bottom of the screen.

Menu bar selections include:

- System Status Line
- Menu Buttons
- System Date/Time

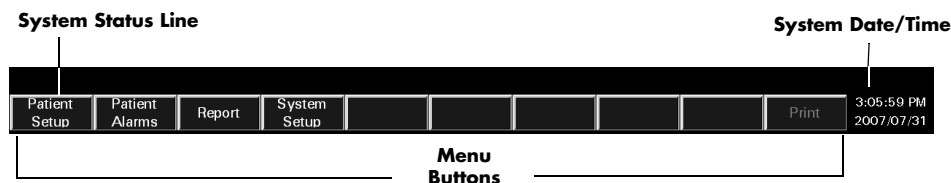

FIGURE 2-6 Panorama Central Station Menu Bar

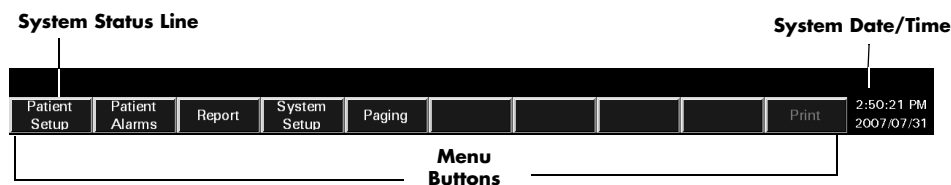

FIGURE 2-7 Panorama Central Station Menu Bar - Paging Option Enabled

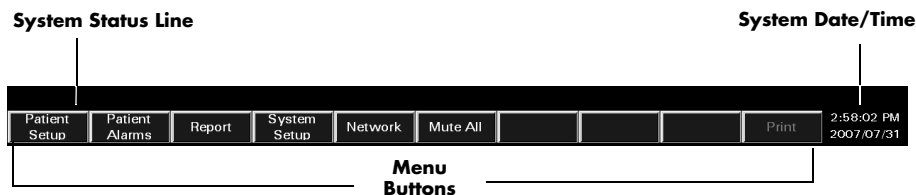

FIGURE 2-8 ViewStation and WorkStation Menu Bar

System Status Line

The System Status line (shown in FIGURE 2-7) displays messages regarding the status of the individual central station, ViewStation, or WorkStation. The System Status line is located above the menu buttons, in the menu bar. System status messages refer to the operation of the system. For a listing of System Status messages, refer to "System Event Messages and Error Codes" on page 13-25.

Menu Buttons

Menu buttons (shown in FIGURE 2-7) provide access to additional interactive screens. When a menu button is selected, a series of corresponding tabs is opened. The tabs that are displayed will vary depending on whether the patient tile is accessed from the central station, ViewStation, or from a WorkStation. For specific information related to a specific tab or button, refer to the appropriate chapter in this book or to the book index.

Table 2-1 provides a list of the tabs that are associated with each menu button.

TABLE 2-1

BUTTON	PURPOSE
Patient Setup	Provides access to the following tabs: <ul style="list-style-type: none"> • The Demographics tab is used to enter and modify patient demographic information (i.e., Last name, First name, ID, Bed, Height, Weight, etc.). • The Transfer tab is used to move patient information from tile to tile within a Panorama Central Station or between central stations. • The Discharge tab is used to remove a patient from centralized monitoring. • The Display tab is used to select the parameter information displayed in a patient tile. • The Standby tab is used to temporarily suspend monitoring while preserving patient settings and historical data. • The Wave Gain tab is used to adjust the wave gain used for displayed patient waveforms. • The Print Setup tab is used to select the parameters that are printed in a patient report.
Patient Alarms	Provides access to the following tabs: <ul style="list-style-type: none"> • The Patient Alarm Setup tab is an optional, password-protected tab used to restrict access to the Patient Alarm Limits and Alarm Responses tabs. • The Alarm Limits tab is used to set a patient alarm limit thresholds. • The Alarm Responses tab is used to configure system behaviors during alarm conditions.
Report	Provides access to the following tabs: <ul style="list-style-type: none"> • The Patient Reports tab is used to request patient-specific reports. • The System Reports tab is used to request system reports. • The Print Status tab is used to display the list of print requests that have been made and the status of each request.

* *Disable ECG is available on version 8.7.1 and above.*

** *Indicates button is not available at the ViewStation or the WorkStation*

*** *Indicates button is only available at the ViewStation and the WorkStation*

TABLE 2-1

BUTTON	PURPOSE
System Setup	<p>Provides access to the following tabs:</p> <ul style="list-style-type: none"> The Parameter Color tab is used to create the system default color and parameter assignment. The Print Setup tab is used to assign a system default printer for report printing. The Touch Screen tab is used to turn the touch screen on and off and recalibrate the touchscreen display. The Installation Setup tab is a password-protected tab used to restrict access to the following tabs: <ul style="list-style-type: none"> The Care Group tab is used to create the system level care group assignment. The Volume tab is used to adjust system default volume levels for physiological alarms. The System Alarms tab is used to create system default settings for alarms. The Passwords tab is used to create passwords that control access to the system. The Equipment Setup tab is used to enter information regarding external monitoring devices used with the Panorama Central Station. The More/Previous tab is used to navigate to the forward and backward between the sets of System Setup tabs. The Date/Time tab is used to select the system default date and time formats. The Unit Priorities tab is used to establish the system default order of parameters. The Unit Choices tab is used to adjust the system default settings for Discharge at Bedside, Pacer Enhancement, Pacer Reject, Paging Demographics, Paging Password Protection, Demographic Line information, Disable ECG*, Height, Weight, Temperature, CO₂, and Trend Display. The Wave Gain tab is used to adjust the system default wave gain setting for displaying waveforms. The Wireless tab is used to program wireless monitoring devices.
** Paging (Optional)	<p>The Paging tab allows for the configuration of pager information for a Panorama Central Station that has the paging option enabled.</p> <p>NOTE: When using a dual display setup, the Paging menu bar button will be disabled if the Paging tab is active on the other display.</p>
*** Network	<p>Provides access to the following tab:</p> <ul style="list-style-type: none"> The Network tab is used to access and select monitored patients on the Panorama Central Network (C-LAN) for viewing at a ViewStation or a WorkStation.

* *Disable ECG is available on version 8.7.1 and above.*

** *Indicates button is not available at the ViewStation or the WorkStation*

*** *Indicates button is only available at the ViewStation and the WorkStation*

TABLE 2-1

BUTTON	PURPOSE
** Mute All (Optional)	This button does not provide access to any tab. When selected, the Mute All button silences the audio alarms for all patient tiles at a ViewStation or a WorkStation for the configured amount of time. The Mute All button does not affect the audio or visual alarm indicators at the bedside monitor or at the host central station.
Print	The Print button provides an additional method to print patient information and reports.

NOTE: The Print menu bar button will be disabled when in the Normal Screen mode.

- * Disable ECG is available on version 8.7.1 and above.
- ** Indicates button is not available at the ViewStation or the WorkStation
- *** Indicates button is only available at the ViewStation and the WorkStation

System Date/Time

The **System Date/Time** (shown in FIGURE 2-6, FIGURE 2-7, and FIGURE 2-8) portion of the menu bar displays the system’s date/time information. The system date/time is displayed in the format selected in the **Date/Time** tab. For additional information regarding the time and date formats available, refer to “Date/Time Tab” on page 9-41.

2.3.3

Tabs

Tabs (shown in FIGURE 2-9) are used to access different screens associated with the Panorama Central Station, ViewStation, and the WorkStation. Tabs are accessed using menu buttons, or the patient tile **VIEW** button. Each tab includes sidebar buttons for expanded functionality.

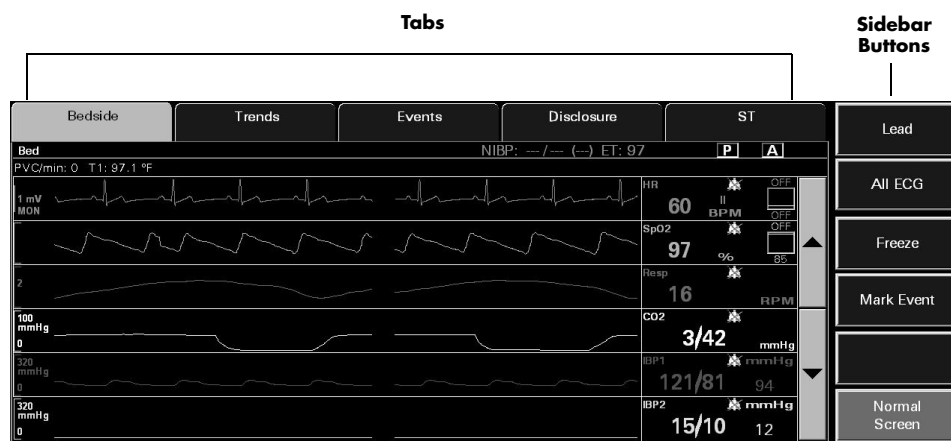

FIGURE 2-9 Tab Architecture

2.3.4 Sidebar Buttons

Sidebar buttons (shown in FIGURE 2-9) are used to perform an action (such as suspend alarms, enable arrhythmia, or return to the Normal Screen mode), add functionality to the tab (such as Skip to, Graphic, and Alarm Responses), or change the contents of the tab (such as Alarm Responses or Alarm Limits).

2.4 Common Controls and Elements

This section provides information regarding several types of controls and elements that are used throughout the system.

Common controls and elements include:

- Buttons
- Progress Bar
- Message Dialog Boxes
- Keyboard Dialog Box
- Keypad Dialog Box
- Weight Dial Dialog
- Height Dial Dialog

Buttons

Buttons provide additional options or perform an action when selected. For example:

- To perform an action. This type of button temporarily changes its appearance to indicate that it has been selected.

FIGURE 2-10 illustrates the change in appearance for an Action button before and after it is selected.



FIGURE 2-10 Action Buttons

- To enable/disable a function. This type of button changes its appearance to indicate if the function is enabled or disabled.

FIGURE 2-11 illustrates the change in appearance for a Function (or latched) button before and after it is selected. When one of these buttons is selected, its function will remain in effect until the button is released. In the first example shown in FIGURE 2-11, the alarms will be suspended until the button is unselected.



FIGURE 2-11 Function and Check Box Buttons

Progress Bar

The Panorama Central Station uses progress bars to indicate the progress of a lengthy operation.



FIGURE 2-12 Progress Bar

Message Dialog Boxes

The Panorama Central Station uses message dialog boxes to verify an action (shown in FIGURE 2-13) and to provide information (shown in FIGURE 2-14).

A Question message dialog box contains **Yes** and **No** buttons.

- The **Yes** button confirms the action, closes the message box and enables all applicable sidebar buttons.
- The **No** button cancels the action, closes the dialog box and enables applicable controls and sidebar buttons.

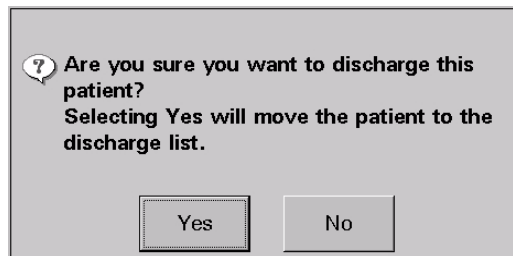

FIGURE 2-13 Message Dialog Box (Question)

An Informational message dialog box contains an **OK** button.

The **OK** button closes the message box and enables all applicable controls and sidebar buttons.



FIGURE 2-14 Message Dialog Box (Informational)

NOTE: All controls are disabled when a Message dialog box is displayed.

Keyboard Dialog Box

The Panorama Central Station uses a keyboard dialog box (shown in FIGURE 2-15) to enter and edit alphanumeric information. The buttons on the keyboard dialog box are similar to a standard computer keyboard.

NOTE: **Tab controls are disabled when the keyboard dialog box is displayed.**

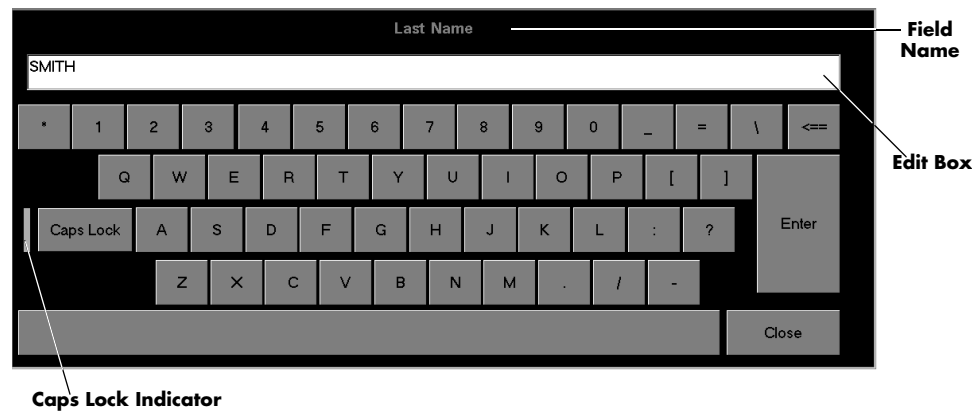

FIGURE 2-15 Keyboard Dialog Box

The keyboard dialog box includes:

- The name of the selected field
- An Edit box to show the entered value
- A **Close** button to discard changes
- An **Enter** button to accept changes
- A Backspace (**<==**) button to clear a single character in the edit box
- A **Caps Lock** button to enable or disable caps lock

A Caps Lock indicator is shown when **Caps Lock** is enabled.

Keypad Dialog Box

The Panorama Central Station uses the keypad dialog box (shown in FIGURE 2-16) to enter and edit numeric information. The buttons in the keypad dialog box are similar to a standard calculator.

NOTE: **Tab controls are disabled when the keypad dialog box is displayed.**

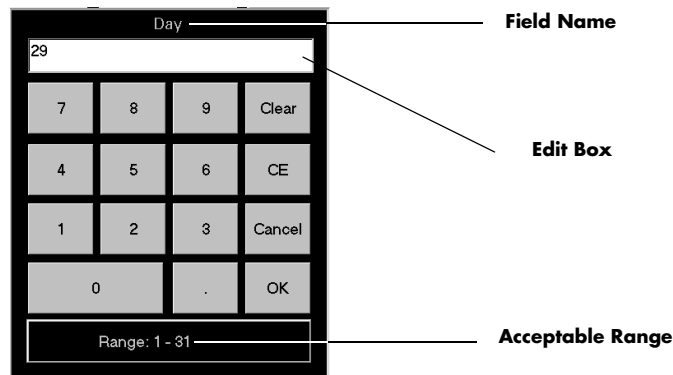

FIGURE 2-16 Keypad Dialog Box

The keypad dialog box includes:

- The name of the selected field
- An Edit box to show the entered value
- The acceptable range of values
- A **Clear** button to delete all of the numbers in the edit box
- A **CE** button to delete a single number from the edit box
- A **Cancel** button to discard changes
- An **OK** button to accept changes

Weight Dial Dialog

The Weight dial dialog can be used to quickly set the pounds and ounces (Neonate patient size only) for a patient's weight.

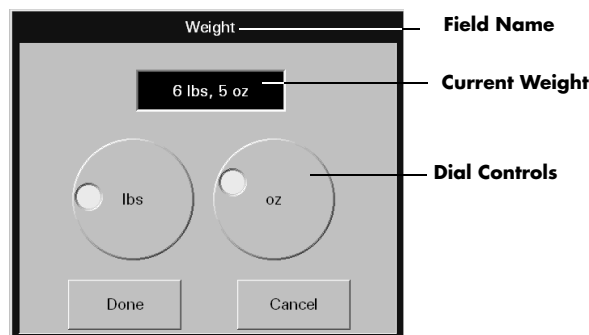

FIGURE 2-17 Weight Dial Dialog (Spectrum bedside device, Neonate patient size)

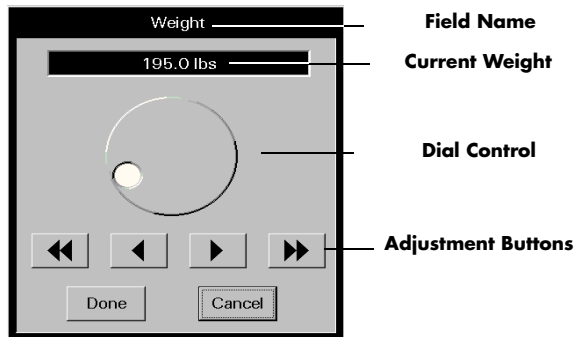

FIGURE 2-18 Weight Dial Dialog (Passport 2 bedside device, all patient sizes)

The Weight dial dialog includes:

- The name of the selected field
- A text box to show the selected value
- A dial control to select the weight
 - Turn in a clockwise direction to sequentially increase the numeric value
 - Turn in a counter-clockwise direction to sequentially decrease the numeric value
- Adjustment buttons to sequentially increase or decrease the numeric value
- A **Done** button to accept changes
- A **Cancel** button to discard changes

Height Dial Dialog

The Height dial dialog functions similarly to the Weight dial dialog. For additional information, refer to the Weight Dial Dialog.

2.5 Quick Reference Guide

The quick reference guide provides abbreviated procedural information for the operation of the Panorama Central Station.

For additional information, refer to the Panorama Quick Reference Guide (P/N 0002-08-7538).

Quick reference procedures include:

- Auto-Admitting a Patient
- Standby
- Discharge
- Display
- Patient Alarms (Limits and Responses)
- Viewing List Trends
- Viewing Events
- Viewing Disclosure Data

NOTE: Demographic information is bi-directionally shared between the bedside monitor and the Panorama Central Station.

2.5.1 Auto-Admitting a Patient

Auto-admit allows for the immediate monitoring of a patient at the Panorama Central Station.

To auto-admit a patient:

1. Verify that the monitoring device is in the Equipment List. For information on how to access the Equipment List, refer to the "Equipment Setup Tab" on page 9-33.
2. Connect/attach the monitoring device to the patient.
3. Turn on the monitoring device. The monitoring device begins monitoring the patient. The parameters that are monitored are dependent on the monitoring device.
4. Verify that the patient is being monitored at the central station.

NOTE: Auto-admit uses the system default settings for monitoring the patient.

2.5.2 Standby

Standby mode suspends the monitoring of a patient at the Panorama Central Station while retaining the patient's historical data and setup priorities. It is important that a patient in this mode be alternatively monitored. The **Standby** tab is also available at the WorkStation.

To activate Standby mode at the central station or the WorkStation:

1. Select the **Patient Setup** menu button.
2. Choose a patient tile by selecting its digital data or waveform area.
3. Select the **Standby** tab.
 - The **Panorama Standby Only** button places the patient in Standby at the Panorama Central Station.

- The **Bedside and Panorama Standby** button places the patient in Standby at the Panorama Central Station and the bedside monitor.

NOTE: **The Bedside and Panorama Standby button is not available when using a Telepack device.**

4. Select a patient's Standby location.
 - a. Select a location from the patient location list
 - b. Choose the **Select** button

To activate Standby mode at the bedside monitor:

- Select the **STANDBY** button on the front of the bedside monitor. This method places both the bedside monitor and the Panorama Central Station in **Standby** mode.

To remove a patient from the Standby mode at the Panorama Central Station or the WorkStation:

1. Select the **Patient Setup** menu button.
2. Choose a patient tile by selecting its digital data or waveform area.
3. Select the **Standby** tab.
4. Select the **Resume Monitoring** button. Monitoring is resumed at the Panorama Central Station.

To remove a patient from the Standby mode at the Panorama Central Station and the bedside monitor:

- Select the **STANDBY** button on the front panel of the bedside monitor. Monitoring resumes at the Panorama Central Station and the bedside monitor.

For additional information on Standby, refer to the "Standby Tab" on page 5-51.

2.5.3 Discharge

The discharge function discharges a patient from a patient tile and resets the Panorama Central Station for the next patient. This tab is available at the WorkStation.

To discharge a patient:

1. Select the **Patient Setup** menu button.
2. Choose a patient tile by selecting its digital data or waveform area.
3. Select the **Discharge** tab.
4. Select the **Bedside and Panorama Discharge** button.

5. A message dialog box is displayed.
 - a. If at least two of the three required demographic fields (First Name, Last Name, Patient ID) are entered, the following message is displayed: **Are you sure you want to discharge this patient? Selecting Yes will move the patient to the discharge list.** The **YES** button discharges the patient. The **NO** button continues monitoring the patient.
 - b. If at least two of the three required demographic fields are not completed, the following message is displayed: **The patient's data and submitted print jobs will be deleted because at least two of the following fields, First Name, Last Name or ID have not been filled in. Do you still want to proceed with the discharge?** The **YES** button discharges the patient. The **NO** button continues monitoring the patient.

To discharge a patient from a bedside monitor:

1. Select the **DISCHARGE** button on the front of the bedside monitor.
2. Select a discharge option.
 - The **Discharge From Monitor** option erases all patient information at the bedside monitor.
 - The **Discharge From Central** option erases all patient information at the Panorama Central Station.
 - The **Discharge From Both** option erases all patient information at the Panorama Central Station and at the bedside monitor.

NOTE: When using the **Discharge From Central** and **Discharge From Both** options, if two of the three demographic fields (First Name, Last Name, and ID) have been completed prior to the patient's discharge, the patient is moved to the Discharge list at the Panorama Central Station and may be retrieved.

NOTE: If a patient is discharged from the Panorama Central Station but not from the patient monitor, the Panorama Central Station tile will not be available for a new patient until a discharge has been performed at the patient monitor.

3. Verify the selection. The **Are you sure?** confirmation dialog box is displayed.
 - The **Yes** selection confirms the patient discharge.
 - The **No** selection discards the patient discharge.

For additional information regarding discharging a patient, refer to "Discharging a Patient from the Central Station and the Bedside Monitor" on page 5-37.

2.5.4

Display

The Display tab controls the order of patient data tiles and the waveforms that are shown on the Main Screen.

To change the patient tile display order at an individual Panorama Central Station, ViewStation, or WorkStation:

1. Select the **Patient Setup** menu button.
2. Choose a patient tile by selecting its digital data or waveform area.
3. Select the **Display** tab.

4. Select a digital parameter tile to change a digital parameter. Select a waveform tile to change a waveform.
5. Select a parameter from the Parameter list.
6. Choose the **Select** button to confirm the choice.

For additional information regarding parameter display, refer to the "Display Tab" on page 5-41.

2.5.5 Patient Alarms

Patient alarms provide for customized alarm limits and responses based on patient need. For additional information on patient alarms, refer to "Patient Alarm Setup Tab (Optional)" on page 6-2.

Alarm Limits

Alarm limits are the configured threshold settings used to monitor patient parameters. If a parameter does not fall within the configured threshold settings, an alarm occurs. When using a bedside monitor, patient alarm limit information will continuously be transmitted between the bedside monitor, the Panorama Central Station, ViewStation, and the WorkStation.

WARNING: Changing the patient alarm limits at the WorkStation will automatically change the patient alarm limits at the Panorama Central Station AND the bedside monitor (if applicable) for the selected patient tile.

To adjust alarm limits:

1. Select the **Patient Alarms** menu button.
2. Choose a patient tile by selecting its digital data or waveform area.
3. Select the **Alarm Limits** tab.
4. Select the parameter alarm limits to adjust. Use the slider bars to adjust the alarm limits.

To adjust alarm limits at the bedside monitor, refer to the bedside monitor's Operating Instructions:

- Passport 2 (P/N 0070-00-0649-XX)
- Passport V (P/N 0070-00-0704-XX)
- Spectrum (P/N 0070-00-0648-XX)
- Spectrum OR (P/N 0070-00-0670-XX)
- DPM 6 (P/N H-046-000184-00)
- DPM 7 (P/N H-046-000186-00)
- V Series (P/N 0070-00-0727-XX)

NOTE: ST alarm limits for DPM6/7 must be adjusted at the DPM6/7 bedside monitor.

For additional information on Alarm Limits, refer to "Alarm Limits Tab (Patient)" on page 6-4.

Alarm Responses

Alarm Responses determine the behavior of alarms when an alarm violation occurs at the Panorama Central Station.

To adjust alarm responses:

1. Select the **Patient Alarms** menu button.
2. Choose a patient tile by selecting its digital data or waveform area.
3. Select the **Alarm Responses** tab.
4. Select the parameter.
5. Adjust the alarm responses for the parameter.

For additional information on alarm responses, refer to "Alarm Responses Tab (Patient)" on page 6-12.

Muting Alarms

To mute a non-latched alarm (for example, IBP):

- Select the **MUTE** button in the alarming patient tile to silence the alarm violation for the configured time period.

NOTE: The **MUTE** button is not available at the **ViewStation** or the **WorkStation**.

For additional information on muting an alarm, refer to "VIEW/MUTE Button" on page 2-8.

To mute a latched alarm (for example, lethal arrhythmias):

- Select the digital data area or waveform area of the alarming patient tile to acknowledge the alarm **AFTER** the alarm condition is resolved.
- Select the **MUTE** button in the alarming patient tile to silence the alarm violation for the configured time period.

NOTE: The audio and visual indicators for a latched alarm will continue until the alarm is acknowledged, even if the alarm condition no longer exists.

NOTE: Selecting the digital data or waveform area of the alarming patient tile, at the host central station, also acknowledges the alarm at the **ViewStation** and the **WorkStation**.

For additional information about latched alarms, refer to "Latching" on page 3-3.

2.5.6 Viewing List Trends

The **Trends** tab displays all available digital data for a patient, in a list format.

To view List Trends at the Panorama Central Station:

1. Select the **VIEW** button in the desired patient tile.
2. Select the **Trends** tab.
 - Select the **Print** menu bar button to print the trends list.

To adjust the trend display period:

1. Select the **Patient Setup** menu button.
2. Select the **Display** tab.
3. Select the **Trend Display** sidebar button.

For additional information regarding the Trends List, refer to "Trends Tab (List View)" on page 7-14.

2.5.7 Viewing Events

The **Events** tab displays all events and related waveform data for a patient.

To view events:

1. Select the **VIEW** button in the desired patient tile.
2. Select the **Events** tab.
 - Select the **Print** menu bar button to print the events list.
3. Select the **Events Filtering** sidebar button to change the filter used in the event list.

For additional information regarding events, refer to "Events Tab" on page 7-24.

4. To view the waveform data associated with an event, highlight the desired event and select the **View Waveform** sidebar button.

The event waveform can be printed by selecting the **Print** menu bar button.

2.5.8 Viewing Disclosure Data

The **Disclosure** tab displays all of the patient's historical waveform data, and associated numeric information, for a selected time period.

To view disclosure data:

1. Select the **VIEW** button in the desired patient tile.
2. Select the **Disclosure** tab.
3. Select the **Display Choices** sidebar button to change the waveforms being viewed.
 - a. Select the **Print** menu bar button or one of the menu bar **Print (x) Hour(s)** (**x**=number of hours to print) button to print the disclosure information.
 - b. Select the **Skip To** sidebar button to view a specific time in a patient monitoring history.
4. For a magnified view of the waveform, highlight a waveform and select the **Zoom In** button.
 - a. Select the **Print** menu bar button to print the magnified disclosure information.

For additional information regarding disclosure, refer to the "Disclosure Tab" on page 7-41.

2.6 Troubleshooting

This section lists some of the potential issues that may occur when admitting a patient to the Panorama Central Station.

MESSAGE/ISSUE *	REASON	SOLUTION
Cannot admit patient/patient data not displayed at central station.	Previous patient not discharged from system and/or monitoring device.	Discharge patient from system.
	Monitoring device not assigned to Panorama Equipment List.	Assign device to Panorama Equipment List.
	Panorama not installed as an option.	Access the Installation Menu, Options submenu at the bedside device. For additional information, refer to the operating instructions of the bedside monitor.
	Network setting on monitoring device is incorrect.	Access the Installation Menu, System Information submenu at the bedside device. For additional information, refer to the operating instructions of the bedside monitor.
	Telepack batteries may need to be replaced.	Test batteries, and if necessary, replace.
	Telepack batteries improperly installed.	Reinstall batteries.

* *Messages are shown in all bold text.*

This page intentionally left blank.

3.0 *Alarm Behavior*

This section outlines the alarm types available in the system and the conditions that would trigger an alarm condition.

- General Alarm Behavior
- Physiological Alarms
- Technical Alarms
- System Alarms

3.1 General Alarm Behavior

The Panorama Central Station uses alarms to send notification when a patient's physiological status changes, a patient has a specific technical issue, or when there is a system violation. When a patient is first admitted, the default system alarm settings are in effect. Individual patient alarm settings can be modified by using the Patient Alarms button at the central station or the WorkStation.

WARNING: Changing the patient alarm limits at the WorkStation will automatically change the patient alarm limits at the Panorama Central Station AND the bedside monitor (if applicable) for the selected patient tile.

By default, alarm settings send notification using:

- Visual indicators
- Audible indicators

The three alarm types used in this system include physiological, technical, and system.

3.2 Physiological Alarms

Physiological alarms indicate a violation of a monitored patient's physiological alarm thresholds or arrhythmia analysis settings. For additional information regarding alarm thresholds and arrhythmia analysis settings, refer to "Alarms and Events" on page 13-1.

3.2.1 Alarm Behaviors

The visual and audio indicators associated with a physiological alarm are:

Visual Indicators

Visual indicators provide visual notification when an alarm threshold is violated. When a physiological alarm condition is triggered, the digital data portion of the patient tile flashes (if the alarm priority is set to 1 or 2), and a text message displays in the Patient Status line. The physiological alarm behavior varies depending on the parameter, and on the alarm priority associated with the parameter. This is discussed in further detail in the "Physiological Alarm Responses" on page 3-4.

Audio Indicators

Audio indicators provide audible notification when an alarm threshold is violated. Audio indicators may vary depending on the alarm severity, alarm type, system setup and configuration. Audio alarms are triggered by:

- The onset of an alarm condition, provided the alarm delay is not active.
- A configured alarm delay, if alarm delay is active.

Audio alarm options are configured in the **System Alarms** (System Alarm Options) tab. By default, audio alarms are enabled.

NOTE: Audio alarms will be triggered at the ViewStation and the WorkStation when there is an alarm occurring at the host central station.

Once the alarm condition is resolved and/or acknowledged, the audible alarm stops, unless the alarm is latched. For additional information regarding alarm limits, refer to "Alarm Limit Settings" on page 13-2. For additional information regarding alarm latching, refer to "Latching" on page 3-3.

3.2.2 Alarm Options

The alarm options associated with a parameter dictate how the system responds when an alarm occurs.

Bedside Alarm Tracking

Bedside Alarm Tracking provides an automatic bi-directional flow of alarm limit change and alarm delay information, between a patient bedside monitor and a Panorama Central Station.

Latching

Alarm **latching** denotes that the audio and visual indicators, associated with an alarm condition, will not automatically stop even when the patient alarm condition is resolved.

By default, lethal alarm events and nurse call events are automatically latched. Physiological alarm events can be configured to be latched or unlatched. Non-lethal alarms cannot be latched, except in DPM6/7 for which any alarms can be latched. When permitted, this option can be enabled/disabled in the **System Alarms** (System Alarm Options) tab.

The patient tile **MUTE** button temporarily silences the alarm condition for the configured time period. However, if that latched alarm is not acknowledged during the configured time period, the alarm indicators resume. Once a patient alarm condition is resolved, it must be acknowledged at the central station and at the bedside monitor. If it is not acknowledged, all audio and visual alarm indicators continue at the central station and at the bedside monitor, even if the alarm condition is resolved.

NOTE: For Passport V and DPM6/7, the alarm condition must be acknowledged first at the bedside, and then acknowledged at the Panorama Central Station.

To acknowledge a latched alarm condition at the central station, once the condition is resolved, perform one of the following to the affected patient tile:

- Select the digital data area
- Select the waveform area
- Select the **VIEW** button

NOTE: Acknowledging a latched alarm at the host central station patient tile acknowledges the alarm at the associated ViewStation and WorkStation patient tile.

NOTE: Acknowledging a latched alarm at the bedside monitor does not acknowledge the alarm at the host central station, ViewStation, or WorkStation patient tile.

To acknowledge a latched alarm at the bedside monitor, refer to its respective Operating Instructions.

Once a latched alarm condition is acknowledged, the alarm indicators discontinue until another alarm condition occurs. Acknowledging the alarm at the central station will not discontinue the alarm at the bedside monitor, and acknowledging the alarm at the bedside monitor will not discontinue the alarm at the central station, ViewStation, or WorkStation.

Apnea Latching

The conditions for apnea latching follow standard latching procedures, however apnea latching is associated with an apnea alarm condition. This option can be enabled/disabled in the **System Alarms** (System Alarm Options) tab. By default, Apnea Latching is enabled.

NOTE: **Respiratory apnea alarm condition events are detected by the bedside monitor.**

NOTE: **Acknowledging an apnea latched alarm at the central station patient tile also acknowledges the alarm at the associated ViewStation and WorkStation patient tile.**

NOTE: **Acknowledging an apnea latched alarm at the bedside monitor does not acknowledge the alarm at the host central station, ViewStation, or WorkStation patient tile.**

Alarm Delay

Alarm Delay is the configurable time period required before an alarm is triggered. Alarm Delay will not effect the Apnea Alarm, ST Alarms, the non-lethal arrhythmia alarms, or the lethal arrhythmia alarms. When permitted, this option can be enabled/disabled in the **System Alarms** (System Alarm Options) tab. By default, an Alarm Delay time is not specified.

ST Alarm Delay

ST alarm delay postpones the trigger of the ST alarm for a configured time period. When permitted, this option can be configured in the **System Alarms** (System Alarm Options) tab.

3.2.3 Physiological Alarm Responses

The alarm responses associated with a physiological alarm are as follows.

3.2.3.1 Alarm Priorities

The Panorama Central Station supports three **alarm priorities**. When alarm priority is turned on, the choices available are Alarm Priority of 1, 2 or 3. Alarms may be turned off by using the Priority Off setting. Alarm priorities associated with lethal alarm parameters cannot be changed from their default value of Priority 1. However, all other parameters can be modified. The alarm priority used to configure a parameter defines the alarm severity.

When a parameter is assigned a Priority Off, there are no visual or audio alarm indicators associated with the alarm event, however **Print on Alarm** and **Save To Event** options are still available.

Alarm priorities are configured in the patient **Alarm Responses** and the **System Alarms** (System Alarm Responses) tabs.

For additional information about defining a parameters alarm priority, refer to “Configuring Alarm Responses” on page 6-14 and “Setting the System Alarms Responses” on page 9-27.

Priority 1 Alarms

Priority 1 alarms are the most severe alarm type. Lethal-arrhythmia alarms (Asystole, V-Tach, and V-Fib) are automatically configured as Priority 1 alarms and cannot be modified. Priority 1 alarm conditions cause the applicable parameter sub-tile to flash in red, display a red text message in the Patient Status line, and use a Priority 1 alarm sound. A parameters’ alarm priority is configured in the **System Alarms** (System Alarm Responses) tab.

Priority 2 Alarms

Priority 2 alarms are less severe than Priority 1 alarms, and have different visual and audio indicators. Heart rate (HR), ST Single, and ST Dual default to Priority 2 alarms. Priority 2 alarm conditions cause the applicable parameter sub-tile to flash in yellow (for a physiological alarm), display a yellow text message in the Patient Status line, and use a Priority 2 alarm sound (if alarm delay is not enabled). A parameters’ alarm priority is configured in the **System Alarms** (System Alarm Responses) tab.

Priority 3 Alarms

Priority 3 alarms are the least severe of the three alarm priorities. By default, temperature (T1/T2), respiration, and SpO₂ are Priority 3 alarms. Priority 3 alarm conditions cause the applicable parameter sub-tile to display in constant yellow, display a yellow text message in the Patient Status line, and use a Priority 3 alarm sound (if alarm delay is not enabled). A parameters’ alarm priority is configured in the **System Alarms** (System Alarm Responses) tab.

Priority Off

Alarm priority can be turned off for certain alarms. Parameters configured to use Priority Off do not have any visual or audio alarm indicators, however, the **Print on Alarm** and **Save To Event** alarm response options still function.

3.2.3.2

Save To Event

Save To Event enables the Panorama Central Station to save a 20 second snapshot of a specific alarm event so that it can later be retrieved and studied in more detail. The Save To Event option is disabled at the ViewStation.

3.2.3.3

Print on Alarm

Print on Alarm automatically generates a patient All Strips Report when a specified alarm is triggered. The patient tile Print on Alarm option is enabled at the ViewStation and functions in the same manner as the host central station. Changes made to the patient tile Print on Alarm option, at the ViewStation, will not affect the patient tile Print on Alarm option at the host central station. For additional information about the All Strips Report, refer to the “All Strips Report” on page 8-2.

3.3 Technical Alarms

Technical alarms are patient specific and are related to technical issues that occur with cables, leads, and parameter sensors. The ViewStation technical event alarm notification will follow those settings at the host central station.

3.3.1 Alarm Behaviors

The visual and audio indicators associated with a technical alarm are as follows:

Visual Indicators

Technical visual indicators display as white text messages in the Patient Status line.

Audio Indicators

Technical alarm audio indicators are based on Technical Events Sound settings in the **System Alarms** (System Alarm Options) tab, the event type and the **Volume** tab settings.

3.3.2 Alarm Options

There is one alarm option available for a technical alarm.

Technical Event Sound

The Technical Events Sound option enables/disables audio notification when a technical alarm is triggered. Some events, for example, a **Communications Lost** event, send an audio alarm notification even when the Technical Events Sound option is disabled.

3.3.3 Alarm Responses

Alarm responses are not available for technical alarms, with the exception of the Nurse Call technical event.

3.4 System Alarms

System alarm events are associated with system-wide issues at the Panorama Central Station.

3.4.1 Alarm Behaviors

The visual and audio indicators associated with a system alarm are as follows:

Visual Indicators

System alarm visual indicators display as white text messages in the System Status line.

Audio Indicators

System audio alarm indicators are based on the settings in the **Volume** tab.

4.0 *Arrhythmia and ST Analysis*

This section describes lead placement, arrhythmia, and ST analysis.

- Lead Placement Procedures
- Arrhythmia Algorithm
- ST Segment Analysis
- Arrhythmia Alarms
- Troubleshooting

4.1 Lead Placement Procedures

Site preparation and ECG electrode placement directly impact the quality of an ECG signal. Optimizing an ECG signal is imperative for accurate monitoring.

The processes involved in successful lead placement include:

- Skin Preparation
- Electrode Patches
- Lead Placement Methods: AHA and IEC

4.1.1 Skin Preparation

Proper skin preparation is essential to obtain accurate ECG data. Electrode sites should be clean, dry and should provide a smooth flat surface. Incidental electrical activity and inaccurate readings may occur due to incorrect skin preparation.

The following skin preparation is recommended for secure patch application:

1. Shave the chest hair in a 2-4 inch diameter of the electrode site.
2. Use a dry gauze pad to remove excess skin oils, skin cells and residue from the electrode sites. Never rub the skin until it is raw or bleeding.

NOTE: Prepare the electrode site with alcohol only if the skin is extremely greasy. If alcohol is used as a drying agent, always allow the skin to dry before placing the electrode patch on the skin.

4.1.2 Electrode Patches

NOTE: Store electrode patches at room temperature and open just prior to use.

NOTE: Avoid more than one type of electrode on a patient because of variations in electrical resistance.

NOTE: Avoid placing electrode patches directly over boney prominences or over any activity movement areas such as shoulders or arms because muscle motion produces electrical activity. If an electrode patch is placed over a large muscle such as the pectorals, the monitor may detect this additional muscle activity, which could lead to false arrhythmia calls.

1. Peel the backing off of the electrode patch only when it is ready for use to prevent evaporation of the contact gel medium. Visually inspect the contact gel medium for moistness. If the gel medium is not moist, do not use the electrode patch. Dry electrode patches are not conductive.

NOTE: If using the snap type electrode wires, attach the electrode patch to the lead wire before placing patch on the patient.

2. Attach the electrode patch to the skin at the prepared site. Smooth the electrode patch down in a circular motion to ensure proper skin contact. If using soft gel electrodes, never push down directly over the contact gel medium as this may displace the gel and cause monitoring artifact. If using hard gel electrodes, it is recommended that during application, the center of the electrode should be slightly pressed onto the skin to ensure direct contact. Consult the electrode patch manufacturer's instructions for specific use.
3. Secure the lead wires to the patient according to hospital practice. For additional information, refer to "Lead Placement Methods: AHA and IEC" on page 4-3. If using a Panorama Telepack, always secure the device to the patient according to hospital standard.

WARNING: As with all medical equipment, carefully route cables and connections to reduce the possibility of entanglement or strangulation.

NOTE: It is recommended that electrode patches be changed at least every 24-36 hours to maintain proper contact with the skin. Some patients may require electrodes to be changed more often. Electrode patches are disposable and should not be reused or reapplied. Try to avoid reusing the exact same electrode site during reapplication. If an electrode becomes wet with fluid, change the electrode patch.

4.1.3 Lead Placement Methods: AHA and IEC

The lead placement procedure that is utilized has a direct impact on the quality of an ECG waveform. The algorithm works best when a patient's R wave is significantly larger than the P or T waves to avoid difficulty in identifying the appropriate waves. On some patients, electrode patch placement and/or the ECG lead viewed may need to be adjusted to obtain a more significant R wave.

The following section outlines lead placement procedures for the American Heart Association (AHA) and the International Electro-Technical Commission (IEC).

3-wire Lead Set

A 3-wire lead set can monitor one of three ECG vectors (I, II, or III). The recommended 3-wire ECG lead placement is as follows.

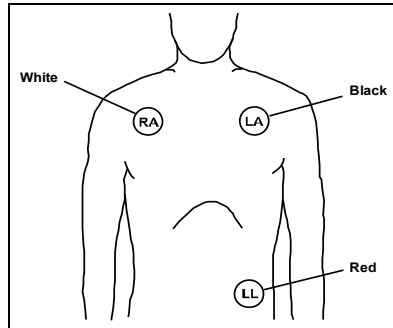

FIGURE 4-1 3-wire Lead Placement (AHA)

- Place RA (white) electrode under right clavicle, mid-clavicular line within the rib cage frame.
- Place LA (black) electrode under left clavicle, mid-clavicular line within the rib cage frame.
- Place LL (red) electrode on the lower left abdomen within the rib cage frame.

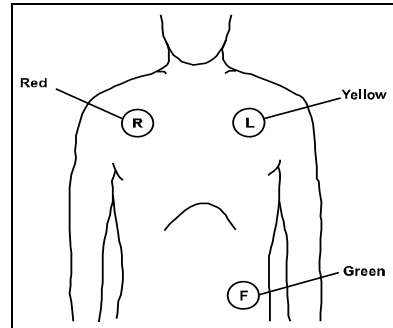

FIGURE 4-2 3-wire Lead Placement (IEC)

- Place R (red) electrode under right clavicle, mid-clavicular line within the rib cage frame.
- Place L (yellow) electrode under left clavicle, mid-clavicular line within the rib cage frame.
- Place F (green) electrode on the lower left abdomen within the rib cage frame.

5-wire Lead Set

A 5-wire lead set can monitor seven ECG vectors (I, II, III, aVR, aVL, aVF, and V) simultaneously. The recommended 5-wire ECG lead placement is as follows.

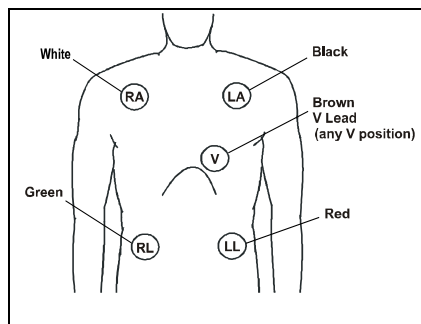

FIGURE 4-3 5-wire Lead Placement (AHA)

- Place RA (white) electrode under the right clavicle, mid-clavicular line within the rib cage frame.
- Place LA (black) electrode under the left clavicle, mid-clavicular line within the rib cage frame.
- Place LL (red) electrode on the lower left abdomen within the rib cage frame.
- Place RL (green) electrode on lower right abdomen within the rib cage frame.
- Place V (brown) chest lead in the proper positioning for desired lead V1-V6.

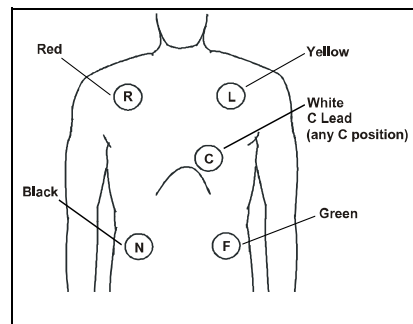

FIGURE 4-4 5-wire Lead Placement (IEC)

- Place R (red) electrode under the right clavicle, mid-clavicular line within the rib cage frame.
- Place L (yellow) electrode under the left clavicle, mid-clavicular line within the rib cage frame.
- Place F (green) electrode on the lower left abdomen within the rib cage frame.
- Place N (black) electrode on lower right abdomen within the rib cage frame.
- Place C (white) chest lead in the proper positioning for the desired lead C1-C6.

6-wire Lead Set

The recommended 6-wire lead placement is as follows.

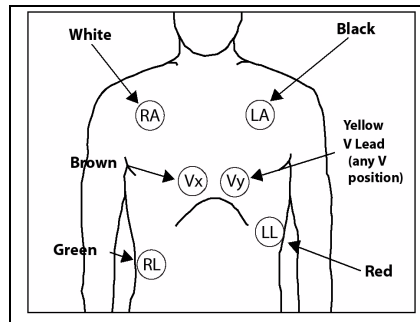

FIGURE 4-5 6-wire Lead Placement (AHA)

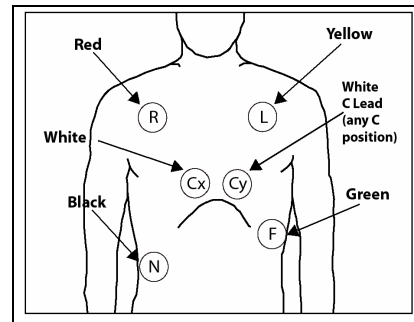

FIGURE 4-6 6-wire Lead Placement (IEC)

- Place the RA (white) electrode under the patient's right clavicle, at the mid-clavicular line within the rib cage frame.
- Place the LA (black) electrode under the patient's left clavicle, at the mid-clavicular line within the rib cage frame.
- Place the LL (red) electrode on the patient's lower left abdomen within the rib cage frame.
- Place the RL (green) electrode on the patient's lower right abdomen within the rib cage frame.
- Place the Vx (brown) electrode in one of the V-lead positions (V1 to V6) depicted in the following section.
- Place the Vy (yellow) electrode in one of the V-lead positions (V1 to V6) depicted in the following section.
- Place the R (red) electrode under the patient's right clavicle, at the mid-clavicular line within the rib cage frame.
- Place the L (yellow) electrode under the patient's left clavicle, at the mid-clavicular line within the rib cage frame.
- Place the F (green) electrode on the patient's lower left abdomen within the rib cage frame.
- Place the N (black) electrode on the patient's lower right abdomen within the rib cage frame.
- Place the Cx (white) electrode in one of the V-lead positions (V1 to V6) depicted in the following section.
- Place the Cy (white) electrode in one of the C-lead (C1 to C6) positions depicted in the following section.

View 12™ Card

A View 12™ card utilizes a 10-wire ECG lead set that can monitor 12 ECG vectors (I, II, III, aVR, aVL, aVF, V1, V2, V3, V4, V5, and V6) simultaneously. The recommended lead placement for a View 12™ card is as follows.

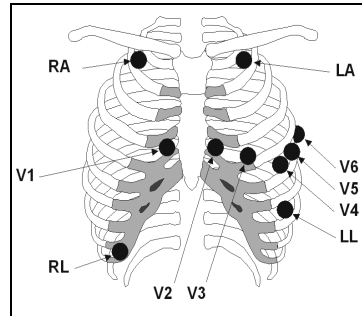

FIGURE 4-7 View 12™ Card Lead Placement (AHA)

- Place RA (white) electrode under the right clavicle, mid-clavicular line within the rib cage frame.
- Place LA (black) electrode under the left clavicle, mid-clavicular line within the rib cage frame.
- Place LL (red) electrode on the lower left abdomen within the rib cage frame.
- Place RL (green) electrode on lower right abdomen within the rib cage frame.
- Place V1 (brown) chest lead in the fourth intercostal space, right sternal border.
- Place V2 (brown) chest lead in the fourth intercostal space, left sternal border.
- Place V3 (brown) chest lead midway between V2 and V4 on a straight line.
- Place V4 (brown) chest lead in the fifth intercostal space, mid-clavicular line.
- Place V5 (brown) chest lead in the fifth intercostal space, anterior axillary line.
- Place V6 (brown) chest lead in the fifth intercostal space, mid-axillary line.

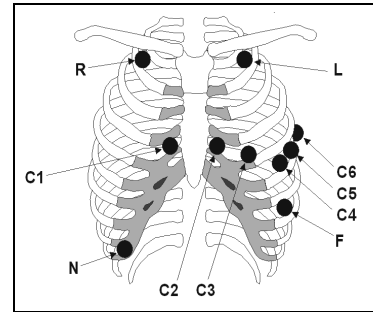

FIGURE 4-8 View 12™ Card Lead Placement (IEC)

- Place R (red) electrode under the right clavicle, mid-clavicular line within the rib cage frame.
- Place L (yellow) electrode under the left clavicle, mid-clavicular line within the rib cage frame.
- Place F (green) electrode on the lower left abdomen within the rib cage frame.
- Place N (black) electrode on lower right abdomen within the rib cage frame.
- Place C1 (white) chest lead in the fourth intercostal space, right sternal border.
- Place C2 (white) chest lead in the fourth intercostal space, left sternal border.
- Place C3 (white) chest lead midway between C2 and C4 on a straight line.
- Place C4 (white) chest lead in the fifth intercostal space, mid-clavicular line.
- Place C5 (white) chest lead in the fifth intercostal space, anterior axillary line.
- Place C6 (white) chest lead in the fifth intercostal space, mid-axillary line.

Lead II Monitoring

The recommended lead placement for Lead II monitoring is as follows.

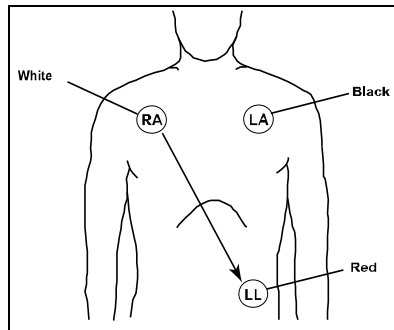

FIGURE 4-9 Lead II Monitoring (AHA)

- Place RA (white) electrode under right clavicle, mid-clavicular line within the rib cage frame.
- Place LA (black) electrode under left clavicle, mid-clavicular line within the rib cage frame.
- Place LL (red) electrode on the lower left abdomen within the rib cage frame.

Select the ECG Lead II at the bedside monitor. Lead II is the direct electrical line between the RA (white) electrode and the LL (red) electrode.

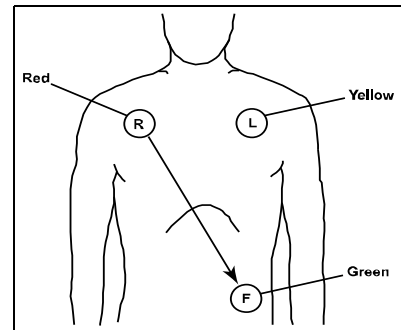

FIGURE 4-10 Lead II Monitoring (IEC)

- Place R (red) electrode under right clavicle, mid-clavicular line within the rib cage frame.
- Place L (yellow) electrode under left clavicle, mid-clavicular line within the rib cage frame.
- Place F (green) electrode on the lower left abdomen within the rib cage frame.

Select the ECG Lead II at the bedside monitor. Lead II is the direct electrical line between the R (red) electrode and the F (green) electrode.

Modified Chest Lead (MCL) Monitoring

The recommended lead placement for MCL monitoring is as follows.

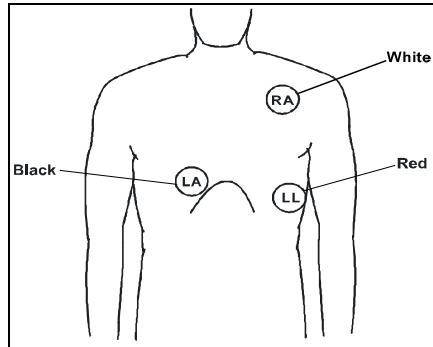

FIGURE 4-11 MCL Monitoring with a 3-wire Lead Set (AHA)

- Place RA (white) electrode under left clavicle, mid-clavicular line within the rib cage frame.
- Place LA (black) electrode on the right sternal border, fourth intercostal in the rib cage frame.
- Place LL (red) electrode on the lower left abdomen within the rib cage frame.

Select ECG Lead I for MCL₁ monitoring. Lead I is the direct electrical line between the RA (white) electrode and the LA (black) electrode.

Select ECG Lead II for MCL₆ monitoring. Lead II is the direct electrical line between the RA (white) electrode and the LL (red) electrode.

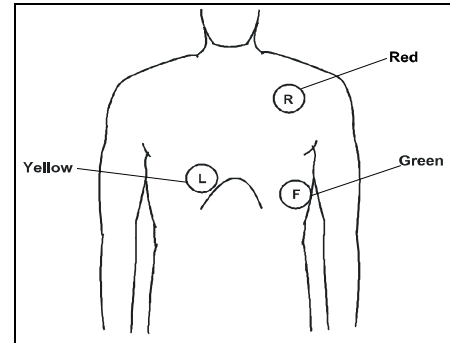

FIGURE 4-12 MCL Monitoring with a 3-wire Lead Set (IEC)

- Place R (red) electrode under left clavicle, mid-clavicular line within the rib cage frame.
- Place L (yellow) electrode on the right sternal border, fourth intercostal in the rib cage frame.
- Place F (green) electrode on the lower left abdomen within the rib cage frame.

Select ECG Lead I for MCL₁ monitoring. Lead I is the direct electrical line between the R (red) electrode and the L (yellow) electrode.

Select ECG Lead II for MCL₆ monitoring. Lead II is the direct electrical line between the L (red) electrode and the F (green) electrode.

Neonatal Electrode Placement

When using a 3-wire lead set, ECG lead placement on a neonate is usually directed towards obtaining the best possible respiration data through the ECG thoracic impedance technique. Thoracic impedance is usually measured between the Right Arm and Left Arm electrode patches. These patches should be placed on the chest directly across from each other to optimize the measuring of the neonate's chest movement.

The recommended lead placement for neonate monitoring is as follows.

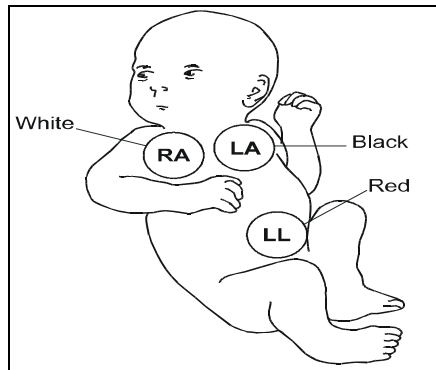

FIGURE 4-13 Neonatal 3-wire Lead Placement (AHA)

- Place RA (white) electrode under patient left clavicle, mid-clavicular line within the rib cage frame.
- Place LA (black) electrode right sternal border, fourth intercostal space within the rib cage frame.
- Place LL (red) electrode on the patient's lower left abdomen within the rib cage frame.

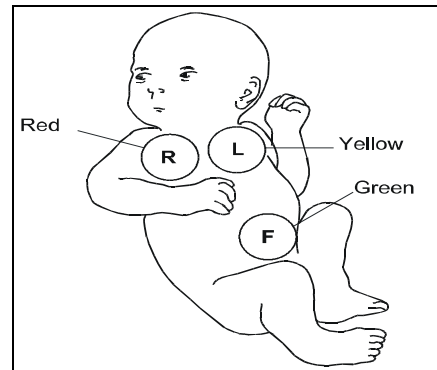

FIGURE 4-14 Neonatal 3-wire Lead Placement (IEC)

- Place R (red) electrode under patient left clavicle, mid-clavicular line within the rib cage frame.
- Place L (yellow) electrode right sternal border, fourth intercostal space within the rib cage frame.
- Place F (green) electrode on the patient's lower left abdomen within the rib cage frame.

Using a Transcutaneous Electrical Nerve Stimulator (TENS)

Since a TENS unit transmits electrical impulses, avoid placing ECG electrode patches near the TENS electrodes. ECG electrode patches may need to be repositioned and the ECG lead viewed may need to be adjusted until the optimum ECG tracing is obtained.

Monitoring a Pacemaker Patient

The recommended lead placement for a pacemaker patient is as follows.

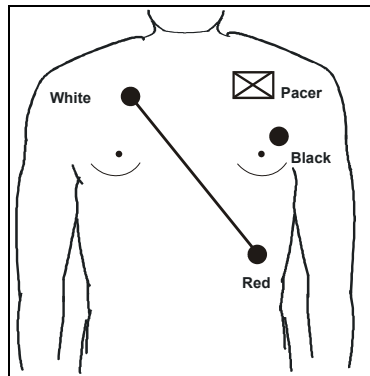

FIGURE 4-15 Placement for a Pacemaker Patient - 3-wire Lead (AHA)

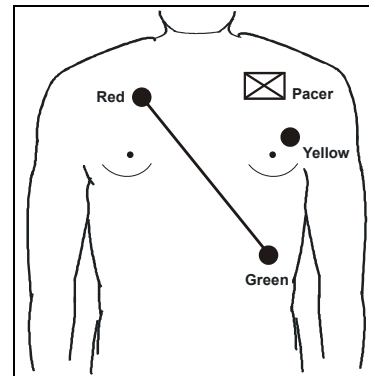

FIGURE 4-16 Placement for a Pacemaker Patient - 3-wire Lead (IEC)

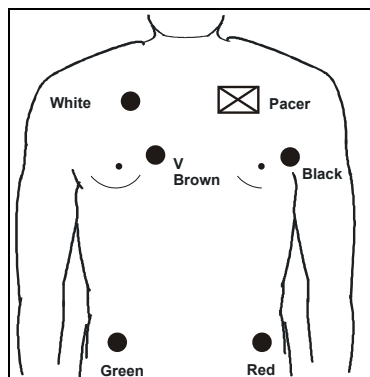

FIGURE 4-17 Placement for a Pacemaker Patient - 5-wire Lead (AHA)

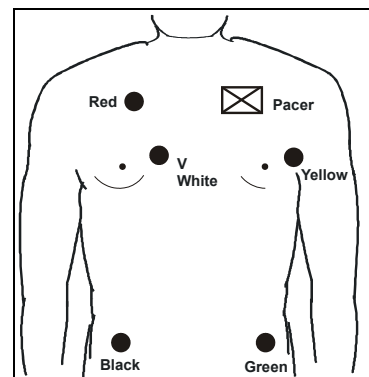

FIGURE 4-18 Placement for a Pacemaker Patient - 5-wire Lead (IEC)

A Pacemaker patient usually requires a different electrode patch placement configuration than a non-pacemaker patient.

Do not place an ECG electrode directly over the pacemaker generator. Place the electrode patches 3-5 inches away from the pacemaker generator area to avoid electrical interference. If the electrode patches are placed closer to pacemaker generator, the ECG will contain artifact, sometimes called "picket fence syndrome." For example, if the pacemaker generator is located in the right subclavian area, relocate the Right Arm (white) electrode closer in towards the center of the chest.

WARNING: PACEMAKER PATIENTS - Indication of the heart-rate may be adversely affected by cardiac pacemaker pulses or by cardiac arrhythmias. Keep pacemaker patients under close surveillance. Refer to "ECG Performance Requirements" on page 16-2 for disclosure of the pacer rejection capability.

CAUTION: Some pacemakers may contain a respiratory sensor that may produce artifact on an ECG waveform.

4.2 Arrhythmia Algorithm

The Panorama Central Station uses an arrhythmia algorithm to monitor ECG waveform data. The arrhythmia analysis feature is intended to detect ventricular rhythms only. However, due to physiologic differences in patient populations, the arrhythmia algorithm may occasionally result in a false alarm or may not recognize certain arrhythmia patterns.

The algorithm creates ECG waveform templates based on a patient's normal ECG data and uses them to analyze newly received data. The algorithm verifies that data is free from noise and artifact, and that it does not deviate from the patient's normal ECG rhythms.

A normal ECG waveform typically includes consistent spacing between R waves, a sharp and well defined QRS complex, and an ECG baseline that is free of noise and artifact. The computerized arrhythmia algorithm works best when the patient's R wave is significantly larger than the P wave and the T wave. If the R wave is not significantly larger than other lower voltage waves on the ECG tracing, the computer may have some difficulty in identifying the appropriate waves. On some patients, electrode patch placement and/or the viewed ECG lead may need to be adjusted in order to obtain a significant R wave.

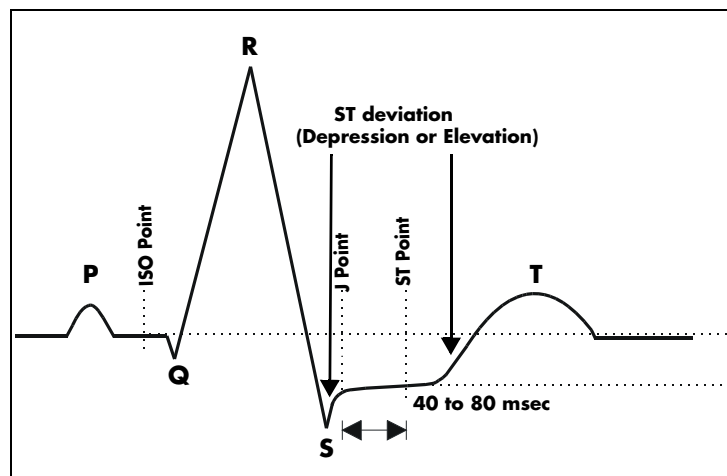

FIGURE 4-19 Sample Waveform

Noise and Artifact

The presence of noise or artifact in an ECG waveform makes the accurate detection and classification of heart beats difficult. To best optimize performance, all leads should be free of noise. If artifact is present on any ECG lead/waveform, then the arrhythmia processing, alarm processing, and quality of the monitoring function may be adversely affected.

Some of the causes of ECG noise include poor skin preparation, improperly attached electrodes, dried electrode gel, defective lead wires, and patient movement. The algorithm uses several techniques to differentiate a patient's QRS complexes from noise sources.

If noise levels are too high, the following will occur until the signal quality is re-established:

- Beat detection is suspended
- All rhythm calls are suspended
- An **ECG Noise** message is displayed in the Patient Status line at the Panorama Central Station when the noise continues beyond the configured noise delay

Heart Rate Meter

Heart Rate is computed using the 16 most recent R-R intervals for heart rates above 48 beats per minute while 4 R-R intervals are used at rates equal to or less than 48 beats per minute. All detected beats are used to compute the heart rate. A separate ventricular rate is used in the algorithm to determine rhythms like ventricular tachycardia and ventricular run.

Filtering Pacer Signals

In order to prevent pacer pulses from being mistaken for QRS complexes, they are removed from the ECG data sent to the arrhythmia algorithm for analysis. Pacer pulses are shown on the Panorama Central Station and bedside monitors as exaggerated vertical lines.

ECG Amplitude

The QRS detection threshold algorithm setting is fixed between 0.15 and 0.45 mV to avoid detecting noise spikes or P-waves as valid beats. Changing the display gain (or wave gain) on the monitor does not affect the signal that is used by the algorithm for beat detection. For optimal performance, the leads selected for monitoring should have an amplitude of 0.5 to 1 mV or more.

Learning

The process of learning is used to establish a normal beat template for a patient. The learn period is dependent on heart rate and dominant pattern. Learning should not be initiated during a primarily ventricular rhythm because an ectopic beat may be established as normal.

A learn should be initiated when beats are not being properly detected, or when they are being erroneously classified. However, if a signal is not strong enough, or lead data is extremely noisy, better signal quality must be established before a learn can be effective.

Beat Detection and Typing

The following table describes the leads that are used for beat detection and beat typing.

DESCRIPTION	3-WIRE LEAD SET	5-WIRE LEAD SET 6-WIRE LEAD SET	VIEW 12™ CARD
Leads used for Beat Detection	Determined by viewed lead	II and V	V1 and V5
Leads used for Beat Typing	Determined by viewed lead	II, V, and I	V1, V5, and II
Leads used for V-Fib Detection	Determined by viewed lead	II and V	V1 and V5

The search for the next beat begins after a refractory period to avoid detecting T-waves as valid QRS complexes. The minimum QRS amplitude that can be detected is between 0.15 mV and 0.45 mV depending on the width of the QRS complex.

Beat typing aligns and compares each new heart beat to reference templates that were previously stored in the system. A beat typing algorithm classifies the beats.

- If an incoming beat matches a template that has already been classified, it is given the same label as the template. The template parameters are updated with the features from this new beat.

The real time ECG analysis library incorporates ventricular ectopic beat detection as a part of arrhythmia analysis.

- Beats are measured for compensatory pause, QRS width, QRS positive and negative areas, and R wave positive and negative amplitudes. This process uses multiple leads when available.
- A scoring algorithm is then applied to those measurements to determine whether or not a beat is ectopic. Beat detection and typing uses the monitored lead whenever a 3-wire lead set is used.

4.3 ST Segment Analysis

The ST segment of an ECG waveform (shown in FIGURE 4-19) represents the period from the end of ventricular de-polarization, to the beginning of ventricular re-polarization, or the end of the QRS complex (the J point) and the beginning of the T-wave. ST Segment analysis is used to monitor the oxygen supply and the viability of the heart muscle.

ST deviation is the vertical distance between the isoelectric (ISO) point level and signal level at ST point.

The ISO point is located between the end of the P-wave and the onset of the QRS complex. The ISO point provides the baseline for this measurement.

The ST point is a fixed distance from the J point at the end of the QRS complex. The ST point can be configured to 40, 60, or 80 milliseconds past the J-point, independent of the heart rate. By default, the ST point is positioned as follows:

- at 80 milliseconds for heart rates less than or equal to 120 beats per minute
- at 60 milliseconds for heart rates greater than 120 beats per minute

ST segments are typically calculated on graph paper with a scale of 1cm/mV, and measured in millimeters where one millimeter is equivalent to 0.1 mV. The reliability of ST measurements is lowered with the presence of atrial fibrillation, flutter, and erratic baseline changes.

Selecting leads that contain the least amount of baseline flutter will improve measurement accuracy, but accurate ST deviation measurement is dependent on the correct location of the ISO and ST points.

All available ECG leads are analyzed to measure deviations in the ST segment.

The displayed ST data is updated approximately every 10 seconds.

Learning

The process of learning is used to establish normal beat templates or a stable baseline for accurate ST analysis. To establish this baseline, the system evaluates the first sixteen normal beats based on readings from leads II, V, and I.

To establish an accurate baseline, it is recommended that learning be done when the patient is in stable condition, not moving, and has an ECG rhythm that is free of artifact. Learning should not be initiated during a primarily ventricular rhythm or other ECG rhythm irregularity because an ectopic beat may be established as normal.

Learning automatically occurs when:

- Arrhythmia analysis is turned on
- ST analysis is turned on
- Patient monitoring resumes and patient is removed from the Standby mode
- A 3-wire lead set is in use and the current ECG lead is changed

ECG Filters

The ST segment of an ECG waveform often contains low amplitude signals with low frequency content. To preserve low frequency signal content, the high pass filter is set to 0.05 Hz when ST analysis is turned on.

4.4 Arrhythmia Alarms

Arrhythmia alarms are activated based on the patterns in the patient ECG waveform rhythms. Beat detection for a 5-lead wire set is determined by using a combination of leads II and V. When using a 3-lead wire set, beat detection is determined by using only the viewed lead.

The following lethal and non-lethal arrhythmia alarms may be detected by the arrhythmia algorithm. For additional information regarding alarm behavior at the Panorama Central Station, refer to "Alarm Behavior" on page 3-1.

NOTE: **Cardiac arrhythmia alarm condition events are detected and processed by the bedside monitor. When using a Telepack device, the detection and processing of the event is done by the Panorama Central Station.**

NOTE: Arrhythmia alarms are not available for the Neonate patient size.

NOTE: The TACHY arrhythmia call for DPM6/7 is not supported on the Panorama system. However, High Heart Rate alarms would be called when that level is met.

4.4.1 Lethal Arrhythmia Alarms

A lethal arrhythmia is an arrhythmia that can be life threatening to a patient if left untreated. Ventricular Tachycardia (V-Tach), Ventricular Fibrillation (V-Fib), and Asystole alarms are classified as lethal arrhythmia alarms. These alarms automatically default to Alarm Priority 1.

NOTE: Lethal arrhythmia alarms may be configured to have a different alarm sound than other physiological alarms. The sounds used are determined during system setup and configuration.

NOTE: Lethal arrhythmia alarms are latched alarms and must be acknowledged after the condition is resolved. To acknowledge the alarm, select the digital data area or the waveform area of the affected patient tile.

NOTE: If a lethal arrhythmia alarm condition exists, and a transition to a different lethal arrhythmia alarm condition occurs, a new event will be stored and a printout will be generated, as configured.

NOTE: When a V-Tach or V-Fib alarm occurs and is replaced by an Asystole alarm, the Asystole alarm will be paged. This will occur if Paging has been installed on the central station; the Asystole alarm paging delay timer has expired; and the alarm condition still exists when the paging delay timer has expired.

Asystole Alarm

An **Asystole** alarm is activated at the Panorama Central Station when no QRS complexes are detected for the configured time period in the absence of Ventricular Fibrillation. When using a View 12™ card, the time period range for an Asystole alarm is between three (3) and eight (8) seconds. When using a 3 or 5-wire lead set, the time period range for an Asystole alarm is between three (3) and ten (10) seconds.

The Asystole alarm is a Priority 1 alarm event that:

- Produces an Alarm Priority 1 visual and audio alarm indicators once the condition is identified.
- Causes a red **Asystole** text message to display in the Patient Status line.

Ventricular-Fibrillation (V-Fib) Alarm

A **V-Fib** alarm is activated at the Panorama Central Station when a fibrillated waveform (P, QRS or T waves can no longer be identified) is detected. V-Fib is defined as “irregular, disorganized electrical activity of the heart”. The ECG signal for V-Fib continuously changes shape, interval, and amplitude. The V-Fib detection algorithm runs in parallel to the beat detection algorithm and continuously examines the incoming data.

The V-Fib alarm is a Priority 1 alarm event that:

- Produces Alarm Priority 1 visual and audio alarm indicators once the condition is identified.
- Causes a red **V-Fib** text message to display in the Patient Status line.

Ventricular Tachycardia (V-Tach) Alarm

A **V-Tach** alarm is activated at the Panorama Central Station as follows:

- The V-Tach lethal arrhythmia alarm is activated when the configured number of consecutive PVCs is reached at a rate equal to or greater than the V-Tach threshold. The range of the V-Tach rate is 100 to 180 beats. The range of the V-Tach threshold is 3-15 bpm.

A V-Tach alarm is a Priority 1 alarm event that:

- Produces the Alarm Priority 1 visual and audio alarm indicators once the condition is identified.
- Causes a red **V-Tach** text message to display in the Patient Status line.

4.4.2

Non-Lethal Arrhythmia Alarms

A Non-Lethal Arrhythmia is an arrhythmia that is most likely not life threatening to a patient. Bigeminy, Bradycardia, Couplet, Irregular Heart Rate, Pause, PVC, Run, Trigeminy, R-On-T PVC, and Ventricular Rhythm (V-Rhythm) alarms are non-lethal arrhythmia alarms, and depending on the alarm, default to Alarm Priority 2 or 3 (except for Bradycardia).

NOTE: **Non-Lethal arrhythmia alarms are not latched alarms and can be acknowledged at anytime.**

Bigeminy Alarm

The **Bigeminy** alarm is activated at the Panorama Central Station when three or more cycles of one PVC coupled to one normal beat are detected.

The Bigeminy alarm has priority settings of **2**, **3**, and **OFF**. When the setting is:

- Set to **2**, the Panorama Central Station produces an Alarm Priority 2 sound once the condition is identified.
- Set to **3**, the Panorama Central Station produces an Alarm Priority 3 sound once the condition is identified.
- Set to **OFF**, the Panorama Central Station does not produce any audio alarm indicators for the Bigeminy alarm condition.
- The Bigeminy alarm causes a yellow **Bigeminy** text message to display in the Patient Status line.

Bradycardia (Brady) Alarm

The **Brady** alarm is activated at the Panorama Central Station when the heart rate falls to a value 10% lower than the user selected value for low heart rate alarm.

NOTE: **The Bradycardia alarm is not available when using a View 12™ card.**

NOTE: **The Brady alarm will not be suspended when the Suspend Non-Lethals sidebar button is selected.**

NOTE: **Brady alarms may be configured to have a different alarm sound than other non-lethal physiological alarms. The sounds used are determined during system setup and configuration.**

The **Brady** alarm has priority settings of **1** and **OFF**. When the setting is:

- Set to **1**, the Panorama Central Station produces an Alarm Priority 1 sound once the condition is identified.
- Set to **OFF**, the Panorama Central Station does not produce any audio alarm indicators for the Bradycardia alarm condition.
- The Bradycardia alarm causes a **Brady** text message to display in the Patient Status line. The color of the message is dependant on the alarm priority configured.

Couplet Alarm

The **Couplet** alarm is activated at the Panorama Central Station when two consecutive PVCs are detected between normal beats.

The Couplet alarm has priority settings of **2**, **3**, and **OFF**. When the setting is:

- Set to **2**, the Panorama Central Station produces an Alarm Priority 2 sound once the condition is identified.
- Set to **3**, the Panorama Central Station produces an Alarm Priority 3 sound once the condition is identified.
- Set to **OFF**, the Panorama Central Station does not produce any audio alarm indicators for the Couplet alarm condition.
- The Couplet alarm causes a yellow **Couplet** text message to display in the Patient Status line.

Irregular Heart Rate Alarm

The **Irregular Heart Rate** alarm is activated at the Panorama Central Station when the measured variation in the R-R interval over a period of time exceeds a preset limit established by the arrhythmia algorithm.

NOTE: **The Irregular Heart Rate alarm is not available when using a View 12™ card.**

The Irregular Heart Rate alarm has priority settings of **2**, **3**, and **OFF**. When the setting is:

- Set to **2**, the Panorama Central Station produces an Alarm Priority 2 sound once the condition is identified.
- Set to **3**, the Panorama Central Station produces an Alarm Priority 3 sound once the condition is identified.
- Set to **OFF**, the Panorama Central Station does not produce any audio alarm indicators for the Irregular Heart Rate alarm condition.
- The Irregular Heart Rate alarm causes a yellow **Irregular HR** text message to display in the Patient Status line.

Pause Alarm

The **Pause** alarm is activated at the Panorama Central Station when no beat is detected during an interval that is greater than 1.8 R-R and when the next beat is not a PVC.

NOTE: **The Pause alarm is only available when using a View 12™ card.**

The **Pause** alarm has priority settings of **1**, **2**, **3**, and **OFF**. When the setting is:

- Set to **1**, the Panorama Central Station produces an Alarm Priority 1 sound once the condition is identified.
- Set to **2**, the Panorama Central Station produces an Alarm Priority 2 sound once the condition is identified.
- Set to **3**, the Panorama Central Station produces an Alarm Priority 3 sound once the condition is identified.
- Set to **OFF**, the Panorama Central Station does not produce any audio alarm indicators for the Pause alarm condition.
- The Pause alarm causes a **Pause** text message to display in the Patient Status line. The color of the message is dependant on the configured alarm priority.

PVC/minute Alarm

The **High PVC** alarm is activated at the Panorama Central Station when the number of PVCs detected per minute exceeds the configured threshold. The PVC rate alarm can be set to Off, or 1 to 30 PVCs per minute.

NOTE: **The PVC/min counter will be set to invalid and display (---) when Asystole, V-Tach, V-Fib, or V-Rhythm is detected.**

The High PVC alarm has priority settings of **2**, **3**, and **OFF**. When the setting is:

- Set to **2**, the Panorama Central Station produces an Alarm Priority 2 sound once the condition is identified.
- Set to **3**, the Panorama Central Station produces an Alarm Priority 3 sound once the condition is identified.
- Set to **OFF**, the Panorama Central Station does not produce any audio alarm indicators for the High PVC alarm condition.
- The High PVC alarm causes a yellow **High PVC** text message to display in the Patient Status line.

Run Alarm

The **Run** alarm is activated at the Panorama Central Station when the number of consecutive PVCs occur at a rate that exceeds the user defined V-Tach rate from 3 beats in a row to one beat less than the user defined V-Tach threshold. For additional information about V-Tach, refer to the definition for "Ventricular Tachycardia (V-Tach) Alarm" on page 4-16.

NOTE: **An R ON T condition at the DPM6/7 bedside monitor will be broadcasted as a Run alarm on the Panorama Central Station.**

The Run alarm has priority settings of **2**, **3**, and **OFF**. When the setting is:

- Set to **2**, the Panorama Central Station produces an Alarm Priority 2 sound once the condition is identified.
- Set to **3**, the Panorama Central Station produces an Alarm Priority 3 sound once the condition is identified.

- Set to **OFF**, the Panorama Central Station does not produce any audio alarm indicators for the Run alarm condition.
- The Run alarm causes a yellow **Run** text message to display in the Patient Status line.

Trigeminy Alarm

The **Trigeminy** alarm is activated at the Panorama Central Station when three or more cycles of one PVC coupled to two normal beats are detected. This rhythm could also cause an Irregular HR alarm.

The Trigeminy alarm has priority settings of **2**, **3** and **OFF**. When the setting is:

- Set to **2**, the Panorama Central Station produces an Alarm Priority 2 sound once the condition is identified.
- Set to **3**, the Panorama Central Station produces an Alarm Priority 3 sound once the condition is identified.
- Set to **OFF**, the Panorama Central Station does not produce any audio alarm indicators for the Trigeminy alarm condition.
- The Trigeminy alarm causes a yellow **Trigeminy** text message to display in the Patient Status line.

R-On-T PVC

The R-On-T PVC alarm is activated when the following occurs:

- A beat is detected as a PVC and previous beat is not a PVC
- Current BTB heart rate is > 120 bpm
- Current RR-interval is < previous RR-interval

The R-On-T PVC alarm is a Medium level alarm event that produces:

- Medium level visual and audio alarm indicators
- A R-On-T PVC text message above the primary waveform area

Ventricular Rhythm (V-Rhythm) Alarm



The **V-Rhythm** alarm is activated at the Panorama Central Station when the number of consecutive PVCs is greater than three and the ventricular rate is less than the configured V-Tach threshold.

The V-Rhythm alarm has priority settings of **2**, **3**, and **OFF**. When the setting is:

- Set to **2**, the Panorama Central Station produces an Alarm Priority 2 sound once the condition is identified.
- Set to **3**, the Panorama Central Station produces an Alarm Priority 3 sound once the condition is identified.
- Set to **OFF**, the Panorama Central Station does not produce any audio alarm indicators for the V-Rhythm alarm condition.
- The V-Rhythm alarm causes a yellow **V-Rhythm** text message to display in the Patient Status line.

4.5 Troubleshooting

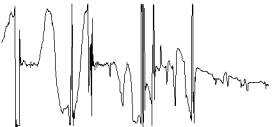
This section lists some of the potential messages and issues that may occur. For additional assistance troubleshooting arrhythmia analysis, please contact a Mindray Clinical Educator at 1-800-288-2121 (U.S and Canada only) or 201-995-8000 (outside U.S. and Canada).

MESSAGE/ISSUE *	REASON	SOLUTION
Noisy ECG traces 	Loose or dry electrodes. Defective electrode wires. Patient cable or leads are routed too close to other electrical devices.	Apply fresh, moist electrodes. Replace wires as necessary. Eliminate 60 Hz interference.
Excessive Electro-surgical Interference	Wrong ECG cable used.	Use ECG cable with internal filter block. NOTE: Respiration monitoring via the ECG electrodes will not be available when using the cable.
	Muscle noise. Inadequate skin preparation prior to application of electrode, tremors, tense subject, and/or poor electrode placement. Patient may have a pacemaker that contains a respiratory sensor.	Repeat skin preparation and electrode location procedures. Apply fresh, moist electrodes. Avoid areas of the torso that are very muscular. Reposition electrodes to reduce ECG artifact.
Intermittent Signal	Connections not tight and/or properly secured. Electrodes dry or loose. Cable or lead wires damaged.	Ensure proper connection. (cable to monitor, cable to lead, lead to electrode). Repeat skin preparation and apply fresh, moist electrodes. Check with continuity tester.
Excessive alarms: heart rate, lead fault	Electrodes dry Alarm limits set too close to patient's normal heart rate. R-wave wrong size Excessive patient movement or muscle tremor.	Repeat skin preparation and apply fresh, moist electrodes. Adjust alarm limits. Must be twice the amplitude of the other waves, like the P and T waves. Reposition electrodes and secure with tape, if necessary.

* Messages are shown in all bold text.

MESSAGE/ISSUE *	REASON	SOLUTION
Low Amplitude ECG Signal	<p>Electrode could be positioned over a bone or muscle mass.</p> <p>Electrodes dry/old</p> <p>Skin improperly prepared</p> <p>This could be the patient's normal QRS complex.</p> <p>Gain set too low.</p>	<p>Move ECG patches closer towards each other.</p> <p>Apply fresh, moist electrodes.</p> <p>Abrade skin.</p> <p>Verify with 12-lead electro-cardiogram.</p> <p>Readjust the ECG wave gain as required. Refer to the Wave Gain Tab (System) for instructions on adjusting the wave gain setting.</p> <p>NOTE: Changing the ECG wave gain does not affect the arrhythmia algorithm.</p>
No ECG Waveform	<p>Gain set too low.</p> <p>Lead wires and patient cable not fully or properly inserted.</p> <p>Cable or lead wires damaged.</p>	<p>Readjust the ECG wave gain as required. Refer to the Wave Gain Tab (System) for instructions on changing the wave gain setting.</p> <p>NOTE: Changing the ECG wave gain does not affect the arrhythmia algorithm.</p> <p>Check for proper insertion.</p> <p>Check with lead continuity tester.</p>
Base Line Wander	<p>Patient moving excessively.</p> <p>Patient's respiration</p> <p>Electrodes dry or loose</p> <p>Static build up around patient.</p>	<p>Secure lead wires and cable to patient.</p> <p>Reposition electrodes</p> <p>Repeat skin preparation and apply fresh, moist electrodes.</p> <p>Check with biomedical engineer.</p>

* Messages are shown in all bold text.

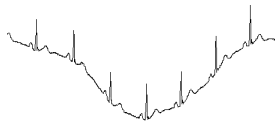

This page intentionally left blank.

Patient Setup Functions

This section describes patient setup at the Panorama Central Station.

- Demographics Tab
- Transfer Tab
- Discharge Tab
- Display Tab
- Standby Tab
- Wave Gain Tab (Patient)
- Print Setup Tab (Patient)

5.1 Demographics Tab

The **Demographics** tab (shown in FIGURE 5-1) allows for the entry and modification of patient demographic information (such as name, age, and weight) and patient settings (such as care group, pacer, arrhythmia, and ST). The **Demographics** tab is only accessible when the selected patient tile is assigned to a monitoring device. The default settings for patient demographics are defined by the **Unit Choices** tab, which is described in the "Unit Choices Tab" on page 9-50.

The **Demographics** tab is available at the ViewStation (shown in FIGURE 5-3) but is for viewing purposes only. When a patient tile is assigned at the ViewStation, it will always display the demographic information of the associated host central station patient tile, provided the patient tile is in an active state.

The **Demographics** tab is available at the WorkStation and may be used in the same manner as it is at the central station. Similar to the central station, demographic changes made to a patient tile at the WorkStation will be sent to the central station, View Only Workstation, and bedside monitor (if applicable).

Automatic updating of the demographic information at the remote workstation will also occur when communication is interrupted, for example:

- The monitoring device is placed in the Standby mode at the central station
- The monitoring device is not communicating with its host central station (Communications Lost)
- Communication between the host central station and the ViewStation and/or the WorkStation is lost (Central Communications Lost)

NOTE: **The host central station(s) C-LAN configuration settings and the software installed at the remote location dictates the functionality available for each patient tile. For additional information, refer to "The ViewStation and the WorkStation" on page 2-4.**

5.1.1 Communications with the Panorama Gateway

If the central station is communicating with an Electronic Medical Records (EMR) system through the Panorama Gateway, entry of demographic information into the **Demographics** tab will differ slightly from the data entry instructions that follow. When using an EMR system, any changes to patient demographics made at the central station and/or bedside monitor will not be sent to the EMR system.

For the central station to be recognized by the EMR system, specific demographics content, referred to as the "Patient Key", must be entered in the **Demographics** tab. Each facility has its own unique "Patient Key." The "Patient Key" consists of the required ID # and, optionally, one or more of the following Patient Menu demographics fields:

- First Name
- Last Name
- Bed # (may be entered for Telepack devices only)

Once the correct "Patient Key" has been entered, communication with the EMR system must be verified. Since the Panorama Gateway can be purchased with Admit/Discharge/Transfer (ADT) messaging only, Results messaging only or ADT messaging with Results messaging, this verification differs as follows:

ADT Messaging

For a Panorama Gateway that has ADT messaging, verify that communication with the EMR system has been established as follows:

- If demographics information corresponding to the following fields was not part of the "Patient Key" but was entered into the EMR system, these fields should auto-populate:
 - ID #
 - First name
 - Last name
 - Date of Birth
 - Gender
- If the fields do not auto-populate, verify that the "Patient Key" was correctly entered and that the patient demographics were entered in the EMR system. If the fields still do not auto-populate after verification, contact the EMR administrator.

Results Messaging

For a Panorama Gateway that has Results messaging, verify that communication with the EMR system has been established by checking the charting system to ensure that patient's vital signs data has been uploaded. If the charting system is not displaying this information, contact the EMR administrator.

5.1.2 Accessing the Demographics Tab

1. From the menu bar, select the **Patient Setup** menu button. The **Demographics** tab is displayed.
2. Choose a patient tile by selecting its digital or waveform area. The **Demographics** tab is enabled.

FIGURE 5-1 Demographics Tab (Central Station using a Bedside Monitor device)

Demographics	Discharge	Display	Standby	Wave Gain	Print Setup	Pacer
Device Label	Bed					
rr						
Last Name	First Name	ID				
HARRISN	ABBY	123				
Height		Gender	Date Of Birth			
in	cm	Unspecified				
Weight		Patient Size - Adult		Date Of Birth		
lbs	kg					
Doctor	Comments					Normal Screen

FIGURE 5-2 Demographics Tab (WorkStation using a Bedside Monitor device)

Demographics	Display	Wave Gain	Print Setup	Pacer
Device Label	Bed			
demo1				
Last Name	First Name	ID		
JONES	JACOB	ICU6789		
Height		Gender - Unspecified	Date Of Birth	
61.0 in	154.9 cm			
Weight		Patient Size - Adult		Date Of Birth
195 lbs	88.6 kg			1945/01/01
Doctor	Comment			Normal Screen
SINGER				

FIGURE 5-3 Demographics Tab - Bedside and/or Telepack (ViewStation)

NOTE: The layout and functionality of the Demographics tab changes based on the type of monitoring device assigned to the patient tile.

5.1.3 Entering Data in the Demographics Tab

This section outlines entering and modifying data in the **Demographics** tab.

NOTE: Patient demographic information cannot be edited at the ViewStation.

Select the Patient to be Set Up/Modified

Choose a patient tile by selecting its digital data or waveform area.

Device Label Field

The **Device Label** field displays the identification label for the device assigned to the selected patient tile.

The device label cannot be entered or modified in the **Demographics** tab. Device Label data is entered and modified via the "Equipment Setup Tab" as described on page 9-33.

Bed Field

The **Bed** field is used to display and enter the label data for bed assignment. The **Bed** field can only be entered, or modified, at the bedside monitor.

NOTE: When using a WMTS 608 bedside monitor, 15 characters may be entered at the bedside monitor but only the first five (5) characters will be displayed in the Bed field.

Entering a value in the Bed Field (Telepack)

1. From the **Demographics** tab, select the **Bed** field. The keyboard dialog box is displayed.
2. Enter a bed value.
 - The Backspace (<==) button clears a single character in the edit box.
 - The **Caps Lock** button enables/disables the caps lock function. A Caps Lock indicator displays when **Caps Lock** is enabled.
3. Accept or reject the text entered in the keyboard entry.
 - The **Close** button discards the changes.
 - The **Enter** button accepts the changes.

Last Name Field

The **Last Name** field is used to enter the last name of a patient. A patient's last name can be entered at the bedside monitor or the Panorama Central Station. Information entered at either the bedside, or at the central station, is automatically transmitted bi-directionally between the devices.

NOTE: If the central station is communicating with an EMR system via the Panorama Gateway, this field may auto-populate once the "Patient Key" has been correctly entered.

1. Select the **Last Name** field. The keyboard dialog box is displayed.
2. Enter the patient's last name (maximum of 15 characters).
 - The Backspace (<==) button clears a single character in the edit box.
 - The **Caps Lock** button enables/disables the caps lock function. A Caps Lock indicator displays when **Caps Lock** is enabled.
3. Accept or reject the text entered in the keyboard dialog box.
 - The **Close** button discards the changes.
 - The **Enter** button accepts the changes.

First Name Field

The **First Name** field is used to enter the first name of a patient. A patient's first name can be entered at the bedside monitor or the Panorama Central Station. Information entered at either the bedside, or at the central station, is automatically transmitted bi-directionally between the devices.

NOTE: If the central station is communicating with an EMR system via the Panorama Gateway, this field may auto-populate once the "Patient Key" has been correctly entered.

1. From the **Demographics** tab, select the **First Name** field. The keyboard dialog box is displayed.
2. Enter the patient's first name (maximum of 15 characters).
 - The Backspace (<==) button clears a single character in the edit box.

- The **Caps Lock** button enables/disables the caps lock function. A Caps Lock indicator displays when **Caps Lock** is enabled.
3. Accept or reject the text entered in the keyboard dialog box.
 - The **Close** button discards the changes.
 - The **Enter** button accepts the changes.

For additional information, refer to “Simultaneous Patient Demographic Tab Editing” on page 5-18.

ID Field

The **ID** field is used to enter the ID of a patient. A patient's ID can be entered at the bedside monitor or the Panorama Central Station. Information entered at either the bedside, or at the central station, is automatically transmitted bi-directionally between the devices.

1. From the **Demographics** tab, select the **ID** field. The keyboard dialog is displayed.
2. Enter the patient's ID.
 - The Backspace (**<==**) button clears a single character in the edit box.
 - The **Caps Lock** button enables/disables the caps lock function. A Caps Lock indicator displays when **Caps Lock** is enabled. Accept or reject the text entered in the keyboard dialog box.

For additional information, refer to “Simultaneous Patient Demographic Tab Editing” on page 5-18.

Height Fields

The **Height** field is used to enter the height of a patient. A patient's height can be entered at the bedside monitor or the Panorama Central Station. Information entered at either the bedside, or at the central station, is automatically transmitted bi-directionally between the devices.

1. From the **Demographics** tab, select the **Height** field. The **Height** dialog box (shown in FIGURE 5-4) is displayed.



FIGURE 5-4 Height Dialog Box

2. Rotate the dial control or use the arrow buttons to select a value in the **Height** dialog box. Refer to the following value ranges.

TABLE 5-1 All Spectrum and Passport (All Patients)

CONTROLS	INCHES (in)	CENTIMETERS (cm)
Range	8.0 to 120.0 in	20.0 to 305.0 cm
Dial Control	Increases number of inches when turned in a clockwise direction Decreases number of inches when turned in a counter-clockwise direction	Increases number of centimeters when turned in a clockwise direction Decreases number of centimeters when turned in a counter-clockwise direction
Single arrow	Increases/decreases inches by 0.5 in until 20.0 in is reached Increases/decreases inches by 1.0 in until 120.0 in is reached	Increases/decreases cm by 1.0 cm until 120.0 cm is reached
Double arrow	Increases/decreases inches by 5.0 in until 20.0 in is reached Increases/decreases inches by 10.0 in until 120.0 in is reached	Increases/decreases cm by 10.0 cm until 305.0 cm is reached

TABLE 5-2 DPM6/7 (All Patients)

CONTROLS	INCHES (in)	CENTIMETERS (cm)
Range	8.0 to 118.0 in	20.0 to 300.0 cm
Dial Control	Increases number of inches when turned in a clockwise direction Decreases number of inches when turned in a counter-clockwise direction	Increases number of centimeters when turned in a clockwise direction Decreases number of centimeters when turned in a counter-clockwise direction
Single arrow	Increases/decreases inches by 1.0 in	Increases/decreases cm by 1.0 cm
Double arrow	Increases/decreases inches by 10.0	Increases/decreases cm by 10.0

TABLE 5-3 V Series (All Patients)

CONTROLS	INCHES (in)	CENTIMETERS (cm)
Range	8.0 to 108.0 in	20.0 to 275.0 cm
Dial Control	Increases number of inches when turned in a clockwise direction Decreases number of inches when turned in a counter-clockwise direction	Increases number of centimeters when turned in a clockwise direction Decreases number of centimeters when turned in a counter-clockwise direction
Single arrow	Increases/decreases inches by 1.0 in	Increases/decreases cm by 1.0 cm
Double arrow	Increases/decreases inches by 10.0	Increases/decreases cm by 10.0

3. Accept or reject the value in the **Height** dialog box.
- The **Done** button accepts the selection.

- The **Cancel** button discards the selection, closes the dialog box, and returns to the **Demographics** tab.

For additional information, refer to “Simultaneous Patient Demographic Tab Editing” on page 5-18.

Gender Field

The **Gender** field is used to enter the gender of a patient. A patient's gender can be entered at the bedside monitor or the Panorama Central Station. Information entered at either the bedside, or at the central station, is automatically transmitted bi-directionally between the devices.

NOTE: If the central station is communicating with an EMR system via the Panorama Gateway, this field may auto-populate once the “Patient Key” has been correctly entered.

Select the **Gender** button until the desired gender selection is displayed.

Weight Field

The **Weight** field is used to enter the weight of a patient. A patient's weight can be entered at the bedside monitor or the Panorama Central Station. Information entered at either the bedside, or at the central station, is automatically transmitted bi-directionally between the devices.

For additional information regarding the Weight dialog box, refer to the “Weight Dial Dialog” on page 2-19.

1. From the Demographics tab, select the Weight field. The Weight dialog box (shown in FIGURE 5-5 and FIGURE 5-6) is displayed.

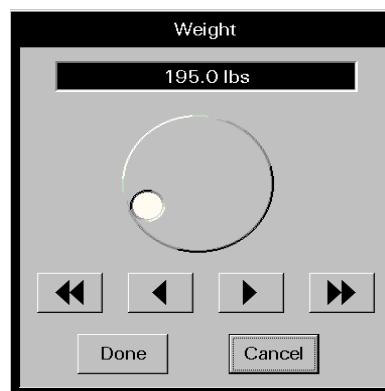

FIGURE 5-5 Weight Dialog Box
(Passport products, all
patient sizes)

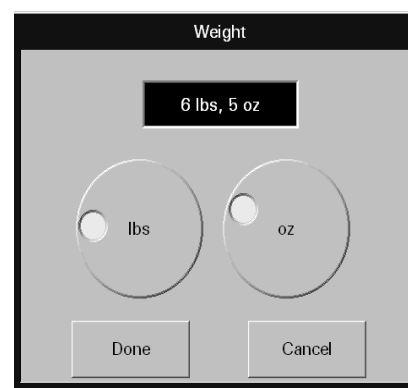

FIGURE 5-6 Weight Dialog Box
(Spectrum products,
Neonate patient size)

2. Rotate the dial control or use the arrow buttons to select a value in the **Weight** dialog box. Refer to the following value ranges.

3. Rotate the dial control or use the arrow buttons to select a value in the **Weight** dialog box. Refer to the following value ranges.

TABLE 5-1 Spectrum, V Series (Adult and Pediatric patient size)

CONTROLS	POUNDS (lbs)	KILOGRAMS (kgs)
Range	1 lb to 1100 lbs	1 kg to 500 kg
Pound/Kilogram Dial Control	Increases number of pounds when turned in a clockwise direction Decreases number of pounds when turned in a counter-clockwise direction	Increases number of kilograms when turned in a clockwise direction Decreases number of kilograms when turned in a counter-clockwise direction
Single arrow	Increases/decreases by 1 lb each time button is selected	Increases/decreases by 1 kg each time button is selected
Double arrow	Increases/decreases by 10 lbs each time button is selected	Increases/decreases by 10 kgs each time button is selected

TABLE 5-2 Spectrum, V Series (Neonate patient size)

CONTROLS	POUNDS (lbs)	KILOGRAMS (kgs)
Range	Refer to TABLE 5-1	10 kg to 10000 kg
Single arrow	Refer to TABLE 5-1	Increases/decreases by 10 kgs each time button is selected
Double arrow	Refer to TABLE 5-1	Increases/decreases by 100 kgs each time button is selected

TABLE 5-3 Spectrum, V Series (Neonate patient size)

CONTROLS	POUNDS (lbs)	KILOGRAMS (kgs)
Range	0 lb to 22 lbs 0 oz to 15 oz	Refer to TABLE 5-2 Refer to TABLE 5-2
Pound Dial Control	Increases number of pounds when turned in a clockwise direction Decreases number of pounds when turned in a counter-clockwise direction	Refer to TABLE 5-2
Ounces Dial Control	Increases number of ounces when turned in a clockwise direction Decreases number of ounces when turned in a counter-clockwise direction	Refer to TABLE 5-2

TABLE 5-4 Passport products (All patient sizes) and Telepack (Adult patient size)

CONTROLS	POUNDS (lbs)	KILOGRAMS (kgs)
Range	0.1 to 1100.0 lbs	0.1 to 500.0 kg
Pound/Kilogram Dial Control	Increases number of pounds when turned in a clockwise direction Decreases number of pounds when turned in a counter-clockwise direction	Increases number of kilograms when turned in a clockwise direction Decreases number of kilograms when turned in a counter-clockwise direction

TABLE 5-4 Passport products (All patient sizes) and Telepack (Adult patient size)
(Continued)

CONTROLS	POUNDS (lbs)	KILOGRAMS (kgs)
Single arrow	0.1 (Increases/decreases by 0.1 lb each time button is selected until 10.0 lbs is reached)	0.1 (Increases/decreases by 0.1 kg each time button is selected until 10.0 kg is reached)
	0.5 (Increases/decreases by 0.5 lbs each time button is selected once 10.0 lbs is reached)	0.5 (Increases/decreases by 0.5 kgs each time button is selected until 100.0 kgs is reached)
	1.0 (Increases/decreases by 1.0 lbs each time button is selected until 1100.0 lbs is reached)	1.0 (Increases/decreases by 1.0 kgs each time button is selected until 500.0 kgs is reached)
Double arrow	0.1 (Increases/decreases by 1.0 lb each time button is selected until 10.0 is reached)	1.0 (Increases/decreases by 1.0 kg each time button is selected until 10.0 kg is reached)
	5.0 (Increases/decreases by 5.0 lbs each time button is selected once 100.0 lbs is reached)	5.0 (Increases/decreases by 5.0 kgs each time button is selected until 100.0 kgs is reached)
	10.0 (Increases/decreases by 10.0 lbs each time button is selected until 1100.0 lbs is reached)	10.0 (Increases/decreases by 10.0 kgs each time button is selected until 500.0 kgs is reached)

TABLE 5-5 DPM6/7 (All patient sizes)

CONTROLS	POUNDS (lbs)	KILOGRAMS (kgs)
Range	4.5 to 440 lbs	2 to 200 kgs
Pound/Kilogram Dial Control	Increases number of pounds when turned in a clockwise direction	Increases number of kilograms when turned in a clockwise direction
	Decreases number of pounds when turned in a counter-clockwise direction	Decreases number of kilograms when turned in a counter-clockwise direction
Single arrow	0.1 (Increases/decreases by 0.1 lb each time button is selected)	0.1 (Increases/decreases by 0.1 kg each time button is selected)
Double arrow	1.0 (Increases/decreases by 1.0 lb each time button is selected)	1.0 (Increases/decreases by 1.0 kg each time button is selected)

4. Accept or reject the selection made in the **Weight** dialog box.
 - The **Done** button accepts the selection.
 - The **Cancel** button discards the selection, closes the dialog box, and returns to the **Demographics** tab.

For additional information, refer to “Simultaneous Patient Demographic Tab Editing” on page 5-18.

Patient Size Field

The **Patient Size** field is used to identify the size of the patient in the selected patient tile. The options for patient size include Adult, Pediatric and Neonate. The default patient size is Adult.

The value for the **Patient Size** field must be selected at the bedside monitor.

NOTE: **Verify monitoring settings when the Patient Size is changed.**

Date Of Birth Field

The **Date Of Birth** field is used to enter the patient’s date of birth. A patient's date of birth can be entered at the bedside monitor or the Panorama Central Station. Information entered at either the bedside, or at the central station, is automatically transmitted bi-directionally between the devices.

NOTE: **If the central station is communicating with an EMR system via the Panorama Gateway, this field may auto-populate once the “Patient Key” has been correctly entered.**

To enter a date of birth:

1. From the **Demographics** tab, select the **Date Of Birth** field. The **Date Of Birth** dialog box (shown in FIGURE 5-7) is displayed.

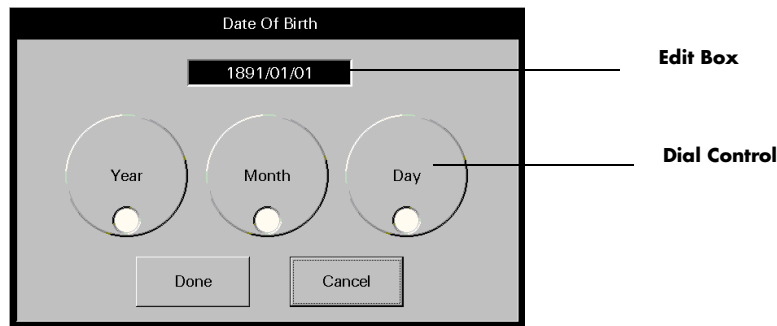

FIGURE 5-7 Date Of Birth Dialog Box

2. Rotate the dial controls to select the month, day and year values. Refer to the following value ranges.

TIME FRAME	RANGE
Month	1 to 12

Day	Dependant on the month selected
Year	1891 to current year

3. Accept or reject the selection made in the **Date Of Birth** dialog box.
 - The **Done** button accepts the selections.
 - The **Cancel** button discards the selections, closes the dialog box and returns to the **Demographics** tab.

For additional information, refer to "Simultaneous Patient Demographic Tab Editing" on page 5-18.

Doctor Field

The **Doctor** field is used to enter the name of the patient's doctor.

1. From the **Demographics** tab, select the **Doctor** field. The keyboard dialog box is displayed.
2. Enter the patient's doctor (maximum of 15 characters).
 - The Backspace (**<==**) button clears a single character in the edit box.
 - The **Caps Lock** button enables/disables the caps lock function. A Caps Lock indicator displays when **Caps Lock** is enabled.
3. Accept or reject the text entered in the keyboard dialog box.
 - The **Close** button discards the changes.
 - The **Enter** button accepts the changes.

Comments Field

The **Comments** field is used to enter notes for the selected patient tile.

1. From the **Demographics** tab, select the **Comments** field. The keyboard dialog box is displayed.
2. Enter a note (maximum of 31 characters).
 - The Backspace (**<==**) button clears a single character in the edit box.
 - The **Caps Lock** button enables/disables the caps lock function. A Caps Lock indicator displays when **Caps Lock** is enabled.
3. Accept or reject the text entered in the keyboard dialog box.
 - The **Close** button discards the changes.
 - The **Enter** button accepts the changes.

5.1.3.1

Pacer Configuration

Select the **Pacer** sidebar button to adjust a patient's **Pacer Enhancement** and **Pacer Filter** settings. The default Pacer Settings are determined in the system setup **Unit Choices** tab. For additional information regarding unit choices, refer to "Unit Choices Tab" on page 9-50 and to "Monitoring a Pacemaker Patient" on page 4-10.

- **Pacer Enhancement** visually marks pacemaker-induced ECG complexes with a colored vertical spike. It can be enabled or disabled in the **Pacer Setting** dialog box (shown in FIGURE 5-8).

NOTE: **A yellow vertical spike will be displayed when a paced beat has been detected and the ECG waveform color is not set to yellow.**

A green vertical spike will be displayed when a paced beat has been detected and the ECG waveform color is set to yellow.

- **Pacer Filtering** adjusts the time period during which pacemaker-induced ECG complexes are filtered for ECG sampling. The preset options for the Pacer Filter are 0 to 80 ms (in increments of 20). The Pacer Filter is selected in the **Pacer Setting** dialog box (shown in FIGURE 5-8).

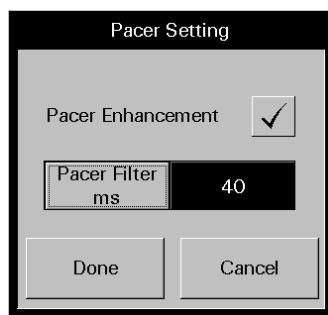

FIGURE 5-8 Pacer Setting Dialog Box

To enter Pacer Settings:

NOTE: **For additional information regarding lead placement procedures for pacemaker patients, refer to “Monitoring a Pacemaker Patient” on page 4-10.**

1. From the **Demographics** tab, select the **Pacer** sidebar button. The **Pacer Setting** dialog box is displayed.
2. Select the **Pacer Enhancement** button to enable or disable this setting for the patient.
 - A checkmark indicates that Pacer Enhancement is enabled.
 - An empty box indicates that Pacer Enhancement is disabled.
3. Select the **Pacer Filter** button until the desired setting is displayed. The selections for **Pacer Filter** range from 0 to 80 ms (in increments of 20).
4. Accept or reject the selections made in the **Pacer Setting** dialog box.
 - The **Done** button accepts the selections.
 - The **Cancel** button discards the selections, closes the dialog box and returns to the **Demographics** tab.

5.1.3.2 Arrhythmia Setup

Select the **Arrhythmia** sidebar button to:

- Enable or disable arrhythmia analysis (for Telepack device only)

- Adjust the system default V-Tach Rate, Asystole Delay, V-Tach Thresholds, and ECG Noise Delay.

NOTE: The Arrhythmia sidebar button is not available at the ViewStation or the WorkStation.

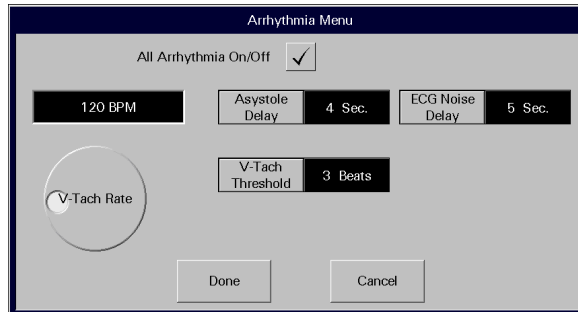

FIGURE 5-9 Arrhythmia Menu Dialog Box (Telepack)

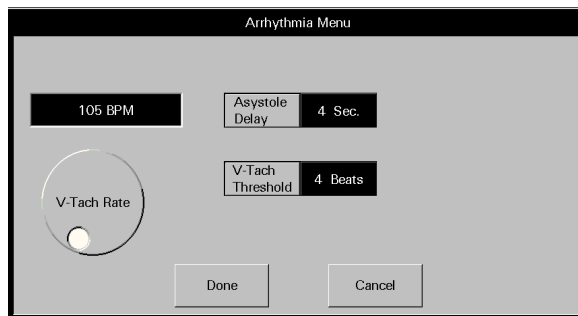

FIGURE 5-10 Arrhythmia Menu Dialog Box (Bedside)

1. Select the All Arrhythmia On/Off check box button (shown in FIGURE 5-9) to enable or disable arrhythmia analysis for the system.
 - A checkmark in the All Arrhythmia On/Off box indicates that arrhythmia analysis is enabled.
 - An empty box indicates that arrhythmia analysis is disabled.

NOTE: Arrhythmia analysis can be enabled for Telepack devices if an Arrhythmia license is available. When arrhythmia analysis is enabled, a license is automatically assigned to a patient.

NOTE: The All Arrhythmia On/Off check box button is only displayed and enabled when using a Telepack device. This check box is not available when using a bedside monitor (shown in FIGURE 5-10). Arrhythmia analysis must be enabled or disabled at the bedside monitor.

2. Rotate the dial control to change the V-Tach Rate. The range available is 100-180 bpm, in 5 bpm increments.
3. Select the **Asystole Delay** button to change the asystole delay time for arrhythmia processing. When using a 3 or 5-wire lead set, the range available is 3-10 seconds. When using a View 12™ card, the range available is 3-8 seconds.
4. Select the **V-Tach Threshold** button to change the V-Tach threshold settings. The range available is 3-15 beats.
5. Select the **ECG Noise Delay** button to change the noise delay setting. The range available is 3-30 seconds.

NOTE: The **ECG Noise Delay** button is only displayed and enabled when using a Telepack device. This button is not available when using a bedside monitor (shown in FIGURE 5-10). ECG Noise Delay must be enabled or disabled at the bedside monitor.

6. Accept or reject the selections made in the dialog box.
 - Select the **Done** button to accept the selections.
 - Select the **Cancel** button to discard the selections, close the dialog box and return to the **Unit Choices** tab.

For additional information, refer to “Simultaneous Patient Demographic Tab Editing” on page 5-18.

5.1.3.3 Configuring Care Groups

Select the **Care Group** sidebar button to assign a specific care group to a patient tile. Care groups allow user-defined categorization of patient tiles. Care groups may represent a care-giver, hospital department, or a special condition. Each care group button has a color indicator that, when assigned to a patient, appears to the right of the **VIEW** button in the patient tile. The system default settings for Care Groups are defined in the System **Care Group** tab. For additional information, refer to the “Care Group Tab” on page 9-9.

The **Care Group** tab and the associated colorized indicators are not available at the ViewStation or the WorkStation.

To select a care group:

1. From the **Demographics** tab, select the **Care Group** sidebar button. The **Care Group** dialog box (shown in FIGURE 5-11) is displayed.

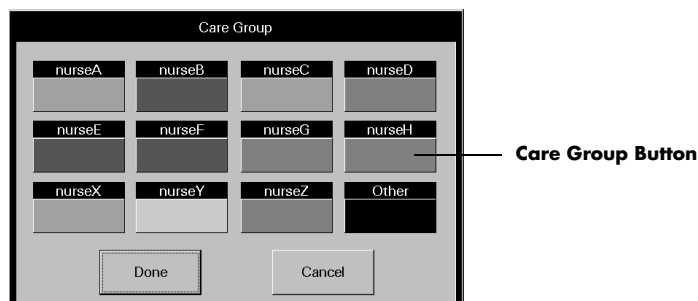

FIGURE 5-11 Care Group Dialog Box

2. Select a **Care Group** button.
3. Accept or reject the **Care Group** selection.
 - The **Done** button accepts the care group selection.
 - The **Cancel** button discards the selection, closes the dialog box, and returns to the **Demographics** tab.

5.1.3.4 Settings (Telepack)

Select the **Settings** sidebar button to establish the type of ECG monitoring filter that will be used for the Telepack device at the central station or the WorkStation. There are two types of monitoring available:

NOTE: The **Settings** sidebar button is not available at the **ViewStation**.

- The **Monitor** filter establishes the frequency response range for non-ST ECG monitoring.
- The **ST** filter establishes the frequency response range for ST diagnostic monitoring.

To enter settings for a Telepack:

1. From the **Demographics** tab, select the **Settings** sidebar button. The **Settings** dialog box (shown in FIGURE 5-12) is displayed.

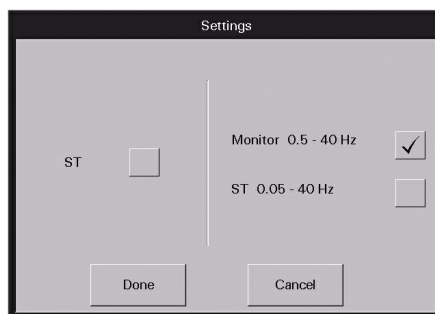

FIGURE 5-12 Settings Dialog Box

2. Select the **ST** (optional) check box to enable or disable ST analysis for the selected patient.
 - A checkmark in the ST box indicates that ST analysis is enabled.
 - An empty box indicates that ST analysis is disabled.
 - When the ST check box is empty, the Monitor filter is automatically enabled.

NOTE: If ST licenses are available, an ST license is automatically assigned to the patient when ST is enabled.

NOTE: When using a 3-lead set, ST is performed on the lead being viewed.

3. Select the **Monitor** or **ST** filter mode.

NOTE: One filter box must always be populated. When a filter mode is selected, the other mode is automatically disabled.

- A checkmark in the Monitor filter box indicates that the Monitor filter is enabled and ST analysis is disabled.

- A checkmark in the ST filter box indicates that the ST analysis is enabled and the Monitor filter is disabled.
4. Accept or reject the selections.
 - The **Done** button accepts the selections.
 - The **Cancel** button discards the selections, closes the dialog box and returns to the **Demographics** tab.

5.1.3.5 Retrieving Discharged Patients

Select the **Retrieve Discharged Pt.** sidebar button to retrieve a patient from the discharge list. A patient is only added to the discharge list if at least two of the three demographic fields (First Name, Last Name, ID) were previously entered.

NOTE: **The Retrieve Discharged Pt. sidebar button is not available at the ViewStation or the WorkStation.**

The **Retrieve Discharged Patient Setting** view (shown in FIGURE 5-13) provides a list of the discharged patients that can be retrieved. The list has four columns labeled First Name, Last Name, ID, and Discharge Time. Each row in the list contains at least two of the three demographic indicators and the discharge time for a patient. The list displays the 15 most recently discharged patients. When the next patient is added to the list, the oldest patient data on the list is removed and permanently deleted from the system.

- A discharged patient can be retrieved into a patient tile that is not actively monitoring a patient.
- A discharged patient can be retrieved into any patient tile that has an assigned device.
- A discharged patient can be retrieved into a tile assigned a different monitoring device than was previously assigned to that patient.

Retrieving a discharged patient into a patient tile:

- Allows for active monitoring of the retrieved patient
- Restores Trend, Event, and Disclosure records
- Restores Wave Gain and Trend Display settings
- Restores patient's alarm limit settings to reflect those at the bedside monitor
- Does not restore patient's alarm limit settings when using a Telepack device

NOTE: **If the destination device and the source device are different, the source devices sensor display setup will be reset to the system default settings of the destination device.**

To retrieve a discharged patient:

1. Select the **Retrieve Discharged Pt.** sidebar button in the **Demographics** tab. The **Retrieve Discharged Patient Setting** view (shown in FIGURE 5-13) is displayed.

Demographics	Transfer	Discharge	Display	Standby	Wave Gain	Print Setup	Pacer
Retrieve Discharged Patient Setting							Arrhythmia
First Name	Last Name	ID	Discharge Time				Care Group
HAROLD	SMITH		12:49PM 2004/12/1				Retrieve Discharged Pt.
							Normal Screen
<input type="button" value="Done"/> <input type="button" value="Cancel"/>							

FIGURE 5-13 Retrieve Discharged Patient Setting View

2. Select the patient to be retrieved.
3. Accept or reject the patient retrieval in the **Retrieve Discharged Patient Setting** view.
 - The **Done** button accepts the patient retrieval.
 - The **Cancel** button discards the patient retrieval, closes the view, and returns to the **Demographics** tab.

5.1.3.6 Simultaneous Patient Demographic Tab Editing

Bedside Menu

If using a bedside device with the Panorama Central Station, patient demographic changes cannot be made at the bedside monitor, central station, and the WorkStation simultaneously. The bedside device will take precedence, followed by the central station, ending with the WorkStation. When an attempt is made to make changes simultaneously, the message **These settings are currently being edited remotely.** will be displayed at the central station or WorkStation, depending on where the change was initiated. If there are multiple WorkStations on the network, the first WorkStation that initiates the change will take precedence over any other WorkStation attempting to implement the same change.

These are the scenarios in which this message will be displayed:

Patient Menu (Passport 2, Passport V, Spectrum, Spectrum OR, DPM 6/7, and V Series only)

- The Patient Menu is active at the bedside monitor and then the **Demographics** tab is opened at the central station or the WorkStation
- The **Demographics** tab is active at the central station or WorkStation and then the Patient Menu is opened at the bedside monitor

Arrhythmia Menu (Passport 2, Passport V, Spectrum, Spectrum OR, and V Series only)

- The Arrhythmia Menu is active at the bedside monitor and then the Arrhythmia Menu dialog is opened at the central station
- The Arrhythmia Menu dialog is active at the central station and then the Arrhythmia Menu is opened at the bedside monitor

CO Setup Menu (applies to the Spectrum, Spectrum OR, and V Series only)

- The CO Setup Menu is active at the bedside monitor and then the **Demographics** tab is opened at the central station or the WorkStation
- The **Demographics** tab is active at the central station or the WorkStation and then the CO Setup Menu is opened at the bedside monitor

Hemodynamic Calculations Menu (applies to the Spectrum, Spectrum OR, and V Series only)

- The Hemodynamic Calculations Menu is active at the bedside monitor and then the **Demographics** tab is opened at the central station or the WorkStation
- The **Demographics** tab is active at the central station or the WorkStation and then the Hemodynamic Calculations Menu is opened at the bedside monitor

Drug Calculator (applies to the Spectrum, Spectrum OR, and V Series only)

- The Drug Calculator is active at the bedside monitor and then the **Demographics** tab is opened at the central station or the WorkStation
- The **Demographics** tab is active at the central station or the WorkStation and then the Drug Calculator is opened at the bedside monitor

Central Station or WorkStation

The message **These settings are currently being edited remotely.** will be displayed at the WorkStation when the WorkStation **Demographics** tab is active and then the **Demographics** tab is opened at the central station. In this scenario, the central station will take precedence, followed by the WorkStation.

This message will also be displayed at the WorkStation when the WorkStation patient **Alarm Limits** or **Alarm Responses** tab is active and then the Alarm Limits or Alarm Responses tab is opened at the central station. In this scenario, the central station will take precedence, followed by the WorkStation.

Acknowledging the Message

To close the **These settings are currently being edited remotely.** message dialog, select the **OK** button. Acknowledging this message will convert the **Demographics** tab at the central station or WorkStation to a read-only state and editing will not be permitted. Once the menu at the bedside device or central station is closed or times out (timeout applies to bedside device only), the **Demographics** tab will become active again and editing can resume.

Unsaved central station or WorkStation changes made in the First Name keyboard dialog, Date Of Birth dialog, Height dialog box, ID keyboard dialog, Last Name keyboard dialog, Weight dialog box, or Arrhythmia Menu (applies to central station only) dialog box will be discarded.

For additional information regarding the bedside monitor menus, refer to the bedside monitor's Operating Instructions:

- Passport 2 (P/N 0070-00-0649-XX)
- Passport V (P/N 0070-00-0704-XX)
- Spectrum (P/N 0070-00-0648-XX)
- Spectrum OR (P/N 0070-00-0670-XX)
- V Series (P/N 0070-00-0727-XX)

NOTE: While the Demographics tab is in a read-only state because the Patient Menu is open at the bedside, the Pacer, Arrhythmia, and Care Group sidebar buttons will be enabled.

5.1.4 Sidebar Buttons

The following sidebar buttons are used to expand the functionality of this tab.

Pacer

This sidebar button was previously described on page 5-12.

Arrhythmia

This sidebar button was previously described on page 5-13.

Care Group

This sidebar button was previously described on page 5-15.

Retrieve Discharged Pt.

This sidebar button was previously described on page 5-17.

Normal Screen

Select the **Normal Screen** sidebar button to return the display to the full screen mode, and close all tabs, message boxes, and dialog boxes.

5.1.5 Troubleshooting

This section lists some of the potential messages and issues that may occur while using the **Demographics** tab.

MESSAGE/ISSUE *	REASON	SOLUTION
Can not admit Patient to this tile. No Device attached to this tile	There is no device assigned to the selected tile.	Select the OK button to close the dialog box. Select a patient tile that has a device attached to it or attach a device to the selected patient tile.
The Arrhythmia sidebar button is disabled.	No equipment is assigned to the patient tile.	Select a different patient tile.
	The selected patient is in the Standby mode.	Remove the selected patient tile from Standby mode.
	Monitoring device is in Communications Lost state.	Restore communication to central station.
	The Arrhythmia Menu at the bedside monitor is active.	Wait for the bedside monitor Arrhythmia Menu to time out or be closed or, use the bedside monitor to make the necessary arrhythmia changes.
The Pacer, Care Group, and the Retrieve Discharged Pt. sidebar buttons are disabled.	The selected patient tile is in Standby mode.	Remove the selected patient tile from Standby mode.
	The message These settings are currently being edited remotely is displayed.	Select the OK button to close the message box and enable the sidebar button.
The filter mode cannot be Monitor when ST is on	Monitor mode cannot be selected while ST is enabled.	Select the OK button to close the dialog box. Turn off ST select the correct filter mode.
Turning on ST will change your ECG filtering to ST mode	ST mode was selected while in Monitor mode.	Select the OK button to close the dialog box. Select the correct filter mode.
Retrieve Discharged Patient Failed: The destination tile is currently occupied.	A patient cannot be retrieved into an occupied tile.	Select the OK button to close the dialog box. Select a vacant patient tile before attempting to retrieve a patient.
No demographic data is displayed at ViewStation or WorkStation for the selected patient tile.	The host central station is in a Central Communications Lost mode.	Resolve the communication error at the host central station.
Patient tile does not contain a care group indicator	If viewing patient tile from the central station, a care group has not been indicated.	Assign the patient tile to a care group.
	Patient tile is being viewed from a ViewStation or a WorkStation, which does not support this feature.	To discern if the patient is assigned to a care group, view the patient tile from the host central station.
These settings are currently being edited remotely.	The Care Group dialog box was closed while the bedside device's Patient Menu is active.	Select the OK button to close the message box and enable the sidebar button.

* Messages are shown in all bold text.

MESSAGE/ISSUE *	REASON	SOLUTION
	The Retrieve Discharged Patient Settings tab was closed while the bedside device's Patient Menu is active.	
	The Arrhythmia Menu dialog box was closed while the bedside device's Patient Menu is active.	
	The Pacer Settings dialog box was closed while the bedside device's Patient Menu is active.	
	The CO Setup Menu is opened at the bedside monitor while the Demographics tab is active at the central station or WorkStation.	
	The Demographics tab is active at the central station or WorkStation and then the CO Setup Menu is opened at the bedside monitor.	
	The Hemodynamic Calculations Menu is opened at the bedside monitor while the Demographics tab is active at the central station or WorkStation.	
	The Demographics tab is active at the central station or WorkStation and then the Hemodynamic Calculations Menu is opened at the bedside monitor.	
The Arrhythmia Menu at the central station was closed and all changes were discarded.	The Arrhythmia Menu was opened at the bedside monitor.	Use the bedside monitor to make the arrhythmia changes. Close the Arrhythmia Menu at the bedside monitor and then reenter the Arrhythmia Menu dialog box at the central station or WorkStation.

* Messages are shown in all bold text.

5.2 Transfer Tab

The **Transfer** tab (shown in FIGURE 5-14) enables the transfer of a patient's data from one device to another. Two types of transfers can be performed through the **Transfer** tab:

- Room To Room Transfer Without Device
- Central To Central Transfer Without Device

The Transfer tab is not available at the ViewStation or the WorkStation. Patient transfers can only be performed at a host central station.

5.2.1 Accessing the Transfer Tab

1. From the menu bar, select the **Patient Setup** menu button. The tabs associated with patient setup are displayed.
2. Choose a patient tile by selecting its digital tile or waveform area.
3. Select the **Transfer** tab. The **Transfer** tab is enabled.



FIGURE 5-14 Transfer Tab

5.2.2 Room To Room Transfer Without Device

A **Room To Room Transfer Without Device** is used to transfer patient data stored at the Panorama Central Station from one patient tile (the source) to another (the destination). Historical patient data is preserved upon successful completion of the transfer, with the exception of historical paging data. If Paging is enabled at the central station, a successful Room to Room Transfer Without Device shall delete any rows in the Failed Pages tab for the transferred patient.

For information regarding changes that occur at the destination tile when the transfer is complete, refer to "Effects of the Transfer" on page 5-24.

The **Room To Room Without Device** button is enabled under the following conditions:

- When a patient tile actively monitoring a patient is selected as the source
- When a patient tile actively monitoring a patient, but placed in **Standby** mode, is selected as the source

- When a patient tile actively monitoring a patient, but experiencing a **Communications Lost** event, is selected as the source

To perform a **Room To Room Transfer Without Device**:

1. Select the patient tile to be transferred. Choose a patient tile by selecting its digital data or waveform area.
2. Select the **Room To Room Without Device** button. The following prompt is displayed: **Please touch tile to which you wish to transfer the patient.**
3. Select a destination tile that has a device assigned. The message **All of the patient's data will be deleted in the destination tile. Do you still want to continue with the transfer?** is displayed.

- The **Yes** button initiates the transfer. As the transfer proceeds, there is no indication in the **Transfer** tab.

If the destination tile is in **Standby** mode when the transfer is complete, the digital data labels and the demographic information will be displayed in the patient tile, but the digital data values and waveforms will not be displayed until the device is returned to the normal monitoring mode.

If the destination tile is in a **Communications Lost** state when the transfer is complete, the tile is blank and all buttons on the **Transfer** tab are unavailable. The tile remains blank until communication has been re-established.

When the transfer is complete, the source tile is blank and the destination tile remains blank until the patient is connected to the monitoring device.

If the destination tile is in a **Waiting for Patient** state when the transfer is complete, the tile will display the Waiting for Patient message until the destination device is activated.

NOTE: When the transfer is complete, a **Room Transfer event and an Admit event are recorded in the Event database.**

NOTE: After a **Room To Room Transfer Without Device**, the patient's **Paging settings will remain the same.**

- The **No** button terminates the transfer and returns to the **Transfer** tab.

NOTE: When transferring patients out of tiles that are hosted by **Passport V or DPM 6/7 monitors**, a new patient will be automatically admitted to the **Panorama** for that source tile following the completion of the transfer. The new patient will immediately be in an active monitoring state and the **Panorama** will reflect the data being gathered at the bedside.

5.2.2.1 Effects of the Transfer

The following is a list of the changes that occur at the destination tile when a **Room To Room Transfer Without Device** is complete:

Display

- The transferred patient's parameter display changes only when the destination device does not support the source device parameters.

- The transferred patient's parameter display waveform 1 changes to ECG II when the destination device does not support the source device's waveform 1 parameter and has a 5 lead ECG cable.
- The transferred patient's parameter display waveform 1 changes to the active lead when the destination device does not support the source device's waveform 1 parameter and has a 3 lead ECG cable.
- The transferred patient's parameter display waveform 2 changes to OFF when the destination device does not support the source device's waveform 2 parameter.
- If the source device is a bedside monitor, the units for CO₂ and temperature will change to that of the destination device.
- If the destination device and the source device are different, the source device's sensor display setup will be reset to the system default settings of the destination device.
- The care group is set to the system default at the destination device.

Demographics

- For all transfers to a bedside monitor, the bed ID and patient size change to those of the destination device. The remaining demographic data only changes when the destination device has experienced a **Communications Lost** event. When communication is re-established, the remaining demographic data is taken from the destination device.
- For all transfers to a Panorama Telepack, the bed ID is cleared and the patient size changes to Adult (the Telepack default). The remaining demographic data is preserved.

Alarms

- The transferred patient's Alarm Limits, Alarm Delay, and ST Alarm Delay change to those of the destination device.
- All alarms for the transferred patient become enabled, discontinuing all Alarm Suspended settings.

5.2.3 Central To Central Transfer Without Device

A **Central To Central Transfer Without Device** is used to transfer patient data stored at one Panorama Central Station to a different Panorama Central Station. Historical patient data is preserved upon successful completion of the transfer, with the exception of historical failed page data. If Paging is enabled at the central station, a successful Central To Central Transfer Without Device will delete any rows in the **Failed Pages** tab for the transferred patient.

The **Central To Central Without Device** button is enabled under the following conditions:

- When a patient tile actively monitoring a patient is selected as the source
- When a patient tile actively monitoring a patient, but placed in **Standby** mode, is selected as the source
- When a patient tile actively monitoring a patient, but experiencing a **Communications Lost** event, is selected as the source

For information regarding changes that occur at the destination tile when the transfer is complete, refer to "Effects of the Transfer" on page 5-28.

5.2.3.1 Source Panorama

1. A prerequisite for the transfer is that certain patient demographic information must exist. In the patient tile to be transferred, ensure that the appropriate information has been provided in at least two of the three demographic fields (Last Name, First Name, and ID).
2. Ensure that the device name for the Source Panorama is properly entered into the Equipment List at the Destination Panorama, as described in the "Equipment Setup Tab" on page 9-33.
3. Ensure that the device name for the Destination Panorama is properly entered into the Equipment List at the Source Panorama, as described in the "Equipment Setup Tab" on page 9-33.
4. Select the patient tile to be transferred. Choose a patient tile by selecting its digital data or waveform area.
5. Select the **Central To Central Without Device** button. The **Select Destination Panorama** list box (shown in FIGURE 5-15) is displayed.

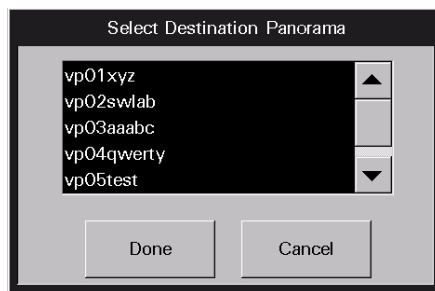

FIGURE 5-15 Select Destination Panorama List Box

6. Select the Destination Panorama device from the **Select Destination Panorama** list box.
 - Select the **Done** button. The message **Are you sure you want to transfer the selected patient?** is displayed with the following two choices:
 - Select the **Yes** button to initiate the first part of the transfer process and return to the **Transfer** tab. In the **Transfer** tab, the message **Central Transfer in progress** is displayed next to the **Central To Central Without Device** button, which has been disabled.
 - Select the **No** button to terminate the transfer and return to the **Transfer** tab.
 - Select the **Cancel** button to terminate the transfer and return to the **Transfer** tab.

If the transfer process is initiated, it will continue as described in following section, "Destination Panorama". As the transfer process continues, the procedure will refer to messages and a progress bar that will display at the Source Panorama.

5.2.3.2 Destination Panorama

When a **Central To Central Transfer Without Device** has been requested from another Panorama Central Station, the message **Transfer In Request from [the Source Panorama name]. Accept/Reject in Transfer Dialog.** is displayed in the system status line of the Destination Panorama.

1. At the Destination Panorama, select a tile that has a monitoring device attached.
2. From the menu bar, select the **Patient Setup** menu button. The tabs associated with Patient Setup are displayed.
3. Select the **Transfer** tab. The **Transfer** tab (shown in FIGURE 5-14) is displayed.
4. Select the **Accept/Reject** button on the **Transfer** tab. The **Transferred In Patient** view (shown in FIGURE 5-16) is displayed.

Panorama	First Name	Last Name	ID
VPO2SWLAB	FIRST	LAST	Q100

FIGURE 5-16 Transferred In Patient View

- Select the **Accept** button. The message **All of the patient's data will be deleted in the destination tile. Do you still want to continue with the transfer?** is displayed with the following two choices:
 - The **Yes** button begins the transfer and returns to the **Transfer** tab. While the transfer is in progress, the following conditions exist:

In the **Transfer** tab of the Destination Panorama, the message **Incoming Transfer In progress** is displayed next to the **Accept/Reject Patient** button, which has been disabled. A progress bar displays below the **Accept/Reject Patient** button.

In the **Transfer** tab of the Source Panorama, a progress bar displays below the **Central To Central Without Device** button.

If the destination tile is in **Standby** mode when the transfer is complete, the digital data displays but the waveform does not display. Upon returning to normal monitoring mode, the waveform is displayed.

If the destination tile is in a **Communications Lost** state when the transfer is complete, the tile is blank and all buttons on the **Transfer** tab are unavailable. The tile remains blank until communication has been re-established.

If the destination tile is in a **Waiting for Patient** state when the transfer is complete, the tile will display the Waiting for Patient message until the destination device is activated.

When the transfer is complete, the message **Transfer In Complete** is displayed on the system status line of the Destination Panorama and the message **Transfer Out Complete** is displayed on the system status line of the Source Panorama.

When the transfer is complete, the source tile is blank and the destination tile remains blank until the patient is connected to the monitoring device.

NOTE: When the transfer is complete, a **Central Transfer event** and an **Admit event** are recorded in the event database.

- The **No** button returns to the **Transfer** tab without terminating the transfer.
- The **Reject** button terminates the transfer and returns to the **Transfer** tab. The message **Transfer Out rejected by [the Destination Panorama name] Central.** is displayed in the system status line of the Source Panorama.
- The **Cancel** button returns to the **Transfer** tab without terminating the transfer.

NOTE: When transferring patients out of tiles that are hosted by **Passport V** or **DPM 6/7** monitors, a new patient will be automatically admitted to the Panorama for that source tile following the completion of the transfer. The new patient will immediately be in an active monitoring state and the Panorama will reflect the data being gathered at the bedside.

NOTE: A **Central To Central Transfer Without Device** can fail if the network connection is lost or if either Panorama loses power during the process. If a **Central To Central Transfer Without Device** fails while in progress, the patient information from the source tile is saved to a **Failed Transfer List** at the Source Panorama.

The **Failed Transfer List** stores a maximum of five failed transfers. If the maximum is reached, the **Central To Central Transfer Without Device** button is disabled. A **Central To Central Transfer Without Device** cannot be initiated until at least one of the failed transfers is either recovered, deleted or transferred using one of the sidebar buttons in the **Transfer** tab. For additional information, refer to “**Sidebar Buttons**” on page 5-29.

5.2.3.3 Effects of the Transfer

The following is a list of the changes that occur at the destination tile when a **Central To Central Transfer Without Device** is complete:

Display

- The transferred patient's parameter display changes, but only when the destination device does not support the source device parameters.
- The transferred patient's parameter display waveform 1 changes to ECG II when the destination device does not support the source device's waveform 1 parameter and has a 5-lead ECG cable.
- The transferred patient's parameter display waveform 1 changes to the active lead when the destination device does not support the source device's waveform 1 parameter and has a 3-lead ECG cable.
- The transferred patient's parameter display waveform 2 changes to OFF when the destination device does not support the source device's waveform 2 parameter.

- If the source device is a bedside monitor, the units for CO₂ and temperature will change to that of the destination device.
- If the destination device and the source device are different, the source devices sensor display setup will be reset to the system default settings of the destination device.
- The care group is set to the system default at the destination device.

Demographics

- For all transfers to a bedside monitor, the bed ID and patient size change to those of the destination device. The remaining demographic data only changes when the destination device has experienced a **Communications Lost** event. When communication is re-established, the remaining demographic data is taken from the destination device.
- For all transfers to a Panorama Telepack, the bed ID is cleared and the patient size changes to Adult (the Telepack default). The remaining demographic data is preserved.

Alarms

- The transferred patient's Alarm Limits, Alarm Delay and ST Alarm Delay change to those of the destination device.

5.2.4

Sidebar Buttons

The following sidebar buttons are used to expand the functionality of this tab.

Recover Patient

When a **Central To Central Transfer Without Device** has failed, the **Recover Patient** sidebar button is used to retrieve patient information that was collected in the Failed Transfer List.

The list box in the **Recover Failed Transfer Patients** view (shown in FIGURE 5-17) has three columns labeled First Name, Last Name and ID. The list contains at least two of these three demographic indicators.

1. Select a destination tile on the Source Panorama to which the patient information is to be recovered. Ensure that the destination tile has a device assigned.
2. Select the **Recover Patient** sidebar button. The **Recover Failed Transfer Patients** view is displayed.

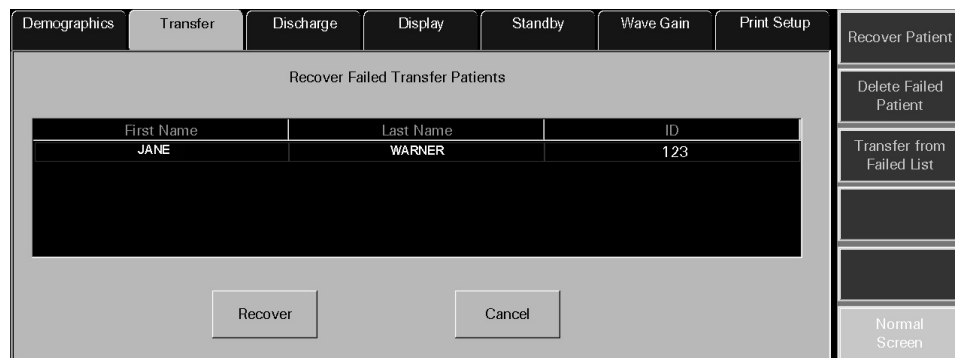

FIGURE 5-17 Recover Failed Transfer Patients View

3. Select the patient whose information is to be recovered from the list.
 - Select the **Recover** button. The message **All of the patient's data will be deleted in the destination tile. Do you still want to continue with the transfer?** is displayed with the following two choices:
 - The **Yes** button deletes all of the patient's data that may have been previously stored for the destination tile, returns to the **Transfer** tab and the recovery process begins. When the recovery is complete, the patient information is removed from the Failed Transfer List and the destination tile displays the recovered patient information, except in the following situations:
 - If the destination tile is in **Standby** mode when the recovery is complete, the digital data displays but the waveform does not display. Upon returning to normal monitoring mode, the waveform is displayed.
 - If the destination tile is in a **Communications Lost** state when the recovery is complete, the tile is blank and all buttons on the **Transfer** tab are unavailable. The tile remains blank until communication has been re-established. Once communication is re-established, the destination tile will populate with the demographic information available at the destination bedside monitor.
 - The **No** button terminates the recovery process and returns to the **Transfer** tab.
 - Select the **Cancel** button to return to the **Transfer** tab.

Delete Failed Patient

When the Failed Transfer List has reached its maximum of five failed transfers, the **Delete Failed Patient** sidebar button is used to delete patient information from the list.

The list box in the **Delete Failed Transfer Patients** view (shown in FIGURE 5-18) has three columns labeled First Name, Last Name and ID. The list will contain at least two of these three demographic indicators.

1. Select the **Delete Failed Patient** sidebar button. The **Delete Failed Transfer Patients** view is displayed.

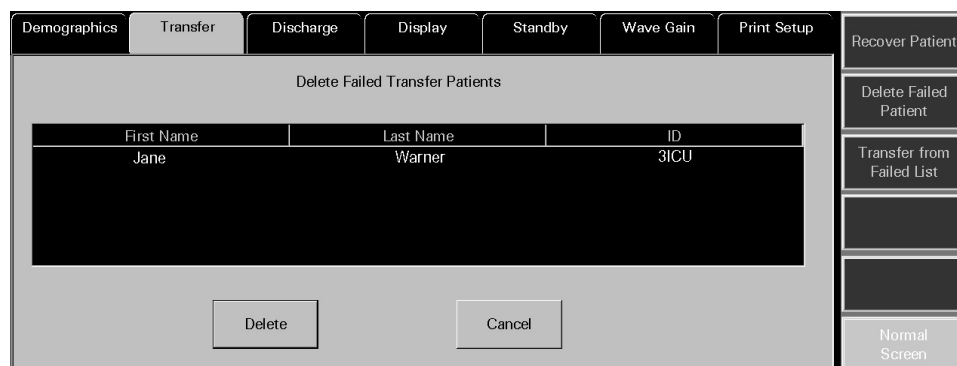

FIGURE 5-18 Delete Failed Transfer Patients View

2. Select the patient whose information is to be deleted from the list.
 - Select the **Delete** button. The message **Are you sure that you want to delete this failed transfer?** is displayed with the following choices:

NOTE: If the **Yes** button is selected, all of the patient's data will be unrecoverable. Once the patient is deleted from the list, the patient will not be displayed in the Retrieve Discharged List and therefore, cannot be retrieved.

- Selecting the **Yes** button when the Delete Failed Transfer Patient list is empty deletes all of the selected patients data from the Failed Transfer List and then returns to the **Transfer** tab.
- Selecting the **Yes** button when the Delete Failed Transfer Patient list contains more patients will delete all of the selected patients data from the Failed Transfer List and then keep the Delete Failed Transfer Patients list open.
- When the deletion is complete, the patient information is removed from the Delete Failed Transfer Patient list.
- The **No** button terminates the deletion process and returns to the **Transfer** tab.
- The **Cancel** button returns to the **Transfer** tab.

Transfer From Failed List

The **Transfer From Failed List** sidebar button is used to resume a transfer of patient information that was collected in the Failed Transfer List when a **Central To Central Transfer Without Device** failed. The patient data and settings collected in the Failed Transfer List at one Panorama Central Station are transferred to a room in an area monitored by a different Panorama Central Station. Historical patient data is preserved upon successful completion of the transfer.

The list box in the **Transfer Failed Transfer Patients** view (shown in FIGURE 5-19) has three columns labeled First Name, Last Name and ID. The list contains at least two of these three demographic indicators.

1. Select the **Transfer From Failed List** sidebar button. The **Transfer Failed Transfer Patients** view is displayed.

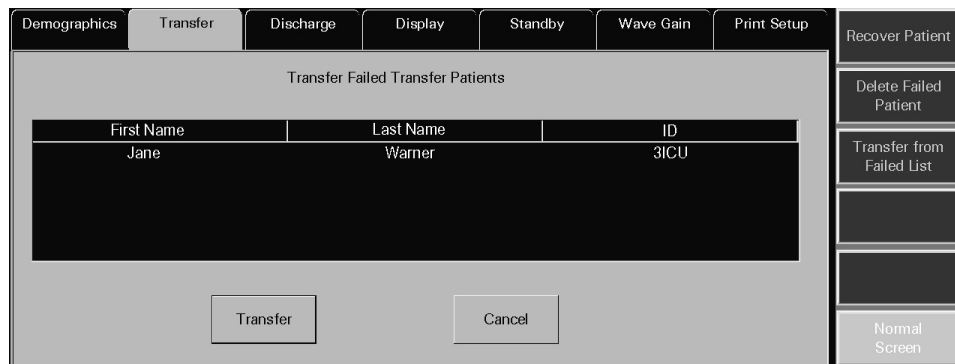

FIGURE 5-19 Transfer Failed Transfer Patients View

2. Select the patient whose information is to be transferred from the list.
 - The **Transfer** button displays the Select Destination Panorama list box (shown in FIGURE 5-15) displays. Go to step 6 on page 5-26 and continue the transfer process. When a Destination Panorama is selected, the patient information is removed from the Failed Transfer List.

- The **Cancel** button returns to the **Transfer** tab.

Normal Screen

Select the **Normal Screen** sidebar button to return the display to the full screen mode, and close all tabs, message boxes, and dialog boxes.

5.2.5 Troubleshooting

This section lists some of the potential messages and issues that may occur while using the Transfer tab.

Room To Room Transfer

MESSAGE/ISSUE *	REASON	SOLUTION
Patient tile shown with demographic text and digital data labels, but no waveforms and/or digital values are displayed	The selected tile is still in the Bedside and Panorama Standby mode.	Return the monitoring device to its active monitoring state.
The Room To Room Without Device button is disabled.	The Transfer Failed list is full. The list stores a maximum of 5 failed transfers. A patient tile is not selected on the Main Screen. The selected patient tile has a device assigned but is not monitoring a patient. The selected patient tile has no device assigned.	Delete a patient from this list before transferring. Select the patient tile that is intended to be transferred. Select the patient tile that is intended to be transferred. Select the patient tile that is intended to be transferred.
The Failed Patient List is full. Delete a patient from this list before transferring.	The Transfer Failed list is full. The list stores a maximum of 5 failed transfers.	Delete a patient from this list before transferring.
Unable to select a patient tile on the Panorama Display.	A message box is currently being displayed.	Close the message box or wait for it to time out and close automatically.
The destination and source tile cannot be the same. Please try again.	The original source tile was selected when the prompt "Please touch tile to which you wish to transfer the patient." was displayed.	Restart the transfer process and select an appropriate destination tile when prompted. Do not select the original source tile.
The destination tile must have a device assigned to perform the transfer.	The destination tile does not have a device assigned.	Restart the transfer process and select a destination tile that has a device assigned when prompted.
This Tab is in use by another display. Can not be updated from more than one display at the same time.	An attempt was made to open the Transfer tab on one display when it is already open on the other display.	Select the OK button and use the open Transfer tab.
At the destination tile, the digital data is displayed but the waveform is not displayed	The destination tile was in Standby mode when the transfer completed.	Return to normal monitoring mode.

* Messages are shown in all bold text.

Room To Room Transfer (Continued)

MESSAGE/ISSUE *	REASON	SOLUTION
Room to Room Transfer Without device failed	Another tab was selected during the transfer process.	Restart the transfer process and do not select another tab until the transfer process is complete.
The destination tile is blank and all buttons on the Transfer tab are unavailable.	The destination tile was in a Communications Lost state when the transfer completed.	Re-establish communication.
Unable to perform operation on tile: Central to Central Transfer Out in progress	A Central to Central transfer Out has been initiated at the source central station but not been accepted or rejected at the destination central station for the selected tile.	Accept or reject the transfer at the destination central station, and then initiate Room to Room Transfer again.
	A Central to Central transfer Out is in process at the source central station	Accept or reject the transfer at the destination central station, and then initiate Room to Room Transfer again.
Unable to perform operation on tile: Central to Central Transfer In in progress.	A Central to Central transfer In is in progress for the selected tile, which is actively monitoring a patient, and a Room to Room transfer is attempted into the same selected tile.	Wait until the Central to Central transfer In is complete, then attempt transfer again.
	A Central to Central transfer In has been initiated at the source central station but not accepted or rejected at the destination central station for the selected tile, and another Central to Central transfer is attempted for another patient into the same selected tile.	Wait until the Central to Central transfer In is complete, then attempt transfer again.
	The Central to Central Without Device button in the Transfer Tab was selected when a Central to Central transfer In is in progress for the selected tile, and the selected tile is actively monitoring a patient.	Wait until the Central to Central transfer In is complete, then attempt transfer again.
	A Central to Central transfer In is in progress for the selected tile, which has an assigned device that is not actively monitoring a patient, and a Room to Room transfer for another patient is initiated into the same selected tile.	Wait until the Central to Central transfer In is complete, then attempt transfer again.
The Waiting for Patient message is displayed in the heart rate digital tile.	The destination device has not been activated.	Activate the destination device.

* Messages are shown in all bold text.

Central To Central Transfer

MESSAGE/ISSUE *	REASON	SOLUTION
The Central To Central Without Device button is disabled.	<p>The Transfer Failed list is full. The list stores a maximum of 5 failed transfers.</p> <p>A patient tile is not selected on the Main Screen.</p> <p>The selected patient tile has a device assigned but is not monitoring a patient.</p> <p>The selected patient tile has no device assigned.</p>	<p>Delete a patient from this list before attempting to transfer.</p> <p>Select the patient tile that is intended to be transferred.</p> <p>Select the patient tile that is intended to be transferred.</p> <p>Select the patient tile that is intended to be transferred.</p>
The Failed Patient List is full. Delete a patient from this list before transferring.	The Transfer Failed list is full. The list stores a maximum of 5 failed transfers.	Delete a patient from this list before transferring.
Available central list is empty.	There are no central stations found on the network.	Contact the System Administrator for assistance.
The patient cannot be transferred because at least two of the following fields: First Name, Last Name or ID has not been entered.	The appropriate information has not been entered into at least two of the three demographic fields (Last Name, First Name and ID) on the Demographics tab.	Enter the appropriate information into at least two of the three demographic fields (Last Name, First Name, and ID) on the Demographics tab.
Selecting the Done button on the Select Destination Panorama list box terminates the transfer and returns to the Transfer tab.	A Destination Panorama device was not selected from the list box before selecting the Done button.	Repeat the transfer procedure and ensure that a Destination Panorama device is selected from the Select Destination Panorama list box before selecting the Done button.
Transfer Out Rejected. Timeout at [the Destination Panorama name] Central.	The Accept/Reject Patient button on the Transfer tab at the Destination Panorama was not selected within 10 minutes of initiating the Central To Central Transfer Without Device.	Repeat the transfer procedure and ensure that the Accept/Reject Patient button on the Transfer tab at the Destination Panorama is selected within 10 minutes of initiating the transfer.
Transfer In Request from [the Source Panorama name] cancelled due to user timeout.	At the Destination Panorama, either the Accept or Reject button on the Transferred In Patient view of the Transfer tab was not selected within 10 minutes of initiating the Central To Central Transfer Without Device.	Repeat the transfer procedure and ensure that either the Accept or Reject button on the Transferred In Patient view of the Transfer tab is selected within 10 minutes of initiating the Central To Central Transfer Without Device.
Transfer In Request from [the Source Panorama name] rejected: Transfer In already in progress	A transfer in was initiated and accepted at the destination central station, and then another transfer in to the same destination central station is attempted.	Wait until the first transfer in is complete, then repeat transfer procedure.
The Accept/Reject Patient button is disabled.	A transfer request has not been received from any other Panorama Central Station.	This does not require a solution.

* Messages are shown in all bold text.

Central To Central Transfer (Continued)

MESSAGE/ISSUE *	REASON	SOLUTION
The destination tile must have a device assigned to perform the transfer.	The destination tile does not have a device assigned.	Select the OK button on the message box and then select a destination tile that has a device assigned.
Please touch tile to which you wish to transfer the patient.	A destination tile has not been selected at the Destination Panorama.	Select a destination tile that has a device assigned.
Failed Transfer Out: System Error. (Source Panorama)	The selected Destination Panorama device was not properly defined in the equipment list. There is an interruption in the network connection between the Source and Destination Panoramas.	Repeat the transfer procedure and ensure that the desired Destination Panorama device is properly defined in the Equipment List. Determine the cause of the interruption and correct.
Failed Transfer In: System Error. (Destination Panorama)	The selected Destination Panorama device was not properly defined in the equipment list. There is an interruption in the network connection between the Source and Destination Panoramas.	Repeat the transfer procedure and ensure that the desired Destination Panorama device is properly defined in the Equipment List. Determine the cause of the interruption and rectify.
This Tab is in use by another display. Can not be updated from more than one display at the same time.	An attempt was made to open the Transfer tab on one display when it is already open on the other display.	Select the OK button and use the open the Transfer tab.
At the destination tile, the digital data is displayed but the waveform is not displayed	The destination tile was in Standby mode when the transfer completed.	Return to normal monitoring mode.
ID number truncated.	More than 10 characters were entered in the ID field at the WMTS 608 bedside device.	Do not enter more than 10 characters when using a WMTS 608 bedside device because only 10 characters will be transferred to the central station.
The destination tile is blank and all buttons on the Transfer tab are unavailable.	The destination tile was in a Communications Lost state when the transfer completed.	Re-establish communication.
Waiting for Patient message is displayed in the heart rate digital tile.	The destination device has not been activated.	Activate the destination device.
Available monitor list is empty.	The Central To Central Transfer Without Device button was selected but there are no other Panorama devices on the network.	Try and transfer to another central station on a different network. If unsuccessful, contact the System Administrator for assistance.

* Messages are shown in all bold text.

Recovering Failed Transfer Patient Data

MESSAGE/ISSUE *	REASON	SOLUTION
The Recover Failed Transfer sidebar button is disabled.	The Failed Transfer List is empty.	No solution required.
Selecting the Recover button has no effect.	A patient has not been selected from the Failed Transfer List.	Select the patient whose information is to be recovered from the list and then select the Recover button.
Select the tile to place the recovered patient in	A destination tile on the Source Panorama was not selected before pressing the Recover button.	Select a destination tile on the Source Panorama.
The destination tile must have a device assigned to perform the transfer	The destination tile does not have a device assigned.	Select the OK button to return to the Recover Failed Transfer Patients view. Select a destination tile that has a device assigned and continue the transfer procedure.
The Waiting for Patient message is displayed in the heart rate digital tile.	The destination device has not been activated.	Activate the destination device.

* *Messages are shown in all bold text.*

Deleting Failed Transfer Patient Data

MESSAGE/ISSUE *	REASON	SOLUTION
The Delete Failed Transfer sidebar button is disabled.	The Failed Transfer List is empty.	No solution required.
Selecting the Delete button has no effect.	A patient has not been selected from the Failed Transfer List.	Select the patient whose information is to be deleted from the list and then select the Delete button.

* *Messages are shown in all bold text.*

Transferring Failed Transfer Patient Data

MESSAGE/ISSUE *	REASON	SOLUTION
The Transfer From Failed List sidebar button is disabled.	The Failed Transfer List is empty.	No solution required.
Selecting the Transfer button has no effect.	A patient has not been selected from the Failed Transfer List.	Select the patient whose information is to be transferred from the list and then select the Transfer button.

* *Messages are shown in all bold text.*

5.3 Discharge Tab

The **Discharge** tab (shown in FIGURE 5-20) is used to discharge a patient from a patient tile. If the required demographic information was previously entered for the patient to be discharged, the patient will be moved to the list of retrievable patients. For additional information regarding retrieving a patient, refer to "Retrieving Discharged Patients" on page 5-17.

The **Discharge** tab is not available at the ViewStation. Patient discharge can be performed at the host central station, the WorkStation, or the bedside monitor. Any change in the patient tile's state will be communicated and changed at the host central station and bedside monitor, if applicable.

NOTE: The host central station(s) C-LAN configuration settings and the software installed at the remote location dictates the functionality available for each patient tile. For additional information, refer to "The ViewStation and the WorkStation" on page 2-4.

5.3.1 Accessing the Discharge Tab

1. From the menu bar, select the **Patient Setup** menu button. The tabs associated with patient setup are displayed.
2. Choose a patient tile by selecting its digital tile or waveform area.
3. Select the **Discharge** tab. The **Discharge** tab is enabled.



FIGURE 5-20 Discharge Tab

5.3.2 Discharging a Patient from the Central Station and the Bedside Monitor

NOTE: Discharge from the bedside monitor and the central station or WorkStation can only be performed when the central station Discharge at Bedside button in the Unit Choices tab is set to ON. For additional information regarding the Unit Choices tab, refer to the "Unit Choices Tab" on page 9-50.

1. Select the tile of the patient to be discharged. Choose a patient tile by selecting its digital data or waveform area.

2. Select the **Bedside and Panorama Discharge** button (shown in FIGURE 5-20). One of two messages will be displayed:
 - If the patient tile contains all the required demographic information (at least two of the three demographic fields, First Name, Last Name, ID must be populated), the **Are you sure you want to discharge this patient? Selecting Yes will move the patient to the discharge list** dialog box is displayed.
 - The **Yes** button discharges the selected patient from the central station and the bedside monitor. It also moves the patient to the central station discharge list.
 - The **No** button cancels the discharge
 - If the patient tile does not contain all the required demographic information (at least two of the three demographic fields, First Name, Last Name, ID must be populated) the message **The patient's data and submitted print jobs will be deleted because at least two of the following fields: First Name, Last Name or ID has not been filled in. Do you still want to proceed with the discharge?** is displayed.
 - The **Yes** button completes the discharge deleting all patient data and unprocessed print jobs
 - The **No** button cancels the discharge

5.3.3 Discharging a Patient from the Central Station

NOTE: Discharge from the central station is only available when the bedside monitor is in a **Communications Lost** state.

1. Select the tile of the patient to be discharged. Choose a patient tile by selecting its digital data or waveform area.
2. Select the **Discharge Patient** button. The **Local Discharge Only! Patient will not be discharged at bedside. Do you still want to proceed with discharge?** message is displayed.
 - If the **Yes** button is selected and at least two of the three demographic fields, First Name, Last Name, ID are populated, the **Are you sure you want to discharge this patient? Selecting Yes will move the patient to the discharge list** message box will be displayed.
 - The **Yes** button completes the discharge and moves the patient to the central station discharge list
 - The **No** button cancels the discharge
 - If the **Yes** button is selected and the patient tile does not contain all the required demographic information (at least two of the three demographic fields, First Name, Last Name, ID must be populated) the message **The patient's data and submitted print jobs will be deleted because at least two of the following fields: First Name, Last Name or ID has not been filled in. Do you still want to proceed with the discharge?** is displayed.
 - The **Yes** button completes the discharge deleting all patient data and unprocessed print jobs
 - The **No** button cancels the discharge

- The **No** button cancels the discharge

5.3.4 Discharging a Patient from a Telepack Device

The same messages described in “Discharging a Patient from the Central Station and the Bedside Monitor” on page 5-37 will be displayed, with one exception. If the **Yes** button is selected after the message **Are you sure you want to discharge this patient? Selecting Yes will move the patient to the discharge list** is displayed, the Telepack will be discharged from the central station. Discharging a Telepack device can only be done from the central station. Once discharged, all the patient information will be cleared.

5.3.5 Sidebar Button - Normal Screen

Select the **Normal Screen** sidebar button to return the display to the full screen mode, and close all tabs, message boxes, and dialog boxes.

5.3.6 Troubleshooting

This section lists some of the potential messages and issues that may occur while using the **Discharge** tab.

MESSAGE/ISSUE *	REASON	SOLUTION
No patient Selected!	This message appears in the demographic field when either a patient tile has not been selected or an empty tile was selected.	Select an active patient tile.
The patient’s data and submitted print jobs will be deleted because at least two of the following fields: First Name, Last Name or ID has not been filled in. Do you still want to proceed with the discharge?	The selected patient does not have at least two of the three demographic fields completed. The demographic fields include First Name, Last Name, and ID.	Select the No button to close the dialog, then enter the required demographic information.
The The patient’s data and submitted print jobs will be deleted because at least two of the following fields: First Name, Last Name or ID has not been filled in. Do you still want to proceed with the discharge? dialog box is open and was automatically closed without any user interaction.	The bedside monitor has gone into a Communications Lost state.	Restore the connection between the Panorama Central Station and the monitoring device. If unable to restore the connection, select the Discharge Patient button to discharge the equipment from the patient tile.

* Messages are shown in all bold text.

MESSAGE/ISSUE *	REASON	SOLUTION
Unable to perform operation on tile: Central to Central Transfer Out in progress.	A Central to Central transfer Out has been initiated at the source central station but not accepted or rejected at the destination central station for the selected tile, and the Discharge Patient button is pressed in the Discharge tab at the source central station.	Wait until the Central to Central transfer is complete, then discharge the patient.
Unable to perform operation on tile: Central to Central Transfer In in progress.	A Central to Central transfer In is in progress for the selected tile and the selected tile is actively monitoring a patient, and the Discharge Patient button is pressed in the Discharge tab at the destination central station.	Wait until the Central to Central transfer is complete, then discharge the patient.
The Discharge Patient button in the Discharge tab is disabled.	The Discharge at Bedside setting in the Unit Choices tab is set to OFF .	If a patient discharge is necessary, it must be performed from the bedside monitor.
	The Discharge tab needs to be refreshed.	Select another tab and then return to the Discharge tab.
	No patient is selected.	Select a patient tile.
The Discharge Patient button in the Discharge tab is enabled.	The bedside monitor has gone into a Communications Lost state.	Verify the connection between the Panorama Central Station and the monitoring device.
	The Discharge at Bedside setting in the Unit Choices tab is set to OFF .	No solution required.
	A Telepack device is in use.	No solution required.
Local Discharge Only! Patient will not be discharged at bedside. Do you still want to proceed with discharge?	The bedside monitor is in a Communications Lost state.	Verify the connection between the Panorama Central Station and the monitoring device.
The Local Discharge Only! Patient will not be discharged at bedside. Do you still want to proceed with discharge? dialog box is open and was automatically closed without any user interaction.	The bedside monitor is no longer in a Communications Lost state.	If the Discharge at Bedside button in the Unit Choices tab is set to ON, proceed with the discharge by selecting the Discharge Patient button. If it is set to OFF, the discharge must be performed from the bedside.

* Messages are shown in all bold text.

5.4 Display Tab

The **Display** tab (shown in FIGURE 5-21) is used to select the digital and waveform parameters that will appear in the selected patient tile. The default settings for patient tiles are defined by the **Unit Choices** tab, which is described in the "Unit Choices Tab" on page 9-50. The layout and functionality of the **Display** tab will change based on the type of monitoring device assigned to the selected patient tile.

The **Display** tab is available at the ViewStation and the WorkStation (shown in FIGURE 5-22), and functions in the same manner as it does at the host central station. When a patient tile is assigned at the ViewStation or the WorkStation, it will initially use the display settings of the associated patient tile at the host central station, provided the patient tile is in an active state..

After this initial transfer, changes made to the host central station, the ViewStation and/or the WorkStation patient tile **Display** tab will be independent of each other unless communication is interrupted. Automatic updating of the display settings at the remote workstation patient tile will occur if any of the following occur:

- The monitoring device is placed in the Standby mode at the central station
- The monitoring device is not communicating with its host central station (Communications Lost)
- Communication between the host central station and the ViewStation and/or the WorkStation is lost (Central Communications Lost)

NOTE: The host central station(s) C-LAN configuration settings and the software installed at the remote location dictates the functionality available for each patient tile. For additional information, refer to "The ViewStation and the WorkStation" on page 2-4.

5.4.1 Accessing the Display Tab

1. From the menu bar, select the **Patient Setup** menu button. The tabs associated with patient setup are displayed.
2. Choose a patient tile by selecting its digital tile or waveform area.
3. Select the **Display** tab. The **Display** tab is enabled.

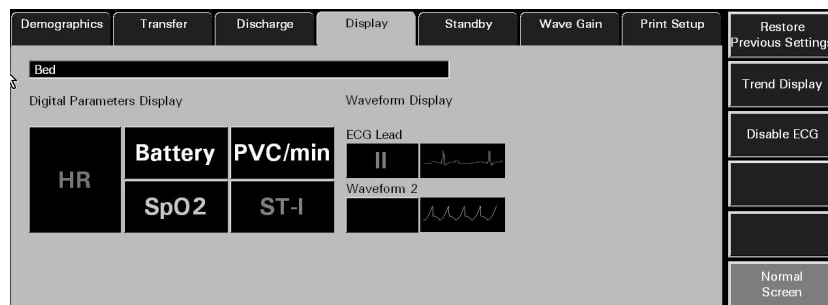

FIGURE 5-21 Display Tab

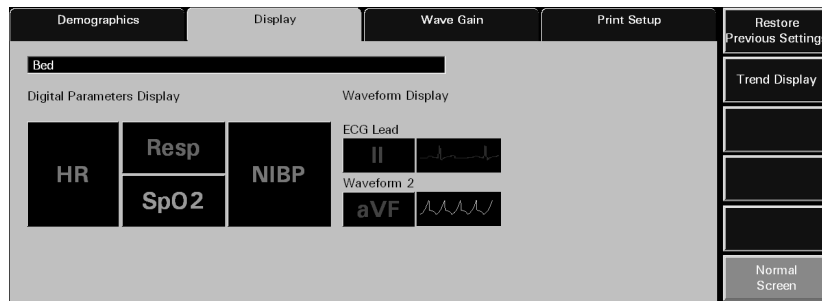

FIGURE 5-22 Display Tab (ViewStation and WorkStation)

5.4.2 Components of the Display Tab

Digital Parameter Data

The Panorama Central Station is capable of showing three to five digital data parameters in each patient file.

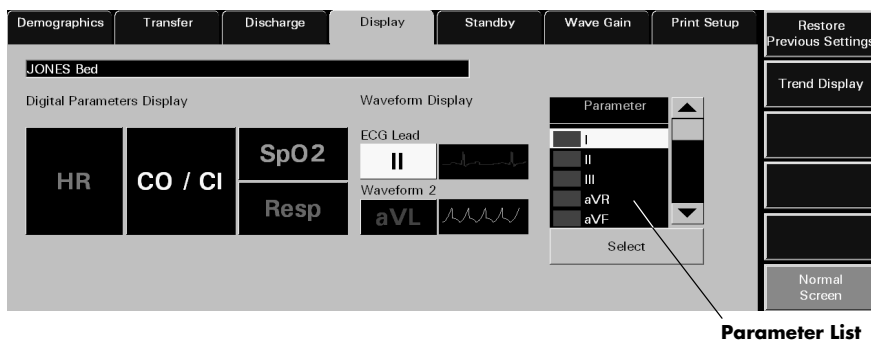

FIGURE 5-23 Display Tab - Parameter List shown

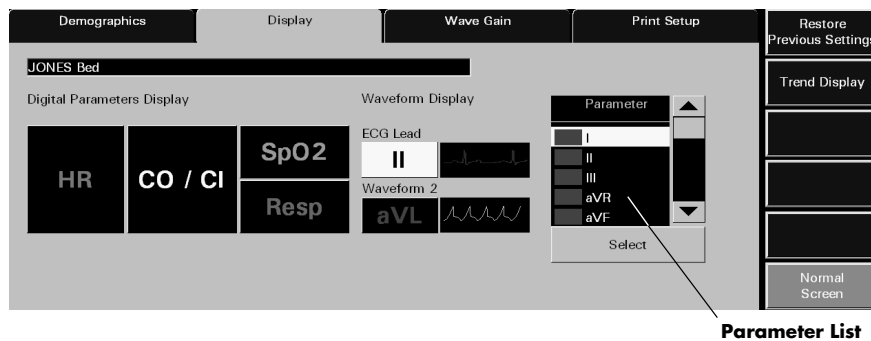

FIGURE 5-24 Display Tab - Parameter List shown (ViewStation and WorkStation)

NOTE: The Parameter list box is not displayed in the Display tab until a parameter tile is selected.

NOTE: When using a WMTS 608 wireless bedside device with a View 12™ card, all 12 leads will be available in the Parameter list, but only the waveforms for leads I, II, III, aVR, aVL, aVF, and V1 will be displayed in the patient tile.

Digital data tiles display a minimum of three and a maximum of five parameters depending on the parameters selected.

A digital data tile consists of three equal-size tiles. The Heart Rate (HR) parameter is always shown in the first tile. The remaining two tiles can each be divided into two sub-tile areas. If the associated device is a Telepack, the Battery Percentage parameter (shown in FIGURE 5-25) will occupy one sub-tile.



FIGURE 5-25 Battery Percentage Digital Data Tile (Telepack)

Parameters occupy 1 or 2 sub-tile areas. The number of digital data parameters that can be displayed is dependent on the type of parameters selected. For example, the NIBP parameter uses two data tiles while the Respiration parameter uses one data tile.



FIGURE 5-26 NIBP and Respiration Digital Data Tiles

Table 5-1 shows the number of sub-tiles that each parameter occupies. For a list of the parameters listed by monitoring device, refer to “Supported Devices” on page 1-3. For additional information regarding the setup of a patient tile, refer to the “Display Tab” on page 5-41.

TABLE 5-1

Number of Sub-tiles Occupied by a Parameter

PARAMETERS	# OF SUB-TILES OCCUPIED
Heart Rate	2
NIBP	2
Respiration	1
SpO ₂	1
IBP	2
Temperature	1
CO ₂	2
O ₂	2
N ₂ O	2
Agent	2

TABLE 5-1
Number of Sub-tiles Occupied by a Parameter

PARAMETERS	# OF SUB-TILES OCCUPIED
PVC	1
ST	1
CO/CI	2
CCO/CCI	2
CCO STAT/CCI STAT	2
SVR	1
SVRI	1
SVO ₂	1
ScVO ₂	1
PAWP	1
Battery Percentage	1

NOTE: Digital data is shown in the color configured for the parameter. For additional information, refer to the “Parameter Color Tab” on page 9-2.

Heart Rate Tile

The Heart Rate tile (shown in FIGURE 5-27) shows the heart rate measurement, the lead through which the measurement is acquired and icons for Arrhythmia/ST analysis.



FIGURE 5-27 Heart Rate Digital Data Tile

The Heart Rate tile follows additional digital data rules.

For example, the Heart Rate tile:

- Always occupies the first digital data tile
- Displays an ECG lead label for the lead acquiring the data
- Displays an **A** icon if arrhythmia analysis is enabled
- Displays an **S** icon if ST analysis is enabled
- Displays the standby location for a patient in Standby mode

Tile Display Rearrangement

Depending on the number of parameters selected, a blank tile may be displayed in the **Display** tab. A blank tile will not be displayed on the Main Screen because the system will automatically populate the empty sub-tiles based on the type of monitoring device:

- **Telepack:** the parameters in the Main Screen tile will automatically rearrange to remove the blank tiles.

- **Bedside:** the parameters in the Main Screen tile will automatically rearrange to compress user selections with the remaining digital data tiles populating based on the next parameter available in the **Unit Priorities** tab.

Waveform Parameter Data

The patient tile is capable of showing up to two waveforms for a patient (shown in FIGURE 5-28).

NOTE: The initial central station wave default settings come from the System Wave Default settings, if settings were configured.

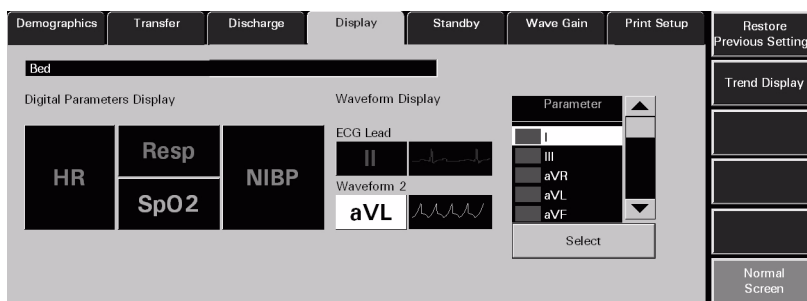

FIGURE 5-28 Display Tab - Waveform Data

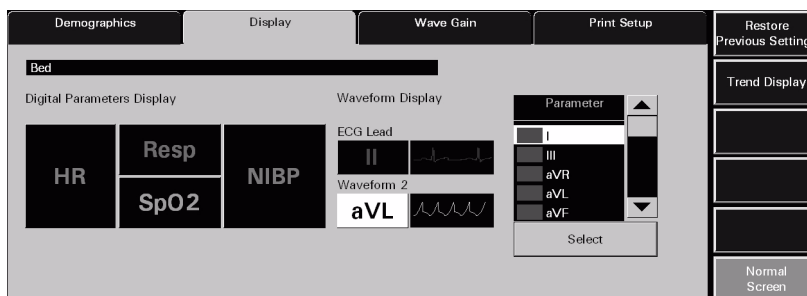

FIGURE 5-29 Display Tab - Waveform Data (ViewStation and WorkStation)

The first waveform is always an ECG waveform. The second waveform can be any other waveform parameter available for the associated device or, if desired, it can be turned off. Each waveform has its own baseline.

NOTE: Waveforms display in the color that was selected for the parameter. For additional information, refer to the "Parameter Color Tab" on page 9-2.

The following table shows the available waveform parameters.

WAVEFORM PARAMETER	AVAILABLE WAVEFORMS
ECG Lead	I, II, III, aVR, aVL, aVF, V, V1, V2, V3, V4, V5, V6 <ul style="list-style-type: none"> The ECG waveforms available are dependent on the lead set used. ECG waveforms use the Pacer Enhancement and Filter Settings that were selected in the Demographics tab for the selected patient tile.

WAVEFORM PARAMETER	AVAILABLE WAVEFORMS
Waveform 2	<p>I, II, III, aVR, aVL, aVF, V, V1, V2, V3, V4, V5, V6, Resp, SpO₂, IBP1, IBP2, IBP3, IBP4, CO₂, O₂, Agent (Iso, Enf, Sev, Hal, Des)</p> <ul style="list-style-type: none"> The ECG waveforms available are dependent on the lead set used. The waveform chosen for the ECG Lead waveform will not be included in the parameter list because it cannot be used in both waveform positions. The remaining parameters available for the second waveform are dependent on the monitoring device associated with the patient tile.

5.4.3 Configuring the Display Tab

This section describes how to configure parameter tiles in the **Display** tab.

ViewStation and WorkStation patient tiles will initially display the same display settings of the associated patient tile at the host central station. For additional information regarding the transfer of display settings from the host central station, refer to the "Trends Tab" on page 7-14.

Selecting a Patient's Parameter Data

1. Choose a patient tile by selecting its digital data or waveform area.
2. Select the parameter tile to be modified. The Parameter list is displayed.
3. From the Parameter list, select the parameter to be viewed or turn the parameter OFF.

NOTE: Digital parameters and the first waveform parameter cannot be turned off.

NOTE: The OFF option is only available in the Parameter list when Waveform 2 is selected in the Waveform Display area. When OFF is selected, the message "Are you sure you want to turn off the parameter" is displayed.

- Digital Parameters include Heart Rate, Respiration, IBP, NIBP, Temp, ST, PVC, SpO₂, N₂O, CO₂, O₂, Cardiac Output (CO), Cardiac Index (CI), Continuous Cardiac Output (CCO), Continuous Cardiac Index (CCI), System Vascular Resistance (SVR), System Vascular Resistance Index (SVRI), SVO₂, ScVO₂, T Blood, Delta T, Pulmonary Artery Wedge Pressure (PAWP) (not supported in DPM6/7), Battery Percentage (for a Telepack device only), and Agent.

NOTE: The CO/CI, Temp 2, and T Blood parameters are only available if they are being monitored by the DPM6/7 (except CO/CI), V Series, Spectrum/Spectrum OR External Parameter Module (EPM). These parameters are not available if they are monitored by an Edwards Vigilance® monitor.

NOTE: The CCO/CCI, SVR, and SVRI parameters are only available if they are being monitored by the DPM6/7 and V Series.

NOTE: The CCO STAT/CCI STAT, SVO₂, ScVO₂, and Temp 3 parameters are only available if they are being monitored by the V Series.

- Waveform Parameters include I, II, III, aVR, aVL, aVF, V, V1, V2, V3, V4, V5, and V6.

4. Choose the **Select** button to highlight the selected parameter. The parameter is shown in the selected patient tile.

NOTE: A digital parameter can only be shown in one parameter tile at any given time.

5.4.3.1 Configuring a Trend Display Interval

Select the **Trend Display** sidebar button to configure the interval at which a patient's trend data will be displayed at the Panorama Central Station, ViewStation, and the WorkStation. Regardless of which Trend Display interval is selected, NIBP, CO/CI, and PAWP trend records will be displayed.

When a patient tile is assigned at the ViewStation or the WorkStation, it will initially display the Trend Display interval of the associated host central station patient tile, provided the patient tile is communicating with the central station. The **Trend Display** sidebar button is available at the ViewStation and the WorkStation and it may be used in the same manner as it is at the central station. For additional information regarding the transfer of trend interval settings from the host central station, refer to the "Trends Tab" on page 7-14.

The default setting for a Trend Display interval is determined by the **Unit Choices** tab. For additional information regarding the **Unit Choices** tab, refer to "Unit Choices Tab" on page 9-50.

NOTE: Trends data is automatically stored in one minute intervals. The Trend Display interval selected does not affect how trend information is stored in the database, just how it is displayed.

NOTE: Changing the Trend Display interval in the Display tab automatically adjusts the Trend Display interval in the Trends tab. Changing the Trend Display interval in the Trends tab automatically adjusts the Trend Display interval in the Display tab.

To select the Trend Display interval:

1. From the **Display** tab, select the **Trend Display** sidebar button. The Trend Display dialog box (shown in FIGURE 5-30) is displayed.

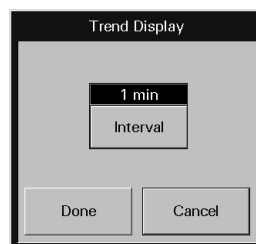

FIGURE 5-30 Trend Display Dialog Box

2. Select the **Interval** button until the desired interval period is displayed. Interval periods include 1 minute, 5 minutes, 10 minutes, 15 minutes, 30 minutes, 1 hour, and 2 hours.
3. Select the **Done** or the **Cancel** button.
 - The **Done** button accepts the selection.

- The **Cancel** button discards the selection, closes the dialog box, and returns to the **Display** tab.

With the exception of NIBP, CO/CI, and PAWP, selecting the **Done** button will change the Trend Display interval in the Trends tab based on the standard clock time intervals. Refer to the following table:

INTERVAL	TREND RECORDS DISPLAYED IN TRENDS TAB
1 minute	All trend records will be displayed.
5 minute	All trend records having a timestamp of 0, 5, 10, 20, 25, 30, 35, 40, 45, 50, and 55 minutes will be displayed.
10 minute	All trend records having a timestamp of 0, 10, 20, 30, 40, and 50 minutes will be displayed.
15 minute	All trend records having a timestamp of 0, 15, 30, and 45 minutes will be displayed.
30 minutes	All trend records having a timestamp of 0, and 30minutes will be displayed.
1 hour	All trend records having a timestamp of 0 minutes (for example, 12:00, 1:00, 2:00) will be displayed.
2 hour	All trend records having a timestamp of 0 minutes for even hours only (for example, 12:00, 2:00, 4:00) will be displayed.

5.4.4 Sidebar Buttons

The following sidebar buttons are used to expand the functionality of this tab.

Restore Previous Settings

Select the **Restore Previous Settings** sidebar button to return patient display settings to those in use when the tab was opened.

Trend Display

This sidebar button was previously described on page 5-48.

Disable ECG

Disable ECG is available on version 8.7.1 and above. See page 9-54 for setting the system default for displaying the **Disable ECG** sidebar button.

If the system has been configured, the **Disable ECG** sidebar button is displayed when a Telepack device with an SpO₂ module is connected. Select the **Disable ECG** sidebar button to disable the display of ECG waveform(s) for the patient(s) if the current Heart Rate source is not ECG.

The Disable ECG sidebar button is disabled if the patient is in Standby mode, during communications loss, or if the Telepack does not have an SpO₂ module connected.

NOTE: **If the Disable ECG sidebar button is latched and the Heart Rate source changes to ECG, the Disable ECG sidebar button will be unlatched and the ECG waveform(s) will be re-enabled.**

Normal Screen

Select the **Normal Screen** sidebar button to return the display to the full screen mode, and close all tabs, message boxes and dialog boxes.

5.4.5 Troubleshooting

This section lists some of the potential messages and issues that may occur while using the **Display** tab.

MESSAGE/ISSUE *	REASON	SOLUTION
No Patient Selected!	This message is displayed in the demographic field when either a patient tile has not been selected or an empty tile was selected.	Select an active patient tile.
V2, V3, V4, V5, or V6 was selected from the Parameter list but the waveform is not displayed in patient tile.	A WMTS 608 wireless bedside device with a View 12 card is in currently in use. When using this device type, the V2-V6 waveforms will not be displayed.	Select a different waveform from the Parameter list. Change to a hardwired or 2.4 GHz wireless device.
The parameter tiles in the Display tab are disabled.	A valid patient tile is not selected.	Select an active patient tile.

* Messages are shown in all bold text.

5.5 Standby Tab

The **Standby** tab (shown in FIGURE 5-31) is used to place a patient in Standby mode at the Panorama Central Station, the WorkStation or the bedside monitor. Standby mode temporarily suspends all patient monitoring, alarm processing, and trending activity.

The **Standby** tab is available at the WorkStation and it may be used in the same manner as it is at the central station. Any change in the patient tile's state will be communicated and changed at the host central station and bedside monitor, if applicable.

NOTE: Patients placed in the Standby mode should be closely monitored.

NOTE: The host central station(s) C-LAN configuration settings and the software installed at the remote location dictates the functionality available for each patient tile. For additional information, refer to "The ViewStation and the WorkStation" on page 2-4.

5.5.1 Accessing the Standby Tab

1. From the menu bar, select the **Patient Setup** menu button. The tabs associated with patient setup are displayed.
2. Choose a patient tile by selecting its digital tile or waveform area.
3. Select the **Standby** tab. The **Standby** tab is enabled.



FIGURE 5-31 Standby Tab

5.5.2 Placing a Patient in Standby Mode

This section outlines placing a patient in the Standby mode from the Panorama Central Station.

1. Choose a patient tile by selecting its digital data or waveform area.
2. From the menu bar, select the **Patient Setup** menu button. The tabs associated with patient setup are displayed.
3. Select the **Standby** tab. The **Standby** tab is displayed.
4. Select the type of Standby mode to be used for the patient.
 - a. Select the **Panorama Standby Only/Standby** button to discontinue patient monitoring at central station but continue monitoring the patient at the bedside.

NOTE: If using a Telepack device, the **Panorama Standby Only** button will be labeled **Standby**.

- b. Select the **Bedside and Panorama Standby** button to discontinue monitoring the patient at the central station and at the bedside monitor.

The Patient Location list box is displayed (shown in FIGURE 5-32).

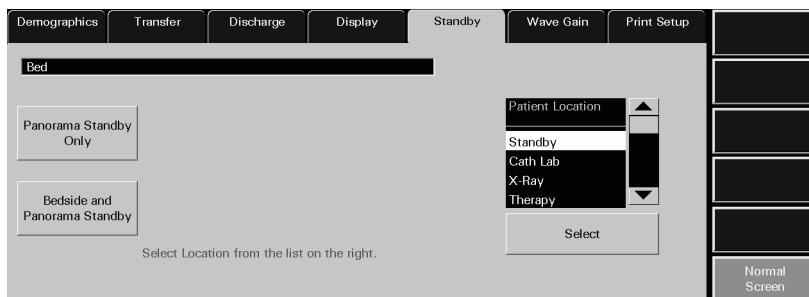

FIGURE 5-32 Standby Tab with Patient Location List displayed

5. Select a patient location from the Patient Location list box, which includes:
 - **Standby**
 - **Cath Lab**
 - **X-ray**
 - **Therapy**
 - **Bath**
 - **OR**
 - **ER**
 - **In Transit**
6. Choose the **Select** button to confirm the Standby location selected. The text for the standby location is shown in the patient tile, and all monitoring, alarm processing and trend storage is suspended.

5.5.3 Removing a Patient from Standby Mode

To remove a patient from Standby mode:

1. From the menu bar, select the **Patient Setup** menu button. The tabs associated with patient setup are displayed.
2. Select the **Standby** tab. The **Standby** tab is displayed.
 - If the patient is in the **Panorama Standby Only** mode, select the **Resume Monitoring** button.

The message **Are you sure that you want to return the patient from Panorama standby** is displayed. Select the **YES** button to return the patient from standby mode and resume monitoring or the **NO** button to keep the patient in Standby mode.
 - If the patient is in the **Bedside and Panorama Standby** mode, select the **STANDBY** button on the bedside monitor.

5.5.4 Sidebar Button - Normal Screen

Select the **Normal Screen** sidebar button to return the display to the full screen mode, and close all tabs, message boxes, and dialog boxes.

5.5.5 Troubleshooting

This section lists some of the potential messages and issues that may occur while using the **Standby** tab.

MESSAGE/ISSUE *	REASON	SOLUTION
No Patient Selected!	This message is displayed in the demographic field when either a patient tile has not been selected or an empty tile was selected.	Select an active patient tile.
A patient in bedside standby cannot be directly placed into Panorama only standby	This message is displayed when the selected patient is already in Standby mode at the bedside monitor or was just released from Standby mode at the bedside monitor.	Select the OK button to close the dialog box. Resume monitoring at the bedside monitor before trying to change standby locations. Wait a moment and try to put the patient in Standby mode again.
Patient in auto standby may only be released from bedside	This message is displayed when the Bedside and Panorama Standby button is selected for a patient that is already in Standby mode at the Panorama Central Station and the Bedside monitor.	Select the OK button to close the dialog box. Release the patient from Standby mode at the bedside monitor before trying to change the patient's Standby mode.
The Standby tab for the selected patient tile is disabled at the WorkStation.	The central station from where the patient tile was networked is configured as View Only.	No solution required.

* *Messages are shown in all bold text.*

5.6 Wave Gain Tab (Patient)

The **Wave Gain** tab (shown in FIGURE 5-33) is used to change the wave gain settings for the selected patient's available waveforms. The layout, functionality, and buttons available in this tab will change based on the type of monitoring device assigned to the selected patient file.

NOTE: **Changing the ECG wave gain does not affect the arrhythmia algorithm.**

The **Wave Gain** tab is available at the ViewStation and the WorkStation, and functions in the same manner as it does at the host central station. When a patient tile is assigned at the ViewStation or the WorkStation, it will initially display the wave gain settings of the associated host central station patient tile, provided the patient tile is communicating with the central station.

After this initial transfer, changes made to the host central station, the ViewStation and/or the WorkStation patient tile **Wave Gain** tab will be independent of each other unless communication is interrupted. Automatic updating of the wave gain settings at the remote workstation patient tile will occur if any of the following occur:

- The monitoring device is placed in the Standby mode at the central station
- The monitoring device is not communicating with its host central station (Communications Lost)
- Communication between the host central station and the ViewStation and/or the WorkStation is lost (Central Communications Lost)

The default host central station wave gain settings are defined by the System **Wave Gain** tab, which is described in the "Wave Gain Tab (System)" on page 9-59.

5.6.1 Accessing the Wave Gain Tab (Patient)

1. From the menu bar, select the **Patient Setup** menu button. The tabs associated with patient setup are displayed.
2. Choose a patient tile by selecting its digital tile or waveform area.
3. Select the **Wave Gain** tab. The **Wave Gain** tab is enabled.



FIGURE 5-33 Wave Gain Tab



FIGURE 5-34 Wave Gain Tab (ViewStation and WorkStation)

5.6.2 Changing a Patient's Wave Gain Settings

This section outlines entering and modifying a patient's wave gain settings using the **Wave Gain** tab.

ViewStation and WorkStation patient tiles will initially display the same wave gain settings of the associated patient tile at the host central station. For additional information regarding the transfer of wave gain settings from the host central station, refer to "Wave Gain Tab (Patient)" on page 5-54.

1. Choose a patient tile by selecting its digital data or waveform area.
2. In the **Wave Gain** tab, select the **ECG mm/mV** button until the desired wave gain displays. The settings available for the ECG wave gain include 2.5, 5.0, 10.0, 20.0, and 30.0 mm/mV.
3. Select the **IBPx mmHg** buttons until the desired wave gain displays. The settings available for the IBPx wave gain include 0-20, 0-40, 0-80, 60-140, 0-160, 0-225, 0-320, and (-10) -10 mmHg.

NOTE: If the **IBPx** button(s) have been labeled at the bedside monitor, the same label(s) will be displayed on the individual wave gain button(s).

4. Select the **Resp Gain** button until the desired wave gain is displayed. The settings available for the resp gain wave gain include 1, 2, 3, 4, and 5.
5. Select the **CO₂ (% , kPa, mmHG)** button until the desired wave gain is displayed.
 - The settings available for the CO₂ % wave gain include 5.0, 7.5, and 10.0 %.
 - The settings available for the CO₂ kPa wave gain include 5.0, 7.5, and 10.0 kPa.
 - The settings available for the CO₂ mmHg wave gain include 40, 60, and 100 mmHg.
6. Select the **O₂ %** button until the desired wave gain is displayed. The settings available for the O₂ wave gain include 18 - 30, 18 - 60, and 18 - 100 %.
7. Select the **AGENT %** button until the desired wave gain is displayed. The settings available for the agent wave gains include 0 - 1.0, 0 - 2.5, 0 - 5.0, 0 - 10.0, 0 - 15.0, and 0 - 20.0 %.
8. Select the **Done** button to accept the wave gain settings shown in the Wave Gain tab. A patient's wave gain settings will not be changed unless the **Done** button is selected.

5.6.3 Sidebar Buttons

The following sidebar buttons are used to expand the functionality of this tab.

Restore Previous Settings

Select the **Restore Previous Settings** sidebar button to return patient display settings to those in use when the tab was opened.

Normal Screen

Select the **Normal Screen** sidebar button to return the display to the full screen mode, and close all tabs, message boxes, and dialog boxes.

5.6.4 Troubleshooting

This section lists some of the potential messages and issues that may occur while using the patient **Wave Gain** tab.

MESSAGE/ISSUE *	REASON	SOLUTION
No Patient Selected!	This message is displayed in the demographic field when either a patient tile has not been selected or an empty tile was selected.	Select an active patient tile.
The patient's wave gain settings did not change	The Done button was not selected after the patient's wave gain settings were changed.	Adjust the patient's wave gain settings and select the Done button when the settings are completed.

* *Messages are shown in all bold text.*

5.7 Print Setup Tab (Patient)

The **Print Setup** tab (shown in FIGURE 5-35) is used to select the waveforms that will be printed when an All Strips, Event Zoom-In, or Full Disclosure Zoom-In report is generated for the selected patient tile. The waveforms included in this tab will change based on the parameters in use and the type of monitoring device that is assigned to the selected patient tile. The default settings for the waveform portion of the Print Setup tab are defined by the system **Print Setup** tab, which is described in the "Print Setup Tab (System)" on page 9-45.

The **Print Setup** tab is available at the ViewStation and the WorkStation, and functions in the same manner as it does at the host central station. When a patient tile is assigned at the ViewStation or the WorkStation, it will initially display the print setup configuration settings of the associated host central station patient tile, provided the patient tile is communicating with the central station.

After this initial transfer, changes made to the host central station, the ViewStation and/or the WorkStation patient tile **Print Setup** tab will be independent of each other unless communication is interrupted. Automatic updating of the print setup configuration settings at the remote workstation patient tile will occur if any of the following occur:

- The monitoring device is placed in the Standby mode at the central station
- The monitoring device is not communicating with its host central station (Communications Lost)
- Communication between the host central station and the ViewStation and/or the WorkStation is lost (Central Communications Lost)

5.7.1 Accessing the Print Setup Tab

1. From the menu bar, select the **Patient Setup** menu button. The tabs associated with patient setup are displayed.
2. Choose a patient tile by selecting its digital tile or waveform area.
3. Select the **Print Setup** tab. The **Print Setup** tab is enabled.

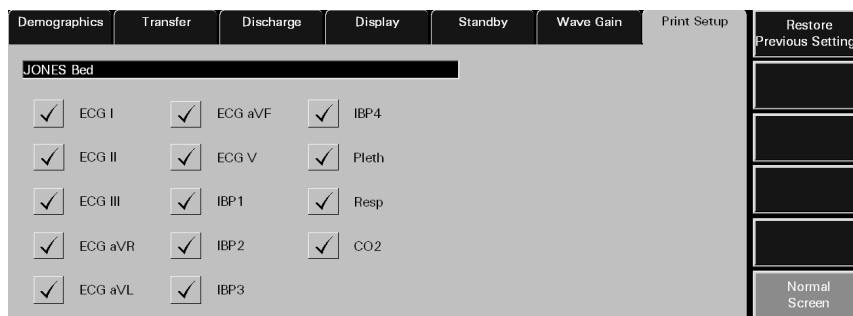

FIGURE 5-35 Patient Print Setup Tab (Central Station)

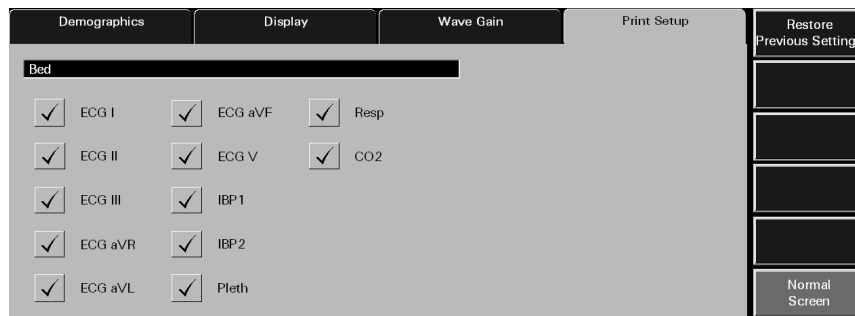

FIGURE 5-36 Patient Print Setup Tab (ViewStation)

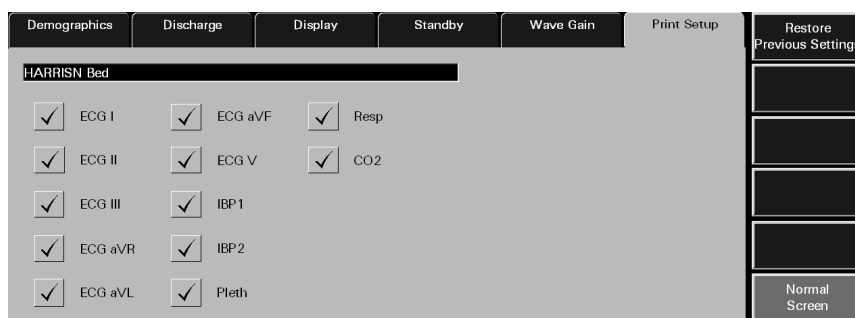

FIGURE 5-37 Patient Print Setup Tab (WorkStation)

5.7.2 Changing a Patient's Print Setup

This section outlines entering and modifying a patient's print setup via the **Print Setup** tab.

Customizing a Patient's Print Setup

1. Choose a patient tile by selecting its digital data or waveform area.
2. In the **Print Setup** tab, select a **check box** button to enable/disable the printing of a parameter. The patient's print setup settings are instantly changed.

The Parameters available in the **Print Setup** tab are dependent on the lead set and/or monitoring device connected to the patient.

- A check mark in a parameter check box indicates that the parameter is selected and will print the patient's All Strip Report, Event Zoom-In, and Full Disclosure Zoom-In Reports.
- An empty parameter check box indicates that the parameter is not selected and will not print the patient's All Strip Report, Event Zoom-In, and Full Disclosure Zoom-In Reports.

5.7.3 Sidebar Buttons

The following sidebar buttons are used to expand the functionality of this tab.

Restore Previous Settings

Select the **Restore Previous Settings** sidebar button to return patient display settings to those in use when the tab was opened.

Normal Screen

Select the **Normal Screen** sidebar button to return the display to the full screen mode, and close all tabs, message boxes, and dialog boxes.

5.7.4

Troubleshooting

This section lists some of the potential messages and issues that may occur while using the patient **Print Setup** tab.

MESSAGE/ISSUE *	REASON	SOLUTION
No Patient Selected!	This message appears in the demographic field when either a patient tile has not been selected or an empty tile was selected.	Select an active patient tile.
A waveform does not print	The waveform is not selected in the patient's Print Setup tab.	Select the waveform in the patient's Print Setup tab.

* *Messages are shown in all bold text.*

This page intentionally left blank.

6.0 *Patient Alarm Functions*

This section describes the configuration of patient alarms at the Panorama Central Station.

- Patient Alarm Setup Tab (Optional)
- Alarm Limits Tab (Patient)
- Alarm Responses Tab (Patient)

6.1 Patient Alarm Setup Tab (Optional)

The **Patient Alarm Setup** tab (shown in FIGURE 6-1) provides password protected access to the patient alarm configuration. When the correct password is entered, the **Alarm Limits** and the **Alarm Responses** tabs are opened.

The **Patient Alarm Setup** tab is only shown if the Password Protection option is set to **ON** in the **System Alarms** tab. If Password Protection is **OFF**, the **Patient Alarms** menu button provides direct access to the **Alarm Limits** and the **Alarm Responses** tabs. For additional information, refer to the "System Alarms Tab" on page 9-14.

The **Patient Alarm Setup** tab is available at the central station and the WorkStation.

6.1.1 Accessing the Patient Alarm Setup Tab

From the menu bar, select the **Patient Alarms** menu button. The **Patient Alarm Setup** tab is displayed.



FIGURE 6-1 Patient Alarm Setup Tab

6.1.2 Entering a Password

To enter a password:

1. Select the **Password** text box in the **Patient Alarm Setup** tab. The keyboard dialog box is displayed.
2. Use the keyboard dialog box to enter the **Alarm** password that was created in the **Passwords** tab (maximum 15 characters). For security purposes asterisks (*) are shown for each typed character. For additional information regarding passwords, refer to the "Passwords Tab" on page 9-29 or contact your System Administrator.

NOTE: Passwords are case sensitive.

- The Backspace (<==) button clears a single character in the edit box
- The **Caps Lock** button enables/disables the caps lock function. A Caps Lock indicator is shown when **Caps Lock** is enabled.
- The **Close** button discards the changes
- The **Enter** button accepts changes

3. The **Alarm Limits** (shown in FIGURE 6-2) and the **Alarm Responses** (shown in FIGURE 6-6) tabs are shown after the correct password is entered. For additional information about alarm limits and alarm responses, refer to “Alarm Limits Tab (Patient)” on page 6-4 and “Alarm Responses Tab (Patient)” on page 6-12.

6.1.3 Sidebar Buttons

The following sidebar button is used to expand the functionality of this tab.

Normal Screen

Select the **Normal Screen** sidebar button to return the display to the full screen mode, and close all tabs, message boxes, and dialog boxes.

6.1.4 Troubleshooting

This section lists some of the potential messages and issues that may occur while using the **Patient Alarm Setup** tab.

MESSAGE/ISSUE *	REASON	SOLUTION
Incorrect password. Please try again.	The wrong password was entered in the Password text box.	Select the OK button to close the dialog box. Enter the correct password in the text box.
	The password was entered in the wrong case.	Re-enter the password turning on/off the keyboard dialog Caps Lock key.
Incorrect password. This is your last chance. Please try again	The wrong password was entered two consecutive times in the Password text box.	Select the OK button to close the dialog box. Enter the correct password in the text box.
	The password was entered in the wrong case.	
The Patient Alarm Setup tab closes and the central station is returned to a full screen monitoring display.	The wrong password was entered three consecutive times in the Password text box.	Reopen the Patient Alarm Setup tab and enter the correct password in the text box.

* Messages are shown in all bold text.

6.2 Alarm Limits Tab (Patient)

The patient **Alarm Limits** tab (shown in FIGURE 6-2) adjusts patient alarm limit settings. The alarm limits available will change according to the type of monitoring device assigned to the selected patient tile. The fields discussed in this section may not apply to all users. For additional information regarding alarm limit settings, refer to "Alarms and Events" on page 13-1.

The patient **Alarm Limits** tab is available at the ViewStation (shown in FIGURE 6-3) but is for viewing purposes only. When a patient tile is assigned at the ViewStation, it will always display the alarm limit settings of the associated host central station patient tile.

The patient **Alarm Limits** tab is available at the WorkStation and functions in the same manner as it does at the host central station but contains fewer sidebar buttons. Similar to the central station, alarm limit changes made at the WorkStation will be sent to the central station, View Only Workstation, and bedside monitor (if applicable).

Automatic updating of the alarm limit settings at the remote workstation will also occur when:

- The monitoring device is placed in the Standby mode at the central station
- The monitoring device is not communicating with its host central station (Communications Lost)
- Communication between the host central station and the ViewStation and/or the WorkStation is lost (Central Communications Lost)

WARNING: Changing the patient alarm limits at the WorkStation will automatically change the patient alarm limits at the Panorama Central Station AND the bedside monitor (if applicable) for the selected patient tile.

NOTE: The host central station(s) C-LAN configuration settings and the software installed at the remote location dictates the functionality available for each patient tile. For additional information, refer to "The ViewStation and the WorkStation" on page 2-4.

6.2.1 Accessing the Alarm Limits Tab

From the menu bar, select the **Patient Alarms** button. If the **Patient Alarm Setup** tab is displayed, enter the password in the **Password** text box. The **Alarm Limits** and **Alarm Responses** tabs are displayed.

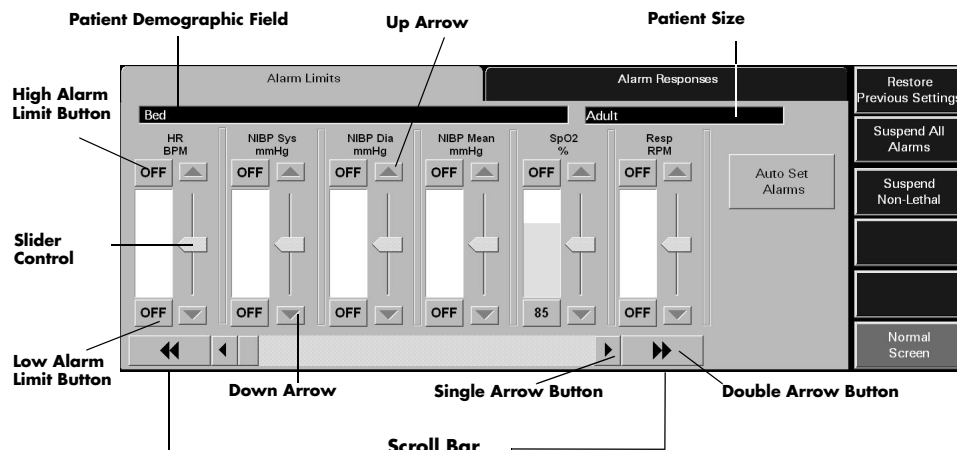

FIGURE 6-2 Alarm Limits Tab

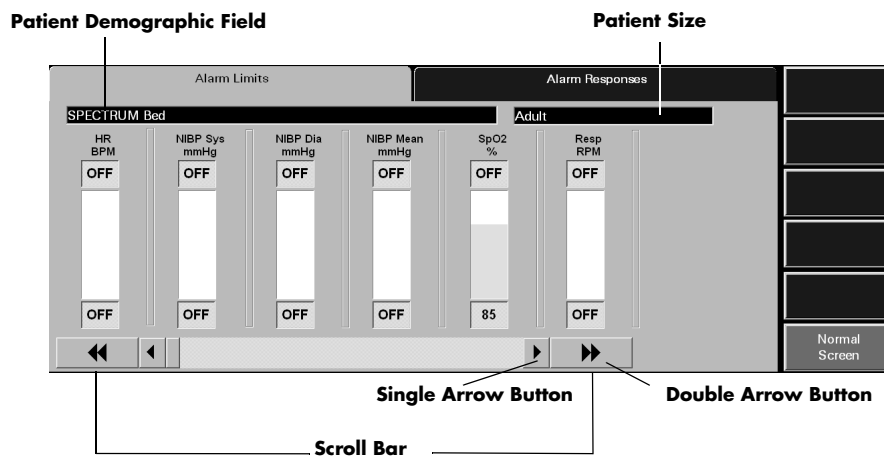

FIGURE 6-3 Alarm Limits Tab (ViewStation)

6.2.2 Configuring Patient Alarm Limits

The following procedure is used for modifying patient alarm limits in the **Alarm Limits** tab. The order in which the alarm slider controls are shown in the **Alarm Limits** tab is selected in the "Unit Priorities Tab" on page 9-47.

ViewStation patient tiles will always display the same patient alarm limit settings of the associated patient tile at the host central station. For additional information regarding the transfer of alarm limit settings from the host central station, refer to "Alarm Limits Tab (Patient)" on page 6-4.

NOTE: The alarm slider controls in the patient Alarm Limits tab are disabled at the ViewStation.

1. Choose a patient tile by selecting its digital data or waveform area.

2. Use the scroll bar or the arrow buttons to locate the parameter to be modified.
 - Double arrow buttons display the next/previous page of parameter slider controls (until the first/last page is reached).
 - Single arrow buttons display the next/previous slider control (until the last control is shown).
3. Set the **High Alarm Limit** button for the selected parameter. This button is either labeled **OFF** or contains an alarm limit value. A high alarm limit is set using the up/down arrow buttons on the parameter's vertical scroll bar or by moving the alarm's slider control.
4. Set the **Low Alarm Limit** button for the selected parameter. This button is either labeled **OFF** or contains an alarm limit value. A low alarm limit is set using the up/down arrow buttons on the parameter's vertical scroll bar or by moving the alarm's slider control.

Alarm limit adjustments made at the Panorama Central Station are automatically sent to the monitoring device.

For additional information regarding the default alarm limit ranges, refer to "Alarms and Events" on page 13-1.

Auto Set Alarms Button

The **Auto Set** button automatically recalculates alarm limit settings to the percent indicated (shown in Table 6-1) above and below the current measured value.

NOTE: The **Auto Set** button does not affect the **SpO₂, ST, PVC, Arrhythmia Run or Apnea Delay** settings.

NOTE: The **Auto Set** button is not available at the **ViewStation**.

TABLE 6-1 Auto Set Percent Indicator

ALARM	PERCENT INDICATOR (APPROXIMATE)
Heart Rate	30%
Respiration	30%
IBP Systolic	20%
IBP Diastolic	20%
IBP Mean	20%
NIBP Systolic	20%
NIBP Diastolic	20%
NIBP Mean	20%
ET CO ₂ (mmHg)	20%
INSP CO ₂ (mmHg)	20%
ET CO ₂ (%)	20%
INSP CO ₂ (%)	20%
ET CO ₂ (kPa)	20%
INSP CO ₂ (kPa)	20%
Temp (F°)	3%
Temp (C°)	3%

TABLE 6-1 Auto Set Percent Indicator (continued)

ALARM	PERCENT INDICATOR (APPROXIMATE)
Delta Temp (F°)	25%
Delta Temp (C°)	25%

6.2.3 Simultaneous Alarm Limit Editing

If using a bedside device with the Panorama Central Station, alarm limit and alarm response configuration changes cannot be made at the bedside monitor, central station, and WorkStation simultaneously. The bedside device will take precedence, followed by the central station, ending with the WorkStation. When an attempt is made to make changes simultaneously, the message **These settings are currently being edited remotely** will be displayed at the central station or WorkStation, depending on where the change was initiated. If there are multiple WorkStations on the network, the first WorkStation that initiates the change will take precedence over any other WorkStation attempting to implement the same change.

These are the scenarios in which this message will be displayed:

- The Alarm Limits Menu is active at the bedside monitor and then the patient **Alarm Limits** tab is opened at the central station or the WorkStation
- The **Alarm Limits** tab is active at the central station or the WorkStation and then the Alarm Limits Menu is opened at the bedside monitor

In both of these scenarios, unsaved changes made in the **Alarm Limits** tab will be discarded.

To close this message dialog, select the **OK** button. Acknowledging this message will convert the **Alarm Limits** tab at the central station to a read-only state and editing will not be permitted. Once the Alarm Limits Menu is closed at the bedside device, the **Alarm Limits** tab will become active again and editing can resume.

For additional information regarding the bedside monitor menus, refer to the bedside monitor's Operating Instructions:

- Passport 2 (P/N 0070-00-0649-XX)
- Passport V (P/N 0070-00-0704-XX)
- Spectrum (P/N 0070-00-0648-XX)
- Spectrum OR (P/N 0070-00-0670-XX)
- DPM 6 (P/N H-046-000184-00)
- DPM 7 (P/N H-046-000186-00)
- V Series (P/N 0070-00-0727-XX)

6.2.4 Sidebar Buttons

The following sidebar buttons are used to expand the functionality of this tab.

Restore Previous Settings

Select the **Restore Previous Settings** sidebar button to return patient display settings to those in use when the tab was opened.

NOTE: The **Restore Previous Settings** sidebar button is not available at the **ViewStation**.

Suspend All Alarms (Optional)

Select the **Suspend All Alarms** sidebar button to suspend, for a user configured period of time, all numeric physiological, lethal arrhythmia, non-lethal arrhythmia, and technical alarms at the Panorama Central Station for the selected patient tile. The **Suspend All Alarms** sidebar button is only shown if the **Suspend Alarms** option is **ON** in the **System Alarms** tab.

WARNING: When the **Suspend All Alarms** sidebar button is enabled, the **Panorama Central Station** will not monitor any lethal or non-lethal arrhythmias and will not display numeric physiological or technical alarms for the selected patient tile.

NOTE: The **Suspend All Alarms** sidebar button is not available at the **ViewStation**.

NOTE: The amount of time an alarm is suspended is dependent on the configured **System Suspend All Timeout** setting.

When the **Suspend All Alarms** sidebar button is selected:

- The **Suspend All Alarms** sidebar button changes to white with black text.
- The **All Alarms Suspended** message displays in red text in the Patient Status line of the patient tile. For additional information regarding the Patient Status line, refer to the "Patient Status Line" on page 2-10.

To resume the monitoring of alarms, select the **Suspend All Alarms** sidebar button.

- When the **Suspend All Alarms** sidebar button is disabled, the button changes to blue with white text. Alarms are now re-enabled for the selected patient.

Suspend Non-Lethal

Select the **Suspend Non-Lethal** sidebar button to suspend all numeric, technical and non-lethal arrhythmia alarms for the selected patient tile. Lethal arrhythmia alarms continue to be monitored at the Panorama Central Station when non-lethal arrhythmia alarms are suspended.

WARNING: When the **Suspend Non-Lethal** alarms sidebar button is enabled, the **Panorama Central Station** will not monitor any priority 2 and priority 3 non-lethal arrhythmias, and will not display numeric physiological or technical alarms for the selected patient tile.

NOTE: The **Suspend Non-lethal** sidebar button is not available at the **ViewStation**.

NOTE: The **Brady** alarm will not be suspended when the **Suspend Non-Lethals** sidebar button is selected.

When the Suspend Non-Lethal button is selected:

- The **Suspend Non-Lethal** sidebar button changes to white with black text.
- The **Non-Lethal Alarms Suspended** message displays in yellow text in the Patient Status line of the patient tile. For additional information regarding the Patient Status line, refer to the "Patient Status Line" on page 2-10.

To resume the monitoring of non-lethal alarms, select the **Suspend Non-Lethal** sidebar button.

- When the **Suspend Non-Lethal** sidebar button is disabled, the button changes to blue with white text. Non-lethal alarms are now re-enabled for the selected patient.

Relearn (Telepack Only)

Select the **Relearn** sidebar button to relearn/refresh ST and Arrhythmia data at the Panorama Central Station.

NOTE: The **Relearn** button is only available when ST and/or arrhythmia analysis is enabled.

NOTE: The **Relearn** sidebar button is not available at the **ViewStation**.

Normal Screen

Select the **Normal Screen** sidebar button to return the display to the full screen mode, and close all tabs, message boxes, and dialog boxes.

6.2.5 Generating a Patient Alarm Report

To review the patient's alarm settings in a report, generate a Patient Alarm Report. This report can be generated directly from the **Alarm Limits** tab by selecting the **Print** menu bar button.

For additional information regarding the Patient Alarm Report, refer to "Patient Alarm Report" on page 8-25.

6.2.6 Testing Alarm Limits

Any alarm may be tested to ensure that it is functioning as intended. To test an alarm:

NOTE: For the purposes of this example, use the **SpO₂ alarm limit slider**. These directions apply to any parameter that uses an alarm slider control.

1. Follow the steps in the "Configuring Patient Alarm Limits" on page 6-5 to access the **Alarm Limits** tab.
2. Scroll to the SpO₂ alarm slider.
3. To trigger the SpO₂ alarm high limit, move the slider to the current value or below the current value to trigger the alarm.
4. To trigger the alarm low limit, move the slider to current value or above the current value to trigger the alarm.
5. Once testing is complete, reset the alarm limit to the desired value.

6.2.7 Troubleshooting

This section lists some of the potential messages and issues that may occur while using the patient **Alarm Limits** tab.

MESSAGE/ISSUE *	REASON	SOLUTION
No Patient Selected!	This message appears in the demographic field when either no patient tile or an empty patient tile has been selected.	Select an active patient tile.
Communications Lost	Communication between the Panorama Central Station and the monitoring device for the selected patient tile has been interrupted.	Verify the connection between the Panorama Central Station and the monitoring device. For example, is the monitoring device out of range?
All of the sidebar buttons (except the Normal Screen button) are disabled.	An empty patient tile is selected.	Select a valid patient tile by touching the digital or waveform area of the patient tile.
All Alarms Suspended	The Suspend All Alarms function is enabled. All numeric physiological, lethal arrhythmia, non-lethal arrhythmia and technical alarm processing for the selected tile has been suspended.	Resume alarm processing by selecting the Suspend All Alarms sidebar button and disabling the Suspend All Alarms function.
Non-Lethal Alarms Suspended	The Suspend Non-Lethal function is enabled. Alarm processing for numeric physiological, technical, and priority 2 and priority 3 non-lethal alarms has been suspended for the selected tile.	Resume alarm processing by selecting the Suspend Non-Lethal sidebar button and disabling the Suspend Non-Lethal function.
These settings are currently being edited remotely.	The Alarm Limits Menu is opened at the bedside monitor while the Alarm Limits tab is active at the central station The Alarm Limits tab is active at the central station and then the Alarm Limits Menu is opened at the bedside monitor.	
The Print menu bar button is disabled.	The message These settings are currently being edited remotely. is displayed.	Select the OK button to close the message box and enable the sidebar button. Close the Alarm Limits menu at the bedside device.
The Suspend All Alarms and Suspend Non-Lethal sidebar buttons are disabled.	The message These settings are currently being edited remotely. is displayed.	Select the OK button to close the message box and enable the sidebar button. Close the Alarm Limits menu at the bedside device.

* Messages are shown in all bold text.

MESSAGE/ISSUE *	REASON	SOLUTION
The patient alarm limits were cleared from the Alarm Limits tab.	The patient size was changed at the bedside monitor.	No solution required. Within 20 seconds, the alarm limits from the bedside will be displayed at the central station.
The Restore Previous Settings sidebar button not functioning.	The previous alarm limits were cleared because the Alarm Limits tab was open while the patient size was changed at the bedside monitor.	No solution required. Within 20 seconds, the alarm limits from the bedside will be displayed at the central station.
The Suspend All Alarms sidebar button is not displayed.	The Suspend Alarms option in the System Alarm Options tab option is set to OFF or Non-Lethal.	If this feature is needed, contact the System Administrator to change the System Alarm Options.
The Suspend Non-Lethals and Suspend All Alarms sidebar buttons are not displayed.	The Suspend Alarms option in the System Alarm Options tab option is set to OFF.	If this feature is needed, contact the System Administrator to change the System Alarm Options.
The Alarm Limits tab is disabled at the WorkStation.	The central station from where the patient tile was networked is configured as View Only.	No solution required.
The Alarm Responses tab is disabled at the WorkStation.	The central station from where the patient tile was networked is configured as View Only.	No solution required.

* *Messages are shown in all bold text.*

6.3 Alarm Responses Tab (Patient)

The **Alarm Responses** tab (shown in FIGURE 6-4 and FIGURE 6-6) is used to adjust the behavior or response of an alarm during an alarm condition.

The **Alarm Responses** tab is available at the ViewStation (shown in FIGURE 6-7) but is for viewing purposes only. When a patient tile is assigned to the ViewStation, it will always display the alarm response settings of the associated host central station patient tile.

The patient **Alarm Responses** tab is available at the WorkStation and functions in the same manner as it does at the host central station but contains fewer sidebar buttons. Similar to the central station, alarm response changes made at the WorkStation, with the exception of the Print on Alarm settings, will be sent to the central station, View Only Workstation, and bedside monitor (if applicable). The Print on Alarm setting is independent of the central station settings or updates.

Automatic updating of the alarm response settings at the remote workstation will also occur when:

- The monitoring device is placed in the Standby mode at the central station
- The monitoring device is not communicating with its host central station (Communications Lost)
- Communication between the host central station and the ViewStation and/or the WorkStation is lost (Central Communications Lost)

NOTE: **The host central station(s) C-LAN configuration settings and the software installed at the remote location dictates the functionality available for each patient tile. For additional information, refer to "The ViewStation and the WorkStation" on page 2-4.**

6.3.1 Accessing the Alarm Responses Tab

1. From the menu bar, select the **Patient Alarms** menu button. If the **Patient Alarm Setup** tab displays, enter the password in the **Password** text box. The **Alarm Limits** and **Alarm Responses** tabs are displayed.
2. Select the **Alarm Responses** tab. The **Alarm Responses** tab is displayed.

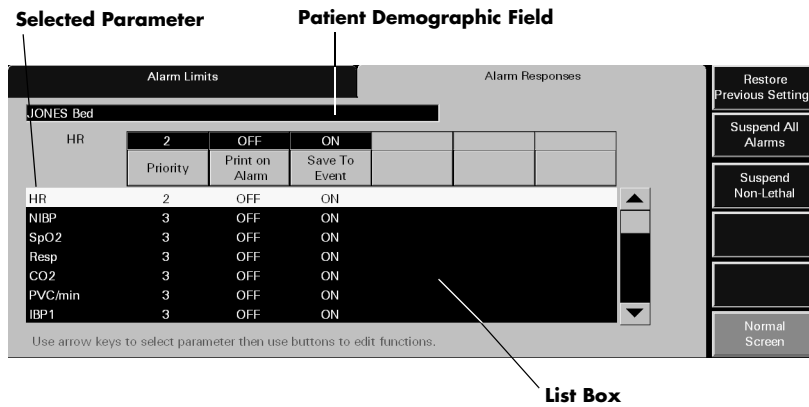

FIGURE 6-4 Alarm Responses Tab (Central Station)

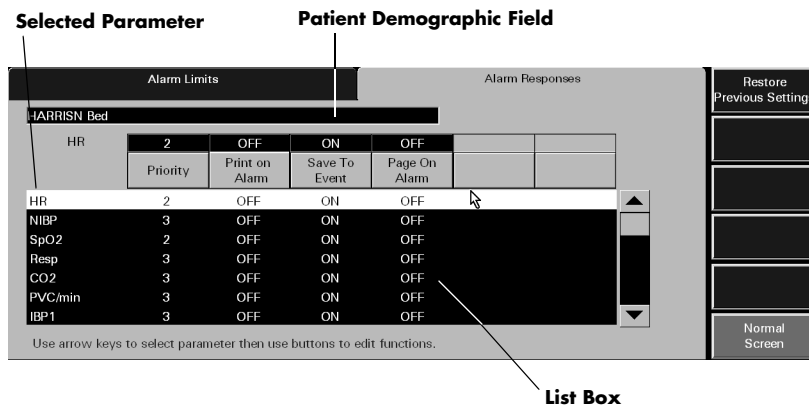

FIGURE 6-5 Alarm Responses Tab (WorkStation)

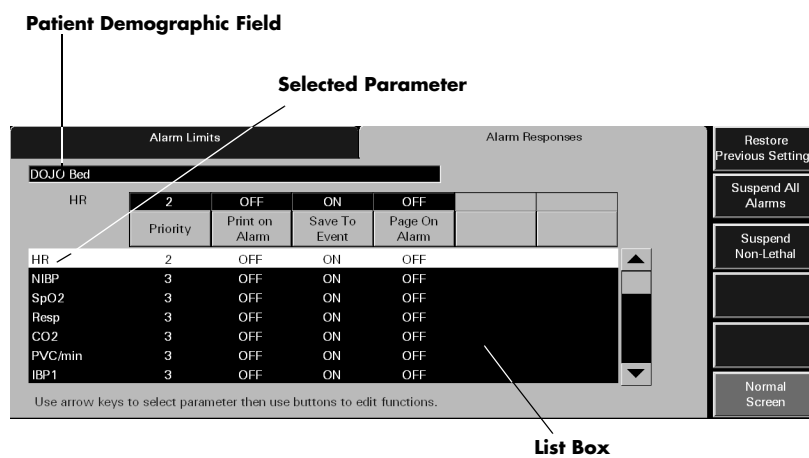

FIGURE 6-6 Alarm Responses Tab - Paging Option Enabled (Central Station)

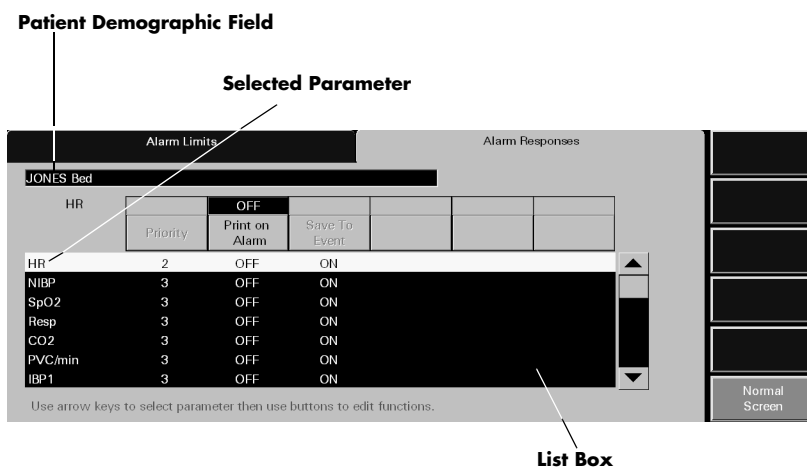

FIGURE 6-7 Alarm Responses Tab (ViewStation)

6.3.2 Configuring Alarm Responses

To configure patient alarm responses at the central station, complete the following:

NOTE: Alarm response changes are effective immediately after the tab is exited.

- Choose a patient tile by selecting its digital data or waveform area.
 - The patient's **Last Name** and **Bed** number are shown in the **Demographics** field, if this information was previously entered in the **Demographics** tab.
- Select the alarm to be modified.
 - The Alarm Responses list box shows the alarms that can be modified.
 - When an alarm is selected, it is shown in white with black text and is shown in the edit box.
- Select the alarm priority for the parameter. To set an alarm priority, select the **Priority** button until the alarm priority setting is shown. Alarm priority is associated with the severity of an alarm condition. It determines the audio and visual indicators that occur during an alarm condition.

Alarm priority settings may include **OFF**, **1**, **2**, and **3**. Each alarm has a predetermined alarm priority settings.

- Priority **1** are the most severe alarms (lethal alarms).
- Priority **2** are alarms of medium severity (most numeric physiological alarms).
- Priority **3** are the least severe alarms (technical alarms).
- Priority **OFF** disables audio feedback for the selected alarm at the Panorama Central Station.

For additional information on alarm behavior, refer to "Alarm Behavior" on page 3-1.

- The **Print on Alarm** button automatically prints alarm data during an alarm condition.
 - The **ON** option automatically prints the alarm events when the alarm condition occurs.
 - The **OFF** option suspends the printing of alarm events during an alarm condition.

5. The **Save To Event** button automatically saves alarm data in the Events database when an alarm condition occurs.
 - The **ON** option automatically saves alarm data during an alarm condition.
 - The **OFF** option does not save alarm data during an alarm condition.

6.3.3 Sidebar Buttons

The following sidebar buttons are used to expand the functionality of this tab.

Restore Previous Settings

Select the **Restore Previous Settings** sidebar button to return patient display settings to those in use when the tab was opened.

NOTE: The **Restore Previous Settings** sidebar button is not available at the **ViewStation**.

Suspend All Alarms (Optional)

Select the **Suspend All Alarms** sidebar button to suspend all numeric physiological, lethal arrhythmia, non-lethal arrhythmia, and technical alarms at the Panorama Central Station for the selected patient tile. The **Suspend All Alarms** sidebar button is only shown if the **Suspend Alarms** option is **ON** in the **System Alarms** tab.

WARNING: When the **Suspend Non-Lethal alarms** sidebar button is enabled, the **Panorama Central Station** will not monitor any **priority 2** and **priority 3** non-lethal arrhythmias, and will not display numeric physiological or technical alarms for the selected patient tile.

NOTE: The **Suspend All Alarms** sidebar button is not available at the **ViewStation** or at the **WorkStation**.

When the **Suspend All Alarms** sidebar button is selected:

- The **Suspend All Alarms** sidebar button changes to white with black text.
- The **All Alarms Suspended** message displays in red text in the Patient Status line of the patient tile. For additional information regarding the Patient Status line, refer to the "Patient Status Line" on page 2-10.

To resume the monitoring of alarms, select the **Suspend All Alarms** sidebar button.

- When the **Suspend All Alarms** sidebar button is disabled, the button changes to blue with white text. Alarms are now re-enabled for the selected patient.

Suspend Non-Lethal

Select the **Suspend Non-Lethal** sidebar button to suspend all numeric, technical and non-lethal arrhythmia alarms for the selected patient tile. Lethal arrhythmia alarms continue to be monitored at the Panorama Central Station when non-lethal arrhythmia alarms are suspended.

WARNING: When the **Suspend Non-Lethal alarms** sidebar button is enabled, the **Panorama Central Station** will not monitor any **priority 2** and **priority 3** non-lethal arrhythmias, and will not display numeric physiological or technical alarms for the selected patient tile.

NOTE: The **Suspend Non-lethal sidebar button** is not available at the **ViewStation** or at the **WorkStation**.

NOTE: The **Brady alarm** will not be suspended when the **Suspend Non-Lethals sidebar button** is selected.

When the Suspend Non-Lethal sidebar button is selected:

- The **Suspend Non-Lethal** sidebar button changes to white with black text.
- The **Non-Lethal Alarms Suspended** message displays in yellow text in the Patient Status line of the patient tile. For additional information regarding the Patient Status line, refer to the "Patient Status Line" on page 2-10.

To resume the monitoring of non-lethal alarms, select the **Suspend Non-Lethal** sidebar button.

- When the **Suspend Non-Lethal** sidebar button is disabled, the button changes to blue with white text. Non-lethal alarms are now re-enabled for the selected patient.

Alarm Setup (Optional)

Select the **Alarm Setup** sidebar button to configure the **ST Alarm Delay** and the **Alarm Delay**, for the selected patient tile, when using a Telepack device.

NOTE: The **Alarm Setup sidebar button** is not available at the **ViewStation**.

To configure alarm delay:

1. Select the **Alarm Setup** button. The **Alarm Setup** dialog box (shown in FIGURE 6-8) is displayed.

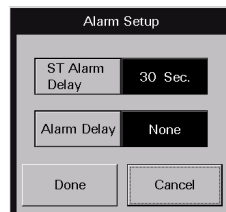

FIGURE 6-8 Alarm Setup Dialog Box

2. Select the **ST Alarm Delay** time period for the selected patient's alarm. ST Alarm Delay is the period of time that the Panorama Central Station delays the notification of an ST alarm. ST Alarm Delay options include 30 seconds, 45 seconds, 1 minute, 90 seconds, 2 minutes and 3 minutes.
3. Select the **Alarm Delay** time period for the selected patient's alarm. Alarm Delay is the period of time that the Panorama Central Station delays the notification of an alarm. Alarm Delay options include None, 1 second, 2 seconds, 3 seconds, 4 seconds, 5 seconds, 6 seconds, 7 seconds and 8 seconds.

NOTE: The **Alarm Delay setting** does not affect the alarm notification for **ST, Apnea, or Arrhythmia**.

NOTE: Changing the alarm delay becomes effective immediately and affects the patient's current alarm delay setting.

4. Select the **Done** or the **Cancel** button.
 - The **Done** button accepts the configured alarm delay settings and returns to the **Alarm Responses** tab.
 - The **Cancel** button discards the configured alarm delay settings and returns to the **Alarm Responses** tab.

Normal Screen

Select the **Normal Screen** sidebar button to return the display to the full screen mode, and close all tabs, message boxes, and dialog boxes.

6.3.4 Troubleshooting

This section lists some of the potential messages and issues that may occur while using the patient **Alarm Responses** tab.

MESSAGE/ISSUE *	REASON	SOLUTION
No Patient Selected!	This message appears in the demographic field when either no patient tile or an empty patient tile has been selected.	Select an active patient tile.
Communications Lost	Communication between the Panorama Central Station and the monitoring device for the selected patient tile has been interrupted.	Check the connection between the Panorama Central Station and the monitoring device. For example is the monitoring device out of range?
All of the sidebar buttons (except the Normal Screen button) are disabled.	An empty patient tile is selected.	Select a valid patient tile by touching the digital or waveform area of the patient tile.
All Alarms Suspended	The Suspend All Alarms function is enabled. All alarm processing for the selected tile has been suspended.	Resume alarm processing by selecting the Suspend All Alarms sidebar button and disabling the Suspend All Alarms function.
Non-Lethal Alarms Suspended	The Suspend Non-Lethal function is enabled. Alarm processing for numeric physiological, technical, and priority 2 and priority 3 non-lethal alarms has been suspended for the selected tile.	Resume alarm processing by selecting the Suspend Non-Lethal sidebar button and disabling the Suspend Non-Lethal function.
The Suspend All Alarms sidebar button is not displayed.	The Suspend Alarms option in the System Alarm Options tab option is set to OFF or Non-Lethal.	If this feature is needed, contact the System Administrator change the System Alarm Options.
The Suspend Non-Lethals and Suspend All Alarms sidebar buttons are not displayed.	The Suspend Alarms option in the System Alarm Options tab option is set to OFF.	If this feature is needed, contact the System Administrator change the System Alarm Options.

* *Messages are shown in all bold text.*

This section describes the tabs that are available when the **VIEW** button is selected from the Panorama Central Station Main Screen.

- Bedside Tab
- Trends Tab
- Events Tab
- Disclosure Tab
- ST Tab

7.1 Bedside Tab

The **Bedside** tab provides an expanded view of the selected patient data. The parameters selected, and the lead set used, determines the data that is displayed in the **Bedside** tab. The data in the **Bedside** tab can be displayed in two different views, the **All Waveforms** view and the **All ECG** view. Both views are discussed in the following sections.

The **Bedside** tab (shown in FIGURE 7-2) is available at the ViewStation and the WorkStation (shown in FIGURE 7-11) and functions in the same manner as it does at the host central station. The **Bedside** tab will display the bedside data from the central station provided the patient tile is in an active state.

7.1.1 Accessing the Bedside Tab

To access the **Bedside** tab (shown in FIGURE 7-1 and FIGURE 7-2), select the **VIEW** button located on the left side of the patient tile.

NOTE: When using a 3-wire lead set with bedside device or a Telepack using a 3-wire or 5-wire lead set, the Bedside tab will always be in the All ECG mode (as shown in FIGURE 7-4).

NOTE: When in the All ECG view, the color of the All ECG sidebar button changes from dark blue with white lettering to white with black lettering. This indicates that this view will continue to display until the All ECG sidebar button is selected again.

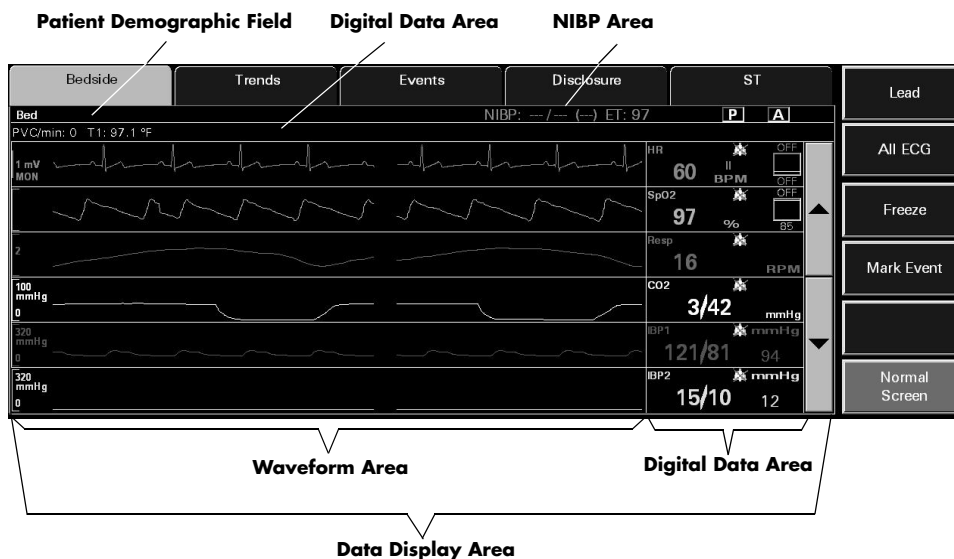

FIGURE 7-1 Bedside Tab - All Waveforms View

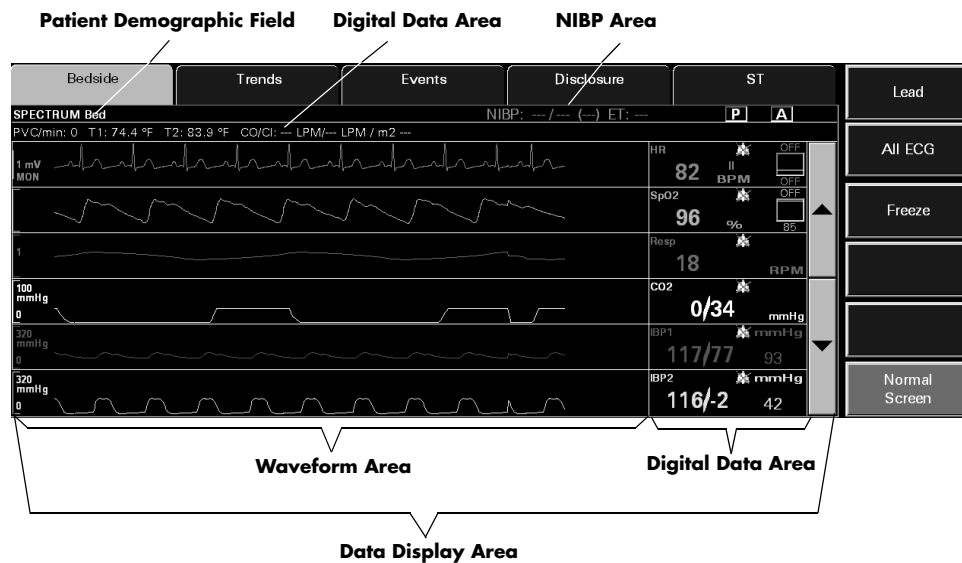

FIGURE 7-2 Bedside Tab - All Waveforms View (ViewStation and WorkStation)

7.1.2 Bedside Tab (All Waveforms View)

The **All Waveforms** view of the **Bedside** tab (shown in FIGURE 7-1 and FIGURE 7-2) displays an expanded view of the selected patient tile.

7.1.2.1 Components of the All Waveforms View



Patient Demographic Field

The patient demographic field displays the last name and bed number of the selected patient, if this data was entered.

NIBP Area

The **All Waveforms** view includes a NIBP area that displays the NIBP systolic, diastolic, mean, and elapsed time when an active patient is selected.

If applicable, the following icons display on the right side of the NIBP area:

-  Indicates that Pacer Enhancement is enabled.
-  Indicates that ST analysis is enabled.
-  Indicates that arrhythmia analysis is enabled.

Digital Data Area

The **All Waveforms** view contains a digital data area that may display the following patient parameters:

- PVC
- Temperature 1
- Temperature 2
- Temperature 3
- Temp Blood
- CO/CI
- CCO/CCI
- CCO STAT/CCI STAT
- SVR
- SVRI
- SVO₂
- ScVO₂
- N₂O

NOTE: The Delta T parameter will not display in the digital data area.

NOTE: The CO/CI, Temp 2, and T Blood parameters are only available if they are being monitored by the DPM6/7 (except CO/CI), V Series, Spectrum/Spectrum OR External Parameter Module (EPM). These parameters are not available if they are monitored by an Edwards Vigilance[®] monitor.

NOTE: The CCO/CCI, SVR, and SVRI parameters are only available if they are being monitored by the DPM6/7 and V Series.

NOTE: The CCO STAT/CCI STAT, SVO₂, ScVO₂, and Temp 3 parameters are only available if they are being monitored by the V Series.

Data Display Area

When in the **All Waveforms** view, the data display area of the **Bedside** tab displays the configured patient parameters in a waveform and digital data tile format. The waveform area of the **Bedside** tab displays in the left portion of the data display area and the digital representation of the waveform displays to the right. In this view, three to six waveforms/digital tiles can be displayed at one time. Parameters experiencing an alarm condition will display a different background color indicating the severity of the alarm. If ST is enabled on the ECG waveform, the digital data section of the **Bedside** tab includes an ST lead label that specifies the lead from which the displayed data is acquired.

The first digital tile always displays one ECG lead along with the patient heart rate (HR). The ECG waveform displayed is the same that is shown in the waveform area of the patient tile. If the selected device is a Telepack with Nonin SpO₂ module and the **All Waveforms** view is displayed, the SpO₂ waveform will always be positioned after the patient heart rate. When the selected device is a bedside monitor, the other waveforms/digital tiles represent the available waveforms for the selected patient tile. The waveforms/digital tiles that appear in the **Bedside** tab are based on the parameters configured at the patient monitoring device.

The order in which the subsequent waveforms display is determined by the order defined in the **Unit Priorities** tab. The color associated with the waveforms/digital tiles is determined by the configured parameter color defined in the **System Setup** tab. A unit of measure label and an alarm status bell icon for each parameter also displays in the digital portion of the display area. The color of the waveform/digital tiles is determined by the configured parameter color.

7.1.2.2 Navigating in the All Waveforms View

If the waveforms exceed the capacity of the viewable screen, use the navigational buttons to locate the desired waveform. The buttons are described as follows:

- The up arrow button moves the group of displayed waveforms up one position within the ordered set of waveforms
- The down arrow button moves the group of displayed waveforms down one position within the ordered set of waveforms

7.1.2.3 Performing ECG Waveform Measurements

ECG waveform measurements for time and amplitude can be performed in the **All Waveforms** view by using the Measure dialog box (shown in FIGURE 7-3).

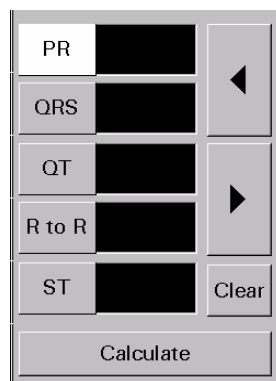

FIGURE 7-3 Measure Dialog Box

The Measure dialog box can only be accessed once the **Freeze** sidebar button has been selected. When the **Freeze** sidebar button is selected, the **All ECG** sidebar button is replaced with the **Measure** sidebar button.

When the Measure dialog box is first accessed, it contains five interval buttons. Once an interval button is selected, two changes occur:

- Navigational buttons and the **Clear** and **Calculate** buttons are displayed in the Measure dialog box
- Reference and measurement lines are displayed in the **Bedside** tab waveform area

The navigational buttons displayed depend on the selected interval. The left and right arrow buttons are available when using the PR, QRS, QT, and R to R intervals. The up and down arrow buttons are available when using the ST interval.

Vertical Measurements (Time)

1. Select either the PR, QRS, QT, or R to R intervals. A dashed vertical reference line is placed to the left of the solid vertical reference line.

NOTE: Adjustments can be made to both the solid vertical reference line and/or the vertical dashed reference line. Selecting the interval button a second time toggles between the two reference lines. When a reference line is active, it blinks/ flashes on the screen.

2. Adjust the location of the vertical reference line as follows:
 - For coarse adjustments, select the desired location on the touch screen. The reference line will move to that point.
 - For fine adjustments, use the left/right arrow buttons to position the reference line at the desired point.
3. Once the vertical reference line appears in the desired location, select the **Calculate** button. The measurement populates the text box beside the selected interval.
 - If another vertical measurement is desired, select another interval button.
 - To delete a measurement, select the interval button that needs to be to reset, then select the **Clear** button.

Horizontal Measurements (Amplitude)

1. Select the ST interval. A dashed horizontal reference line is placed above the solid horizontal reference line.

NOTE: Adjustments can be made to both the horizontal solid reference line and/or the horizontal dashed reference line. Selecting the interval button a second time toggles between the two reference lines. When a reference line is active, it blinks/ flashes on the screen.

2. Adjust the location of the dashed, horizontal reference line as follows:
 - For coarse adjustments, select the desired location on the touch screen. The reference line will move to that point.
 - For fine adjustments, use the up/down arrow buttons to position the reference line at the desired point.
3. Once the dashed, horizontal reference line appears in the desired location, select the **Calculate** button. The measurement populates the text box beside the ST interval.
 - If another horizontal measurement is desired, select another interval button.

- To delete the ST measurement, select the ST interval button, then select the **Clear** button.

7.1.2.4 Sidebar Buttons

The following sidebar buttons are used to expand the functionality of this view.

Lead

Select the **Lead** sidebar button to cycle through each of the waveforms in the ECG ordered set. The **Lead** sidebar button is not available when using a:

- Telepack device with a 3 or 5-wire lead set
- Telepack with Nonin SpO₂ module with a 3-wire lead set

All ECG

Select the **All ECG** sidebar button to change to the **All ECG** view of the **Bedside** tab. The **Bedside** tab remains in the **All ECG** view until the **All ECG** button is selected again. The **All ECG** sidebar button is not available when using a:

- Telepack device with a 3 or 5-wire lead set
- Telepack with Nonin SpO₂ module with a 3-wire lead set

For additional information about the **All ECG** view, refer to the “Bedside Tab (All ECG View)” on page 7-9.

Freeze

Select the **Freeze** sidebar button to halt the updating of digital parameter data and waveforms currently displayed in the **Bedside** tab. The **Bedside** tab remains frozen until the **Freeze** sidebar button is selected again. Freezing the **Bedside** tab does not affect the waveform or any real time alarms in the upper half of the Normal Screen.

When the **Freeze** sidebar button is selected, the **All ECG** sidebar button is replaced by the **Measure** sidebar button.

Measure

Select the **Measure** sidebar button to activate the Measure dialog box (shown in FIGURE 7-3). The Measure dialog contains reference and measurement lines to measure the time and amplitude of an ECG waveform. For additional information regarding ECG waveform measurements, refer to "Performing ECG Waveform Measurements" on page 7-11.

Mark Event

Select the **Mark Event** sidebar button to save the current data to the Event database as a ‘Central User Marked Event.’ This can be useful for noting such things as the time when a medication was administered.

NOTE: **The Mark Event sidebar button is not available at the ViewStation or the WorkStation.**

Normal Screen

Select the **Normal Screen** sidebar button to return the display to the full screen mode, and close all tabs, message boxes, and dialog boxes.

7.1.3 Generating an All Strips Report

To review a patient’s real-time data, generate an All Strips Report. This report can be generated directly from the **Bedside** tab by selecting the **Print** menu bar button.

For additional information regarding the All Strips Report, refer to the “All Strips Report” on page 8-2.

7.1.3.1 Troubleshooting

For **All Waveforms** view troubleshooting information, refer to "Troubleshooting" on page 7-12.

7.1.4 Bedside Tab (All ECG View)

The **Bedside** tab **All ECG** view displays all the ECG waveforms available based on the lead set currently in use.

7.1.4.1 Accessing the All ECG View

To access the **All ECG** view (shown in FIGURE 7-4), select the **All ECG** sidebar button from the **Bedside** tab **All Waveforms** view.

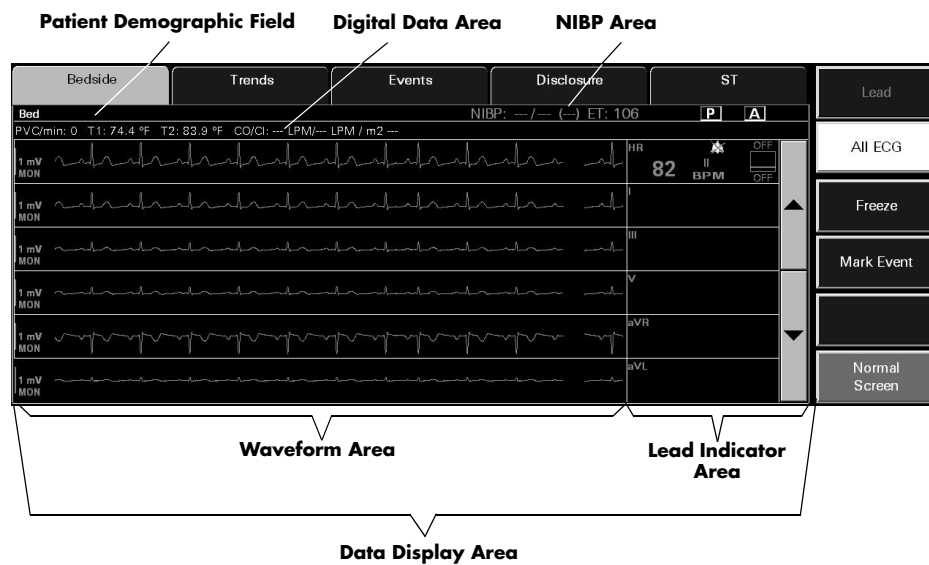

FIGURE 7-4 Bedside Tab - All ECG View (Central Station)

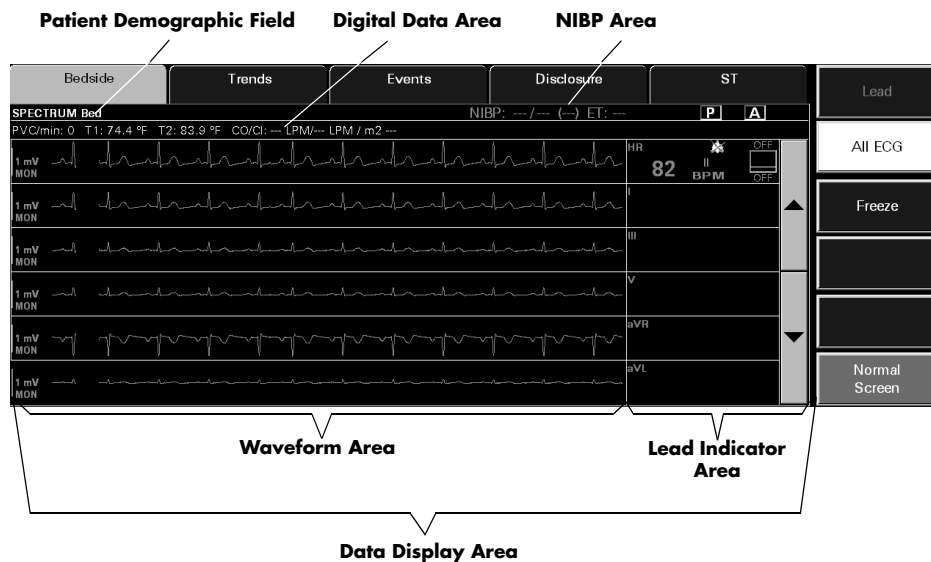

FIGURE 7-5 Bedside Tab - All ECG View (ViewStation and WorkStation)

7.1.4.2 Components of the All ECG View

Patient Demographic Field

The description of this field was previously described on page 7-3.

NIBP Area

The description of this area was previously described on page 7-3.

Digital Data Area

The description of this area was previously described on page 7-4.

Data Display Area

When in the **All ECG** view, the waveform area of the **Bedside** tab displays all the ECG waveforms based on the lead set currently in use. The waveform area of the **Bedside** tab displays in the left portion of the data display area and the ECG lead indicator displays to the right.

The first digital tile displays one ECG lead along with the patient heart rate (HR). The ECG waveform displayed is the same waveform shown in the waveform area of the patient tile, except when a View 12™ card is in use. In this case, the first waveform displayed will always be ECG Lead I. When a 3 or a 5-wire lead is used, the ECG lead that appears in the first waveform position is selected from the **Display** tab. The other waveforms/lead tiles represent the available waveforms/leads for the selected patient tile. The order in which the subsequent waveforms appear is based on the order specified by the ordered set. The waveforms/lead tiles that appear are based on the lead set currently in use.

7.1.4.3 Navigating in the All ECG View

If the waveforms exceed the capacity of the viewable screen, use the navigational buttons to locate the desired waveform. The buttons are described as follows:

- The up arrow button moves the group of displayed waveforms up one position within the ordered set of waveforms
- The down arrow button moves the group of displayed waveforms down one position within the ordered set of waveforms

When a View 12™ card is in use, the double up arrow/down arrow can be used to navigate:

- The double up arrow button displays the previous set of ECG waveforms
- The double down arrow button displays the next set of ECG waveforms

7.1.4.4 Performing ECG Waveform Measurements

ECG waveform measurements for time and amplitude can be performed in the **All ECG** view by using the Measure dialog box (shown in FIGURE 7-3). For additional information about performing waveform measurements, refer to “Performing ECG Waveform Measurements” on page 7-5.

7.1.4.5 Sidebar Buttons

The sidebar buttons available in this view are the same as the sidebar buttons described in the **All Waveforms** view. Please refer to page 7-7 for a full description of each of the sidebar buttons.

7.1.4.6 Troubleshooting

This section lists some of the potential messages and issues that may occur while using the either of the **Bedside** tab views.

MESSAGE/ISSUE*	REASON	SOLUTION
A waveform parameter is not displayed.	If the waveform parameter exists, it has not been scrolled into view on the display.	Use the navigation buttons or View More sidebar button to scroll to the desired parameter waveform.
	The waveform parameter is not being monitored at the bedside.	Connect the sensor(s) for the waveform parameter to the patient.
NIBP/Digital Data area empty	No equipment is assigned to the selected tile.	Assign a monitoring device to the patient tile.
	Patient is in the "Panorama Standby Only" mode	Remove patient from Panorama Standby Only by selecting the Resume Monitoring button in the Standby tab.
	Patient is in the "Bedside and Panorama Standby Only" mode	Remove patient from Bedside and Panorama Standby Only by pressing the STANDBY button on front panel of the bedside monitoring device.
	Selected tile is in the Discharge state.	Retrieve discharged patient.
(for NIBP area only)	The equipment assigned to the selected tile does not support the NIBP parameter.	Assign a monitoring device that supports NIBP to the selected tile.
Up arrow/down arrow button is not available or is disabled	View 12™ card is in use	Use double up/down arrow button to navigate
	There are less than six waveforms available.	
Double up arrow/down arrow button is not available	View 12™ card is not in use	
First waveform position not affected when navigation up/down arrow button is used	The first waveform is not affected by the navigational buttons.	
Lead/All ECG sidebar button is unavailable	No equipment is assigned to the selected tile.	Assign a monitoring device to the patient tile.
	Patient is in the "Panorama Standby Only" mode.	Remove patient from Panorama Standby Only by selecting the Resume Monitoring button in the Standby tab.
	Patient is in the "Bedside and Panorama Standby Only" mode.	Remove patient from Bedside and Panorama Standby Only by pressing the STANDBY button on front panel of the monitoring device.
	Selected tile is in the Communications Lost state or Discharge state.	Verify connection to central stations and/or retrieve discharged patient.

MESSAGE/ISSUE*	REASON	SOLUTION
	Selected device is a Telepack with a 3 or 5-wire lead set.	
	Selected device is a Passport 2, Passport V, Spectrum, DPM6/7, or V Series with a 3 or 5-wire lead set.	
	Bedside tab is in the All ECG display or Freeze mode.	Select the All ECG sidebar button to change to the Normal display mode.
Lead sidebar button is disabled	The selected device is a: <ul style="list-style-type: none"> • Telepack device with a 3 or 5-wire lead • Telepack with Nonin SpO₂ module attached with a 3-wire lead set 	No solution required.
	The All ECG sidebar button is latched.	Select the All ECG sidebar button to enable the Lead sidebar button.
Buttons in Measure dialog box are unavailable	Interval is not selected.	Select an interval.
The Print menu bar button is disabled.	The patient tile is in the Bedside and Panorama Standby mode.	If necessary, remove the patient tile from this mode.
	The patient tile is in the Panorama Standby Only mode.	If necessary, remove the patient tile from this mode.
	The patient tile is in the Communications Lost state.	Restore communications with the bedside monitor.
	The patient tile is in a Waiting for Patient state.	Restore communications with the bedside monitor.

7.2 Trends Tab

The **Trends** tab provides access to a patient's trended digital data. Trend data is automatically displayed in one minute intervals unless an alternate Trend Display interval was selected. If the **Trends** tab is selected before the first interval is reached, or before the first NIBP, CO/CI, or PAWP measurement occurs, the list will be empty. All previously collected parameter data will be displayed, even if the parameter is not currently being monitored.

The monitoring device, utilized parameters, and configured settings determines the data that is displayed in the **Trends** tab. The configured trend display settings determine at what interval the trends data will be displayed in the **Trends** tab.

The **Trends** tab is available at the ViewStation and the WorkStation and functions in the same manner as it does at the host central station. The **Trends** tab will display the trend data from the central station provided the patient file is communicating with the central station.

A patient's trended digital data can be viewed in two formats, either as a list, or graphically. Both views are discussed in the following sections.

7.2.1 Accessing the Trends Tab

1. Select the **VIEW** button on the desired patient file. The **Bedside** tab is displayed.
2. Select the **Trends** tab. The **Trends** tab is displayed in the **List** view (shown in FIGURE 7-6).

Patient Demographic Field

Patient Demographic Field										Graphic	
Bedside	Trends	Events	Disclosure	ST							
Bed											
Date / Time	HR BPM	NIBP mmHg	S/D (Mean) mmHg	SpO2 %	Resp RPM	CO2 In/Ex mmHg	PVC/min	IBP1 mmHg	S/I mmHg		Trend Display
06/24 03:50 PM	83	---	(--)	ET:---	96	18	0/34	0		117/7	
06/24 03:49 PM	82	---	(--)	ET:---	96	18	0/34	0		117/7	
06/24 03:48 PM	83	---	(--)	ET:---	96	18	0/34	0		117/7	
06/24 03:47 PM	82	---	(--)	ET:---	96	18	0/34	0		117/7	
06/24 03:46 PM	83	---	(--)	ET:---	96	18	0/34	0		117/7	
06/24 03:45 PM	82	---	(--)	ET:---	96	18	0/34	0		117/7	
06/24 03:44 PM	83	---	(--)	ET:---	96	18	0/34	0		117/7	
06/24 03:43 PM	82	---	(--)	ET:---	96	18	0/34	0		117/7	
06/24 03:42 PM	83	---	(--)	ET:---	96	18	0/34	0		117/7	
06/24 03:41 PM	82	---	(--)	ET:---	96	18	0/34	0		117/7	
<div style="display: flex; justify-content: space-between; align-items: center;"> Old Data Page Down Scroll Down Previous Event Next Event Scroll Up Page Up New Data </div>											Normal Screen

FIGURE 7-6 Trends Tab - List View (Central Station, ViewStation, and WorkStation)

7.2.2 Trends Tab (List View)

The **List** view of the **Trends** tab (shown in FIGURE 7-6) provides a list of all of the trended digital data for the selected patient and is displayed first when the **Trends** tab is accessed. Each trend record is displayed as a row in the list, in descending chronological order. The most recent trend record appears at the top.

When the **List** view of the **Trends** tab is selected, the top row in the list is highlighted. Each trend record's date and time display in the first column. All subsequent columns display parameter data in the order that was specified in the **Unit Priorities** tab. For additional information, refer to "System Setup Functions" on page 9-1.

If a priority 1 physiological alarm condition existed for a parameter during the time of trend record storage, that parameter's data will be highlighted in red.

If a priority 2 or 3 physiological alarm condition existed for a parameter during the time of trend record storage, that parameter's data will be highlighted in yellow.

7.2.2.1 Components of the List View

Patient Demographic Field



The patient demographic field displays the last name and bed number of the selected patient, if this data was entered.

7.2.2.2 Navigating in the List View

If the **List** view exceeds the capacity of the viewable screen, use the navigational buttons and scroll bars to locate the desired parameter data.

Scrolling through the List

There are three methods of scrolling through the list rows:

- Use the New Data button  or the Old Data button , both located below the horizontal scroll bar, to display the most current or the oldest trend records filtered to the current Trend display settings for the selected patient.
- Use the Page Down (double down-arrow) and Page Up (double up-arrow) buttons, located below the horizontal scroll bar, to scroll through one page of the list at a time.
- Use the up and down arrows, located below the horizontal scroll bar, for single row scrolling.

Scrolling through the Parameters

Use the left and right arrows of the horizontal scroll bar for single parameter scrolling or drag the scroll box to move quickly through the parameters.

Previous Event Button

Select the **Previous Event** button to locate and highlight the previous event condition that occurred **before** the currently highlighted row.

Next Event Button

Select the **Next Event** button to locate and highlight an event that occurred **after** the currently highlighted trend in the list box.

7.2.2.3 Configuring a Trend Display Interval

Select the **Trend Display** sidebar button to configure the interval at which a patient's trend data will be displayed. Regardless of which Trend Display interval is selected, NIBP, CO/CI, and PAWP trend records will be displayed.

ViewStation and WorkStation patient tiles will initially display the same trend interval settings of the associated patient tile at the host central station. For additional information regarding the transfer of trend interval settings from the host central station, refer to the "Trends Tab" on page 7-14.

The default setting for a Trend Display interval is determined by the **Unit Choices** tab. For additional information regarding the **Unit Choices** tab, refer to "Unit Choices Tab" on page 9-50.

NOTE: Trends data is automatically stored in one minute intervals. The Trend Display interval selected does not affect how trend information is stored in the database, just how it is displayed.

NOTE: Changing the trend display setting in the List Trend tab automatically adjusts the trend display setting in the Display tab. Changing the trend display setting in the Display tab automatically adjusts the trend display setting in the List Trend tab.

To select the Trend Display interval:

1. From the **Display** tab, select the **Trend Display** sidebar button. The Trend Display dialog box (shown in FIGURE 7-7) is displayed.

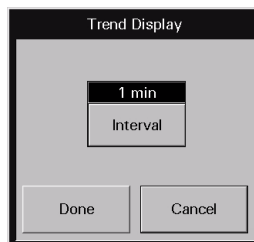

FIGURE 7-7 Trend Display Dialog Box

2. Select the **Interval** button until the desired interval period is displayed. Interval periods include 1 minute, 5 minutes, 10 minutes, 15 minutes, 30 minutes, 1 hour, and 2 hours.
3. Select the **Done** or the **Cancel** button.
 - The **Done** button accepts the selection.
 - The **Cancel** button discards the selection, closes the dialog box, and returns to the **Display** tab.

With the exception of NIBP, CO/CI and PAWP, selecting the **Done** button will change the Trend Display interval in the Trends tab based on the standard clock time intervals. Refer to the following table:

INTERVAL	TREND RECORDS DISPLAYED IN TRENDS TAB
1 minute	All trend records will be displayed.
5 minute	All trend records having a timestamp of 0, 5, 10, 20, 25, 30, 35, 40, 45, 50, and 55 minutes will be displayed.
10 minute	All trend records having a timestamp of 0, 10, 20, 30, 40, and 50 minutes will be displayed.
15 minute	All trend records having a timestamp of 0, 15, 30, and 45 minutes will be displayed.
30 minutes	All trend records having a timestamp of 0 and 30 minutes will be displayed.
1 hour	All trend records having a timestamp of 0 minutes (for example, 12:00, 1:00, 2:00) will be displayed.
2 hour	All trend records having a timestamp of 0 minutes for even hours only (for example, 12:00, 2:00, 4:00) will be displayed.

7.2.2.4 Printing a Trend List Report from the List View

Multiple hours of trend data can be printed to a Trends List Report directly from **List** view.

To indicate the time interval for printing this report:

1. From the **List** view, select the **Print** menu bar button. The Print Selection dialog box (shown in FIGURE 7-8) is displayed.

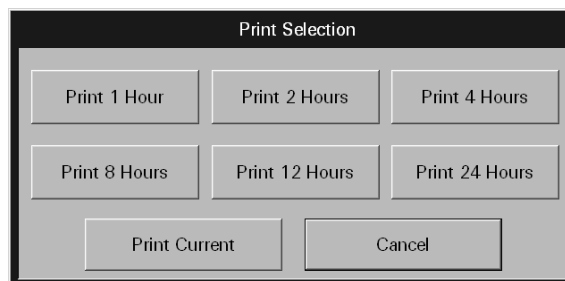

FIGURE 7-8 Print Selection Dialog Box

2. Select the **Print Current** button, a time interval button, or the **Cancel** button.
 - Select the **Print Current** to create a one page Trend List Report.
 - Select one of the time interval buttons. The choices are print 1 hour, 2 hours, 4 hours, 8 hours, 12 hours, and 24 hours.

3. Select the **Cancel** button to close the dialog box without generating the print request. For additional information regarding this report, refer to "Trend List Report" on page 8-17.

7.2.2.5 Sidebar Buttons

The following sidebar buttons are used to expand the functionality of this view.

Graphic

Select the **Graphic** sidebar button to open the **Graphic** view of the **Trends** tab. For additional information regarding the **Graphic** view, refer to "Accessing the Graphic View" on page 7-20.

Trend Display

This sidebar button was previously described on page 7-16.

Normal Screen

Select the **Normal Screen** sidebar button to return the display to the full screen mode, and close all tabs, message boxes, and dialog boxes.

7.2.2.6 Troubleshooting

This section lists some of the potential messages and issues that may occur while using the **List** view of the **Trends** tab.

MESSAGE/ISSUE *	REASON	SOLUTION
There is no data in the List view of the Trends tab.	A patient has not been admitted to the selected tile.	Admit a patient to the selected tile or choose a tile that already has an admitted patient.
	The Trends tab was selected before the first interval was reached or before the first NIBP measurement occurred.	Wait until the first interval is reached or until the first NIBP measurement occurs.
A column of parameter data is not displayed.	If the column of parameter data exists, it has not been scrolled into view on the display.	Use the scroll bar located along the bottom of the Trend list to scroll to the desired parameter column.
	The parameter has not been monitored for this patient.	Connect the sensor(s) for the parameter to the patient.
No more data found (Page Down Button)	There is no data in the Trend database because the Trends tab was selected before the first interval was reached or before the first NIBP measurement occurred.	Wait until the first interval is reached or until the first NIBP measurement occurs.
	The last row in the list is already highlighted.	Select the OK button to close the message box and return to the List view of the Trends tab.
No more data found (Page Up Button)	There is no data in the Trend database because the Trends tab was selected before the first interval was reached or before the first NIBP measurement occurred.	Wait until the first interval is reached or until the first NIBP measurement occurs.
	The first row in the list is already highlighted.	Select the OK button to close the message box and return to the List view of the Trends tab.

* Messages are shown in all bold text.

MESSAGE/ISSUE *	REASON	SOLUTION
No more data found (Previous Event Button)	There is no event data in the Trend database. None of the rows that are below the currently highlighted row contain a parameter with an event condition. The last row in the list is already highlighted.	Wait until an event is recorded to the Trend database. Select the OK button to close the message box and return to the List view of the Trends tab. Select the OK button to close the message box and return to the List view of the Trends tab.
No more events found (Next Event Button)	There is no event data in the Trend database. None of the rows that are above the currently highlighted row contain a parameter with an event condition. The first row in the list is already highlighted.	Wait until an event is recorded to the Trend database. Select the OK button to close the message box and return to the List view of the Trends tab. Select the OK button to close the message box and return to the List view of the Trends tab.
The Graphic and Trend Display sidebar buttons are disabled.	There is no data in the Trend database because the Trends tab was selected before the first interval was reached or before the first NIBP measurement occurred. A patient has not been admitted to the selected tile. The Trends List data is still loading. The Print Selection dialog box is open.	Wait until the first interval is reached or until the first NIBP measurement occurs. Admit a patient to the selected tile or choose a tile that already has an admitted patient. Wait for the Trends List data to finish loading. Close the Print Selection dialog box.
The Print menu bar button is disabled.	The trends data is loading.	Wait until the trends data is loaded.

* *Messages are shown in all bold text.*

7.2.3 Trends Tab (Graphic View)

The **Graphic** view of the **Trends** tab (shown in FIGURE 7-9) provides a graphical representation of all of the trended digital data for a selected patient. All previously collected data is displayed, even if the parameter is not currently being monitored.

The **Graphic** view for each parameter includes a range bar, plot area and parameter area for the selected time. A maximum of three parameters can be scrolled into the viewable area of the display.

When the **Graphic** view is displayed, a movable reference line, that crosses the three available plot areas, is initially placed at the same date/time as the row (trend record) that was highlighted in the **List** view. The trend record data that is displayed in the parameter area is defined by the location of the reference line.

The **Graphic** view is available at the ViewStation and the WorkStation and functions in the same manner as it does at the host central station.

7.2.3.1 Accessing the Graphic View

1. Select the **VIEW** button on the desired patient tile. The **Bedside** tab is displayed.
2. Select the **Trends** tab. The **Trends** tab is displayed in the **List** view.
3. Select the **Graphic** sidebar button. The **Trends** tab is displayed in the **Graphic** view.

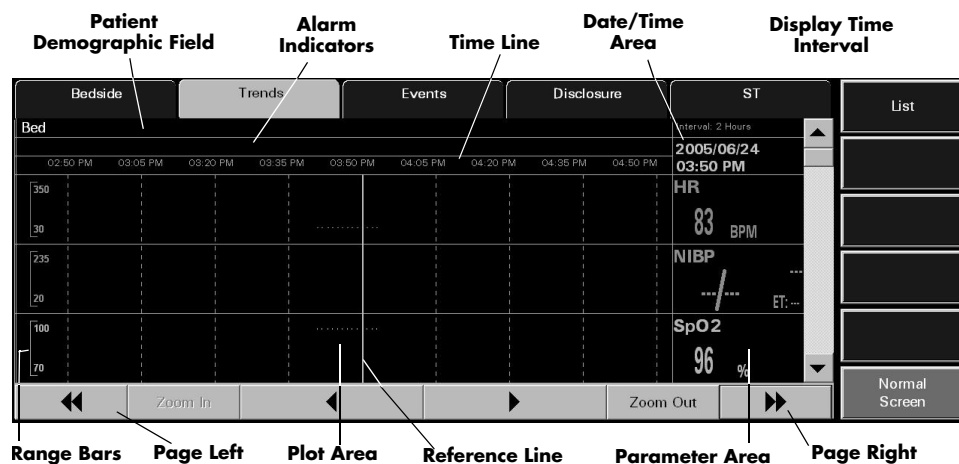

FIGURE 7-9 Trends Tab - Graphic View (Central Station, ViewStation, and WorkStation)

7.2.3.2 Components of the Graphic View

Patient Demographic Field

The patient demographic field displays the last name and bed number of the selected patient, if this data was entered.

Alarm Indicator Area

Vertical lines that are displayed in the alarm indicator area denote the time at which an alarm occurred. The color of each vertical line in the alarm indicator area denotes the priority of the alarm.

Date/Time Area

The date/time area indicates the date and time associated with the location of the reference line.

Display Time Interval

The display time interval is the current setting for the viewable snapshot and is one page of the **Graphic** view. When the **Graphic** view opens, the default display time interval is two hours.

Time Line

The time line displays nine equally spaced time values based on the display time interval.

Range Bars

The range bar for each parameter, except Heart Rate, is displayed with the maximum and minimum values for that parameter.

For Heart Rate, the minimum and maximum scale is automatically adjusted based on the range of values displayed at the time, also considering the current zoom level and time range. The minimum scale value for Heart Rate is 10 bpm less than the lowest displayed value in the current view; the maximum scale value for Heart Rate is 10 bpm greater than the highest displayed value in the current view.

Each range bar is displayed in the color of the parameter as described in the **Parameter Color** tab.

Plot Areas

The plotted trend records are displayed in the following format:

- One plotted point for single sensor parameters
- A line connecting the inspired value and end tidal value for dual sensor parameters
- A line connecting the systolic and diastolic values and a single dot for the mean value for multi-sensor parameters

Each plotted trend record is displayed in the color of the parameter as described in the Parameter Color Tab.

Parameter Areas

The trend record data that is displayed in the parameter area is defined by the location of the reference line. For parameters that have experienced an alarm event, the background color of the parameter area is based on the alarm priority at the time of trend record storage.

If there is no data at the location of the reference line, the parameter areas will display the parameter label and/or the unit of measurement.

7.2.3.3 Navigating in the Graphic View

Scrolling through the Parameters

A vertical scroll bar is located along the right side of the parameter area. The up and down arrows on the scroll bar can be used for single parameter scrolling or the bar can be dragged to move quickly through a large number of parameters.

Scrolling through the Time Line

There are two methods of scrolling through the time line:

- Use the left arrow button to move the reference line to the previous trend record on the time line and the right arrow button to move the reference line to the next trend record on the time line.
- Use the Page Left (double left-arrow) button to scroll to the previous page and the Page Right (double right-arrow) button to scroll to the next page. Increments are based on the display time interval.

Zoom In Button

The **Zoom In** button decreases the display time interval to a minimum of 2 hours, in two hour increments.

Zoom Out Button

The **Zoom Out** button increases the display time interval to a maximum of 8 hours, in two hour increments.

7.2.3.4 Sidebar Buttons

The following sidebar buttons are used to expand the functionality of this view.

List

Select the **List** sidebar button to return to the **List** view of the **Trends** tab.

Normal Screen

Select the **Normal Screen** sidebar button to return the display to the full screen mode, and close all tabs, message boxes, and dialog boxes.

7.2.4 Generating a Graphic Trend Report

To review the trends for the selected patient tile in a graphical format, generate a Graphic Trend Report. This report can be generated directly from the **Trends** tab by selecting the **Print** menu bar button.

For additional information regarding the Graphic Trend Report, refer to the "Graphic Trend Report" on page 8-47.

7.2.4.1 Troubleshooting

This section lists some of the potential messages and issues that may occur while using the **Graphic** view of the **Trends** tab.

MESSAGE/ISSUE *	REASON	SOLUTION
There is no trend data in the display.	A patient has not been admitted to the selected tile.	Admit a patient to the selected tile or choose a tile that already has an admitted patient.
	The Trends tab was selected before the first interval was reached or before the first NIBP measurement occurred.	Wait until the first interval is reached or until the first NIBP measurement occurs.
The parameter areas only display the parameter label and/or the unit of measurement.	There is no data at the location of the cursor line.	Move the cursor line to a point on the time line where data is known to exist.
No more data found (Page Left Button)	There is no data in the Trend database because the Trends tab was selected before the first interval was reached or before the first NIBP measurement occurred.	Wait until the first interval is reached or until the first NIBP measurement occurs.
	The first recorded data has been reached. No further data exists before this time.	Select the OK button to close the message box and return to the Graphic view of the Trends tab.
No more data found (Page Right Button)	There is no data in the Trend database because the Trends tab was selected before the first interval was reached or before the first NIBP measurement occurred.	Wait until the first interval is reached or until the first NIBP measurement occurs.
	The most recent recorded data has been reached. No further data exists after this time.	Select the OK button to close the message box and return to the Graphic view of the Trends tab.
Time out of range (Zoom In Button)	The minimum display time interval has been reached.	Select the OK button to close the message box and return to the Graphic view of the Trends tab.
Time out of range (Zoom Out Button)	The maximum display time interval has been reached.	Select the OK button to close the message box and return to the Graphic view of the Trends tab.
Time out of range (Left Arrow Button)	The minimum display time interval has been reached.	Select the OK button to close the message box and return to the Graphic view of the Trends tab.
Time out of range (Right Arrow Button)	The maximum display time interval has been reached.	Select the OK button to close the message box and return to the Graphic view of the Trends tab.
The List sidebar button is disabled.	A message box is being displayed.	Close the message box.

* *Messages are shown in all bold text.*

7.3 Events Tab

The **Events** tab lists all the events for a selected patient file. The monitoring device, utilized parameters, and configured settings determine the events that are saved in the **Events** list. All previously collected data is displayed, even if the parameter is not being monitored.

NOTE: **If a lethal arrhythmia alarm condition exists, and a transition to a different lethal arrhythmia alarm condition occurs, a new event will be stored and a printout will be generated, as configured.**

The **Events** tab is available at the ViewStation and the WorkStation (shown in FIGURE 7-11) and functions in the same manner as it does at the host central station, with the exception of the delete event buttons. The **Events** tab will display the event data from the central station, provided the patient tile is communicating with the central station.

The **Events** tab displays events in two formats, either as a list, or as a waveform. Both views are discussed in the following sections.

7.3.1 Accessing the Events Tab

1. Select the **VIEW** button on the desired patient tile. The **Bedside** tab is displayed.
2. Select the **Events** tab. The **Events** tab is displayed in the **List** view (shown in FIGURE 7-10).

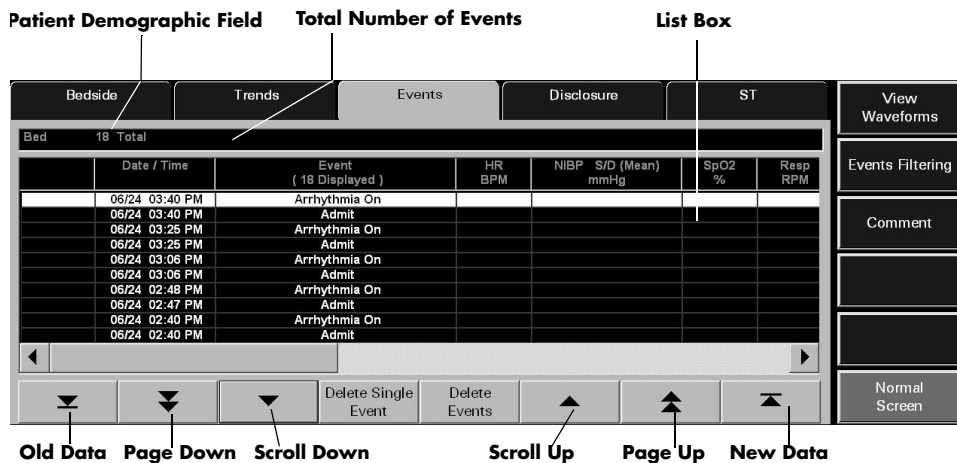

FIGURE 7-10 Events Tab - List View

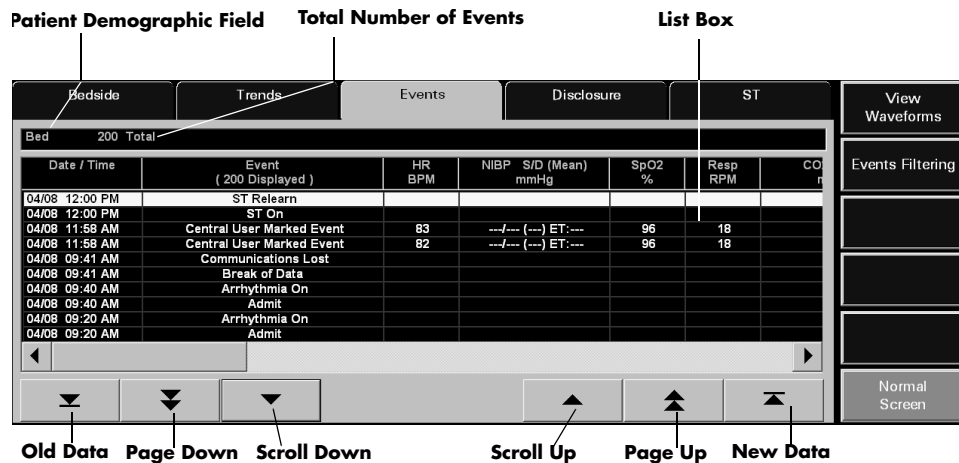

FIGURE 7-11 Events Tab - List View (ViewStation and WorkStation)

7.3.2 Events Tab (List View)

The **List** view lists all the events for the selected tile in a column format. Each event record is displayed as a row in the list, with the most recent filtered event record at the top of the list. The remaining events display in descending chronological order. For additional information regarding events filtering, refer to “Events Filtering” on page 7-32.

7.3.2.1 Components of the List View

Patient Demographic Area

The **List** view patient demographic area will display the last name and bed number of the selected patient, if this data was entered. In addition, the total number of events currently in the Events database will display beside the patient demographic information.

Events Tab List Box Area

The **List** view displays each event record as a row in the list box. The list box is capable of displaying a maximum of 1000 rows at one time. If the 1000 row maximum is reached, and new events occur, the oldest events will automatically be deleted from the Events database.

When the **List** view is first selected, the top row in the list will be highlighted. The event record date and time is displayed in the first column, the event description is displayed in the second column, and the heart rate (HR) is displayed in the third column (shown in FIGURE 7-10). All subsequent columns display parameter data in the order specified in the **Unit Priorities** tab.

NOTE: **All previously collected parameter data is displayed in the Events tab list box, even if the parameter is not currently being monitored.**

Alarm Indicators



If there was an alarm associated with an event, the specific parameter value will be highlighted in the Event list. For example, if a Priority 1 physiological or bedside alarm condition existed for a parameter at the time of event record storage, that parameter's data is highlighted in red. If a Priority 2 or 3 physiological or bedside alarm condition existed for a parameter at the time of event record storage, that parameter's data is highlighted in yellow.

7.3.2.2 Navigating in the List View

If the **List** view list exceeds the capacity of the viewable screen, use the navigational buttons and scroll bars to locate the desired parameter data.

Scrolling through the List

There are three methods of scrolling through the list rows:

- Use the New Data button  or the Old Data button , both located below the horizontal scroll bar, to display the most current or the oldest events for the selected patient.
- Use the Page Down (double down-arrow) and Page Up (double up-arrow) buttons, located below the horizontal scroll bar, to scroll through one page of the list at a time.
- Use the up and down arrows, located below the horizontal scroll bar, for single row scrolling.

Scrolling through the Parameters

Use the left and right arrows of the horizontal scroll bar for single parameter scrolling or drag the scroll box to move quickly through the parameters.

7.3.2.3 Deleting Event Records

Remove event records from the **List** view by selecting the **Delete Single Event** button and/or the **Delete Events** button.

Delete Single Event Button

Select the **Delete Single Event** button to remove a single event record from the **List** view.

NOTE: **The Delete Single Event button is not available at the ViewStation or the WorkStation.**

To delete a single event record:

1. From the **List** view, select the event record to be deleted.
2. Select the **Delete Single Event** button. A confirmation dialog box is displayed.
3. Select **Yes** or **No**.
 - The **Yes** button deletes the event record. The event record is removed from the **Events** list.

NOTE: **If the Events List is open at the ViewStation or WorkStation when the host central station confirmation dialog box "Yes" button is selected, the message "Events were deleted from the database. Press the OK button to refresh the list." will be displayed at the ViewStation or the WorkStation.**

- The **No** button does not delete the event.

NOTE: **Not all event records can be deleted. Refer to the “Alarms and Events” chapter for more information regarding which events cannot be deleted.**

Delete Events Button

Select the **Delete Events** button to remove multiple events from the **List** view. Events are deleted from the first selected event downward, towards the older events. For example, to delete the five most recent events in the list, select the first event in the list, then select the **Delete Events** button. Verify the number of events to delete is correct, then select the **Delete** button.

NOTE: **The Delete Events button is not available at the ViewStation or the WorkStation.**

To delete multiple events:

1. From the **List** view, select the first event to be deleted.
2. Select the **Delete Events** button. The **Delete Events** dialog box (shown in FIGURE 7-12) is displayed.



FIGURE 7-12 Delete Events Dialog Box

3. Select the **0** in the **Number Of Events** text box. The keypad dialog box is displayed.
4. Use the numeric keypad to enter the number of events to delete (between 1-50), then select the **OK** button. The numeric keypad closes and the Delete Events dialog box is displayed.
5. Select the **Delete** or **Cancel** button.
 - Select the **Delete** button to remove the events.
 - Select the **Cancel** button to close the dialog box and leave the **Events** list unmodified.
6. Selecting the **Delete** button prompts a confirmation box to display.
 - Select the **Yes** button to delete the event records. The event records are removed from the **Events** list.

NOTE: **If the Events List is open at the ViewStation or WorkStation when the host central station confirmation dialog box “Yes” button is selected, the message “Events were deleted from the database. Press the OK button to refresh the list.” will be displayed at the ViewStation or the WorkStation.**

- Select the **No** button to close the dialog box and leave the **Events** list unmodified.

NOTE: Not all event records can be deleted. Refer to the “Alarms and Events” chapter for more information regarding which events cannot be deleted.

7.3.2.4 Refreshing the List View

Depending on the event type, the event may not be displayed in the **List** view until the list is regenerated or refreshed. To refresh the **List** view, select any neighboring tab, such as the Disclosure or ST tabs, then reselect the **Events** tab. This will refresh the **List** view so it will display the most current events.

7.3.3 Event Filtering

The **Events** tab provides an event filter as a means of controlling the events displayed in the **List** view. Filters can be configured based on time and on parameters. Since the Event list contains historical data, the event filter is available even when the patient tile is experiencing a **Communications Lost** condition or is in a **Panorama Standby Only** or **Bedside and Panorama Standby** mode.

The initial central station event filter settings come from the System Event Filter settings, if settings were configured. ViewStation and WorkStation patient tiles will initially display the same event filter settings of the associated patient tile at the host central station. For additional information regarding the transfer of event filter settings from the host central station, refer to the “Trends Tab” on page 7-14.

7.3.3.1 Accessing the Events Filter

To access the events filter, select the **Events Filtering** sidebar button from the **Events** tab **List** view.

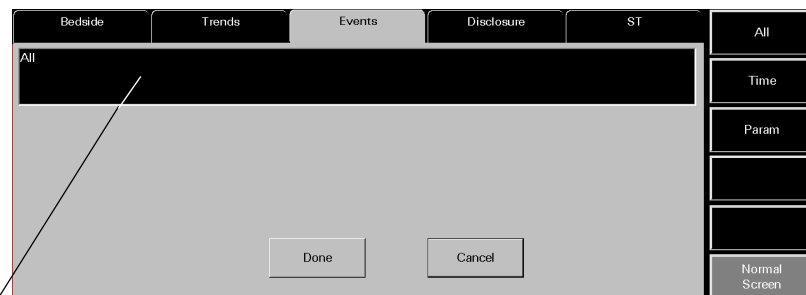

Event Filter Text Box

FIGURE 7-13 Event Tab (Events Filtering)

7.3.3.2 Components of the Events Filter

Event Filter Text Box

The Event Filter text box is where the selected filter settings are displayed. Upon admission, the Event Filter text box lists “All” as the filter. This means that the events (maximum of 1000) for the selected patient tile will be displayed in the **Events** tab. Event filters can be configured based on time and/or parameters.

Done Button

Select the **Done** button to close the **All Event Filter** view and display the **Events** tab with the configured filter settings.

Cancel Button

Select the **Cancel** button to close the **All Event Filter** view and display the **Events** tab with the previously configured filter settings.

7.3.3.3

Time Filters

By indicating a start time and an end time, the view will only include events within the configured time period.

Accessing the Time Filter

To access the Time Filter (shown in FIGURE 7-14), select the **Time** sidebar button from the **Events Filter** view. If any previously selected time ranges were specified, they will be displayed in the Event Filter text box beside the **Time:** label, and in the Start Time and End Time text boxes.

FIGURE 7-14 Time Event Filter

Clearing Time Filters

To remove previously entered time filters, select the **Clear** button from the **Time Filter** view.

Configuring a Time Filter

To enter a start time:

1. Select the Start Time text box. The Start Time dialog box (shown in FIGURE 7-15) is displayed.

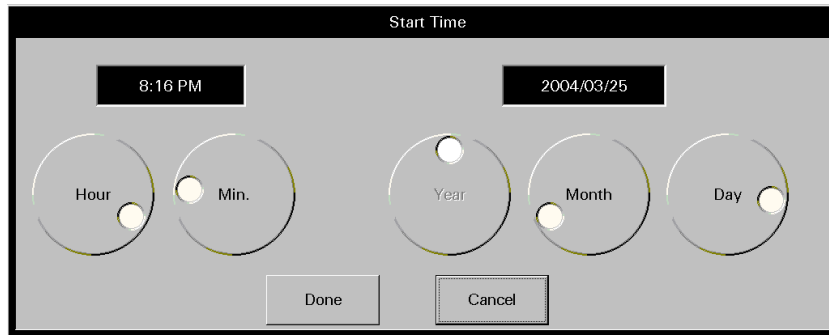

FIGURE 7-15 Start Time Dialog Box

2. Rotate the dial controls to select the hour and minute values.
3. Rotate the dial controls to select the month, day and year values. Refer to the following value ranges.

TIME FRAME	RANGE
Month	Month range to be inclusive within the limits of the oldest event to the most recent event in the selected patient tile's Events database.
Day	Day range to be inclusive within the limits of the oldest event to the most recent event in the selected patient tile's Events database.
Year	Year range to be inclusive within the limits of the oldest event to the most recent event in the selected patient tile's Events database.

4. Accept or reject the selection made in the **Start Time** dialog box.
 - The **Done** button accepts the selections. When the **Done** button is selected, the date and time selected populates the Start Time text box, End Time text box, and the Event Filter text box.
 - The **Cancel** button discards the selections, closes the dialog box, and returns to the **Time Event Filter** view.

To enter an end time:

1. Select the End Time text box. The End Time dialog box (shown in FIGURE 7-16) is displayed.

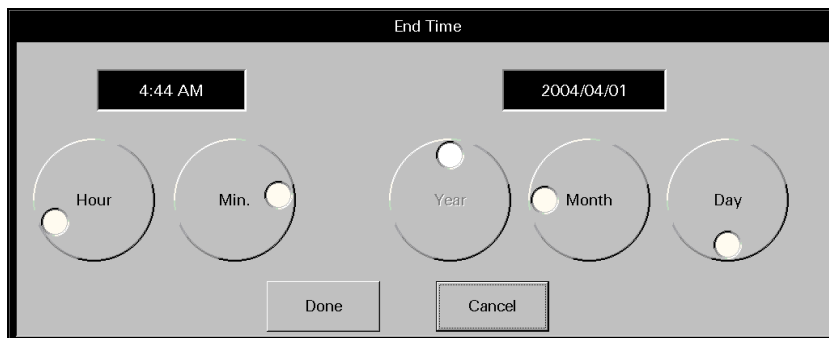

FIGURE 7-16 End Time Dialog Box

- To enter the end time, follow steps 2, 3, and 4 from the previous section (entering a Start Time).

7.3.3.4

Parameter Filters

By selecting specific parameters, the **Events** tab will only display the events that contain the chosen parameter. Parameter filters can be configured for physiological and technical events. The physiological events listed are dependent on the assigned monitoring device and the technical events listed are dependent on the ECG lead wire set currently in use.

Accessing the Parameter Filter

To access the Parameter Filter (shown in FIGURE 7-17), select the **Param** sidebar button from the **All Events** view. By default, the physiological events are shown first. If any previously selected parameters were specified, they will be displayed in the Event Filter text box beside the **Param:** label.

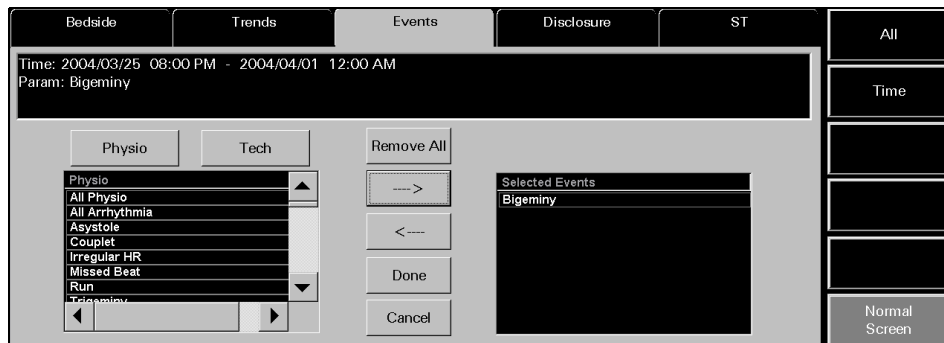

FIGURE 7-17 Parameter Event Filter View

Configuring a Parameter Filter

To configure a parameter filter:

- If a technical event filter is needed, select the **Tech** button.

NOTE: By default, the physiological events are displayed when the **Param** sidebar is selected.

- Move/remove the selected events by using any of the buttons described in the following table:

BUTTON	FUNCTION
Remove All	Removes all the events listed in the Selected Events list box and from the Event Filter text box.
Add/Right Arrow	Adds the selected event to the Selected Events list box, and to the Event Filter text box.
Remove/Left Arrow	Removes the chosen event from the Selected Events list box and from the Event Filter text box.
NOTE:	A maximum of five physiological and/or technical events may be added to the Selected Events list at one time.

3. Select the **Done** button to apply the selected event filter and return to the **List** view or select the **Cancel** button to restore the previously chosen filter settings.

7.3.3.5 Printing an Events List Report from the List View

Multiple hours of event data can be printed to an Events List Report directly from the **List** view.

To indicate the time interval for printing this report:

1. From the **List** view, select the **Print** menu bar button. The Print Selection dialog box (shown in FIGURE 7-8) is displayed.
2. Select the **Print Current** button, a time interval button, or the **Cancel** button.
 - Select the **Print Current** to create a one page Trend List Report.
 - Select one of the time interval buttons. The choices are print 1 hour, 2 hours, 4 hours, 8 hours, 12 hours, and 24 hours.
3. Select the **Cancel** button to close the dialog box without generating the print request.

For additional information about this report, refer to the "Event List Report" on page 8-21.

7.3.3.6 Sidebar Buttons

The following sidebar buttons can be used to expand the functionality of this view.

View Waveforms

For additional information regarding the functionality of this sidebar button, refer to "Accessing the Waveforms View" on page 7-34.

Events Filtering

For additional information regarding the functionality of this sidebar button, refer to "Event Filtering" on page 7-28.

Normal Screen

Select the **Normal Screen** sidebar button to return the display to the full screen mode, and close all tabs, message boxes, and dialog boxes.

7.3.3.7 Troubleshooting

This section lists some of the potential messages and issues that may occur while using the **List** view of the **Events** tab.

MESSAGE/ISSUE *	REASON	SOLUTION
Sidebar buttons disabled when Events tab selected.	Patient tile not selected.	Select a patient tile.
	There is no patient admitted to the selected tile.	Admit a patient to the tile.
No patient in the tile	There is no patient admitted to the selected tile.	Admit a patient to the tile.
	Patient tile not selected.	Select a patient tile.

* Messages are shown in all bold text.

MESSAGE/ISSUE *	REASON	SOLUTION
No data in Events list.	Patient tile not selected.	Select a patient tile.
	None of the existing event data meets the criteria of the current event filter.	Change the event filter.
	There is no patient admitted to the selected tile.	Admit a patient to the tile.
Events list column headers not displayed.	Patient tile not selected.	Select a patient tile.
	There is no patient admitted to the selected tile.	Admit a patient to the tile.
The View Waveform and Events Filtering sidebar buttons are disabled.	The Events List is empty or none of the existing event data meets the criteria of the current event filter.	Change the event filter.
	There is no patient admitted to the selected tile.	Admit a patient to the tile.
Some items cannot be deleted.	Specific types of events cannot be removed from the Event list.	Refer to the Alarms and Events chapter.
Events were deleted from the database. Press the OK button to refresh the list.	This message will appear if the Events List is open at the ViewStation or WorkStation when an event is deleted from the host central station Events database.	Select the OK button.
The Print menu button is disabled.	The event data is loading.	Wait until the event data is loaded.
Events are filtered but an event filter was not created.	A system event filter may have been created.	Contact the System Administrator to see if a system event filter exists.

* *Messages are shown in all bold text.*

7.3.4 Events Tab (Waveforms View)

The **Waveforms** view (shown in FIGURE 7-18) of the **Events** tab displays waveform data for the selected patient. In order for the event to display in the **Waveforms** view, there must be waveform data associated with the event. Physiological alarm events and 'marked events' are stored as waveform data. All previously collected data is displayed, even if the parameter is not currently being monitored.

7.3.5 Accessing the Waveforms View

1. Select the **VIEW** button on the desired patient tile. The **Bedside** tab is displayed.
2. Select the **Events** tab. The **List** view is displayed.
3. Select a physiological alarm event or marked event (for example, High Heart Rate Alarm) from the **List** view for the selected patient, then select the **View Waveforms** sidebar button. The selected event is displayed in the **Waveforms** view (shown in FIGURE 7-18).

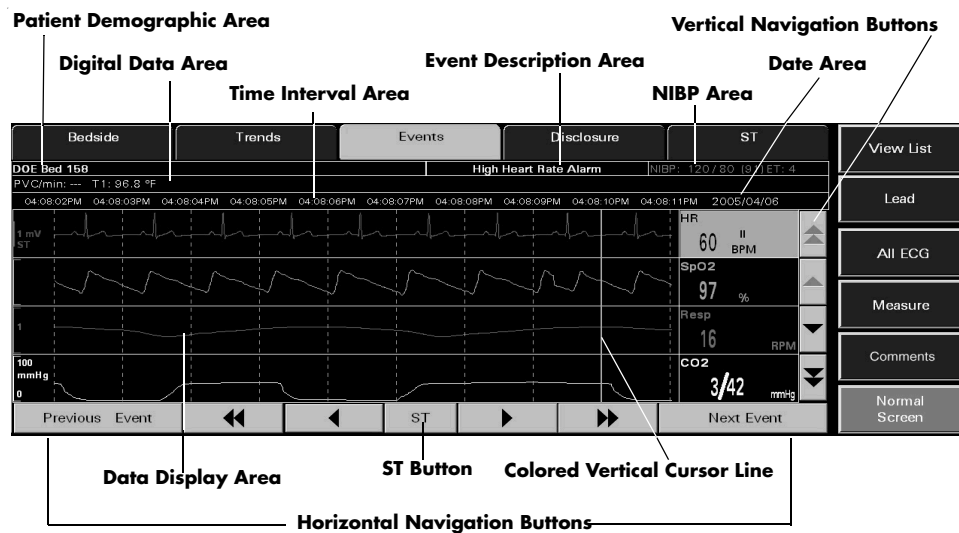

FIGURE 7-18 Waveforms View of the Events Tab

7.3.5.1 Components of the Waveforms View

Patient Demographic Area

The patient demographic area displays the patient's last name and bed number, if available.

Digital Data Area

The following seven (7) parameters can display in the digital data area depending on the bedside monitor configuration.

- PVC/min
- Temperature 1
- Temperature 2
- Temperature 3
- T Blood
- N2O
- CO/CI
- CCO/CCI
- CCO STAT/CCI STAT
- SVR
- SVRI
- SVO₂
- ScVO₂
- PAWP

NOTE: The Temperature 1, Temperature 2, Temperature 3 (V Series only), and T Blood parameters are only displayed when they are used in the calculation of the Delta Temperature parameter.

Time Interval Area

The time interval area is displayed in one second intervals. A total of nine seconds can be viewed on the screen at one time. Each second shown displays a time label over each one-second grid line in the waveform area.

Event Description Area

The event description area displays the event that was selected in the **Event List** view. For example, a High Heart Rate Alarm.

NIBP Area

The NIBP area displays the NIBP systolic pressure, diastolic pressure, mean pressure, and elapsed time.

Date Area

The date area indicates the date the event occurred and was stored in the Events database.

Data Display Area

If data is available, the **Waveforms** view displays 20 seconds of waveform data. The initial **Waveforms** view displays the first nine seconds of waveform data before the alarm was triggered, and can display three to four waveforms and/or digital data tiles at one time.

Colored Vertical Cursor Line

The colored vertical cursor line extends from the first waveform to the last waveform on the display. The colored vertical cursor line can be moved to indicate the specific time within the event.

7.3.5.2 Navigating in the Waveforms View of the Events Tab

Navigating in the **Waveforms** view is accomplished by using buttons. When the **Waveforms** view is first opened, the colored vertical cursor line will be positioned in the far right position.

Vertical Navigation Buttons

Double Up Arrow Button

Select the **double up arrow** push button to display the previous page of waveforms in the ordered set. This button will be disabled if the first waveform in the ordered set is already visible in the data display area.

Up Arrow Button

Select the **up arrow** button to move the group of waveforms displayed up one position within the set of available waveforms. This button will be disabled if the first waveform in the ordered set is already visible in the data display area.

Double Down Arrow Button

Select the **double down arrow** button to display the next page of waveforms in the ordered set. This button will be disabled if the last waveform in the ordered set is already visible in the data display area.

Down Arrow Button

Select the **down arrow** button to move the group of waveforms displayed down one position within the ordered set of available waveforms. This button will be disabled if the last waveform in the ordered set is already visible in the data display area.

Horizontal Navigation Buttons

Previous Event Button

Select the **Previous Event** to locate and display an event that occurred earlier than the current event time began. This button will be disabled when there are no more events that have a time less than the current event time.

Double Left Arrow Button

Select the **double left arrow** button to display the previous nine seconds of event data, provided this data was collected. This button will be disabled if the vertical cursor is positioned at the beginning of the stored data for the event.

Left Arrow Button

Select the **left arrow** button to move the colored vertical cursor line one second back in time. This button will be disabled if the vertical cursor is positioned at the beginning of the stored data for the event.

Right Arrow Button

Select the **right arrow** button to move the colored vertical cursor line one second forward in time. This button will be disabled if the vertical cursor is positioned at the end of the stored data for the event.

Double Right Arrow Button

Select the **double right arrow** button to display the next nine seconds of event data, provided this data was collected. This button will be disabled if the vertical cursor is positioned at the end of the stored data for the event.

Next Event Button

Select the **Next Event** button to locate and highlight an event that occurred **after** the currently highlighted event in the list box.

7.3.5.3

ST Button

Select the **ST** button to open the **Waveforms** view ST dialog box.

Waveforms View ST Dialog Box

The **Waveforms** view ST dialog box (shown in FIGURE 7-19) displays the current and reference values for all the leads where ST was performed during the selected event. The number of leads that display in this dialog box is dependent on the number of leads used during the event. If the ST option has been enabled, the ST button will be enabled even if ST is not currently being monitored. If ST was never enabled for the patient tile, the ST button will be disabled.

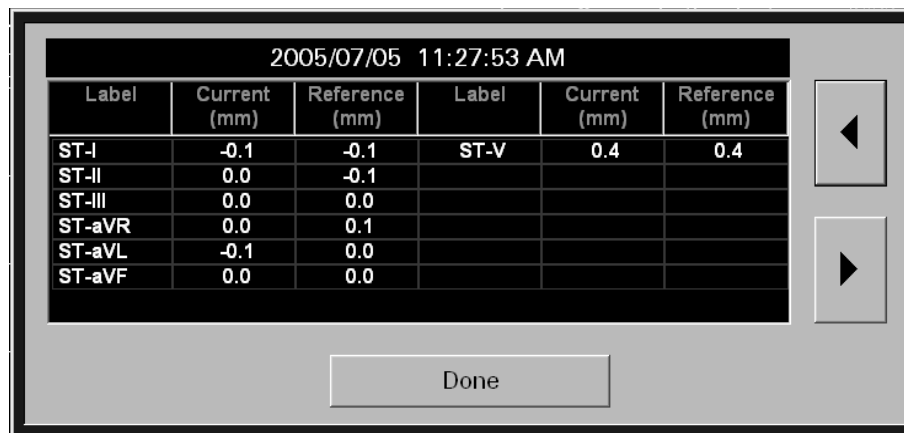

2005/07/05 11:27:53 AM					
Label	Current (mm)	Reference (mm)	Label	Current (mm)	Reference (mm)
ST-I	-0.1	-0.1	ST-V	0.4	0.4
ST-II	0.0	-0.1			
ST-III	0.0	0.0			
ST-aVR	0.0	0.1			
ST-aVL	-0.1	0.0			
ST-aVF	0.0	0.0			

FIGURE 7-19 Waveforms View ST Dialog

Date and Time Text Area

The date/time text area, located at the top of the **Waveforms** view ST dialog, displays the date and time the ST data displayed was acquired. When the ST dialog box navigation buttons (moving forward or backward in time) are used, this area will be updated to reflect the date and time of the ST data currently displayed in the dialog box.

Left Arrow Button

Select the **left arrow** button to view the ST data for the previous second of the event.

Right Arrow Button

Select the **right arrow** button to view the ST data for the next second of the event.

Done Button

Select the **Done** button to close the **Waveforms** view ST dialog.

7.3.5.4 Comments Dialog Box (Optional)

With the addition of system-wide paging, a paging notification can be sent to clinicians to alert them that a specific event type has occurred. If a page was sent for a selected event in the **Waveforms** view, an asterisk (*) will appear beside the event in the event description area (shown in FIGURE 7-18). The paging information related to the event can be viewed by selecting the **Comments** sidebar button. The Comments dialog box will display either a **Page Sent** or a **Page Failed** message. If the selected event does not have an asterisk beside the event description, this indicates that a page has not been sent for the selected event. In this case, the **Comments** sidebar button will be disabled.

7.3.5.5 Sidebar Buttons

The **Waveforms** view may contain up to six sidebar buttons.

View List

Select the **View List** sidebar button to return to the **Events** list.

Lead

Select the **Lead** sidebar button to cycle through each of the waveforms in the ECG lead ordered set. The **Lead** sidebar button is not available when using a:

- Telepack device with a 3 or 5-wire lead set
- Telepack with Nonin SpO₂ module with a 3-wire lead set

All ECG

Select the **All ECG** sidebar button to access the All ECG mode of the **Events** tab. When the **All ECG** button is white, this indicates the **Events** tab is in the All ECG mode. The **Waveforms** view remains in the **All ECG** mode until the **All ECG** sidebar button is selected again. The **All ECG** sidebar button is not available when using a:

- Telepack device with a 3 or 5-wire lead set
- Telepack with Nonin SpO₂ module with a 3-wire lead set

NOTE: If a 5-wire or 12-lead set was previously used for the selected patient, the All ECG sidebar push button will always be enabled.

Measure

Select the **Measure** sidebar button to activate the Measure dialog box (shown in FIGURE 7-3). The Measure dialog contains reference and measurement lines to calculate the time and amplitude of an ECG waveform. For instructions on the use of the Measure button, refer to “Performing ECG Waveform Measurements” on page 7-5.

NOTE: The Print menu bar will be enabled when the Measure dialog box is open.

Comments (Optional)

This sidebar button was previously described in the “Comments Dialog Box (Optional)” on page 7-38. If the Paging feature is unavailable at the central station, the **Comments** sidebar button will not be displayed.

Normal Screen

Select the **Normal Screen** sidebar button to return the display to the full screen mode, and close all tabs, message boxes, and dialog boxes.

7.3.5.6 Printing an Event Zoom In Report from the Waveforms View

To print a Event Zoom In Report from the **Waveforms** view, select the **Print** button from the menu bar (shown in FIGURE 2-1).

7.3.5.7 Troubleshooting

This section lists some of the potential messages and issues that may occur while using the **Waveforms** view of the **Events** tab.

MESSAGE/ISSUE *	REASON	SOLUTION
Sidebar buttons disabled when Events tab selected.	Patient tile not selected. There is no patient admitted to the selected tile.	Select a patient tile. Admit a patient to the tile.
No patient in the tile	There is no patient admitted to the selected tile. Patient tile not selected.	Admit a patient to the tile. Select a patient tile.
No Waveform data is collected for this event.	The selected event is not a physiological alarm event.	Refer to the Alarms and Events chapter.
The correct alarmed event is selected from the List view but no waveform is displayed in View Waveforms view.	A 3-lead wire set is being used and the active lead was changed from when the event originally occurred.	Return to the lead that was active when the event occurred, then try to view the waveform again.

* Messages are shown in all bold text.

MESSAGE/ISSUE *	REASON	SOLUTION
Events were deleted from the database. Press the OK button to refresh the list.	When viewing a patient tile's Event Zoom In tab at the ViewStation or WorkStation, pressing the Next Event and/or Previous Event button to an event that has been deleted from the database, will display the message "Events were deleted from the database. Press the OK button to refresh the list." at the ViewStation or WorkStation.	Select the OK button to close the message box.
Next Event button is disabled.	The last event is selected in the list, therefore, there are no events to view next.	Select an earlier event.
Previous Event button is disabled.	The first event is selected in the list, therefore, there are no previous events to view.	Select a later event.
ST button is disabled	ST was never enabled for the selected patient tile.	If the patient tile requires ST analysis, and there is an ST license available, enable ST from the bedside monitor.
Lead sidebar button is disabled	The selected device is a: <ul style="list-style-type: none"> • Telepack device using a 3 or 5-wire lead • Telepack with Nonin SpO₂ module attached with a 3-wire lead set 	No solution required.
	The All ECG sidebar button is latched.	Select the All ECG sidebar button to enable the Lead sidebar button.
CO/CI data is not displayed in Waveforms view but is displayed in Events list.	Currently, CO/CI waveform data is not displayed in the Waveforms view.	No solution required.
No more events found	The colored vertical cursor is positioned at the first or the last event in the Events database.	No solution required.
Comments sidebar button is not displayed in sidebar.	The Paging option is not present on the central station licensing key.	Obtain a licensing key that contains the Paging option.
Comments sidebar button is disabled.	No paging information was sent for the selected event.	If a page should have been sent for the selected event type, verify the Page On Alarm settings in the Alarm Responses tab.

* Messages are shown in all bold text.

7.4 Disclosure Tab

The **Disclosure** tab provides access to a patient's disclosure database. The disclosure database is a collection of continuous, running, available waveforms that can store between 1 and 72 hours of disclosure data, depending on the type of license key that is issued for the system. License keys are issued for 1-hour, 24-hour, 48-hour, and 72-hour periods.

Each record in the database includes the time of the record, digital data, patient alarm events and all of the waveforms (with the exception of the O₂ and Agent waveforms) that were available for the patient at the time of the record storage. When a patient's disclosure database reaches the maximum number of records allowed, the next new record replaces the oldest record.

The **Disclosure** tab is available at the ViewStation and the WorkStation (shown in FIGURE 7-20) and functions in the same manner as it does at the host central station. The **Disclosure** tab will display the disclosure data from the central station, provided the patient file is communicating with the central station.

A patient's disclosure data can be viewed in two different formats. The default view is the **Compressed** view. The other is the **Waveforms** (magnified) view. Both views are discussed in the following sections.

7.4.1 Accessing the Disclosure Tab

1. Select the **VIEW** button on the desired patient file. The **Bedside** tab will be displayed.
2. Select the **Disclosure** tab. The **Disclosure** tab (shown in FIGURE 7-20) **Compressed** view is displayed.

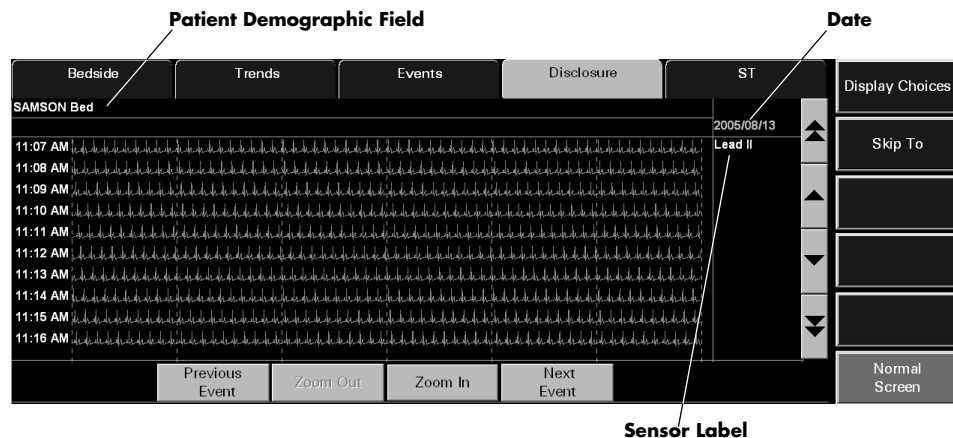

FIGURE 7-20 Disclosure Tab - Compressed View (Central Station, ViewStation, WorkStation)

7.4.1.1 Components of the Compressed View

Patient Demographic Field

The patient demographic field displays the last name and bed number of the selected patient, if this data was entered.

Waveform Area

The waveform area of the **Disclosure** tab provides a compressed view of the selected patient's historical waveform data. A maximum of 10 minutes of waveform data can be scrolled into the viewable area of the display. Each row of historical disclosure data in the waveform area is displayed in one minute intervals. Each waveform is displayed in the designated color of the parameter.

On initial entry to the **Compressed** view of the **Disclosure** tab, the ECG waveform displayed is the first waveform shown in the main screen.

The waveforms displayed in the **Disclosure** tab are based on the sensors currently in use. Any previously collected data is displayed, even if the parameter is not currently being monitored. Newly stored waveform data does not immediately update the disclosure waveform area. Selecting another control in the **Disclosure** tab causes the waveform area to refresh and updates the newly stored waveform data.

Blank sections of a disclosure waveform occur during the storage of a row of data when:

- The system time has been altered
- The device has been placed into **Standby** mode
- The device is in a **Communications Lost** state
- The Panorama Central Station has been restarted

The entire waveform area will be blank if the selected patient tile does not have a monitoring device attached or if there is no historical disclosure data in the patient's database.

Time, Date, and Sensor Label

The actual time the data was stored is displayed on the left side of the waveform. The format of the time display follows the System Time Format as defined in the "Date/Time Tab" on page 9-41.

The date the selected waveform data was recorded is displayed in the upper right corner of the waveform area (shown in FIGURE 7-20).

A sensor label for the selected waveform data is also displayed in the upper right corner of the waveform area, just below the date (shown in FIGURE 7-20).

Event Markers

The **Disclosure** tab uses event markers to indicate that an event (such as an alarm condition) has occurred. Event markers are small, color coded, horizontal lines that are drawn above the disclosure waveform at the onset of the event. The color codes for the event markers are defined as follows:

- Red event markers indicate that a Level 1 alarm occurred
- Yellow event markers indicate that either a Level 2 or a Level 3 alarm occurred
- Blue event markers indicate that a user marked event occurred at either the Panorama Central Station or the bedside monitor and/or that the **Nurse Call** button was pressed on the Panorama Telepack
- Orange event markers indicate that a **Communications Lost** event or a clock adjustment occurred

7.4.1.2 Navigating in the Waveform Area

If the **Disclosure** tab waveforms exceed the capacity of the viewable screen, use the navigational buttons to locate the desired waveform. The buttons are described as follows:

Previous Event Button

Select the **Previous Event** button to locate the next event in the patient's disclosure database that occurred **before** the time at the upper left corner of the compressed view.

Next Event Button

Select the **Next Event** button to locate the next event marker in the **Compressed** view that occurred **after** the current marker time.

Zoom In Button

Select the **Zoom In** button to magnify a selected area from the compressed view of the patient's disclosure waveform.

Zoom Out Button

Select the **Zoom Out** button to return the magnified view of the patient's disclosure waveform to the compressed view of the waveform. The **Zoom Out** button is only enabled when the magnified view of the waveform is displayed.

Scrolling through the Waveforms

If the disclosure database exceeds the capacity of the viewable screen (10 minutes), there are two methods of scrolling through the waveforms. Arrow buttons located along the right side of the view (next to the sidebar) function as follows:

- Use the single up-arrow and single down-arrow buttons to scroll up or down a single row.
- Use the Page Up (double up-arrow) and Page Down (double down-arrow) buttons to scroll through one page of disclosure waveforms at a time to view earlier or later data.

7.4.1.3 Changing the Displayed Waveform

Select the **Display Choices** sidebar button to select the waveform that will be displayed in the **Compressed** view of the **Disclosure** tab. The **Display Choices** dialog box (shown in FIGURE 7-21) displays the choices that are available based on the monitoring device, ECG lead set, and utilized sensors. Any previously used parameters, ECG lead set or sensors are displayed, even if they are not currently in use.

NOTE: The sensor selected in the **Display Choices** dialog will remain until the **Disclosure** tab is exited.

NOTE: The **O2** and **Agent** parameters are not available in the **Display Choices** list box.

To change the sensor currently displayed in the **Disclosure** tab:

1. Select the **Display Choices** sidebar button. The **Display Choices** dialog box is displayed.

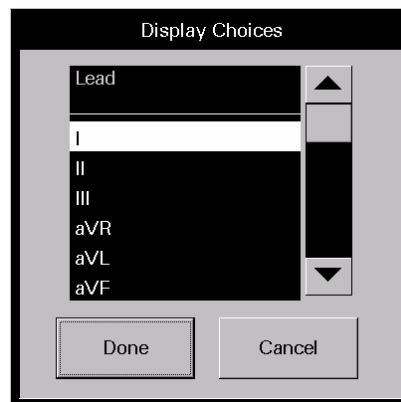

FIGURE 7-21 Display Choices Dialog Box

2. Select the desired waveform to be displayed from the **Display Choices** dialog box.
 - Select the **Cancel** button to return to the **Disclosure** tab.
 - Select the **Done** button return to the **Disclosure** tab and view the selected waveform.

7.4.1.4 Locating Specific Disclosure Data

Select the **Skip To** sidebar button to choose a different time period from the selected patient's disclosure database. The date and time the data was stored is displayed on the left side of the waveform.

NOTE: The time and date selected in the **Skip To** dialog will remain until the **Disclosure** tab is exited.

To locate a specific time in the disclosure database:

1. Select the **Skip To** sidebar button. The **Skip To** dialog box (shown in FIGURE 7-22) will be displayed.

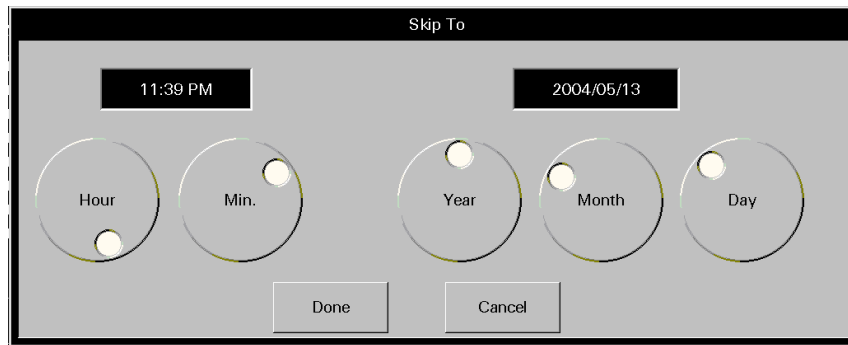

FIGURE 7-22 Skip To Dialog Box

2. Rotate the dial controls to select the time and date to be displayed. Ensure that the selected time and date are within the timeframe of the database.
 - Select the **Cancel** button to return to the **Disclosure** tab.
 - Select the **Done** button to return to the **Disclosure** tab with the selected date displayed in the date area, and the selected time displayed in the upper left corner of the waveform area.

7.4.1.5 Printing a Full Disclosure Report from the Compressed View

Multiple hours of disclosure data can be printed to a Full Disclosure Report directly from the **Compressed** view.

To indicate the time interval for printing this report:

1. From the **Compressed** view, select the **Print** menu bar button. The Print Selection dialog box (shown in FIGURE 7-8) is displayed.
2. Select the **Print Current** button, a time interval button, or the **Cancel** button.
 - Select the **Print Current** to create a one page Trend List Report.
 - Select one of the time interval buttons. The choices are print 1 hour, 2 hours, 4 hours, 8 hours, 12 hours, and 24 hours.
3. Select the **Cancel** button to close the dialog box without generating the print request.

7.4.1.6 Sidebar Buttons

The following sidebar buttons are used to expand the functionality of this view.

Display Choices

Select the **Display Choices** sidebar button to select the waveform that will be displayed in the **Compressed** view of the **Disclosure** tab. For additional information regarding this option, refer to “Changing the Displayed Waveform” on page 7-44.

Skip To

Select the **Skip To** sidebar button to choose a different time period from the selected patient’s disclosure database. For additional information regarding this option, refer to “Locating Specific Disclosure Data” on page 7-44.

Normal Screen

Select the **Normal Screen** sidebar button to return the display to the full screen mode, and close all tabs, message boxes, and dialog boxes.

7.4.1.7 Troubleshooting

For **Compressed** view troubleshooting information, refer to "Troubleshooting" on page 7-51.

7.4.2 Disclosure Tab (Waveforms View)

The **Waveforms** view displays a selected area from the **Compressed** view of the patient's disclosure waveform (shown in FIGURE 7-23).

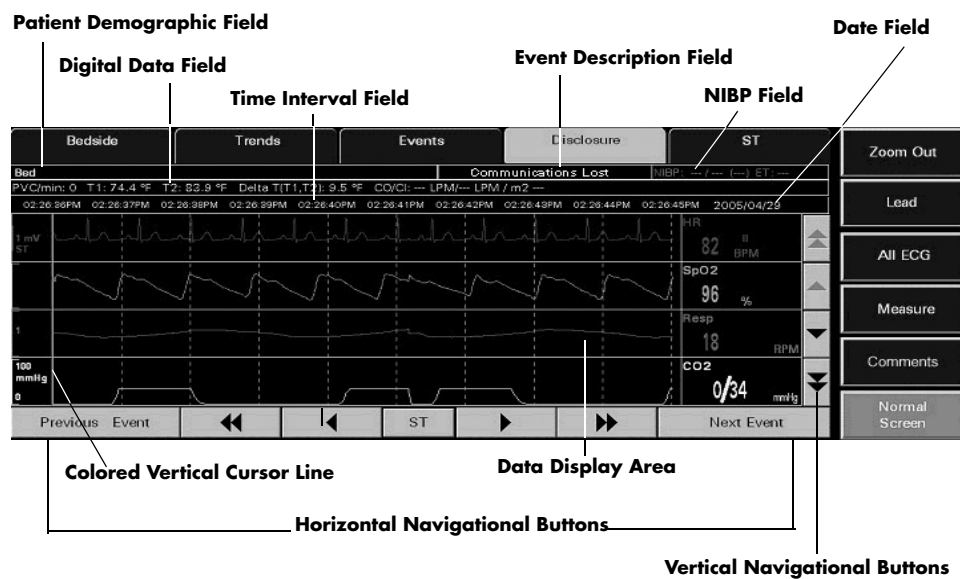

FIGURE 7-23 Disclosure Tab (Waveforms View)

7.4.2.1 Accessing the Waveforms View

1. Select the **VIEW** button on the desired patient tile. The **Bedside** tab is displayed.
2. Select the **Disclosure** tab. The **Waveforms** view (shown in FIGURE 7-23) is displayed.
3. Select a zoomed in area using one of the following methods:
 - Selecting the **Zoomed In** button without highlighting the waveform displays the magnified view beginning with the time at the upper left corner of the compressed waveform area.
 - A section of the waveform can be highlighted by selecting a starting point and dragging to an end point. Selecting the **Zoom In** button displays a magnified view of the highlighted section.

7.4.2.2 Components of the Waveforms View

Patient Demographic Field

The patient demographic area displays the patient's last name and bed number, if available.

Digital Data Field

The following seven (7) parameters can display in the digital data area depending on the bedside monitor configuration.

- PVC/min
- Temperature 1
- Temperature 2
- Temperature 3
- T Blood
- N2O
- CO/CI
- CCO/CCI
- CCO STAT/CCI STAT
- SVR
- SVRI
- SVO₂
- ScVO₂
- PAWP

NOTE: The Temperature 1, Temperature 2, Temperature 3 (V Series only), and T Blood parameters are only displayed when they are used in the calculation of the Delta Temperature parameter.

Time Interval Field

The time interval field is displayed in one second intervals. A total of nine seconds can be viewed on the screen at one time. Each second shown displays a time label over each one-second-grid line in the waveform area.

Event Description Field

The event description field displays the event that was selected in the **Event List** view. For example, a High Heart Rate Alarm.

NIBP Field

The NIBP field displays the NIBP systolic pressure, diastolic pressure, mean pressure, and elapsed time.

Date Field

The date area indicates the date the event occurred and was stored in the Events database.

Data Display Area

If data is available, the **Waveforms** view displays 20 seconds of waveform data. The initial **Waveforms** view displays the first nine seconds of waveform data before the alarm was triggered, and can display three to four waveforms and/or digital data tiles at one time.

Colored Vertical Cursor Line

The colored vertical cursor line extends from the first waveform to the last waveform on the display. Each movement of the colored vertical cursor line indicates the specific time in the event.

7.4.2.3 Navigating in the Waveforms View of the Disclosure Tab

Navigating in the **Waveforms** view is accomplished by using buttons. When the **Waveforms** view is first opened, the colored vertical cursor line will be positioned in the far left position.

Vertical Navigation Buttons

Double Up Arrow Button

Select the **double up arrow** push button to display the previous page of waveforms in the ordered set. This button will be disabled if the first waveform in the ordered set is already visible in the data display area.

Up Arrow Button

Select the **up arrow** button to move the group of waveforms displayed up one position within the ordered set of available waveforms. This button will be disabled if the first waveform in the ordered set is already visible in the data display area.

Double Down Arrow Button

Select the **double down arrow** button to display the next page of waveforms in the ordered set. This button will be disabled if the last waveform in the ordered set is already visible in the data display area.

Down Arrow Button

Select the **down arrow** button to move the group of waveforms displayed down one position within the ordered set of available waveforms. This button will be disabled if there are less than nine seconds of earlier data to display.

Horizontal Navigation Buttons

Previous Event Button

Select the **Previous Event** button to locate and display an event that occurred earlier than the current event time began. This button will be disabled when the colored vertical cursor is positioned at the start time of the first event in the database.

Double Left Arrow Button

Select the **double left arrow** button to display the previous nine seconds of event data, provided this data was collected. This button will be disabled if the colored vertical cursor line is positioned at the start time of the first record in the database.

Left Arrow Button

Select the **left arrow** button to move the colored vertical cursor line one second back in time. This button will be disabled when the colored vertical cursor is positioned at the start time of the first record in the database.

Right Arrow Button

Select the **right arrow** button to move the colored vertical cursor line one second forward in time.

Double Right Arrow Button

Select the **double right arrow** button to display the next nine seconds of event data, provided this data was collected.

Next Event Button

Select the **Next Event** button to locate and highlight an event that occurred **after** the currently highlighted event in the **Waveforms** view.

7.4.2.4

ST Button

Select the **ST** button to open the Full Disclosure Zoom In ST dialog box.

Full Disclosure Zoom In ST Dialog Box

The Full Disclosure Zoom In ST dialog box (shown in FIGURE 7-19) displays the current and reference values for all the leads where ST was performed during the selected event. The number of leads that display in this dialog box is dependent on the number of leads used during the event. If the ST option has ever been enabled for the selected patient tile, the ST button will be enabled even if ST is not currently being monitored. If ST was never enabled for the patient tile, the ST button will be disabled.

2005/07/05 11:27:53 AM					
Label	Current (mm)	Reference (mm)	Label	Current (mm)	Reference (mm)
ST-I	-0.1	-0.1	ST-V	0.4	0.4
ST-II	0.0	-0.1			
ST-III	0.0	0.0			
ST-aVR	0.0	0.1			
ST-aVL	-0.1	0.0			
ST-aVF	0.0	0.0			

Done

FIGURE 7-24 Full Disclosure Zoom In ST Dialog

Date and Time Text Area

The date/time text area, located at the top of the Full Disclosure Zoom In ST dialog, displays the date and time the ST data displayed was acquired. When the ST dialog box navigation buttons (moving forward or backward in time) are used, this area will be updated to reflect the date and time of the ST data currently displayed in the dialog box.

Left Arrow Button

Select the **left arrow** button to view the ST data for the previous event second.

Right Arrow Button

Select the **right arrow** button to view the ST data for the next event second.

Done Button

Select the **Done** button to close the Full Disclosure Zoom In ST dialog.

7.4.2.5 Comments Dialog Box (Optional)

With the addition of system-wide paging, a paging notification can be sent to clinicians to alert them that a specific event type has occurred. If a page was sent for a selected event in the **Waveforms** view, an asterisk (*) will appear beside the event in the event description area (shown in FIGURE 7-18). The paging information related to the event can be viewed by selecting the **Comments** sidebar button. The Comments dialog box will display either a **Page Sent** or a **Page Failed** message. If the selected event does not have an asterisk beside the event description, this indicates that a page has not been sent for the selected event. In this case, the **Comments** sidebar button will be disabled.

7.4.2.6 Sidebar Buttons

The **Waveforms** view may contain up to six sidebar buttons.

Zoom Out

Select the **Zoom Out** sidebar button to return to the **Compressed** view of the **Disclosure** tab.

Lead

Select the **Lead** sidebar button to cycle through each of the waveforms in the ordered set. The **Lead** sidebar button is not available when using a:

- Telepack device with a 3 or 5-wire lead set
- Telepack with Nonin SpO₂ module with a 3-wire lead set

All ECG

Select the **All ECG** sidebar button to access the All ECG mode of the **Disclosure** tab. When the **All ECG** button is white, this indicates the **Disclosure** tab is in the All ECG mode. The **Waveforms** view remains in the **All ECG** mode until the **All ECG** sidebar button is selected again. The **All ECG** sidebar button is not available when using a:

- Telepack device with a 3 or 5-wire lead set
- Telepack with Nonin SpO₂ module with a 3-wire lead set

NOTE: If a 5-wire or 12-lead set was previously used for the selected patient, the All ECG sidebar push button will always be enabled.

Measure

Select the **Measure** sidebar button to activate the Measure dialog box (shown in FIGURE 7-3). The Measure dialog contains reference and measurement lines to calculate the time and amplitude of an ECG waveform. For instructions on the use of the Measure button, refer to “Performing ECG Waveform Measurements” on page 7-5.

NOTE: The Print menu bar will be enabled when the Measure dialog box is open.

Comments (Optional)

This sidebar button was previously described in the “Comments Dialog Box (Optional)” on page 7-50. If the Paging feature is unavailable at the central station, the **Comments** sidebar button will not be displayed.

Normal Screen

Select the **Normal Screen** sidebar button to return the display to the full screen mode, and close all tabs, message boxes, and dialog boxes.

7.4.2.7 Printing a Full Disclosure Zoom In Report from the Waveforms View

To print a Full Disclosure Zoom In Report from the **Waveforms** view, select the **Print** button from the Menu Bar (shown in FIGURE 2-1).

7.4.2.8 Troubleshooting

This section lists some of the potential messages and issues that may occur while using the **Disclosure** tab.

MESSAGE/ISSUE *	REASON	SOLUTION
No patient in the tile	The selected tile is not actively monitoring a patient.	Choose a tile that is actively monitoring a patient.
All displays are blank and all buttons (except Normal Screen) are disabled.	The selected patient tile does not have any stored historical data.	The selected patient tile has not been monitoring long enough to have stored any data. Wait for new data to accumulate.
	The selected patient tile does not have a device attached.	Choose a tile that is actively monitoring a patient.
All buttons (except Normal Screen) are disabled.	The Display Choices dialog box is displayed.	Close the Display Choices dialog box.

* Messages are shown in all bold text.

MESSAGE/ISSUE *	REASON	SOLUTION
A section of the waveform is blank.	<p>The system time was altered during the storage of the row of data.</p> <p>The device was placed into Standby mode during the storage of the row of data.</p> <p>The device experienced a Communications Lost event during the storage of the row of data.</p> <p>The Panorama was restarted during the storage of the row of data.</p>	<p>Wait for new data to accumulate.</p> <p>Restore the system to normal operating mode to resume data collection.</p> <p>Determine the cause of the Communications Lost condition and rectify to resume data collection.</p> <p>Wait for new data to accumulate.</p>
No more events found (Previous Event Button)	<p>There is no event data in the Disclosure database.</p> <p>There are no more events in the patient's Disclosure database that occurred before the time at the upper left corner of the compressed view.</p> <p>The oldest data is at the upper left corner of the compressed view.</p>	<p>Wait until an event is recorded to the Disclosure database.</p> <p>Select the OK button to close the message box and return to the Disclosure tab.</p> <p>Select the OK button to close the message box and return to the Disclosure tab.</p>
No more events found (Next Event Button)	<p>There is no event data in the Disclosure database.</p> <p>There are no more events in the patient's Disclosure database that occurred after the time at the lower right corner of the compressed view.</p> <p>The most recent data is at the lower right corner of the compressed view.</p>	<p>Wait until an event is recorded to the Disclosure database.</p> <p>Select the OK button to close the message box and return to the Disclosure tab.</p> <p>Select the OK button to close the message box and return to the Disclosure tab.</p>
Time out of range (Page Up button)	There are less than 10 rows of data that are newer than the top row.	Select the OK button to close the message box and return to the Disclosure tab. Wait for new data to accumulate.
Time out of range (Page Down button)	There are less than 10 rows of data that are older than the top row.	Select the OK button to close the message box and return to the Disclosure tab. Data is not available.
Time out of range (single up-arrow button)	There is no new data to display.	Select the OK button to close the message box and return to the Disclosure tab. Wait for new data to accumulate.
Time out of range (single down-arrow button)	There is no older data to display.	Select the OK button to close the message box and return to the Disclosure tab. Data is not available.

* Messages are shown in all bold text.

MESSAGE/ISSUE *	REASON	SOLUTION
Time out of range (Done button in the Skip To dialog box)	A time and date that is older than the oldest data or newer than the most recent data was entered in the Skip To dialog box.	Select the OK button to close the message box. Select the Skip To sidebar button and enter a time and date that is within the time frame of the database.
ST button is disabled	ST was never enabled for the selected patient tile.	If the patient requires ST analysis, and there is an ST license available, enable ST for the selected patient tile.
Comments sidebar button is not displayed in sidebar	The Paging option is not present on the central station licensing key.	Obtain a licensing key that contains the Paging option.
There is a gap between waveform times	Either the central station and monitoring device were not communicating during that time (Communications Lost) or the system time was changed in the Date/Time tab.	No solution required.
Comments sidebar button is disabled.	No paging information was sent for the selected event.	If a page should have been sent for the selected event type, verify the Page On Alarm settings in the Alarm Responses tab.
The current event was deleted from the database. Press the OK button to refresh the data.	This message will be displayed when viewing a patient tile's Full Disclosure Zoom In tab at the ViewStation or WorkStation, and the Next Event and/or Previous Event button is selected to view an event that has been deleted from the database.	Select the OK button to close the message box.
The Previous Event button is disabled.	The cursor is positioned at the first record of the Disclosure database.	No solution required.
Lead sidebar button is disabled	The selected device is a: <ul style="list-style-type: none"> • Telepack device with a 3 or 5-wire lead set • Telepack with Nonin SpO₂ module attached with a 3-wire lead set 	No solution required.
	The All ECG sidebar button is latched.	Select the All ECG sidebar button to enable the Lead sidebar button.

* Messages are shown in all bold text.

7.5 ST Tab

The **ST** tab is used to view and configure the current ST templates or view the ST numeric data for the selected patient tile. The number of ST templates or ST numeric data displayed depends on the type of ECG lead set and the monitoring device currently in use.

ST templates are displayed when using a hardwired or wireless 2.4 GHz bedside device, or Telepack device. When using any of these devices, the ST templates can be adjusted directly from the Panorama Central Station.

When using a WMTS 608 wireless bedside device, only numeric data is displayed (shown in FIGURE 7-26). ST configuration settings must be adjusted at the bedside device.

The **ST** tab is available at the ViewStation and the WorkStation but is for viewing purposes only. When a patient tile is assigned at the ViewStation and/or the WorkStation, it will always display the ST information of the associated host central station patient tile provided the patient tile is in an active state.

Automatic updating of the ST information at the remote workstation will also occur when:

- The monitoring device is placed in the Standby mode at the central station
- The monitoring device is not communicating with its host central station (Communications Lost)
- Communication between the host central station and the ViewStation and/or the WorkStation is lost (Central Communications Lost)

7.5.1 Accessing the ST Tab

1. Select the **VIEW** button in the selected patient tile. The **Bedside** tab is displayed.
2. Select the **ST** tab. The **ST** tab (shown in FIGURE 7-25 or FIGURE 7-26) is displayed.



FIGURE 7-25 ST Tab - Hardwired Bedside Monitor (5-wire lead set)

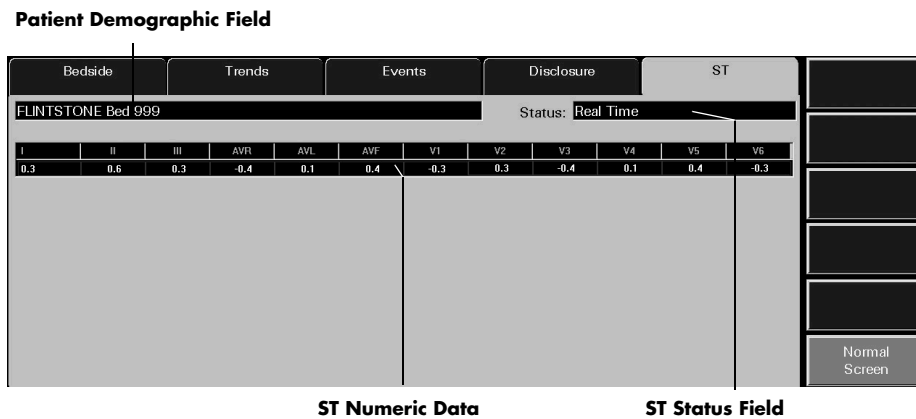

FIGURE 7-26 ST Tab - WMTS 608 Wireless Bedside Device (View 12™ card installed)



FIGURE 7-27 ST Tab - Hardwired Bedside Monitor - 5-wire lead set (ViewStation and WorkStation)

7.5.1.1 Components of the ST Tab

Patient Demographic Field

The patient demographic field displays the last name and bed number of the selected patient, if this data was entered.

ST Status Field

The ST Status field displays the status of ST analysis at the Panorama Central Station. The Status field only displays one message at any given time. The available status messages include:

- **No License** indicates that an ST license is not available for the selected patient tile.
- **Disabled** indicates that the ST algorithm on the bedside monitoring device is currently disabled.
- **Relearning** indicates that the ST algorithm is enabled and is in the learning phase of ST analysis.
- **Real Time** indicates that the ST algorithm is enabled, a successful learn phase has been completed, and the most current data is being displayed.
- **Patient in Standby** indicates that the selected patient tile is in a standby state.
- **Communications Lost** indicates that the Panorama Central Station is not communicating with the monitoring device.

ST Template Area (Device Dependent)

The ST template area will display ST templates and digital data for each ECG lead that is utilized when using a hardwired bedside device, a wireless 2.4 GHz bedside device, or a Telepack device. ECG lead labels are shown at the top of the ST template area. These labels represent the ST data currently displayed.

NOTE: **When using a 3 or 5-wire lead set, ST is invalidated when the measured ST value exceeds range, and/or paced rhythm persists for more than 45 seconds.**

When using a View 12™ card, ST is invalidated when the measured ST value exceeds range, and/or paced rhythm persists for more than 30 seconds.

For all lead wire sets, ST is also invalidated during detected episodes of Asystole, V-Fib, V-Tach, and V-Rhythm.

NOTE: **ST templates are not displayed when using a WMTS 608 bedside device.**

- When utilizing a 3-wire lead set, the ST tab will contain one ST template for the lead that is currently being monitored.
- When utilizing a 5-wire lead set, the ST tab will contain seven ST templates.
- When utilizing a View 12™ card, the ST tab will contain 12 ST templates.

Reference ST

- The reference ST template is displayed in white
- The digital data for the reference ST displays at the bottom of the ST template area
- The reference ST template displays dashes (- -) when ST is relearning, when there is no data available, or when the data is invalid

Current ST

- The current ST template is displayed in yellow
- The digital data for the current ST will be shown at the bottom of the ST template area
- The current ST template will display dashes (- -) when ST is relearning, when there is no data available, and when the data is invalid

NOTE: **ST templates and digital data will not be shown in the ST template areas during an ST learn phase.**

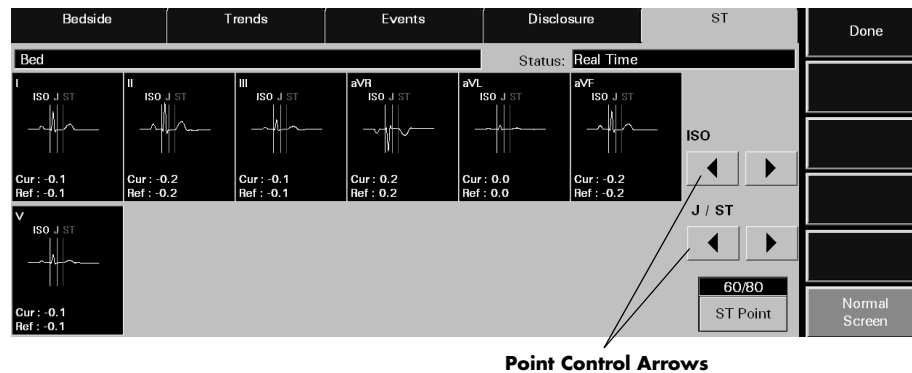

FIGURE 7-28 Point Control Arrows in ST Tab (5-wire Lead Set)

7.5.1.2 Configuring ST (Device Dependent)

Configuration settings are device dependent, except for the Telepack 608 which is turned on at the central station, and can only be performed when using a hardwired bedside device, a wireless 2.4 GHz bedside device, or a Telepack device. When using a WMTS 608 bedside device, ST configuration settings must be performed at the bedside monitor.

NOTE: If the ECG Lead set is changed during ST configuration, the ST tab will automatically be closed and returned to the normal screen mode.

To configure ST points:

1. Select the **Config ST** sidebar button in the **ST** tab. The ISO, J/ST and ST Point controls (shown in FIGURE 7-28) are displayed in the ST tab.
2. Select a point control arrow to configure the ISO reference line. The ISO reference line is displayed in white.
 - Select the left arrow to move the ISO reference line to the left one step setting.
 - Select the right arrow to move the ISO reference line to the right one step setting.
3. Select a point control arrow to configure the J/ST reference line. The J reference line is displayed in yellow. The ST reference line is displayed in green.
 - Select the left arrow to move the J/ST reference line to the left one step setting.
 - Select the right arrow to move the J/ST reference line to the right one step setting.

NOTE: Due to monitor resolution restrictions, adjustments to the J/ST reference lines may not always be shown.

4. Select the **ST Point** button to select the desired ST Point. Changing the ST point will move the ST reference line to the right of the J reference line for the selected number of milliseconds. The options that are available for ST Point include 40, 60, 80 and 60/80 milliseconds.
5. Select the **Done** button.

7.5.1.3 Simultaneous ST Configuration Editing

If using a bedside device with the Panorama Central Station, ST configuration changes cannot be made at the bedside monitor and at the central station simultaneously. When an attempt is made to do this, the bedside device will take precedence and the message **These settings are currently being edited remotely.** will be displayed central station.

These are the scenarios in which this message will be displayed:

- The ST Menu is active at the bedside monitor and then the **ST** tab is opened at the central station
- The **ST** tab is active at the central station and then the ST Menu is opened at the bedside monitor

To close this message dialog, select the **OK** button. Acknowledging this message will convert the **ST** tab at the central station to a read-only state and editing will not be permitted. Once the ST Menu is closed at the bedside device, the **ST** tab will become active again and editing can resume.

In both of these scenarios, unsaved changes made in the central station Config ST tab will be discarded, and the system will return to the **ST** tab.

For additional information regarding the bedside monitor menus, refer to the bedside monitor's Operating Instructions:

- Passport 2 (P/N 0070-00-0649-XX)
- Passport V (P/N 0070-00-0704-XX)
- Spectrum (P/N 0070-00-0648-XX)
- Spectrum OR (P/N 0070-00-0670-XX)
- V Series (P/N 0070-00-0727-XX)

7.5.1.4 Sidebar Buttons

The following sidebar buttons are used to expand the functionality of this view.

Config ST

Select the **Config ST** sidebar button to configure the ST templates in the **ST** tab. Selecting the **Config ST** sidebar button will display the controls (shown in FIGURE 7-28) needed to configure the ST templates. When the **Config ST** sidebar button is selected, it is replaced by the **Done** sidebar button.

NOTE: The **Config ST** sidebar button is not available when using a **DPM6/7** or **WMTS 608** wireless bedside device.

NOTE: The **Config ST** sidebar button is not available at the **ViewStation** or the **WorkStation**.

Done

Select the **Done** sidebar button to confirm the selected ST configuration.

Normal Screen

Select the **Normal Screen** sidebar button to return the display to the full screen mode, and close all tabs, message boxes, and dialog boxes.

7.5.2 Generating an ST Report

To review the current and reference digital values with the associated ST templates for the selected patient tile, generate an ST Report. This report can be generated directly from the **ST** tab by selecting the **Print** menu bar button.

NOTE: **The Print button is not available when using a WMTS 608 wireless bedside device.**

For additional information regarding the ST Report, refer to the “ST Report” on page 8-14.

7.5.3 Troubleshooting

This section lists some of the potential messages and issues that may occur while using the **ST** tab.

MESSAGE/ISSUE *	REASON	SOLUTION
No Patient Selected! is displayed in the ST tab demographics text box	This message appears in the demographic field when an empty patient tile has been selected.	Select an active patient tile.
No License is displayed in ST tab status text box	The monitoring device does not have an ST license or ST has been disabled.	Obtain an ST license and/or enable ST at the monitoring device.
Disabled is displayed in ST tab status text box	ST is disabled at the monitoring device.	Enable ST.
Relearning is displayed in ST tab status text box	ST was just enabled at the monitoring device.	Wait for a successful learn phase to complete.
Real Time is displayed in ST tab status text box	ST is enabled and a successful learn phase has been completed.	No solution required.
Patient in Standby is displayed in ST tab status text box	The selected patient tile is in a standby state.	The message will be removed when monitoring is resumed.
Communications Lost is displayed in the ST tab status text box	The central station is in a Communications Lost state.	The message will be removed when communications is restored.
“---” displays in ST template	ST data displays as invalid because monitor may be in a learning phase or patient is in an ECG rhythm that does not allow for ST monitoring (V-Fib, Asystole, etc.)	Wait until learn phase is complete and/or re-establish normal ECG.
ST templates are present but contain no ST data.	Monitoring device is in relearn mode.	Wait for Real Time to display in ST tab status text box.

* *Messages are shown in all bold text.*

MESSAGE/ISSUE *	REASON	SOLUTION
	The These settings are currently being edited remotely message is displayed.	Select the OK button to close the message box and enable the sidebar button. Close the ST Menu at the bedside device.
ST templates are not available in the ST tab.	A WMTS 608 wireless bedside device is in use.	View the ST templates at the bedside device.
The Print menu bar button is disabled.	The selected patient tile does not have an ST license.	If necessary, activate an ST license for the patient tile.
	The selected tile is in a learn phase.	Wait for the learn phase to complete.
	ST has been disabled.	If an ST license is available, enable a license for the patient tile.
	The patient tile is in the Bedside and Panorama Standby mode.	If necessary, remove the patient tile from this mode.
	The patient tile is in the Panorama Standby Only mode.	If necessary, remove the patient tile from this mode.
	The patient tile is in the Communications Lost state.	Restore communications with the bedside monitor.
	The These settings are currently being edited remotely. message is displayed.	Select the OK button to close the message box and enable the sidebar button. Close the ST Menu at the bedside device.
	The ST tab is displayed and the assigned device is a WMTS 608 bedside monitor.	ST numerics can be documented by generating a Trend List Report.
	The patient tile is in a Waiting for Patient state.	Restore communications with the bedside monitor.
These settings are currently being edited remotely.	The ST Menu is opened at the bedside monitor while in the Config ST mode at the central station.	Wait until the changes are made at the bedside monitor. If necessary, close the ST menu at the bedside to enable the ST menu at the central station.
	The ST tab is active at the central station and then the ST Menu is opened at the bedside monitor.	
	The central station Config ST tab is active and then the ST Menu is opened at the bedside monitor.	

* Messages are shown in all bold text.

MESSAGE/ISSUE *	REASON	SOLUTION
The Config ST tab at the central station was closed and all changes were discarded.	The ST Menu was opened at the bedside monitor.	Use the bedside monitor to make the ST configuration changes. Close the ST Menu at the bedside monitor and then reenter the Config ST tab at the central station.
The Config ST sidebar button is disabled.	The These settings are currently being edited remotely message is displayed.	Select the OK button to close the message box and enable the sidebar button. Close the ST Menu at the bedside device.

* *Messages are shown in all bold text.*

This page intentionally left blank.

8.0 *Report Functions*

This section outlines the types of reports that can be generated by the Panorama Central Station.

- Patient Reports Tab
- System Reports Tab
- Print Status Tab
- Additional Reports

8.1 Patient Reports Tab

The **Patient Reports** tab (shown in FIGURE 8-1) is used to print patient-specific reports.

The following reports can be printed from the **Patient Reports** tab:

- All Strips Report
- Full Disclosure Report
- ST Report
- Trend List Report
- Event List Report
- Patient Alarm Report

8.1.1 Accessing the Patient Reports Tab

1. From the menu bar, select the **Report** button.
2. Select the **Patient Reports** tab. The **Patient Report** tab is displayed.
3. Choose a patient tile by selecting its digital data or waveform area. If available, the patient's last name and bed number display in the patient demographic field.

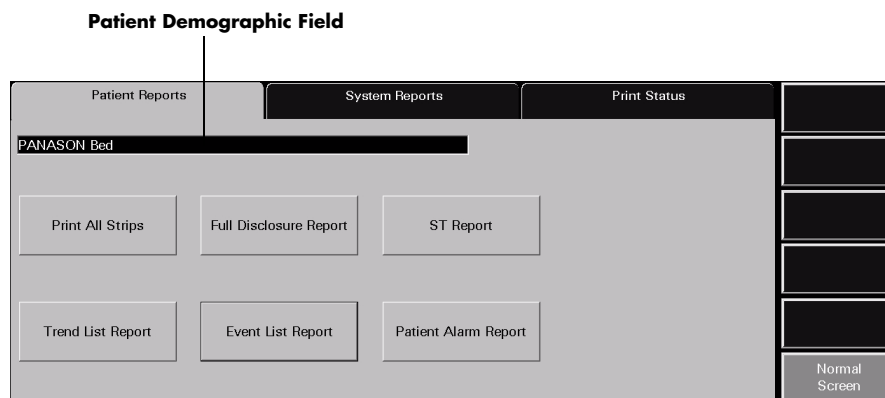

FIGURE 8-1 Patient Reports Tab

8.1.2 All Strips Report

The All Strips Report (shown in FIGURE 8-2 and FIGURE 8-3) contains real-time monitoring data, all current digital numeric values and all current configured waveforms for the selected patient tile. The report includes a header, digital data, waveform data and a footer section.

NOTE: This report is not available when the selected patient tile is in a **Communications Lost, Waiting for Patient, or Standby state.**

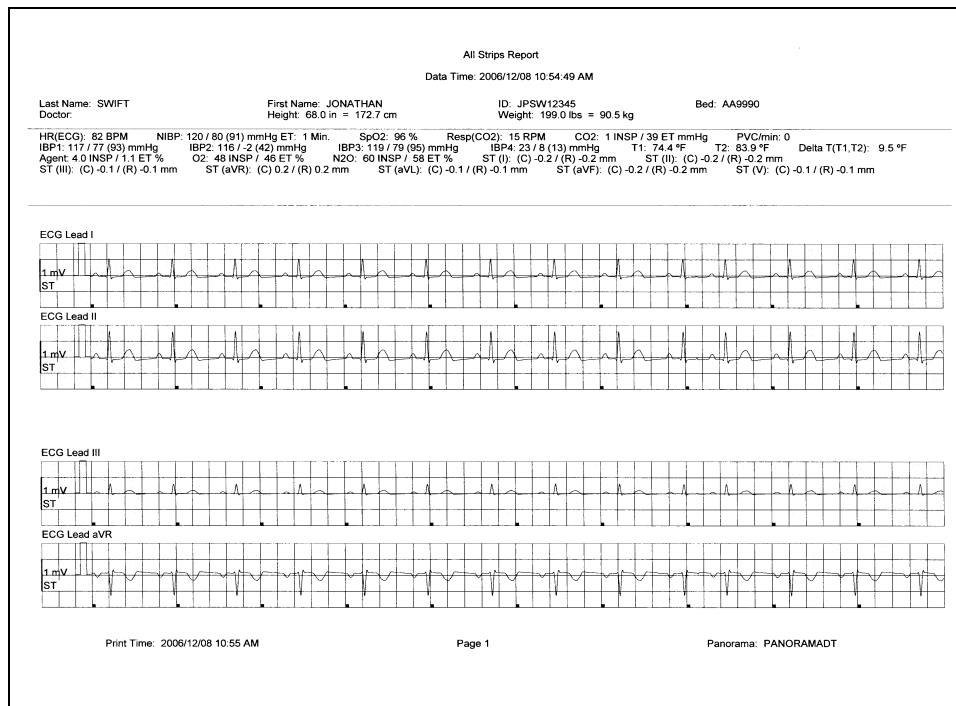

FIGURE 8-2 All Strips Report (Page 1)

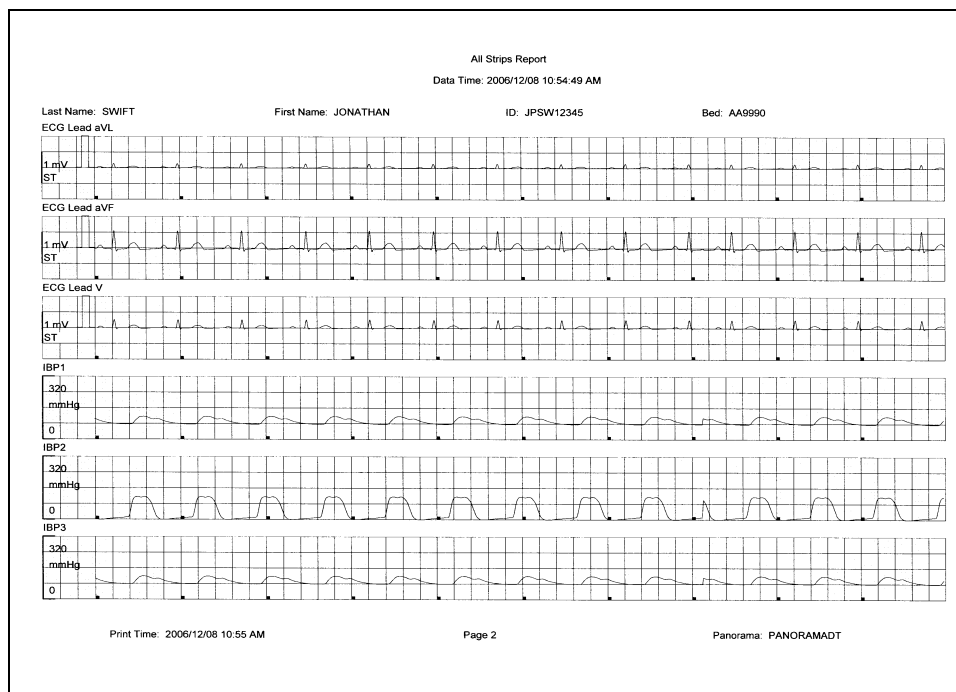

FIGURE 8-3 All Strips Report (Page 2)

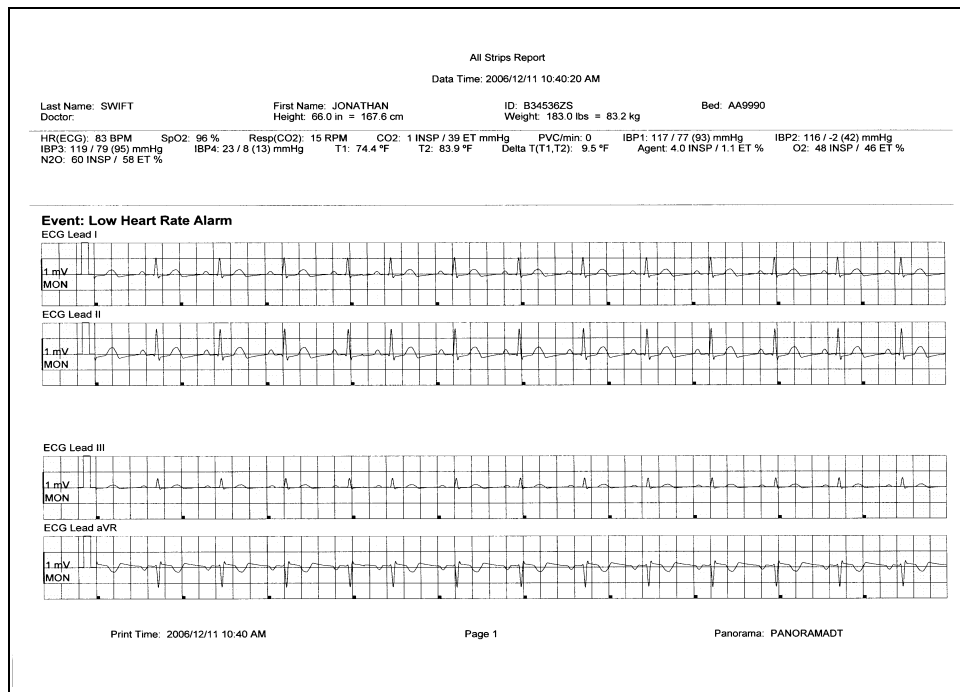

FIGURE 8-4 All Strip Report - Printed by Print on Alarm

8.1.2.1 Header

The All Strips Report's first page header provides the title of the report and basic demographic information, if it is available. The demographic information includes the patient's first and last name, identification number, bed number, weight, height and doctor.

Page headers on subsequent pages of the report provide the report title, the date and time the data was collected, and limited demographic information about the patient (first and last name, identification number and bed number), if it is available.

If the demographic data was not previously entered in the system, only the demographic label is shown.

8.1.2.2 Digital Data

The All Strips Report's digital data section displays measurements for the digital data parameters currently available for the selected patient tile. The displayed parameter order is determined by the system **Unit Priorities** tab. The digital data section contains the following:

- A parameter label
- A numeric measurement
- A unit of measure label
- A heart rate (HR) value
- Dashes (-) to indicate missing or invalid digital data.
- Square brackets ([]) to indicate alarming parameter values

NOTE: **Digital Data is only shown on the first page of the report.**

8.1.2.3 **Waveform Data**

The waveforms that print in the All Strips Report's waveform data section depend on which leads are currently in use and on the waveforms selected in the Print Setup function.

The first page of this report contains four waveforms. The middle pages of the report will contain six waveforms while the last page may contain one to six waveform strips depending on the waveforms available. Each waveform in this report represents approximately 10 seconds of data; five seconds prior to the time of the print request and 5 seconds after the print request. A waveform label (i.e., ECG Lead II) is shown above each strip to identify the data source and the unit of measurement (i.e., %, RPM, BPM, mmHg, kPa). Pleth, ECG and Respiration do not display a unit of measurement. The waveforms displayed in the report are shown on a calibrated grid and contain a scale bar.

If the All Strips Report printed as a result of a Print on Alarm, the event that prompted the report will print below the report digital data in bold.

For pacemaker patients that have Pacer Enhancement enabled, the report displays a vertical bar to indicate the firing of the pacemaker impulse.

For information on selecting the waveforms that can be printed in this report, refer to the "Print Setup Tab (Patient)" on page 5-57.

8.1.2.4 **ECG Waveforms**

The ECG waveforms shown in the All Strips Report are based on the ECG lead wire set currently in use and on the waveforms selected in the **Print Setup** tab. The ECG waveform report displays the following:

- An ECG lead label
- A wave gain scale bar and a calibration pulse for wave gains less than 30 mm/mV
- A calibrated grid
- Current ECG monitoring label
- A continuous straight line for active ECG leads that are not connected

Non-ECG Waveforms

The non-ECG waveforms shown in the All Strips Report only include the non-ECG parameters in use at the time of the print request.

All non-ECG waveforms in the report contain a parameter label and a unit of measure label. Non-ECG waveforms in the report contain a wave gain scale bar if the waveform is available at the time of the print request. If the waveform is not available, the report prints blank data for the specified time period. Also:

- If the IBP waveform was labeled at the bedside monitor, the report contains that IBP label.
- If the Anesthetic Agent was identified at the bedside monitor, the report contains that Agent label.

Footer

The All Strips Report contains a footer at the bottom of every page. The footer includes:

- The date and time of the print request. The format displayed is taken from the **System Date/Time** tab.
- A centered page number.
- The name of the Panorama Central Station where the report was generated.

Printing an All Strips Report

The All Strips Report is printed in landscape orientation, using any of the following methods:

- Select the **Print All Strips** button in the **Patient Reports** tab. Selecting the **Print All Strips** button will post an **All Strips Report** print request for the selected patient.
- Select the **REC** button in a patient file.
- Select the **Print** menu bar button in the **Bedside** tab.
- Enable the Print on Alarm option in the **Alarm Responses** tab when there is an alarm condition.
- Select the **Strip** button on a Passport 2, Passport V, Spectrum or Spectrum OR.
- Select the **Realtime Print** onscreen button on a DPM6 or DPM7. Select the **Print** button on a Telepack (refer to “Button Indicators” on page 10-3).

NOTE: To print this report for all active patients, use the **System Reports** tab **Print All Strips/All Patients** report.

NOTE: Remote printing is currently not available on the V Series.

Requesting this report posts a print job in the system Print Status tab. For additional information, refer to the “Print Status Tab” on page 8-38.

For report troubleshooting messages and issues, refer to “Troubleshooting” on page 8-27.

8.1.3 Full Disclosure Report

The Full Disclosure Report provides a compressed view of a patient’s historical ECG (shown in FIGURE 8-5 and FIGURE 8-6) and non-ECG (shown in FIGURE 8-7 and FIGURE 8-8) waveform data. This report includes a header, waveform data, and a footer.

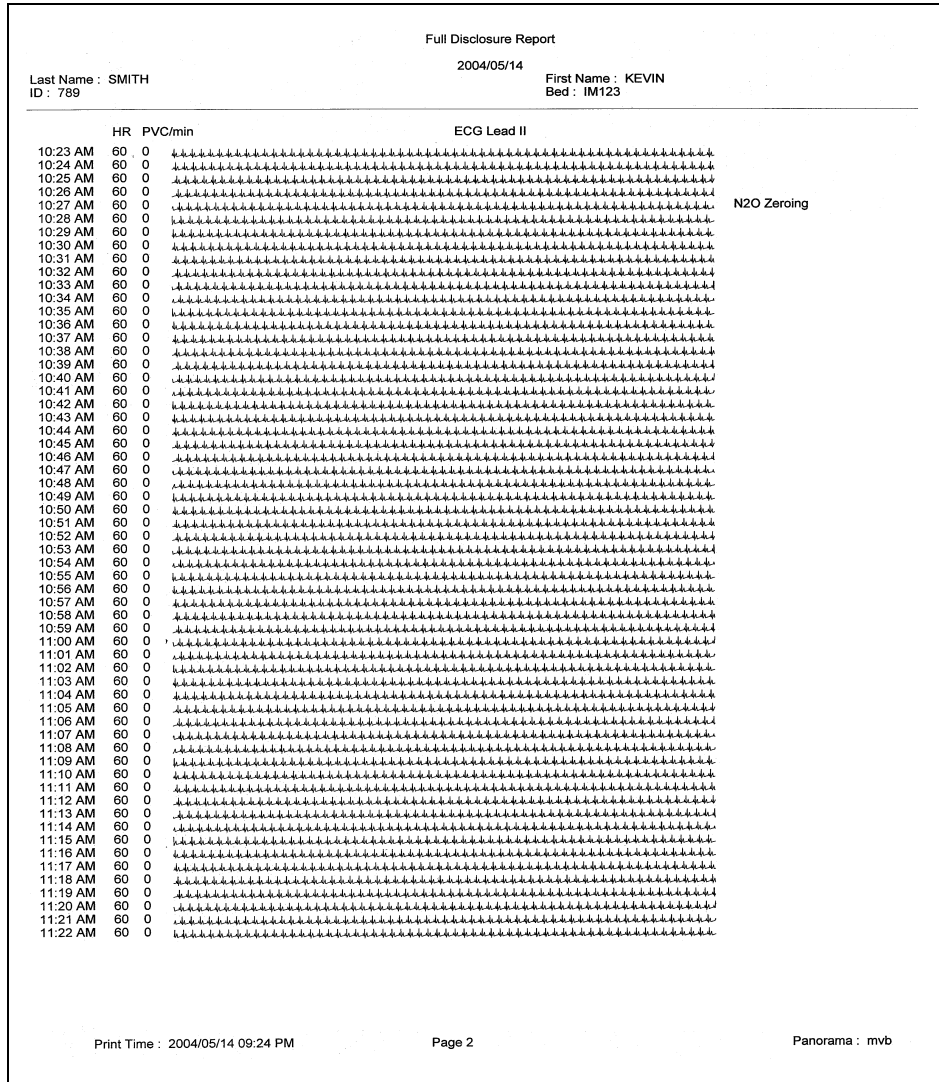

FIGURE 8-6 Full Disclosure Report (Page 2- ECG waveform layout)

8.1.3.2 Waveform Data

The ECG waveforms shown in the Full Disclosure Report are based on the ECG lead wire set currently in use and on the waveforms selected in the **Print Setup** tab.

ECG Waveform Format

The ECG waveform format for the Full Disclosure Report includes five columns. This format is used for reports that show ECG parameter waveforms.

- The first column contains the time (hour and minute) of the disclosure record. The time format follows the system format specified in the **Date/Time** tab.
- The second column contains a heart rate (HR) value. The heart rate value shown is from the last second of data that was collected during the disclosure record. If disclosure data is not available for the time period specified, dashes (–) are shown in the place of a heart rate value.
- The third column contains a PVC/min. value. The PVC value shown is the value that was obtained during the disclosure record. If disclosure data is not available for the time period specified, dashes are shown in the place of a PVC value.
- The fourth column contains a label for the waveform data being displayed in the report. The waveform label shown is the source of data for the disclosure record.
- The fifth column contains the events that occurred during the period of the disclosure record. If multiple events occur during the time period specified, the event with the highest priority is shown. If no events occur during the time period specified, this column remains empty.

For information regarding the type of events that occur in the Full Disclosure Report, refer to “Physiological Alarms and Events” on page 13-2.

Non-ECG Waveform Format

The non-ECG waveform format for the Full Disclosure Report includes four columns. This format is used for reports that show Non-ECG parameter waveforms.

- The first column contains the time (hour and minute) of the disclosure record. The time format follows the system format specified in the **Date/Time** tab.
- The second column contains a heart rate (HR) value. The heart rate value shown is from the last second of data that was collected during the disclosure record. If disclosure data is not available for the time period specified, dashes are shown in the place of a heart rate value.
- The third column contains a label for the waveform data being displayed in the report. The waveform label shown is the source of data for the disclosure record.
- The fourth column contains the events that have occurred during the period of the disclosure record. If multiple events occurred during the time period specified then the event with the highest priority is displayed. If no events occurred during the time period specified, this column remains empty.

For information regarding the type of events that occur in the Full Disclosure Report, refer to “Physiological Alarms and Events” on page 13-2.

8.1.3.3 Footer

The Full Disclosure Report contains a footer at the bottom of every page. The footer includes:

- The date and time of the print request. The format displayed is taken from the **System Date/Time** tab. For more information regarding date/time formats, refer to the "Date/Time Tab" on page 9-41.
- A centered page number.
- The name of the Panorama Central Station where the report was generated.

8.1.3.4 Printing a Full Disclosure Report (ECG and Non-ECG Layout)

The Full Disclosure Report is printed in portrait orientation, using any of the following methods:

To print one hour of full disclosure data (ECG layout):

1. Select the **Full Disclosure Report** button in the **Patient Reports** tab. The Print Selection dialog is displayed (shown in FIGURE 8-9).

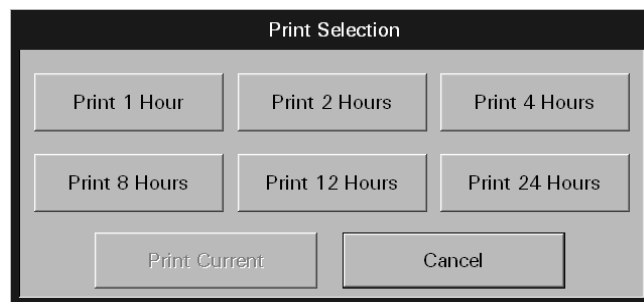

FIGURE 8-9 Print Selection Dialog Box

2. Select the **Print 1 Hour** button. The report is sent to the printer.

To print one hour of full disclosure data (non-ECG layout):

1. From the **Disclosure** tab, select the **Display Choices** sidebar button. The Display Choices dialog box is displayed (shown in FIGURE 8-10).

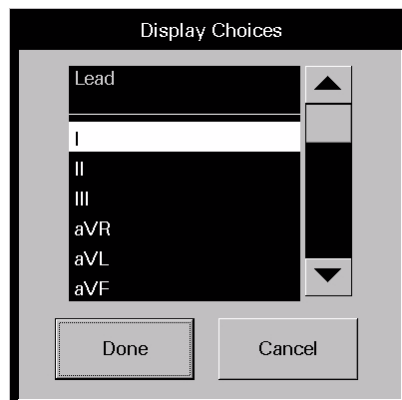

FIGURE 8-10 Display Choices Dialog Box

2. Select a non-ECG parameter from the list box, then select the **Done** button. The waveforms in the tab will change to the selected non-ECG parameter.
3. From the menu bar, select the **Print** button. The Print Selection dialog is displayed (shown in FIGURE 8-9).
4. Select the **Print 1 Hour** button. The report is sent to the printer.

To print multiple hours of full disclosure data:

1. From the **Patient Reports** tab, select the **Full Disclosure Report** button.
2. From the menu bar, select the **Print** button. The Print Selection dialog is displayed.
3. Select one of the time interval buttons or the **Cancel** button.
 - The choices are print 1 hour, 2 hours, 4 hours, 8 hours, 12 hours, and 24 hours.
 - Select the **Cancel** button to close the dialog box without generating the print request.

To print multiple hours of full disclosure data (non-ECG layout):

1. From the **Disclosure** tab, select the **Display Choices** sidebar button. The Display Choices dialog box is displayed.
2. Select a non-ECG parameter from the list box, then select the **Done** button. The waveforms in the **Disclosure** tab will change to the selected non-ECG parameter.
3. From the menu bar, select the **Print** button. The Print Selection dialog is displayed (shown in FIGURE 8-9).
4. Select one of the time interval buttons or the **Cancel** button.
 - The choices are print 1 hour, 2 hours, 4 hours, 8 hours, 12 hours, and 24 hours.
 - Select the **Cancel** button to close the dialog box without generating the print request.

Requesting either report posts a print job in the system Print Status tab. For additional information, refer to the "Print Status Tab" on page 8-38.

8.1.4 ST Report

The ST Report (shown in FIGURE 8-11 and FIGURE 8-12) includes current and reference digital values with the associated ST templates, for a selected patient tile. This report includes a header, ST data and a footer section.

NOTE: This report is not available when using a WMTS 608 wireless bedside device, during a relearning phase, or when the selected patient tile is in a Communications Lost, Standby, or a Waiting for Patient state.

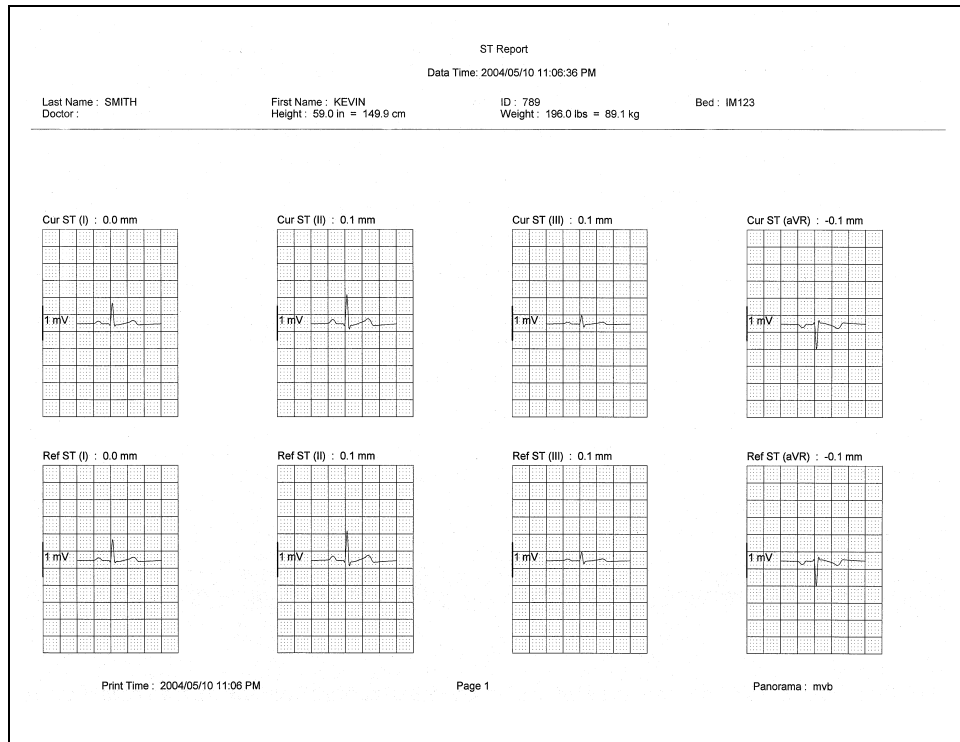

FIGURE 8-11 ST Report (Page 1)

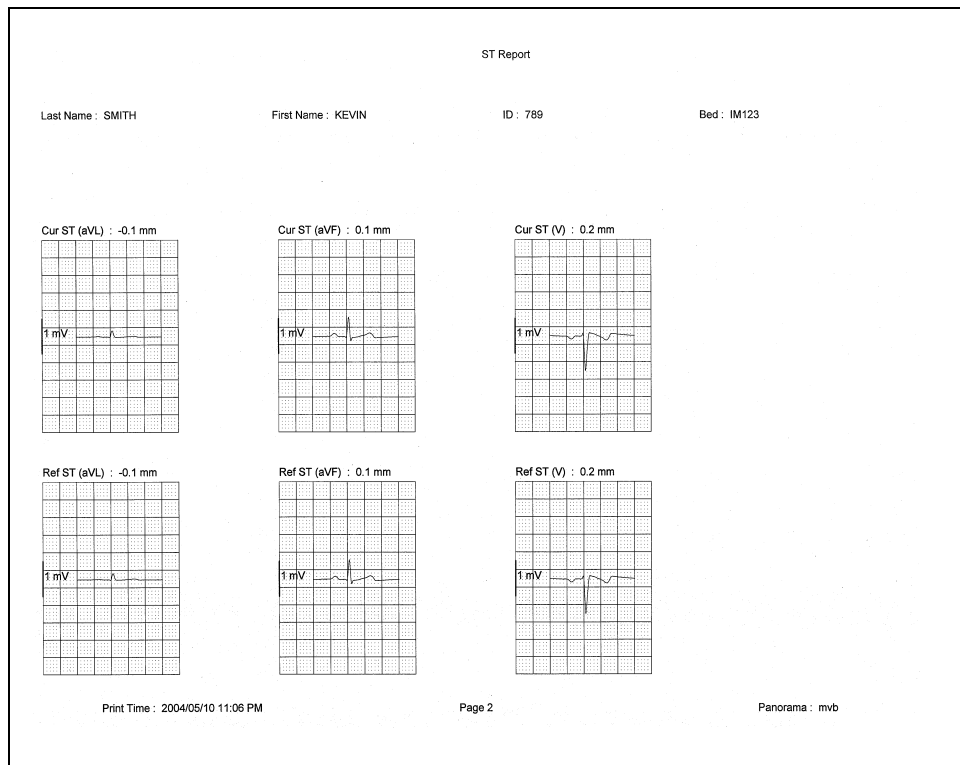

FIGURE 8-12 ST Report (Page 2)

8.1.4.1 Header

The ST Report's first page header provides the title of the report and basic demographic information, if it is available. The demographic information includes the patient's first and last name, identification number, bed number, weight, height and doctor.

Page headers on subsequent pages of the report provide the report title, the date and time the data was collected, and limited demographic information about the patient (first and last name, identification number and bed number), if it is available.

If the demographic data was not previously entered in the system, only the demographic label is shown.

8.1.4.2 ST Data

The ST Report's data section includes current and reference templates for the ST data. ST data is shown in millimeter (mm) measurements. The ST templates shown in the report are limited to the ECG lead connections currently in use and selected in the **Print Setup** tab.

- One current and one reference template for the lead being monitored in a 3-lead cable connection.
- Three current and three reference templates for the leads being monitored in a 5-lead cable connection.
- Twelve current and twelve reference templates for all of the leads in a 12-lead cable connection.

Current Templates

The current templates shown in the ST Report are limited to the ECG lead connections currently in use and the waveforms the patient has selected in the **Print Setup** tab.

- Current templates in the report contain a label section above the ST data that includes CUR, the ST lead and the ST measurement.
- Current ST values display in brackets ([]), if the data represents an alarm condition.
- Current ST values in the report print on a calibrated grid with a scale bar, which corresponds to the ECG wave gain measurement.

Reference Templates

The reference templates shown in the ST Report are limited to the ECG lead wire set currently in use and the waveforms selected.

- Reference templates in the report contain a label section above the ST data that includes REF, the ST lead and the ST measurement.
- Reference ST values display in brackets ([]), if the data is in an alarm condition.
- Reference ST values in the report print on a calibrated grid with a scale bar, which corresponds to the ECG wave gain measurement.

8.1.4.3 Footer

The ST Report contains a footer at the bottom of every page. The footer includes:

- The date and time of the print request. The format displayed is taken from the **System Date/Time** tab.
- A centered page number.
- The name of the Panorama Central Station where the report was generated.

8.1.4.4 Printing an ST Report

The ST Report is printed in landscape orientation, using any of the following methods:

- From the **Patient Reports** tab, select the **ST Report** button.
- From the menu bar, select the **Print** button.

Requesting this report posts a print job in the system Print Status tab. For additional information, refer to the "Print Status Tab" on page 8-38.

8.1.5 Trend List Report

The Trend List Report (shown in FIGURE 8-13 and FIGURE 8-14) shows a patient's historical trended digital data. The data displayed is based on the time interval selected in the Trend Display dialog box, and can be shown over a 1, 2, 4, 8, 12, or 24 hour time period. This report includes a header, trend records, and a footer.

Trend List Report		
Last Name: PANASON	First Name: SAMMY	ID: 123ICU
Doctor: zoen	Bed:	
Height: 64.0 in = 162.6 cm	Weight: 301.0 lbs = 136.8 kg	
Date / Time: 2004/12/17 08:18:23 PM		
HR(ECG): 80 BPM SpO2: 96 % Resp(CO2): 18 RPM CO2: 0 INSP / 34 ET mmHg PVC/min: 0 IBP1: 117 / 77 (93) mmHg		
IBP2: 116 / -2 (42) mmHg IBP3: 119 / 79 (95) mmHg IBP4: 23 / 8 (13) mmHg T1: 74.4 °F T2: 83.9 °F		
Delta T(T1,T2): 9.5 °F ST (I): (C) -0.1 / (R) -0.1 mm ST (II): (C) -0.2 / (R) -0.2 mm ST (III): (C) -0.1 / (R) -0.1 mm		
ST (aVR): (C) 0.1 / (R) 0.1 mm ST (aVL): (C) 0.0 / (R) 0.0 mm ST (aVF): (C) -0.1 / (R) -0.1 mm ST (V1): (C) 0.0 / (R) 0.0 mm		
ST (V2): (C) - / (R) - mm ST (V3): (C) - / (R) - mm ST (V4): (C) - / (R) - mm ST (V5): (C) - / (R) - mm		
ST (V6): (C) - / (R) - mm		
Date / Time: 2004/12/17 08:17:23 PM		
HR(ECG): 80 BPM SpO2: 96 % Resp(CO2): 18 RPM CO2: 0 INSP / 34 ET mmHg PVC/min: 0 IBP1: 117 / 77 (93) mmHg		
IBP2: 116 / -2 (42) mmHg IBP3: 119 / 79 (95) mmHg IBP4: 23 / 8 (13) mmHg T1: 74.3 °F T2: 83.9 °F		
Delta T(T1,T2): 9.6 °F ST (I): (C) -0.1 / (R) -0.1 mm ST (II): (C) -0.2 / (R) -0.2 mm ST (III): (C) -0.1 / (R) -0.1 mm		
ST (aVR): (C) 0.1 / (R) 0.1 mm ST (aVL): (C) 0.0 / (R) 0.0 mm ST (aVF): (C) -0.1 / (R) -0.1 mm ST (V1): (C) 0.0 / (R) 0.0 mm		
ST (V2): (C) - / (R) - mm ST (V3): (C) - / (R) - mm ST (V4): (C) - / (R) - mm ST (V5): (C) - / (R) - mm		
ST (V6): (C) - / (R) - mm		
Date / Time: 2004/12/17 08:16:23 PM		
HR(ECG): 80 BPM SpO2: 96 % Resp(CO2): 18 RPM CO2: 0 INSP / 34 ET mmHg PVC/min: 0 IBP1: 117 / 77 (93) mmHg		
IBP2: 116 / -2 (42) mmHg IBP3: 119 / 79 (95) mmHg IBP4: 23 / 8 (13) mmHg T1: 74.4 °F T2: 83.9 °F		
Delta T(T1,T2): 9.5 °F ST (I): (C) -0.1 / (R) -0.1 mm ST (II): (C) -0.2 / (R) -0.2 mm ST (III): (C) -0.1 / (R) -0.1 mm		
ST (aVR): (C) 0.1 / (R) 0.1 mm ST (aVL): (C) 0.0 / (R) 0.0 mm ST (aVF): (C) -0.1 / (R) -0.1 mm ST (V1): (C) 0.0 / (R) 0.0 mm		
ST (V2): (C) - / (R) - mm ST (V3): (C) - / (R) - mm ST (V4): (C) - / (R) - mm ST (V5): (C) - / (R) - mm		
ST (V6): (C) - / (R) - mm		
Date / Time: 2004/12/17 08:15:23 PM		
HR(ECG): 80 BPM SpO2: 96 % Resp(CO2): 18 RPM CO2: 0 INSP / 34 ET mmHg PVC/min: 0 IBP1: 117 / 77 (93) mmHg		
IBP2: 116 / -2 (42) mmHg IBP3: 119 / 79 (95) mmHg IBP4: 23 / 8 (13) mmHg T1: 74.3 °F T2: 83.9 °F		
Delta T(T1,T2): 9.6 °F ST (I): (C) -0.1 / (R) -0.1 mm ST (II): (C) -0.2 / (R) -0.2 mm ST (III): (C) -0.1 / (R) -0.1 mm		
ST (aVR): (C) 0.1 / (R) 0.1 mm ST (aVL): (C) 0.0 / (R) 0.0 mm ST (aVF): (C) -0.1 / (R) -0.1 mm ST (V1): (C) 0.0 / (R) 0.0 mm		
ST (V2): (C) - / (R) - mm ST (V3): (C) - / (R) - mm ST (V4): (C) - / (R) - mm ST (V5): (C) - / (R) - mm		
ST (V6): (C) - / (R) - mm		
Date / Time: 2004/12/17 08:14:23 PM		
HR(ECG): 80 BPM SpO2: 96 % Resp(CO2): 18 RPM CO2: 0 INSP / 34 ET mmHg PVC/min: 0 IBP1: 117 / 77 (93) mmHg		
IBP2: 116 / -2 (42) mmHg IBP3: 119 / 79 (95) mmHg IBP4: 23 / 8 (13) mmHg T1: 74.4 °F T2: 83.9 °F		
Delta T(T1,T2): 9.5 °F ST (I): (C) -0.1 / (R) -0.1 mm ST (II): (C) -0.2 / (R) -0.2 mm ST (III): (C) -0.1 / (R) -0.1 mm		
ST (aVR): (C) 0.1 / (R) 0.1 mm ST (aVL): (C) 0.0 / (R) 0.0 mm ST (aVF): (C) -0.1 / (R) -0.1 mm ST (V1): (C) 0.0 / (R) 0.0 mm		
ST (V2): (C) - / (R) - mm ST (V3): (C) - / (R) - mm ST (V4): (C) - / (R) - mm ST (V5): (C) - / (R) - mm		
ST (V6): (C) - / (R) - mm		
Date / Time: 2004/12/17 08:13:23 PM		
HR(ECG): 80 BPM SpO2: 96 % Resp(CO2): 18 RPM CO2: 0 INSP / 34 ET mmHg PVC/min: 0 IBP1: 117 / 77 (93) mmHg		
IBP2: 116 / -2 (42) mmHg IBP3: 119 / 79 (95) mmHg IBP4: 23 / 8 (13) mmHg T1: 74.3 °F T2: 83.9 °F		
Delta T(T1,T2): 9.6 °F ST (I): (C) -0.1 / (R) -0.1 mm ST (II): (C) -0.2 / (R) -0.2 mm ST (III): (C) -0.1 / (R) -0.1 mm		
ST (aVR): (C) 0.1 / (R) 0.1 mm ST (aVL): (C) 0.0 / (R) 0.0 mm ST (aVF): (C) -0.1 / (R) -0.1 mm ST (V1): (C) 0.0 / (R) 0.0 mm		
ST (V2): (C) - / (R) - mm ST (V3): (C) - / (R) - mm ST (V4): (C) - / (R) - mm ST (V5): (C) - / (R) - mm		
ST (V6): (C) - / (R) - mm		
Date / Time: 2004/12/17 08:12:23 PM		
HR(ECG): 80 BPM SpO2: 96 % Resp(CO2): 18 RPM CO2: 0 INSP / 34 ET mmHg PVC/min: 0 IBP1: 117 / 77 (93) mmHg		
IBP2: 116 / -2 (42) mmHg IBP3: 119 / 79 (95) mmHg IBP4: 23 / 8 (13) mmHg T1: 74.4 °F T2: 83.9 °F		
Delta T(T1,T2): 9.5 °F ST (I): (C) -0.1 / (R) -0.1 mm ST (II): (C) -0.2 / (R) -0.2 mm ST (III): (C) -0.1 / (R) -0.1 mm		
ST (aVR): (C) 0.1 / (R) 0.1 mm ST (aVL): (C) 0.0 / (R) 0.0 mm ST (aVF): (C) -0.1 / (R) -0.1 mm ST (V1): (C) 0.0 / (R) 0.0 mm		
ST (V2): (C) - / (R) - mm ST (V3): (C) - / (R) - mm ST (V4): (C) - / (R) - mm ST (V5): (C) - / (R) - mm		
ST (V6): (C) - / (R) - mm		
Date / Time: 2004/12/17 08:11:23 PM		
HR(ECG): 80 BPM SpO2: 96 % Resp(CO2): 18 RPM CO2: 0 INSP / 34 ET mmHg PVC/min: 0 IBP1: 117 / 77 (93) mmHg		
IBP2: 116 / -2 (42) mmHg IBP3: 119 / 79 (95) mmHg IBP4: 23 / 8 (13) mmHg T1: 74.3 °F T2: 83.9 °F		
Delta T(T1,T2): 9.6 °F ST (I): (C) -0.1 / (R) -0.1 mm ST (II): (C) -0.2 / (R) -0.2 mm ST (III): (C) -0.1 / (R) -0.1 mm		
ST (aVR): (C) 0.1 / (R) 0.1 mm ST (aVL): (C) 0.0 / (R) 0.0 mm ST (aVF): (C) -0.1 / (R) -0.1 mm ST (V1): (C) 0.0 / (R) 0.0 mm		
ST (V2): (C) - / (R) - mm ST (V3): (C) - / (R) - mm ST (V4): (C) - / (R) - mm ST (V5): (C) - / (R) - mm		
ST (V6): (C) - / (R) - mm		
Print Time: 2004/12/17 08:19 PM		
Page 1		
Panorama: MICHELLEUI		

FIGURE 8-13 Trend List Report (Page 1)

Trend List Report	
Last Name : PANASON ID : 123ICU	First Name : SAMMY Bed :
Date / Time: 2004/12/17 08:10:23 PM HR(ECG): 80 BPM SpO2: 96 % Resp(CO2): 18 RPM CO2: 0 INSP / 34 ET mmHg PVC/min: 0 IBP1: 117 / 77 (93) mmHg IBP2: 116 / -2 (42) mmHg IBP3: 119 / 79 (95) mmHg IBP4: 23 / 8 (13) mmHg T1: 74.4 °F T2: 83.9 °F Delta T(T1,T2): 9.5 °F ST (I): (C) -0.1 / (R) -0.1 mm ST (II): (C) -0.2 / (R) -0.2 mm ST (III): (C) -0.1 / (R) -0.1 mm ST (aVR): (C) 0.1 / (R) 0.1 mm ST (aVL): (C) 0.0 / (R) 0.0 mm ST (aVF): (C) -0.1 / (R) -0.1 mm ST (V1): (C) 0.0 / (R) 0.0 mm ST (V2): (C) - / (R) - mm ST (V3): (C) - / (R) - mm ST (V4): (C) - / (R) - mm ST (V5): (C) - / (R) - mm ST (V6): (C) - / (R) - mm	
Date / Time: 2004/12/17 08:09:23 PM HR(ECG): 80 BPM SpO2: 96 % Resp(CO2): 18 RPM CO2: 0 INSP / 34 ET mmHg PVC/min: 0 IBP1: 117 / 77 (93) mmHg IBP2: 116 / -2 (42) mmHg IBP3: 119 / 79 (95) mmHg IBP4: 23 / 8 (13) mmHg T1: 74.3 °F T2: 83.9 °F Delta T(T1,T2): 9.6 °F ST (I): (C) -0.1 / (R) -0.1 mm ST (II): (C) -0.2 / (R) -0.2 mm ST (III): (C) -0.1 / (R) -0.1 mm ST (aVR): (C) 0.1 / (R) 0.1 mm ST (aVL): (C) 0.0 / (R) 0.0 mm ST (aVF): (C) -0.1 / (R) -0.1 mm ST (V1): (C) 0.0 / (R) 0.0 mm ST (V2): (C) - / (R) - mm ST (V3): (C) - / (R) - mm ST (V4): (C) - / (R) - mm ST (V5): (C) - / (R) - mm ST (V6): (C) - / (R) - mm	
Date / Time: 2004/12/17 08:08:23 PM HR(ECG): 80 BPM SpO2: 96 % Resp(CO2): 18 RPM CO2: 0 INSP / 34 ET mmHg PVC/min: 0 IBP1: 117 / 77 (93) mmHg IBP2: 116 / -2 (42) mmHg IBP3: 119 / 79 (95) mmHg IBP4: 23 / 8 (13) mmHg T1: 74.4 °F T2: 83.9 °F Delta T(T1,T2): 9.5 °F ST (I): (C) -0.1 / (R) -0.1 mm ST (II): (C) -0.2 / (R) -0.2 mm ST (III): (C) -0.1 / (R) -0.1 mm ST (aVR): (C) 0.1 / (R) 0.1 mm ST (aVL): (C) 0.0 / (R) 0.0 mm ST (aVF): (C) -0.1 / (R) -0.1 mm ST (V1): (C) 0.0 / (R) 0.0 mm ST (V2): (C) - / (R) - mm ST (V3): (C) - / (R) - mm ST (V4): (C) - / (R) - mm ST (V5): (C) - / (R) - mm ST (V6): (C) - / (R) - mm	
Date / Time: 2004/12/17 08:07:23 PM HR(ECG): 80 BPM SpO2: 96 % Resp(CO2): 18 RPM CO2: 0 INSP / 34 ET mmHg PVC/min: 0 IBP1: 117 / 77 (93) mmHg IBP2: 116 / -2 (42) mmHg IBP3: 119 / 79 (95) mmHg IBP4: 23 / 8 (13) mmHg T1: 74.3 °F T2: 83.9 °F Delta T(T1,T2): 9.6 °F ST (I): (C) -0.1 / (R) -0.1 mm ST (II): (C) -0.2 / (R) -0.2 mm ST (III): (C) -0.1 / (R) -0.1 mm ST (aVR): (C) 0.1 / (R) 0.1 mm ST (aVL): (C) 0.0 / (R) 0.0 mm ST (aVF): (C) -0.1 / (R) -0.1 mm ST (V1): (C) 0.0 / (R) 0.0 mm ST (V2): (C) - / (R) - mm ST (V3): (C) - / (R) - mm ST (V4): (C) - / (R) - mm ST (V5): (C) - / (R) - mm ST (V6): (C) - / (R) - mm	
Date / Time: 2004/12/17 08:06:23 PM HR(ECG): 80 BPM SpO2: 96 % Resp(CO2): 18 RPM CO2: 0 INSP / 34 ET mmHg PVC/min: 0 IBP1: 117 / 77 (93) mmHg IBP2: 116 / -2 (42) mmHg IBP3: 119 / 79 (95) mmHg IBP4: 23 / 8 (13) mmHg T1: 74.4 °F T2: 83.9 °F Delta T(T1,T2): 9.5 °F ST (I): (C) -0.1 / (R) -0.1 mm ST (II): (C) -0.2 / (R) -0.2 mm ST (III): (C) -0.1 / (R) -0.1 mm ST (aVR): (C) 0.1 / (R) 0.1 mm ST (aVL): (C) 0.0 / (R) 0.0 mm ST (aVF): (C) -0.1 / (R) -0.1 mm ST (V1): (C) 0.0 / (R) 0.0 mm ST (V2): (C) - / (R) - mm ST (V3): (C) - / (R) - mm ST (V4): (C) - / (R) - mm ST (V5): (C) - / (R) - mm ST (V6): (C) - / (R) - mm	
Date / Time: 2004/12/17 08:05:23 PM HR(ECG): 80 BPM SpO2: 96 % Resp(CO2): 18 RPM CO2: 0 INSP / 34 ET mmHg PVC/min: 0 IBP1: 117 / 77 (93) mmHg IBP2: 116 / -2 (42) mmHg IBP3: 119 / 79 (95) mmHg IBP4: 23 / 8 (13) mmHg T1: 74.3 °F T2: 83.9 °F Delta T(T1,T2): 9.6 °F ST (I): (C) -0.1 / (R) -0.1 mm ST (II): (C) -0.2 / (R) -0.2 mm ST (III): (C) -0.1 / (R) -0.1 mm ST (aVR): (C) 0.1 / (R) 0.1 mm ST (aVL): (C) 0.0 / (R) 0.0 mm ST (aVF): (C) -0.1 / (R) -0.1 mm ST (V1): (C) 0.0 / (R) 0.0 mm ST (V2): (C) - / (R) - mm ST (V3): (C) - / (R) - mm ST (V4): (C) - / (R) - mm ST (V5): (C) - / (R) - mm ST (V6): (C) - / (R) - mm	
Date / Time: 2004/12/17 08:04:23 PM HR(ECG): 80 BPM SpO2: 96 % Resp(CO2): 18 RPM CO2: 0 INSP / 34 ET mmHg PVC/min: 0 IBP1: 117 / 77 (93) mmHg IBP2: 116 / -2 (42) mmHg IBP3: 119 / 79 (95) mmHg IBP4: 23 / 8 (13) mmHg T1: 74.4 °F T2: 83.9 °F Delta T(T1,T2): 9.5 °F ST (I): (C) -0.1 / (R) -0.1 mm ST (II): (C) -0.2 / (R) -0.2 mm ST (III): (C) -0.1 / (R) -0.1 mm ST (aVR): (C) 0.1 / (R) 0.1 mm ST (aVL): (C) 0.0 / (R) 0.0 mm ST (aVF): (C) -0.1 / (R) -0.1 mm ST (V1): (C) 0.0 / (R) 0.0 mm ST (V2): (C) - / (R) - mm ST (V3): (C) - / (R) - mm ST (V4): (C) - / (R) - mm ST (V5): (C) - / (R) - mm ST (V6): (C) - / (R) - mm	
Date / Time: 2004/12/17 08:03:23 PM HR(ECG): 80 BPM SpO2: 96 % Resp(CO2): 18 RPM CO2: 0 INSP / 34 ET mmHg PVC/min: 0 IBP1: 117 / 77 (93) mmHg IBP2: 116 / -2 (42) mmHg IBP3: 119 / 79 (95) mmHg IBP4: 23 / 8 (13) mmHg T1: 74.3 °F T2: 83.9 °F Delta T(T1,T2): 9.6 °F ST (I): (C) -0.1 / (R) -0.1 mm ST (II): (C) -0.2 / (R) -0.2 mm ST (III): (C) -0.1 / (R) -0.1 mm ST (aVR): (C) 0.1 / (R) 0.1 mm ST (aVL): (C) 0.0 / (R) 0.0 mm ST (aVF): (C) -0.1 / (R) -0.1 mm ST (V1): (C) 0.0 / (R) 0.0 mm ST (V2): (C) - / (R) - mm ST (V3): (C) - / (R) - mm ST (V4): (C) - / (R) - mm ST (V5): (C) - / (R) - mm ST (V6): (C) - / (R) - mm	

Print Time: 2004/12/17 08:19 PM

Page 2

Panorama: MICHELLEUI

FIGURE 8-14 Trend List Report (Page 2)

8.1.5.1 Header

The Trend List Report's first page header provides the title of the report and basic demographic information, if it is available. The demographic information includes the patient's first and last name, identification number, bed number, weight, height and doctor.

Page headers on subsequent pages of the report provide the report title, the date and time the data was collected, and limited demographic information about the patient (first and last name, identification number and bed number), if it is available.

If the demographic data was not previously entered in the system, only the demographic label is shown.

8.1.5.2 Trend Records

The Trend List Report's digital data section includes the digital data that occurred for the selected patient, based on the time interval selected in the Trend Display dialog box. The data printed in the report is determined by the device connected to the selected patient tile and the sensors in use.

The report displays digital data records for each minute of the selected time period. Digital data records are separated by a solid horizontal line. If data is not available for the selected time period, the report will not print. Each digital record in the report contains the following:

- The time format follows the system format specified in the **Date/Time** tab.
- Digital data values for the parameters specific to the device connected to the patient tile and the sensors used during the specified time period.
- A heart rate (HR) value. The source of the heart rate data is shown in parentheses next to the HR label. If data is not available for the specified time period, dashes are shown in the place of a heart rate value.
- Digital Data records in the report use brackets ([]) to distinguish data in the alarm condition.

8.1.5.3 Footer

The Trend List Report contains a footer at the bottom of every page. The footer includes:

- The date and time of the print request. The format displayed is taken from the **System Date/Time** tab.
- A centered page number.
- The name of the Panorama Central Station where the report was generated.

8.1.5.4 Printing a Trend List Report

The Trend List Report is printed in portrait orientation.

To print one hour of trend data:

- From the Patient Reports tab, select the **Trend List Report** button. The Print Selection dialog is displayed (shown in FIGURE 8-9).
- Select the **Print 1 Hour** button. The report is sent to the printer.

To print multiple hours of trend data from the **Patient Reports** tab:

1. Select the **Trend List Report** button.
2. Select one of the time interval buttons or the **Cancel** button.
 - The choices are print 1 hour, 2 hours, 4 hours, 8 hours, 12 hours, and 24 hours.
 - Select the **Cancel** button to close the dialog box without generating the print request.

To print multiple hours of trend data from the **Trends** tab:

1. From the menu bar, select the **Print** button. The Print Selection dialog is displayed.
2. Select the **Print Current** button, a time interval button, or the **Cancel** button.
 - Select the **Print Current** to create a one page Trend List Report.
 - Select one of the time interval buttons. The choices are print 1 hour, 2 hours, 4 hours, 8 hours, 12 hours, and 24 hours.
 - Select the **Cancel** button to close the dialog box without generating the print request.

Requesting this report posts a print job in the system Print Status tab. For additional information, refer to the "Print Status Tab" on page 8-38.

8.1.6 Event List Report

The Event List Report (shown in FIGURE 8-15 and FIGURE 8-16) shows a patient's historical physiological, system and technical alarm events for a 1, 2, 4, 8, 12 and 24 hour time period. This report includes a header, event records, and a footer.

Event List Report	
Last Name: PANASON Doctor: zoen Height: 64.0 in = 162.6 cm	First Name: SAMMY Bed: Weight: 301.0 lbs = 136.8 kg
ID: 123ICU	
Total Events: 48 Event Filter: All	Displayed Events: 48
Date : 2004/12/17 05:54:30 PM Event: Run	
HR(ECG): 220 BPM SpO2: 96 % Resp(CO2): 18 RPM CO2: 0 INSP / 34 ET mmHg PVC/min: --- IBP1: 117 / 77 (93) mmHg IBP2: 116 / -2 (42) mmHg IBP3: 119 / 79 (95) mmHg IBP4: 23 / 8 (13) mmHg T1: 74.4 °F T2: 83.9 °F Delta T(T1,T2): 9.5 °F	
Date : 2004/12/17 05:54:29 PM Event: Bigeminy	
HR(ECG): --- BPM SpO2: 96 % Resp(CO2): 18 RPM CO2: 0 INSP / 34 ET mmHg PVC/min: --- IBP1: 117 / 77 (93) mmHg IBP2: 116 / -2 (42) mmHg IBP3: 119 / 79 (95) mmHg IBP4: 23 / 8 (13) mmHg T1: 74.4 °F T2: 83.9 °F Delta T(T1,T2): 9.5 °F	
Date : 2004/12/17 05:53:58 PM Event: Couplet	
HR(ECG): --- BPM SpO2: 96 % Resp(CO2): 18 RPM CO2: 0 INSP / 34 ET mmHg PVC/min: --- IBP1: 117 / 77 (93) mmHg IBP2: 116 / -2 (42) mmHg IBP3: 119 / 79 (95) mmHg IBP4: 23 / 8 (13) mmHg T1: 74.4 °F T2: 83.9 °F Delta T(T1,T2): 9.5 °F	
Date : 2004/12/17 05:53:56 PM Event: Run	
HR(ECG): 221 BPM SpO2: 96 % Resp(CO2): 18 RPM CO2: 0 INSP / 34 ET mmHg PVC/min: --- IBP1: 117 / 77 (93) mmHg IBP2: 116 / -2 (42) mmHg IBP3: 119 / 79 (95) mmHg IBP4: 23 / 8 (13) mmHg T1: 74.4 °F T2: 83.9 °F Delta T(T1,T2): 9.5 °F	
Date : 2004/12/17 05:53:45 PM Event: Run	
HR(ECG): --- BPM SpO2: 96 % Resp(CO2): 18 RPM CO2: 0 INSP / 34 ET mmHg PVC/min: --- IBP1: 117 / 77 (93) mmHg IBP2: 116 / -2 (42) mmHg IBP3: 119 / 79 (95) mmHg IBP4: 23 / 8 (13) mmHg T1: 74.3 °F T2: 83.9 °F Delta T(T1,T2): 9.6 °F	
Date : 2004/12/17 05:53:40 PM Event: Bigeminy	
HR(ECG): --- BPM SpO2: 96 % Resp(CO2): 18 RPM CO2: 0 INSP / 34 ET mmHg PVC/min: --- IBP1: 117 / 77 (93) mmHg IBP2: 116 / -2 (42) mmHg IBP3: 119 / 79 (95) mmHg IBP4: 23 / 8 (13) mmHg T1: 74.4 °F T2: 83.9 °F Delta T(T1,T2): 9.5 °F	
Date : 2004/12/17 05:53:37 PM Event: Couplet	
HR(ECG): --- BPM SpO2: 96 % Resp(CO2): 18 RPM CO2: 0 INSP / 34 ET mmHg PVC/min: --- IBP1: 117 / 77 (93) mmHg IBP2: 116 / -2 (42) mmHg IBP3: 119 / 79 (95) mmHg IBP4: 23 / 8 (13) mmHg T1: 74.3 °F T2: 83.9 °F Delta T(T1,T2): 9.6 °F	
Date : 2004/12/17 05:53:11 PM Event: Couplet	
HR(ECG): 220 BPM SpO2: 96 % Resp(CO2): 18 RPM CO2: 0 INSP / 34 ET mmHg PVC/min: --- IBP1: 117 / 77 (93) mmHg IBP2: 116 / -2 (42) mmHg IBP3: 119 / 79 (95) mmHg IBP4: 23 / 8 (13) mmHg T1: 74.4 °F T2: 83.9 °F Delta T(T1,T2): 9.5 °F	
Date : 2004/12/17 05:53:03 PM Event: Run	
HR(ECG): 220 BPM SpO2: 96 % Resp(CO2): 18 RPM CO2: 0 INSP / 34 ET mmHg PVC/min: --- IBP1: 117 / 77 (93) mmHg IBP2: 116 / -2 (42) mmHg IBP3: 119 / 79 (95) mmHg IBP4: 23 / 8 (13) mmHg T1: 74.4 °F T2: 83.9 °F Delta T(T1,T2): 9.5 °F	
Date : 2004/12/17 05:52:51 PM Event: Run	
HR(ECG): 185 BPM SpO2: 96 % Resp(CO2): 18 RPM CO2: 0 INSP / 34 ET mmHg PVC/min: --- IBP1: 117 / 77 (93) mmHg IBP2: 116 / -2 (42) mmHg IBP3: 119 / 79 (95) mmHg IBP4: 23 / 8 (13) mmHg T1: 74.4 °F T2: 83.9 °F Delta T(T1,T2): 9.5 °F	
Date : 2004/12/17 05:52:38 PM Event: Couplet	
HR(ECG): 185 BPM SpO2: 96 % Resp(CO2): 18 RPM CO2: 0 INSP / 34 ET mmHg PVC/min: --- IBP1: 117 / 77 (93) mmHg IBP2: 116 / -2 (42) mmHg IBP3: 119 / 79 (95) mmHg IBP4: 23 / 8 (13) mmHg T1: 74.4 °F T2: 83.9 °F Delta T(T1,T2): 9.5 °F	
Print Time: 2004/12/17 05:55 PM	Page 1
Panorama: MICHELLEUI	

FIGURE 8-15 Event List Report (Page 1)

Event List Report	
Last Name : PANASON ID : 123ICU	First Name : SAMMY Bed :
Date : 2004/12/17 05:52:36 PM	Event: Run
HR(ECG): 185 BPM SpO2: 96 % Resp(CO2): 18 RPM CO2: 0 INSP / 34 ET mmHg PVC/min: --- IBP1: 117 / 77 (93) mmHg IBP2: 116 / -2 (42) mmHg IBP3: 119 / 79 (95) mmHg IBP4: 23 / 8 (13) mmHg T1: 74.4 °F T2: 83.9 °F Delta T(T1,T2): 9.5 °F	
Date : 2004/12/17 05:52:36 PM	Event: V-Tach
HR(ECG): 185 BPM SpO2: 96 % Resp(CO2): 18 RPM CO2: 0 INSP / 34 ET mmHg PVC/min: --- IBP1: 117 / 77 (93) mmHg IBP2: 116 / -2 (42) mmHg IBP3: 119 / 79 (95) mmHg IBP4: 23 / 8 (13) mmHg T1: 74.4 °F T2: 83.9 °F Delta T(T1,T2): 9.5 °F	
Date : 2004/12/17 05:52:34 PM	Event: Run
HR(ECG): 137 BPM SpO2: 96 % Resp(CO2): 18 RPM CO2: 0 INSP / 34 ET mmHg PVC/min: 5 IBP1: 117 / 77 (93) mmHg IBP2: 116 / -2 (42) mmHg IBP3: 119 / 79 (95) mmHg IBP4: 23 / 8 (13) mmHg T1: 74.4 °F T2: 83.9 °F Delta T(T1,T2): 9.5 °F	
Date : 2004/12/17 05:52:00 PM	Event: V-Rhythm
HR(ECG): 40 BPM SpO2: 96 % Resp(CO2): 18 RPM CO2: 0 INSP / 34 ET mmHg PVC/min: --- IBP1: 117 / 77 (93) mmHg IBP2: 116 / -2 (42) mmHg IBP3: 119 / 79 (95) mmHg IBP4: 23 / 8 (13) mmHg T1: 74.3 °F T2: 83.9 °F Delta T(T1,T2): 9.6 °F	
Date : 2004/12/17 05:51:48 PM	Event: V-Rhythm
HR(ECG): 48 BPM SpO2: 96 % Resp(CO2): 18 RPM CO2: 0 INSP / 34 ET mmHg PVC/min: 4 IBP1: 117 / 77 (93) mmHg IBP2: 116 / -2 (42) mmHg IBP3: 119 / 79 (95) mmHg IBP4: 23 / 8 (13) mmHg T1: 74.4 °F T2: 83.9 °F Delta T(T1,T2): 9.5 °F	
Date : 2004/12/17 05:51:45 PM	Event: Pause
HR(ECG): 84 BPM SpO2: 96 % Resp(CO2): 18 RPM CO2: 0 INSP / 34 ET mmHg PVC/min: 1 IBP1: 117 / 77 (93) mmHg IBP2: 116 / -2 (42) mmHg IBP3: 119 / 79 (95) mmHg IBP4: 23 / 8 (13) mmHg T1: 74.3 °F T2: 83.9 °F Delta T(T1,T2): 9.6 °F	
Date : 2004/12/17 05:51:27 PM	Event: V-Rhythm
HR(ECG): 84 BPM SpO2: 96 % Resp(CO2): 18 RPM CO2: 0 INSP / 34 ET mmHg PVC/min: 1 IBP1: 117 / 77 (93) mmHg IBP2: 116 / -2 (42) mmHg IBP3: 119 / 79 (95) mmHg IBP4: 23 / 8 (13) mmHg T1: 74.4 °F T2: 83.9 °F Delta T(T1,T2): 9.5 °F	
Date : 2004/12/17 05:41:57 PM	Event: Central User Marked Event
HR(ECG): 80 BPM SpO2: 96 % Resp(CO2): 18 RPM CO2: 0 INSP / 34 ET mmHg PVC/min: 0 IBP1: 117 / 77 (93) mmHg IBP2: 116 / -2 (42) mmHg IBP3: 119 / 79 (95) mmHg IBP4: 23 / 8 (13) mmHg T1: 74.4 °F T2: 83.9 °F Delta T(T1,T2): 9.5 °F	
Date : 2004/12/17 05:41:56 PM	Event: Central User Marked Event
HR(ECG): 80 BPM SpO2: 96 % Resp(CO2): 18 RPM CO2: 0 INSP / 34 ET mmHg PVC/min: 0 IBP1: 117 / 77 (93) mmHg IBP2: 116 / -2 (42) mmHg IBP3: 119 / 79 (95) mmHg IBP4: 23 / 8 (13) mmHg T1: 74.4 °F T2: 83.9 °F Delta T(T1,T2): 9.5 °F	
Print Time: 2004/12/17 05:55 PM	Page 2
Panorama: MICHELLEUI	

FIGURE 8-16 Event List Report (Page 2)

8.1.6.1

Header

The Event List Report's page header provides the title of the report and basic demographic information, if it is available. The demographic information includes the patient's first and last name, identification number, bed number, weight, height and doctor.

Page headers on subsequent pages of the report provide the report title, the date and time the data was collected, and limited demographic information about the patient (first and last name, identification number and bed number), if it is available.

If the demographic data was not previously entered in the system, only the demographic label is shown.

8.1.6.2 Event Record

The Event List Report's event record section includes the digital data that occurred during the specified time period. The data in this report is determined by the events that occurred during the specified time period.

Event data records are separated by a solid horizontal line. If data is not available for the selected time period, the report will not print.

- The first page of event records include numbers for the Total Events (the total number of events in the selected patient's event database), the Displayed Events (the number of events shown in the report) and the Event Filter (based on the event filter setting).
- Each event record in the report contains the time (hour and minute) when the event occurred. The time format follows the system format specified in the **Date/Time** tab.
- Each Event record in the report contains the name of the event that has occurred for the selected patient.
- Each physiological event record in the report contains the digital data values for the specified time period.
- Each Event Data record in the report contains a digital heart rate (HR) value. The source of the heart rate data is shown in parentheses next to the HR label. If data is not available for the time period specified, dashes are shown in the place of a heart rate value.

For information regarding the digital data supported by each device, refer to "Supported Devices" on page 1-3. The column order in which the digital parameter data is printed in a record is based on the order selected in the **Unit Priorities** tab.

- Event records in the report use brackets ([]) to distinguish data in the alarm condition and dashes (- -) to distinguish incomplete or missing data.
- System and technical event records in the report do not contain digital data values.

8.1.6.3 Footer

The Event List Report contains a footer at the bottom of every page. The footer includes:

- The date and time of the print request. The format displayed is taken from the **System Date/Time** tab.
- A centered page number.
- The name of the Panorama Central Station where the report was generated.

8.1.6.4 Printing an Event List Report

The Event List Report is printed in portrait orientation.

To print one hour of event data:

- From the **Patient Reports** tab, select the **Event List Report** button. The Print Selection dialog is displayed (shown in FIGURE 8-9).
- Select the **Print 1 Hour** button. The report is sent to the printer.

To print multiple hours of event data from the **Patient Reports** tab:

1. Select the **Event List Report** button.
2. Select one of the time interval buttons or the **Cancel** button.
 - The choices are print 1 hour, 2 hours, 4 hours, 8 hours, 12 hours, and 24 hours.
 - Select the **Cancel** button to close the dialog box without generating the print request.

To print multiple hours of trend data from the **Events** tab:

1. From the menu bar, select the **Print** button. The Print Selection dialog is displayed.
2. Select one of the **Print Current**, a time interval button, or the **Cancel** button.
 - Select the **Print Current** to create a one page Trend List Report.
 - Select one of the time interval buttons. The choices are print 1 hour, 2 hours, 4 hours, 8 hours, 12 hours, and 24 hours.
 - Select the **Cancel** button to close the dialog box without generating the print request.

NOTE: **If the number of hours selected exceeds the amount of data in system, the report shows only the available data.**

Requesting this report posts a print job in the system Print Status tab. For additional information, refer to the "Print Status Tab" on page 8-38.

8.1.7 Patient Alarm Report

The Patient Alarm Report (shown in FIGURE 8-17) is a single page report containing a patient's alarm settings information (unit of measure, alarm limits, priority and alarm responses). This report includes a header, patient alarm data, optional arrhythmia and paging delay settings, and a footer.

Patient Alarm Report						
Last Name : ROBERTS		First Name : STEVEN		ID : B3992		
Bed : 344A		Doctor :		Patient Size : Adult		
Parameter	Units	High Limit	Low Limit	Priority	Print On Alarm	Save To Event
HR	BPM	120	60	2	OFF	ON
NIBP Sys	mmHg	OFF	OFF	3	OFF	ON
NIBP Dia	mmHg	OFF	OFF	3	OFF	ON
NIBP Mean	mmHg	OFF	OFF	3	OFF	ON
SpO2	%	OFF	85	2	OFF	ON
Resp	RPM	14	7	3	OFF	ON
PVC/min	PVC/min	OFF	---	3	OFF	ON
IBP1 Sys	mmHg	120	80	3	OFF	ON
IBP1 Dia	mmHg	45	25	3	OFF	ON
IBP1 Mean	mmHg	65	42	3	OFF	ON
IBP2 Sys	mmHg	140	90	3	OFF	ON
IBP2 Dia	mmHg	65	40	3	OFF	ON
IBP2 Mean	mmHg	85	54	3	OFF	ON
IBP3 Sys	mmHg	190	125	3	OFF	ON
IBP3 Dia	mmHg	120	75	3	OFF	ON
IBP3 Mean	mmHg	140	92	3	OFF	ON
IBP4 Sys	mmHg	165	105	3	OFF	ON
IBP4 Dia	mmHg	95	60	3	OFF	ON
IBP4 Mean	mmHg	115	74	3	OFF	ON
T1	°F	100	95	3	OFF	ON
T2	°F	99	94	3	OFF	ON
Delta T	°F	3	2	3	OFF	ON
Apnea	---	30	---	3	OFF	ON
Asystole	---	---	---	1	OFF	ON
Bigeminy	---	---	---	3	OFF	ON
Couplet	---	---	---	3	OFF	ON
Irregular HR	---	---	---	3	OFF	ON
Run	---	---	---	3	OFF	ON
Trigeminy	---	---	---	3	OFF	ON
V-Fib	---	---	---	1	OFF	ON
V-Tach	---	---	---	1	OFF	ON
V-Rhythm	---	---	---	3	OFF	ON
Brady	---	---	---	1	OFF	ON
Arrhythmia Settings						
Asystole Delay: 4 Sec.		V-Tach Threshold: 3 Beats		All Arrhythmia On/Off: ON		V-Tach Rate: 120 BPM
Print Time: 2007/07/17 12:55 PM						
Page 1						
Panorama: CENTRAL86B						

FIGURE 8-17 Patient Alarm Report - Paging Option Disabled

Patient Alarm Report							
Last Name : Bed :		First Name : Doctor :		ID : Patient Size : Adult			
Parameter	Units	High Limit	Low Limit	Priority	Print On Alarm	Save To Event	Page On Alarm
HR	BPM	OFF	OFF	2	OFF	ON	OFF
NIBP Sys	mmHg	OFF	OFF	3	OFF	ON	OFF
NIBP Dia	mmHg	OFF	OFF	3	OFF	ON	OFF
NIBP Mean	mmHg	OFF	OFF	3	OFF	ON	OFF
SpO2	%	OFF	85	2	OFF	ON	OFF
Resp	RPM	OFF	OFF	3	OFF	ON	OFF
INSPCO2	mmHg	10.0	—	3	OFF	ON	OFF
ETCO2	mmHg	80.0	—	3	OFF	ON	OFF
PVC/min	PVC/min	OFF	—	3	OFF	ON	OFF
IBP1 Sys	mmHg	OFF	OFF	3	OFF	ON	OFF
IBP1 Dia	mmHg	OFF	OFF	3	OFF	ON	OFF
IBP1 Mean	mmHg	OFF	OFF	3	OFF	ON	OFF
IBP2 Sys	mmHg	OFF	OFF	3	OFF	ON	OFF
IBP2 Dia	mmHg	OFF	OFF	3	OFF	ON	OFF
IBP2 Mean	mmHg	OFF	OFF	3	OFF	ON	OFF
T1	°F	OFF	OFF	3	OFF	ON	OFF
Apnea	—	30	—	3	OFF	ON	OFF
Asystole	—	—	—	1	OFF	ON	OFF
Bigeminy	—	—	—	3	OFF	ON	OFF
Couplet	—	—	—	3	OFF	ON	OFF
Irregular HR	—	—	—	3	OFF	ON	OFF
Run	—	—	—	3	OFF	ON	OFF
Trigeminy	—	—	—	3	OFF	ON	OFF
V-Fib	—	—	—	1	OFF	ON	OFF
V-Tach	—	—	—	1	OFF	ON	OFF
V-Rhythm	—	—	—	3	OFF	ON	OFF
Brady	—	—	—	1	OFF	ON	OFF
Arrhythmia Settings							
Asystole Delay: 4 Sec.		V-Tach Threshold: 3 Beats		All Arrhythmia On/Off: ON		V-Tach Rate: 120 BPM	
Paging Delay Settings							
Paging Delay: 10 Sec.							
Print Time: 2007/07/12 11:57 AM							
Page 1							
Panorama: SHSTATION							

FIGURE 8-18 Patient Alarm Report - Paging Option Enabled

8.1.7.1 Header

The Patient Alarm Report's page header provides the title of the report and basic demographic information, if it is available. The demographic information includes the patient's first and last name, identification number, bed number, weight, height and doctor.

If the demographic data was not previously entered in the system, only the demographic label is shown.

8.1.7.2 Patient Alarm Data

The Patient Alarm Report's data section includes alarm information for all of the alarms. The parameters in a Patient Alarm Report are dependent on the device connected to the selected patient file. The columns are described as follows:

- **Parameter** displays the parameters for which the specified patient has an alarm.
- **Units** displays the unit of measure in use for the parameter specified.
- **High Limit** displays the High alarm limit for the parameter specified.
- **Low Limit** displays the Low alarm limit for the parameter specified.
- **Priority** displays the alarm priority assigned to the parameter specified.

- **Print On Alarm** displays the Print on Alarm response assigned to the parameter specified.
- **Save to Event** displays the Save To Event alarm response that has been assigned to the parameter specified.
- **Page On Alarm** displays the Page On Alarm response that has been assigned to the parameter specified.

8.1.7.3 Arrhythmia Settings

The Patient Alarm Report's Arrhythmia Settings section includes values for the following:

- Asystole Delay
- V-Tach Threshold
- All Arrhythmia On/Off
- V-Tach Rate

8.1.7.4 Paging Delay Settings

The Patient Alarm Report's Paging Delay section includes the system paging delay value that was configured in the System Alarms tab.

8.1.7.5 Footer

The Patient Alarm Report contains a footer at the bottom of the page. The footer includes:

- The date and time of the print request. The format displayed is taken from the **System Date/Time** tab.
- A centered page number.
- The name of the Panorama Central Station where the report was generated.

8.1.7.6 Printing a Patient Alarm Report

The Patient Alarm Report is printed in portrait orientation, using any of the following methods:

- From the **Patient Reports** tab, select the **Patient Alarm Report** button.
- From the **Alarm Limits** tab, select the **Print** menu bar button.

Requesting this report posts a print job in the system Print Status tab. For additional information, refer to the "Print Status Tab" on page 8-38.

8.1.8 Troubleshooting

This section lists some of the potential messages and issues that may occur while using the **Patient Reports** tab.

MESSAGE/ISSUE *	REASON	SOLUTION
All report buttons are disabled.	A patient is not currently selected.	Select a patient before trying to print a report.
The ST Report button is disabled.	The selected patient does not have ST enabled.	Enable ST for the selected patient before trying to print an ST report.

* Messages are shown in all bold text.

MESSAGE/ISSUE *	REASON	SOLUTION
	A WMTS 608 wireless bedside device is in use.	No solution required.
	The selected patient tile is relearning phase, or is in a Communications Lost or Standby state.	Wait for the patient tile to resume monitoring.
The ST Report button is hidden.	The selected patient tile is in a Waiting for Patient state.	Activate the destination device.
The Print All Strips report button is disabled.	The selected patient tile is in a Communications Lost or Standby state.	Wait for the patient tile to resume monitoring.
The Print All Strips button is hidden.	The selected patient tile is in a Waiting for Patient state.	Activate the destination device.
The report will not print	There are several reasons that a report would not print. There could be a communication problem between the printer and the Panorama Central Station and/or there could be a problem with the printer.	If there is an error that appears such as Printer out of Paper you will need to remedy that situation. If the No Printer connected or Printer not Available error is displayed, verify that the printer was properly configured with the Panorama Central Station. Refer to the Panorama Printer Configuration Manual (P/N 0070-00-0561).
The Delta T parameter does not display in the All Strips report.	One of the two temperature sources used to calculate the Delta T value is not valid.	Verify that the two temperature sources have been properly configured.
Page On Alarm column not displayed in Patient Alarm Report	Paging option is not enabled at the central station.	If available, enable Paging option. If feature unavailable, no solution required.
All Arrhythmia On/Off setting set to Off	Arrhythmia is disabled for a selected patient tile.	If available, enable arrhythmia for the selected patient tile. If feature or license is unavailable, no solution required.
In the Patient Alarm Report's Arrhythmia Settings section, a "-" is displayed as the value for Asystole Delay, V-Tach Threshold, and V-Tach Rate	Arrhythmia is disabled for a selected patient tile.	If available, enable arrhythmia for the selected patient tile. If feature or license is unavailable, no solution required.
Paging Delay Settings section not displayed in the Patient Alarm Report.	This section will only be displayed when Paging is enabled at the central station.	If available, enable Paging option. If feature unavailable, no solution required.

* Messages are shown in all bold text.

8.2 System Reports Tab

The **System Reports** tab (shown in FIGURE 8-20) is used to generate reports on a system level. A patient file does not have to be selected to generate a system report.

The following reports can be printed from the **System Reports** tab:

- Accessing the System Reports Tab
- All Strips (All Patients) Report
- Equipment Report
- Paging Report

8.2.1 Accessing the System Reports Tab

1. From the menu bar, select the **Report** button.
2. Select the **System Reports** tab. The **System Reports** tab is displayed.

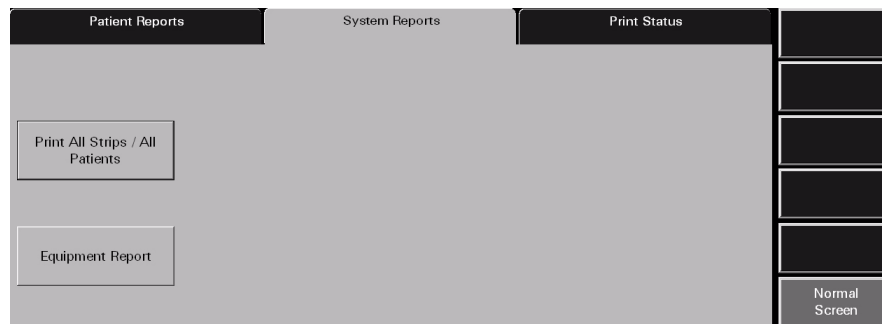

FIGURE 8-19 System Reports Tab

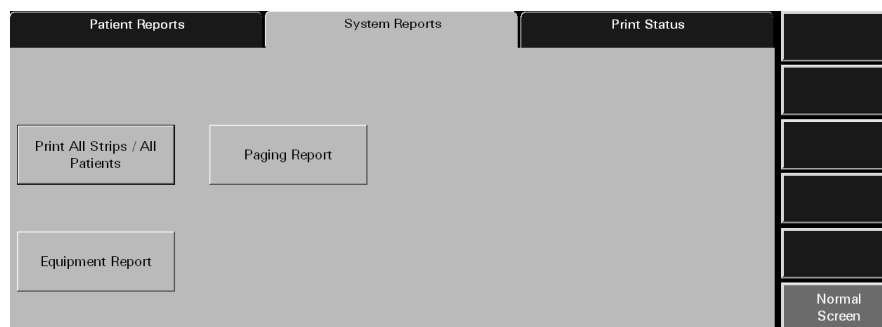

FIGURE 8-20 System Reports Tab - Paging Option Enabled

NOTE: The **Paging Report** button will only be displayed when the **Paging Option** is enabled at the central station.

8.2.2 All Strips (All Patients) Report

The All Strips (All Patients) Report (shown in FIGURE 8-21 and FIGURE 8-22) contains real-time monitoring data for all the active patients monitored by the Panorama Central Station. This report contains all current numeric values and waveforms. It is similar to the All Strips Report, except that it prints for all active patients. The report includes a header, digital data, waveform data and a footer.

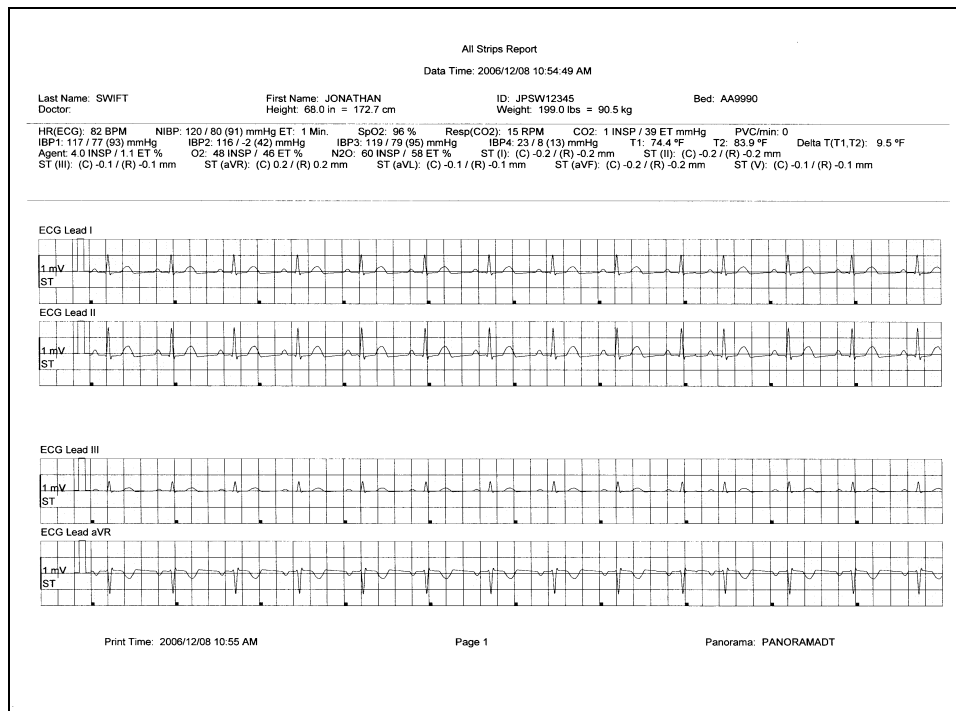

FIGURE 8-21 All Strips (All Patients) Report (Page 1)

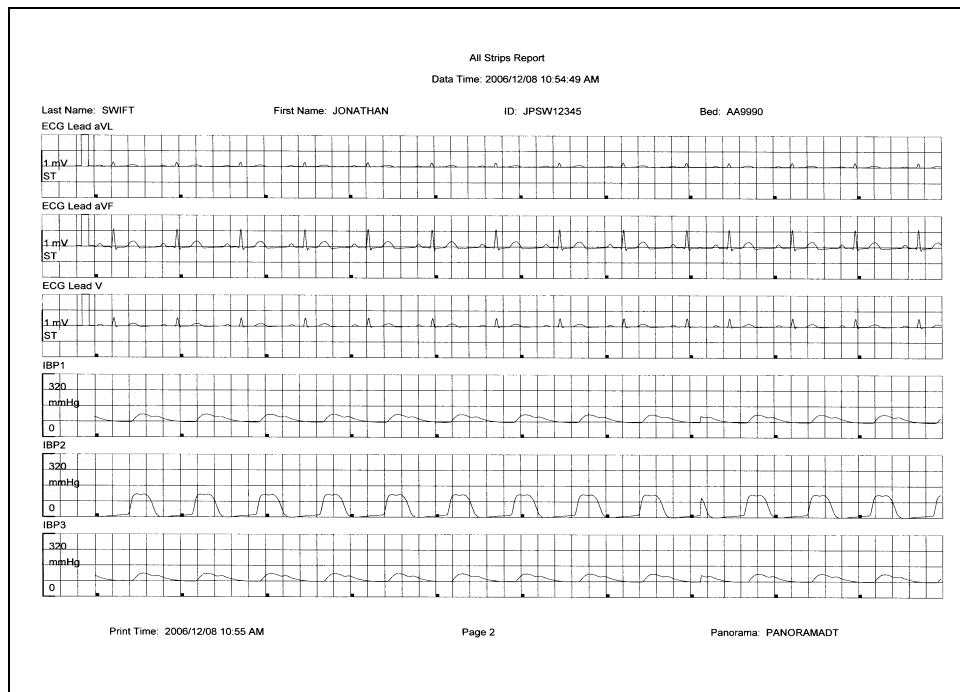

FIGURE 8-22 All Strips (All Patients) Report (Page 2)

8.2.2.1 Header

The All Strips (All Patients) Report's first page header provides the title of the report and basic demographic information, if it is available. The demographic information includes the patient's first and last name, identification number, bed number, weight, height, and doctor.

Page headers on subsequent pages of the report provide the report title, the date and time the data was collected, and limited demographic information about the patient (first and last name, identification number, and bed number), if it is available.

If the demographic data was not previously entered in the system, only the demographic label is shown.

8.2.2.2 Digital Data

The All Strips (All Patients) Report's digital data section displays measurements for the digital data parameters currently available for the selected patient file. The displayed parameter order is determined by the system **Unit Priorities** tab. The digital data section contains the following:

- A parameter label
- A numeric measurement
- A unit of measure label
- A heart rate (HR) value
- Dashes (-) to indicate missing or invalid digital data.
- Square brackets ([]) to indicate alarming parameter values

NOTE: **Digital Data is only shown on the first page of the report.**

8.2.2.3 Waveform Data

The waveforms that print in the All Strips (All Patients) Report's waveform data section are limited to which leads are currently in use, and on the waveforms selected in the Print Setup function.

The first page of this report contains up to two waveforms while subsequent pages contain up to three waveforms. Each waveform in this report represents approximately 10 seconds of data; five seconds prior to the time of the print request and 5 seconds after the print request. A waveform label (i.e., ECG Lead II) is shown above each strip to identify the data source and the unit of measurement (i.e., %, RPM, BPM, mmHg, kPa). Pleth, ECG and Respiration do not display a unit of measurement. The waveforms displayed in the report are shown on a calibrated grid and contain a scale bar.

For pacemaker patients that have Pacer Enhancement enabled, the report displays a vertical bar to indicate the firing of the pacemaker impulse.

ECG Waveforms

The ECG waveforms shown in the All Strips (All Patients) Report are based on the ECG lead wire set currently in use and on the waveforms selected in the **Print Setup** tab. The ECG waveform report displays with the following:

- An ECG lead label
- A wave gain scale bar and a calibration pulse for wave gains less than 30 mm/mV
- A calibrated grid
- Current ECG monitoring label
- A continuous straight line for active ECG leads that are not connected

Non-ECG Waveforms

The non-ECG waveforms shown in the All Strips (All Patients) Report are based on the non-ECG waveforms that are in use and the non-ECG waveforms that are selected to be printed. The report only includes non-ECG parameters if they are in use at the time of the print request.

All non-ECG waveforms in the report contain a parameter label and a unit of measure label. Non-ECG waveforms in the report may contain a wave gain scale bar. If a non-ECG waveform is unavailable at the time of the print request, the report prints blank data for the specified time period.

- If the IBP waveform was labeled at the bedside monitor, the report contains that IBP label.
- If the Anesthetic Agent was identified at the bedside monitor, the report contains that Agent label.

8.2.2.4 Footer

The report contains a footer at the bottom of every page. The footer includes:

- The date and time of the print request. The format displayed is taken from the **System Date/Time** tab.
- A centered page number.
- The name of the Panorama Central Station where the report was generated.

8.2.2.5 Printing an All Strips (All Patients) Report

The All Strips (All Patients) Report prints in portrait orientation, using the following method:

- From the **System Reports** tab, select the **Print All Strips/All Patients** button. Selecting this button sends a print request, for each patient, to the printer.

Requesting this report posts a print job in the system Print Status tab. For additional information, refer to the "Print Status Tab" on page 8-38.

8.2.3 Equipment Report

The Equipment Report (shown in FIGURE 8-23) contains a list of devices currently assigned to the Panorama Central Station. This report displays a maximum of 32 devices per page and includes a header, six columns and a footer.

NOTE: The Equipment Report is not available at the ViewStation.

Equipment Report					
Label	Type	Title	Device ID	Patient Name	Patient ID
spectrum	Spectrum	0	S1006D7X	----	----
spectrum2	Spectrum	1	S10656FX	----	----

Print Time: 2006/12/08 08:51 PM Page 1 Panorama: IDS01XXXXXXXXXX
S/N: IDS01XXXXXXXXXX

FIGURE 8-23 Equipment Report

8.2.3.1 Header

The header of the Equipment Report displays a centered report title.

8.2.3.2 Equipment Information

The Equipment Report contains six columns. They are describes as follows:

- **Label** displays the equipment device label. For additional information regarding Device ID's, refer to the "Equipment Setup Tab" on page 9-33.
- **Type** displays the type of device that is attached to the central station. For example, a Telepack-WMTS or a Passport 2.
- **Tile** displays the tile the device is attached to. Six dashes (- - - -) display in this column if the tile number associated with the device in the Equipment Setup dialog is **None**.
- **Device ID** displays the ID of the device or unit. Six dashes display in this column if the device is a Panorama Central Station.
- **Patient Name** displays the first name and last name of the patient attached to the device. If a patient is not attached to the device, the report displays six dashes in this column. Dashes also display if the device attached to the patient does not have the patient's first and last name entered.
- **Patient ID** displays the identification number of the patient attached to the device. Six dashes display in this column if the device attached to the patient does not have the Patient ID entered.

8.2.3.3 Footer

The Equipment Report contains a footer at the bottom of every page. The footer includes:

- The date and time of the print request. The format displayed is taken from the **System Date/Time** tab.
- A centered page number.
- The name of the Panorama Central Station where the report was generated.
- The serial number of the Panorama Central Station where the report was generated.

8.2.3.4 Printing the Equipment Report

The Equipment Report is printed in portrait orientation, using any of the following methods:

- From the **System Report** tab, select the **Equipment Report** button.

NOTE: The **Equipment Report** button is not available at the **ViewStation**.

- From the **Equipment Setup** tab, select the **Print** menu bar button.

Requesting this report posts a print job in the system Print Status tab. For additional information, refer to the "Print Status Tab" on page 8-38.

8.2.4 Paging Report

The Paging Report (shown in FIGURE 8-24) prints all the currently assigned pagers, lists who each pager is assigned to, and specifies which patient tiles are assigned to which pagers. This report contains a row for every pager listed in the **Paging** tab and can contain a maximum of 100 pager assignments. Depending on the number of assigned pagers, this report may contain more than one page.

NOTE: The **Paging Report** is not available at the **ViewStation**.

Paging Report		
Pager Number	Pager Assignment	Title
1	abe	0,1,2,3,4,5,6,7,8,9,10,11,12,13,14,15
2	betty gable	0,1,2,3,4,5,6,7,8,9,10,11,12,13,14,15
3	charlie chan	0,1,2,3,4,5,6,7,8,9,10,11,12,13,14,15
4	diana	0,1,2,3,4,5,6,7,8,9,10,11,12,13,14,15
7	7	0,1,2,3,4,5,6,7,8,9,10,11,12,13,14,15
8	8	0,1,2,3,4,5,6,7,8,9,10,11,12,13,14,15
10	10	0,1,2,3,4,5,6,7,8,9,10,11,12,13,14,15
11	11	1,2,3,4,5,6,7,8,9,10,11,12,13,14,15
12	12	0,1,2,3,4,5,6,7,8,9,10,11,12,13,14,15
13	a	0
14	d	0,1,2,3,4,5,6,7,8,9,10,11,12,13,14,15

Print Time: 2005/08/17 03:07 PM Page 1 Panorama: PANORAMA_DT

FIGURE 8-24 Paging Report

8.2.4.1 Header

The Paging Report's header provides the title of the report.

8.2.4.2 Pager Information

The Paging information section of the report contains all the pager information as they are configured at the central station at the time the report was generated.

The following pager information is shown in three columns:

- **Pager Number** displays the number that has been assigned to the pager. This column can display a maximum of 14 alphanumeric characters.
- **Pager Assignment** displays which person or department the pager is assigned to.
- **Tile** displays which patient tile number the pager is assigned to. This column can display a maximum of 30 alphanumeric characters. In addition, this column can display a maximum of 8-12 patient tiles when using a single display or a dual display configuration. The Tile column uses a comma (,) as a separator when more than one patient tile is assigned to a pager.

8.2.4.3 Footer

The Paging Report contains a footer at the bottom of the report page. The footer includes:

- The date and time of the print request. The format displayed is taken from the **System Date/Time** tab.
- A centered page number.
- The name of the Panorama Central Station where the report was generated.

8.2.4.4 Printing a Paging Report

The Paging Report is printed in portrait orientation, using any of the following methods:

- From the **System Reports** tab, select the **Paging Report** button.
- From the **Paging** tab, select the **Print** menu bar button.

Requesting this report posts a print job in the system Print Status tab. For additional information, refer to the "Print Status Tab" on page 8-38.

8.3 Print Status Tab

The **Print Status** tab (shown in FIGURE 8-25) contains a list of current print requests. Once the status of a print request changes or the report prints, the list updates automatically without having to refresh the list.

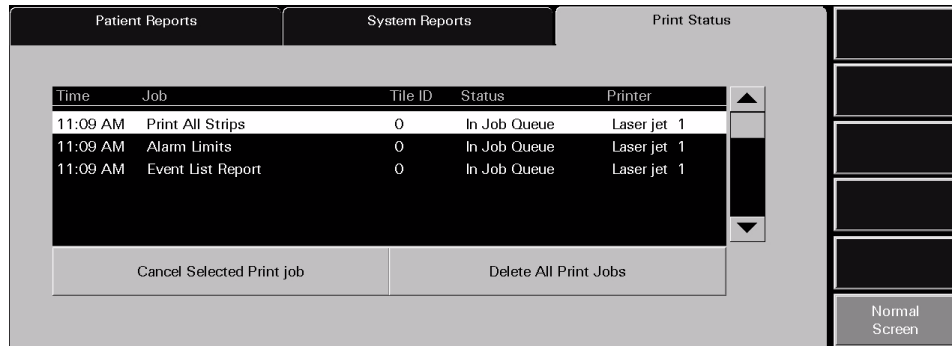

FIGURE 8-25 Print Status Tab

8.3.1 Print Status Tab List Box

Once a new print request is submitted, specific information displays in the **Print Status** tab. The list box contains the following information:

- **Time** displays the time the print request was submitted. The print time format follows the system format specified in the **Date/Time** tab.
- **Job** displays the name of the requested report. For example, if the Full Disclosure Report was requested, the **Job** column displays **Full Disclosure Report**.
- **Tile ID** displays the **Tile ID** associated with the print request. For example, if the All Strips Report is requested and tile six is selected, the **Tile ID** column displays **6**.
- **Status** displays the current status of the print request. There are five possible status options available:

In Job Queue	Indicates that a print request was generated
Printing	Indicates that the print request is currently printing
Deleting	Indicates that the print request is currently being deleted
Spooling	Indicates the time between when the print request is made, and when the request is printed
Error	Indicates that there is an error at the printer that requires user intervention

The information available in this column is real-time. For example, once the status of a print request changes or the report prints, the list updates accordingly.

- **Printer** displays the name of the printer associated with the print request.

8.3.2 Removing Print Jobs from the Print Queue

Once print requests are submitted, they can be cancelled or deleted by using the following buttons.

Cancel Selected Print Job

Select the **Cancel Selected Print job** button to delete the selected print request from the job queue. When this button is selected, the multi-column list box Status column displays **Deleting**, and the request is removed from the multi-column list box.

Delete All Print Jobs

Select the **Delete All Print Jobs** button to cancel all print requests in the job queue. When this button is selected, the multi-column list box Status column displays **Deleting** for each print request and the requests are removed from the multi-column list box.

8.3.3 Sidebar Buttons

The following sidebar button is used to expand the functionality of this tab.

Normal Screen

Select the **Normal Screen** sidebar button to return the display to the full screen mode, and close all tabs, message boxes, and dialog boxes.

8.3.4 Troubleshooting

This section lists some of the potential messages and issues that may occur while using the **Print Status** tab.

MESSAGE/ISSUE *	REASON	SOLUTION
Report is not printing	Printer not selected at the Panorama Central Station.	Refer to the Panorama Printer Configuration document (P/N 0070-00-0561).
	Printer is not turned on.	Turn the printer on.
	Printer is offline.	Verify that the printer is online.
	Printer is out of paper.	Verify that the printer paper tray contains paper.
		Verify that the printer is connected to the Panorama Central Station.
		Print a test page. Refer to the the Panorama Printer Configuration document (P/N 0070-00-0561).
		Verify that the printer configuration settings are correct.

* Messages are shown in all bold text.

8.4 Additional Reports

The Panorama Central Station is capable of generating additional reports from areas other than the **Reports** menu button.

Reports generated by the Panorama Central Station, but cannot be generated from the **Reports** menu button include:

- Event Zoom In Report
- Full Disclosure Zoom In Report
- Graphic Trend Report
- 12-lead Report
- Telepack Error Log Report
- System Alarm Report

8.4.1 Accessing Additional Reports

These reports can be accessed from different areas throughout the system. For specific instructions on how request each of these reports, refer to each reports printing section.

8.4.2 Event Zoom In Report

The Event Zoom In Report (shown in FIGURE 8-26 and FIGURE 8-27) shows all of a patient's historical digital and waveform data for a selected event. This report includes a header, digital data, waveform data and a footer.

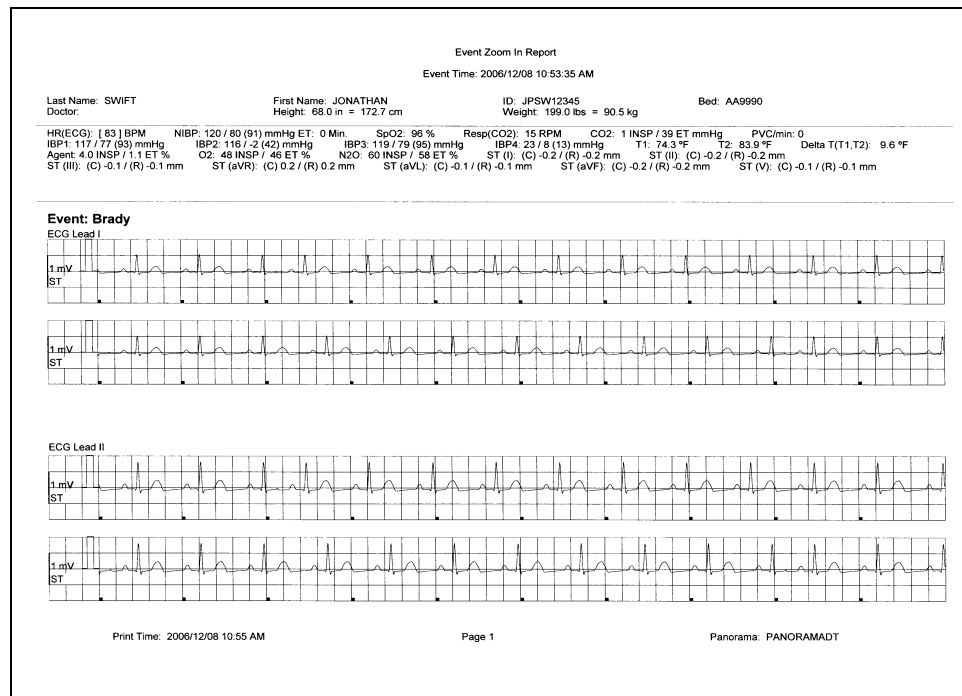

FIGURE 8-26 Event Zoom In Report (Page 1)

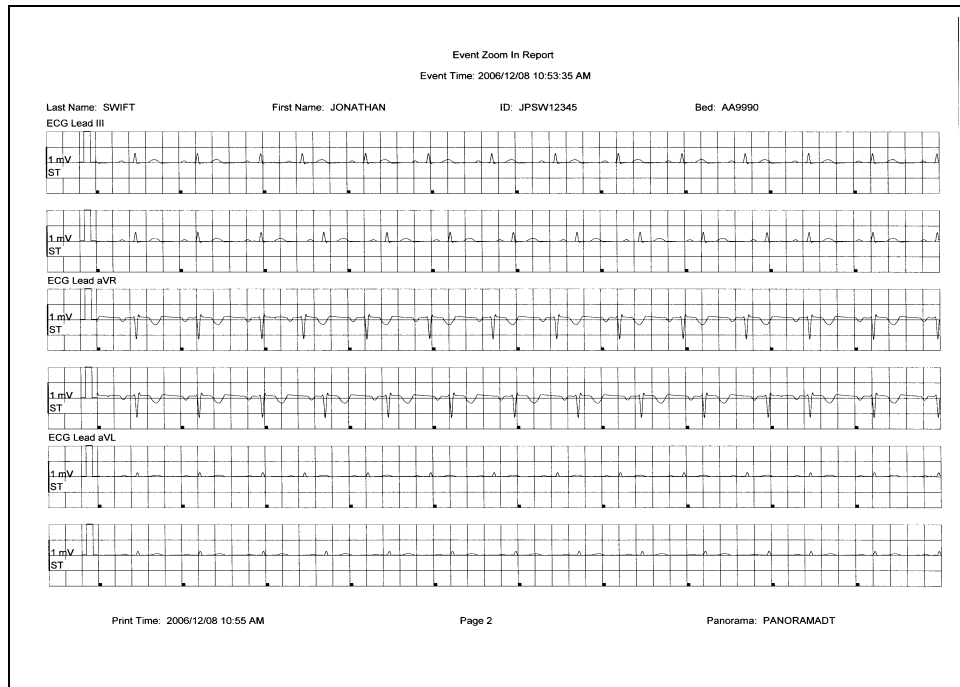

FIGURE 8-27 Event Zoom In Report (Page 2)

8.4.2.1 Header

The Event Zoom In Report's first page header provides the title of the report and basic demographic information, if it is available. The demographic information includes the patient's first and last name, identification number, bed number, weight, height and doctor.

Page headers on subsequent pages of the report provide the report title, the date and time the data was collected, and limited demographic information about the patient (first and last name, identification number and bed number), if it is available.

If the demographic data was not previously entered in the system, only the demographic label is shown.

8.4.2.2 Digital Data

The Event Zoom In Report's digital data section displays measurements for the digital data parameters currently available for the selected patient file. The displayed parameter order is determined by the system **Unit Priorities** tab. The digital data section contains the following:

- A parameter label
- A numeric measurement
- A unit of measure label
- A heart rate (HR) value
- Dashes (-) to indicate missing or invalid digital data.
- Square brackets ([]) to indicate alarming parameter values

NOTE: **Digital Data is only shown on the first page of the report.**

NOTE: **ST digital data includes Current (C) and Reference (R) values.**

8.4.2.3 **Waveform Data**

The waveforms that print in the Event Zoom In Report's waveform data section depend on which leads are currently in use and on the waveforms selected in the Print Setup function.

The first page of this report contains four waveforms. The middle pages of the report will contain six waveforms while the last page may contain two, four, or six waveform strips depending on the waveforms available. Each waveform in this report represents approximately 10 seconds of data; five seconds prior to the time of the print request and 5 seconds after the print request. A waveform label (i.e., ECG Lead II) is shown above each strip to identify the data source and the unit of measurement (i.e., %, RPM, BPM, mmHg, kPa). Pleth, ECG and Respiration do not display a unit of measurement. The waveforms displayed in the report are shown on a calibrated grid and contain a scale bar.

For pacemaker patients that have Pacer Enhancement enabled, the report displays a vertical bar to indicate the firing of the pacemaker impulse.

8.4.2.4 **ECG Waveforms**

The ECG waveforms shown in the Event Zoom In Report are limited to the ECG lead wire set currently in use, and on the waveforms selected in the **Print Setup** tab. The ECG waveform report is displayed with the following:

- An ECG lead label
- A wave gain scale bar and a calibration pulse for wave gains less than 30 mm/mV
- A calibrated grid
- Current ECG monitoring label
- A continuous straight line for active ECG leads that are not connected

8.4.2.5 Non-ECG Waveforms

The non-ECG waveforms shown in the Event Zoom In Report are limited to the non-ECG waveforms that are in use, and the non-ECG waveforms that are selected to be printed.

All non-ECG waveforms in the report contain a parameter label and a unit of measure label. Non-ECG waveforms in the report may contain a wave gain scale bar. If a non-ECG waveform is unavailable at the time of the print request, the report prints blank data for the specified time period.

- If the IBP waveform was labeled at the bedside monitor, the report contains that IBP label.
- If the Anesthetic Agent was identified at the bedside monitor, the report contains that Agent label.

8.4.2.6 Footer

The Event Zoom In Report contains a footer at the bottom of every page. The footer includes:

- The date and time of the print request. The format displayed is taken from the **System Date/Time** tab.
- A centered page number.
- The name of the Panorama Central Station where the report was generated.

8.4.2.7 Printing an Event Zoom In Report

The Event Zoom In Report prints in landscape orientation using the following method:

- From the **Waveforms View** of the **Events** tab, select the **Print** menu bar button.

Requesting this report posts a print job in the system Print Status tab. For additional information, refer to the "Print Status Tab" on page 8-38.

8.4.3 Full Disclosure Zoom In Report

The Full Disclosure Zoom In Report (shown in FIGURE 8-28 and FIGURE 8-29) provides historical digital and waveform data available for the selected patient tile. The amount of disclosure data available for a patient is dependent on the amount of disclosure data allowed by the Panorama Central Station license. This report includes a header, digital data, waveform data and a footer.

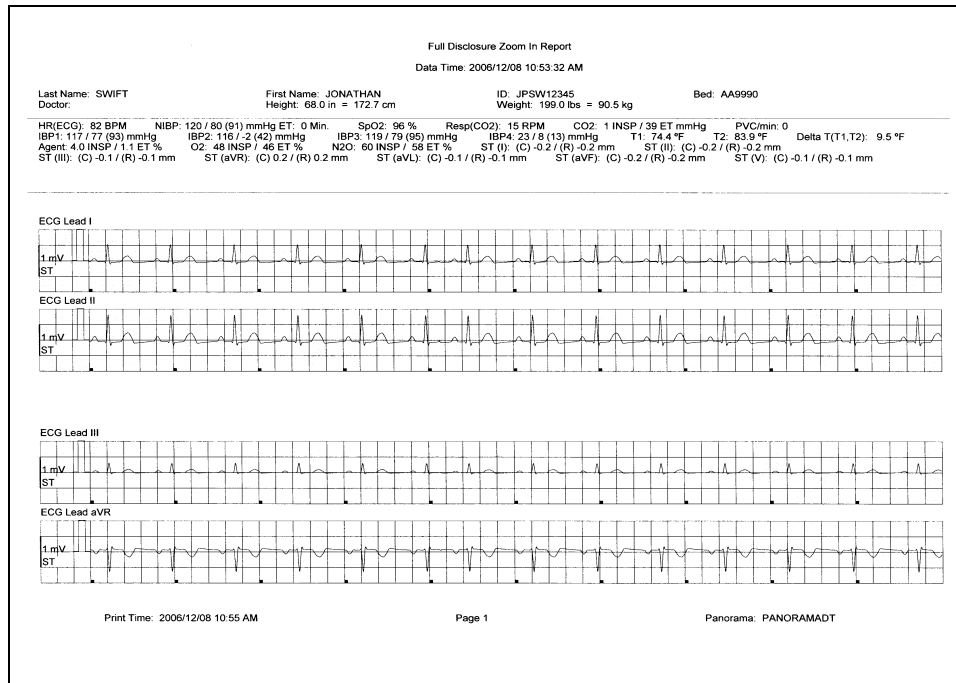

FIGURE 8-28 Full Disclosure Zoom In Report (Page 1)

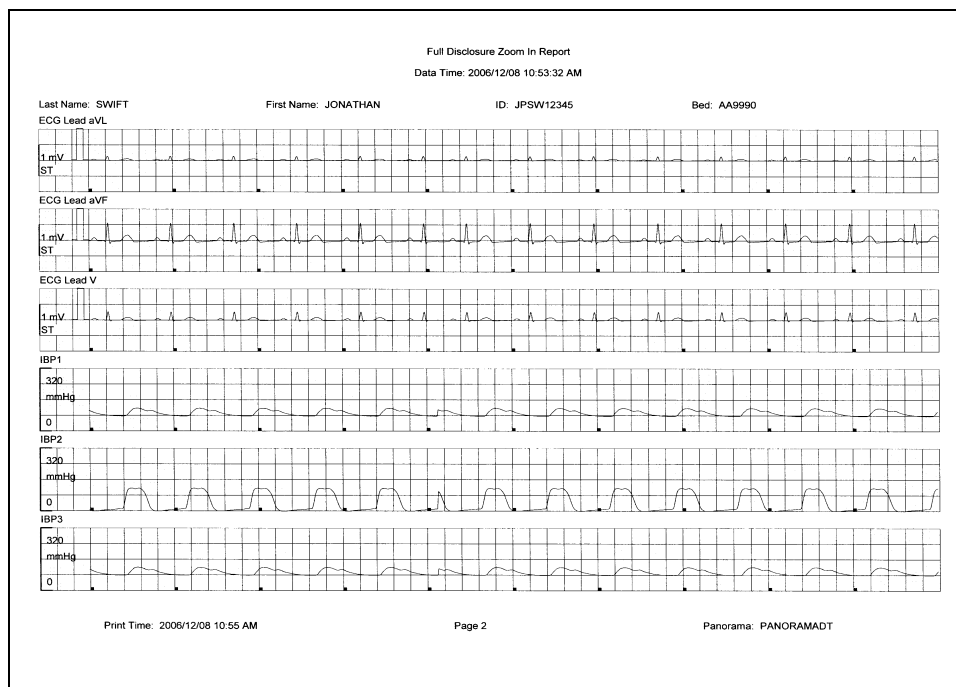

FIGURE 8-29 Full Disclosure Zoom In Report (Page 2)

8.4.3.1 Header

The Full Disclosure Zoom In Report's first page header provides the title of the report and basic demographic information, if it is available. The demographic information includes the patient's first and last name, identification number, bed number, weight, height and doctor.

Page headers on subsequent pages of the report provide the report title, the date and time the data was collected, and limited demographic information about the patient (first and last name, identification number and bed number), if it is available.

If the demographic data was not previously entered in the system, only the demographic label is shown.

8.4.3.2 Digital Data

The Full Disclosure Zoom In Report's digital data section displays measurements for the digital data parameters currently available for the selected patient tile. The displayed parameter order is determined by the system **Unit Priorities** tab. The digital data section contains the following:

- A parameter label
- A numeric measurement
- A unit of measure label
- A heart rate (HR) value
- Dashes (-) to indicate missing or invalid digital data.
- Square brackets ([]) to indicate alarming parameter values

NOTE: **Digital Data is only shown on the first page of the report.**

NOTE: **ST digital data includes both Current (C) and Reference (R) values.**

8.4.3.3 Waveform Data

The waveforms that print in this Full Disclosure Zoom In Report's waveform data section are limited to which leads are currently in use, and on the waveforms selected in the Print Setup function.

The first page of this report contains four waveforms. The middle pages of the report contains six waveforms while the last page may contain two, four, or six waveforms depending on the waveforms available. Each waveform in this report represents approximately 10 seconds of data, five seconds prior to the time of the print request and 5 seconds after the print request. A waveform label (i.e., ECG Lead II) is shown above each strip to identify the data source and the unit of measurement (i.e., %, RPM, BPM, mmHg, kPa). Pleth, ECG and Respiration do not display a unit of measurement. The waveforms displayed in the report are shown on a calibrated grid and contain a scale bar.

For pacemaker patients that have Pacer Enhancement enabled, the report displays a vertical bar to indicate the firing of the pacemaker impulse.

ECG Waveforms

The ECG waveforms shown in the Full Disclosure Zoom In Report are limited to the ECG lead wire set currently in use and on the waveforms selected in the **Print Setup** tab. The ECG waveform report displays with the following:

- An ECG lead label
- A wave gain scale bar and a calibration pulse for wave gains less than 30 mm/mV
- A calibrated grid
- Current ECG monitoring label
- A continuous straight line for active ECG leads that are not connected

Non-ECG Waveforms

The non-ECG waveforms shown in the Full Disclosure Zoom In Report are based on the non-ECG waveforms that are in use and the non-ECG waveforms that are selected to be printed.

All non-ECG waveforms in the report contain a parameter label and a unit of measure label. Non-ECG waveforms in the report may contain a wave gain scale bar. If a non-ECG waveform is unavailable at the time of the print request, the report prints blank data for the specified time period.

- If the IBP waveform was labeled at the bedside monitor, the report contains that IBP label.
- If the Anesthetic Agent was identified at the bedside monitor, the report contains that Agent label.

8.4.3.4

Footer

The Full Disclosure Zoom In Report contains a footer at the bottom of every page. The footer includes:

- The date and time of the print request. The format displayed is taken from the **System Date/Time** tab.
- A centered page number.
- The name of the Panorama Central Station where the report was generated.

8.4.4

Printing a Full Disclosure Zoom In Report

The Full Disclosure Zoom In Report is printed in landscape orientation. Follow these steps to print this report:

1. From the **Disclosure** tab, select a portion of the compressed waveform view, then select the **Zoom In** button. The magnified view of the selected section is displayed in the **Waveforms** view.
2. Select the **Print** menu bar button. The report is sent to the printer.

Requesting this report posts a print job in the system Print Status tab. For additional information, refer to the "Print Status Tab" on page 8-38.

8.4.5 Graphic Trend Report

The Graphic Trend Report (titled Trend Graphic Report in FIGURE 8-30 and FIGURE 8-31) displays the trends for the selected patient tile in a graphical format. Graphic Trends are viewed by selecting the **Graphic** button in the **Trends** tab. This report includes a header, Digital data, Graphic data and a footer section.

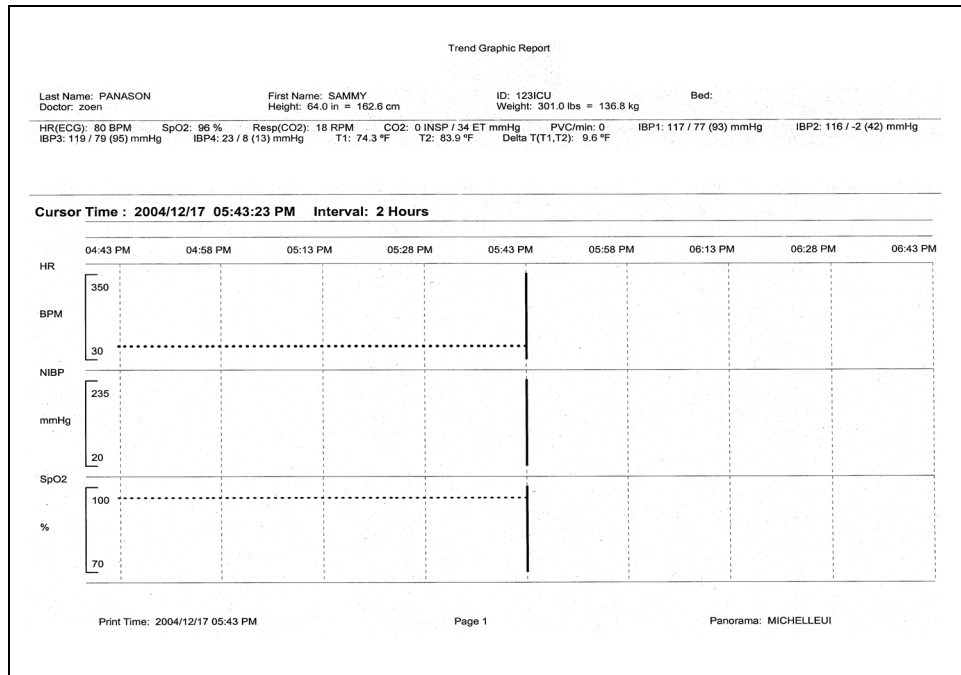

FIGURE 8-30 Graphic Trend Report (Page 1)

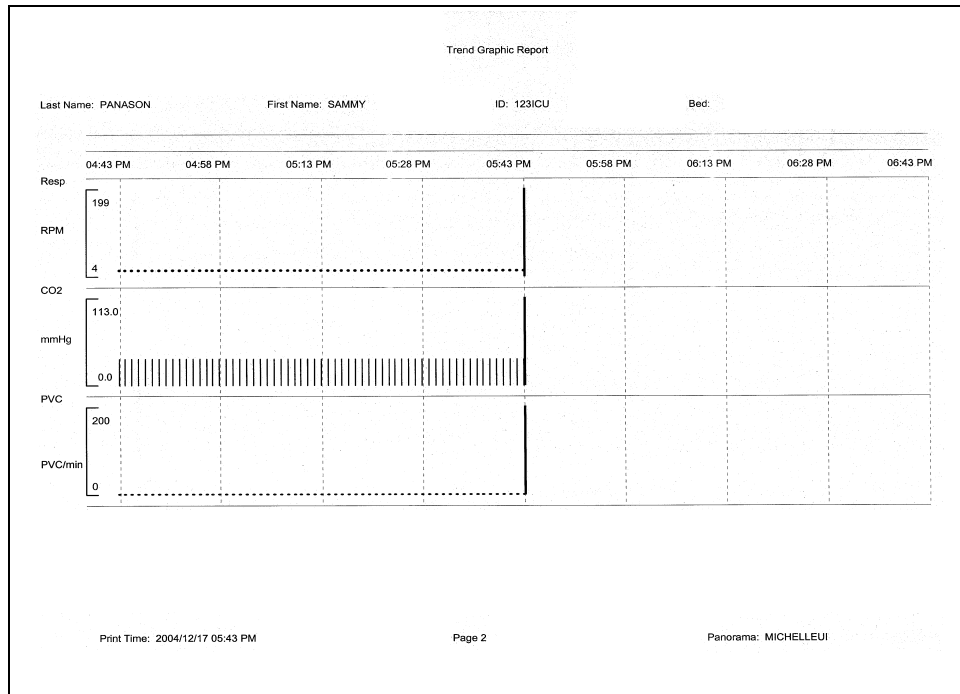

FIGURE 8-31 Graphic Trend Report (Page 2)

8.4.5.1 Header

The Graphic Trend Report's first page header provides the title of the report and basic demographic information, if it is available. The demographic information includes the patient's first and last name, identification number, bed number, weight, height and doctor.

Page headers on subsequent pages of the report provide the report title, the date and time the data was collected, and limited demographic information about the patient (first and last name, identification number and bed number), if it is available.

If the demographic data was not previously entered in the system, only the demographic label is shown.

8.4.5.2 Digital Data

The Graphic Trend Report's digital data section displays measurements for the digital data parameters currently available for the selected patient tile. The displayed parameter order is determined by the system **Unit Priorities** tab. The digital data section contains:

- A parameter label
- A numeric measurement
- A unit of measure label
- A heart rate (HR) value
- Dashes (-) to indicate missing or invalid digital data.
- Square brackets ([]) to indicate alarming parameter values

NOTE: **Digital Data is only shown on the first page of the report.**

8.4.5.3 Graphic Data

The graphic data section of the Graphic Trend Report displays a cursor time, parameter list and a graphical representation of the parameter measurements that occurred during the selected time period.

- The cursor time represents the time that was selected in the Trends (Graphic) tab. The cursor time in the report follows the system Date/Time format.
- The parameters shown in this report display on the left side of the report. Each parameter has its own graphical layout which includes a parameter label, a unit of measure label, a scale bar and the scale bar range of values.
- For historical purposes, the Graphic Data section of the report shows all the selected parameters, even if the parameters are currently turned off.
- The report shows a vertical line on the graph to represent the occurrence of a physiological alarm.
- The report shows nine time periods across the top of the graph for a more representative look at the parameter data. The time periods will be shown in the system default time/date format.
- The time periods shown in the report are equal sections of the total time interval selected in the graphic report. For example, if a 4 hour interval is selected, graphical data is plotted in 30 minute increments and if an 8 hour interval is selected, data is plotted in 60 minute increments. This report is capable of plotting graphical data in 2, 4, 6 and 8 hour time intervals. The report is printed in the time interval specified in the **Trends** (Graphic) tab.

Time intervals are changed in the **Trends** (Graphic) tab by selecting the **Zoom In** and **Zoom Out** buttons.

- This report shows a cursor line in the graph for the Cursor Time posted on the report.
- The data plotted in the Graphic Trend Report reflects the trend data records that were collected based on the Trend Display interval configuration.
- The report shows one plotted point for each parameter sensor.
- Dual sensor parameters (such as INSP/ET CO2) are plotted individually then connected with a line (for example, inspired and end tidal values).
- Multiple sensor parameters (such as NIBP) are plotted individually then the systolic and diastolic points are connected and a single point is shown for the Mean measurement.

8.4.5.4 Footer

The Graphic Trend Report contains a footer at the bottom of every page. The footer includes:

- The date and time of the print request. The format displayed is taken from the **System Date/Time** tab.
- A centered page number.
- The name of the Panorama Central Station from which the report was generated.

8.4.5.5 Printing a Graphic Trend Report

The Graphic Trend Report is printed in landscape orientation, using any of the following:

- Select a valid plot point, then select the **Print** menu bar button from the **Trends** (Graphic) tab.
- From the bedside monitor, verify that **Select Printer** option is configured to print remotely, and that the trends graphic option is active, then press the **PRINT TREND** button.

Requesting this report posts a print job in the system Print Status tab. For additional information, refer to the "Print Status Tab" on page 8-38.

8.4.6 12-lead Report

The 12-lead Report (shown in FIGURE 8-32) provides analysis of 12 vectors of ECG data for the selected patient file. This report includes a header and waveform data. All of the data contained in this report is obtained from the bedside monitor.

NOTE: This report is not available when using a WMTS 608 bedside device.

NOTE: The 12-lead Report is not available at the ViewStation.

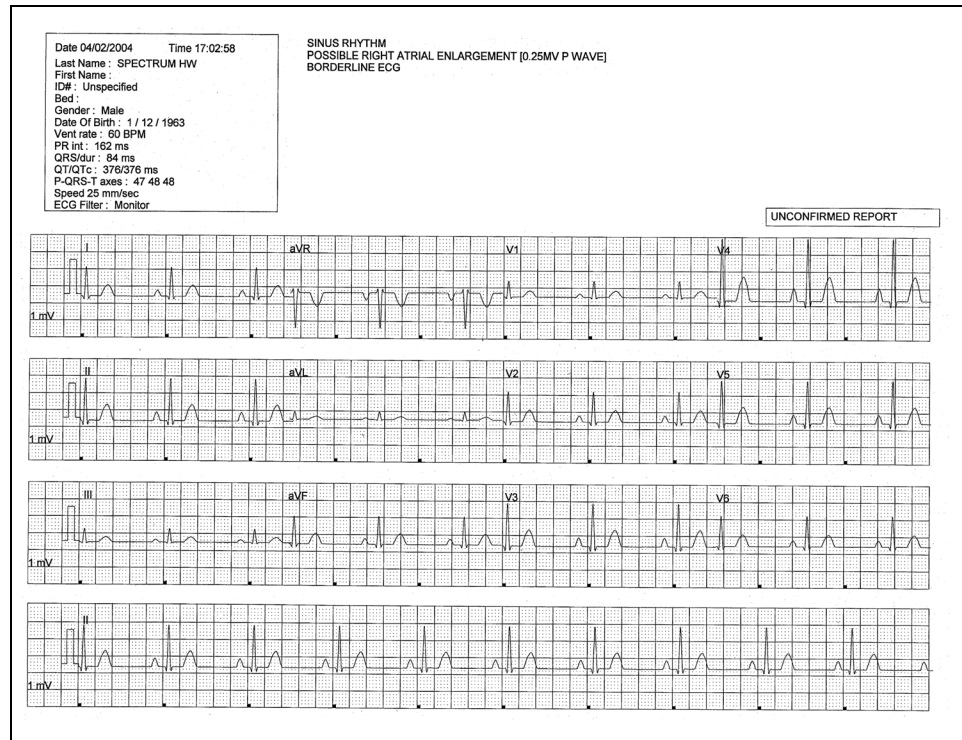

FIGURE 8-32 12-lead Report

8.4.6.1 Header

The 12-lead Report's page header provides the title of the report and basic demographic information, if it is available. The demographic information includes the patient's first and last name, identification number, bed number, weight, height and doctor.

If the demographic data was not previously entered in the system, only the demographic label is shown.

- Interpretation Area: The Interpretation area of the 12-lead report shows an analysis of the collected data.

If data is missing from the report, the message **Unable to Obtain Interpretation. Enter Patient Date of Birth and Gender** is displayed.

If the patient's Patient Size is not set to Adult, the message **Unable to Obtain Interpretation. Patient not an adult** is displayed.

If the patient is less than 18 years old, the message **Unable to Obtain Interpretation. Patient Must Be At Least 18 Years Old** is displayed.

- Unconfirmed Report: The 12-lead Report is marked as an Unconfirmed Report when interpretation strings are printed on the report. This indicates that a physician must review the report for a diagnosis confirmation.

8.4.6.2 Waveform Data

The 12-lead Report section displays 2.5 seconds of waveform data for each of the 12 leads monitored at the bedside monitor, a 10-second ECG rhythm strip for Lead II, a calibration pulse and a wave gain setting of 1 millivolt.

8.4.6.3 Printing a 12-lead Report (Passport 2 and Spectrum)

The 12-lead Report prints when a print request is received from a connected bedside monitor. This report prints in landscape orientation.

Before this report is requested, the following must be configured at the bedside monitor:

- A View 12™ card must be in use
- The monitor must be in the View All ECG Mode
- Remote printing must be enabled

To print the report, select the **STRIP** button from the bedside monitor. A print request is sent from the bedside monitor to the Panorama Central Station's selected printer.

Please refer to the Spectrum Operating Instructions (P/N 0070-00-0648-XX) for more specific printing instructions.

Requesting this report posts a print job in the system Print Status tab. For additional information, refer to the "Print Status Tab" on page 8-38.

8.4.7 Telepack Error Log Report

The Telepack Error Log Report (shown in FIGURE 8-33) is a one page report that shows all logged errors for any wireless Telepack devices connected to the Panorama Central Station in service mode. This report includes a header, error log data and a footer.

NOTE: The Telepack Error Log Report is not available at the ViewStation.

Telepack Error Log Report					
Device ID: T37DA3AX					
Filename	Line Number	Message	Arg1	Arg2	
Ecm.cxx	825373440	WatchDogFailure	16777215	19719442	

Print Time : 2003/12/30 03:34 PM Page 1 Panorama : ECS_CO-OP2

FIGURE 8-33 Telepack Error Log Report

8.4.7.1 Header

The Telepack Error Log Report header provides the title of the report and the connected Device ID for the connected wireless device.

8.4.7.2 Error Log Data

The Telepack Error Log Report's error log data section displays all of the logged error messages for any connected Telepack device in a columnar format. These messages are used to diagnose a problem with the connected wireless device.

8.4.7.3 Footer

The Telepack Error Log Report contains a footer at the bottom the page. The footer includes:

- The date and time of the print request. The format displayed is taken from the **System Date/Time** tab. For more information regarding date/time formats, refer to the "Date/Time Tab" on page 9-41.
- A centered page number.
- The name of the Panorama Central Station where the report was generated.

8.4.7.4 Printing a Telepack Error Log Report

The Telepack Error Log Report prints in a landscape orientation. Follow these steps to print this report:

1. From the **Wireless** tab, select the **Error Log** sidebar button.
2. Select the **Print** menu bar button.

Requesting this report posts a print job in the system Print Status tab. For additional information, refer to the "Print Status Tab" on page 8-38.

8.4.8 System Alarm Report

The System Alarm Report (shown in FIGURE 8-34) shows all of the system default settings for the parameter alarms available in the Panorama Central Station. The report includes header, System Alarm data, optional arrhythmia and paging delay settings, and a footer section.

System Alarm Report						
Patient Size : Adult						
Parameter	Units	High Limit	Low Limit	Priority	Print On Alarm	Save To Event
HR	BPM	150	50	2	OFF	ON
NIBP Sys	mmHg	OFF	OFF	3	OFF	ON
NIBP Dia	mmHg	OFF	OFF	3	OFF	ON
NIBP Mean	mmHg	OFF	OFF	3	OFF	ON
SpO2	%	OFF	85	2	OFF	ON
Resp	RPM	OFF	OFF	3	OFF	ON
INSPCO2	%	OFF	---	3	OFF	ON
ETCO2	%	8.0	OFF	3	OFF	ON
PVC/min	PVC/min	OFF	---	3	OFF	ON
IBP1 Sys	mmHg	OFF	OFF	3	OFF	ON
IBP1 Dia	mmHg	OFF	OFF	3	OFF	ON
IBP1 Mean	mmHg	OFF	OFF	3	OFF	ON
IBP2 Sys	mmHg	OFF	OFF	3	OFF	ON
IBP2 Dia	mmHg	OFF	OFF	3	OFF	ON
IBP2 Mean	mmHg	OFF	OFF	3	OFF	ON
IBP3 Sys	mmHg	OFF	OFF	3	OFF	ON
IBP3 Dia	mmHg	OFF	OFF	3	OFF	ON
IBP3 Mean	mmHg	OFF	OFF	3	OFF	ON
IBP4 Sys	mmHg	OFF	OFF	3	OFF	ON
IBP4 Dia	mmHg	OFF	OFF	3	OFF	ON
IBP4 Mean	mmHg	OFF	OFF	3	OFF	ON
T1	°F	OFF	OFF	3	OFF	ON
T2	°F	OFF	OFF	3	OFF	ON
Delta T	°F	OFF	OFF	3	OFF	ON
Tb	°F	OFF	OFF	3	OFF	ON
HAL	%	---	---	3	OFF	ON
ISO	%	---	---	3	OFF	ON
ENF	%	---	---	3	OFF	ON
SEV	%	---	---	3	OFF	ON
DES	%	---	---	3	OFF	ON
INSPO2	%	---	---	3	OFF	ON
INSPN2O	%	---	---	3	OFF	ON
ST Single	mm	OFF	OFF	2	OFF	ON
ST Dual	mm	OFF	OFF	2	OFF	ON
Nurse Call	---	---	---	3	OFF	ON
Apnea	---	60	---	3	OFF	ON
Asystole	---	---	---	1	OFF	ON
Bigeminy	---	---	---	3	OFF	ON
Couplet	---	---	---	3	OFF	ON
Irregular HR	---	---	---	3	OFF	ON
Run	---	---	---	3	OFF	ON
Trigeminy	---	---	---	3	OFF	ON
V-Fib	---	---	---	1	OFF	ON
V-Tach	---	---	---	1	OFF	ON
V-Rhythm	---	---	---	3	OFF	ON
Pause	---	---	---	2	OFF	ON
Brady	---	---	---	1	OFF	ON
Arrhythmia Settings						
Asystole Delay: 4 Sec.		V-Tach Threshold: 3 Beats		All Arrhythmia On/Off: ON		V-Tach Rate: 120 BPM
ECG Noise Delay: 5 Sec.						
Print Time: 2007/07/17 12:56 PM			Page 1		Panorama: CENTRAL86B	

FIGURE 8-34 System Alarm Report - Paging Option Disabled

System Alarm Report							
Patient Size : Adult							
Parameter	Units	High Limit	Low Limit	Priority	Print On Alarm	Save To Event	Page On Alarm
HR	BPM	150	50	2	OFF	ON	OFF
NIBP Sys	mmHg	OFF	OFF	3	OFF	ON	OFF
NIBP Dia	mmHg	OFF	OFF	3	OFF	ON	OFF
NIBP Mean	mmHg	OFF	OFF	3	OFF	ON	OFF
SpO2	%	OFF	85	2	OFF	ON	OFF
Resp	RPM	OFF	OFF	3	OFF	ON	OFF
INSPCO2	%	OFF	---	3	OFF	ON	OFF
ETCO2	%	8.0	---	3	OFF	ON	OFF
PVC/min	PVC/min	OFF	---	3	OFF	ON	OFF
IBP1 Sys	mmHg	OFF	OFF	3	OFF	ON	OFF
IBP1 Dia	mmHg	OFF	OFF	3	OFF	ON	OFF
IBP1 Mean	mmHg	OFF	OFF	3	OFF	ON	OFF
IBP2 Sys	mmHg	OFF	OFF	3	OFF	ON	OFF
IBP2 Dia	mmHg	OFF	OFF	3	OFF	ON	OFF
IBP2 Mean	mmHg	OFF	OFF	3	OFF	ON	OFF
IBP3 Sys	mmHg	OFF	OFF	3	OFF	ON	OFF
IBP3 Dia	mmHg	OFF	OFF	3	OFF	ON	OFF
IBP3 Mean	mmHg	OFF	OFF	3	OFF	ON	OFF
IBP4 Sys	mmHg	OFF	OFF	3	OFF	ON	OFF
IBP4 Dia	mmHg	OFF	OFF	3	OFF	ON	OFF
IBP4 Mean	mmHg	OFF	OFF	3	OFF	ON	OFF
T1	°F	OFF	OFF	3	OFF	ON	OFF
T2	°F	OFF	OFF	3	OFF	ON	OFF
Delta T	°F	OFF	OFF	3	OFF	ON	OFF
Tb	°F	OFF	OFF	3	OFF	ON	OFF
HAL	%	---	---	3	OFF	ON	OFF
ISO	%	---	---	3	OFF	ON	OFF
ENF	%	---	---	3	OFF	ON	OFF
SEV	%	---	---	3	OFF	ON	OFF
DES	%	---	---	3	OFF	ON	OFF
INSPQ2	%	---	---	3	OFF	ON	OFF
INSPN2O	%	---	---	3	OFF	ON	OFF
ST Single	mm	OFF	OFF	2	OFF	ON	OFF
ST Dual	mm	OFF	OFF	2	OFF	ON	OFF
Nurse Call	---	---	---	3	OFF	ON	OFF
Apnea	---	60	---	3	OFF	ON	OFF
Asystole	---	---	---	1	OFF	ON	OFF
Bigeminy	---	---	---	3	OFF	ON	OFF
Couplet	---	---	---	3	OFF	ON	OFF
Irregular HR	---	---	---	3	OFF	ON	OFF
Run	---	---	---	3	OFF	ON	OFF
Trigeminy	---	---	---	3	OFF	ON	OFF
V-Fib	---	---	---	1	OFF	ON	OFF
V-Tach	---	---	---	1	OFF	ON	OFF
V-Rhythm	---	---	---	3	OFF	ON	OFF
Pause	---	---	---	2	OFF	ON	OFF
Brady	---	---	---	1	OFF	ON	OFF

Arrhythmia Settings

Asystole Delay: 4 Sec. V-Tach Threshold: 3 Beats All Arrhythmia On/Off: ON V-Tach Rate: 120 BPM
 ECG Noise Delay: 5 Sec.

Paging Delay Settings

Paging Delay: 10 Sec.

Print Time: 2007/07/12 11:58 AM Page 1 Panorama: SHSTATION

FIGURE 8-35 System Alarm Report - Paging Option Enabled

8.4.8.1 Header

The System Alarm Report's header provides the title of the report.

8.4.8.2 System Alarm Information

The System Alarm section of the report will display all of the system alarm default settings, as configured at the Panorama Central Station. Alarm limits are listed for the Adult, Pediatric and Neonate patient sizes.

The following alarm information is shown in the report:

- **Parameter** displays the name of the parameter for which the alarm is set.
- **Units** displays the default unit of measure in which the parameter is shown. If the unit of measure is not applicable to the parameter, dashes (–) display instead of a unit of measure.

- **High Limit** displays the high limit for the alarm setting. Measurements that exceed this setting will trigger an alarm condition. If a high limit is not applicable to the parameter, dashes (–) display instead of the high limit.
- **Low Limit** displays the low limit for the alarm setting. Measurements below this setting trigger an alarm condition. If a low limit is not applicable to the parameter, dashes (–) display instead of the low limit.
- **Priority** displays the importance rating for the alarm. The alarm priorities available to each parameter may differ.
- **Print On Alarm** displays whether or not the parameter data should be printed during an alarm condition. Print On Alarm settings include ON and OFF.
- **Save To Event** displays whether or not the parameter data should be saved as an event during an alarm condition. Save To Event settings include ON and OFF.

Alarm settings can be customized to a patient using the patient Alarms tabs.

8.4.8.3 Arrhythmia Settings

The System Alarm Report's Arrhythmia Settings section includes values for the following:

- Asystole Delay
- V-Tach Threshold
- All Arrhythmia On/Off
- V-Tach Rate
- ECG Noise Delay

8.4.8.4 Paging Delay Settings

The System Alarm Report's Paging Delay section includes the system paging delay value that was configured in the System Alarms tab.

8.4.8.5 Footer

The System Alarm Report contains a footer at the bottom of the report page. The footer includes:

- The date and time of the print request. The format displayed is taken from the **System Date/Time** tab.
- A centered page number.
- The name of the Panorama Central Station where the report was generated.

8.4.8.6 Printing a System Alarm Report

The System Alarm Report is printed in portrait orientation. Follow these steps to print this report:

1. From the **System Alarms** tab, select the **System Alarm Limits** sidebar button.
2. Select the **Print** menu bar button. The report is sent to the printer.

Requesting this report posts a print job in the system Print Status tab. For additional information, refer to the "Print Status Tab" on page 8-38.

8.4.9 Troubleshooting

This section lists some of the potential messages and issues that may occur while trying to print an additional report.

MESSAGE/ISSUE *	REASON	SOLUTION
The report will not print	There are several reasons that would cause a report not to print. It could be a problem with the communication between the printer and the Panorama Central Station or simply a problem with the printer.	If there is an error that appears such as Printer out of Paper you will need to remedy that situation. If the No Printer connected or Printer not Available error is displayed check that the printer was properly configured with the Panorama Central Station. Refer to the Printer Configuration manual (P/N 0070-00-0561).

* *Messages are shown in all bold text.*

System Setup Functions

This section outlines the tabs and default configuration settings associated with the Panorama Central Station, the ViewStation, and the WorkStation.

- Parameter Color Tab
- Touch Screen Tab
- Installation Setup Tab
- Care Group Tab
- Volume Tab
- System Alarms Tab
- Passwords Tab
- Equipment Setup Tab
- More Tab
- Previous Tab
- Date/Time Tab
- Print Setup Tab (System)
- Unit Priorities Tab
- Unit Choices Tab
- Wave Gain Tab (System)
- Wireless Tab

9.1 Parameter Color Tab

The **Parameter Color** tab (shown in FIGURE 9-1) selects the system default colors for the parameters which will be displayed in the patient tile. This tab is available at the ViewStation and the WorkStation, and it functions in the same manner as it does at the host central station. Parameter Color tab changes made at the central station or remote workstations are independent of each other.

9.1.1 Accessing the Parameter Color Tab

- From the menu bar, select the **System Setup** button. The tabs associated with the **System Setup** button are displayed. By default, the **Parameter Color** tab is displayed first.

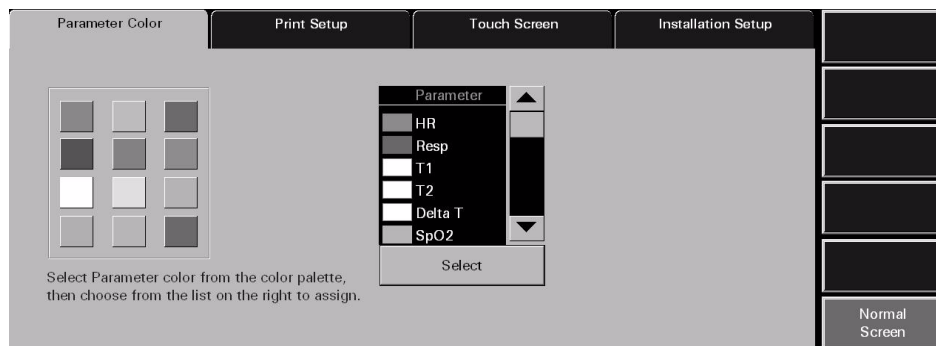

FIGURE 9-1 Parameter Color Tab

9.1.2 Selecting a Color for Parameter Data

This section outlines assigning a color to a parameter in the **Parameter Color** tab.

- Select a color tile button.
 - A checkmark indicates that the colored tile is selected.
 - An empty tile indicates that a colored tile is not selected.
- Select a parameter in the Parameter list box (use the scroll bars to view all of the parameters). When a parameter is selected, the associated label changes from a black background with white text to a white background with black text.
- Choose the **Select** button to accept the parameter selection. The color is assigned to the selected parameter and the color icon is shown in the list box to the left of the parameter name.

9.1.3 Sidebar Button - Normal Screen

Select the **Normal Screen** sidebar button to return the display to the full screen mode, and close all tabs, message boxes, and dialog boxes.

9.1.4 Troubleshooting

This section lists some of the potential messages and issues that may occur while using the **Parameter Color** tab.

MESSAGE/ISSUE *	REASON	SOLUTION
The System Setup menu button is disabled.	The System Setup function is already open on another Panorama display and cannot be opened on multiple displays.	Close the System Setup function on the Panorama display where it is open.

* *Messages are shown in all bold text.*

9.2 Touch Screen Tab

The **Touch Screen** tab provides a means to turn the touch screen on and off and recalibrate (or reset) the touch screen. This tab is available at the ViewStation and the WorkStation, and it functions in the same manner as it does at the host central station. Touch Screen tab changes made at the central station or remote workstations are independent of each other.

9.2.1 Accessing the Touch Screen Tab

1. From the menu bar, select the **System Setup** button. The first set of **System Setup** tabs is displayed.
2. Select the **Touch Screen** tab. A **Touch Screen On/Off** and **Recalibrate Touch Screen** button is displayed in the tab (shown in FIGURE 9-2).
3. For further instructions, refer to sections Turning the Touch Screen On or Off and Recalibrating the Touch Screen.

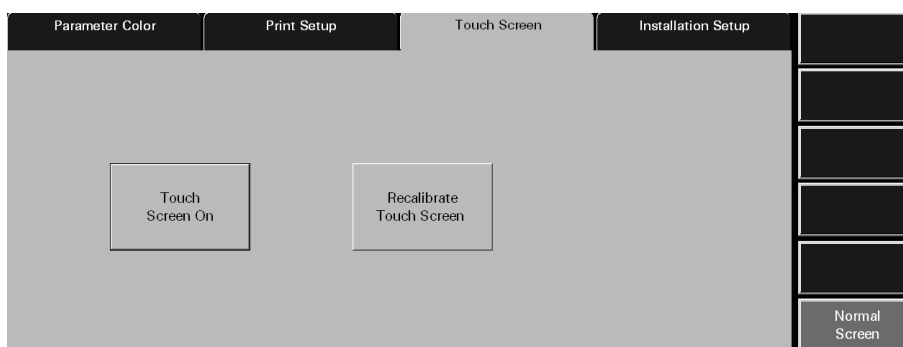

FIGURE 9-2 Touch Screen tab

9.2.1.1 Turning the Touch Screen On or Off

The touch screen may be turned on or off by selecting the Touch Screen On/Off button. If the touch screen is turned off, a mouse is required to navigate. When the touch screen is turned off, the message **Touch Screen Off** will be displayed in the lower left corner of the screen in the System Status line. By default, the touch screen is turned on.

9.2.1.2 Recalibrating the Touch Screen

The touch screen should be recalibrated whenever the touch interface becomes difficult to maneuver. By default the

1. From the menu bar, select the **System Setup** button. The first set of **System Setup** tabs is displayed.
2. Select the **Touch Screen** tab.
3. Select the **Recalibrate Touch Screen** button. The recalibration process is initiated (shown in FIGURE 9-3).

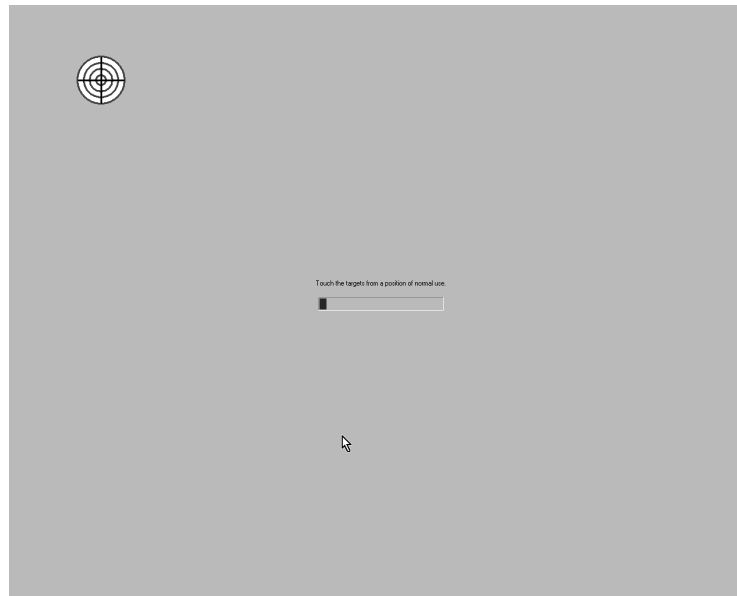

FIGURE 9-3 Recalibration Screen (Part I)

4. Touch the red targets on the screen as instructed. Three calibration targets will be displayed.

NOTE: The messages in the Recalibrate Touch Screen display are always displayed in the English language.

NOTE: During the recalibration process, the patient tiles, menu bar, and sidebar buttons will be replaced by the recalibration screen.

5. Once the three targets have been touched, the message **Touch the screen. Does the cursor follow your finger?** is displayed (shown in FIGURE 9-5).

Select either the or button.

- Select the button if the targets moved as they were selected. Once selected, the screen is recalibrated.
- Select the button if the targets did not move as they were selected. Once selected, the recalibration process begins again.

NOTE: When the central station, ViewStation, or WorkStation uses a dual display configuration, recalibration will affect both touch screen displays. The first touch screen display will be calibrated and then the second.

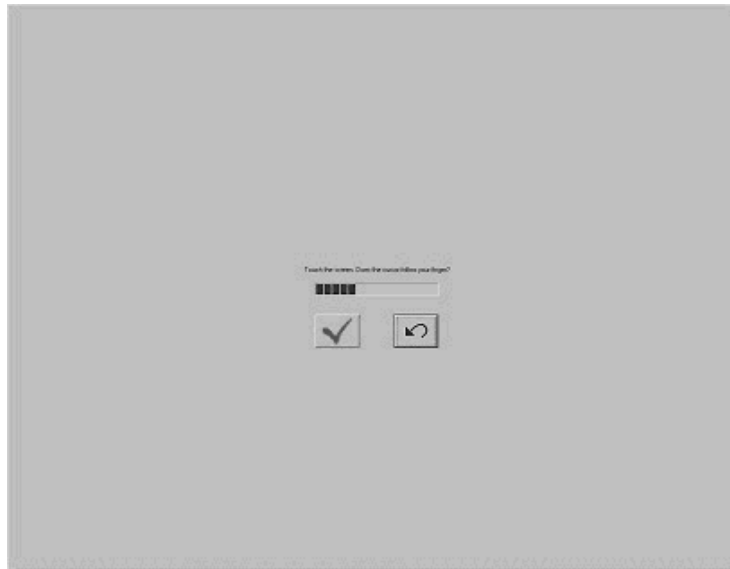



FIGURE 9-4 Recalibration Screen (Part II)

9.2.2 Sidebar Button - Normal Screen

Select the **Normal Screen** sidebar button to return the display to the full screen mode, and close all tabs, message boxes, and dialog boxes.

9.2.3 Troubleshooting

This section lists some of the potential messages and issues that may occur **Touch Screen** tab.

MESSAGE/ISSUE *	REASON	SOLUTION
Recalibration settings not accepted	The Recalibration screen timed out because the first target was not touched within 30 seconds.	Try to recalibrate again and touch the first target before the 30 second time out.
Recalibration steps are repeated	The  button was selected in error.	Recalibrate again and if the targets moved as they were selected, select the  button.
Touch Screen OFF	The Touch Screen On button was selected.	Use the mouse to navigate. If touch screen functionality is needed, press the Touch Screen OFF button again to reactivate the touch screen.

* *Messages are shown in all bold text.*

Contact your local Service Representative if recalibration of the touch screen does not improve the performance of the touch screen display.

9.3 Installation Setup Tab

The system **Installation Setup** tab (shown in FIGURE 9-5) controls access to restricted central station functions. This tab is available at the ViewStation and the WorkStation, and it functions in the same manner as it does at the host central station. The **Installation Setup** tab is password protected.

9.3.1 Accessing the Installation Setup Tab

1. From the menu bar, select the **System Setup** button. The first set of System Setup tabs is displayed.
2. Select the **Installation Setup** tab. The **Installation Setup** tab is displayed.

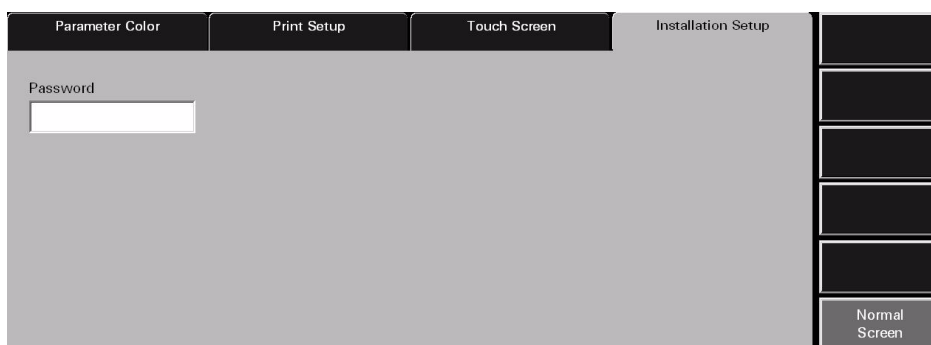

FIGURE 9-5 Installation Setup Tab

9.3.2 Entering a Password

To gain access to the protected central station system functions, the correct password must be entered in the **Installation Setup** tab's password box. The password required for the **Installation Setup** tab is defined in the system **Password** tab.

1. Select the **Password** text box in the **Installation Setup** tab. The keyboard dialog box is displayed.
2. Using the keyboard dialog box, enter the System password that was established in the **Passwords** tab (maximum 15 characters). For security purposes asterisks (*) are shown for each character entered.
3. Accept or reject the text entered in the keyboard dialog box. For additional information about using the keyboard dialog box, refer to "Keyboard Dialog Box" on page 2-18.

The following tabs can be accessed at the central station after the correct password has been entered in the **Installation Setup** tab: **Care Group, Volume, System Alarms, Passwords, Equipment Setup, More/Previous, Date/Time, Unit Priorities, Unit Choices, Wave Gain,** and **Wireless.**

The following tabs can be accessed at the ViewStation and the WorkStation after the correct password has been entered in the **Installation Setup** tab: **Volume, System Alarms, Passwords, Date/Time,** and **Unit Choices.**

9.3.3 Sidebar Button - Normal Screen

Select the **Normal Screen** sidebar button to return the display to the full screen mode, and close all tabs, message boxes, and dialog boxes.

9.3.4 Troubleshooting

This section lists some of the potential messages and issues that may occur while using the **Installation Setup** tab.

MESSAGE/ISSUE *	REASON	SOLUTION
Incorrect password. Please try again.	The wrong password was entered in the Password text box.	Select the OK button to close the dialog box. Enter the correct password in the text box.
	The password was entered in the wrong case.	Re-enter the password turning on/off the keyboard dialog Caps Lock key.
Incorrect password. This is your last chance. Please try again.	The wrong password was entered two consecutive times in the Password text box.	Select the OK button to close the dialog box. Enter the correct password in the text box.
The Installation Setup tab closes and the Panorama Central Station is returned to a full screen monitoring display	The wrong password was entered three consecutive times in the Password text box.	Reopen the Installation Setup tab and enter the correct password in the text box.
The System Setup menu button is disabled.	The System Setup function is already open on another Panorama display and cannot be opened on multiple displays.	Close the System Setup function on the Panorama display where it is open.

* *Messages are shown in all bold text.*

9.4 Care Group Tab

The system **Care Group** tab (shown in FIGURE 9-6) allows for the default assignment of selected patient tiles to specific system care groups. This enables a patient tile to automatically be assigned to a specific care group upon admission to the Panorama Central Station. The central station supports up to twelve care groups. Each care group is associated with a unique color indicator and a unique reference label. The **Care Group** tab and the associated colorized indicator are not available at the ViewStation or the WorkStation.

Care groups may be used to indicate a special meaning with regard to a patient tile. For example, care groups may be used to represent a specific care-giver, hospital department, or a critical monitoring condition. Contact the System Administrator before making adjustments to the system care groups.

9.4.1 Accessing the Care Group Tab

1. From the menu bar, select the **System Setup** button. The **Password** tab is displayed.
2. Follow the directions in the "Entering a Password" section on page 9-7.
3. Once the correct password has been entered, the tabs associated with the **System Setup** button are displayed. By default, the **Care Group** tab is displayed first.

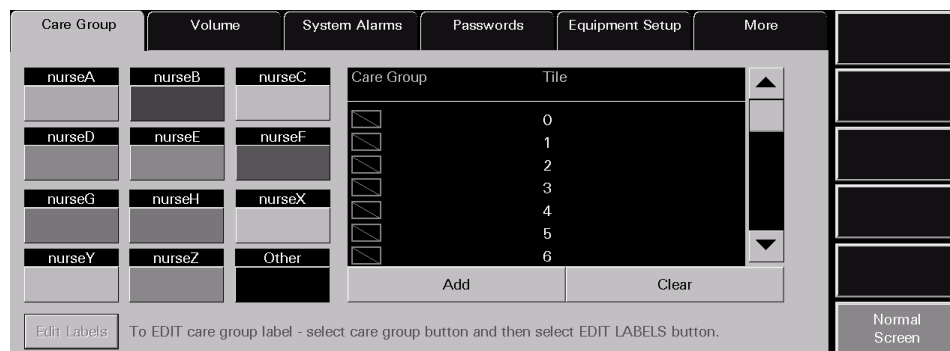

FIGURE 9-6 Care Group Tab

9.4.2 Editing Care Group Labels

This section outlines editing the system Care Group reference label.

Selecting a Patient's Care Group

1. Select a care group by choosing the colored tile below the care group label. When a care group is selected, the reference label changes from a black background with white text to a white background with black text.
2. Select the **Edit Labels** button. The keyboard dialog box is displayed.
3. Enter the name for the selected care group (maximum of 6 characters). The name is displayed in the white text box.
4. Accept or reject the text entered in the keyboard dialog box. For additional information about using the keyboard dialog box, refer to "Keyboard Dialog Box" on page 2-18.

9.4.3 Assigning a Patient Tile to a Care Group

The assignment of a system care group occurs when a patient is admitted to a tile at the Panorama Central Station. When a patient tile is assigned to a care group, the color associated with the care group will be shown in vertical bar beside the patient tile **VIEW** button. To adjust the care group assignment of an active patient tile, refer to the "Demographics Tab" on page 5-2.

This section outlines assigning system default care group settings to specific patient tiles.

Selecting/Editing a Patient's Care Group

1. Select a care group tile by selecting the colored tile below the care group label. When a tile is selected the associated label changes from a black background with white text to a white background with black text.
2. Select the tile number to be assigned to the selected care group. When a tile is selected it changes from a black background with white text to a white background with black text.
3. Accept or reject the care group assignment.
 - Select the **Add** button to assign the selected patient to the care group. The care group icon is displayed next to the selected patient tile in the care group list box.
 - Select the **Clear** button to delete the care group currently assigned to the selected patient.

9.4.4 Sidebar Button - Normal Screen

Select the **Normal Screen** sidebar button to return the display to the full screen mode, and close all tabs, message boxes, and dialog boxes.

9.4.5 Troubleshooting

This section lists some of the potential messages and issues that may occur while using the system **Care Group** tab.

MESSAGE/ISSUE *	REASON	SOLUTION
The System Setup menu button is disabled.	The System Setup function is already open on another Panorama display and cannot be opened on multiple displays.	Close the System Setup function on the Panorama display where it is open.

* *Messages are shown in all bold text.*

9.5 Volume Tab

The system **Volume** tab (shown in FIGURE 9-7 and FIGURE 9-8) adjusts the system default volume levels. Volume levels can be adjusted for system alarms and physiological alarms. This tab is available at the ViewStation and the WorkStation, and it functions in the same manner as it does at the host central station. Volume tab changes made at the central station or remote workstations are independent of each other.

9.5.1 Accessing the Volume Tab

1. From the menu bar, select the **System Setup** button. The **Parameter Color** tab is displayed.
2. Select the **Installation Setup** tab. The **Installation Setup** tab is displayed.
3. Follow the directions in the "Entering a Password" section on page 9-7.
4. Once the correct password has been entered, the tabs associated with the **System Setup** button are displayed.
5. Select the **Volume** tab. The **Volume** tab is displayed.

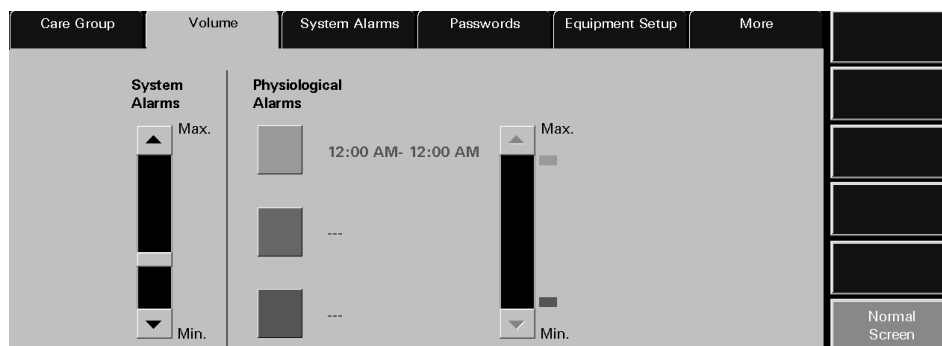

FIGURE 9-7 Volume Tab (Central Station)

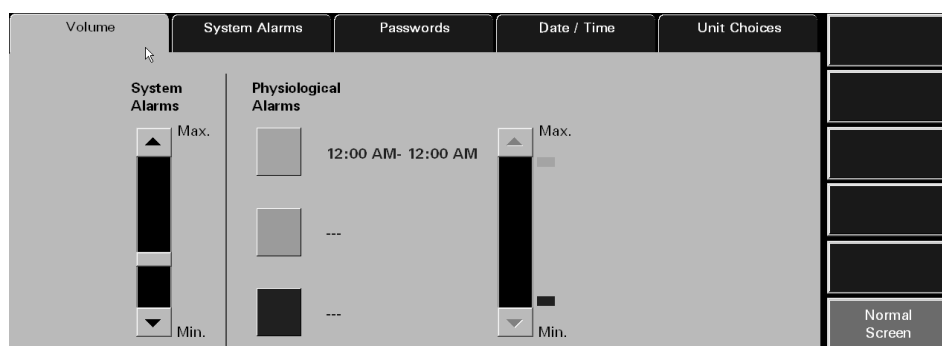

FIGURE 9-8 Volume Tab (ViewStation and WorkStation)

CAUTION: Do not block the speakers. Set the volume levels so that alarms can be heard at all times, as described in this Operation Manual.

Setting a System Alarms Volume Level

The System Alarms volume setting determines the volume of the sound associated with the Panorama Central Station alarm settings.

Characteristics of the System Alarms volume setting:

- A volume level range of 10-100%
- A factory default setting of 30%
- It cannot be turned OFF

NOTE: Adjustments to the System Alarms volume setting will take effect immediately.

To adjust the System Alarms volume level:

- Move the volume control scroll bar box or the scroll bar arrows up (to maximize sound) or down (to minimize sound)

Setting a Physiological Alarms Volume Level

The Physiological Alarm volume level is a system setting that applies to enabled numeric and arrhythmia alarm violations. The Panorama Central Station allows up to three time specified volume settings to be configured for physiological alarms. This feature allows user-defined volume settings for physiological alarms to be specified, based on the time of day.

Characteristics of the Physiological Alarm volume setting:

- The time period format for physiological alarms will follow the system's time format
- A volume level range of 10-100%
- A factory default setting of 100%
- It cannot be turned OFF

CAUTION: Do not block the speakers. Set the volume levels so that alarms can be heard at all times, as described in this Operation Manual.

1. Select the colored tile that corresponds to the time period for which the volume level is being adjusted.
 - A checkmark in the colored tile indicates that the tile has been selected and the **From/To** fields are displayed.
 - A colored tile without a checkmark indicates that the tile has not been selected.
2. Select the **From/To** fields to enter a time period for the selected physiological alarm. The keypad dialog box displays.
 - Delete existing hour and minute data by using the **CLEAR** or **CE** buttons on the keypad.
 - When using the 12-hour time format, the **AM/PM** toggle button switches between the AM and PM settings.

NOTE: Time periods are mutually exclusive. When a new time period is entered, the time periods for the other physiological alarms are automatically adjusted to prevent overlapping of time periods.

3. Set the volume level for the selected physiological alarm.

To adjust the volume level, move the volume control scroll bar box or the scroll bar arrows up (to maximize sound) or down (to minimize sound). The colored icon to the right of the scroll bar is automatically moved when the volume level is adjusted.

4. Select the **Done** button to save the physiological alarm volume adjustments. The Physiological Alarm volume adjustments will take effect once the **Done** button is selected.

9.5.2 Sidebar Button - Normal Screen

Select the **Normal Screen** sidebar button to return the display to the full screen mode, and close all tabs, message boxes, and dialog boxes.

9.5.3 Troubleshooting

This section lists some of the potential messages and issues that may occur while using the **Volume** tab.

MESSAGE/ISSUE *	REASON	SOLUTION
The System Setup menu button is disabled.	The System Setup function is already open on another Panorama display and cannot be opened on multiple displays.	Close the System Setup function on the Panorama display where it is open.

* *Messages are shown in all bold text.*

9.6 System Alarms Tab

The **System Alarms** tab (shown in FIGURE 9-10, FIGURE 9-11, and FIGURE 9-11) controls the default settings for system alarm options, specific alarm limits, and alarm response functions. This tab is available at the ViewStation and the WorkStation, and it functions in the same manner as it does at host central station with fewer buttons. System Alarms tab changes made at the central station or remote workstations are independent of each other.

For information regarding individual patient alarm settings, refer to the "Patient Alarm Setup Tab (Optional)" on page 6-2.

9.6.1 System Alarms (Options) Tab

The **System Alarms** (System Alarm Options) tab controls the system default settings for patient alarms.

9.6.1.1 Accessing the System Alarm (Options) Tab

1. From the menu bar, select the **System Setup** button. The **Password** tab is displayed.
2. Follow the directions in the "Entering a Password" section on page 9-7.
3. Once the correct password has been entered, the tabs associated with the **System Setup** button are displayed.
4. Select the **System Alarms** tab. The **System Alarms** (System Alarm Options) tab is displayed.

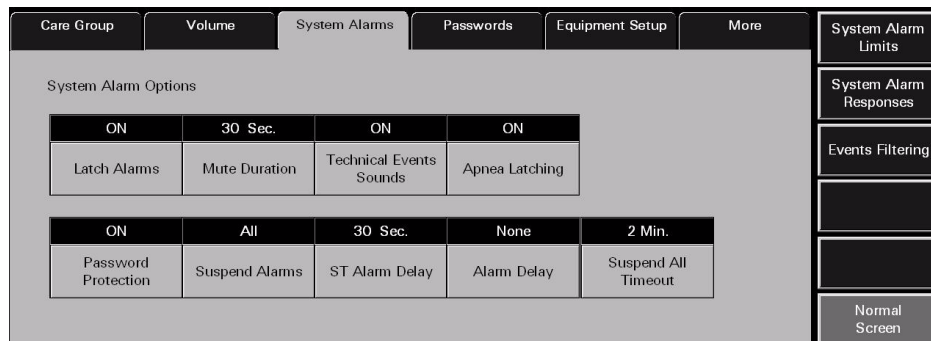

FIGURE 9-9 System Alarms (System Alarm Options) Tab (Central Station)

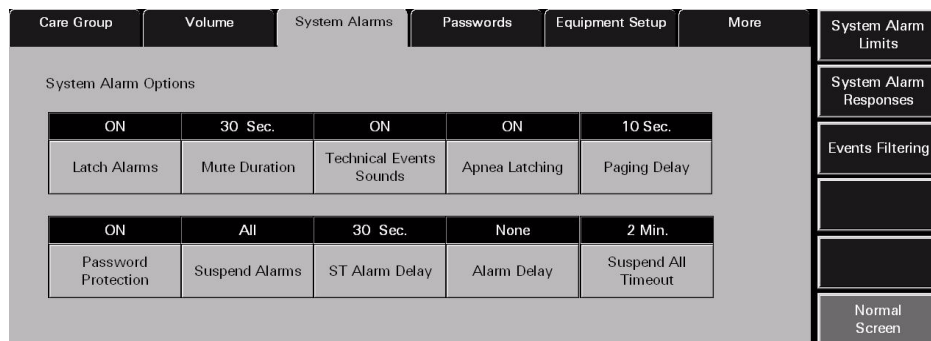

FIGURE 9-10 System Alarms (System Alarm Options) Tab - Paging Option Enabled (Central Station)

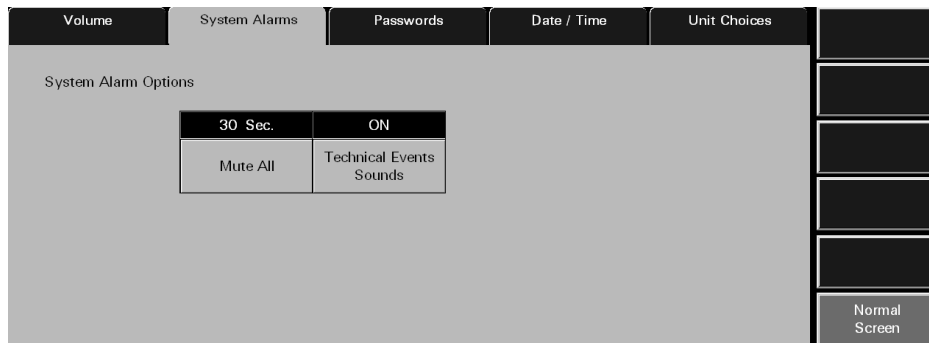

FIGURE 9-11 System Alarms (System Alarm Options) Tab (ViewStation)

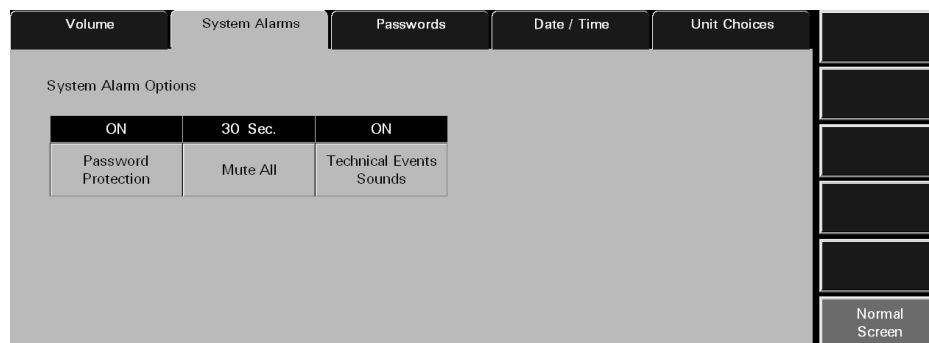

FIGURE 9-12 System Alarms (System Alarm Options) Tab (WorkStation)

9.6.1.2 Setting the System Alarms Options (Central Station)

This section outlines selecting system alarm option defaults.

1. Select the **Latch Alarms** toggle button to either enable or disable the latch alarms function. Latch Alarm options include **ON** and **OFF**. The factory default setting is **ON**. Alarm latching allows physiological alarms to continue their alarm behaviors until the alarm is acknowledged by the user.
 - The **ON** option indicates that alarm latching is enabled.
 - The **OFF** option indicates that alarm latching is disabled.

NOTE: The Latch Alarms option will not affect apnea alarms, lethal arrhythmias, and non-lethal arrhythmias.

NOTE: Changes to the Latch Alarms option will only affect new alarm violations.

2. Select the **Mute Duration** button to select the mute duration period for alarms in the Panorama Central Station. The mute duration period is the amount of time an alarm parameter will be silenced. Mute Duration periods include 10 seconds, 15 seconds, 30 seconds, 45 seconds, 60 seconds, and 120 seconds. The factory default setting is 30 seconds.

NOTE: Changes to the Mute Duration period will take effect within ten (10) seconds of the change.

NOTE: Using the Mute Duration button will not affect the visual indicators associated with an alarm.

3. Select the **Technical Events Sounds** toggle button to enable or disable sound during a technical event. **Technical Events Sounds** options include **ON** and **OFF**. The factory default setting is **ON**.
 - The **ON** option indicates that **Technical Events Sounds** will be heard during a technical event.
 - The **OFF** options indicates that **Technical Events Sounds** will not be heard during a technical event.

NOTE: Changes to the **Technical Events Sounds** option will affect all patients within ten (10) seconds of the change.

4. Select the **Apnea Latching** toggle button to either enable or disable the apnea latching function. Apnea latching is the ability to set Apnea alarms to continue the alarm behaviors until the alarm is acknowledged by the user. Apnea latching options include **ON** and **OFF**. The factory default setting is **ON**.
 - The **ON** option indicates that **Apnea Latching** will be enabled.
 - The **OFF** options indicates that **Apnea Latching** will not be enabled.

NOTE: Changes to the **Apnea** option will affect all new Apnea alarms.

5. Select the **Paging Delay** button to select a paging delay for the system. This button will only be available when the paging option has been enabled. The Paging Delay options include 5 seconds, 10 seconds, 15 seconds, 20 seconds, 25 seconds, and 30 seconds. The factory default setting is 10 seconds.

NOTE: Changing the **Paging Delay** will only be applied to newly admitted patients and will not affect patients currently being monitored or to currently alarming parameters.

NOTE: This option will only be displayed if the **Paging** option is enabled at the central station.

6. Select the **Password Protection** toggle button to either enable or disable the password protection for the **Patient Alarms** tab in the Panorama Central Station or the WorkStation. **Password Protection** options include **ON** and **OFF**. The factory default setting is **ON**.
 - The **ON** option indicates that **Password Protection** will be enabled when trying to access the **Patient Alarms** tab.
 - The **OFF** options indicates that **Password Protection** will not be enabled when trying to access the **Patient Alarms** tab.

NOTE: Changes to the **Password Protection** option will affect all patients upon entering the **Patient Alarms** tab.

7. Select the **Suspend Alarms** toggle button to either enable or disable the ability to suspend all, all non-lethal, or disable the ability to suspend any alarms. Suspend Alarms options include **All**, **OFF**, and **Non-Lethal**. The factory default setting is **All**.
 - The **All** option indicates that the **Suspend All Alarms** and the **Suspend Non-Lethal** sidebar button will be available in the **Patient Alarms** tabs.
 - The **Non-Lethal** option indicates that only the **Suspend Non-Lethal** sidebar button will be available in the **Patient Alarms** tabs.
 - The **OFF** option indicates that neither the **Suspend All Alarms** nor the **Suspend Non-Lethal** sidebar buttons will be accessible in the **Patient Alarms** tab.

NOTE: Changes to the **Suspend Alarms** option will affect all patients upon entering the **Patient Alarms** tab.

8. Select the **ST Alarm Delay** button to set an alarm delay for ST alarms. **ST alarm delay** is the period of time that the Panorama Central Station will wait before ST alarm notification. **ST Alarm Delay** options include 30 seconds, 45 seconds, 1 minute, 90 seconds, 2 minutes, and 3 minutes. The factory default setting is 30 seconds.

NOTE: **ST Alarm Delay** only affects new ST alarms for Telepack devices. When using a bedside monitor, the ST alarm delay settings are transferred to the central station.

9. Select the **Alarm Delay** button to set an alarm delay for the Panorama Central Station. The alarm delay is the period of time that the Panorama Central Station will wait before alarm notification. Alarm Delay options include None, 1 second, 2 seconds, 3 seconds, 4 seconds, 5 seconds, 6 seconds, 7 seconds, and 8 seconds. The factory default setting is None.

NOTE: **Alarm Delay** only affects new alarms for Telepack devices. When using a bedside monitor, the ST alarm delay settings are transferred to the central station.

10. Select the **Suspend All Timeout** button to temporarily suspend all alarms or all non-lethal alarms for a configured time period. This button is only enabled when the **Suspend Alarms** option is set to **All**. When this option is enabled, and a time period is selected, either the **Suspend All Alarms** or the **Suspend Non-Lethal** sidebar button in the Patient Alarm Limits and Patient Alarm Responses tab must be selected before the alarm suspension begins. **Suspend All Timeout** options include 2 minutes, 3 minutes, 5 minutes, 10 minutes, and None. The factory default setting is 2 minutes.

9.6.1.3 Setting the System Alarm Options (ViewStation and WorkStation)

This section outlines selecting system alarm option defaults at the ViewStation and the WorkStation.

The ViewStation and the WorkStation are independent of each other. For example, if an option is selected at the ViewStation, the WorkStation will not be affected unless the same option is selected at the WorkStation.

1. Select the **Password Protection** toggle button to either enable or disable the password protection for the **Patient Alarms** tab at the WorkStation. **Password Protection** options include **ON** and **OFF**. The factory default setting is **ON**.
 - The **ON** option indicates that **Password Protection** will be enabled when trying to access the **Patient Alarms** tab.
 - The **OFF** options indicates that **Password Protection** will not be enabled when trying to access the **Patient Alarms** tab.

NOTE: The **Password Protection** toggle button is not available at the ViewStation.

NOTE: Changes to the **Password Protection** option will affect all patients upon entering the **Patient Alarms** tab at the WorkStation.

2. Select the **Mute All** button to select the mute duration period for alarms. The mute duration period is the amount of time an alarm parameter will be silenced. Mute duration periods include 10 seconds, 15 seconds, 30 seconds, 45 seconds, 60 seconds, 120 seconds, and Permanent. The factory default setting is 30 seconds.

NOTE: The host central station will not have a Mute All button.

NOTE: The Mute All button will affect all patient tiles at the ViewStation and WorkStation (if selected at both sites). The Mute All function will not affect the patient tiles at the host central station.

NOTE: Selecting the Mute All button will not affect the visual indicators associated with an alarm.

3. Select the **Technical Events Sounds** toggle button to enable or disable sound during a technical event. **Technical Events Sounds** options include **ON** and **OFF**. The factory default setting is **ON**.

- The **ON** option indicates that **Technical Events Sounds** will be heard during a technical event.
- The **OFF** options indicates that **Technical Events Sounds** will not be heard during a technical event.

NOTE: Changes to the Technical Events Sounds option will affect all patients within ten (10) seconds of the change.

9.6.2 System Event Filtering

Select the **Events Filtering** sidebar button to control the system default event filters that will initially be used when a selected patient tile's **Events** tab is opened.

System Event filters can be configured based on time, parameters, or both. ViewStation and WorkStation patient tiles will initially display the same event filter settings of the associated patient tile at the host central station.

For information regarding patient level event filtering, refer to "Event Filtering" on page 7-28.

9.6.2.1 Accessing the Events Filter

To access the system events filter view (shown in FIGURE 9-13), select the **Events Filtering** sidebar button from the **System Alarms Options** tab.

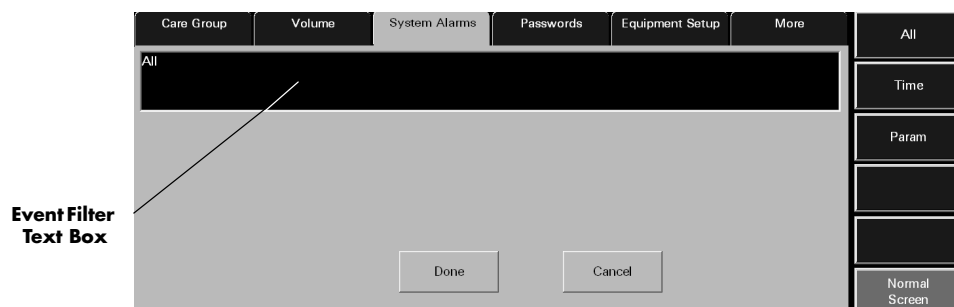

FIGURE 9-13 System Alarms - Events Filtering (Central Station)

9.6.2.2 Components of the Events Filter

Event Filter Text Box

The Event Filter text box is where the selected filter settings are displayed. The factory default Event Filter text box lists "All" as the initial filter, which indicates that there are no active event filters being used.

Done Button

Select the **Done** button to close the **All Event Filter** view and return to the **System Alarm Options** tab.

Cancel Button

Select the **Cancel** button to close the **All Event Filter** view and return to the **System Alarm Options** tab.

9.6.2.3 Time Filters

By indicating a start time and an end time, only events included within the configured time period will be displayed.

Accessing the Time Filter

To access the Time Filter view (shown in FIGURE 9-14), select the **Time** sidebar button from the **Events Filter** view. If any previously selected time ranges were specified, they will be displayed in the Event Filter text box beside the **Time:** label, and in the Start Time and End Time text boxes.

FIGURE 9-14 Time Event Filter

Clearing Time Filters

To remove previously entered time filters, select the **Clear** button from the **Time Filter** view.

Configuring a Time Filter

To enter a start time:

1. Select the Start Time text box. The Start Time dialog box (shown in FIGURE 9-15) is displayed.

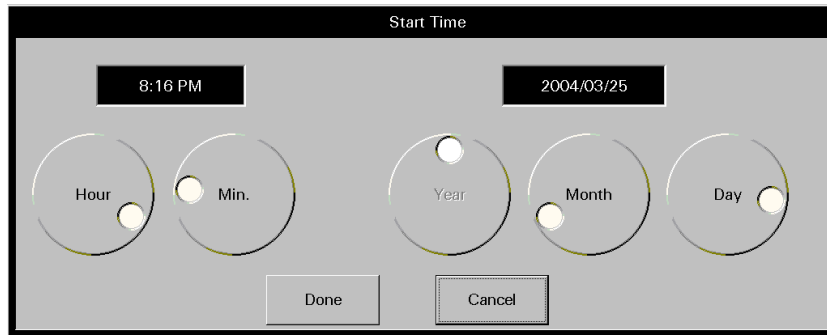

FIGURE 9-15 Start Time Dialog Box

2. Rotate the dial controls to select the hour and minute values.
3. Rotate the dial controls to select the month, day, and year values.
4. Accept or reject the selection made in the **Start Time** dialog box.
 - The **Done** button accepts the selections. When the **Done** button is selected, the date and time selected populates the Start Time text box, End Time text box, and the Event Filter text box.
 - The **Cancel** button discards the selections, closes the dialog box, and returns to the **Time Event Filter** view.

To enter an end time:

1. Select the End Time text box. The End Time dialog box (shown in FIGURE 9-16) is displayed.

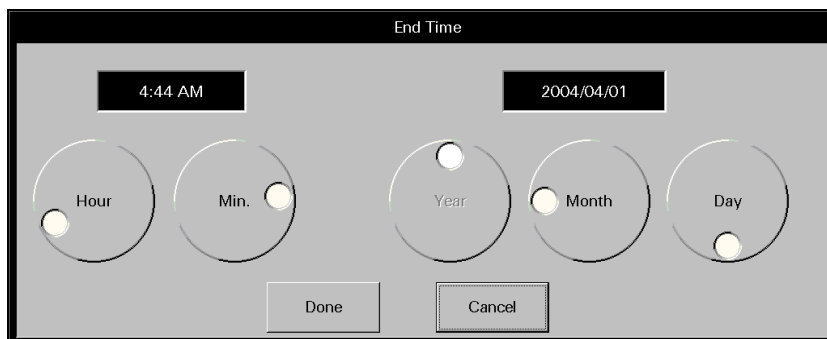

FIGURE 9-16 End Time Dialog Box

2. To enter the end time, follow steps 2, 3, and 4 from the previous section (entering a start time).

9.6.2.4 Parameter Filters

By indicating a parameter filter, only the selected parameters will be displayed. Parameter filters can be configured for physiological and technical events.

Accessing the Parameter Filter

To access the Parameter Filter (shown in FIGURE 9-17), select the **Param** sidebar button from the **All Events** view. By default, the physiological events are shown first. If any previously selected parameters were specified, they will be displayed in the Event Filter text box beside the **Param:** label.

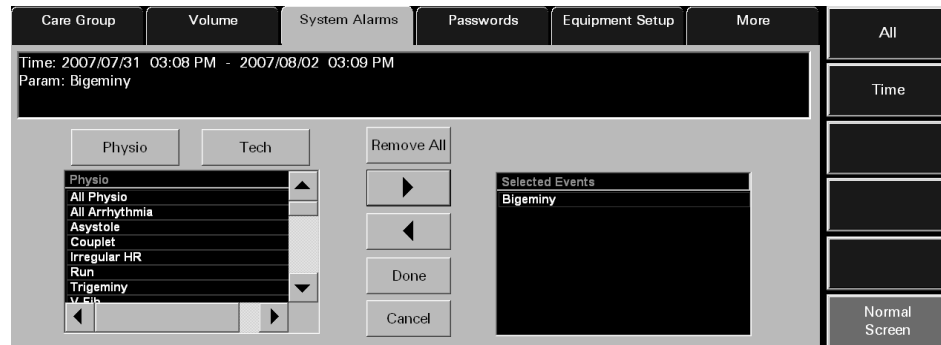

FIGURE 9-17 Parameter Event Filter View

Configuring a Parameter Filter

To configure a parameter filter:

1. If a technical event filter is needed, select the **Tech** button.

NOTE: By default, the physiological events are displayed when the **Param** sidebar is selected.

2. Move/remove the selected events by using any of the buttons described in the following table:

BUTTON	FUNCTION
Remove All	Removes all the events listed in the Selected Events list box and from the Event Filter text box.
Add/Right Arrow	Adds the selected event to the Selected Events list box, and to the Event Filter text box.
Remove/Left Arrow	Removes the chosen event from the Selected Events list box and from the Event Filter text box.
NOTE:	A maximum of five physiological and/or technical events may be added to the Selected Events list at one time.

3. Select the **Done** button to apply the selected event filter and return to the **List** view or select the **Cancel** button to restore the previously chosen filter settings.

9.6.2.5 Sidebar Buttons

The following sidebar buttons are used to expand the functionality of this tab.

System Alarm Limits

Select the **System Alarm Limits** sidebar button to display the **System Alarm Limits** tab. For additional information regarding system alarm limits, refer to “System Alarms (Alarm Limits) Tab” on page 9-23.

NOTE: The **System Alarm Limits** sidebar button is not available at the **ViewStation** or the **WorkStation**.

System Alarm Responses

Select the **System Alarm Responses** sidebar button to display the **System Alarm Responses** tab. For information regarding system alarm responses, refer to “Accessing the System Alarms (System Alarm Responses) Tab” on page 9-26.

NOTE: The **System Alarm Responses** sidebar button is not available at the **ViewStation** or the **WorkStation**.

Events Filtering

This sidebar button was previously described on page 9-18.

Normal Screen

Select the **Normal Screen** sidebar button to return the display to the full screen mode, and close all tabs, message boxes, and dialog boxes.

9.6.2.6

Troubleshooting

This section lists some of the potential messages and issues that may occur while using the System **Alarm Options** tab.

MESSAGE/ISSUE *	REASON	SOLUTION
The System Setup menu button is disabled.	The System Setup function is already open on a Panorama display and cannot be opened on multiple displays.	Close the System Setup function on the Panorama display on which it is opened.
The Paging Delay button is not displayed.	The central station where the patient tile resides does not have the Paging option enabled.	If the Paging feature was purchased, enable it.
The System Alarm Limits and System Alarm Responses tab is not available at the ViewStation or WorkStation.	System alarm limits and responses must be changed at the central station.	Change the alarm limits and responses from the central station.
Suspend All Timeout button is disabled.	The Suspend Alarms option is set to OFF or Non-Lethal.	Change the Suspend Alarms option to All.

* Messages are shown in all bold text.

9.6.3 System Alarms (Alarm Limits) Tab

The **System Alarms** (System Alarm Limits) tab (shown in FIGURE 9-18) controls the system default settings for the following alarm limits, according to patient size:

- Heart Rate (HR)
- ST Single
- PVC/min
- ST Dual

The remaining default parameter alarm limits are taken directly from the bedside device. The **System Alarms** (Alarm Limits) is available at the Panorama Central Station and the WorkStation. The ViewStation does not have an Alarm Limits tab. ViewStation Alarm limit settings are transferred from the host central to the ViewStation when the patient tile is assigned.

9.6.3.1 Accessing the System Alarms (System Alarm Limits) Tab

1. From the menu bar, select the **System Setup** button. The **Password** tab is displayed.
2. Follow the directions in the "Entering a Password" section on page 9-7.
3. Once the correct password has been entered, the tabs associated with the **System Setup** button are displayed.
4. Select the **System Alarms** tab. The **System Alarms** (System Alarm Options) tab is displayed.
5. Select the **System Alarm Limits** sidebar button. The **System Alarms** (System Alarm Limits) tab is displayed.

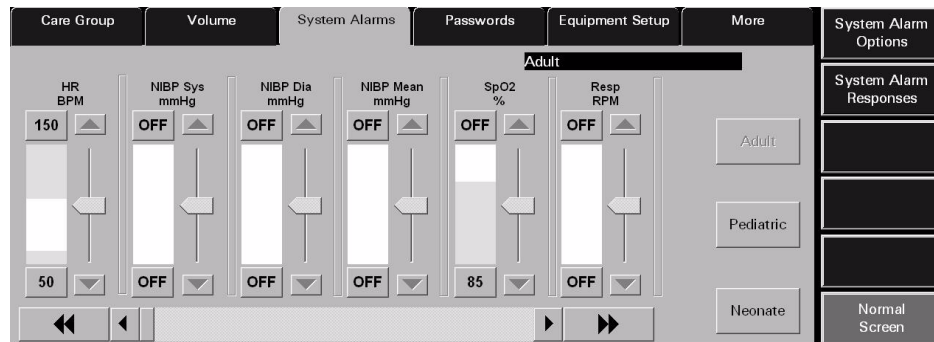

FIGURE 9-18 System Alarms (System Alarm Limits) Tab (Central Station)

9.6.3.2 Setting the System Alarm Limits

This section outlines setting system defaults for alarm limits, according to patient size.

The following steps should be performed for each patient size.

1. Select the **Patient Size** button to set the system alarm limit defaults for a specific patient size. Patient Size options include Adult, Pediatric, and Neonate. The factory default setting is Adult. When a **Patient Size** is selected, the button will change from black text on a grey background to grey text on a grey background.

2. Use the horizontal scroll bar in the **System Alarms** (System Alarm Limits) tab to locate the slider controls that need to be set or modified. Each page can show a maximum of six slider controls and a minimum of one slider control on each screen.
 - Select the double arrow scroll bar buttons to display the next/previous page of available parameter slider controls (until the first/last page is reached).
 - Select the single arrow scroll bar buttons to display the next/previous slider control (until the last/first control is shown).
3. Manually set the alarm limits for the selected parameter.

To set a high alarm limit:

- Select the upper alarm limit button to the left of the parameters slider bar. This button is either labeled with the word **OFF** or with the high alarm limit setting.
- To set an upper alarm limit, either select the up/down arrow buttons on the parameters vertical scroll bar or drag and drop the scroll box in the scroll bar.

To set a low alarm limit:

- Select the lower alarm limit button to the left of the parameters slider bar. This button is either labeled with the word **OFF** or with the low alarm limit setting.
- To set a lower alarm limit, either select the up/down arrow button on the parameter's vertical scroll bar or drag and drop the scroll box in the scroll bar.

For additional information on the default alarm limit ranges, refer to the "System Alarms Tab" on page 9-14.

9.6.3.3 Sidebar Buttons

The following sidebar buttons are used to expand the functionality of this tab.

System Alarm Options

Select the **System Alarm Options** sidebar button to display the **System Alarm Options** tab. For additional information regarding System Alarm Options, refer to the "System Alarms Tab" on page 9-14.

System Alarm Responses

Select the **System Alarm Responses** sidebar button to display the **System Alarm Responses** tab. For additional information regarding System Alarm Responses, refer to the "System Alarms Tab" on page 9-14.

Normal Screen

Select the **Normal Screen** sidebar button to return the display to the full screen mode, and close all tabs, message boxes, and dialog boxes.

9.6.3.4 Troubleshooting

This section lists some of the potential messages and issues that may occur while using the System **Alarm Limits** tab.

MESSAGE/ISSUE *	REASON	SOLUTION
The System Setup menu button is disabled.	The System Setup function is already open on a Panorama display and cannot be opened on multiple displays.	Close the System Setup function on the Panorama display on which it is opened.
The System Alarm Limits and System Alarm Responses tab is not available at the ViewStation or WorkStation.	System alarm limits and responses must be changed at the central station.	Change the alarm limits and responses from the central station.

* *Messages are shown in all bold text.*

9.6.4 System Alarms (Alarm Responses) Tab

The **System Alarms** (System Alarm Responses) tab (shown in FIGURE 9-19 and FIGURE 9-20) controls the system default settings for alarm responses at the Panorama Central Station and the WorkStation. This tab is not available at the ViewStation or the WorkStation. Alarm response settings are transferred from the host central to the ViewStation and the WorkStation when the patient tile is assigned.

9.6.4.1 Accessing the System Alarms (System Alarm Responses) Tab

The **System Alarms** (System Alarm Responses) tab (shown in FIGURE 9-20) controls the system default settings for alarm responses.

1. From the menu bar, select the **System Setup** button. The **Password** tab is displayed.
2. Follow the directions in the "Entering a Password" section on page 9-7.
3. Once the correct password has been entered, the tabs associated with the **System Setup** button are displayed.
4. Select the **System Alarms** tab. The **System Alarms** (System Alarm Options) tab is displayed.
5. Select the **System Alarm Responses** sidebar button. The **System Alarms** (System Alarm Responses) tab is displayed.

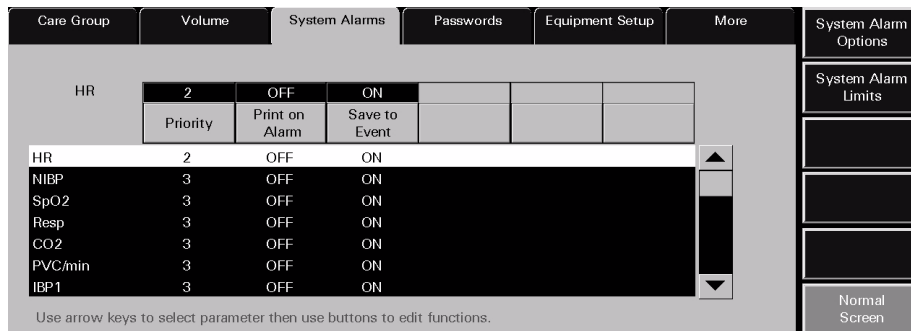

FIGURE 9-19 System Alarms (System Alarm Responses) Tab (Central Station)

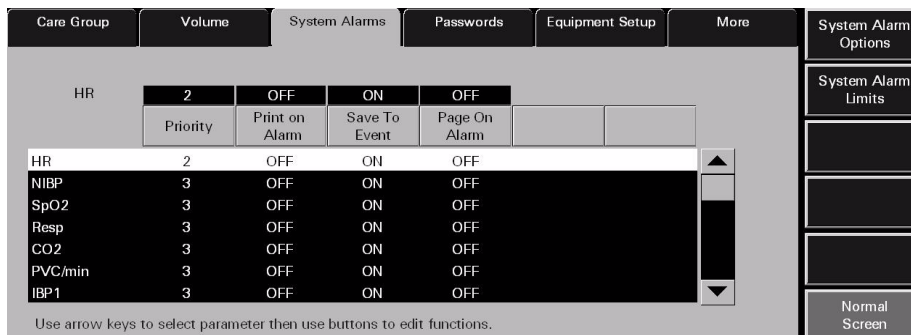

FIGURE 9-20 System Alarms (System Alarm Responses) Tab - Paging Option Enabled (Central Station)

9.6.4.2 Setting the System Alarms Responses

This section outlines setting system defaults for alarm responses.

1. Select a parameter in the **System Alarm Limits** (System Alarm Responses) tab to make adjustments.
 - The alarm responses list box shows a list of the available alarm conditions.
 - When an alarm is selected, it will be highlighted in white with black text and will be displayed on the left side of the Priority button.
2. Select the alarm **Priority** button to select the alarm priority for the selected alarm. The Alarm Priority setting determines the audio and visual indicators the central station will elicit when an alarm condition occurs. Alarm Priority is based on the severity of the alarm condition. Every alarm condition will have predetermined alarm priority choices. The Alarm Priorities available include Off, 1, 2, and 3, depending on the alarm.
 - Priority 1 alarms are the most severe alarms (lethal alarms). Priority 1 alarms are shown in red.
 - Priority 2 alarms include alarms of medium severity (most physiological numeric alarms). Priority 2 alarms are shown in yellow.
 - Priority 3 alarms are the least severe alarms (technical alarms). Priority 3 alarms are shown in yellow.
 - When Alarm Priorities are turned **OFF** there will be no audio feedback for alarms at the Panorama Central Station.
3. Select the **Print on Alarm** button to determine if the data for the alarm should be printed when the alarm occurs.
 - Select the **ON** option to automatically print the alarmed event when the alarm condition occurs.
 - Select the **OFF** option to suspend printing the alarmed event when the alarm condition occurs.
4. Select the **Save To Event** button to determine if the alarm data is saved in the Event database when the alarm condition occurs.
 - Select the **ON** option to automatically save the alarm event when the alarm condition occurs.
 - Select the **OFF** option and the alarm event will not be saved to the Events database when the alarm condition occurs.
5. Select the **Page On Alarm** button to determine if a page should be sent when the alarm condition occurs.
 - Select the **ON** option to automatically send a page when the alarm condition occurs.
 - Select the **OFF** option and a page will not be sent when the alarm condition occurs.

9.6.4.3 Sidebar Buttons

The following sidebar buttons are used to expand the functionality of this tab.

System Alarm Options

Select the **System Alarm Options** sidebar button to display the **System Alarm Options** tab. For additional information regarding System Alarm Options, refer to the "System Alarms Tab" on page 9-14.

System Alarm Limits

Select the **System Alarm Limits** sidebar button to display the **System Alarm Limits** tab. For additional information regarding System Alarm Limits, refer to the “System Alarms Tab” on page 9-14.

Normal Screen

Select the **Normal Screen** sidebar button to return the display to the full screen mode, and close all tabs, message boxes, and dialog boxes.

9.6.4.4

Troubleshooting

This section lists some of the potential messages and issues that may occur while using the System **Alarm Responses** tab.

MESSAGE/ISSUE *	REASON	SOLUTION
The System Setup menu button is disabled.	The System Setup function is already open on another Panorama display and cannot be opened on multiple displays.	Close the System Setup function on the Panorama display where it is open.
The Page On Alarm button is not displayed.	The central station where the patient tile resides does not have the Paging option enabled.	If necessary, enable the Paging option.
The System Alarm Limits and System Alarm Responses tab is not available at the ViewStation or WorkStation.	System alarm limits and responses must be changed at the central station.	Change the alarm limits and responses from the central station.

* Messages are shown in all bold text.

9.7 Passwords Tab

The system **Passwords** tab (shown in FIGURE 9-21 through FIGURE 9-24) establishes and modifies the passwords used to access the **System Setup** and **Patient Alarm Setup** areas of the Panorama Central Station. This tab is available at the ViewStation and the WorkStation, and it functions in the same manner as it does at the host central station but does not contain an **Alarm** button. Passwords tab changes made at the central station or remote workstations are independent of each other.

9.7.1 Accessing the Installation Setup Tab

1. From the menu bar, select the **System Setup** button. The **Password** tab is displayed.
2. Follow the directions in the "Entering a Password" section on page 9-7.
3. Once the correct password has been entered, the tabs associated with the **System Setup** button are displayed.
4. Select the **Passwords** tab. The **Passwords** tab is displayed.

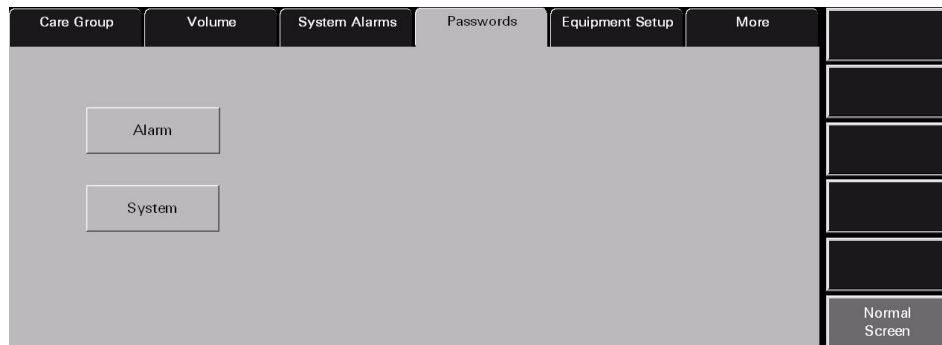

FIGURE 9-21 Passwords Tab - Paging Option Disabled (Central Station)

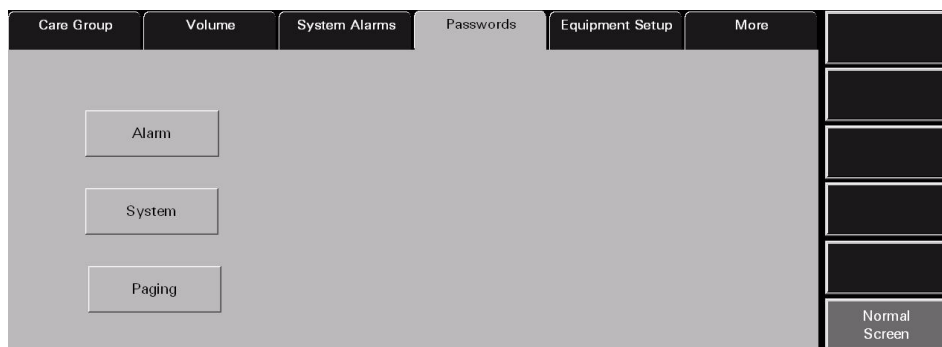

FIGURE 9-22 Passwords Tab - Paging Option Enabled (Central Station)

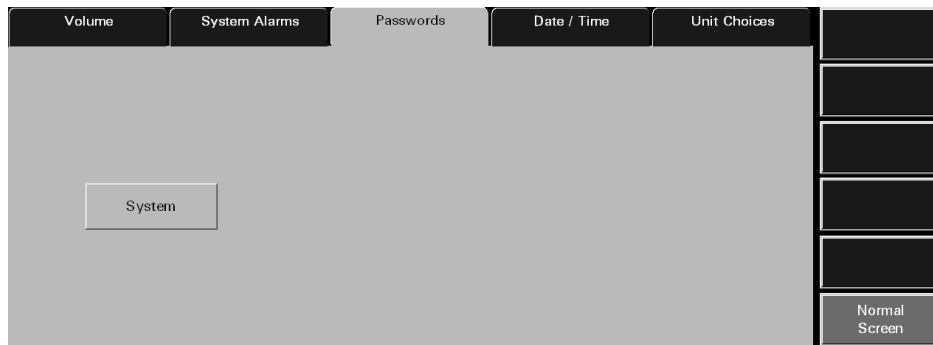

FIGURE 9-23 Passwords Tab (ViewStation)

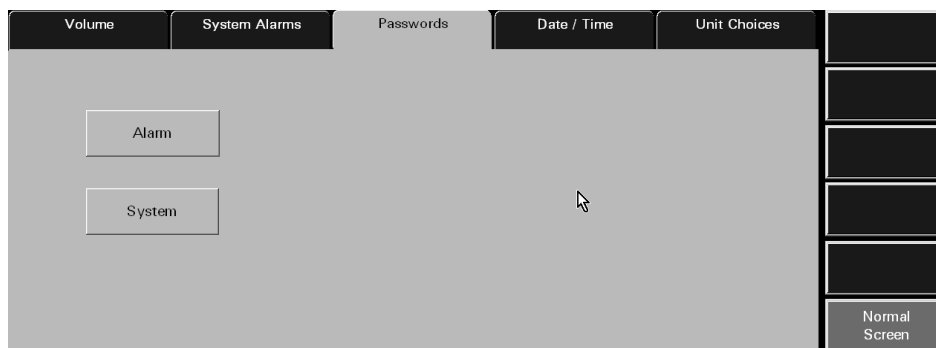

FIGURE 9-24 Passwords Tab (WorkStation)

9.7.2 Modifying a Default Password

The **Passwords** tab changes the password that provides access to the Patient Alarms and System Alarms tab.

1. Select either the **Alarm**, **System**, or **Paging** (displayed if Paging option is enabled) button. The **Old Password** text box is displayed.

NOTE: The **Alarm** button is not available at the ViewStation.

2. Select the **Old Password** text box. The keyboard dialog box is displayed.
3. Using the keyboard dialog box, enter the alarm password that was previously established in "Recording Password Changes" on page 9-31. The Alarm and System password is case sensitive and can be a maximum of 15 characters.
4. Accept or reject the text entered in the keyboard dialog box. For additional information about using the keyboard dialog box, refer to "Keyboard Dialog Box" on page 2-18.

NOTE: The factory default Alarm password is 'alarm'. The factory default System password is 'system'. The factory default Paging password is 'paging'.

NOTE: Passwords are case sensitive.

5. Select the **New Password** text box. The keyboard dialog box is displayed.
6. Using the keyboard dialog box, enter the new alarm password. The Alarm password is case sensitive and can be a maximum of 15 characters.
7. Accept the text entered in the keyboard dialog box. For additional information about using the keyboard dialog box, refer to "Keyboard Dialog Box" on page 2-18.
8. Select the **Confirm** text box. The keyboard dialog box is displayed.
9. Using the keyboard dialog box, re-enter the new alarm password. Accept or reject the text entered in the keyboard dialog box. For additional information about using the keyboard dialog box, refer to "Keyboard Dialog Box" on page 2-18.

The password is changed and the **Passwords** tab is returned to its original state.

Recording Password Changes

CAUTION: If passwords are changed from the factory defaults, users **MUST ensure that they document new passwords in the space provided in this manual. For additional information refer to "Passwords Tab" on page 9-29. Failure to recall user defined passwords will render the system UNUSABLE.**

NOTE: Restrict access among hospital staff to the **System password.**

Record password changes in the following table:

PROVIDES ACCESS TO	DEFAULT PASSWORD	USER DEFINED PASSWORD
Patient Alarms	alarm	
System Menus	system	
Paging Tab (optional)	paging	

9.7.3 Sidebar Button - Normal Screen

Select the **Normal Screen** sidebar button to return the display to the full screen mode, and close all tabs, message boxes, and dialog boxes.

9.7.4 Troubleshooting

This section lists some of the potential messages and issues that may occur while using the **Passwords** tab.

MESSAGE/ISSUE *	REASON	SOLUTION
Incorrect password. Please try again.	The wrong password was entered in the text box.	Select the OK button to close the dialog box. Enter the correct password in the dialog box.
	The password was entered in the wrong case.	Re-enter the password turning on/off the keyboard dialog Caps Lock key.
Illegal Password. Please choose a new password.	An illegal character (anything other than A-Z and/or 0-9) was entered in the keyboard dialog box.	Try re-entering a password that contains only the letters A-Z and/or numbers 0-9.

* Messages are shown in all bold text.

MESSAGE/ISSUE *	REASON	SOLUTION
Illegal Password. Password should be 1 to 15 characters.	When entering a New Password in the keyboard dialog, the Enter key was selected in the keyboard dialog before any characters/ numbers were selected.	Enter a password that contains at least 1 character before selecting the Enter key.
The System Setup menu button is disabled.	The System Setup function is already open on another central station display and cannot be opened on multiple displays.	Close the System Setup function on the Panorama display where it is open.
The Alarm button is not displayed in the Passwords tab.	System Alarm tab is being viewed from a ViewStation.	If password maintenance is necessary for this function, access the Alarm button from a host central station.
The Paging button is not displayed in the Passwords tab.	The central station where the patient tile resides does not have the Paging option enabled.	If necessary, enable the Paging option.

* *Messages are shown in all bold text.*

9.8 Equipment Setup Tab

The **Equipment Setup** tab (shown in FIGURE 9-25 and FIGURE 9-26) adds, deletes, and modifies the equipment used with the Panorama Central Station. The **Equipment Setup** tab includes an equipment list that shows the types of equipment that may communicate with the central station. This tab is not available at the ViewStation or the WorkStation. Equipment maintenance can only be performed at the host central station.

9.8.1 Accessing the Equipment Setup Tab

1. From the menu bar, select the **System Setup** button. The **Password** tab is displayed.
2. Follow the directions in the "Entering a Password" section on page 9-7.
3. Once the correct password has been entered, the tabs associated with the **System Setup** button are displayed.
4. Select the **Equipment Setup** tab. The **Equipment Setup** tab is displayed.

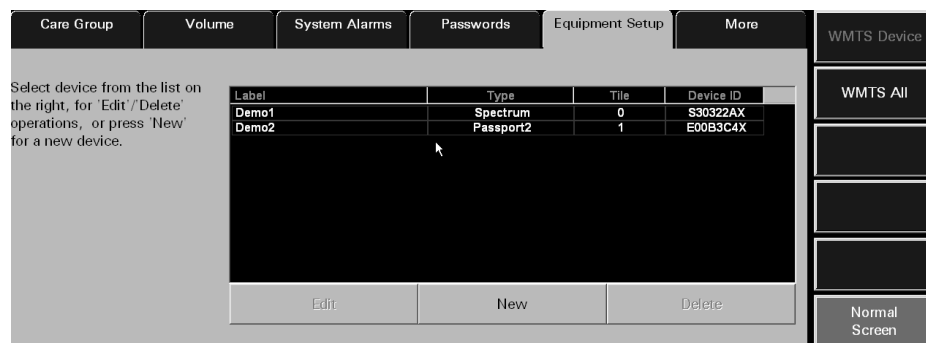

FIGURE 9-25 Equipment Setup Tab

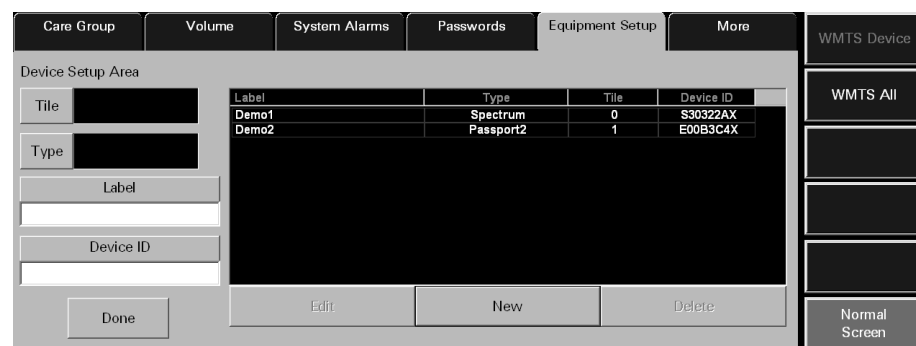

FIGURE 9-26 Equipment Setup Tab (with Device Setup Area shown)

- The first column of the equipment list box displays the device **Label** for the equipment listed.
- The second column of the equipment list box displays the **Type** of device listed.
- The third column of the equipment list box displays the **Tile** number associated with the equipment.
- The fourth column of the equipment list box displays the **Device ID** number for the equipment listed.

Device ID Format

DEVICE	STARTING CHARACTER	# OF CHARACTERS	ENDING CHARACTER
Telepack WMTS	M or m	6	X or x
Passport 2	E or e	6	X or x
Passport 2 WMTS	U or u	6	X or x
Passport V	N or n	6	X or x
Spectrum	S or s	6	X or x
Spectrum WMTS	B or b	6	X or x
Spectrum OR	D or d	6	X or x
DPM6/7	H or h	6	X or x
V Series	A or a	6	X or x

9.8.2 Entering New Equipment

This section outlines adding new equipment to the Panorama Central Station equipment list.

1. Select the **New** button below the equipment list box. The Device Setup Area (shown in FIGURE 9-26) is displayed.
2. Select the **Tile** button. In the **Tile Number** dialog box, select the tile number for the new monitoring device.
 - The tile numbers available for a single 8 tile display include **NONE** (when no tile number is assigned to the equipment) and 0 to 7.
 - The tile numbers available for a single 12 tile display include **NONE** (when no tile number is assigned to the equipment) and 0 to 11.
 - The tile numbers available for a dual 16 tile display include **NONE** (when no tile number is assigned to the equipment) and 0 to 15.

Select the **Done** button to accept the selection.

Select the **Cancel** button to discard the selection.

The tile number is displayed in the **Tile** field.

NOTE: The **Tile** button will be disabled and display a dash (-) if the type of equipment being entered is a Panorama Server or a Panorama Central Station.

3. Select the **Type** button. In the **Device Type** dialog box, select the device type of the new monitoring device.

The equipment list supports the following types of equipment: Telepack, Telepack WMTS, Passport 2, Passport 2 WMTS, Passport V, Spectrum, Spectrum WMTS, Spectrum OR, DPM6/7, and V Series.

Select the **Done** button to accept the selection or the **Cancel** button to discard the selection.

The device type is displayed in the **Type** field.

4. Select the **Label** text box to enter a label for the new equipment.
5. Use the keyboard dialog box to enter the device label for the new equipment. A device label must be entered in the equipment list and can only use alphanumeric characters and underscores (_). There is a maximum of 15 characters.
6. Accept or reject the text entered in the keyboard dialog box. For additional information about using the keyboard dialog box, refer to "Keyboard Dialog Box" on page 2-18.

NOTE: All Device Labels in the Equipment List must be unique and cannot be duplicated.

7. Select the **Device ID** text box.
8. Use the keyboard dialog box to enter the device identification number for the new equipment. A Device ID must be entered in the equipment list for Passport, Telepack, Spectrum, DPM6/7, V Series, and Panorama Telemetry Server devices (maximum of 8 characters). For additional information about Device ID formats, refer to "Device ID Format" on page 9-34.

NOTE: All Device IDs in the equipment list must be unique and cannot be duplicated.

NOTE: The Device ID field will display a dash (-) and be disabled if the type of equipment being entered is a Panorama Central Station.

9. Accept or reject the text entered in the keyboard dialog box. For additional information about using the keyboard dialog box, refer to "Keyboard Dialog Box" on page 2-18.
10. Select the **Done** button. The equipment is added to the equipment list.

9.8.3 Modifying Equipment Included in the Equipment List

This section outlines modifying equipment added to the Panorama Central Station Equipment List.

1. From the equipment list box, select the monitoring device to be modified. A monitoring device has been selected when it changes from white text on a black background to black text on a white background.
2. Select the **Edit** button under the Equipment list box. The Device Setup Area is displayed.
3. Select the area in the Device Setup to be modified. For additional information about modifying the Device Setup area, refer to "Entering New Equipment" on page 9-34.

NOTE: The Label text field is the only field that can be modified for a monitoring device currently monitoring a patient.

4. Select the **Done** button. The equipment is added to the Equipment List.

9.8.4 Deleting Equipment in the Equipment List

This section outlines deleting equipment from the Panorama Central Station Equipment List.

1. From the equipment list box, select the monitoring device to be modified. A monitoring device has been selected when it changes from white text on a black background to black text on a white background.
2. Select the **Delete** button below the equipment list box.

NOTE: **Only equipment not actively monitoring a patient can be deleted.**

3. The message **Are you sure you want to delete this device?** message box is displayed.
 - Select the **Yes** button to delete the selected device and close the dialog box.
 - Select the **No** button to keep the selected device and close the dialog box.

NOTE: **If an associated patient tile has been assigned at the ViewStation or the WorkStation, or both, the connection between the patient tiles will continue to exist, even if the equipment is deleted at the host central station.**

9.8.5 Sidebar Buttons

The following sidebar buttons are used to expand the functionality of this tab.

WMTS Device

This sidebar button should not be used without assistance from a Service Representative.

WMTS All

This sidebar button should not be used without assistance from a Service Representative.

Normal Screen

Select the **Normal Screen** sidebar button to return the display to the full screen mode, and close all tabs, message boxes, and dialog boxes.

9.8.6 Troubleshooting

This section lists some of the potential messages and issues that may occur while using the **Equipment** tab.

MESSAGE/ISSUE *	REASON	SOLUTION
Equipment list is full	This message appears when the New button is pressed and the equipment list contains the maximum number of equipment list entries.	Select the OK button to close the dialog box. Delete a device from the equipment list.
Illegal Device Tile. Device Tile must be defined. Please try again.	This message appears when the Done button is pressed in the Equipment Setup tab before a tile number is selected.	Select the OK button to close the dialog box. Select a tile number in the Tile Number dialog box.

* Messages are shown in all bold text.

MESSAGE/ISSUE *	REASON	SOLUTION
The Tile button is disabled and a dash (-) is shown in the Tile field.	The type of equipment being entered in the equipment list is either a Panorama Server or a Panorama	A file number cannot be entered for the Panorama Server or the Panorama equipment types.
Invalid Device Type	This message appears when the Done button is pressed in the Equipment Setup tab before a device type is selected.	Select the OK button to close the dialog box. Select a device type in the Device Type dialog box.
Illegal Device Label. Device Label must be defined. Please try again.	This message appears when the Done button is pressed in the Equipment Setup tab before a device label is selected.	Select the OK button to close the dialog box. Select a device label in the Device Label dialog box.
Device Label already exists! Please enter a new one	This message appears when a duplicate device label is entered in the Device Label field.	Select the OK button to close the dialog box. Enter a new device label in the Device Label field.
Invalid characters entered. Please enter a new label.	This message appears when invalid characters have been entered in the Device Label. The device label can only contain alphanumeric characters and underscores (_).	Select the OK button to close the dialog box. Enter a valid Device label.
Illegal Device ID. Please enter a new one.	This message appears when the Done button is pressed in the Equipment Setup tab before a device ID is selected.	Select the OK button to close the dialog box. Enter a Device ID in the Device ID dialog box.
Device ID must be 8 characters in length.	This message appears when the Device ID that was entered is less than 8 characters in length. Please refer to the Device ID setup rules in the Setting up New Equipment section.	Select the OK button to close the dialog box. Enter a Device ID in the Device ID dialog box.
Device ID must start with the proper device prefix	This message appears when the incorrect device prefix is entered in the Device ID box.	Select the OK button to close the dialog box. Enter the correct Device ID prefix.
Suffix of Device ID last character must be 'x' or 'X'.	This message appears when the incorrect device suffix is entered in the Device ID box.	Select the OK button to close the dialog box. Enter the correct Device ID suffix.
This Device ID already exists!	This message appears when a duplicate Device ID is entered in the Device ID field.	Select the OK button to close the dialog box. Enter a new Device ID in the Device ID field.
You have reached the maximum number of channel licenses available.	This message appears when all available channels on the Panorama Central Station are occupied.	Select the OK button to close the dialog box. Delete a piece of equipment from an existing channel if it is no longer in use. The system administrator can also purchase additional channel licenses.

* Messages are shown in all bold text.

MESSAGE/ISSUE *	REASON	SOLUTION
This version of software does not support more than 16 monitored patients.	This message appears when the maximum number of patients is being monitored on the Panorama Central Station.	Select the OK button to close the dialog box. Discharge a patient if the patient is no longer being monitored.
System Setup menu button is disabled.	The System Setup function is already open on another Panorama display and cannot be opened on multiple displays.	Close the System Setup function on the Panorama display where it is open.
Cannot delete a device connected to a patient	The device cannot be deleted because it is currently connected to a patient.	Select the OK button to close the dialog box. Disconnect the patient from the selected device before attempting to delete it.
The Tile button, Type button and Device ID field are disabled.	The selected equipment cannot be edited because it is currently monitoring a patient.	This equipment cannot be edited until a patient discharge is performed.
Unable to perform operation on tile: Central to Central Transfer In in progress.	Equipment Setup tab Delete button was selected for equipment that was not actively monitoring a patient, while a Central to Central Transfer In is in progress to that same device.	Wait for the Central to Central Transfer to complete, then try again.

* *Messages are shown in all bold text.*

9.9 More Tab

The **More** tab (shown in FIGURE 9-27) is used for navigational purposes and when selected, will display another set of **System Setup** tabs at the Panorama Central Station. This tab is not available at the ViewStation or the WorkStation.

9.9.1 Accessing Additional (More) Tabs

1. From the menu bar, select the **System Setup** button. The **Password** tab is displayed.
2. Follow the directions in the "Entering a Password" section on page 9-7.
3. Once the correct password has been entered, the tabs associated with the **System Setup** button are displayed.
4. Select the **More** tab. The next set of System Setup tabs is displayed.

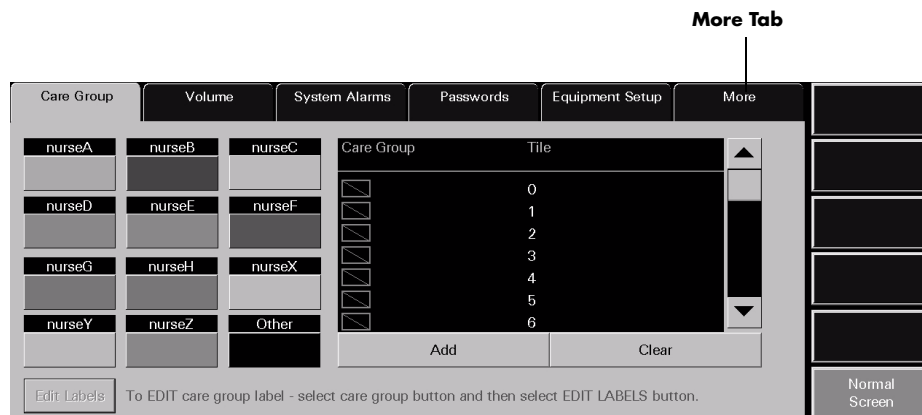

FIGURE 9-27 More Tab

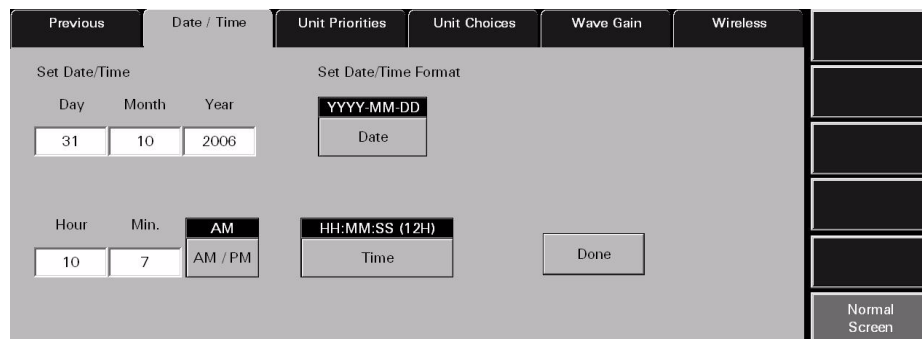

FIGURE 9-28 Tabs available when More tab is selected

9.10 Previous Tab

The **Previous** tab (shown in FIGURE 9-29) is used for navigational purposes and when selected, will display another set of system setup tabs at the Panorama Central Station. This tab is not available at the ViewStation or the WorkStation.

9.10.1 Accessing Previous Tabs

1. From the menu bar, select the **System Setup** button. The first set of **System Setup** tabs is displayed.
2. Select the **Installation Setup** tab. The **Installation Setup** tab is displayed.
3. Enter the correct system password.
4. Select the **More** tab. The next set of System Setup tabs is displayed.
5. Select the **Previous** tab to display the first set of tabs (shown in FIGURE 9-30) associated with the **System Setup** tab.

Previous Tab

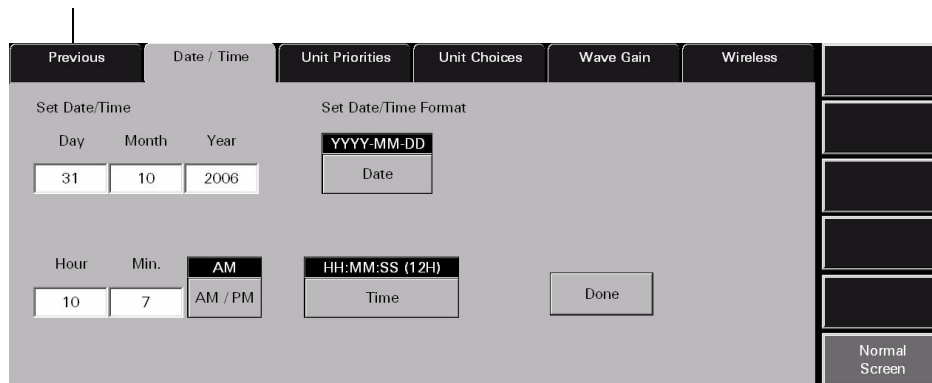

FIGURE 9-29 Previous Tab

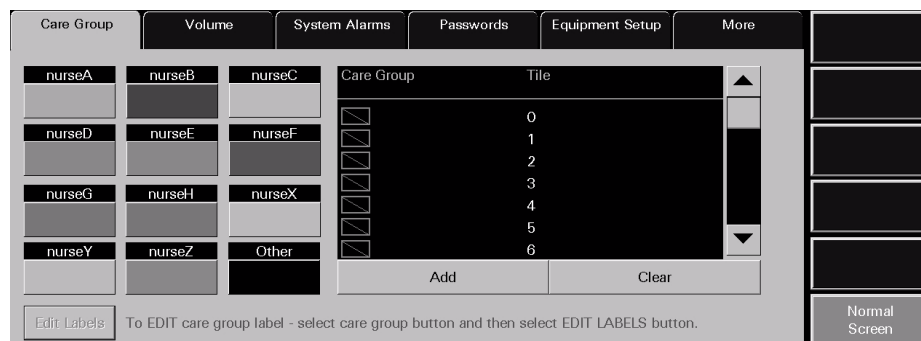

FIGURE 9-30 Tabs available when Previous tab is selected

9.11 Date/Time Tab

The **Date/Time** tab (shown in FIGURE 9-31) sets the system date and time and configures the default date and time formats at the Panorama Central Station. This tab is available at the ViewStation and the WorkStation, and it functions in the same manner as it does at the host central station. Date/Time tab changes made at the central station or remote workstations are independent of each other.

NOTE: The host central station, ViewStation, and WorkStation system times are independent of each other.

9.11.1 Accessing the Date/Time Tab

1. From the menu bar, select the **System Setup** button. The **Password** tab is displayed.
2. Follow the directions in the "Entering a Password" section on page 9-7.
3. Once the correct password has been entered, the tabs associated with the **System Setup** button are displayed.
4. Select the **More** tab. The next set of System Setup tabs is displayed.
5. Select the **Date/Time** tab. The **Date/Time** tab is displayed.

FIGURE 9-31 Date/Time Tab (Central Station)

FIGURE 9-32 Date/Time Tab (WorkStation)

FIGURE 9-33 Date/Time Tab (ViewStation)

9.11.2 Set Date/Time

The settings configured in the **Date/Time** tab are the settings that will be used for all date/time related functions in the Panorama Central Station.

NOTE: **When generating the Full Disclosure Report, Event List Report, etc., the Data Time indicated below the report title is based on the system time the data was collected at the host central station, not the system time displayed at the ViewStation or the WorkStation.**

Setting a Date in the Date/Time Tab

1. From the **Date/Time** tab, select the **Day** field. The keypad dialog box is displayed. The range available is shown on the bottom of the dialog box.
2. Using the keypad dialog box, enter the number that represents the current day of the month.
 - Select the **Clear** button to delete all of the numbers in the text box
 - Select **CE** button to delete a single number from the text box
 - Select **Cancel** button to discard changes and close the dialog box
 - Select **OK** button to accept changes. The Day field will remain unchanged until the **OK** button is pressed.
3. Select the **Month** field. The keypad dialog box is displayed. The range available is 1 to 12.
4. Using the keypad dialog box, enter the number that represents the current month.
 - Select the **Clear** button to delete all of the numbers in the text box
 - Select **CE** button to delete a single number from the text box
 - Select **Cancel** button to discard changes and close the dialog box
 - Select **OK** button to accept changes. The Month field will remain unchanged until the **OK** button is pressed.
5. Select the **Year** field. The keypad dialog box is displayed. The range available is 1970 to 2037.
6. Using the keyboard dialog box, enter the number that represents the current year.
 - Select the **Clear** button to delete all of the numbers in the text box
 - Select **CE** button to delete a single number from the text box

- Select **Cancel** button to discard changes and close the dialog box
 - Select **OK** button to accept changes. The Month field will remain unchanged until the **OK** button is pressed.
7. Select the **Date** button to select the desired date format.
The date formats available include DD-MM-YYYY, MM-DD-YYYY and YYYY-MM-DD (default).
8. Select the **Done** button to change the system date format.
The **Are you sure you want to change the date/time settings?** confirmation box is displayed.
9. Select the **Yes** or **No** button in the dialog box.
- Select the **Yes** button to change the system date format
 - Select the **No** button to discard the changes that were made to the system date format

Setting a Time in the Date/Time Tab

1. From the **Date/Time** tab, select the **Hour** field. The keypad dialog box is displayed. The range available is 1 to 12.
2. Using the keypad dialog box, enter the number for the current hour.
- Select the **Clear** button to delete all of the numbers in the text box
 - Select **CE** button to delete a single number from the text box
 - Select **Cancel** button to discard changes and close the dialog box
 - Select **OK** button to accept changes. The Hour field will remain unchanged until the **OK** button is pressed.
3. Select the **Min.** field. The keypad dialog box is displayed. The range available is 0 to 59.
4. Using the keypad dialog box, enter the number that represents the current minute.
- Select the **Clear** button to delete all of the numbers in the text box
 - Select **CE** button to delete a single number from the text box
 - Select **Cancel** button to discard changes and close the dialog box
 - Select **OK** button to accept changes. The Min. field will remain unchanged until the **OK** button is pressed.
5. Select the AM/PM toggle button to select either AM or PM.

NOTE: **The AM/PM button is only available if the current time format is in 12 hour mode.**

6. Select the **Time** button to select the desired time format.
The time formats available include HH:MM (12H), HH:MM:SS (12H) (default), HH:MM (24H) and HH:MM:SS (24H).

NOTE: **Whenever the central station is set to a language other than English, it will be in the 24-hour time format.**

7. Select the **Done** button to change the system time format.
The **Are you sure you want to change the date/time settings?** confirmation box is displayed.

8. Select the **Yes** or **No** button in the dialog box.
 - Select the **Yes** button to change the system time format
 - Select the **No** button to discard the changes that were made to the system time format

9.11.3 Sidebar Button - Normal Screen

Select the **Normal Screen** sidebar button to return the display to the full screen mode, and close all tabs, message boxes, and dialog boxes.

9.11.4 Troubleshooting

This section lists some of the potential messages and issues that may occur while using the **Date/Time** tab.

MESSAGE/ISSUE *	REASON	SOLUTION
The System Setup menu button is disabled.	The System Setup function is already open on another Panorama display and cannot be opened on multiple displays.	Close the System Setup function on the Panorama display where it is opened.

* *Messages are shown in all bold text.*

9.12 Print Setup Tab (System)

The **Print Setup** tab (shown in FIGURE 9-34 and FIGURE 9-35) defines the printer(s) that will be used to print standard (defined as reports that do not contain waveforms) and strip reports (such as the All Strips, Event Zoom-In, and Full Disclosure Zoom-In Reports). This tab is available at the ViewStation and WorkStation, and it functions in the same manner as the host central station. The central station and each remote workstation is capable of communicating with two network printers simultaneously.

Print Setup tab changes made at the central station or remote workstations are independent of each other.

NOTE: **The network printer(s) must be properly configured to communicate with the central station.**

For information regarding individual patient print setup configuration, refer to "Print Setup Tab (Patient)" on page 5-57.

For information regarding printer configuration, refer to the Panorama Printer Configuration Guide (P/N 0070-00-0561).

9.12.1 Accessing the Print Setup Tab (Central Station)

1. From the menu bar, select the **System Setup** button.
2. Select the **Print Setup** tab. The **Print Setup** tab is displayed.

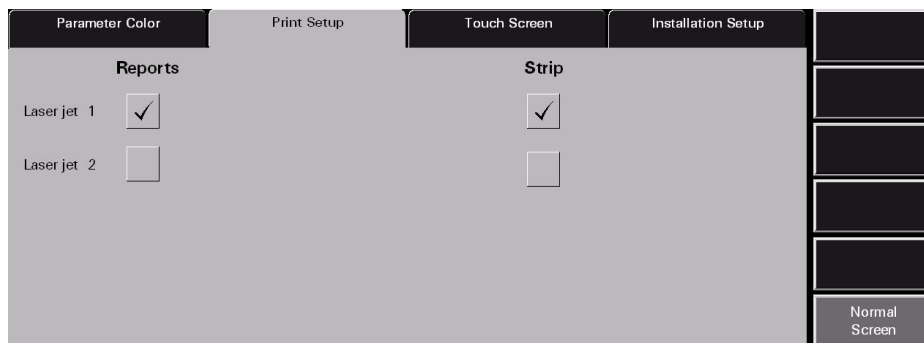

FIGURE 9-34 System Print Setup Tab (Central Station)

9.12.2 Accessing the Print Setup Tab (ViewStation and WorkStation)

- Follow steps from the "Accessing the Print Setup Tab (Central Station)" section on page 9-45.

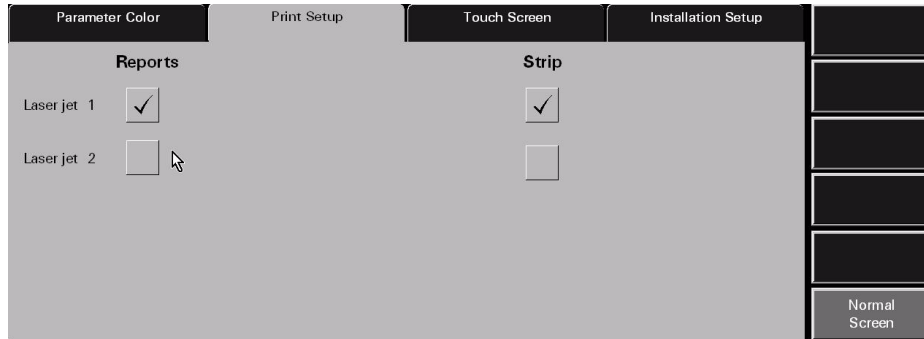

FIGURE 9-35 System Print Setup Tab (ViewStation and WorkStation)

9.12.3 Setting the System Default Print Setup

This section outlines using the **Print Setup** tab to establish to which default printer print requests will be directed. To set system default print requests:

1. Select a printer's check box button to enable/disable the printing of reports to the selected printer. The options available include Laser jet 1 and Laser jet 2. Print setup settings are changed instantly.
 - A check mark in a printer's check box indicates that if the printer was properly configured with the Panorama Central Station, it will be capable of printing Panorama reports.
 - An empty check box button indicates the printer is not selected and will not print Panorama reports.
2. Select the printer's check box button to enable/disable the printing of strips. The print setup settings are changed instantly.
 - A check mark in a printer's check box button indicates that if the printer was properly configured with the Panorama Central Station, it will be capable of printing waveform strips.
 - An empty check box indicates the printer is not selected and will not print waveform strips.

9.12.4 Troubleshooting

This section lists some of the potential messages and issues that may occur while using the System **Print Setup** tab.

MESSAGE/ISSUE *	REASON	SOLUTION
The System Setup menu button is disabled.	The System Setup function is already open on another Panorama display and cannot be opened on multiple displays.	Close the System Setup function on the Panorama display where it is open.

* Messages are shown in all bold text.

9.13 Unit Priorities Tab

The **Unit Priorities** tab (shown in FIGURE 9-36) determines the initial order in which parameters in the Main Screen, **Bedside** tab, **Trends** tab, and **Events** (List) are displayed. This tab is not available at the ViewStation or the WorkStation. Unit priority settings are transferred from the host central station to the ViewStation and the WorkStation when the patient tile is assigned.

9.13.1 Accessing the Unit Priorities Tab

1. From the menu bar, select the **System Setup** button. The first set of System Setup tabs is displayed.
2. Follow the directions in the "Entering a Password" section on page 9-7.
3. Once the correct password has been entered, the tabs associated with the **System Setup** button are displayed.
4. Select the **More** tab. The next set of System Setup tabs is displayed.
5. Select the **Unit Priorities** tab. The **Unit Priorities** tab is displayed.

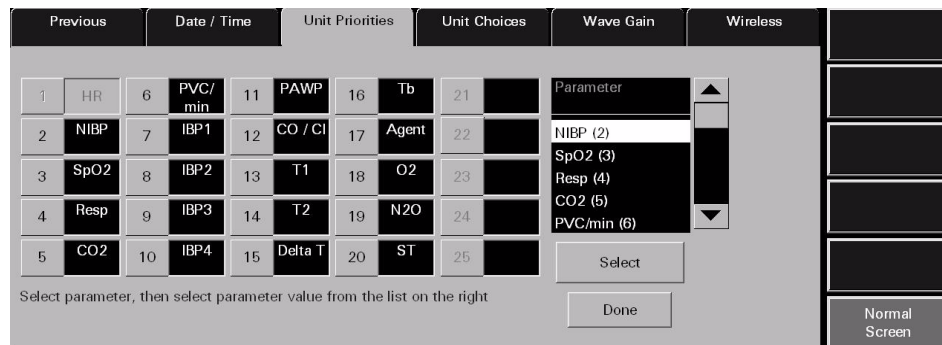

FIGURE 9-36 Unit Priorities Tab

9.13.2 Setting a Default Order in the Unit Priorities Tab

This section outlines how to select the parameter order in the **Unit Priorities** tab.

Selecting the Unit Priority Order

1. Select a **Unit Priority** number button.
The parameter with the number 1 priority will always be Heart Rate.
2. Select a parameter tile from the Parameter list.
A parameter has been selected when it changes from white text with a black background to black text with a white background.

NOTE: Parameters show their current unit priority position in parentheses next to their name in the Parameter list.

3. Choose the **Select** button. The selected parameter is assigned its new unit priority position and will be shown in the box on the right of the selected unit priority.
4. Repeat steps 2-3 until the parameters are in the desired order.
5. Select the **Done** button. All priority changes in the **Unit Priorities** tab have now been confirmed. The changes that were made will only be applied to newly admitted patients and will not affect patients currently being monitored.

9.13.2.1 Setting the Waveform System Defaults

Select the Wave Defaults sidebar button to select the system default patient tile waveforms.

1. Select the **Wave Defaults** sidebar button in the **Unit Priorities** tab. The **Wave Defaults** dialog box (shown in FIGURE 9-37) is displayed.

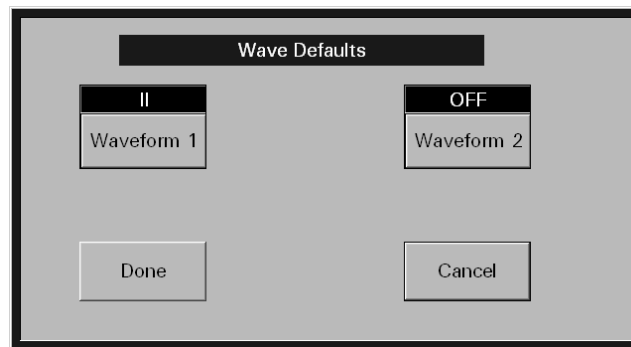

FIGURE 9-37 Wave Defaults Dialog Box

1. Select the **Waveform 1** button until the desired ECG waveform is displayed.
The settings available for the ECG waveform include ECG I through V6. The factory default setting is ECG II.
2. Select the **Waveform 2** button until the desired ECG waveform is displayed.
The settings available for the ECG waveform include ECG I through V6, IBP1-IBP4, Resp, Pleth, CO2, O2, Agent, and OFF. The factory default setting is OFF.
3. Accept or reject the selections made in the dialog box.
 - Select the **Done** button to accept the selections.
 - Select the **Cancel** button to discard the selections, close the dialog box and return to the **Unit Priorities** tab.

9.13.3 Sidebar Buttons

The following sidebar buttons are used to expand the functionality of this tab.

Wave Defaults

This sidebar button was previously described on page 9-48.

Normal Screen

Select the **Normal Screen** sidebar button to return the display to the full screen mode, and close all tabs, message boxes, and dialog boxes.

9.13.4 Troubleshooting

This section lists some of the potential messages and issues that may occur **Unit Priorities** tab.

MESSAGE/ISSUE *	REASON	SOLUTION
Please select a parameter button before selecting from the list	This message appears when the Select button is pressed before a Unit Priority button is selected.	Select the OK button to close the dialog box. Select a Unit Priority button.
The System Setup menu button is disabled.	The System Setup function is already open on another Panorama display and cannot be opened on multiple displays.	Close the System Setup function on the Panorama display on where it is open.

* *Messages are shown in all bold text.*

9.14 Unit Choices Tab

The **Unit Choices** tab (shown in FIGURE 9-38, FIGURE 9-39, and FIGURE 9-40) determines the initial units of measure, configures the default pacemaker settings, and selects which patient demographic information is displayed. This tab is available at the ViewStation and WorkStation, and it functions in the same manner as it does at the host central station but contains different buttons. Unit Choices tab changes made at the central station or remote workstations are independent of each other.

9.14.1 Accessing the Unit Choices Tab (Central Station)

1. From the menu bar, select the **System Setup** button. The first set of System Setup tabs is displayed.
2. Follow the directions in the "Entering a Password" section on page 9-7.
3. Once the correct password has been entered, the tabs associated with the **System Setup** button are displayed.
4. Select the **More** tab. The next set of System Setup tabs is displayed.
5. Select the **Unit Choices** tab. The **Unit Choices** tab is displayed.

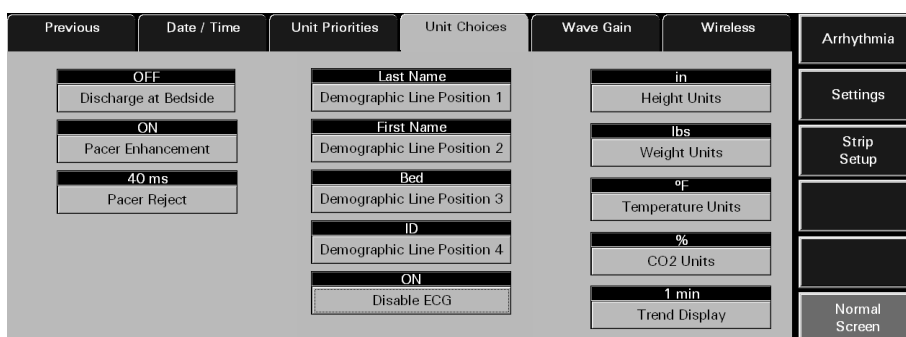

FIGURE 9-38 Unit Choices Tab - Paging Option Disabled (Central Station)

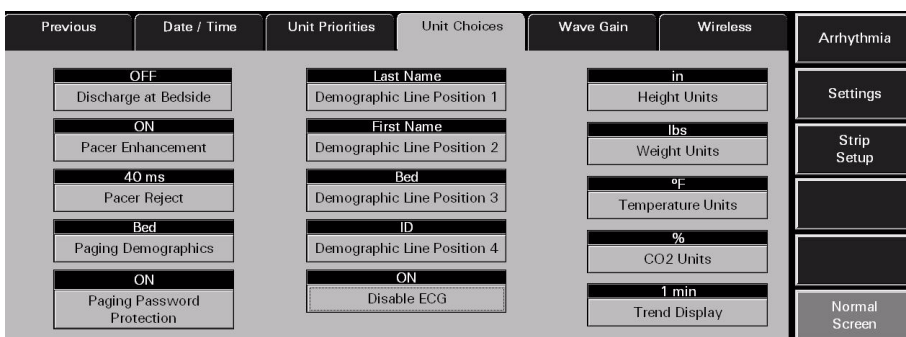

FIGURE 9-39 Unit Choices Tab - Paging Option Enabled (Central Station)

9.14.2 Accessing the Unit Choices Tab (ViewStation and WorkStation)

1. Follow steps 1-4 from the "Accessing the Unit Priorities Tab" section.
2. Select the **Unit Choices** tab. The **Unit Choices** tab is displayed.

Volume	System Alarms	Passwords	Date / Time	Unit Choices
		Last Name		
		Demographic Line Position 1		
		First Name		
		Demographic Line Position 2		
		Bed		
		Demographic Line Position 3		
		ID		
		Demographic Line Position 4		
				Normal Screen

FIGURE 9-40 Unit Choices Tab (ViewStation and WorkStation)

9.14.2.1 Setting the Unit Choices (Central Station)

This section outlines selecting system defaults for pacemaker settings, order of demographic data and units of measurement.

1. Select the **Discharge at Bedside** button to set the system default for allowing patient discharge from the central station.

Discharge at Bedside options include **ON** and **OFF**. The factory default setting is **OFF**.

- The **ON** option indicates that Discharge at Bedside is enabled.
- The **OFF** option indicates that Discharge at Bedside is disabled.

NOTE: The **Discharge at Bedside** button only affects bedside monitors. This button setting has no affect when a Telepack device is in use.

NOTE: Changing the **Discharge at Bedside** option will take affect the next time the **Discharge** tab is entered.

2. Select the **Pacer Enhancement** button to set the system default setting for Pacer Enhancement. Pacer enhancement will visually mark pacemaker-induced ECG complexes with a colored vertical spike.

The Pacer Enhancement settings for a specific patient can be changed in the Pacer Settings dialog box in the **Demographics** tab. Pacer Enhancement options include **ON** and **OFF**. The factory default setting is **ON**.

- The **ON** option indicates that Pacer Enhancement is enabled.
- The **OFF** option indicates that Pacer Enhancement is disabled.

NOTE: Changing the **Pacer Enhancement** option will affect all newly admitted patients and will have no affect on patients currently being monitored.

NOTE: The **Pacer Enhancement** option is not available at the **ViewStation** or the **WorkStation**.

3. Select the **Pacer Reject** button to select the system default pacer reject period. Pacer Reject adjusts the time period at which pacemaker-induced ECG complexes are filtered for ECG sampling processes.

Pacer Reject options include 0 to 80 milliseconds (ms) in 20-second increments. The factory default setting is 40 ms.

NOTE: **Changing the Pacer Reject option will affect all newly admitted patients and will have no effect on patients currently being monitored.**

NOTE: **The Pacer Reject option is not available at the ViewStation or the WorkStation.**

4. Select the **Paging Demographics** button to define which demographic information is sent to the paging system when a page is requested. Paging Demographics options include **Bed**, **Bed + Last Name**, and **Bed + ID**. The factory default setting is **Bed**. Refer to the following tables for formatting examples:

OPTION	ALARM TYPE	FORMAT EXAMPLES
Bed	Heart Rate	central name: XXXBed:ICU10 Low Heart Rate Alarm
Bed	Arrhythmia	central name: XXXBed:ICU10 Asystole
Bed	Not HR or arrhythmia alarm	central name: XXXBed:ICU10 High Temperature 1
Bed	ST alarm	central name: XXXBed:ICU10 ST Single Alarm

OPTION	ALARM TYPE	FORMAT EXAMPLES
Bed + Last Name	Heart Rate	central name: XXXBed:ICU10 Name: Patient Last Name Low Heart Rate Alarm
Bed + Last Name	Arrhythmia	central name: XXXBed:ICU10 Name: Patient Last Name Asystole
Bed + Last Name	Not HR or arrhythmia alarm	central name: XXXBed:ICU10 Name: Patient Last Name High Temperature 1
Bed + Last Name	ST alarm	central name: XXXBed:ICU10 Name: Patient Last Name ST Single Alarm

OPTION	ALARM TYPE	FORMAT EXAMPLES
Bed + ID	Heart Rate	central name: XXXBed:ICU10 ID: Patient ID Low Heart Rate Alarm
Bed + ID	Arrhythmia	central name: XXXBed:ICU10 ID: Patient ID Asystole
Bed + ID	Not HR or arrhythmia alarm	central name: XXXBed:ICU10 ID: Patient ID High Temperature 1
Bed + ID	ST alarm	central name: XXXBed:ICU10 ID: Patient ID ST Single Alarm

NOTE: **The amount of data that is displayed in the pager display window may differ slightly due to the type of pager being used.**

NOTE: **Changing the Paging Demographics option will take effect immediately.**

NOTE: This option will only be displayed if the Paging option is enabled at the central station.

5. Select the **Paging Password Protection** button to enable and/or disable password protection for the **Paging** tab. Paging Protection options include **ON** and **OFF**. The factory default setting is **ON**.
 - The **ON** option indicates that Paging Password Protection is enabled.
 - The **OFF** option indicates that Paging Password Protection is disabled.

NOTE: This option will only be displayed if the Paging option is enabled at the central station.

6. Select the **Demographic Line Position 1** button to select the system default demographic data to be shown in the first demographic line position of the Patient Status line in the Main Screen of the Panorama Central Station.

Demographic Line Position 1 options include Last Name, First Name, Bed, ID, and Demo Off. The factory default setting is Last Name.

NOTE: Changing the Demographic Line Position 1 option will affect all patients with the next update of the Patient Status line in the patient tile.

7. Select the **Demographic Line Position 2** button to select the system default demographic data to be shown in the second demographic line position of the Patient Status line in the Main Screen of the Panorama Central Station.

Demographic Line Position 2 options include First Name, Bed, ID, Demo Off, and Last Name. The factory default setting is First Name.

NOTE: Changing the Demographic Line Position 2 option will affect all patients with the next update of the Patient Status line in the patient tile.

8. Select the **Demographic Line Position 3** button to select the system default demographic data to be shown in the third demographic line position of the Patient Status line in the Main Screen of the Panorama Central Station.

Demographic Line Position 3 options include Bed, ID, Demo Off, Last Name, and First Name. The factory default setting is Bed.

NOTE: Changing the Demographic Line Position 3 option will affect all patients with the next update of the Patient Status line in the patient tile.

9. Select the **Demographic Line Position 4** button to select the system default demographic data to be shown in the fourth demographic line position of the Patient Status line in the Main Screen of the Panorama Central Station.

Demographic Line Position 4 options include ID, Demo Off, Last Name, First Name, and Bed. The factory default setting is ID.

NOTE: Changing the Demographic Line Position 4 option will affect all patients with the next update of the Patient Status line in the patient tile.

10. Select the **Disable ECG** button (available on version 8.7.1 and above) to select the system default for displaying the **Disable ECG** sidebar button on the unit Display Tab. If **ON** is selected, the **Disable ECG** sidebar button is displayed on the unit Display tab if a Telepack with SpO₂ module is connected. If **OFF** is selected, the **Disable ECG** sidebar button is not displayed, and the ECG waveforms will be re-enabled. The factory default setting is **OFF**.

11. Select the **Height Units** button to select the system default unit of measurement to be used for the height variable in the Panorama Central Station. **Height Unit** options include cm (centimeters) and in (inches). The factory default setting is cm.

NOTE: **Changing the Height Units option will affect new Telepack patients upon entering the Demographics tab.**

NOTE: **The Height Units option is not available at the ViewStation or the WorkStation.**

12. Select the **Weight Units** button to select the system default unit of measurement to be used for measuring weight at the Panorama Central Station. Weight Unit options include lbs (pounds) and kg (kilograms). The factory default setting is lbs.

NOTE: **Changing the Weight Units option will affect new Telepack patients upon entering the Demographics tab.**

NOTE: **The Weight Units option is not available at the ViewStation or the WorkStation.**

13. Select the **Temperature Units** button to select the system default temperature unit to be used for measuring temperature at the Panorama Central Station. Temperature unit options include F (Fahrenheit) and C (Celsius). The factory default setting is F.

NOTE: **Changing the Temperature Units option will affect all new patients upon entering the System Alarm Limits tab.**

NOTE: **The Temperature Units option is not available at the ViewStation or the WorkStation.**

14. Select the **CO₂** button to select the system default CO₂ unit to be used for measuring CO₂ at the Panorama Central Station. CO₂ unit options include %, kPa, and mmHg. The factory default setting is %.

NOTE: **Changing the CO₂ Units option will affect all new patients upon entering either the System Alarm Limits or System Wave Gain tabs.**

NOTE: **The CO₂ Units option is not available at the ViewStation or the WorkStation.**

15. Select the **Trend Display** button to configure the interval at which a patient's trend data will be displayed in the **Trends** tab.

Interval periods include 1 minute, 5 minutes, 10 minutes, 15 minutes, 30 minutes, 1 hour, and 2 hours. The factory default setting is 1 minute.

NOTE: **Trend data is automatically stored in one minute intervals. The Trend Display interval selected does not affect how trend information is stored in the database, just how it is displayed.**

NOTE: **The Trend Display option is not available at the ViewStation or the WorkStation.**

9.14.2.2 Setting the Unit Choices (ViewStation and WorkStation)

- Follow steps 6 - 9 from the "Setting the Unit Choices (Central Station)" section on page 9-51.

9.14.2.3 Arrhythmia Setup (Telepack)

Select the **Arrhythmia** sidebar button to:

- Enable or disable arrhythmia analysis for a Telepack device

NOTE: If using a Passport 2, Passport V, Spectrum, Spectrum OR, DPM6/7, or V Series, arrhythmia analysis must be enabled or disabled at the bedside monitor.

- Adjust the default V-Tach Rate, Asystole Delay, V-Tach Thresholds, and ECG Noise Delay for a Telepack device

NOTE: The Arrhythmia sidebar button is not available at the ViewStation or the WorkStation.

NOTE: When using a bedside device, the arrhythmia settings are taken from the bedside monitor upon admission.

1. Select the All Arrhythmia On/Off check box button in the Arrhythmia Menu dialog box (shown in FIGURE 9-41) to enable or disable arrhythmia analysis for a Telepack device.

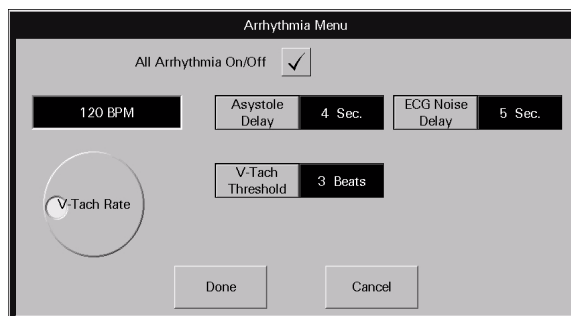

FIGURE 9-41 Arrhythmia Menu Dialog Box (Passport and Spectrum devices only)

- A checkmark in the All Arrhythmia On/Off box indicates that arrhythmia analysis is enabled.
- An empty box indicates that arrhythmia analysis is disabled.

NOTE: Arrhythmia analysis can be enabled for Telepack devices if an Arrhythmia license is available. When arrhythmia analysis is enabled, a license is automatically assigned to a patient.

2. Use the dial control to change the system default V-Tach Rate. The range available is 100-180 bpm, in 5 bpm increments. The factory default setting is 120 bpm.
3. Select the **Asystole Delay** button to change the system default asystole delay time for Arrhythmia processing. The range available is 3-10 seconds. The factory default setting is 4 seconds.
4. Select the **V-Tach Threshold** button to change the system default V-Tach threshold settings. The range available is 3-15 beats. The factory default setting is 3 beats.
5. Select the **ECG Noise Delay** button to change the system default noise delay setting. The range available is 3-30 seconds. The factory default setting is 6 seconds.

NOTE: The **ECG Noise Delay** button settings only affect Telepack monitoring devices.

NOTE: When using a bedside device, these settings are taken from the bedside upon admission.

6. Accept or reject the selections made in the dialog box.
 - Select the **Done** button to accept the selections.
 - Select the **Cancel** button to discard the selections, close the dialog box and return to the **Unit Choices** tab.

9.14.2.4 Settings (Telepack)

Select the **Settings** sidebar button to establish the default ECG monitoring filter that will be used by the Telepack, and to select the ECG leads for ST monitoring.

NOTE: The **Settings** sidebar button is not available at the **ViewStation** or the **WorkStation**.

- The Monitor mode for ECG filtering establishes the frequency response range for non-ST ECG monitoring.
- The ST mode for ECG filtering establishes the frequency response range for ST diagnostic monitoring.

NOTE: The Telepack can only have one type of ECG filtering enabled at any given time (**Monitor mode** or **ST mode**).

To configure the default ECG monitoring filter:

1. Select the **Settings** sidebar button in the **Unit Choices** tab. The **Settings** dialog box (shown in FIGURE 9-42) is displayed.

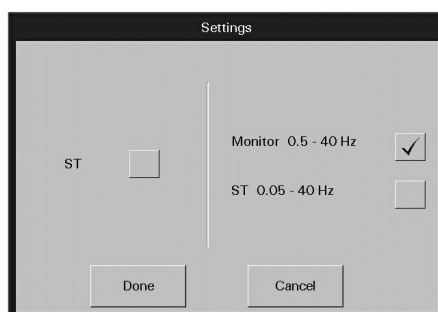

FIGURE 9-42 Settings Dialog Box

2. Select the **ST** check box to enable or disable ST analysis for the selected patient.
 - A checkmark in the ST box indicates that ST analysis is enabled.
 - An empty box indicates that ST analysis is disabled.
 - When the ST check box is empty, the Monitor filter is automatically enabled.

NOTE: If ST licenses are available, an ST license is automatically assigned to the patient when ST is enabled.

NOTE: When using a 5-wire lead set or a View 12™ card, ST is performed on the leads available.

When using a 3-wire lead set, ST is performed on the lead being viewed.

3. Select the **Monitor** or **ST** filter mode.

NOTE: One filter box must always be populated. When a filter mode is selected, the other mode is automatically disabled.

- A checkmark in the Monitor filter box indicates that the Monitor filter is enabled and ST analysis is disabled.
 - A checkmark in the ST filter box indicates that the ST analysis is enabled and the Monitor filter is disabled.
4. Accept or reject the selections made in the dialog box.
 - Select the **Done** button to accept the selections.
 - Select the **Cancel** button to discard the selections, close the dialog box and return to the **Unit Choices** tab.

9.14.3

Configuring Default Report Waveform Parameters

Select the **Strip Setup** sidebar button (shown in FIGURE 9-38) to select the default waveform parameters that will print in the All Strips, Event Zoom-In, and Full Disclosure Zoom-In reports.

NOTE: The **Strip Setup** sidebar button is not available at the **ViewStation** or the **WorkStation**.

To select the default waveform parameters:

1. From the **Unit Choices** tab, select the **Strip Setup** sidebar button.

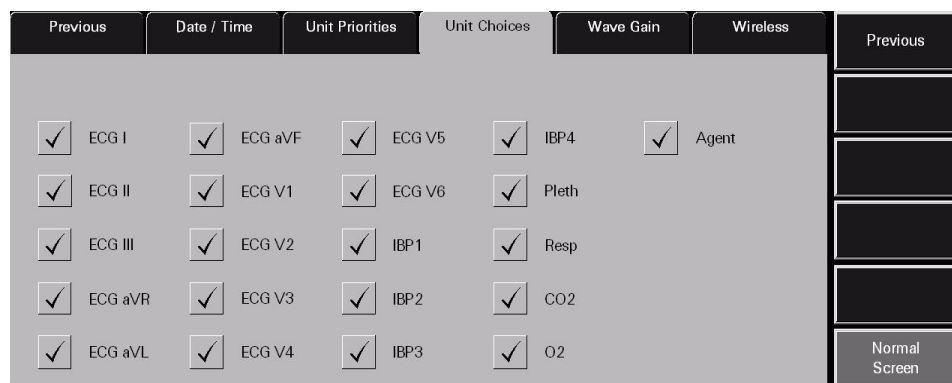

FIGURE 9-43 Strip Setup View of the Unit Choices Tab

2. Select the waveform check box button to enable/disable the printing of waveforms in strip reports. The print setup settings are changed instantaneously.
 - A check mark in a waveform's check box button indicates the waveform is selected to print in reports when that parameter is in use.
 - An empty check box button indicates the waveform is not selected and will not print in reports.
3. To return to the **Unit Choices** tab, select the **Previous** sidebar button.

For additional information about customizing the waveform strips printed for a particular patient, refer to the "Print Setup Tab (Patient)" on page 5-57.

9.14.4 Sidebar Buttons

The following sidebar buttons are used to expand the functionality of this tab.

Strip Setup

This sidebar button was previously described on page 9-57.

Previous

This sidebar button was previously described on page 9-57.

Arrhythmia

This sidebar button was previously described on page 9-55.

Settings (Telepack)

This sidebar button was previously described on page 9-56.

Normal Screen

Select the **Normal Screen** sidebar button to return the display to the full screen mode, and close all tabs, message boxes, and dialog boxes.

9.14.5 Troubleshooting

This section lists some of the potential messages and issues that may occur while using the **Unit Choices** tab.

MESSAGE/ISSUE *	REASON	SOLUTION
The System Setup menu button is disabled.	The System Setup function is already open on a Panorama display and cannot be opened on multiple displays.	Close the System Setup function on the Panorama display on which it is opened.
The Strip Setup sidebar button is not displayed.	Unit Choices tab is being viewed from a ViewStation.	If strip setup is necessary, access the Strip Setup button from a central station.

* Messages are shown in all bold text.

9.15 Wave Gain Tab (System)

The **Wave Gain** tab (shown in FIGURE 9-44) is used to change the initial wave gain settings. This tab is not available at the ViewStation or the WorkStation. Wave gain settings are transferred from the host central station to the ViewStation and the WorkStation when the patient tile is assigned.

For information regarding individual patient tile wave gain settings, refer to the "Wave Gain Tab (Patient)" on page 5-54.

NOTE: The changes made in the **Wave Gain tab (System)** will apply to newly admitted patients.

9.15.1 Accessing the Wave Gain Tab

1. From the menu bar, select the **System Setup** button. The first set of System Setup tabs is displayed.
2. Follow the directions in the "Entering a Password" section on page 9-7.
3. Once the correct password has been entered, the tabs associated with the **System Setup** button are displayed.
4. Select the **More** tab. The next set of System Setup tabs is displayed.
5. Select the **Wave Gain** tab. The **Wave Gain** tab is displayed.

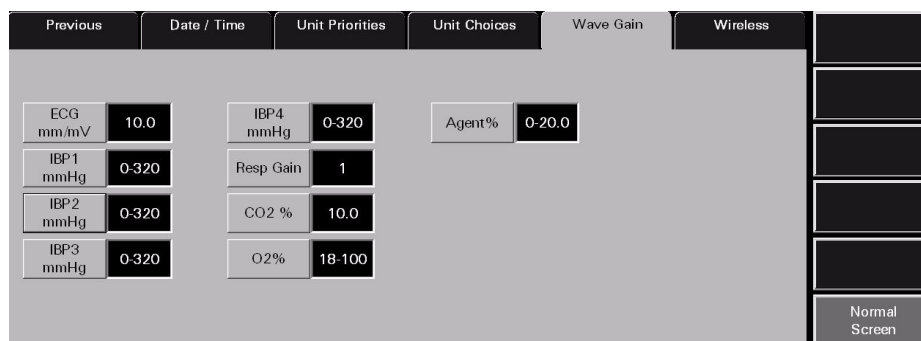

FIGURE 9-44 Wave Gain Tab (System)

9.15.2 Changing the System Default Wave Gain Settings

This section outlines entering and modifying the system default wave gain settings.

1. Select the **ECG mm/mV** button until the desired ECG wave gain is displayed. The settings available for the ECG wave gain include 2.5, 5.0, 10.0, 20.0, and 30.0 mm/mV. The factory default setting is 10.0 mm/mV.
2. Select the **IBPx mmHg** buttons until the desired IBPx wave gains is displayed. There are four IBP buttons. The settings available for the IBP wave gains include 0-20, 0-40, 0-80, 60-140, 0-160, 0-225, 0-320, and (-10) -10 mmHg. The factory default setting is 0-320 mmHg.

NOTE: If the **IBPx** button(s) have been labeled at the bedside monitor, the same label(s) will be displayed on the individual wave gain button(s).

NOTE: **Changing the ECG wave gain does not affect the arrhythmia analysis.**

- 3.** Select the **Resp Gain** button until the desired Resp Gain wave gain is displayed.
The settings available for the Resp Gain wave gain include 1, 2, 3, 4, and 5. The factory default setting is 1.
- 4.** Select the **CO₂ (% , kPa, mmHG)** button until the desired CO₂ wave gain is displayed.
 - The settings available for the CO₂ % wave gain include 5.0, 7.5, and 10.0 %. The factory default setting is 10.0 %.
 - The settings available for the CO₂ kPa wave gain include 5.0, 7.5, and 10.0 kPa. The factory default setting is 10.0 kPa.
 - The settings available for the CO₂ mmHg wave gain include 40, 60, and 100 mmHg. The factory default setting is 100 mmHg.
- 5.** Select the **O₂ %** button until the desired O₂ wave gain is displayed.
The settings available for the O₂ wave gain include 18 - 30, 18 - 60, and 18 - 100 %. The factory default setting is 18 - 100%.
- 6.** Select the **AGENT %** button until the desired Agent wave gain is displayed.
The settings available for the agent wave gains include 0 - 1.0, 0 - 2.5, 0 - 5.0, 0-10.0, 0-15.0, and 0-20.0 %. The factory default setting is 0-20.0%.

9.15.3 Sidebar Button - Normal Screen

Select the **Normal Screen** sidebar button to return the display to the full screen mode, and close all tabs, message boxes, and dialog boxes.

9.15.4 Troubleshooting

This section lists some of the potential messages and issues that may occur while using the System **Wave Gain** tab.

MESSAGE/ISSUE *	REASON	SOLUTION
The System Setup menu button is disabled.	The System Setup function is already open on a Panorama display and cannot be opened on multiple displays.	Close the System Setup function on the Panorama display on which it is opened.

* *Messages are shown in all bold text.*

9.16 Wireless Tab

The **Wireless** tab manages the devices on the Panorama wireless network. It can be used to retrieve information from a wireless device as well as to program it. The **Wireless** tab should only be used when a wireless monitoring device is assigned to the selected patient file. The **Wireless** tab is not available at the ViewStation or the WorkStation. Wireless device maintenance can only be performed from the host central station.

NOTE: The layout and functionality of the **Wireless** tab changes, based on the type of monitoring equipment attached to the programming cable.

9.16.1 Accessing the Wireless Tab

1. From the menu bar, select the **System Setup** button. The first set of **System Setup** tabs is displayed.
2. Follow the directions in the "Entering a Password" section on page 9-7.
3. Once the correct password has been entered, the tabs associated with the **System Setup** button are displayed.
4. Select the **More** tab. The next set of System Setup tabs is displayed.
5. Select the **Wireless** tab. The **Wireless** tab is displayed.

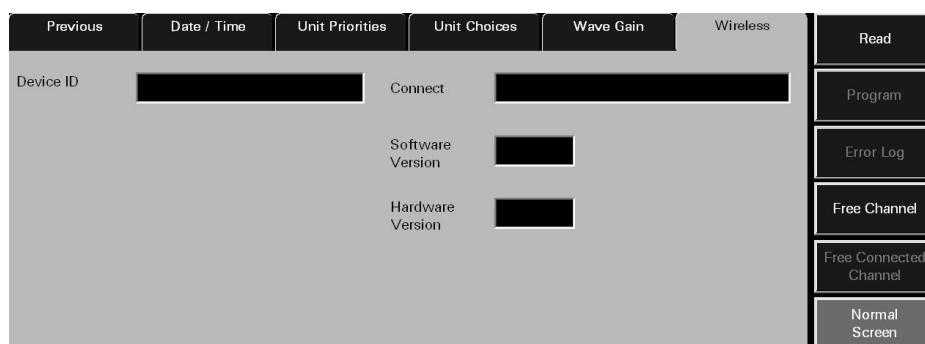

FIGURE 9-45 Wireless Tab (device unread)

9.16.2 Entering Wireless Settings (Telepack-2.4)

This section outlines the settings available in the **Wireless** tab for the Telepack-2.4. The settings in the Wireless tab are shown by selecting the **Read** button and configured by selecting the **Program** button.

NOTE: Programming and assigning of the Telepack must be performed by authorized service personnel only.

The fields shown in these images are described on the following pages.

The screenshot shows the 'Wireless' tab interface with the following fields and values:

Previous	Date / Time	Unit Priorities	Unit Choices	Wave Gain	Wireless
Device ID	ZF4091DX	Connect	Connected to 2.4 Telemetry		
Telepack IP	7 . 6 . 6 . 73	Software Version	F.8	Roaming Version	1.1
Subnet Mask	255 . 255 . 255 . 0	Hardware Version	A.0	Security Selection	WEP128
Network Name	Dscope	Lead Selection	Lead II	Free Channel	Free Connected Channel
Encryption Key	abcdef1234567890abcdef1234	Normal Screen			

FIGURE 9-46 Wireless Tab After Telepack-2.4 Connected

Device ID

The **Device ID** field displays the identification number that was assigned to the connected wireless device. A Device ID has a maximum of 8 alphanumeric characters. Data is shown in the Device ID field when the Wireless tab's **Read** sidebar button is selected. If the read was not successful the Device ID field will remain blank. To view the connection status of the wireless device check the message in the Connect field. The Device ID field cannot be edited and has a factory default setting of blank.

The Device ID for a monitoring device is set up in the **Equipment List** tab. For additional information on setting up a Device ID, refer to the "Equipment Setup Tab" on page 9-33.

Telepack IP

The **Telepack IP** field displays and enables editing of the IP address of the assigned wireless device. The IP address provides a unique device address of the device on the Panorama network.

NOTE: Each Telepack-2.4 device must be configured with a unique IP address from all other devices on the network.

- Data is shown in the Telepack IP Address field when the Wireless tab's **Read** sidebar button is pressed and the read is successful. The default value of the Telepack IP is 0.0.0.0. If the read is not successful, an error message will be displayed. To view the connection status for the wireless device, check the message in the Connect field.
- A Telepack IP Address can be programmed in a connected device by selecting the **Program** sidebar button.

NOTE: The Telepack IP Address field will not be shown if the device cannot be recognized or if there is a Read error.

Subnet Mask

The **Subnet Mask** field displays and enables editing of the Subnet Mask IP address for the assigned wireless device. It sets the subnet mask of the attached device.

- Data is shown in the Subnet Mask IP Address field when the Wireless tab's **Read** sidebar button is pressed and the read is successful. The default value of the Telepack IP is 0.0.0.0. If the read is not successful, an error message will be displayed. To view the connection status of the wireless device, check the message in the Connect field.
- A Subnet Mask IP Address can be programmed in a connected device by selecting the **Program** sidebar button.

NOTE: The Subnet Mask IP Address field will not be shown when the device cannot be recognized or there is a Read error.

Network Name

The **Network Name** field displays the name of the network on which the assigned device resides. It sets the Network Name of the attached device.

- Data is shown in the Network Name field when the Wireless tab's **Read** sidebar button is pressed and the read is successful. If the read is not successful, an error message will be displayed. To view the connection status, check the message in the Connect field.
- A Network Name can be assigned to a connected device by selecting the **Program** sidebar button. The Network Name can contain up to 8 characters. The default value is blank (no characters).

NOTE: The Network Name field will not be shown when the device cannot be recognized or there is a Read error.

Encryption Key

The **Encryption Key** field provides communication security for the connected wireless device on the network. A valid entry for the encryption key must consist of 26 hexadecimal characters, which include letters A to F and numbers 0-9.

- Data is shown in the Encryption Key field when the Wireless tab's **Read** sidebar button is pressed and the read is successful. If the read is not successful, an error message will be displayed. To view the connection status, check the message in the Connect field.
- An encryption key can be assigned to a connected device by selecting the **Program** sidebar button.

NOTE: The Encryption Key field will not be shown when the device cannot be recognized or there is a Read error.

NOTE: The Encryption Key is not case sensitive.

Connect Field

The **Connect** field displays the status of the connection between the Panorama Central Station and the wireless device. A connection status is shown in the Connect field when the Wireless tab's **Read** sidebar button is selected. The status in the Connect field cannot be edited and has a factory default setting of blank.

The messages shown in the **Connect** field include:

MESSAGE	REASON
Connected to 2.4 Telemetry	The connection with the Telepack-2.4 was successful.
Not Connected	The connection with the wireless device was not successful.
Error: Could not receive data	The connection with the wireless device was not successful. Either there was no response from the device or the device is not connected.

Software Version

The **Software Version** field displays the version of software currently in use by the wireless device. Data is shown in the Software Version field when the Wireless tab's **Read** sidebar button is selected. The factory default setting is blank. If the read was not successful, an error message will be displayed and the Software Version field will remain blank. To view the connection status of the wireless device check the message in the Connect field.

Hardware Version

The **Hardware Version** field displays the version of hardware in use by the connected device. Data is shown in the Hardware Version field when the Wireless tab's **Read** sidebar button is selected and has a factory default setting of blank. If the read was not successful, an error message will be displayed and the Hardware Version field will remain blank. To view the connection status of the wireless device check the message in the Connect field.

Security Selection

The **Security Selection** Toggle Choice Control displays the current security protocol. Currently, the only available Security Selection is "WEP128", which sets the security protocol to 128-bit encryption.

Lead Selection

The **Lead Selection** button is applicable only to 3-wire lead sets. The **Lead Selection** button sets and displays the ECG lead for the attached wireless device. ECG lead selection options include Lead I, Lead II and Lead III. The default setting is Lead II.

- Data is shown in the Lead Selection field when the Wireless tab's **Read** sidebar button is selected. Lead Selection has a factory default setting of blank. If the read was not successful, an error message will be displayed and the Lead Selection field will remain blank. To view the connection status check the message in the Connect field.
- The Lead to be monitored by a connected device can be assigned by selecting the **Program** sidebar button.

NOTE: The **Lead Selection** button will not be shown when the device cannot be recognized or there is a Read error.

9.16.3 Entering Wireless Settings (Telepack-608)

This section outlines the settings available in the **Wireless** tab. The settings in the Wireless tab are shown by selecting the **Read** button and configured by selecting the **Program** button.

NOTE: **Programming and assigning of the Telepack must be performed by authorized service personnel only.**

The fields shown in these images are described on the following pages.

FIGURE 9-47 Wireless Tab after Telepack-608 connected

FIGURE 9-48 Wireless Tab after 608 Instrument Radio connected

Device ID

The **Device ID** field displays the identification number that was assigned to the connected wireless device. A Device ID has a maximum of 8 alphanumeric characters. Data is shown in the Device ID field when the Wireless tab's **Read** sidebar button is selected. If the read was not successful the Device ID field will remain blank. To view the connection status of the wireless device check the message in the Connect field. The Device ID field cannot be edited and has a factory default setting of blank.

The Device ID for a monitoring device is set up in the **Equipment List** tab. For additional information on setting up a Device ID, refer to the "Equipment Setup Tab" on page 9-33.

Connect Field

The **Connect** field displays the status of the connection between the Panorama Central Station and the wireless device. A connection status is shown in the Connect field when the Wireless tab's **Read** sidebar button is selected. The status in the Connect field cannot be edited and has a factory default setting of blank.

The messages shown in the **Connect** field include:

MESSAGE	REASON
Connected to 608 Telemetry	The connection with the Telepack-608 was successful.
Connected to 608 Instrument Telemetry	The connection with the 608 Instrument Radio was successful.
Not Connected	The connection with the wireless device was not successful.
Error: Could not receive data	The connection with the wireless device was not successful. Either there was no response from the device or the device is not connected.

Software Version

The **Software Version** field displays the version of software currently in use by the wireless device. Data is shown in the Software Version field when the Wireless tab's **Read** sidebar button is selected. The factory default setting is blank. If the read was not successful the Software Version field will remain blank. To view the connection status of the wireless device check the message in the Connect field.

Hardware Version

The **Hardware Version** field displays the version of hardware in use by the connected device. Data is shown in the Hardware Version field when the Wireless tab's **Read** sidebar button is selected and has a factory default setting of blank. If the read was not successful the Hardware Version field will remain blank. To view the connection status of the wireless device check the message in the Connect field.

Lead Selection

The **Lead Selection** button displays the ECG Lead to be monitored by the assigned device. It sets the lead to be monitored by the attached device. ECG lead selection options include Lead I, Lead II and Lead III.

- Data is shown in the Lead Selection field when the Wireless tab's **Read** sidebar button is selected. Lead Selection has a factory default setting of blank. If the read was not successful the Lead Selection field will remain blank. To view the connection status check the message in the Connect field.
- The Lead to be monitored by a connected device can be assigned by selecting the **Program** sidebar button.

NOTE: **The Lead Selection button will not be shown when the device cannot be recognized or there is a Read error.**

Protocol Selection

The **Protocol Selection** button displays the protocol selection for the assigned device. It sets the protocol of the attached device.

- Data is shown in the Protocol Selection field when the Wireless tab's **Read** sidebar button is pressed and has a factory default setting of blank. If the read was not successful the Protocol Selection field will remain blank. To view the connection status check the message in the Connect field.
- A Protocol Selection data can be programmed in a connected device by selecting the **Program** sidebar button.

NOTE: **The Protocol Selection button will not be shown when the device cannot be recognized or there is a Read error.**

Channel Type

The **Channel Type** button displays the selected channel for the assigned device. It selects the channel type of the attached device. Channel type options include Medium and High.

- Data is shown in the Channel Type field when the Wireless tab's **Read** sidebar button is pressed and has a factory default setting of blank. If the read was not successful the Channel Type field will remain blank. To view the connection status check the message in the Connect field.
- A Channel type can be programmed in a connected device by selecting the **Program** sidebar button.

NOTE: **The Channel Type button will not be shown when the device cannot be recognized or there is a Read error.**

DL Pair

The **DL Pair** button displays the channel that will be used for transferring data (i.e., demographics, alarms, arrhythmia) from the central station to the wireless bedside device. DL Pair options include 1,2,3, and Auto. Options 1,2, and 3 should be used for networks that are configured for roaming. The Auto setting should be used for networks that are not configured for roaming.

NOTE: **The DL Pair option affects wireless bedside devices using instrument radios.**

- Data is shown in the DL Pair field when the instrument radio has previously been programmed.
- A DL Pair can be programmed in a connected device by selecting the **Program** sidebar button.

9.16.4 Sidebar Buttons

The following sidebar buttons are used to expand the functionality of this tab.

9.16.4.1 Read

Select the **Read** sidebar button to retrieve status parameters from the connected wireless device when it is connected to the Panorama Central Station in Service mode.

Selecting the **Read** button will attempt to obtain a reading from the connected wireless device.

- A successful read from a known device will display the fields and sidebar buttons appropriate to the attached device.
- An unsuccessful read will only display a connect status in the **Connect** field. The **Device ID**, **Software Version**, and **Hardware Version** fields will be blank.

9.16.4.2 Program

Select the **Program** sidebar button to program information in a wireless device when it is connected to the Panorama Central Station in Service mode.

NOTE: The **Program** sidebar button will be disabled until a valid device has been detected by the Panorama Central Station.

Selecting the **Program** sidebar button will display the message **Are you sure you want to program the wireless device?**

- Select the **Yes** button to program the wireless device. The message **Wireless device programmed successfully.** is displayed.
- Select the **No** button to cancel the programming of the connected device.

9.16.5 Error Log Sidebar Button

Select the **Error Log** sidebar button to display the log of error messages for the connected wireless device. Selecting the **Error Log** sidebar button will bring up the Error log for the connected wireless device. When the **Error Log** sidebar button is selected the button is changed to the **Telepack** sidebar button. FIGURE 9-49 shows the Error Log for the **Wireless** tab.

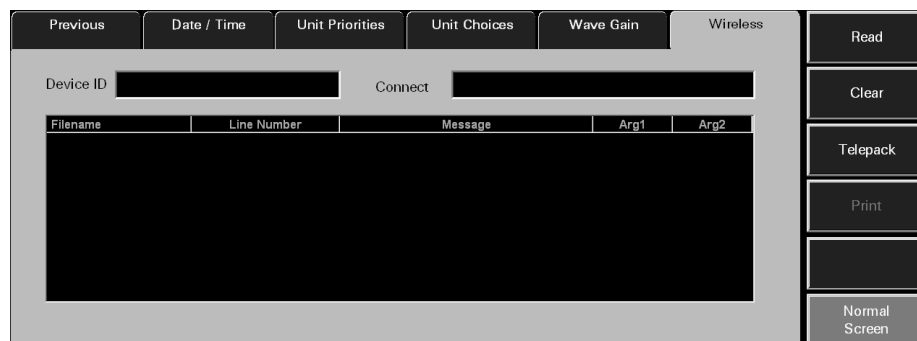

FIGURE 9-49 Error Log for the Wireless Tab

NOTE: The **Error Log** sidebar button will be disabled until a valid device has been detected by the Panorama Central Station.

Printing a Telepack Error Log Report

A Telepack Error Log Report can be printed from this tab by selecting the **Print** menu bar button.

For additional information regarding this report, refer to the "Telepack Error Log Report" on page 8-53.

9.16.6 Device ID

The **Device ID** field displays the identification number that was assigned to the connected wireless device. A Device ID has a maximum of 8 alphanumeric characters. Data is shown in the Device ID field when the Wireless tab's **Read** sidebar button is selected. If the read was not successful the Device ID field will remain blank. To view the connection status of the wireless device check the message in the Connect field. The Device ID field cannot be edited and has a factory default setting of blank.

Device ID is set up in the **Equipment List** tab. For additional information on setting up a Device ID and the requirements of a Device ID, refer to the "Equipment Setup Tab" on page 9-33.

9.16.7 Connect Field

The **Connect** field displays the status of the connection between the Panorama Central Station and the wireless device. A connection status is shown in the Connect field when the Wireless tab's **Read** sidebar button is selected. The status in the Connect field cannot be edited and has a factory default setting of blank.

The messages shown in the **Connect** field include:

MESSAGE	REASON
Connected to 608 Telemetry	The connection with the Telepack-608 was successful.
Connected to 608 Instrument Telemetry	The connection with the 608 Instrument Radio was successful.
Not Connected	The connection with the wireless device was not successful.
Error: Could not receive data	The connection with the wireless device was not successful. Either there was no response from the device or the device is not connected.

List Box

The Error Log list box contains the error messages that occurred at the connected wireless device. The following information is collected in an Error log:

- **Filename column**
The Filename column shows the names of the files in the error list.
- **Line Number column**
The Line Number column shows the line numbers for the items in the error list.
- **Message column**
The Message column shows the messages that were sent to the Panorama system by the Telepack-608 device.

- Arg1 column
The Arg 1 column is populated by the text fields sent to the Panorama system by the Telepack-608 device.
- Arg2 column
The Arg 1 column is populated by the text fields sent to the Panorama system by the Telepack-608 device.

Error Log Read Sidebar Button

Select the **Read** sidebar button to retrieve error log messages from the connected wireless device when it is connected to the Panorama Central Station in Service mode. A device is in Service mode when it is connected to the Panorama Central Station's serial port 2 via the device's programming cable.

Selecting the **Read** button will attempt to read the Error log from the connected wireless device.

- A successful read from a known device will display the fields and sidebar buttons appropriate to the attached device.
- An unsuccessful read will only display a connect status in the **Connect** field.

Clear Sidebar Button

The Error Log contains a **Clear** sidebar button. Select the **Clear** sidebar button to delete the contents of the Telepack Error log. Selecting the **Clear** sidebar button produces a pop-up confirmation dialog on the screen that states **Are you sure you want to clear the error log? Selecting Yes will Delete all Data.**

- The choices for the Error Log confirmation dialog are No and Yes.
- Selecting the **No** button in the Error Log confirmation dialog does not clear the error log.
- Selecting the **Yes** button in the Error Log confirmation dialog deletes the contents of the Error log.

Telepack Sidebar Button

The Error Log contains a **Telepack** sidebar button. Select the **Telepack** button to return the tab to the **Wireless** tab display.

For additional information regarding printer setup, refer to the Panorama Printer Configuration Guide (P/N 0070-00-0561).

For additional information regarding the Telepack Error Log Report, refer to "Additional Reports" on page 8-40.

Sidebar Button - Normal Screen

Select the **Normal Screen** sidebar button to return the display to the full screen mode, and close all tabs, message boxes, and dialog boxes.

9.16.7.1 Free Channel Sidebar Button

Select the **Free Channel** sidebar button to free an allocated channel for a wireless device. Selecting the **Free Channel** sidebar button will request a list of the wireless devices on the wireless network.

NOTE: The **Free Channel sidebar button will be disabled until a valid device has been detected by the Panorama Central Station.**

9.16.7.2 Free Connected Channel Sidebar Button

Select the **Free Connected Channel** sidebar button to free a channel from a connected device that supports channels.

NOTE: The **Free Connected Channel sidebar button will be disabled until a valid device has been detected by the Panorama Central Station.**

9.16.7.3 Sidebar Button - Normal Screen

Select the **Normal Screen** sidebar button to return the display to the full screen mode, and close all tabs, message boxes, and dialog boxes.

9.16.8 Troubleshooting

This section lists some of the potential messages and issues that may occur while using the **Wireless** tab.

MESSAGE/ISSUE *	REASON	SOLUTION
The System Setup menu button is disabled.	The System Setup function is already open on a Panorama display and cannot be opened on multiple displays.	Close the System Setup function on the Panorama display on which it is opened.
You must enter all fields to program the wireless device	All of the fields in the Wireless tab were not completed before the Program button was pressed.	Select the OK button to close the error message dialog box. Complete all of the fields in the Wireless tab before selecting the Program button.
Program Failure: Invalid Data	The wireless device was not successfully programmed.	Select the OK button to close the error message dialog box. Recheck the accuracy of the data to be entered in the wireless device.
Warning: Attached device is already programmed with a channel. Allocated channel will be lost if not freed first. Do you want to continue	The connected device has already been programmed and allocated with a channel.	Select the OK button to close the error message dialog box. <ul style="list-style-type: none"> Select the YES button to discard the previously allocated channel and try to obtain a new channel. Select the NO button to keep the previously obtained channel.

* Messages are shown in all bold text.

MESSAGE/ISSUE *	REASON	SOLUTION
Program Failure: Unable to obtain a channel.	The system tried to obtain a channel from the Panorama Central Station but was unsuccessful.	Select the OK button to close the error message dialog box. Free up any unused channels. Try again to obtain a channel from the system. The system administrator can also purchase additional channels.
Network Error: Unable to obtain device list.	The system requested a device list from the wireless network but did not receive one within the allocated request time.	Select the OK button to close the error message dialog box. Request a device list from the wireless network again.
There are no devices available	An empty device list was received from the wireless network.	Select the OK button to close the error message dialog box. Enter the device in the Panorama Equipment list.
Free Error: Device not found	The device channel was not successfully freed.	Select the OK button to close the error message dialog box. Try to free a different channel from the system. The system administrator can also purchase additional channels.
Program Failure: The channel was successfully freed but an error was encountered when programming the device. The device must now be programmed over its existing channel.	The channel was successfully freed but there was a problem with the programming of the device.	Select the OK button to close the error message dialog box. Program the device over its existing channel.

* Messages are shown in all bold text.

This page intentionally left blank.

Telepack (Optional)

This section outlines the Panorama Telepack:

- Introduction
- Button Indicators
- Indicator Lights
- Operating Instructions
- Telepack with Nonin SpO2 Module (Optional)
- Approved Telepack Accessories
- Troubleshooting

10.1 Introduction

The Panorama Telepack is a battery powered ambulatory device that acquires ECG information from an adult patient and transmits it to the Panorama Central Station for analysis. For the Telepack-608, the transmission to the Panorama Central Station is via the Panorama Telemetry Server; for the Telepack-2.4, the transmission is direct to the Panorama Central Station. The Panorama Central Station is capable of performing data analysis functions such as Heart Rate determination, R-wave detection, and ECG filtering.

The Telepack is controlled through the use of buttons which are located on the front and side of the device. The status of the unit is shown by the LED indicator lights. The Telepack will not turn off unless the batteries are removed from the unit or when the batteries are depleted.

The Telepack has the following key features:

- Uni-directional data transmission (between ambulatory patient and Panorama Central Station) using wireless communication technology in the WMTS band or ISM band
- Functions such as Nurse Call, Attendant Present, Lead Select, Remote Print, and Lead/Battery/Link tests are easily performed using buttons
- LED lights are used to indicate link status, battery status, and ECG lead connection status
- 3-wire and 5-wire Lead ECG support









CAUTION: The Panorama Telepack and Instrument Radio are wireless devices and may be subject to intermittent signal dropout. Panorama wireless devices are designed to perform with a maximum cumulative signal dropout of one minute in a 24-hour period under ideal conditions. A crowded wireless environment or interference from other medical or non-medical devices, either intentional (e.g., VOIP phones, pagers, asset tracking systems, etc.) or unintentional (e.g., AC motors, microwave ovens, paper shredders, etc.), may result in a significantly increased amount of signal dropout experienced by any one or multiple wireless device(s).

See "Technical Alarms and Events" on page 13-19 for troubleshooting intermittent signal dropout of the wireless device.

CAUTION: Changes or modifications not expressly approved by Mindray DS USA, Inc. could void the user's authority to operate the equipment.

10.2 Button Indicators

The following buttons are located on the Telepack device:

- One **Nurse Call** button: 
- Two **Attendant Present** button:  buttons
- One **LEAD SELECT** button:  (domestic),  (international)
- One **CHECK** button:  (domestic),  (international)
- One **RECORD** button:  (domestic), or  (international)

10.2.1 Nurse Call Button

Press the **Nurse Call** button to request the presence of a clinician. When this button is pressed:

- A message displays on the Panorama Central Station indicating that the **Nurse Call** button was pressed.
- If configured, an event is recorded and posted to the **Events** tab Event list. For additional information about configuring this option, refer to “Alarm Responses Tab (Patient)” on page 6-12.

10.2.2 Attendant Present Buttons

Press the **Attendant Present** buttons simultaneously to indicate the presence of a clinician at the patient’s bedside. When these buttons are pressed:

- A message posts to the Events list indicating that the **Attendant Present** buttons were pressed.
- The Nurse Call alarm is acknowledged, if the **Nurse Call** button was pressed.

10.2.3 LEAD SELECT Button

Press the ECG **LEAD SELECT** button to:

- Change the active lead when using a 3-wire lead set
- The ECG LED that is active will turn on for 2 seconds

10.2.4

CHECK Button

Press the **CHECK** button to verify LED indicator lights are functioning, ECG Lead connection, link status, and battery status.

For information on interpreting the status of the ECG Lead, Link Status and Battery Status LED indicator lights, refer to the following sections: “ECG Lead Diagram LED Indicator Lights” on page 10-4, “Link Status LED Indicator Light” on page 10-6, and “Battery Status LED Indicator Light” on page 10-6.

10.2.5

RECORD Button

Press the **RECORD** button to remotely print the “All Strips Report” to the Panorama Central Station default printer.

10.3 Indicator Lights

The Telepack uses LED indicator lights to verify the functionality of the device. The indicator lights on the device include:

- 3-wire and 5-wire ECG lead indicator lights
- 1 Link Status indicator light
- 1 Battery Status indicator light

10.3.1

ECG Lead Diagram LED Indicator Lights

The Telepack ECG Lead diagram’s LED indicator lights show the status of the lead connections with the patient. The Telepack’s ECG Lead LED indicator lights (shown in FIGURE 10-1 and FIGURE 10-2), include five green LED indicators that correspond to the following lead connections:

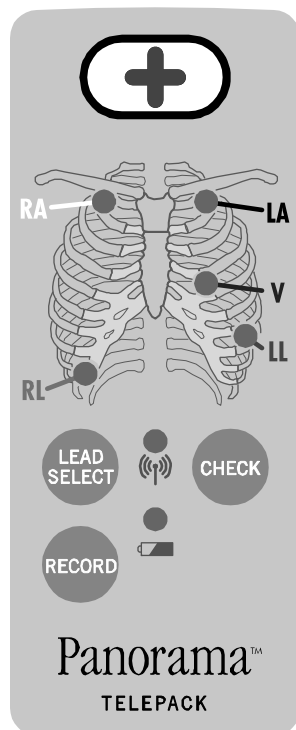

FIGURE 10-1 Front View of Telepack (AHA) with Domestic Overlay

Domestic Overlay

- White RA (right arm)
- Black LA (left arm)
- Brown V (chest)
- Green RL (right leg)
- Red LL (left leg)

The ECG Lead LED indicator lights remain off except during the initial power up phase and during a lead test sequence. For additional information, refer to “Lead Placement Procedures” on page 4-2.

Press the **CHECK** button to verify the Telepack’s ECG lead connections.

NOTE: When the **CHECK** button is pressed, all of the device LED indicator lights are tested simultaneously.

This test determines if the patches are connected based on thoracic impedance. If a patch adhesive is not sticking, a patch is dry, or the skin gel is dry, the test fails.

The Telepack’s ECG Lead LED indicator lights remains on for approximately 10 seconds during the test sequence, indicating that the Telepack has good lead connectivity. An unlit ECG Lead LED light indicates that the Telepack has no lead connectivity.

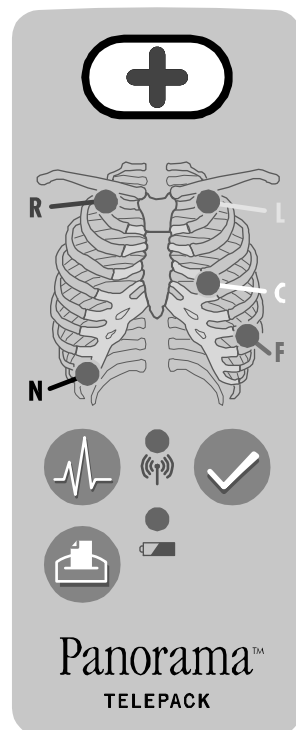

FIGURE 10-2 Front View of Telepack (AHA) with International Overlay

International Overlay

- Red R (right arm)
- Yellow L (left arm)
- White C (chest)
- Black N (right leg)
- Green F (left leg)

NOTE: If a 3-wire Lead set is used, a maximum of three lights will illuminate. If a 5-wire Lead set is used, a maximum of five lights will illuminate.

10.3.2 Link Status LED Indicator Light

The Telepack Link Status LED indicator light verifies the Telepack's connection to the Panorama Patient Monitoring Network.

The Link Status LED indicator light remains on for approximately 10 seconds during the initial power up and during the test sequence.

Press the **CHECK** button to verify the Telepack's link status with the wireless network.

NOTE: When the **CHECK** button is pressed, all of the device LED indicator lights are tested simultaneously.

The Telepack's Link Status LED indicator light shows the results of the link status test as follows:

TELEPACK	LED STATUS	DESCRIPTION
Telepack-2.4	On	The Telepack-2.4 has established communication with the access point.
	Flashing	The Telepack-2.4 is trying to establish communication with the access point.
	Off	The Telepack-2.4 has not been configured for operation, or the Telepack-2.4 is in system startup.
Telepack-608	On	The Telepack-608 has been configured for operation. This is not an indication of being in range of the wireless network.
	Flashing	The Telepack-608 has not been configured for operation.
	Off	The Telepack-608 batteries need replacement.

10.3.3 Battery Status LED Indicator Light

The Telepack Battery Status LED indicator light verifies the status of the Telepack's batteries.

Press the **CHECK** button to verify the Telepack's battery status.

NOTE: When the **CHECK** button is pressed, all of the device LED indicator lights are tested simultaneously.

During this test sequence, the Battery Status LED indicator light will remain on for approximately 10 seconds if the Telepack batteries have more than 2 hours of battery life remaining. A flashing Battery Status LED light indicates the Telepack batteries have less than 2 hours of battery life remaining. An unlit Battery Status LED light indicates the Telepack batteries should be replaced immediately, or that they have been incorrectly inserted.

NOTE: The Telepack device should not be used for battery storage purposes.

NOTE: When a Telepack is assigned to a patient tile, the battery charge percentage integer, and percent sign (%) are displayed in the digital data tile at the central station.

NOTE: The Telepack batteries used may be subject to local regulations regarding disposal. At the end of the battery life, never dispose of the batteries in a fire. Batteries should be disposed of in accordance with any local regulations.

10.4 Operating Instructions

This section of the manual provides instructions for programming the Telepack device for use with the Panorama Central Station.

10.4.1 Initial Setup of Telepack

The Panorama Central Station should be installed and running before you begin to set up the Telepack device. For additional information, refer to the Panorama Service Manual (P/N 0070-00-0634).

The following items are required to initially install and program the Telepack:

- Telepack device
- 2 AA size alkaline batteries (P/N 0146-00-0077-01)
- Telepack service mode cable

10.4.1.1 Inserting Batteries

To activate the Telepack device, insert the 2 AA size alkaline batteries in the Telepack battery compartment. Use the label on the back of the Telepack as a guide. Secure the end cap of the battery compartment by twisting firmly in the clockwise direction.

The Telepack automatically performs an initial system check if the batteries are installed properly.

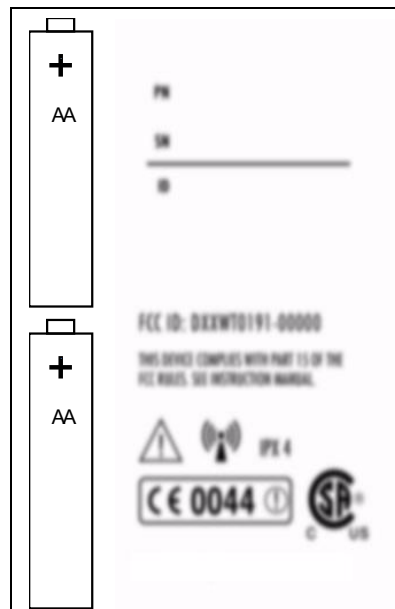

FIGURE 10-3 Telepack, rear panel (right side of image intentionally blurred)

WARNING: Do not incinerate batteries, possible explosion may occur.

CAUTION: Visually inspect the battery compartment for any foreign object prior to use.

CAUTION: The Telepack may not function if the batteries installed in the device are corroded. Use only approved batteries (P/N 0146-00-0077-01) in the Telepack and observe proper polarity. Installing batteries with the incorrect polarity may cause the batteries to become excessively warm.

The Telepack will not transmit data to the Panorama Central Station once the batteries have become depleted. To test the batteries, press the **CHECK** button and confirm that both the Link LED and the Battery LED is lit.

When not in use, the Telepack device should be stored without batteries.

10.4.1.2 Programming the Telepack

This section describes how to program the Telepack. For additional information, refer to the "Wireless Tab" on page 9-62.

NOTE: Programming and assigning of the Telepack must be performed by authorized service personnel only.

CAUTION: The Telepack should not be attached to the patient when the device is being programmed into the system.

To program the Telepack:

1. Connect the Telepack service mode cable from the Panorama Central Station to the serial port provided on the base of the Telepack device.
2. Insert the batteries into the device. For additional information, refer to "Inserting Batteries" on page 10-7.
3. From the central station main screen, select the **System Setup** menu button.
4. Select the **Installation Setup** tab, and enter the System password. For additional information, refer to "Entering a Password" on page 6-2.
5. Select the **More** tab, then select the **Wireless** tab. The **Wireless** tab is displayed (shown in FIGURE 10-4).

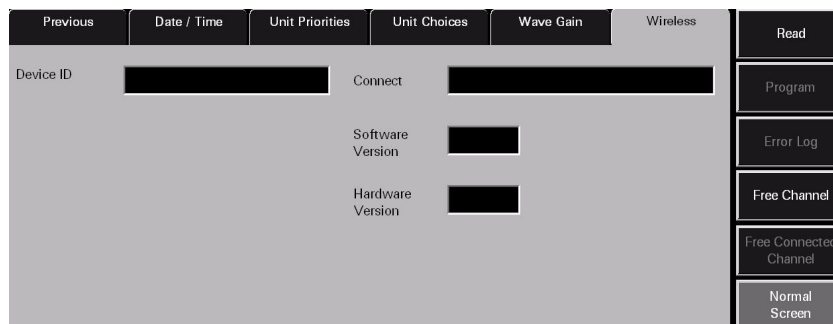

FIGURE 10-4 Wireless Tab

6. Select the **Read** sidebar button. The information from the Telepack device is displayed in the appropriate fields.
7. Select the **Program** sidebar button. A dialog box appears.
8. Change any editable fields as necessary.
9. Select the **Yes** button to confirm. The message **Wireless device programmed successfully appears** is displayed confirming that the Telepack was programmed correctly.

NOTE: If the Telepack device is not connected properly or if the Panorama Central Station is unable to detect the device, the message, "Error: Could not receive data" is displayed at the Panorama Central Station.

10.4.1.3 Entering the Telepack to the Equipment List

The Telepack device should be entered to the Panorama Central Station Equipment List using the **Equipment Setup** tab. For additional information about entering a Telepack device to the Panorama Central Station, refer to "Entering New Equipment" on page 9-34.

The Device ID is found on the back of the Telepack device. After assigning the device to the Panorama Central Station, the Telepack is ready for patient use.

10.4.1.4 Telepack Power Up Sequence

The Telepack goes through a power up sequence each time the batteries are inserted in the device. The power up sequence includes a hardware and software check, an ECG Lead connection status test, a link status test, and a battery status test. A successful power up sequence is indicated when the LED indicator lights illuminate for approximately 10 seconds.

For additional information on the status tests performed by the Telepack during the start up sequence, refer to the "LEAD SELECT Button" on page 10-3.

After the Telepack device powers up, it is ready to be programmed and assigned to a patient.

10.4.1.5 Telepack Communication Range

Telepack-2.4

The range for the Telepack-2.4 device to communicate and transfer data is generally within 100 feet of a network access point. This distance is subject to site survey, and is affected by building materials. The device is for indoor use only.

Telepack-608

The range for the Telepack-608 device to communicate and transfer data is generally within 30 feet of a Panorama Antenna. This distance is subject to site survey, and is affected by building materials. The device is for indoor use only.

10.4.2 Securing the Telepack Device

Secure the Telepack to the patient after the ECG leads are connected to the device. The device should be secured in a telemetry pouch or in the pocket of a patient gown.

10.5 Telepack with Nonin SpO₂ Module (Optional)

This section of the manual provides instructions for installing the Nonin SpO₂ module in the Telepack.

10.5.1 Introduction

The Telepack with Nonin SpO₂ module is an optional accessory used to monitor and display SpO₂ data for a patient that is being monitored at the Panorama Central Station. The SpO₂ data includes SpO₂ waveform, SpO₂ numeric data, and numeric pulse rate.

10.5.2 Installing the SpO₂ Module on the Telepack

1. Using care, remove the flexible cover from the connector on the bottom of the Telepack by using a small flat-blade screw driver or other similar tool (shown in FIGURE 10-5).

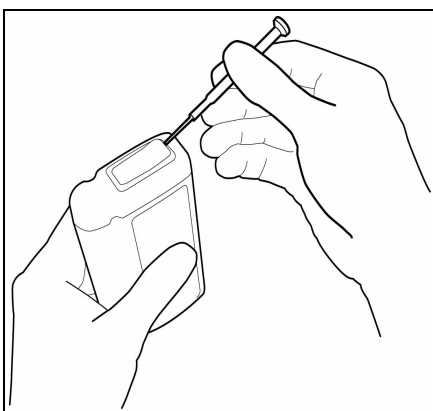

FIGURE 10-5 Removing Telepack Flexible Cover

2. Install the flexible cover (removed in step 1) on the connector on the bottom of the SpO₂ Module.

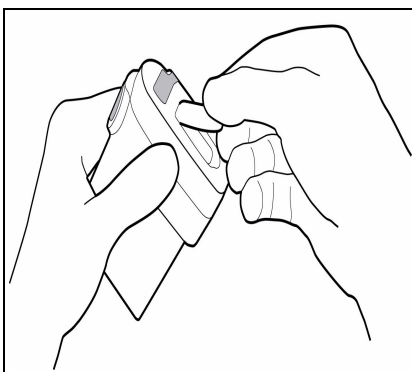

FIGURE 10-6 Installing Flexible Cover in SpO₂ Module

3. Turn the Telepack off by rotating the battery cap in a counter-clockwise direction. The Telepack is turned off.



FIGURE 10-7 Removing Telepack Battery Cap

4. Align the two devices (shown in FIGURE 10-8) and then slide the SpO₂ Module into the Telepack. First, the connectors are mated; Continue pushing the devices together firmly until a loud audible "click" is heard as the mechanical latch is engaged.

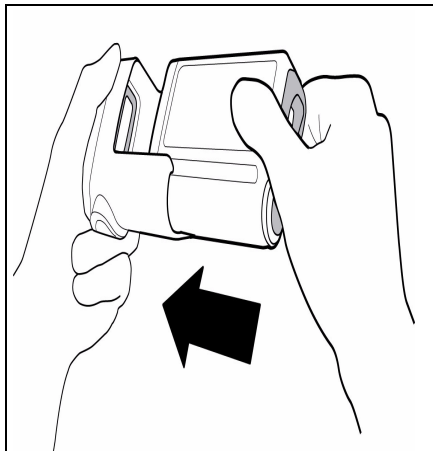

FIGURE 10-8 Inserting Telepack into SpO₂ Module

5. Turn the Telepack on by securing the end cap of the battery compartment by twisting firmly in the clockwise direction.

10.5.3

Removing the SpO₂ Module from the Telepack

1. Turn the Telepack off by rotating the battery cap in a counter-clockwise direction. The Telepack is turned off.

2. Press the large button on the right side of the SpO₂ module (shown in FIGURE 10-9) until a loud audible click is heard. The click sound indicates that the latch has been properly disengaged from the Telepack.

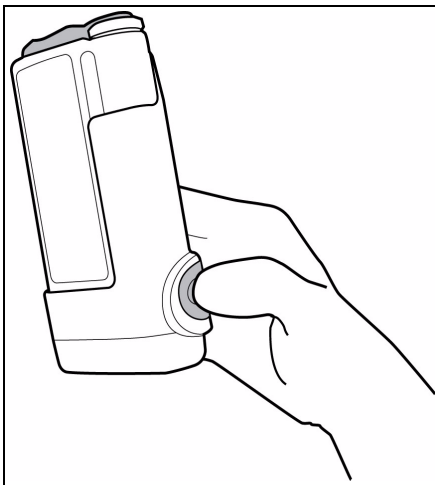

FIGURE 10-9 SpO₂ Module Release Button

NOTE: As a safety feature, the connectors should remain connected even after the mechanical latch is disengaged.

3. Separate the SpO₂ Module from the Telepack.
4. Remove the flexible cover from the bottom of the SpO₂ Module.
5. To avoid electrostatic sensitivity, install the flexible cover on the connector on the bottom of the Telepack.

NOTE: The Telepack may automatically reset due to an electrostatic event if the flexible cover is not replaced.

10.5.4 Installing the Patient Cable

A patient cable is needed to collect the SpO₂ data.

1. Mate the 8-pin connector on the cable with the matching connector on the bottom of the SpO₂ Module. The connector should be firmly pressed in place to ensure that it is properly placed.

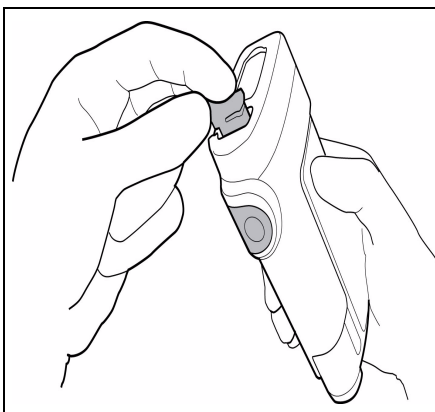

FIGURE 10-10 Inserting Patient Cable in SpO₂ Module

2. Route the cable in the channel on the back of the unit. The channel regions (shown in FIGURE 10-11) should also be pressed firmly to ensure that they are properly placed.

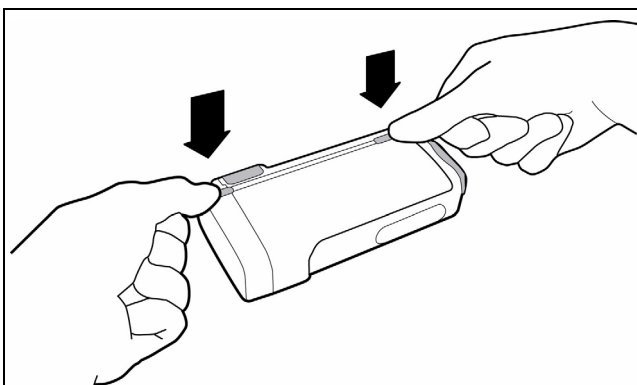

FIGURE 10-11 Securing the Patient Cable

10.5.5 Attaching the Finger Clip Sensor

1. Insert the finger (preferably the index, middle, or ring finger) into the Nonin finger clip until the end of the finger reaches the finger stop (shown in FIGURE 10-12). Keep the fingernail facing the sensor top. Ensure that long fingernails are not interfering with the proper finger position.

NOTE: Disposable finger sensors (shown in FIGURE 10-13) may also be used. Follow the packaging directions carefully to ensure proper application.

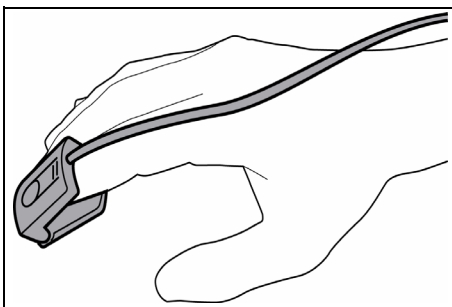

FIGURE 10-12 Reusable finger clip sensor

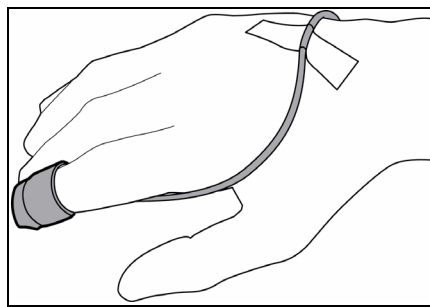

FIGURE 10-13 Disposable sensor

NOTE: For best results, when using the sensor for data collection, secure the sensor cable independently from the sensor with medical device tape, preferably around the base of the finger. Be sure that the tape securing the cable does not restrict the blood flow.

CAUTION: Tissue damage or inaccurate SpO₂ measurements may be caused by incorrect sensor application or use, such as wrapping too tightly, applying supplemental tape, failing to inspect the sensor site periodically, or failing to position appropriately. Carefully read the sensor directions for use, the Panorama Operating Instructions, and all precautionary information before use.

CAUTION: Inaccurate SpO₂ measurements may be caused by:

- **Incorrect sensor application or use**
- **Significant levels of dysfunctional hemoglobins, (e.g., carboxyhemoglobin or methemoglobin)**
- **Intra-vascular dyes such as indocyanine green or methylene blue**
- **Exposure to excessive illumination such as surgical lamps (especially ones with a xenon light source), bilirubin lamps, fluorescent lights, infrared heating lamps, or excessive ambient light. In such cases, cover the sensor site with opaque material.**
- **Excessive patient movement**
- **Venous pulsations**
- **Electro-surgical interference**
- **Placement of a sensor on an extremity that has a blood pressure cuff, arterial catheter, or intra-vascular line.**
- **Cold extremities due to reduced circulation.**
- **Nail polish or fungus**

CAUTION: In certain situations in which perfusion and signal strength are low, such as in patients with thick or pigmented skin, inaccurately low SpO₂ readings will result. Verification of oxygenation should be made, especially in patients with chronic lung disease, before instituting any therapy or intervention.

CAUTION: Many patients suffer from poor peripheral perfusion due to hypothermia, hypovolemia, severe vasoconstriction, reduced cardiac output, etc. These symptoms may cause a loss in vital sign readings.

CAUTION: Prolonged and continuous monitoring may increase the risk of skin erosion and pressure necrosis at the site of the sensor. Check the SpO₂ sensor site frequently to ensure proper positioning, alignment and skin integrity at least every eight (8) hours; with the Adult and Pediatric re-usable finger sensor, check every four (4) hours; for patients of poor perfusion or with skin sensitive to light, check every 2 - 3 hours; more frequent examinations may be required for different patients. Change the sensor site if signs of circulatory compromise occur.

10.5.6 Removing the Patient Cable

- The patient cable is removed by gently pulling the cable from its channel, and then gripping and pulling the pull tab, to disconnect the connectors.

10.6 Approved Telepack Accessories

DESCRIPTION	PART NUMBER
Telepack-608	0998-00-0191-06 (Domestic) 0998-00-0191-07 (International)
Telepack-2.4	0998-00-0707-01 (Domestic) 0998-00-0707-02 (International)
Electrodes	0681-00-0100-01 (Box of 600) 0681-00-0100-02 (Box of 60)
ECG Lead Set for Telepack, 18"	0012-00-1503-04 (3-wire lead set, domestic) 0012-00-1503-01 (5-wire lead set, domestic) 0012-00-1503-13 (3-wire lead set, international) 0012-00-1503-10 (5-wire lead set, international)
ECG Lead Set for Telepack, 24"	0012-00-1503-05 (3-wire lead set, domestic) 0012-00-1503-02 (5-wire lead set, domestic) 0012-00-1503-14 (3-wire lead set, international) 0012-00-1503-11 (5-wire lead set, international)
ECG Lead Set for Telepack, 36"	0012-00-1503-06 (3-wire lead set, domestic) 0012-00-1503-03 (5-wire lead set, domestic) 0012-00-1503-15 (3-wire lead set, international) 0012-00-1503-12 (5-wire lead set, international)
ECG Plug	0012-00-1527-32 (RL-Green plug, domestic) 0012-00-1527-34 (V-Brown plug, domestic) 0012-00-1527-33 (N-Black plug, international) 0012-00-1527-35 (C-White plug, international)
Kit, Telepack Programming	0020-00-0485-01
Telepack SpO ₂ Module	0998-00-0192-01
Adult Single Patient Use Nonin Sensor, 10 pack	0600-00-0139-10
Adult Reusable Nonin SpO ₂ Sensor, 1 each	0600-00-0140-01
Interface Cable for Single Patient Use Adult SpO ₂ Sensor	0012-00-1542-01
Kit, Adult Nonin SpO ₂ Sensors	0020-00-0167
SpO ₂ Module Cleaning Plug	0003-00-0055
Batteries (Alkaline, size AA)	0146-00-0077-01
Panorama Telepack Pouch	0202-00-0179-02 (Bag of 25)
ECG AAMI (DOMESTIC) LEAD WIRES	
Lead Wire, LA-Black, 18"	0012-00-1527-04
Lead Wire, LL-Red, 18"	0012-00-1527-03
Lead Wire, RA-White, 18"	0012-00-1527-02
Lead Wire, RL-Green, 18"	0012-00-1527-05
Lead Wire, V-Brown, 18"	0012-00-1527-01
Lead Wire, LA-Black, 24"	0012-00-1527-14
Lead Wire, LL-Red, 24"	0012-00-1527-13
Lead Wire, RA-White, 24"	0012-00-1527-12
Lead Wire, RL-Green, 24"	0012-00-1527-15
Lead Wire, V-Brown, 24"	0012-00-1527-11
Lead Wire, LA-Black, 36"	0012-00-1527-24
Lead Wire, LL-Red, 36"	0012-00-1527-23

DESCRIPTION	PART NUMBER
Lead Wire, RA-White, 36"	0012-00-1527-22
Lead Wire, RL-Green, 36"	0012-00-1527-25
Lead Wire, V-Brown, 36"	0012-00-1527-21
ECG IEC (INTERNATIONAL) LEAD WIRES	
Lead Wire, N-Black, 18"	0012-00-1527-10
Lead Wire, R-Red, 18"	0012-00-1527-07
Lead Wire, C-White, 18"	0012-00-1527-06
Lead Wire, F-Green, 18"	0012-00-1527-08
Lead Wire, L-Yellow, 18"	0012-00-1527-09
Lead Wire, N-Black, 24"	0012-00-1527-20
Lead Wire, R-Red, 24"	0012-00-1527-17
Lead Wire, C-White, 24"	0012-00-1527-16
Lead Wire, F-Green, 24"	0012-00-1527-18
Lead Wire, L-Yellow, 24"	0012-00-1527-19
Lead Wire, N-Black, 36"	0012-00-1527-30
Lead Wire, R-Red, 36"	0012-00-1527-27
Lead Wire, C-White, 36"	0012-00-1527-26
Lead Wire, F-Green, 36"	0012-00-1527-28
Lead Wire, L-Yellow, 36"	0012-00-1527-29

WARNING: The Telepack should not be used adjacent to or stacked with other equipment. If adjacent or stacked use is necessary, the Telepack should be observed to verify normal operation in the configuration in which it will be used.

10.7 Troubleshooting

This section lists some of the potential messages and issues that may occur while using a Telepack device.

MESSAGE/ISSUE *	REASON	SOLUTION
Telepack/LED's not turning on	Batteries are not installed correctly, batteries are depleted, or batteries corroded.	Visually inspect the battery compartment for any foreign object. Replace the batteries.
Telepack not transmitting data to the Panorama Central Station.	Batteries are discharged.	Press the CHECK button to verify that the batteries are depleted. Replace as necessary.
Flashing Battery Status LED indicator light	Batteries in the Telepack are weakening.	Replace batteries
The message Error: Could not receive data is displayed, while attempting to program the Telepack	Telepack is not connected properly, or the Panorama Central Station is unable to detect the Telepack.	Verify that the service mode cable is properly connected to the device. Retry programming. Check batteries.
Unlit ECG Lead LED indicator light	Telepack has no lead connectivity.	Connect the electrode. Check batteries.
Communications Lost	Telepack's radio signal is out of range with the wireless network.	For Telepack-2.4, verify the Telepack is within 100 feet of a network access point. For Telepack-608, verify the Telepack is within 30 feet of a network access point. Check batteries.
Flashing Link Status LED indicator light	Telepack is not communicating with the Panorama Central Station.	Verify that Device ID is registered on the Panorama Central Station. Verify that Panorama Central Station is functioning. Additionally for Telepack-2.4, verify that the Access Point and Network Name are properly configured on the Telepack.
	For Telepack-608, the unit may be defective.	Contact Technical Support.
SpO ₂ waveform not displayed at the Panorama Central Station patient tile	SpO ₂ waveform has not been selected in the Display tab.	Go to the Display tab and select the SpO ₂ waveform from the Parameter list to display in the Waveform 2 position. For additional information regarding the Display tab, refer to "Configuring the Display Tab" on page 5-47.
	SpO ₂ module is not properly connected to the Telepack.	Power down the Telepack and reconnect the SpO ₂ module to the Telepack.
	Battery cap on the Telepack was not secured.	Verify that the Telepack battery cap is secured.

MESSAGE/ISSUE *	REASON	SOLUTION
SpO₂ Check Sensor	An SpO ₂ sensor issue was detected.	Select the digital tile or waveform tile area, or select the View button to acknowledge the technical event.

* *Messages are shown in all bold text.*

User Maintenance

This section of the manual outlines proper maintenance of the Panorama Central Station touch screen and Telepack device.

- Touch Screen User Maintenance
- Telepack User Maintenance

11.1 Touch Screen User Maintenance

The Panorama display uses a touch screen overlay for more simple navigation of the system. (A mouse can also be used for point-and-click navigation of the system.)

For instructions on turning the touch screen on and off, refer to “Touch Screen Tab” on page 9-4.

11.1.1 Care and Cleaning of the Touch Screen

For the best performance, it is recommended that the Panorama Central Station touch screen be kept clean. Observe the following precautions when cleaning the touch screen:

CAUTION: To avoid potential system issues, deactivate the touch screen before cleaning.

CAUTION: DO NOT spray glass cleaner directly on a display as it could possibly leak inside a non-sealed unit and cause damage.

CAUTION: Follow your hospital protocol for handling of blood and body fluids.

- Always remember to use a cloth or towel to apply glass cleaner to the touch screen.
- Any standard glass cleaner can be used to clean the touch screen. DO NOT use abrasive cleaning materials to clean a touch screen. DO NOT use alcohol or solvents containing chlorinated hydrocarbons.
- Remove fingerprints and stains by using a liquid lens cleaner and a soft cloth.
- Use a fine soft-hair brush to carefully brush away dust and dirt particles.

11.2 Telepack User Maintenance

The following sections provide information about storing and cleaning the Telepack device and the Nonin SpO₂ module.

11.2.1 Storing the Telepack

When not in use, carefully store the Telepack by wrapping the lead set loosely around the casing of the Telepack device, or with the lead set attached and hanging freely. Do not wrap the lead set tightly around the casing of the Telepack as it may damage the wires.

CAUTION: Ensure that the batteries are removed when the Telepack is being stored.

To remove the batteries, twist the endcap of the battery compartment in a counter-clockwise direction. Removing the batteries helps preserve battery life and could prevent potential damage to the Telepack due to battery leakage.

NOTE: The Telepack remains on until the batteries are removed or depleted.

The Telepack has been tested and found to comply with the limits for a Class B digital device, pursuant to part 15 of the FCC Rules. These limits are designed to provide reasonable protection against harmful interference in a residential installation.

The Telepack generates, uses and can radiate radio frequency energy and if not installed and used in accordance with the instructions, may cause harmful interference to radio communications. However, there is no guarantee that interference will not occur in a particular installation.

If the Telepack does cause harmful interference to radio or television reception, which can be determined by turning the Telepack off and on, the user is encouraged to try and correct the interference by one or more of the following measures:

- Reorient or relocate the receiving antenna.
- Increase the separation between the equipment and receiver.
- Consult the dealer or an experienced radio/TV technician for help.

11.2.2 Cleaning and Disinfecting the Telepack Device

The information in this section pertains to cleaning and disinfecting the Telepack and its accessories. The components that need to be cleaned and disinfected are:

- Telepack device
- Battery compartment
- ECG Lead sets
- Nonin SpO₂ module
- SpO₂ Finger Clip Sensor

NOTE: The Telepack should be cleaned and disinfected before and after each patient's use.

The solutions used to clean the Telepack should be compatible with the cleaning solutions used to clean the ECG lead sets, if they are going to remain attached while the Telepack is cleaned. If the cleaning solution is not compatible, ensure that the ECG leads do not come in contact with the cleaning solution used to clean the Telepack. Only hospital-approved disinfecting procedures like those recommended by AAMI or AORN should be used to disinfect the Telepack unit.

The cleaning solutions that can be used are:

- Soap and water
- Glutaraldehyde 2% (for example, Cidex)
- Dilute chlorine bleach (sodium hypochlorite), 10% solution, freshly prepared in past 24 hours
- Isopropyl alcohol 70%
- Ethyl alcohol

Guidelines for Cleaning the Telepack

- Remove the batteries, and reattach the end cap of the battery compartment firmly. Clean the empty Telepack using a cloth moistened with cleaning solution, by gently wiping the outside of the Telepack.
- Remove the ECG lead wire from the device to clean around the ECG connector.

NOTE: Do not immerse the Telepack in the cleaning solution.

- Any excess cleaning solution should be wiped away with a cloth moistened with distilled water.
- A lint free cloth should be used to dry the Telepack unit thoroughly.

11.2.2.1 Cleaning the Battery Compartment

To clean the battery compartment, follow these guidelines:

- Remove the batteries from the battery compartment by twisting the endcap in a counter-clockwise direction. Visually inspect for fluids or foreign matter.
- Use a gauze pad or long handle swab moistened with soap, water or alcohol to clean the battery compartment.
- Excess cleaning solution should be wiped away with a cloth moistened with distilled water.
- A lint free cloth should be used to wipe the inside of the battery compartment. Air dry the battery compartment prior to re-inserting the batteries.

NOTE: Ensure that the battery contact leads and the battery compartment are dry prior to re-inserting the batteries for use.

11.2.2.2 Cleaning the ECG Lead Sets

To clean the ECG lead sets, use any one of the following cleaning solutions:

- Soap and water
- Glutaraldehyde 2% (for example, Cidex)
- Dilute chlorine bleach (sodium hypochlorite), 10% solution, freshly made in past 24 hours
- Ethyl Alcohol 30% (for example, green soap tincture)

To clean the ECG lead sets, remove them from the Telepack, and follow these guidelines:

- Use the cleaning solution to wipe and rinse the lead set.
- The cleaning solution should be wiped away with a cloth moistened with distilled water.
- A lint free cloth should be used to dry the lead set thoroughly.

WARNING: The Telepack should not be used adjacent to or stacked with other equipment. If adjacent or stacked use is necessary, the Telepack should be observed to verify normal operation in the configuration in which it will be used.

Sterilization of the Lead Sets

CAUTION: Prior to sterilization, lead sets must be removed from the Telepack. The Telepack and/or the Telepack with Nonin SpO₂ must not be sterilized.

Use EtO to sterilize the leadsets. The sterilization should be performed by following the hospital-approved procedure for EtO sterilization, such as those recommended by AAMI. The leadsets remain effective up to 10 exposures to EtO sterilization cycles.

NOTE: Damage to the lead sets will result if steam or gamma radiation is used for the sterilization process.

11.2.3 Cleaning the SpO₂ Module

In the event that the SpO₂ Module becomes soiled, a cleaning plug (P/N 0003-00-0055) should be used to cover the serial connector on the SpO₂ Module before it is cleaned.

CAUTION: Use the designated cleaning plug (P/N 0003-00-0055) when cleaning and disinfecting the Nonin SpO₂ module. If fluids enter the device, it may affect the functionality of the module or render it unusable.

Approved Cleaning Solutions

Please refer to the approved cleaning solutions described in “Cleaning and Disinfecting the Telepack Device” on page 11-3.

Inserting the Cleaning Plug

1. Carefully cover the connector by aligning the cleaning plug with the lower portion of the SpO₂ Module.

2. Press downward while angling the top arm of the plug into the shallow circular recess.

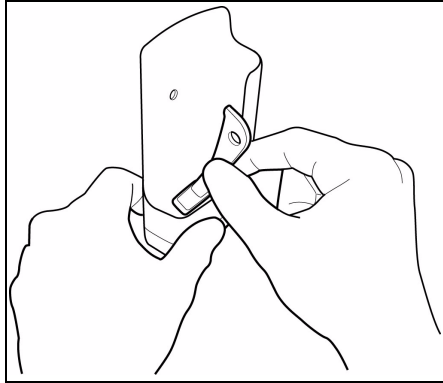

FIGURE 11-1 Inserting the Cleaning Plug

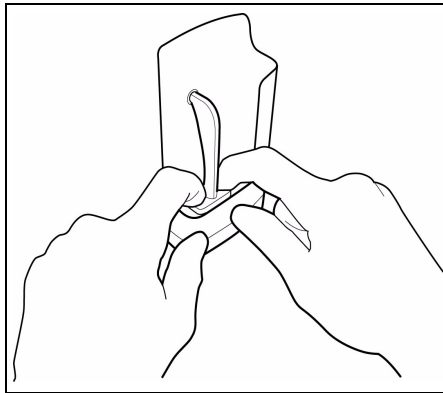

FIGURE 11-2 Securing the Cleaning Plug

NOTE: The cleaning plug should remain in place during cleaning.

Removing the Cleaning Plug

- Remove the cleaning plug by pulling the tip of the top arm from the recess in the SpO₂ module.

11.2.4 Cleaning the SpO₂ Finger Clip Sensor

Clean the sensor with a soft cloth dampened with a mild detergent or isopropyl alcohol. Ensure that all tape residue is removed. To ensure proper functioning of the finger clip sensor, do not:

- pour or spray any liquid on the sensor
- immerse in liquid
- use abrasive cleaning materials to clean

11.2.5 Disposal of the Telepack Device

Adhere to the following guidelines when disposing of any Telepack device and its accessories.

- The Telepack should be disposed of in a manner adhering to local or country regulations regarding disposal of electronic and computer accessories.
- If your state/country laws recommend recycling, you can dispose of the device by following the recycling program offered by state/federal run agencies.

11.2.6 Disposing of Batteries

Adhere to the following note when disposing the batteries.

NOTE: **The Telepack batteries used may be subject to local regulations regarding disposal. At the end of the battery life, never dispose of the batteries in a fire. Batteries should be disposed of in accordance with any local regulations.**

This page intentionally left blank.

Parameter Specifications

This section is for reference only. The Parameter Specifications section lists the allowable range specifications for all of the parameters measured by the Panorama Central Station and the invalidation of parameter data. It includes the following items:

- Parameter Specifications
- Invalid Data Display

12.1 Parameter Specifications

The parameters displayed on the Panorama Central Station are dependent on the type of equipment connected to the Panorama system.

12.1.1 Heart Rate: HR

The Heart Rate parameter obtains data from ECG and IBP sources.

Unit of Measure: Beats Per Minute (bpm)

Resolution: 1 bpm

Heart Rate Source: ECG

PATIENT SIZE	MINIMUM VALUE (bpm)	MAXIMUM VALUE (bpm)
Neonate	30	350
Pediatric	30	300
Adult	30	300

The Panorama Central Station displays ECG waveforms when using 3-wire, 5-wire, and 12 lead cable. The ECG leads available at the Panorama Central Station are dependent on the lead cable connected to the patient.

LEAD	WAVEFORM LEADS AVAILABLE
3-wire lead set	I, II, III
5-wire lead set	I, II, III, aVR, aVL, aVF, V
6-wire lead set	I, II, III, aVR, aVL, aVF, Vx, Vy
View 12™ card	I, II, III, aVR, aVL, aVF, V1, V2, V3, V4, V5, V6
Unit of Measure:	mV

Heart Rate Source: IBP

PATIENT SIZE	MINIMUM VALUE (bpm)	MAXIMUM VALUE (bpm)
Neonate	30	350
Pediatric	30	300
Adult	30	300

12.1.2 Respiration: Resp

The Respiration parameter obtains data from ECG, CO₂ or Gas Module sources.

Unit of Measure: Respirations Per Minute (rpm)

Resolution: 1 rpm

Respiration Source: ECG Thoracic Impedance

PATIENT SIZE	MINIMUM VALUE (rpm)	MAXIMUM VALUE (rpm)
Neonate	4	199
Pediatric	4	199
Adult	4	199

Respiration Source: CO₂

PATIENT SIZE	MINIMUM VALUE (rpm)	MAXIMUM VALUE (rpm)
Neonate	0	150
Pediatric	0	150
Adult	0	150

Respiration Source: Gas Module

PATIENT SIZE	MINIMUM VALUE (rpm)	MAXIMUM VALUE (rpm)
Neonate	4	60
Pediatric	4	60
Adult	4	60

The Panorama Central Station supports respiration waveforms.

12.1.3

NIBP

The NIBP parameter includes measurements for the Systolic (Sys), Diastolic (Dia), Mean and Elapsed Time (ET).

Unit of Measure: mmHg

Resolution: 1 mmHg

ET

Unit of Measure: minute

Resolution: 1 minute

NIBP (Sys)

PATIENT SIZE	MINIMUM VALUE (mmHg)	MAXIMUM VALUE (mmHg)
Neonate	45	120
Pediatric	55	160
Adult	55	235

NIBP (Dia)

PATIENT SIZE	MINIMUM VALUE (mmHg)	MAXIMUM VALUE (mmHg)
Neonate	20	100
Pediatric	30	150
Adult	30	200

NIBP Mean

PATIENT SIZE	MINIMUM VALUE	MAXIMUM VALUE
Neonate	mmHg greater than the NIBP (Dia) value	mmHg less than the NIBP (Sys) value
Pediatric	mmHg greater than the NIBP (Dia) value	mmHg less than the NIBP (Sys) value
Adult	mmHg greater than the NIBP (Dia) value	mmHg less than the NIBP (Sys) value

NIBP (ET)

PATIENT SIZE	MINIMUM VALUE (MIN.)	MAXIMUM VALUE (MINUTES)
Neonate	0	999
Pediatric	0	999
Adult	0	999

12.1.4

SpO₂

The SpO₂ parameter includes measurements from Masimo SET[®] and Nellcor[®] SpO₂ sensors.

Unit of Measure: %

Resolution: 1%

PATIENT SIZE	MINIMUM VALUE (%)	MAXIMUM VALUE (%)
Neonate	–	100
Pediatric	–	100
Adult	–	100

The Panorama Central Station supports SpO₂ waveforms.

12.1.5 Nonin SpO₂

The Nonin SpO₂ parameter includes measurements from Nonin sensors.

Unit of Measure: %

Resolution: 1%

PATIENT SIZE	MINIMUM VALUE (%)	MAXIMUM VALUE (%)
Neonate	N/A	N/A
Pediatric	N/A	N/A
Adult	–	100

The Panorama Central Station supports SpO₂ waveforms.

12.1.6 IBP: mmHg

The Panorama Central Station supports up to four invasive blood pressure parameters. The measurements shown for each pressure include Systolic (Sys), Diastolic (Dia) and Mean.

NOTE: IBP parameter labels include IBP, Art, UA, LV, PA, CVP, ICP, LA, and RA. The label used is based on the label selected at the bedside monitor.

Resolution: 1 mmHg

IBP (Sys)

PATIENT SIZE	MINIMUM VALUE (mmHg)	MAXIMUM VALUE (mmHg)
Neonate	-30	300
Pediatric	-30	300
Adult	-30	300

IBP (Dia)

PATIENT SIZE	MINIMUM VALUE (mmHg)	MAXIMUM VALUE (mmHg)
Neonate	-30	300
Pediatric	-30	300
Adult	-30	300

IBP Mean

PATIENT SIZE	MINIMUM VALUE (mmHg)	MAXIMUM VALUE (mmHg)
Neonate	-30	300
Pediatric	-30	300
Adult	-30	300

The Panorama Central Station supports IBP waveforms. The Panorama Central Station will not display an IBP waveform if the IBP cable is not connected to the system.

12.1.7 CO₂

The Panorama Central Station supports the mmHg, kPa and % measurements for CO₂.

NOTE: The unit of measure shown for CO₂ is based on the selection made at the bedside monitor.

Units of Measure: mmHg, %, kPa

Resolution: 1 mmHg, 1 %, 1 kPa

INSP/ET CO₂

PATIENT SIZE	MINIMUM VALUE (mmHg)	MAXIMUM VALUE (mmHg)
Neonate	0	99
Pediatric	0	99
Adult	0	99

PATIENT SIZE	MINIMUM VALUE (%)	MAXIMUM VALUE (%)
Neonate	0	13
Pediatric	0	13
Adult	0	13

PATIENT SIZE	MINIMUM VALUE (KPA)	MAXIMUM VALUE (KPA)
Neonate	0	13
Pediatric	0	13
Adult	0	13

The Panorama Central Station supports a CO₂ waveform.

12.1.8 O₂

The Panorama Central Station supports INSP/ET O₂.

Unit of Measure: %

Resolution: 1 %

12.1.9 INSP/ET O₂

PATIENT SIZE	MINIMUM VALUE (%)	MAXIMUM VALUE (%)
Neonate	0	99
Pediatric	0	99
Adult	0	99

The Panorama Central Station supports an O₂ waveform.

12.1.10 N₂O

The Panorama Central Station supports INSP/ET N₂O.

Unit of Measure: %

Resolution: 1 %

INSP/ET N₂O

PATIENT SIZE	MINIMUM VALUE (%)	MAXIMUM VALUE (%)
Neonate	0	99
Pediatric	0	99
Adult	0	100

12.1.11 Anesthetic Agents: Iso, Enf, Des, Sev, Hal, Agent

The Panorama Central Station supports the INSP and ET measurements of the Isoflurane (Iso), Enflurane (Enf), Desflurane (Des), Sevoflurane (Sev), and Halothane (Hal) anesthetic agents.

NOTE: The Panorama Central Station will display general Agent values when the Gas Module cannot identify the agent.

The Anesthetic Agent label used is based on the labeling provided by the bedside monitor.

Unit of Measure: %

Resolution: 1%

Iso, Enf and Hal INSP/ET Ranges

PATIENT SIZE	MINIMUM VALUE (%)	MAXIMUM VALUE (%)
Neonate	0	Not Applicable
Pediatric	0	Not Applicable
Adult	0	Not Applicable

Des INSP/ET Ranges

PATIENT SIZE	MINIMUM VALUE (%)	MAXIMUM VALUE (%)
Neonate	0	Not Applicable
Pediatric	0	Not Applicable
Adult	0	Not Applicable

Sev INSP/ET Ranges

PATIENT SIZE	MINIMUM VALUE (%)	MAXIMUM VALUE (%)
Neonate	0	Not Applicable
Pediatric	0	Not Applicable
Adult	0	Not Applicable

- The Panorama Central Station supports Iso, Enf, Sev, Hal and Des waveforms.
- The Panorama Central Station displays a Generic Agent waveform when the Gas Module cannot identify a specific agent.

12.1.12 Premature Ventricular Contraction (PVC)

The Panorama Central Station supports PVC data.

Unit of Measure: PVC/min
Resolution: 1 PVC/min

PATIENT SIZE	LEADS	MINIMUM VALUE	MAXIMUM VALUE
Neonate	3 lead, 5 lead, or 12 lead	Not Applicable	Not Applicable
Pediatric	3 lead, 5 lead, or 12 lead	0 PVC/min	Less than the Current HR value (PVCs/min)
Adult	3 lead, 5 lead, or 12 lead	0 PVC/min	Less than the Current HR value (PVCs/min)

12.1.13 Temp: T1, T2, T3, Delta T, and T Blood

The Panorama Central Station supports five temperature measurements.

Units of Measure: F° and C°
Resolution: 0.1 F° and 0.1 C°

T1, T2, and T3

PATIENT SIZE	MINIMUM VALUE (F°)	MAXIMUM VALUE (F°)
Neonate	59	113
Pediatric	59	113
Adult	59	113

PATIENT SIZE	MINIMUM VALUE (C°)	MAXIMUM VALUE (C°)
Neonate	15	45
Pediatric	15	45
Adult	15	45

NOTE: T3 is currently supported by the V Series only.

Delta T Values

PATIENT SIZE	MINIMUM VALUE (F°)	MAXIMUM VALUE (F°)
Neonate	0	9.9
Pediatric	0	9.9
Adult	0	9.9

PATIENT SIZE	MINIMUM VALUE (C°)	MAXIMUM VALUE (C°)
Neonate	0	5.5
Pediatric	0	5.5
Adult	0	5.5

T Blood Values

PATIENT SIZE	MINIMUM VALUE (F°)	MAXIMUM VALUE (F°)
Neonate	Not Applicable	Not Applicable
Pediatric	63.7	109.1
Adult	63.7	109.1

PATIENT SIZE	MINIMUM VALUE (C°)	MAXIMUM VALUE (C°)
Neonate	Not Applicable	Not Applicable
Pediatric	17.5	43
Adult	17.5	43

12.1.14

ST

The ST parameter provides an ST measurement using ECG leads to acquire data.

PARAMETER LABELS

3-wire lead set	ST - I, ST - II, ST - III
5-wire lead set	ST - I, ST - II, ST - III, ST - aVR, ST - aVL, ST - aVF, ST - V
6-wire lead set	ST - I, ST - II, ST - III, ST - aVR, ST - aVL, ST - aVF, ST - Vx, ST - Vy
View 12™ card	ST - I, ST - II, ST - III, ST - aVR, ST - aVL, ST - aVF, ST - V1, ST - V2, ST - V3, ST - V4, ST - V5, ST - V6
Unit of Measure:	mm
Resolution:	0.1 mm

PATIENT SIZE	MINIMUM VALUE (MM)	MAXIMUM VALUE (MM)
Neonate	Not Applicable	Not Applicable
Pediatric	-10.0	10.0
Adult	-10.0	10.0

NOTE: A (C) next to an ST measurement indicates that the value represents a Current measurement.

NOTE: An (R) next to an ST measurement indicates that the value represents a Reference measurement.

12.1.15 Cardiac Output

Unit of Measure: lpm
Resolution: 0.1 lpm

PATIENT SIZE	MINIMUM VALUE (LPM)	MAXIMUM VALUE (LPM)
Adult	0.2	20.0

12.1.16 Cardiac Index

Unit of Measure: lpm/m²
Resolution: 0.1 lpm/m²

PATIENT SIZE	MINIMUM VALUE (LPM/M ²)	MAXIMUM VALUE (LPM/M ²)
Adult	0.1	20.0

12.1.17 Continous Cardiac Output (CCO)

Unit of Measure: lpm
Resolution: 0.1 lpm

PATIENT SIZE	MINIMUM VALUE (LPM)	MAXIMUM VALUE (LPM)
Pediatric	0.2 (non-DPM)	25.0 (non-DPM)
	1.0 (DPM)	20.0 (DPM)
Adult	0.2 (non-DPM)	25.0 (non-DPM)
	1.0 (DPM)	20.0 (DPM)

12.1.18 Continous Cardiac Output STAT (CCO STAT)

Unit of Measure: lpm
Resolution: 0.1 lpm

PATIENT SIZE	MINIMUM VALUE (LPM)	MAXIMUM VALUE (LPM)
Pediatric	0.2 (non-DPM)	25.0 (non-DPM)
	1.0 (DPM)	20.0 (DPM)
Adult	0.2 (non-DPM)	25.0 (non-DPM)
	1.0 (DPM)	20.0 (DPM)

12.1.19 Continous Cardiac Index (CCI)

Unit of Measure: lpm
Resolution: 0.1 lpm

PATIENT SIZE	MINIMUM VALUE (LPM)	MAXIMUM VALUE (LPM)
Pediatric	0.2	25.0
Adult	0.2	25.0

12.1.20 Continous Cardiac Index STAT (CCI STAT)

Unit of Measure: lpm
Resolution: 0.1 lpm

PATIENT SIZE	MINIMUM VALUE (LPM)	MAXIMUM VALUE (LPM)
Pediatric	0.2	25.0
Adult	0.2	25.0

12.1.21 System Vascular Resistance (SVR)

Unit of Measure: dynes*sec/cm⁵
Resolution: 1 dynes*sec/cm⁵

PATIENT SIZE	MINIMUM VALUE (DYNES*SEC/CM⁵)	MAXIMUM VALUE (DYNES*SEC/CM⁵)
Pediatric	0	3000
Adult	0	3000

12.1.22 System Vascular Resistance Index (SVRI)

Unit of Measure: dynes*sec/cm⁵/m²
Resolution: 1 dynes*sec/cm⁵/m²

PATIENT SIZE	MINIMUM VALUE (DYNES*SEC/CM⁵/M²)	MAXIMUM VALUE (DYNES*SEC/CM⁵/M²)
Pediatric	0	6000
Adult	0	6000

12.1.23 Mixed Venous Saturation (SvO₂)

Unit of Measure: %
Resolution: 1%

PATIENT SIZE	MINIMUM VALUE (%)	MAXIMUM VALUE (%)
Pediatric	0	99
Adult	0	99

12.1.24 Central Venous Oxygen Saturation (ScvO₂)

Unit of Measure: %
Resolution: 1%

PATIENT SIZE	MINIMUM VALUE (%)	MAXIMUM VALUE (%)
Pediatric	10	99
Adult	10	99

12.1.25 Pulmonary Artery Wedge Pressure (PAWP)

Unit of Measure: mmHg
Resolution: 1 mmHg

PATIENT SIZE	MINIMUM VALUE (mmHg)	MAXIMUM VALUE (mmHg)
Pediatric	-30	300
Adult	-30	300

12.1.26 Battery Percentage

Unit of Measure: %
Resolution: 1 %

PATIENT SIZE	MINIMUM VALUE	MAXIMUM VALUE
Adult	5 %	100 %

12.2 Invalid Data Display

The Panorama Central Station uses dashes (--), Xs (XX) or a straight line (waveform) to show invalid data.

Dashes (--) Digital Data

Digital data is replaced with dashes (--) for the following reasons:

- Data is above the maximum value
- Data is below the minimum value
- Parameter is not available
- Lead or a sensor is off
- Sensor is not zeroed
- Parameter is zeroing
- Measurement has not been taken
- Measurement is being taken
- Measurement has timed out
- Measurement is being retried
- Parameter is turned off
- View 12™ card is relearning
- PVC/min counter reset
- Gas module or the source agent is occluded
- Gas module or the source agent is purging
- Gas module is turned off
- ST license is not available
- Learning ST Values

Xs (XX) Digital Data

Digital data is replaced with Xs (XX) for the following reasons:

- IBP parameter is not zeroed
- NIBP parameter failed to obtain a reading

Straight Line (Waveforms)

Waveform data is replaced with a continuous straight line for the following reasons:

- ECG leads are disconnected
- ECG cable is not connected to the system
- Respiration parameter is disabled at the bedside monitor and the source is ECG
- Respiration parameter is using a View 12™ card at the bedside monitor and the source is ECG
- SpO₂ cable is connected but not in use
- IBP cable is connected but not zeroed or is zeroing
- CO₂ filter line is not in use or is zeroing
- O₂ parameter is not in use
- Gas module is connected but the agent is not in use
- Gas module is connected but the agent is not detected

The alarms available at the Panorama Central Station are dependent on the patient monitoring devices in use and on how the alarm options are configured at the Panorama Central Station.

This section outlines the alarm types and briefly describes the events that cause alarm conditions.

- Physiological Alarms and Events
- Physiological Alarms and Events: Arrhythmias
- Technical Alarms and Events
- System Event Messages and Error Codes

13.1 Physiological Alarms and Events

The Panorama Central Station uses physiological alarms to indicate that a patient's physiological alarm thresholds have been violated.

13.1.1 Alarm Limit Settings

This section identifies high and low alarm limit settings, and available alarm priorities for each physiological alarm, by patient size. It also differentiates which alarm limit settings are available at each monitoring device.

ALARM	ALARM PRIORITY	ALARM LIMIT	NEONATE	PEDIATRIC	ADULT	DEVICES	
Heart Rate Units: bpm	1 or 2 Factory Default: 2	High Limit	Off, 100-350 Factory Default: 200	Off, 100-300 Factory Default: 180	Off, 60-250 Factory Default: 150	Passport 2, Passport V Spectrum/Spectrum OR, Telepack	
		Low Limit	Off, 30-200 Factory Default: 100	Off, 30-150 Factory Default: 80	Off, 30-120 Factory Default: 50		
	1 or 2 Factory Default: 2	High Limit	Off, 17-300 Factory Default: 200	Off, 17-300 Factory Default: 160	Off, 17-300 Factory Default: 120	DPM6/7	
		Low Limit	Off, 15-298 Factory Default: 100	Off, 15-298 Factory Default: 75	Off, 15-298 Factory Default: 50		
	1 or 2 Factory Default: 2	High Limit	Off, 50-350 Factory Default: 200 (other)	Off, 50-300 Factory Default: 180 (other)	Off, 50-300 Factory Default: 150 (other)	V Series	
		Low Limit	Off, 25-200 Factory Default: 90 (other)	Off, 25-200 Factory Default: 80 (other)	Off, 25-200 Factory Default: 50 (other)		
	1 or 2 Factory Default: 2	High Limit	N/A	N/A	Off, 60-250 Factory Default: 150	Telepack with Nonin SpO ₂ module	
		Low Limit	N/A	N/A	Off, 30-120 Factory Default: 50		
				NOTE:	When the central station language is configured for French, the Heart Rate (HR) high/low alarm limit cannot be turned Off.		
				NOTE:	When the selected device is a Telepack, the Low Heart Rate alarm will be called when the heart rate becomes invalid because the rate is underrange.		
Respiration Units: rpm	1, 2, and 3 Factory Default: 3	High Limit	Off, 30-200 Factory Default: Off	Off, 15-150 Factory Default: Off	Off, 10-100 Factory Default: Off	Passport 2, Passport V, Spectrum/Spectrum OR	
		Low Limit	Off, 5-50 Factory Default: 5	Off, 5-40 Factory Default: Off	Off, 5-30 Factory Default: Off		
	1, 2, and 3 Factory Default: 3	High Limit	Off, 2-100 Factory Default: 100	Off, 2-100 Factory Default: 30	Off, 2-100 Factory Default: 30	DPM6/7	
		Low Limit	Off, 0-98 Factory Default: 30	Off, 0-98 Factory Default: 8	Off, 0-98 Factory Default: 8		

N/A - Not Applicable

ALARM	ALARM PRIORITY	ALARM LIMIT	NEONATE	PEDIATRIC	ADULT	DEVICES
	1, 2, and 3 Factory Default: 3	High Limit	Off, 10-190 Factory Default: Off	Off, 10-190 Factory Default: Off	Off, 10-190 Factory Default: Off	V Series
		Low Limit	Off, 5-50 Factory Default: Off	Off, 5-50 Factory Default: Off	Off, 5-50 Factory Default: Off	
SpO ₂ Units: %	1 and 2 Factory Default: 2	High Limit	Off, 80-100% Factory Default: Off	Off, 80-100% Factory Default: Off	Off, 80-100% Factory Default: Off	Passport 2, Passport V, Spectrum/Spectrum OR
		Low Limit	50-99% Factory Default: 92%	50-99% Factory Default: 90%	50-99% Factory Default: 85%	
	1 and 2 Factory Default: 2	High Limit	Off, (Desat+1)-100% Factory Default: Off	Off, (Desat+1)-100% Factory Default: Off	Off, (Desat+1)-100% Factory Default: Off	DPM6/7
		Low Limit	Desat-99% Factory Default: 90%	Desat-99% Factory Default: 90%	Desat-99% Factory Default: 90%	
	1 and 2 Factory Default: 2	High Limit	Off, 75-101% Factory Default: 101%	Off, 75-101% Factory Default: 101%	Off, 75-101% Factory Default: 101%	V Series
		Low Limit	70-99% Factory Default: 92%	70-99% Factory Default: 90%	70-99% Factory Default: 88%	
SpO ₂ (Nonin) Units: %	1 and 2 Factory Default: 2	High Limit	N/A	N/A	Off, 80-100% Factory Default: Off	Telepack with Nonin SpO ₂ module
		Low Limit	N/A	N/A	50-99% Factory Default: 85%	
NOTE: The SpO₂ high/low alarm limit will always be displayed in the digital file portion of the Bedside tab All Waveforms view.						
IBPx Systolic Units: mmHg*	2 or 3 Factory Default: 3	High Limit	Off, 5-180 Factory Default: Off	Off, 5-240 Factory Default: Off	Off, 5-300 Factory Default: Off	Passport 2, Passport V, Spectrum/Spectrum OR
		Low Limit	Off, 0-130 Factory Default: Off	Off, 0-130 Factory Default: Off	Off, 0-150 Factory Default: Off	
IBPx Diastolic Units: mmHg*	2 or 3 Factory Default: 3	High Limit	Off, 0-70 Factory Default: Off	Off, 0-100 Factory Default: Off	Off, 0-140 Factory Default: Off	Passport 2, Passport V, Spectrum/Spectrum OR
		Low Limit	Off, 0-50 Factory Default: Off	Off, 0-100 Factory Default: Off	Off, 0-120 Factory Default: Off	
IBPx Mean Units: mmHg*	2 or 3 Factory Default: 3	High Limit	Off, 5-100 Factory Default: Off	Off, 5-100 Factory Default: Off	Off, 5-150 Factory Default: Off	Passport 2, Passport V, Spectrum/Spectrum OR
		Low Limit	Off, 2-50 Factory Default: Off	Off, 2-50 Factory Default: Off	Off, 2-100 Factory Default: Off	

N/A - Not Applicable

ALARM	ALARM PRIORITY	ALARM LIMIT	NEONATE	PEDIATRIC	ADULT	DEVICES
* All IBPx alarm limits apply to IBP1, IBP2, IBP3, IBP4, ART, UA, LV, PA, CVP, ICP, LA, and RA. The Panorama Central Station is capable of monitoring up to four IBP measurements.						
NOTE: x = 1, 2, 3 or 4 (IBP3 and 4 only available if Spectrum/Spectrum OR External Parameter Module (EPM) is installed)						
IBP1-8 Systolic Units: mmHg	2 or 3 Factory Default: 3	High Limit	Off, 5-300 Factory Default: Off	Off, 5-300 Factory Default: Off	Off, 5-300 Factory Default: Off	V Series
		Low Limit	Off, 0-150 Factory Default: Off	Off, 0-150 Factory Default: Off	Off, 0-150 Factory Default: Off	
IBP1-8 Diastolic Units: mmHg	2 or 3 Factory Default: 3	High Limit	Off, 5-200 Factory Default: Off	Off, 5-200 Factory Default: Off	Off, 5-200 Factory Default: Off	V Series
		Low Limit	Off, 0-150 Factory Default: Off	Off, 0-150 Factory Default: Off	Off, 0-150 Factory Default: Off	
IBP1-8 Mean Units: mmHg	2 or 3 Factory Default: 3	High Limit	Off, 5-200 Factory Default: Off	Off, 5-200 Factory Default: Off	Off, 5-200 Factory Default: Off	V Series
		Low Limit	Off, 0-150 Factory Default: Off	Off, 0-150 Factory Default: Off	Off, 0-150 Factory Default: Off	
Art, Art2, Ao, UAP, FAP, BAP, LV Systolic Units: mmHg	2 or 3 Factory Default: 3	High Limit	Off, 2-300 Factory Default: 90	Off, 2-300 Factory Default: 120	Off, 2-300 Factory Default: 160	DPM6/7
		Low Limit	Off, 0-298 Factory Default: 55	Off, 0-298 Factory Default: 70	Off, 0-298 Factory Default: 90	
Art, Art2, Ao, UAP, FAP, BAP, LV Diastolic Units: mmHg	2 or 3 Factory Default: 3	High Limit	Off, 2-300 Factory Default: 60	Off, 2-300 Factory Default: 70	Off, 2-300 Factory Default: 90	DPM6/7
		Low Limit	Off, 0-298 Factory Default: 20	Off, 0-298 Factory Default: 40	Off, 0-298 Factory Default: 50	
Art, Art2, Ao, UAP, FAP, BAP, LV Mean Units: mmHg	2 or 3 Factory Default: 3	High Limit	Off, 2-300 Factory Default: 70	Off, 2-300 Factory Default: 90	Off, 2-300 Factory Default: 110	DPM6/7
		Low Limit	Off, 0-298 Factory Default: 35	Off, 0-298 Factory Default: 50	Off, 0-298 Factory Default: 70	
PA Systolic Units: mmHg	2 or 3 Factory Default: 3	High Limit	Off, -4-120 Factory Default: 60	Off, -4-120 Factory Default: 60	Off, -4-120 Factory Default: 35	DPM6/7
		Low Limit	Off, -6-118 Factory Default: 24	Off, -6-118 Factory Default: 24	Off, -6-118 Factory Default: 10	

N/A - Not Applicable

ALARM	ALARM PRIORITY	ALARM LIMIT	NEONATE	PEDIATRIC	ADULT	DEVICES
PA Diastolic Units: mmHg	2 or 3 Factory Default: 3	High Limit	Off, -4-120 Factory Default: 4	Off, -4-120 Factory Default: 4	Off, -4-120 Factory Default: 60	DPM6/7
		Low Limit	Off, -6-118 Factory Default: -4	Off, -6-118 Factory Default: -4	Off, -6-118 Factory Default: 0	
PA Mean Units: mmHg	2 or 3 Factory Default: 3	High Limit	Off, -4-120 Factory Default: 26	Off, -4-120 Factory Default: 26	Off, -4-120 Factory Default: 20	DPM6/7
		Low Limit	Off, -6-118 Factory Default: 12	Off, -6-118 Factory Default: 12	Off, -6-118 Factory Default: 10	
ICP, CVP, LAP, RAP, UVP Mean Units: mmHg	2 or 3 Factory Default: 3	High Limit	Off, -8-40 Factory Default: 4	Off, -8-40 Factory Default: 4	Off, -8-40 Factory Default: 10	DPM6/7
		Low Limit	Off, -10-38 Factory Default: 0	Off, -10-38 Factory Default: 0	Off, -10-38 Factory Default: 0	
NIBP Systolic Units: mmHg	2 or 3 Factory Default: 3	High Limit	Off, 40-180 Factory Default: Off	Off, 40-180 Factory Default: Off	Off, 70-240 Factory Default: Off	Passport 2, Passport V, Spectrum/Spectrum OR
		Low Limit	Off, 15-130 Factory Default: Off	Off, 15-130 Factory Default: Off	Off, 15-150 Factory Default: Off	
NIBP Diastolic Units: mmHg	2 or 3 Factory Default: 3	High Limit	Off, 50-100 Factory Default: Off	Off, 50-100 Factory Default: Off	Off, 40-130 Factory Default: Off	Passport 2, Passport V, Spectrum/Spectrum OR
		Low Limit	Off, 10-50 Factory Default: Off	Off, 10-50 Factory Default: Off	Off, 30-120 Factory Default: Off	
NIBP Mean Units: mmHg	2 or 3 Factory Default: 3	High Limit	Off, 40-160 Factory Default: Off	Off, 50-180 Factory Default: Off	Off, 60-200 Factory Default: Off	Passport 2, Passport V, Spectrum/Spectrum OR
		Low Limit	Off, 10-70 Factory Default: Off	Off, 10-100 Factory Default: Off	Off, 40-140 Factory Default: Off	
NIBP Systolic Units: mmHg	2 or 3 Factory Default: 3	High Limit	Off, 45-135 Factory Default: 90	Off, 45-200 Factory Default: 120	Off, 45-270 Factory Default: 160	DPM6/7
		Low Limit	Off, 40-130 Factory Default: 40	Off, 40-195 Factory Default: 70	Off, 40-265 Factory Default: 90	
NIBP Diastolic Units: mmHg	2 or 3 Factory Default: 3	High Limit	Off, 15-100 Factory Default: 60	Off, 15-150 Factory Default: 70	Off, 15-210 Factory Default: 90	DPM6/7
		Low Limit	Off, 10-95 Factory Default: 20	Off, 10-145 Factory Default: 40	Off, 10-205 Factory Default: 50	

N/A - Not Applicable

ALARM	ALARM PRIORITY	ALARM LIMIT	NEONATE	PEDIATRIC	ADULT	DEVICES
NIBP Mean Units: mmHg	2 or 3 Factory Default: 3	High Limit	Off, 25-110 Factory Default: 70	Off, 25-165 Factory Default: 90	Off, 25-230 Factory Default: 110	DPM6/7
		Low Limit	Off, 20-105 Factory Default: 25	Off, 20-160 Factory Default: 50	Off, 20-225 Factory Default: 60	
NIBP Systolic Units: mmHg	2 or 3 Factory Default: 3	High Limit	Off, 30-100 Factory Default: Off	Off, 30-140 Factory Default: Off	Off, 40-240 Factory Default: Off	V Series
		Low Limit	Off, 20-90 Factory Default: Off	Off, 20-120 Factory Default: Off	Off, 30-150 Factory Default: Off	
NIBP Diastolic Units: mmHg	2 or 3 Factory Default: 3	High Limit	Off, 30-90 Factory Default: Off	Off, 30-120 Factory Default: Off	Off, 40-150 Factory Default: Off	V Series
		Low Limit	Off, 10-80 Factory Default: Off	Off, 20-100 Factory Default: Off	Off, 20-140 Factory Default: Off	
NIBP Mean Units: mmHg	2 or 3 Factory Default: 3	High Limit	Off, 30-90 Factory Default: Off	Off, 30-140 Factory Default: Off	Off, 60-200 Factory Default: Off	V Series
		Low Limit	Off, 10-70 Factory Default: Off	Off, 20-100 Factory Default: Off	Off, 20-150 Factory Default: Off	
INSP CO ₂ (mmHg)	2 or 3 Factory Default: 3	High Limit	Off, 5-30 Factory Default: Off	Off, 5-30 Factory Default: Off	Off, 5-30 Factory Default: Off	Passport 2, Passport V, Spectrum/Spectrum OR
		Low Limit	N/A	N/A	N/A	
INSP CO ₂ (%)	2 or 3 Factory Default: 3	High Limit	Off, 1-4 Factory Default: Off	Off, 1-4 Factory Default: Off	Off, 1-4 Factory Default: Off	Passport 2, Passport V, Spectrum/Spectrum OR
		Low Limit	N/A	N/A	N/A	
INSP CO ₂ (kPa)	2 or 3 Factory Default: 3	High Limit	Off, 1-4 Factory Default: Off	Off, 1-4 Factory Default: Off	Off, 1-4 Factory Default: Off	Passport 2, Passport V, Spectrum/Spectrum OR
		Low Limit	N/A	N/A	N/A	
INSP CO ₂ (mmHg)	2 or 3 Factory Default: 3	High Limit	Off, 5-30 Factory Default: 10	Off, 5-30 Factory Default: 10	Off, 5-30 Factory Default: 10	V Series
		Low Limit	N/A	N/A	N/A	
INSP CO ₂ (%)	2 or 3 Factory Default: 3	High Limit	Off, 1-4 Factory Default: 1	Off, 1-4 Factory Default: 1	Off, 1-4 Factory Default: 1	V Series
		Low Limit	N/A	N/A	N/A	
INSP CO ₂ (kPa)	2 or 3 Factory Default: 3	High Limit	Off, 1-4 Factory Default: 1	Off, 1-4 Factory Default: 1	Off, 1-4 Factory Default: 1	V Series
		Low Limit	N/A	N/A	N/A	

N/A - Not Applicable

ALARM	ALARM PRIORITY	ALARM LIMIT	NEONATE	PEDIATRIC	ADULT	DEVICES
FiCO ₂ (mmHg)	2 or 3 Factory Default: 3	High Limit	Off, 1-99 Factory Default: 4	Off, 1-99 Factory Default: 4	Off, 1-99 Factory Default: 4	DPM6/7
		Low Limit	N/A	N/A	N/A	N/A
FiCO ₂ (%)	2 or 3 Factory Default: 3	High Limit	Off, 0.4-13.0 Factory Default: 0.5	Off, 0.4-13.0 Factory Default: 0.5	Off, 0.4-13.0 Factory Default: 0.5	DPM6/7
		Low Limit	N/A	N/A	N/A	N/A
FiCO ₂ (kPa)	2 or 3 Factory Default: 3	High Limit	Off, 0.1-13.2 Factory Default: 0.5	Off, 0.1-13.2 Factory Default: 0.5	Off, 0.1-13.2 Factory Default: 0.5	DPM6/7
		Low Limit	N/A	N/A	N/A	N/A
ET CO ₂ (mmHg)	2 or 3 Factory Default: 3	High Limit	Off, 20-80 Factory Default: 60	Off, 20-80 Factory Default: 60	Off, 20-80 Factory Default: 60	Passport 2, Passport V, Spectrum/Spectrum OR
		Low Limit	Off, 5-50 Factory Default: Off	Off, 5- 0 Factory Default: Off	Off, 5-50 Factory Default: Off	
ET CO ₂ (%)	2 or 3 Factory Default: 3	High Limit	Off, 2-10 Factory Default: 8	Off, 2-10 Factory Default: 8	Off, 2-10 Factory Default: 8	Passport 2, Passport V, Spectrum/Spectrum OR
		Low Limit	Off, 1-6 Factory Default: Off	Off, 1-6 Factory Default: Off	Off, 1-6 Factory Default: Off	
ET CO ₂ (kPa)	2 or 3 Factory Default: 3	High Limit	Off, 2-10 Factory Default: 8	Off, 2-10 Factory Default: 8	Off, 2-10 Factory Default: 8	Passport 2, Passport V, Spectrum/Spectrum OR
		Low Limit	Off, 1-6 Factory Default: Off	Off, 1-6 Factory Default: Off	Off, 1-6 Factory Default: Off	
ET CO ₂ (mmHg)	2 or 3 Factory Default: 3	High Limit	Off, 3-99 Factory Default: 45	Off, 3-99 Factory Default: 50	Off, 3-99 Factory Default: 50	DPM6/7
		Low Limit	Off, 1-97 Factory Default: 30	Off, 1-97 Factory Default: 20	Off, 1-97 Factory Default: 15	
ET CO ₂ (%)	2 or 3 Factory Default: 3	High Limit	Off, 0.4-13.0 Factory Default: 5.9	Off, 0.4-13.0 Factory Default: 6.5	Off, 0.4-13.0 Factory Default: 6.5	DPM6/7
		Low Limit	Off, 0.1-12.8 Factory Default: 3.9	Off, 0.1-12.8 Factory Default: 2.6	Off, 0.1-12.8 Factory Default: 2.0	
ET CO ₂ (kPa)	2 or 3 Factory Default: 3	High Limit	Off, 0.4-13.2 Factory Default: 6.0	Off, 0.4-13.2 Factory Default: 6.7	Off, 0.4-13.2 Factory Default: 6.7	DPM6/7
		Low Limit	Off, 0.1-12.8 Factory Default: 4.0	Off, 0.1-12.8 Factory Default: 2.7	Off, 0.1-12.8 Factory Default: 2.0	

N/A - Not Applicable

ALARM	ALARM PRIORITY	ALARM LIMIT	NEONATE	PEDIATRIC	ADULT	DEVICES
ET CO ₂ (mmHg)	2 or 3 Factory Default: 3	High Limit	Off, 20-80 Factory Default: 60	Off, 20-80 Factory Default: 60	Off, 20-80 Factory Default: 60	V Series
		Low Limit	Off, 5-50 Factory Default: 15	Off, 5-50 Factory Default: 15	Off, 5-50 Factory Default: 15	
ET CO ₂ (%)	2 or 3 Factory Default: 3	High Limit	Off, 2-10 Factory Default: 10	Off, 2-10 Factory Default: 10	Off, 2-10 Factory Default: 10	V Series
		Low Limit	Off, 1-6 Factory Default: 2	Off, 1-6 Factory Default: 2	Off, 1-6 Factory Default: 2	
ET CO ₂ (kPa)	2 or 3 Factory Default: 3	High Limit	Off, 2-10 Factory Default: 10	Off, 2-10 Factory Default: 10	Off, 2-10 Factory Default: 10	V Series
		Low Limit	Off, 1-6 Factory Default: 2	Off, 1-6 Factory Default: 2	Off, 1-6 Factory Default: 2	
CCO (L/min) CCO STAT (L/min)	1, 2, or 3 Factory Default: 3	High Limit	NA	Off, 2.0 to 20.0 L/min. Factory Default: Off	Off, 2.0 to 20.0 L/min. Factory Default: Off	DPM 6/7 (CCO only)
		Low Limit	NA	Off, 1.0 to 19.0 L/min. Factory Default: Off	Off, 1.0 to 19.0 L/min. Factory Default: Off	
	1, 2, or 3 Factory Default: 3	High Limit	NA	Off, 2.0 to 20.0 L/min. Factory Default: Off	Off, 2.0 to 20.0 L/min. Factory Default: Off	V Series
		Low Limit	NA	Off, 1.0 to 19.0 L/min. Factory Default: Off	Off, 1.0 to 19.0 L/min. Factory Default: Off	
CCI (L/min) CCI STAT (L/min)	1, 2, or 3 Factory Default: 3	High Limit	NA	Off, 2.0 to 20.0 L/min. Factory Default: Off	Off, 2.0 to 20.0 L/min. Factory Default: Off	DPM 6/7 (CCI only)
		Low Limit	NA	Off, 1.0 to 19.0 L/min. Factory Default: Off	Off, 1.0 to 19.0 L/min. Factory Default: Off	
	1, 2, or 3 Factory Default: 3	High Limit	NA	Off, 2.0 to 20.0 L/min. Factory Default: Off	Off, 2.0 to 20.0 L/min. Factory Default: Off	V Series
		Low Limit	NA	Off, 1.0 to 19.0 L/min. Factory Default: Off	Off, 1.0 to 19.0 L/min. Factory Default: Off	
SVR (dynes*sec/cm ⁵)	1, 2, or 3 Factory Default: 3	High Limit	NA	Off, 500 to 5000 dynes*sec/cm ⁵ Factory Default: Off	Off, 500 to 5000 dynes*sec/cm ⁵ Factory Default: Off	DPM 6/7
		Low Limit	NA	Off, 0 to 2000 dyne*sec/cm ⁵ Factory Default: Off	Off, 0 to 2000 dynes*sec/cm ⁵ Factory Default: Off	

N/A - Not Applicable

ALARM	ALARM PRIORITY	ALARM LIMIT	NEONATE	PEDIATRIC	ADULT	DEVICES
	1, 2, or 3 Factory Default: 3	High Limit	NA	Off, 500 to 5000 dynes*sec/cm ⁵ Factory Default: Off	Off, 500 to 5000 dynes*sec/cm ⁵ Factory Default: Off	V Series
		Low Limit	NA	Off, 0 to 2000 dynes*sec/cm ⁵ Factory Default: Off	Off, 0 to 2000 dynes*sec/cm ⁵ Factory Default: Off	
SVRI (dynes*sec/cm ⁵ /M ²)	1, 2, or 3 Factory Default: 3	High Limit	NA	Off, 1000 to 9950 dynes*sec/cm ⁵ /M ² Factory Default: Off	Off, 1000 to 9950 dynes*sec/cm ⁵ /M ² Factory Default: Off	DPM 6/7
		Low Limit	NA	Off, 0 to 4000 dynes*sec/cm ⁵ /M ² Factory Default: Off	Off, 0 to 4000 dynes*sec/cm ⁵ /M ² Factory Default: Off	
	1, 2, or 3 Factory Default: 3	High Limit	NA	Off, 1000 to 9950 dynes*sec/cm ⁵ /M ² Factory Default: Off	Off, 1000 to 9950 dynes*sec/cm ⁵ /M ² Factory Default: Off	V Series
		Low Limit	NA	Off, 0 to 4000 dynes*sec/cm ⁵ /M ² Factory Default: Off	Off, 0 to 4000 dynes*sec/cm ⁵ /M ² Factory Default: Off	
SVO2 (%)	1, 2, or 3 Factory Default: 3	High Limit	NA	Off, 20 to 99% Factory Default: Off	Off, 20 to 99% Factory Default: Off	V Series
		Low Limit	NA	Off, 0 to 60% Factory Default: Off	Off, 0 to 60% Factory Default: Off	
T1/T2 T3 (V Series Only) Units: F°	2 or 3 Factory Default: 3	High Limit	Off, 95-110° Factory Default: Off	Off, 95-110° Factory Default: Off	Off, 95-110° Factory Default: Off	T1 Passport 2, Passport V, Spectrum/Spectrum OR
		Low Limit	Off, 80-100° Factory Default: Off	Off, 80-100° Factory Default: Off	Off, 80-100° Factory Default: Off	T2 optional for Spectrum/ Spectrum OR
	2 or 3 Factory Default: 3	High Limit	Off, 34-122° Factory Default: 102°	Off, 34-122° Factory Default: 102°	Off, 34-122° Factory Default: 102°	DPM6/7
		Low Limit	Off, 32-120° Factory Default: 97°	Off, 32-120° Factory Default: 97°	Off, 32-120° Factory Default: 97°	
	2 or 3 Factory Default: 3	High Limit	Off, 77-113° Factory Default: Off	Off, 77-113° Factory Default: Off	Off, 77-113° Factory Default: Off	V Series
		Low Limit	Off, 59-104° Factory Default: Off	Off, 59-104° Factory Default: Off	Off, 59-104° Factory Default: Off	

N/A - Not Applicable

ALARM	ALARM PRIORITY	ALARM LIMIT	NEONATE	PEDIATRIC	ADULT	DEVICES	
T1/T2 T3 (V Series Only) Units: C°	2 or 3 Factory Default: 3	High Limit	Off, 35-43° Factory Default: Off	Off, 35-43° Factory Default: Off	Off, 35-43° Factory Default: Off	T1 Passport 2, Passport V Spectrum/Spectrum OR	
		Low Limit	Off, 26-38° Factory Default: Off	Off, 26-38° Factory Default: Off	Off, 26-38° Factory Default: Off	T2 optional for Spectrum/ Spectrum OR	
	2 or 3 Factory Default: 3	High Limit	Off, 1.1-50.0° Factory Default: 39.0°	Off, 1.1-50.0° Factory Default: 39.0°	Off, 1.1-50.0° Factory Default: 39.0°	DPM6/7	
		Low Limit	Off, 0.1-49.0° Factory Default: 36.0°	Off, 0.1-49.0° Factory Default: 36.0°	Off, 0.1-49.0° Factory Default: 36.0°		
	2 or 3 Factory Default: 3	High Limit	Off, 25-45° Factory Default: Off	Off, 25-45° Factory Default: Off	Off, 25-45° Factory Default: Off	V Series	
		Low Limit	Off, 15-40° Factory Default: Off	Off, 15-40° Factory Default: Off	Off, 15-40° Factory Default: Off		
Delta T Units: F°	2 or 3 Factory Default: 3	High Limit	Off, 2-10° Factory Default: Off	Off, 2-10° Factory Default: Off	Off, 2-10° Factory Default: Off	Spectrum/Spectrum OR,	
		Low Limit	Off, 2-10° Factory Default: Off	Off, 2-10° Factory Default: Off	Off, 2-10° Factory Default: Off		
	2 or 3 Factory Default: 3	NOTE: Only available if Spectrum/Spectrum OR External Parameter Module (EPM) is installed and sensor is attached					
		High Limit	Off, 1-90° Factory Default: 4°	Off, 1-90° Factory Default: 4°	Off, 1-90° Factory Default: 4°	DPM6/7	
		Low Limit	N/A	N/A	N/A		
	2 or 3 Factory Default: 3	High Limit	Off, 1-10° Factory Default: Off	Off, 1-10° Factory Default: Off	Off, 1-10° Factory Default: Off	V Series	
Low Limit		N/A	N/A	N/A			
Delta T Units: C°	2 or 3 Factory Default: 3	High Limit	Off, 1-5° Factory Default: Off	Off, 1-5° Factory Default: Off	Off, 1-5° Factory Default: Off	Spectrum/Spectrum OR	
		Low Limit	Off, 1-5° Factory Default: Off	Off, 1-5° Factory Default: Off	Off, 1-5° Factory Default: Off		
	NOTE: Only available if Spectrum/Spectrum OR External Parameter Module (EPM) is installed and sensor is attached						

N/A - Not Applicable

ALARM	ALARM PRIORITY	ALARM LIMIT	NEONATE	PEDIATRIC	ADULT	DEVICES
	2 or 3 Factory Default: 3	High Limit	Off, 0.1-50.0° Factory Default: 2.0°	Off, 0.1-50.0° Factory Default: 2.0°	Off, 0.1-50.0° Factory Default: 2.0°	DPM6/7
		Low Limit	N/A	N/A	N/A	
	2 or 3 Factory Default: 3	High Limit	Off, 1-10° Factory Default: Off	Off, 1-10° Factory Default: Off	Off, 1-10° Factory Default: Off	V Series
		Low Limit	N/A	N/A	N/A	
T Blood Units: F°	2 or 3 Factory Default: 3	High Limit	N/A	Off, 95-110° Factory Default: Off	Off, 95-110° Factory Default: Off	Spectrum/Spectrum OR
		Low Limit	N/A	Off, 80-100° Factory Default: Off	Off, 80-100° Factory Default: Off	
		NOTE: Only available if Spectrum/Spectrum OR External Parameter Module (EPM) is installed and sensor is attached				
	2 or 3 Factory Default: 3	High Limit	N/A	Off, 95-110° Factory Default: Off	Off, 95-110° Factory Default: Off	V Series
		Low Limit	N/A	Off, 80-100° Factory Default: Off	Off, 80-100° Factory Default: Off	
T Blood Units: C°	2 or 3 Factory Default: 3	High Limit	N/A	Off, 35-43° Factory Default: Off	Off, 35-43° Factory Default: Off	Spectrum/Spectrum OR
		Low Limit	N/A	Off, 26-38° Factory Default: Off	Off, 26-38° Factory Default: Off	
		NOTE: Only available if Spectrum/Spectrum OR External Parameter Module (EPM) is installed and sensor is attached				
	2 or 3 Factory Default: 3	High Limit	N/A	Off, 35-43° Factory Default: Off	Off, 35-43° Factory Default: Off	V Series
		Low Limit	N/A	Off, 26-38° Factory Default: Off	Off, 26-38° Factory Default: Off	
ST Single Units: mm	1, 2 or 3 Factory Default: 2	High Limit	N/A	Off, 0.50 to 10.0 Factory Default: Off	Off, 0.50 to 10.0 Factory Default: Off	Passport 2, Passport V, Spectrum/Spectrum OR, Telepack, V Series
		Low Limit	N/A	Off, (-0.5) to (-10.0) Factory Default: Off	Off, (-0.5) to (-10.0) Factory Default: Off	

N/A - Not Applicable

ALARM	ALARM PRIORITY	ALARM LIMIT	NEONATE	PEDIATRIC	ADULT	DEVICES
ST Dual Units: mm	1, 2 or 3 Factory Default: 2	High Limit	N/A	Off, 0.50-10.0 Factory Default: Off	Off, 0.50-10.0 Factory Default: Off	Passport 2, Passport V, Spectrum/Spectrum OR, Telepack, V Series
		Low Limit	N/A	Off, (-0.5) - (-10.0) Factory Default: Off	Off, (-0.5) - (-10.0) Factory Default: Off	
PVC Units: PVCs/min	2 or 3 Factory Default: 3	High Limit	N/A	Off, 1-30 Factory Default: Off	Off, 1-30 Factory Default: Off	Passport 2, Passport V, Spectrum/Spectrum OR, Telepack
		Low Limit	N/A	N/A	N/A	
	2 or 3 Factory Default: 3	High Limit	N/A	Off, 1-10 Factory Default: Off	Off, 1-10 Factory Default: Off	DPM6/7
		Low Limit	N/A	N/A	N/A	
Apnea Delay Units: Seconds	2 or 3 Factory Default: 3	High Limit	10-20 Factory Default: 15	10-20 Factory Default: 15	10-60 Factory Default: 60	Passport 2, Passport V, Spectrum/Spectrum OR
		Low Limit	N/A	N/A	N/A	
	2 or 3 Factory Default: 3	High Limit	10, 15, 20, 25, 30, 35, 40 Factory Default: 20	10, 15, 20, 25, 30, 35, 40 Factory Default: 20	10, 15, 20, 25, 30, 35, 40 Factory Default: 20	DPM6/7
		Low Limit	N/A	N/A	N/A	
	2 or 3 Factory Default: 3	High Limit	10-20 Factory Default: 15	10-20 Factory Default: 15	10-60 Factory Default: 30	V Series
		Low Limit	N/A	N/A	N/A	

N/A - Not Applicable

13.1.2 Physiological Alarm Event Messages

This section lists the alarm messages that may appear at the Panorama Central Station when an Physiological alarm event occurs.

PARAMETER	PANORAMA CENTRAL STATION MESSAGES	REASON
Heart Rate (HR)	High Heart Rate Alarm Low Heart Rate Alarm	Current value is either equal to or higher/lower than the set alarm limits.
Respiration (ECG Thoracic Impedance, CO ₂ , and Gas Module)	High Respiration Rate Alarm Low Respiration Rate Alarm	Current value is either equal to or higher/lower than the set alarm limits.
SpO ₂ (Masimo SET [®] , Nellcor [®] , Nonin)	High SpO ₂ Alarm Low SpO ₂ Alarm	Current value is either equal to or higher/lower than the set alarm limits.
IBPx (Sys) Labels include: IBP1, IBP2, IBP3, IBP4, IBP5, IBP6, IBP7, IBP8, ART, UA, LV, PA, CVP, ICP, LA, RA	High IBPx Systolic Alarm Low IBPx Systolic Alarm	Current value is either equal to or higher/lower than the set alarm limits.
IBPx (Dia) Labels include: IBP1, IBP2, IBP3, IBP4, IBP5, IBP6, IBP7, IBP8, ART, UA, LV, PA, CVP, ICP, LA, RA	High IBPx Diastolic Alarm Low IBPx Diastolic Alarm	Current value is either equal to or higher/lower than the set alarm limits.
IBPx (Mean) Labels include: IBP1, IBP2, IBP3, IBP4, IBP5, IBP6, IBP7, IBP8, ART, UA, LV, PA, CVP, ICP, LA, RA	High IBPx Mean Alarm Low IBPx Mean Alarm	Current value is either equal to or higher/lower than the set alarm limits.
INSP CO ₂ (mmHg, %, kPa)	High CO ₂ Inspired Alarm	Current value is either equal to or higher than the set alarm limits.
ET CO ₂ (mmHg, %, kPa)	High CO ₂ ET Alarm Low CO ₂ ET Alarm	Current value is either equal to or higher/lower than the set alarm limits.
INSP O ₂	O ₂ Inspired Alarm	There has been a violation of the O ₂ Inspired alarm.
ET O ₂	O ₂ ET Alarm	There has been a violation of the O ₂ ET alarm.
INSP N ₂ O	N ₂ O Inspired Alarm	There has been a violation of the N ₂ O Inspired alarm.
ET N ₂ O	N ₂ O ET Alarm	There has been a violation of the N ₂ O ET alarm.
Agent	Agent Inspired Alarm	There has been a violation of the Agent Inspired alarm.
	Agent ET Alarm	There has been a violation of the Agent ET alarm.
INSP Iso	Agent Iso Inspired Alarm	There has been a violation of the Iso Inspired alarm.
ET Iso	Agent Iso ET Alarm	There has been a violation of the Iso ET alarm.

PARAMETER	PANORAMA CENTRAL STATION MESSAGES	REASON
INSP Enf	Agent Enf Inspired Alarm	There has been a violation of the Enf Inspired alarm.
ET Enf	Agent Enf ET Alarm	There has been a violation of the Enf ET alarm.
INSP Des	Agent Des Inspired Alarm	There has been a violation of the Des Inspired alarm.
ET Des	Agent Des ET Alarm	There has been a violation of the Des ET alarm.
INSP Sev	Agent Sev Inspired Alarm	There has been a violation of the Sev Inspired alarm.
ET Sev	Agent Sev ET Alarm	There has been a violation of the Sev ET alarm.
INSP Hal	Agent Hal Inspired Alarm	There has been a violation of the Hal Inspired alarm.
ET Hal	Agent Hal ET Alarm	There has been a violation of the Hal ET alarm.
NIBP (Sys)	High NIBP Sys Alarm Low NIBP Sys Alarm	Current value is either equal to or higher/lower than the set alarm limits.
NIBP (Dia)	High NIBP Dia Alarm Low NIBP Dia Alarm	Current value is either equal to or higher/lower than the set alarm limits.
NIBP (Mean)	High NIBP Mean Alarm Low NIBP Mean Alarm	Current value is either equal to or higher/lower than the set alarm limits.
CCI	High CCI Alarm Low CCI Alarm	Current value is either equal to or higher/lower than the set alarm limits.
CCI STAT	High CCI STAT Alarm Low CCI STAT Alarm	Current value is either equal to or higher/lower than the set alarm limits.
CCO	High CCO Alarm Low CCO Alarm	Current value is either equal to or higher/lower than the set alarm limits.
CCO STAT	High CCO STAT Alarm Low CCO STAT Alarm	Current value is either equal to or higher/lower than the set alarm limits.
SVO2	High SVO2 Alarm Low SVO2 Alarm	Current value is either equal to or higher/lower than the set alarm limits.
SVR	High SVR Alarm Low SVR Alarm	Current value is either equal to or higher/lower than the set alarm limits.
SVRI	High SVRI Alarm Low SVRI Alarm	Current value is either equal to or higher/lower than the set alarm limits.
T1 (F/C)	High Temp 1 Alarm Low Temp 1 Alarm	Current value is either equal to or higher/lower than the set alarm limits.
T2 (F/C)	High Temp 2 Alarm Low Temp 2 Alarm	Current value is either equal to or higher/lower than the set alarm limits.
T3 (F/C)	High Temp 3 Alarm Low Temp 3 Alarm	Current value is either equal to or higher/lower than the set alarm limits.
Delta T (F/C)	High Delta T Alarm Low Delta T Alarm	Current value either equal to or higher/lower than the set alarm limits.

PARAMETER	PANORAMA CENTRAL STATION MESSAGES	REASON
Temperature Label: ESO, NAS, REC, BLA, AXI, SKI	High ESO Alarm Low ESO Alarm High NAS Alarm Low NAS Alarm High REC Alarm Low REC Alarm High BLA Alarm Low BLA Alarm High AXI Alarm Low AXI Alarm High SKI Alarm Low SKI Alarm	Current value either equal to or higher/lower than the set alarm limits.
	ESO Sensor Failed NAS Sensor Failed REC Sensor Failed BLA Sensor Failed AXI Sensor Failed SKI Sensor Failed	Sensor has malfunctioned.
	ESO Not Calibrated/Zeroed NAS Not Calibrated/Zeroed REC Not Calibrated/Zeroed BLA Not Calibrated/Zeroed AXI Not Calibrated/Zeroed SKI Not Calibrated/Zeroed	Sensor has not been calibrated or zeroed.
T Blood (F/C)	Low T Blood Alarm High T Blood Alarm	Current value is either equal to or higher/lower than the set alarm limits.
ST Single	ST Single Alarm	Current value of one ST lead is either equal to or higher/lower than the set alarm limits. A separate ST Single alarm will be shown for each lead of ST that independently violates the alarm.
ST Dual	ST Dual Alarm	Current value for two or more ST leads are either equal to or higher/lower than the set alarm limits. A separate ST Dual alarm will be shown for every two leads of ST that independently violate the alarm.
Apnea	Apnea Alarm	Apneic episode is either equal to or longer than the set alarm limits.
PVC	High PVC Alarm	Current PVCs/per minute threshold is in violation.

13.2 Physiological Alarms and Events: Arrhythmias

This section lists the alarm messages that may appear at the Panorama Central Station when an Arrhythmia alarm occurs.

Arrhythmia Alarms

EVENT	ALARM PRIORITY	PANORAMA CENTRAL STATION MESSAGES	REASON
V-Tach ¹	1	V-Tach	The configured number of consecutive PVCs is reached at a rate equal to or greater than the V-Tach threshold. The range of the V-Tach heart rate is between 100 to 180 beats per minute. The range of the V-Tach threshold is 3-15 bpm.
V-Fib ¹	1	V-Fib	There is an absence of recognizable P, QRS or T waves.
Asystole ¹	1	Asystole	There are no QRS complexes detected for the configured time period in the absence of Ventricular Fibrillation. When using a View 12™ card, the time period range for an Asystole alarm is between three (3) and ten (10) seconds, and between three (3) and eight (8) seconds when using a 3 or 5-wire lead set.
Bigeminy	2,3 or Off Factory Default: 3	Bigeminy	There are three or more cycles of one PVC followed by a normal beat.
Couplet	2,3 or Off Factory Default: 3	Couplet	There are two consecutive PVCs detected between normal beats.
Irregular HR	2,3 or Off Factory Default: 3	Irregular HR	The measured variation in the R-R interval over a period of time exceeds a preset limit established by the arrhythmia algorithm.
Run	2,3 or Off Factory Default: 3	Run	There are a number of consecutive PVCs occurring at a rate that exceeds the configured V-Tach rate.
Trigeminy	2,3 or Off Factory Default: 3	Trigeminy	Three or more cycles of one PVC coupled to two normal beats are detected.
V-Rhythm	2,3 or Off Factory Default: 3	V-Rhythm	The number of consecutive PVCs is greater than two and the ventricular rate is less than the configured V-Tach threshold.
PVC	2,3 or Off Factory Default: 3	High PVC	The number of PVCs detected per minute exceeds the configured threshold.

¹ Indicates alarm is latched.

² Alarm will only be detected when using a View 12™ card.

³ Alarm will not be detected when using a View 12™ card.

EVENT	ALARM PRIORITY	PANORAMA CENTRAL STATION MESSAGES	REASON
Brady ³	1 or Off Factory Default: 1	Brady	Heart rate fell to a value 10 % lower than the configured low heart rate alarm.
Pause ²	1,2,3 or Off Factory Default: 2	Pause	No beat is detected during an interval that is greater than 1.8 R-R and when the next beat is not a PVC.

1 Indicates alarm is latched.

2 Alarm will only be detected when using a View 12™ card.

3 Alarm will not be detected when using a View 12™ card.

13.3 Technical Alarms and Events

The Panorama Central Station uses Technical alarms to indicate that a patient specific technical issue has occurred.

This section provides the technical event messages that may be posted to the Events database and shown in white text (with the exception of the All Alarms Suspended and Non-Lethal Alarms Suspended events) in the Patient Status line. When a number is indicated beside the event message, refer to the table footnotes.

Technical Events

MESSAGE	REASON
All Alarms Suspended ^{1,2}	The Suspend All Alarms sidebar button was selected in the Patient Alarms tabs. NOTE: This event message will display in red text in the Patient Status line.
Resume All Alarms ^{1,2,3}	A patient's alarms are to resume.
Non-Lethal Alarms Suspended ^{1,2}	The Suspend Non-Lethal sidebar button is selected in the Patient Alarms tabs. NOTE: This event message will display in yellow text in the Patient Status line.
Resume Non-Lethal Alarms ^{1,2,3}	A patient's non-lethal alarms are set to resume.
Communications Lost ^{4,5}	The connection between the Panorama Central Station and the attached monitoring equipment has been interrupted.
Central Communications Lost ⁴	The connection between the host central station and the ViewStation has been interrupted.
Signal Lost-Limited Arrhythmia ⁴	A Telepack is in use, arrhythmia analysis is enabled, and there are multiple disruptions of data that may affect the performance of the arrhythmia algorithm.
Signal Lost ⁴	A Telepack is in use, arrhythmia analysis is disabled, and there are multiple disruptions of data.
Standby ^{1,2}	A patient was placed into Standby mode. In Standby mode, all of the patient's monitoring activity is suspended. NOTE: Message will not be shown in the Patient Status line. Instead, message and/or Standby location will be shown in the patient's digital data tile in pink text.
Resume Monitoring ^{1,2}	The patient was removed from Standby mode.

¹ Event cannot be deleted from Event database

² Event will not elicit technical event sound

³ Event will not display in Patient Status line

⁴ Event will always elicit the technical event sound regardless of the Technical Event sound setting

⁵ Event will post a Page request when the central station has the paging option enabled and the alarm is configured to send a page

Technical Events (Continued)

MESSAGE	REASON
Low Battery ⁵	The monitoring equipment battery is low. NOTE: If the Low Battery message appears and the monitoring device is a Telepack, the Battery Percentage digital data tile will flash yellow until the issue is resolved.
Battery Bad Cell	Bad battery cells are detected at the patient monitor battery. This message is only displayed on the Patient Status line.
Cooling Fan Failure	The bedside monitor cooling fan is not operational and the monitor is running on AC power. This message is only displayed on the Patient Status line.
Admit ^{2,3}	A patient is admitted to the Panorama Central Station.
Discharge	The patient was discharged from the Panorama Central Station.
Arrhythmia On ^{1,2,3}	The Arrhythmia option is enabled on a patient's monitoring equipment.
Arrhythmia Off ^{1,2,3}	The Arrhythmia option is disabled on a patient's monitoring equipment.
ST On ^{1,2,3}	The ST option is enabled on a patient's monitoring equipment.
ST Off ^{1,2,3}	The ST option is disabled on a patient's monitoring equipment.
ST Relearn ^{2,3}	The ST algorithm completes a learning phase.
Arrhythmia Relearn ^{2,3}	The arrhythmia algorithm completes a learning phase.
Central User Marked Event ^{2,3}	The user has marked an event at the central station.
Bedside User Marked Event ^{2,3}	The user has marked an event at the bedside monitor.
Calipers Marked Event ^{2,3}	The user has marked a caliper event at the Panorama Central Station
Central Transfer ^{2,3}	A central-to-central transfer has been successfully completed at the central station.
Room Transfer ^{2,3}	A room-to-room transfer has been successfully completed at the central station.
HEART RATE TECHNICAL EVENTS	
Check Lead Connections	The bedside monitor detects a lead off condition.

1 Event cannot be deleted from Event database

2 Event will not elicit technical event sound

3 Event will not display in Patient Status line

4 Event will always elicit the technical event sound regardless of the Technical Event sound setting

5 Event will post a Page request when the central station has the paging option enabled and the alarm is configured to send a page

Technical Events (Continued)

MESSAGE	REASON
RA Lead Off ^{4,5}	The RA lead is not connected to the patient, ECG lead I or II is selected while using a 3-wire lead set, 5-wire lead set or a View 12™ card.
LA Lead Off ^{4,5}	The LA lead is not connected to the patient, ECG lead I or III is selected while using a 3-wire lead set, 5-wire lead set, or a View 12™ card.
LL Lead Off ^{4,5}	The LL lead is not connected to the patient, ECG lead II or III is selected while using a 3-wire lead, 5-wire lead set, or View 12™ card.
Leads Off ^{4,5}	Two or more of the ECG leads are not connected to the patient and a 3-wire lead set, 5-wire lead set or a View 12™ card is in use. It will also be shown when using a 3-wire lead set and ECG I, II, or III is shown and the LL, LA, or RA leads are off, respectively. When using a View 12™ card and two or more leads are off, unless one of the disconnected leads is the RL lead. If a 5-wire lead set is in use and the RL lead is off.
V Lead Off ^{4,5}	A V lead is not connected to the patient and a 5-wire lead set is in use.
V1-V6 Lead Off ^{4,5}	A V1-6 lead is not connected to the patient and a View 12™ card is in use.
ECG Noise ⁴	Noise is present on one or more leads.
RESPIRATION (ECG THORACIC IMPEDANCE) TECHNICAL EVENTS	
Respiration CVA Present	A CVA condition is detected for the monitored patient.
SPO₂ (MASIMO SET® AND NELLCOR®) TECHNICAL EVENTS	
SpO₂ System Check	There is an SpO ₂ system check.
SpO₂ Communication Error	There is interference in the communication between the SpO ₂ source and the bedside monitor.
SpO₂ Failure	A faulty 5V power supply or a faulty positive or negative 15V power supply is detected on the SpO ₂ board.
SpO₂ Board Fault	The SpO ₂ board fails.
SpO₂ Unrecognized Cable	The system detects an unrecognized SpO ₂ cable.
SpO₂ Pulse Search	The SpO ₂ sensor is attempting to detect a pulse.
SpO₂ Weak Pulse	The SpO ₂ sensor detects a weak pulse.
SPO₂ (MASIMO) TECHNICAL EVENTS	
<i>1</i>	<i>Event cannot be deleted from Event database</i>
<i>2</i>	<i>Event will not elicit technical event sound</i>
<i>3</i>	<i>Event will not display in Patient Status line</i>
<i>4</i>	<i>Event will always elicit the technical event sound regardless of the Technical Event sound setting</i>
<i>5</i>	<i>Event will post a Page request when the central station has the paging option enabled and the alarm is configured to send a page</i>

Technical Events (Continued)

MESSAGE	REASON
SpO₂ Low Perfusion	The SpO ₂ Masimo sensor detects low perfusion.
SpO₂ Too Much Light	The SpO ₂ Masimo sensor detects too much light.
SpO₂ Unrecognized Sensor	An unrecognized SpO ₂ Masimo sensor is detected by the system.
SpO₂ Sensor Off	The SpO ₂ Masimo sensor is off.
SpO₂ No Sensor	The SpO ₂ Masimo sensor is not plugged in.
SpO₂ Sensor Failed	Communication with the SpO ₂ Masimo sensor failed.
SpO₂ Interference	There is interference in the communication with the SpO ₂ Masimo sensor.
SPO₂ (NELLCOR) TECHNICAL EVENTS	
SpO₂ Motion	The SpO ₂ Nellcor sensor detects motion.
SpO₂ Check Sensor	The SpO ₂ Nellcor sensor detects a problem.
SpO₂ No Pulse	The SpO ₂ Nellcor sensor does not detect a pulse.
SPO₂ (NONIN) TECHNICAL EVENTS	
SpO₂ (NONIN) Communication Error	There is interference in the communication between the SpO ₂ source and the Telepack.
SpO₂ Check Sensor	The SpO ₂ (Nonin) sensor detects a problem.
SpO₂ No Sensor	The SpO ₂ (Nonin) sensor is not plugged in or the sensor is inoperable.
SpO₂ Low Perfusion	The SpO ₂ (Nonin) sensor detects low perfusion.
SpO₂ Pulse Search	The SpO ₂ (Nonin) sensor is attempting to detect a pulse.
IBPX TECHNICAL EVENTS	
IBPx (Labels include: Art, UA, LV, PA, CVP, ICP, LA,RA) Not Calibrated/Zeroed	The IBP device is not calibrated or zeroed.
NOTE:	x = 1, 2, 3 or 4 (IBP3 and 4 are only available if the Spectrum/Spectrum OR External Parameter Module (EPM) is installed)
CO₂ TECHNICAL EVENTS	
CO₂ Not Calibrated/Zeroed	The CO ₂ device is not calibrated.
CO₂ Occlusion	The CO ₂ device detects a blockage in the filter line.
O₂ TECHNICAL EVENTS	
O₂ Not Calibrated/Zeroed	The O ₂ device is not calibrated.
O₂ Zeroing	The O ₂ device is zeroing.
O₂ Occlusion	The O ₂ device detects a blockage in the filter line.

- 1 Event cannot be deleted from Event database
- 2 Event will not elicit technical event sound
- 3 Event will not display in Patient Status line
- 4 Event will always elicit the technical event sound regardless of the Technical Event sound setting
- 5 Event will post a Page request when the central station has the paging option enabled and the alarm is configured to send a page

Technical Events (Continued)

MESSAGE	REASON
N₂O TECHNICAL EVENTS	
N₂O Not Calibrated/Zeroed	The N ₂ O device is not calibrated.
N₂O Zeroing	The N ₂ O device is zeroing.
N₂O Occlusion	The N ₂ O device detects a blockage in the filter line.
AGENT TECHNICAL EVENTS	
Agent Not Calibrated/Zeroed	The Agent device is not calibrated.
NIBP TECHNICAL EVENTS	
NIBP Cuff Overpressure	The patient's NIBP cuff has an overpressure episode.
NIBP Unable to Measure	The patient's NIBP cuff is unable to take a valid measurement.
NIBP Retry	There is an NIBP measurement retry.
NIBP Pump Higher	The patient's NIBP cuff needs additional pressure to take a measurement.
NIBP Measuring	The patient's NIBP cuff is inflating.
NIBP Deflating	The patient's NIBP cuff is deflating.
CARDIAC OUTPUT TECHNICAL EVENTS	
New CO Measurement ^{2,3}	The Cardiac Output run was accepted at the bedside monitor.
NOTE:	The CO parameter is only available when the Spectrum/ Spectrum OR External Parameter Module (EPM) is installed.
PAWP TECHNICAL EVENTS	
New PAWP Measurement ^{2,3}	The PAWP value was accepted on the bedside monitor.
NURSE CALL TECHNICAL EVENTS	
Nurse Call ⁴	The Nurse Call button on the Telepack was selected.
ATTENDANT PRESENT TECHNICAL EVENTS	
Attendant Present ^{2,3}	The Attendant Present buttons on the Telepack were selected.
BEDSIDE PRINTER TECHNICAL EVENTS	
Printer out of paper	The bedside monitor local printer is out of paper.
Printer Door is Open	The bedside monitor local printer has an open door condition.

¹ Event cannot be deleted from Event database

² Event will not elicit technical event sound

³ Event will not display in Patient Status line

⁴ Event will always elicit the technical event sound regardless of the Technical Event sound setting

⁵ Event will post a Page request when the central station has the paging option enabled and the alarm is configured to send a page

Technical Events (Continued)

MESSAGE	REASON
CENTRAL COMMUNICATION TECHNICAL EVENTS	
Central Communications Lost	The connection between the ViewStation and the host central station was interrupted.
<hr/>	
<i>1 Event cannot be deleted from Event database</i>	
<i>2 Event will not elicit technical event sound</i>	
<i>3 Event will not display in Patient Status line</i>	
<i>4 Event will always elicit the technical event sound regardless of the Technical Event sound setting</i>	
<i>5 Event will post a Page request when the central station has the paging option enabled and the alarm is configured to send a page</i>	

13.4 System Event Messages and Error Codes

The Panorama Central Station displays system event messages and error codes to indicate system-wide issues at the central station and/or at the ViewStation. They are listed based on the system violation, and are resolved when the system-wide condition no longer exists.

This section provides the system event messages and error codes that may be shown in the System Status line in white text.

System Event Messages and Error Codes

MESSAGE	REASON
No Printer Selected or Available	When the print request was made at the central station or remote workstation, no printer was selected, printer was unavailable, or printer was not properly configured.
Printer Offline	The central station or remote workstation default printer's Offline button is selected. NOTE: Button may not be labeled "Offline." Refer to printer user guide for specific button name.
Printer Paper Jam	The central station or remote workstation default printer paper tray is removed as the print job is starting to print.
Printer Out of Paper	The central station or remote workstation default printer is out of paper.
Clock Adjusted	The central station or remote workstation system time or date was adjusted.
Print Halted...Print Queue Full	The central station or remote workstation default printer has been halted because the print queue is full.
Printer error - no toner	The central station or remote workstation default printer toner is low.
Printer in error state	The central station or remote workstation default printer has an error that is not related to any of the previous messages.
All Alarms Muted for x:xx secs	The Mute All menu button was selected at the ViewStation or WorkStation.
All Alarms Muted Permanently	The Mute All menu button was selected at the ViewStation or WorkStation and the Permanent option was selected.
Touch Screen OFF	The central station or remote touch screen is off.
System Service required - Contact Mindray or Authorized Mindray Distributor (100)	This message will be displayed after the central station and/or workstation automatically restarted because a system issue was detected.
System Service required - Contact Mindray or Authorized Mindray Distributor (101)	This message will be displayed if the system performed an auto-reboot due to the GUI process not running.

System Event Messages and Error Codes

MESSAGE	REASON
System Service required - Contact Mindray or Authorized Mindray Distributor (104)	This message will be displayed if a fatal system error has occurred.
System Service required - Contact Mindray or Authorized Mindray Distributor (300)	<p>The central station or remote workstation has detected a hard drive error.</p> <p>CAUTION: It is important to notify Service personnel when the system event message "System Service required - Contact Mindray or Authorized Mindray Distributor (300)." is displayed. This message indicates that while data was being written to or read from the system hard drive, an error was detected. Until service personnel correct this issue, patient data may be lost (for example, demographic information, alarm configurations, and historical patient data). Real time parameter monitoring and alarm checking will not be affected by this message. This message will be displayed until reset by service personnel.</p>

13.5 Operator Position

The operator of the device should be positioned in front of the Panorama Patient Monitoring Network Display at a distance of no more than 1 m.

13.6 Alarm Verification

Alarms can be verified by creating an alarm condition on a connected patient monitor and verifying the alarm is present on the Panorama Patient Monitoring Network Display in a normal operator's position.

14.0 *Network Tab (Optional)*

This section outlines how to configure a ViewStation or a WorkStation to display patient tiles from a Panorama Central Station(s) using the **Network** tab.

- Network Tab
- Troubleshooting

14.1 Network Tab

The **Network** tab (shown in FIGURE 14-1) is where the accessible patient tiles currently monitored on the C-LAN are displayed. These patient tiles may be selected for viewing at the ViewStation or the WorkStation. The **Network** tab can only be seen from a ViewStation or a WorkStation and is not available from the host central station. The ViewStation and WorkStation are independent of each other. For example, if a patient is added to a patient tile at a ViewStation, the WorkStation will not be affected unless the same patient is added to a patient tile at the WorkStation.

NOTE: The host central station(s) C-LAN configuration settings and the software installed at the remote location dictates the functionality available for each patient tile. For additional information, refer to "The ViewStation and the WorkStation" on page 2-4.

14.1.1 Accessing the Network Tab

- From the ViewStation or WorkStation menu bar (shown in FIGURE 2-8 on page 2-11), select the **Network** button. The **Network** tab is displayed (shown in FIGURE 14-1).

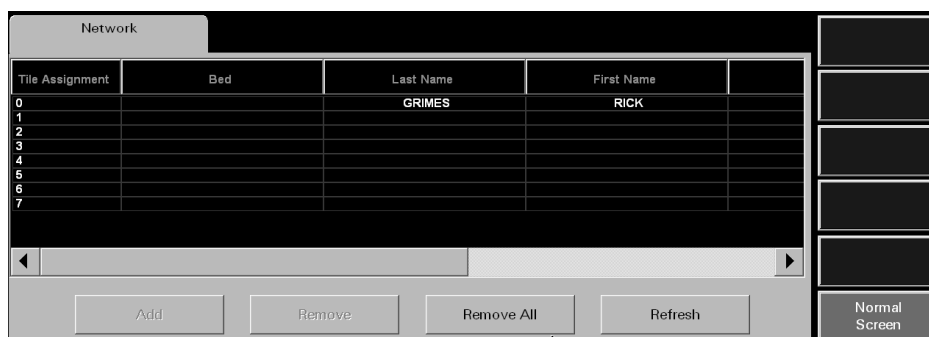

FIGURE 14-1 Network Tab

14.1.2 Sorting the Contents of the Network Tab List Box

When the **Network** tab is first accessed, it will automatically be sorted in ascending order, by the numerical tile assignment number. To sort by another column in the list box, select another column heading, and the rows will be resorted based on the selection. Any changes made to the list after it has been sorted, for example a tile assignment is removed, another **Network** tab dialog is opened from another remote location, or the **Network** tab is closed, will cancel the previous sort order.

14.1.3 Assigning Patient Tiles in the Network Tab

The **Add** button assigns a ViewStation or WorkStation tile number to the selected row in the **Network** tab list box. Once a patient in the **Network** tab list box is assigned a tile number, the patient's data (which is monitored at the host central station) can be seen at the ViewStation or WorkStation.

NOTE: Once a tile is assigned to an associated tile at the ViewStation or the WorkStation, the association to the host patient tile will continue to exist, even if the patient is discharged or the monitoring equipment is removed from the Equipment List at the host central station. Therefore, when a new patient is admitted to the host central station, the patient data will automatically be displayed at the associated ViewStation or the WorkStation tile.

NOTE: To determine which host patient tile the ViewStation or the WorkStation tile is associated with, scroll to the Central column in the Network tab.

To assign a patient tile in the **Network** tab:

1. Select a row in the **Network** tab list box that does not contain a tile assignment number.
2. Select the **Add** button. The Tile Number list box is displayed (shown in FIGURE 14-2).

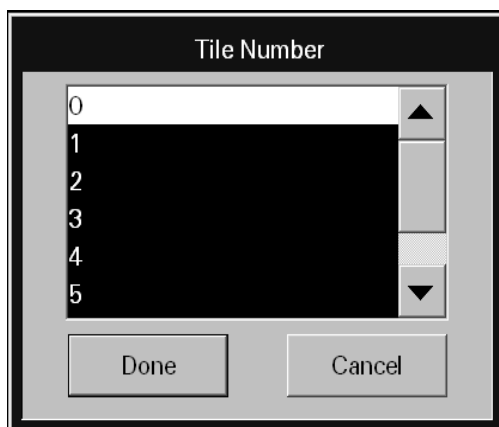

FIGURE 14-2 Tile Number List Box

NOTE: The ViewStation or WorkStation single or dual display configuration dictates the maximum number of tiles that can be assigned. Table 14-1 shows how many tiles can be assigned when using a single or dual display configuration.

TABLE 14-1

VIEW ONLY WORKSTATION CONFIGURATION	NUMBER OF TILES
Single display - 8 tiles	0 - 7
Single display - 12 tiles	0 - 11
Dual display - 24 tiles	0 - 23

3. Select a tile from the list box.
4. Accept or reject the selection.
 - Select the **Done** button to accept the tile assignment and display the patient's data, from the assigned tile, at the ViewStation or WorkStation within five (5) seconds.
 - Select the **Cancel** button to reject the tile assignment and close the Tile Number list box.

14.1.4 Removing a Patient Tile Assignment in the Network Tab

The **Remove** button clears the selected rows' patient tile assignment from the **Network** tab list box and discontinues displaying the selected host patient tile's data at the ViewStation or WorkStation.

NOTE: **Removing a patient tile assignment at the ViewStation or WorkStation will eliminate the connection to the associated host central station patient tile. Therefore, when a patient is admitted to the host central station tile, the patient data will not be displayed at the ViewStation or the WorkStation until another tile association has been established.**

To remove a single tile assignment from the **Network** tab:

1. Select a row in the **Network** tab multi-column list box that contains a number in the **Tile Assignment** column.
2. Select the **Remove** button. The message **Are you sure?** is displayed.
 - Select the **Yes** button to remove the number displayed in the **Tile Assignment** column, discontinue displaying monitored data for the selected patient tile at the ViewStation or the WorkStation, and close the message box.
 - Select the **No** button to continue displaying monitored data for the selected patient tile at the ViewStation or the WorkStation, cancel the remove request, and close the message box.

14.1.5 Removing All Patient Tile Assignments in the Network Tab

The **Remove All** button clears all previously assigned patient tile numbers from the **Network** tab list box and discontinues displaying all of the patient tiles monitored data at the ViewStation or WorkStation.

To clear all the tile assignments from the **Network** tab:

- From the **Network** tab, select the **Remove All** button. The message **Are you sure?** is displayed.
 - Select the **Yes** button to erase all the assigned tile numbers in the **Tile Assignment** column, discontinue displaying monitored data for all the tiles at the ViewStation or the WorkStation, and close the message box.
 - Select the **No** button to continue displaying monitored data for all patients at the ViewStation or the WorkStation, cancel the remove all request, and close the message box.

14.1.6 Refreshing the Network Tab List Box

The **Refresh** button updates the **Network** tab list box for any changes that may have occurred while the **Network** tab was open. Once the **Refresh** button is selected, the **Network** tab list box will regenerate if:

- Any new equipment is added at the host central station
- Any existing equipment is removed from the host central station
- Any existing equipment is edited at the host central station
- Any patient demographic information (Last Name, First Name, ID, Bed, Doctor) or Central Station name/tile number is edited at the host central station

14.1.7 Troubleshooting

This section lists some of the potential messages and issues that may occur while using the **Network** tab.

MESSAGE/ISSUE *	REASON	SOLUTION
The Add button disabled.	No row has been selected in the Network tab list box.	Select a row in the Network tab list box.
	Selected row is already assigned to a tile at the ViewStation or WorkStation.	Select a different row.
The Remove button is disabled.	The selected row(s) in the Network tab does not currently have a tile assignment(s) or no tile(s) have been assigned at the ViewStation or WorkStation.	Establish tile assignment(s) at the ViewStation or WorkStation.
The Remove All button is disabled.	No tile(s) have been assigned at the ViewStation or WorkStation.	Establish tile assignment(s) at the ViewStation or WorkStation.
You have reached the maximum number of channel licenses available.	All the tiles at the ViewStation or WorkStation are currently occupied.	Remove a patient from one of the patient tiles at the ViewStation or WorkStation.
Patient tile no longer displaying patient data at ViewStation or WorkStation.	Communication between the host central station and the ViewStation or WorkStation has been interrupted (Central Communication Lost state).	Contact a Service Representative.
	A Room to Room Without Device transfer out for the host tile has been completed.	Refresh the Network tab list box, and then assign the transferred patient tile to an available tile at the ViewStation or WorkStation.
	A Central to Central Without Device transfer out for the host tile has been accepted.	Refresh the Network tab list box, and then assign the transferred patient tile to an available tile at the ViewStation or WorkStation.
	Host tile at central station is in a Discharge state.	Retrieve patient from Discharge list, if possible, then reassign the retrieved patient tile to an available tile at the ViewStation or WorkStation.

* Messages are shown in all bold text.

MESSAGE/ISSUE *	REASON	SOLUTION
ViewStation or WorkStation tile goes into a Communication Lost state	Host tile at central station is in a Lost Communication state.	Reestablish communication at host central station, and if necessary, contact a Service Representative.
ViewStation or WorkStation tile goes into a Standby state	Host tile at central station is in a Standby state.	Wait for host patient tile to be removed from Standby state.
Patient tile not available in Network tab list box	Network tab needs to be refreshed.	Select the Network tab Refresh button.
	ViewStation or WorkStation is in a Central Communication Lost state.	Contact a Service Representative.
	Patient not currently being monitored on any of the C-LAN central stations.	Admit the patient to a central station on the C-LAN, then assign the patient to an available tile at the ViewStation or WorkStation.
Host patient tile information is displayed at the host central station but not at the ViewStation or WorkStation	Association between host central station patient tile and ViewStation or WorkStation patient tile has not been established.	Assign the tile in the Network tab at the ViewStation or WorkStation.
Selected tile is currently assigned.	Attempted to assign a patient tile at the ViewStation or WorkStation that is already assigned.	Assign the patient to another tile number, if one is available.

* *Messages are shown in all bold text.*

15.0 *Paging Tab (Optional)*

This section outlines the functionality of the **Paging** tab and describes how to configure pagers to properly function with the Panorama Central Station(s), when this option has been purchased.

- Paging Password Tab
- Paging Tab

15.1 Paging Password Tab

The **Paging** password tab (shown in FIGURE 15-1) provides password protected access to the system paging configuration tab. When the correct password is entered, the **Paging** tab is opened.

The **Paging** password tab is only shown if the Paging Password Protection option is set to **ON** in the **Unit Choices** tab. If Paging Password Protection is **OFF**, the **Paging** menu button provides direct access to the **Paging** tab. For additional information regarding the Unit Choices tab, refer to "Unit Choices Tab" on page 9-50.

The **Paging** tab is not available at the ViewStation.

15.1.1 Accessing the Paging Tab

From the Menu Bar, select the **Paging** menu button. The **Paging** password tab is displayed.



FIGURE 15-1 Paging Password tab

15.1.2 Entering a Password

To enter a password:

1. Select the **Password** text box in the **Paging** password tab. The keyboard dialog box is displayed.
2. Use the keyboard dialog box to enter the password that was created in the **Passwords** tab (maximum 15 characters). For security purposes asterisks (*) are shown for each typed character. For additional information regarding passwords, refer to the "Passwords Tab" on page 9-29 or contact your System Administrator.

NOTE: Passwords are case sensitive.

- The Backspace (<==) button clears a single character in the edit box
- The **Caps Lock** button enables/disables the caps lock function. A Caps Lock indicator is shown when **Caps Lock** is enabled.
- The **Close** button discards the changes
- The **Enter** button accepts changes

3. The **Paging** tab (shown in FIGURE 15-2) is displayed after the correct password is entered.

15.1.3 Sidebar Buttons

The following sidebar button is used to expand the functionality of this tab.

Normal Screen

Select the **Normal Screen** sidebar button to return the display to the full screen mode, and close all tabs, message boxes, and dialog boxes.

15.1.4 Troubleshooting

This section lists some of the potential messages and issues that may occur while using the **Paging** password tab.

MESSAGE/ISSUE *	REASON	SOLUTION
Incorrect password. Please try again.	The wrong password was entered in the Password text box.	Select the OK button to close the dialog box. Enter the correct password in the text box.
	The password was entered in the wrong case.	Re-enter the password turning on/off the keyboard dialog Caps Lock key.
Incorrect password. This is your last chance. Please try again	The wrong password was entered two consecutive times in the Password text box.	Select the OK button to close the dialog box. Enter the correct password in the text box.
The Paging password tab closes and the central station is returned to a full screen monitoring display.	The wrong password was entered three consecutive times in the Password text box.	Reopen the Paging password tab and enter the correct password in the text box.

* *Messages are shown in all bold text.*

15.2 Paging Tab

The **Paging** tab allows for the configuration of pager information for a Panorama Central Station that has the paging option enabled. If the central station does not have a **Paging** button on the system Menu Bar, this is an indication that the workstation does not have the Paging option installed.

15.2.1 Accessing the Paging Tab

1. From the Menu Bar, select the **Paging** button.
2. If the **Paging** password tab is displayed, enter the password in the **Password** text box. The **Paging** tab is displayed (shown in FIGURE 15-2).

NOTE: The **Paging** tab list box is displayed in ascending order by pager number.

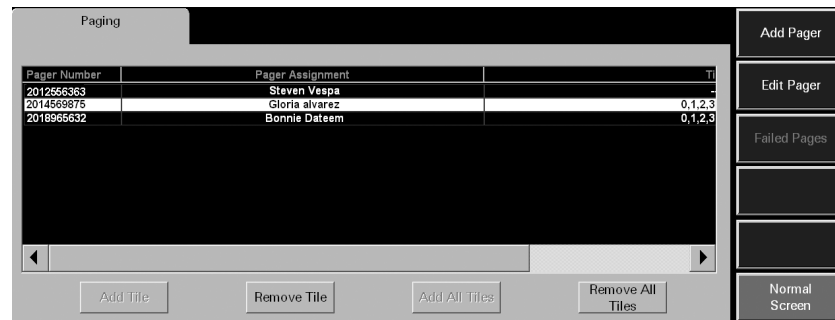

FIGURE 15-2 Paging Tab

15.2.2 Adding a Pager

To add a pager:

1. From the **Paging** tab, select the **Add Pager** sidebar button. The Pager Details dialog (shown in FIGURE 15-3) is displayed.

NOTE: The **Pager Number** and **Pager Assignment** are required fields.

Pager Details

Pager Number

Pager Assignment

Buttons: Done, Cancel

FIGURE 15-3 Pager Details Dialog

2. Select the **Pager Number** text box. The keypad dialog box is displayed.
3. Use the numeric keypad to enter the pager number (maximum of 14 alphanumeric characters), then select the **OK** button. The numeric keypad closes and the **Pager Details** dialog is displayed.

NOTE: **Pager numbers must be unique. If an existing pager number is entered, the message "Pager Number already exists! Please enter a new number." is displayed.**

4. Enter the name of the person who will be responsible for the pager or some other identifying information in the **Pager Assignment** text box (maximum of 30 alphanumeric characters).

NOTE: **Pager assignments must be unique. If an existing pager assignment is entered, the message "This Pager Assignment already exists. Please enter a new assignment." is displayed.**

5. Accept or reject the entry made in the keyboard dialog box.
 - The **Done** button accepts the entry, closes the dialog box, and updates the **Paging** tab list box.
 - The **Cancel** button discards the entry, closes the dialog box, and returns to the **Paging** tab.

NOTE: **The decimal button shall be disabled in the Pager Assignment keyboard.**

15.2.3 Assigning a Patient Tile

To assign a patient tile to a pager:

1. From the **Paging** tab list box, select a pager.
2. Select the **Add Tile** button. The Tile Number dialog box (shown in FIGURE 15-4) is displayed. The number of tiles that are displayed is dependent on the number of configured central station displays and available patient tiles. For additional information, refer to TABLE 15-1 .

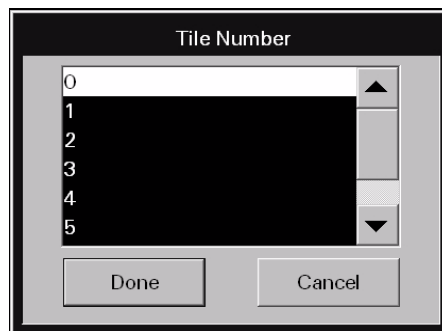

FIGURE 15-4 Tile Number dialog box

TABLE 15-1

CENTRAL STATION CONFIGURATION	PATIENT TILE NUMBER
Single display - 8 tiles	0 - 7
Single display - 12 tiles	0 - 11
Dual display - 16 tiles	0 - 15

3. Select a tile number.

NOTE: The list box will only include patient tiles that are not currently assigned to the selected pager.

NOTE: A patient tile number can be assigned to a maximum of 10 pagers.

4. Accept or reject the selections made in the list box.
 - The **Done** button accepts the selection, closes the dialog box, and updates the **Paging** tab list box.
 - The **Cancel** button discards the selection, closes the dialog box, and returns to the **Paging** tab.
5. Repeat steps 2 - 4 to continue adding patient tiles to the selected pager, if necessary.

NOTE: Multiple tile assignments will be separated by a comma (,) in the Tile column.

15.2.4 Adding All Patient Tiles to a Pager

To assign all available patient tiles to a pager:

1. From the **Paging** tab list box, select a pager.
2. Select the **Add All Tiles** button. The **Are you sure you want to Add All Tiles?** question dialog box is displayed.
 - The **Yes** selection confirms the selection, closes the question dialog box, and updates the Tile column in the **Paging** tab list box.
 - The **No** selection cancels the selection, closes the confirmation dialog, and returns to the **Paging** tab list box.

15.2.5 Removing a Patient Tile Assignment

To remove an existing tile assignment from a pager:

1. From the **Paging** tab list box, select a pager.
2. Select the **Remove Tile** button. The Tile Number dialog box (shown in FIGURE 15-4) is displayed. The number of tiles that are displayed is dependent on the number of patient tiles assigned to the selected pager.
3. Select a patient tile.
4. Accept or reject the selections made in the list box.
 - The **Done** button accepts the selection, closes the dialog box, and returns to the **Paging** tab where the list box updates are displayed.
 - The **Cancel** button discards the selection, closes the dialog box, and returns to the **Paging** tab.

15.2.6 Removing All Patient Tiles from a Pager

To remove all patient tiles assignments from a pager:

1. From the **Paging** tab list box, select a pager.

2. Select the **Remove All Tiles** button. The **Are you sure you want to Remove All Tiles?** question dialog box is displayed.
 - The **Yes** selection confirms the selection, closes the question dialog box, and updates the Tile column in the **Paging** tab list box.
 - The **No** selection cancels the selection, closes the confirmation dialog, and returns to the **Paging** tab list box.

15.2.7 Editing a Pager

To edit an existing pager number or pager assignment:

1. Select the pager from the **Paging** tab list box.
2. Select the **Edit Pager** sidebar button. The Pager Details dialog box is displayed.

FIGURE 15-5 Pager Details (Edit Mode)

3. Edit the pager information.

NOTE: **The Pager Number and Pager Assignment are required fields.**

4. Accept or reject the changes made in the dialog box.
 - The **Done** button accepts the changes, closes the dialog box, and returns to the **Paging** tab where the list box updates are displayed.
 - The **Cancel** button discards the changes, closes the dialog box, and returns to the **Paging** tab.

15.2.8 Removing a Pager

To remove a pager:

1. Follow steps 1 and 2 from the "Editing a Pager" section.
2. Select the **Remove Pager** button in the Pager Details dialog box.
3. Verify the selection. The **Are you sure you want to delete this pager and all its assignments?** question dialog box is displayed.
 - The **Yes** selection confirms the deletion, closes the question dialog box, and removes the pager from the **Paging** tab list box.
 - The **No** selection cancels the deletion, closes the confirmation dialog, and returns to the **Paging** tab list box.

15.2.9 Resending a Failed Page

If an attempt was made to send a page and was unsuccessful, the page will be added to the **Failed Pages** view. The **Failed Pages** view contains a list box that can display a maximum of 100 failed pages. The list box orders the failed pages chronologically in descending order.

NOTE: If the system is reset, all failed pages listed in the “Failed Pages” view will be removed.

To resend a failed page:

1. Select the **Failed Page** sidebar button. The **Failed Pages** view (shown in FIGURE 15-6) is displayed.

NOTE: The **Failed Page** sidebar button will only be available if there is failed page information in the **Failed Pages** view.





Date / Time	Event	Pager Number	Pager Assignment	Title
03/02 10:19 AM	Low Heart Rate Alarm	2019958000	nancy	5
03/02 10:18 AM	High Heart Rate Alarm	2019958000	nancy	5
03/02 10:18 AM	High Heart Rate Alarm	001	bob	0
03/02 10:18 AM	Low Respiration Rate Alarm	2019958000	nancy	5



FIGURE 15-6 Failed Pages View

2. Select a failed page from the list box using the navigational buttons.
3. Select the **Resend** sidebar button. The failed page is resent and the row is removed from the list box if the page was successfully resent. If the page was not successfully resent, a new row will be added to the top of the **Failed Pages** view list box with updated date and time stamp.

Navigating in the Failed Pages View

To navigate in the **Failed Pages** view, select any of the following buttons to:

BUTTON	DESCRIPTION
	Display the oldest failed pages in the list box.
	Scroll down the list one page at a time.
	Scroll down one row in the list at a time.
	Scroll up one row in the list at a time.

BUTTON	DESCRIPTION
	Scroll up the list one page at a time.
	Display the newest failed pages in the list box.

15.2.10 Generating a Paging Report

To review all of the currently assigned pagers, determine who each pager is assigned to, and to which tile the pager is assigned, generate a Paging Report. This report can be generated directly from the **Paging** tab by selecting the **Print** button from the Menu Bar.

For additional information regarding the Paging Report, refer to the "Paging Report" on page 8-35.

15.2.11 Troubleshooting

This section lists some of the potential messages and issues that may occur while using the **Paging** tab.

MESSAGE/ISSUE *	REASON	SOLUTION
You have reached the maximum number of pagers that can be assigned to a tile.	A patient tile cannot be assigned to more than 10 pagers.	Remove one pager assignment from the patient tile.
The Add Tile button is disabled.	There are no pagers listed in the Paging tab's list box.	Add a pager and then assign it to a tile.
	All the patient tiles at the central station are already assigned to the selected pager in the Paging tab's list box.	Assign the pager to another patient tile.
The Remove Tile button is disabled.	There are no pagers listed in the Paging tab's list box.	Add a pager and then assign it to a tile.
	None of the patient tiles at the central station are assigned to the selected pager in the Paging tab's list box.	Assign a pager to one of the patient tiles.
Are you sure you want to Add All Tiles?	The Add All Tiles button was selected in the Paging tab's list box.	Confirm that this was the intended function, then select the Yes button to confirm or the No button to cancel the function and return to the Paging tab.
Some tiles could not be assigned to this pager.	The Add All Tiles button was selected.	Some of the patient tiles already contain 10 pager assignments.
Are you sure you want to Remove All Tiles?	The Remove All Tiles button was selected in the Paging tab's list box.	Confirm that this was the intended function, then select the Yes or No button.

* Messages are shown in all bold text.

MESSAGE/ISSUE *	REASON	SOLUTION
Are you sure that you want to delete the selected event/s?	The Delete or Delete All sidebar button was selected while in the Failed Pages view.	Confirm that this was the intended function, then select the Yes button or the No button.
The Done button in the Pager Details dialog box is disabled.	No data has been entered into the Pager Number and/or the Pager Assignment text box.	Enter a Pager Number and/or Pager Assignment in the Pager Details dialog box.
Pager Number already exists! Please enter a new number.	Pager numbers must be unique. The pager number entered is a duplicate of an existing pager number.	Enter a unique pager number, then select the OK button.
Was not able to enter 18 alpha numerics in the Pager Number field.	A maximum of 15 alphanumeric characters can be entered to the Pager Number field.	Verify the Pager Number is correct.
While entering a Pager Assignment, could not continue adding alphanumeric characters.	A maximum of 30 alphanumeric characters can be added to the Pager Assignment field.	Abbreviate the assignee name or identifying title.
A failed page was removed from the Failed Pages list box.	The failed page was successfully resent which removes the page from the Failed Pages view.	Locate the event in the Events List and verify that a page was sent for the event.
	The list box maximum of 100 records was reached and the failed page was automatically deleted from the database.	Periodically delete or resend the failed pages from the Failed Pages list box to avoid the automatic deletion of failed pages.
	A failed page was removed from the Failed Pages list box.	A failed page was removed from the Failed Pages list box.
	If the system is reset, all failed pages listed in the "Failed Pages" view will be removed.	—
The selected event has been deleted.	The failed page event has been deleted from the database because it reached its maximum number of records.	Select another failed page from the list box.
You have reached the maximum number of pagers.	The Add Pager sidebar push button was selected when the the maximum number of pagers has already been assigned at the central station.	Review the list and remove any unused pagers from the list.
This Pager Assignment already exists. Please enter a new assignment.	The pager assignment entered in the Pager Assignment text box is a duplicate of a pager assignment that already exists.	Enter a different pager assignment.

* Messages are shown in all bold text.

Performance Specifications

This section outlines performance specifications for the Panorama Patient Monitoring Network.

- ECG Performance Requirements
- ECG Derived Heart Rate Meter Performance Requirements
- Panorama Central Station and Panorama Telemetry Server
- Keyboard
- Mouse
- Displays
- Network Printer
- Access Points/Antennas
- Telepack Specifications
- Nonin SpO2 Module Specifications

16.1 ECG Performance Requirements

Three Lead Displayable Leads:	I, II, III (one vector at a time)
Five Lead Displayable Leads:	I, II, III, aVR, aVL, aVF, V
Twelve Lead Displayable Leads:	I, II, III, aVR, aVL, aVF, V1, V2, V3, V4, V5, and V6
Standardizing Voltage:	The ECG size is indicated by a scale bar displayed on the left of the waveform window with a scale indicating the height of the bar in mV. Printed output to have standardizing pulse printed at beginning of strip
Time base selection (Non-permanent display)	25 mm/s
Time base error (Non-permanent display)	$\pm 10\%$
Impulse Response	0.1 mV max 0.3 mV/sec max slope
Aspect Ratio	0.4 ± 0.08 sec/mV (met by 25 mm/s)
Overall System Error	Greater of 5% or 40 μ V ANSI/AAMI EC13-2002, 4.2.7.1 (a)
ECG Input dynamic range	+/- 5mV max
Channel Width	30 mm. min

Waveform Displays	<p>Each waveform in the All Strips, Event List Zoom-In, Full Disclosure Zoom-In and ST reports will be displayed on a calibrated grid (5mm x 5mm) that conforms to ANSI/AAMI EC13: 2002.4.2.9.7d.</p> <p>Each second of the waveforms in the All Strips, Event List Zoom-In, Full Disclosure Zoom-In and ST reports will be marked with a time annotation marker that conforms to ANSI/AAMI EC13: 2002.4.2.9.7e.</p>
Heart Rate Meter Accuracy and Response to Irregular Rhythm	<p>Per ANSI/AAMI EC13-2002 Section 4.1.2.1e. paragraph 3a, Ventricular Bigeminy, the Heart Rate meter response is in the range of 39 bpm to 80 bpm.</p> <p>Per ANSI/AAMI EC13-2002 Section 4.1.2.1e. paragraph 3b, Slow alternating Ventricular Bigeminy, the Heart Rate meter response is in the range of 45 bpm to 62 bpm.</p> <p>Per ANSI/AAMI EC13-2002 Section 4.1.2.1e. paragraph 3c, Rapid alternating Ventricular Bigeminy, the Heart Rate meter response is constant at 60 bpm.</p> <p>Per ANSI/AAMI EC13-2002 Section 4.1.2.1e. paragraph 3d, Bidirectional systoles, the Heart Rate meter response is constant at 90 bpm.</p>
Time to Alarm for Tachycardia	The alarm response time for Tachycardia is less than 5 seconds in accordance with ANSI/AAMI EC13-2002 Section 4.1.2.1g.
Pacer Rejection	The heart rate meter rejects pulses of amplitude signals from $\pm 2\text{mV}$ to $\pm 700\text{mV}$ and duration 0.1 ms to 2ms with no tail according to ANSI/AAMI EC13-2002 Section 4.1.4.1 (No tails).
Pacemaker Pulse Rejection Capability	The pacer detector's slew rate is 6.024V/s
NOTE:	The heart rate meter does not reject Pacemaker pulses with tails.
NOTE:	The heart rate meter does not reject Pacemaker with fast ECG signals.
NOTE:	There is no Pacemaker pulse auxiliary output.

16.2 ECG Derived Heart Rate Meter Performance Requirements

Range:	30 to 300 bpm Adult/Pediatric ANSI/AAMI EC13-2002, 4.2.7 30 to 350 bpm Neonatal ANSI/AAMI EC13-2002, 4.2.7
Resolution:	1 bpm

16.2.1 Alarm Response

High HR alarm Range	Off 60-250 bpm Adult 100-300 bpm Pediatric 100-350 bpm Neonatal (ANSI/AAMI EC13-2002, 4.2.8.1)
Low HR alarm Range	Off 30-120 bpm Adult 30-150 bpm Pediatric 30-200 bpm Neonatal (ANSI/AAMI EC13-2002, 4.2.8.1)
Resolution	5 bpm max. (ANSI/AAMI EC13-2002, 4.2.8.2)
Accuracy	± 5 bpm or $\pm 10\%$ (ANSI/AAMI EC13-2002, 4.2.8.3)
Time to alarm Step Change Response Time	Less than 10 seconds for 60 bpm low limit alarm to sound when stepping from a heart rate of 80 to 40 bpm (ANSI/AAMI EC13-2002, 4.2.8.4 and 4.2.8.5). Less than 10 seconds for 100 bpm high limit alarm to sound when stepping from a heart rate of 80 to 120 bpm (ANSI/AAMI EC13-2002, 4.2.8.6)

16.2.2 ST Segment Analysis

Enabling:	Enabled in Adult and Pediatric (from a bedside monitor only) modes only. ST for Telepack units may be enabled at the Panorama Central Station.
-----------	--

Default ST Measurement Point: 80 ms after J point for heart rates ≤ 120 bpm
60 ms after the J point for heart rates > 120 bpm

User Selectable ST

Measurement Points: 40, 60 and 80 ms after J point (heart rate independent)
Or 60/80 Heart Rate Dependent

Default ISO Point: Located between the P and Q waves.

User adjustable ISO Point: User adjustable from "R peak" - 10 ms to "R peak" - 200 ms in 8 ms increments.

Default J Point: The end of the QRS complex.

User adjustable J Point: User adjustable from "R peak" - 10 ms to "R peak" - 200 ms in 8 ms increments.

Numerical ST Update Rate: 3/5 Lead Wire: every 10 seconds
View 12 card: every 2 seconds

16.2.3 Arrhythmia Analysis

Arrhythmia analysis identifies ventricular arrhythmia.

The following arrhythmia calls will be displayed:

Asystole	Pause
Bigeminy	Run
Bradycardia (Brady)	Trigeminy
Couplet	Ventricular Fibrillation (V-Fib)
Irregular Heart Rate	Ventricular Rhythm
PVCs per minute	Ventricular Tachycardia (V-Tach)

16.2.4 NIBP Performance Characteristics

Systolic Pressure Measurement

Range: 55 to 235 mmHg in Adult mode
55 to 160 mmHg in Pediatric mode
45 to 120 mmHg in Neonatal mode

Resolution: 1 mmHg

16.2.4.1 Diastolic Pressure Measurement

Range: 30 to 200 mmHg in Adult mode
30 to 150 mmHg in Pediatric mode
20 to 100 mmHg in Neonatal mode

	Resolution:	1 mmHg
16.2.4.2	Pulse Rate	
	Range:	35-245 bpm, for Adults/Pediatric 70– 245 bpm, for Neonate
	Resolution:	1 bpm
16.2.5	IBP Pressure Range	
	Range:	30 to 300 mmHg
16.2.6	IBP Heart Rate Meter	
	Range:	30 to 300 bpm Adult/Pediatric 30 to 333 bpm Neonatal
	Resolution:	1 bpm
16.2.7	Temperature Performance Requirements	
	Scale:	Selectable Celsius or Fahrenheit
	Range:	15 °C to 45 °C 59 °F to 113 °F
	Resolution:	0.1 °C 0.1 °F
16.2.8	ECG Respiration Performance Requirements	
	Range:	4 to 199 breaths per minute
	Resp. Scale:	1, 2, 3, 4 or 5 with standard ECG cable
16.2.9	SpO₂	
	SpO ₂ Range:	70% to 100%
	Pulse Rate Range:	30 to 235

16.2.10 Nonin SpO₂

SpO₂ Range: 0% to 100%
Pulse Rate Range: 18 to 300

16.2.11 CO₂ Performance Requirements

Range: 0 - 13%
Respiration Rate Range: 0 - 150 breaths/minute

16.2.12 CO₂ Alarm

ET CO₂ High Alarm Range: Off, 20 to 80 mmHg
ET CO₂ Low Alarm Range: Off, 5 to 50 mmHg
Insp. CO₂ High Alarm Range: Off, 5 to 30 mmHg

16.3 Panorama Central Station and Panorama Telemetry Server

Panorama Central Station hardware consists of a computer, hard drives, Ethernet, display controllers, case and a power supply.

There is one basic hardware platform for the Panorama Central Station computer system. It contains the following:

- CPU Motherboard and processor
- 1 GB of RAM
- 1280 x 1024 dpi 24-bit (16.7 million colors) display controllers
- 80 GB system hard drive, minimum
- Four channel serial interface for touch screen inputs, Telepack programming, and future features
- 2 on-board Ethernet connectors
- CD-R/W

Panorama Telemetry Server hardware consists of a computer, hard drives, Ethernet, display controllers, case and a power supply. The system is populated with the following:

- CPU Motherboard and processor
- 1 GB of RAM, minimum
- 800 x 600 dpi display controllers
- 80 GB system hard drive, minimum
- 1 channel serial port
- 2 on-board Ethernet connectors
- CD-R/W

16.3.1 Real Time Clock

This is used for various time-related functions in the Panorama Central Station and the Panorama Telemetry Server.

16.3.2 Power Supply

Voltage

- 100-240 VAC ($\pm 10\%$)

Frequency

- 60/50 Hz ($\pm 3\text{Hz}$)

Panorama Central Station Power Consumption Maximum

- 115 VAC @ 1.4 A + 20%
- 230 VAC @ 0.6 A + 20%

16.3.3 Operating Temperature

- +5 to +40 ° C (Panorama Central Station)
- +10 to +40 ° C (Panorama Telemetry Server)

16.3.4 Operating Humidity

- 20% to 80% Relative Humidity Maximum, non-condensing, maximum wet bulb 29 ° C

16.3.5 Operating Altitude

- 1060 to 700 hPa (-1250 to 9889 feet ASL) (-380 - 3014 m) (795 to 525 mmHg)

16.3.6 Storage Temperature

- -20 to +60 ° C

16.3.7 Storage Humidity

- 5% to 80% Relative Humidity Maximum, non-condensing, maximum wet bulb 35 ° C (Panorama Central Station)
- 5% to 80% Relative Humidity Maximum, non-condensing, maximum wet bulb 29 ° C (Panorama Telemetry Server)

16.3.8 Storage Altitude

- 1060 to 700 hPa (-1250 to 9889 feet ASL) (-380 - 3014 m) (795 to 525 mm Hg)

16.3.9 Standards

The Panorama Central Station and Panorama Telemetry Server comply with the following standards:

SAFETY

UL 60950-1:2003	Safety of Information Technology Equipment
CSA-C22.2 60950-1-03	Safety of Information Technology Equipment
EN 60601-1-4:1996	Programmable Electrical Medical Systems
EN 1041:1998	Information supplied by the manufacturer with medical systems
IEC 60601-1-8:2006	Electrically-generated alarm signals (Except section 201.8.3 for Alarm Icons. The monitor instead maintains the icons specified by IEC 60417.)

SAFETY DESIGNATIONS

(SEE SECTION 16.3.11 (TABLE 16-1, TABLE 16-2, TABLE 16-3, TABLE 16-4))

Mode of Operation	Continuous
Protection Against Hazards of Explosion	Non Protected (ordinary)
Protection Against Ingress of Liquids	IPX0 (ordinary, non-protected)
Degree of Mobility	Stationary, Intra Hospital

PERFORMANCE

ANSI/AAMI EC11:1991	Diagnostic Electrocardiographic devices
ANSI/AAMI EC13:2002	Cardiac monitors, heart rate meters, and alarms
EN ISO 21647:2004	Basic safety and essential performance of respiratory gas monitors
EN ISO 9919:2005	Basic safety and essential performance of pulse oximeter equipment for medical use.
AAMI SP10:1992	Electronic or automated sphygmomanometer
FCC 47CFR, Part 95, Sub Part H, Wireless Medical Telemetry Service (WMTS), for 608 MHz devices and components of the system	

HAZARD ANALYSIS

EN 14971:2000	Application of Risk management to medical devices
---------------	---

ENVIRONMENTAL / EMC

IEC 60601-1-2:2001	Electromagnetic compatibility
--------------------	-------------------------------

SHIPPING

ISTA Test Procedure 2A	Shipping Integrity test
------------------------	-------------------------

16.3.10 Information Display and Control

16.3.10.1 Audio Indicators

Audio alarms are in accordance with IEC60601-1-8.

The measured sound pressure level for the high audio alarm is 72 dB.

The measured sound pressure level for the medium audio alarm is 65 dB.

The measured sound pressure level for the low audio alarm is 60 dB.

16.3.10.2 Recovery from Power Loss

16.3.10.2.1 Alarm Restoration from Power Loss

If the Panorama system experiences a power loss, all alarm settings will be restored upon power reset. For the Telepack, alarm settings will be restored from the Panorama Patient Monitoring Central Station.

CAUTION: If the Panorama system experiences a communication loss, all Telepack ST and/or arrhythmia alarms that were active at the time of communication loss will not produce central station alarm notifications once communication is restored. This is due to the automatic relearn function of the ST and/or arrhythmia algorithm after communication is restored.

16.3.10.2.2 Data Logging after Power Loss

All logs will be restored following a power loss of any duration. Logs consist of the event log (service only), error log (service only), and the patient database.

16.3.11 Electromagnetic Compatibility

The Panorama Central Station, Panorama Telemetry Server, and Panorama Wireless Transceiver meet the requirements of IEC 60601-1-2:2001.

NOTE: The Panorama Central Station, Panorama Telemetry Server, and Panorama Wireless Transceiver (120V only) needs special precautions regarding Electro Magnetic Compatibility (EMC) and needs to be installed and put into service according to the EMC information provided in this section.

NOTE: Portable and mobile RF communications equipment can affect the Panorama Central Station and Panorama Telemetry. Refer to Table 16-1 on page 16-12, Table 16-2 on page 16-13, and Table 16-4 on page 16-15.

TABLE 16-1

GUIDANCE AND DECLARATION - ELECTROMAGNETIC EMISSIONS

The Panorama Central Station, Telemetry Server, and Panorama Wireless Transceiver (120V only) is intended for use in the electromagnetic environment specified below. The customer or the user of the Panorama Central Station and Telemetry Server should assure that it is used in such an environment.

EMISSIONS TEST	COMPLIANCE	ELECTROMAGNETIC ENVIRONMENT - GUIDANCE
RF emissions CISPR 11	Group 1	The Panorama Central Station, Telemetry Server, and Panorama Wireless Transceiver uses RF energy only for its internal function and external data transmission. However, its RF emissions are very low and are not likely to cause any interference in nearby electronic equipment.
RF emissions CISPR 11	Class A	The Panorama Central Station, Telemetry Server, and Panorama Wireless
Harmonic emissions IEC 61000-3-2 *	Class A	Transceiver is suitable for use in all establishments other than domestic and those directly connected to the public
Voltage fluctuations/ Flicker emissions IEC 61000-3-3 *	Complies	low-voltage power supply network that supplies buildings used for domestic purposes

* Panorama Central Station and Panorama Telemetry Server only

TABLE 16-2**GUIDANCE AND DECLARATION - ELECTROMAGNETIC IMMUNITY**

The Panorama Central Station, Telemetry Server, and Panorama Wireless Transceiver is intended for use in the electromagnetic environment specified below. The customer or the user of the Panorama Central Station and Telemetry Server should assure that it is used in such an environment.

IMMUNITY TEST	IEC 60601 TEST LEVEL	COMPLIANCE LEVEL	ELECTROMAGNETIC ENVIRONMENT - GUIDANCE
Electrostatic discharge (ESD) IEC 61000-4-2	±6 kV contact ±8 kV air	±6 kV contact ±8 kV air	Floors should be wood, concrete or ceramic tile. If floors are covered with synthetic material, the relative humidity should be at least 30%.
Electrical fast transient/burst IEC 61000-4-4	±2 kV for power supply lines ±1 kV for input/output lines	± 2 kV for power supply lines ± 1 kV for input/output lines	Mains power quality should be typical of a commercial or hospital environment.
Surge IEC 61000-4-5	±1 kV differential mode ±2 kV common mode	± 1 kV differential mode ± 2 kV common mode	Mains power quality should be typical of a commercial or hospital environment.
Voltage dips, short interruptions and voltage variations on power supply input lines IEC 61000-4-11	<5% U_T (>95% dip in U_T) for 0,5 cycle	<5% U_T (>95% dip in U_T) for 0,5 cycle	Mains power quality should be typical of a commercial or hospital environment. If the user requires continued operation during power mains interruptions, it is recommended that the device be powered from an uninterruptible power supply or a battery.
	40% U_T (60% dip in U_T) for 5 cycles	40% U_T (60% dip in U_T) for 5 cycles	
	70% U_T (30% dip in U_T) for 25 cycles	70% U_T (30% dip in U_T) for 25 cycles	
	< 5% U_T (>95% dip in U_T) for 5 sec	< 5% U_T (>95% dip in U_T) for	
Power frequency (50/60 Hz) magnetic field IEC 61000-4-8	3 A/m	3 A/m	Power frequency magnetic fields should be at levels characteristic of a typical location in a typical commercial or hospital environment.

U_T is the a.c. mains voltage prior to application of the test level.

NOTE: **Panorama Central Station, Telemetry Server, and Panorama Wireless Transceiver, that are rack mounted, shall be powered down prior to cable and/or Panorama Licensing Key attachment or disconnect.**

TABLE 16-3

GUIDANCE AND DECLARATION - ELECTROMAGNETIC IMMUNITY

The Panorama Central Station, Telemetry Server, and Panorama Wireless Transceiver is intended for use in the electromagnetic environment specified below. The customer or the user of the Panorama Central Station and Telemetry Server should assure that it is used in such an environment.

IMMUNITY TEST	IEC 60601 TEST LEVEL	COMPLIANCE LEVEL	ELECTROMAGNETIC ENVIRONMENT - GUIDANCE
Conducted RF IEC 61000-4-6	3 Vrms 150 kHz to 80 MHz	3 Vrms	Portable and mobile RF communications equipment should be used no closer to any part of the Telepack, including cables, than the recommended separation distance calculated from the equation applicable to the frequency of the transmitter. Recommended separation distance $d = 1.2 \times \sqrt{P}$
Radiated RF IEC 61000-4-3	3 V/m 80 MHz to 2.5 GHz	3 V/m	$d = 1.2 \times \sqrt{P}$ 80 MHz to 800 MHz $d = 2.3 \times \sqrt{P}$ 80 MHz to 2.5 GHz Where P is the maximum output power rating of the transmitter in watts (W) according to the transmitter manufacturer and d is the recommended separation distance in meters (m). Field strengths from fixed RF transmitters, as determined by an electromagnetic site survey* should be less than the compliance level in each frequency range. Interference may occur in the vicinity of equipment marked with the following symbol: 

NOTE: At 80 MHz and 800 MHz, the higher frequency range applies.

NOTE: These guidelines may not apply in all situations. Electromagnetic propagation is affected by absorption and reflection from structures, objects and people.

* Field strengths from fixed transmitters, such as base stations for radio (cellular/cordless) telephones and land mobile radios, amateur radio, AM and FM radio broadcast and TV broadcast cannot be predicted theoretically with accuracy. To assess the electromagnetic environment, due to fixed RF transmitters, an electromagnetic site survey should be considered. If the measured field strength where the Telepack is used exceeds the applicable RF compliance level, the Telepack should be observed to verify normal operation. If abnormal performance is observed, additional measures may be necessary, such as reorienting or relocating the Telepack.

NOTE: Panorama Central Station equipment should not be used in the presence of high energy amplitude modulated (AM) signals that are operating within the audible range. These signals are not normally found in the hospital environment.

TABLE 16-4**RECOMMENDED SEPARATION DISTANCES BETWEEN PORTABLE AND MOBILE RF COMMUNICATIONS EQUIPMENT AND THE PANORAMA CENTRAL STATION AND TELEMTRY SERVER**

The Panorama Central Station, Telemetry Server, and Panorama Wireless Transceiver is intended for use in an electromagnetic environment in which radiated RF disturbances are controlled. The customer or the user of the Panorama Central Station, Telemetry Server, and Panorama Wireless Transceiver can help prevent electromagnetic interference by maintaining a minimum distance between portable and mobile RF communications equipment (transmitters) and the Panorama Central Station, Telemetry Server, and Panorama Wireless Transceiver as recommended below, according to the maximum output power of the communications equipment.

RATED MAXIMUM OUTPUT POWER OF TRANSMITTER W (WATTS)	SEPARATION DISTANCE ACCORDING TO FREQUENCY OF TRANSMITTER M (METERS)		
	150 KHZ TO 80 MHZ $D = 1.2 \times \sqrt{P}$	80 MHZ TO 800 MHZ $D = 1.2 \times \sqrt{P}$	800 MHZ TO 2.5 GHZ $D = 2.3 \times \sqrt{P}$
0.01	0.12	0.12	0.23
0.1	0.38	0.38	0.73
1	1.2	1.2	2.3
10	3.8	3.8	7.3
100	12	12	23

For transmitters rated at a maximum output power not listed above, the recommended separation distance d in meters (m) can be determined using the equation applicable to the frequency of the transmitter, where P is the maximum output power rating of the transmitter in watts (W) according to the transmitter manufacturer.

NOTE: At 80 MHz and 800 MHz, the separation distance for the higher frequency range applies.

NOTE: These guidelines may not apply in all situations. Electromagnetic propagation is affected by absorption and reflection from structures, objects and people.

16.3.12 Physical Characteristics

Maximum Size (Rack Mount (2U) CPU Case)

- Depth: 28.0" (711.2 mm)
- Height: 3.5" (88.9 mm)
- Width: 19.3" (490.2 mm)

Maximum Weight

- 36.0 lbs (16.33 kg)

Maximum Size (Vertical CPU Case)

- Depth: 17.5" (445.5 mm)
- Height: 17.0" (431.8 mm)
- Width: 7.5" (190.5 mm)

Maximum Weight

- 30.0 lbs (13.6 kg)

16.4 Keyboard

- Keyboard is supported for system diagnostics only.
- This keyboard is offered in English language only and is not required for normal operation, but will be required for non-application system maintenance.
- The System will not require a keyboard to boot up and enter Panorama Central Station application software.

16.5 Mouse

- The mouse is supported for system diagnostics and user interface.
- Supported as an interface control device.
- The mouse operates independent of a touch screen interface.
- The mouse/touch screen is used together with the display to make selections from various menus and screens.

16.6 Displays

16.6.1 21" CRT Display

(Used with earlier versions of the Panorama Central Station software.)

This is an integrated monitor that includes an internal touch screen controller and has the following features:

- SXGA
- 1280 x 1024 dpi capability
- 0.27mm dot pitch
- 19" viewable image measured diagonally

16.6.2 20" CRT Display

(Used with earlier versions of the Panorama Central Station software.)

This is an integrated monitor that includes an internal touch screen controller and has the following features:

- SXGA
- 1280 x 1024 dpi capability
- 0.27mm dot pitch
- 18.9" viewable image measured diagonally

16.6.3 19" Flat Panel

(Used with current versions of the Panorama Central Station software.)

This is an integrated monitor that includes an internal touch screen controller and has the following features:

- SXGA
- 1280 x 1024 dpi capability
- 0.28mm dot pitch
- 19.0" viewable image measured diagonally

16.6.4 18.1" Flat Panel

(Used with earlier versions of the Panorama Central Station software.)

This is an integrated monitor that includes an internal touch screen controller and has the following features:

- SXGA
- 1280 x 1024 dpi capability
- 0.28mm dot pitch
- 18.1" viewable image measured diagonally

WARNING: The 18.1" flat panel may tip over, if the display head is inclined to an angle greater than 45° backward tilt. If the user elects to have the display head inclined to an angle greater than 45° backward tilt, the flat panel must be attached to a secure mounting surface via three screw locations on the bottom of the base.

16.6.5 Touch Screen

- A Surface Acoustical Wave (SAW) touch screen is supported as the standard input device on the 18.1", 19", 20", and/or 21" display.
- The touch screen operates independent of a mouse interface.
- The actual touch screen and its controller are integrated into the display.
- The touch screen communication is accepted by Panorama Central Station via a serial port.
- Use of the touch screen does not preclude the use of a mouse.

16.7 Network Printer

- The network printer is the standard hard copy output device for the output of Panorama Central Station waveform strip-charts and reports.
- There is no provision to support a printer mounted within Panorama Central Station CPU enclosure.
- The printer connects to the system via the Panorama Central Network (C-LAN).
- Two network laser printers are supported per Panorama Central Station.

For additional information, refer to the Panorama Printer Configuration Guide (P/N 0070-00-0561).

16.7.1 Requirements

Communications connection:	10/100 Base-TX Ethernet with internal print server
Speed:	17 pages per minute printing at full resolution
Resolution:	1200-dpi output
Media:	Plain paper sheets
Media sizes:	8.5 in. by 11 in. and A4

NOTE: Please refer to the manufacturer's printer manual for specific instructions regarding the printer.

16.8 Access Points/Antennas

The Panorama Telemetry Server will require Symbol® Technologies Access Points with antennas as described in the Panorama Installation Guide (P/N 0070-00-0635) when ISM communication is required. If using Telepack-2.4 units, the Panorama Central Station will require Cisco Access Points.

16.9 Panorama Wireless Transceiver/Splitters/Antennas/ Cable Repeaters

16.9.1 Panorama Wireless Transceiver

16.9.1.1 Power Supply

Voltage

- 100-120 VAC ($\pm 10\%$)

Frequency

- 60 Hz (± 3 Hz)

Power Consumption

- 1.25 Amps (maximum)

16.9.1.2 Physical Characteristics

Maximum Size

- Depth: 16.2" (411.48 mm)
- Height: 5.2" (132.08 mm)
- Width: 17" (431.8 mm)

Maximum Weight

- 12.35 lbs (5.6 kg)

16.9.1.3 Frequency Range

Receiver Range

- 608-614 MHz

Transmit Range

- 1395-1400 MHz and 1427-1429.5 MHz

16.9.2 Panorama Antenna

Physical Characteristics

Maximum Size

- Depth: 7.6" diameter (193.04 mm)
- Height: 5.5" (139.7 mm)

Maximum Weight

- 0.88 lbs (0.4 kg)

Frequency Range

- Receiver Range: 608-614 MHz
- Transmit Range: 1395-1400 MHz and 1427-1429.5 MHz

16.9.3 Cable Repeater**Physical Characteristics****Maximum Size**

- Depth: 4.75" (120.65 mm)
- Height: 6.75" (171.45 mm)
- Width: 9.75" (247.65 mm)

Maximum Weight

- 3.96 lbs. (1.8 kg)

Frequency Range

- Receiver Range: 608-614 MHz
- Transmit Range: 1395-1400 MHz and 1427-1429.5 MHz

16.9.4 Splitter**Physical Characteristics****Maximum Size**

- Depth: 2" (50.8 mm)
- Height: 2" (50.8 mm)
- Width: 1.25" (31.75 mm)

Maximum Weight

- 0.22 lbs. (0.1 kg)

16.9.5 Environmental Characteristics for the Panorama Wireless Transceiver/Splitters/Antennas**16.9.5.1 Operating Temperature**

- +5 to +40 °C

16.9.5.2 Operating Humidity

- 20 % to 80 % Relative Humidity Maximum, non-condensing, maximum wet bulb 29 ° C

16.9.5.3 Operating Altitude

- 1060 to 700 hPa (-1250 to 9889 feet ASL) (795 to 525 mmHg)

16.9.5.4 Storage Temperature

- -20 to +60 ° C

16.9.5.5 Storage Humidity

- 5% to 80% Relative Humidity Maximum, non-condensing, maximum wet bulb 35 ° C

16.9.5.6 Storage Altitude

- 1060 to 700 hPa (-1250 to 9889 feet ASL) (795 to 525 mmHg)

16.9.5.7 Safety and Electromagnetic Compatibility

Refer to sections 16.3.9 and 16.3.11.

16.9.5.8 FCC Labeling

Panorama Wireless Transceiver

FCC ID: DXXVT0190-00000

This device complies with part 15 of the FCC rules.

NOTE: **Operation is subject to the following two conditions: (1) this device may not cause harmful interference, and (2) this device must accept any interference received, including interference that may cause undesired operation of the device.**

16.10 Telepack Specifications

The following are the specifications for the Telepack:

TABLE 16-5

SPECIFICATION	DESCRIPTION
Acquired Leads	ECG 3-Lead: I, II, III (one vector at a time) ECG 5-Lead: Three vectors (I, II, III, aVR, aVF, V(n))
Battery Type and Runtime	40 hrs minimum (Telepack-608) 24 hrs minimum (Telepack-608 with Nonin SpO ₂ module) 24 hrs minimum (Telepack 2.4) 16 hrs minimum (Telepack 2.4 with Nonin SpO ₂ module) Conditions: All Telepack units using two (2) AA alkaline cells with ECG at a HR of 60 bpm common to the Panorama Central Station (using battery P/N 0146-00-0077-XX)
Battery Shelf Life	The battery shelf life is indicated on the battery casing.
Lead Current	Max lead current: 25nA

16.10.1 Safety Designations

TABLE 16-6

DESIGNATION	DESCRIPTION
Degree of protection against electric shock	ECG-Type CF defibrillation protected.
Supply Connection	3 VDC Internal Battery
Mode of Operation	Continuous
Protection Against Hazards of Explosion	Not Protected (Ordinary)
Degree of Electrical Connection between Equipment and Patient	Equipment designed for direct electrical connection to the patient
Degree of Mobility	Transportable, Intra Hospital
Protection against ingress of liquid (please refer to your device):	
Protected against splashing water	IPX4 (with or without SpO ₂ module attached)

16.10.2 Panorama Server Analysis

The bedside monitor collects and analyses patient information and then transfers its analysis to the Panorama Central Station through the Panorama Telemetry Server; therefore, no calculations are performed by the Panorama Telemetry Server.

16.10.3 Environmental Characteristics

The environmental characteristics of the Telepack device are as follows:

TABLE 16-7

SPECIFICATION	DESCRIPTION
Maximum Size (Telepack)	Height: 5.10" (129.54 mm) Width: 2.95" (74.93 mm) Depth: 1.23" (31.24 mm)
Operating Environment	Temperature: + 5 °C to + 40 °C (+41 °F to +104 °F) Altitude: 1060 hPa to 700 hPa -1250 feet to 9889 feet ASL -380 m to 3014 m 795 mmHg to 525 mmHg
Operating and Storage Humidity	Storage: 10% to 90% maximum, non-condensing Operating: 15% to 90% maximum, non-condensing
Storage Temperature	-20 °C to +60 °C (-4 °F to +140 °F)
Storage Altitude	1,060 hPa to 700 hPa -1250 feet to 9,889 feet ASL -380 m to 3,014 m 795 mmHg to 525 mmHg

16.10.4 Electromagnetic Compatibility

The following section describes the electromagnetic compatibility of the Telepack device.

NOTE: The Telepack needs special precautions regarding Electro Magnetic Compatibility (EMC) and needs to be installed and put into service according to the EMC information provided in this section.

NOTE: Portable and mobile RF communications equipment can affect the Telepack. See Table 16-8 on page 16-24, Table 16-9 on page 16-24, Table 16-10 on page 16-26 and Table 16-11 on page 16-27.

TABLE 16-8**GUIDANCE AND DECLARATION - ELECTROMAGNETIC EMISSIONS**

It is important that the Telepack is used in the electromagnetic environment specified in the following table.

EMISSIONS TEST	COMPLIANCE	ELECTROMAGNETIC ENVIRONMENT - GUIDANCE
RF emissions CISPR 11	Group 1	The Telepack uses RF energy only for its internal function and external data transmission. However, its RF emissions are very low and are not likely to cause any interference in nearby electronic equipment.
RF emissions CISPR 11	Class A	The Telepack is suitable for use in all establishments other than domestic establishments and those directly connected to the public low-voltage power supply network that supplies buildings used for domestic purposes.
Harmonic emissions IEC 61000-3-2	N/A	
IEC 61000-3-3 Voltage fluctuations/ Flicker emissions	N/A	

TABLE 16-9**GUIDANCE AND DECLARATION - ELECTROMAGNETIC IMMUNITY**

It is important that the Telepack is used in the electromagnetic environment specified in the following table.

IMMUNITY TEST	IEC 60601 TEST LEVEL	COMPLIANCE LEVEL	ELECTROMAGNETIC ENVIRONMENT - GUIDANCE
Electrostatic discharge (ESD) IEC 61000-4-2	±6 kV contact ±8 kV air	±6 kV contact ±8 kV air	Floors should be wood, concrete or ceramic tile. If floors are covered with synthetic material, the relative humidity should be at least 30%.
Electrical fast transient/burst IEC 61000-4-4	±2 kV for power supply lines ±1 kV for input/output lines	N/A *	Mains power quality should be typical of a commercial or hospital environment.
Surge IEC 61000-4-5	±1 kV differential mode ±2 kV common mode	N/A *	Mains power quality should be typical of a commercial or hospital environment.

U_T is the a.c. mains voltage prior to application of the test level.

* Telepack operates only from the internal battery

TABLE 16-9 (Continued)**GUIDANCE AND DECLARATION - ELECTROMAGNETIC IMMUNITY**

It is important that the Telepack is used in the electromagnetic environment specified in the following table.

IMMUNITY TEST	IEC 60601 TEST LEVEL	COMPLIANCE LEVEL	ELECTROMAGNETIC ENVIRONMENT - GUIDANCE
Voltage dips, short interruptions and voltage variations on power supply input lines IEC 61000-4-11	<5% U_T (>95% dip in U_T) for 0,5 cycle	N/A *	Mains power quality should be typical of a commercial or hospital environment. If the user requires continued operation during power mains interruptions, it is recommended that the device be powered from an uninterruptible power supply or a battery.
	40% U_T (60% dip in U_T) for 5 cycles		
	70% U_T (30% dip in U_T) for 25 cycles		
	< 5% U_T (>95% dip in U_T) for 5 sec		
Power frequency (50/60 Hz) magnetic field IEC 61000-4-8	3 A/m	3 A/m	Power frequency magnetic fields should be at levels characteristic of a typical location in a typical commercial or hospital environment.

U_T is the a.c. mains voltage prior to application of the test level.

* Telepack operates only from the internal battery

TABLE 16-10**GUIDANCE AND DECLARATION - ELECTROMAGNETIC IMMUNITY**

It is important that the Telepack is used in the electromagnetic environment specified in the following table.

IMMUNITY TEST	IEC 60601 TEST LEVEL	COMPLIANCE LEVEL	ELECTROMAGNETIC ENVIRONMENT - GUIDANCE
Conducted RF IEC 61000-4-6	3 Vrms 150 kHz to 80 MHz	N/A	<p>Portable and mobile RF communications equipment should be used no closer to any part of the Telepack, including cables, than the recommended separation distance calculated from the equation applicable to the frequency of the transmitter.</p> <p>Recommended separation distance</p> $d = 1.2 \times \sqrt{P}$
Radiated RF IEC 61000-4-3	3 V/m 80 MHz to 2.5 GHz	3 V/m	<p>$d = 1.2 \times \sqrt{P}$ 80 MHz to 800 MHz</p> <p>$d = 2.3 \times \sqrt{P}$ 80 MHz to 2.5 GHz</p> <p>Where P is the maximum output power rating of the transmitter in watts (W) according to the transmitter manufacturer and d is the recommended separation distance in meters (m).</p> <p>Field strengths from fixed RF transmitters, as determined by an electromagnetic site survey* should be less than the compliance level in each frequency range.</p> <p>Interference may occur in the vicinity of equipment marked with the following symbol: </p>

NOTE: At 80 MHz and 2.5 GHz MHz, the higher frequency range applies.

NOTE: The EMC guidelines in Table 16-10 on page 16-26 may not apply in all situations. Electromagnetic propagation is affected by absorption and reflection from structures, objects and people.

* Field strengths from fixed transmitters, such as base stations for radio (cellular/cordless) telephones and land mobile radios, amateur radio, AM and FM radio broadcast and TV broadcast cannot be predicted theoretically with accuracy. To assess the electromagnetic environment, due to fixed RF transmitters, an electromagnetic site survey should be considered. If the measured field strength where the Telepack is used exceeds the applicable RF compliance level, the Telepack should be observed to verify normal operation. If abnormal performance is observed, additional measures may be necessary, such as reorienting or relocating the Telepack.

TABLE 16-11**RECOMMENDED SEPARATION DISTANCES BETWEEN PORTABLE AND MOBILE RF COMMUNICATIONS EQUIPMENT AND THE TELEPACK**

The Telepack is intended for use in an electromagnetic environment where radiated RF disturbances are controlled. Prevent electromagnetic interference by maintaining a minimum distance between portable and mobile RF communications equipment (transmitters) and the Telepack as recommended in the following table, according to the maximum output power of the communications equipment.

RATED MAXIMUM OUTPUT POWER OF TRANSMITTER W (WATTS)	SEPARATION DISTANCE ACCORDING TO FREQUENCY OF TRANSMITTER M (METERS)		
	150 KHZ TO 80 MHZ $D = 1.2 \times \sqrt{P}$	80 MHZ TO 800 MHZ $D = 1.2 \times \sqrt{P}$	800 MHZ TO 2.5 GHZ $D = 2.3 \times \sqrt{P}$
0.01	0.12	0.12	0.23
0.1	0.38	0.38	0.73
1	1.2	1.2	2.3
10	3.8	3.8	7.3
100	12	12	23

For transmitters rated at a maximum output power not listed above, the recommended separation distance d in meters (m) can be determined using the equation applicable to the frequency of the transmitter, where P is the maximum output power rating of the transmitter in watts (W) according to the transmitter manufacturer.

NOTE: At 80 MHz and 800 MHz, the separation distance for the higher frequency range applies.

NOTE: The separation distances guidelines in Table 16-11 on page 16-27 may not apply in all situations. Electromagnetic propagation is affected by absorption and reflection from structures, objects and people.

16.10.5 FCC Labeling

- Radio Transceiver - The Telepack-608 (FCC ID:DXXWT0191-00000) utilizes the frequency range 608 MHz - 614 MHz. Modulation is 2-level FSK.
- This device complies with part 15 of the FCC rules. Operation is subject to the following two conditions: (1) this device may not cause harmful interference, and (2) this device must accept any interference received, including interference that may cause undesired operation of the device.
- Radio Transceiver - The Telepack-2.4 (FCC ID DXXWT0707-00000) utilizes the frequency range 2400 MHz to 2500 MHz typical.
- This Class B digital apparatus meets all requirements of the Canadian Interference Causing Equipment Regulations. Operation is subject to the following two conditions: (1) this device may not cause harmful interference, and (2) this device must accept any interference received, including interference that may cause undesired operation.

Cet appareillage numérique de la classe B répond à toutes les exigences de l'interférence canadienne causant des règlements d'équipement. L'opération est sujette aux deux conditions suivantes: (1) ce dispositif peut ne pas causer l'interférence nocive, et (2) ce dispositif doit accepter n'importe quelle interférence reçue, y compris l'interférence qui peut causer l'opération peu désirée.

- The Telepack-2.4 complies with FCC/IC radiation exposure limits set forth for an uncontrolled environment. The Telepack-2.4 is in direct contact with the body of the user under normal operating conditions. This transmitter must not be co-located or operating in conjunction with any other antenna or transmitter.

16.10.6 Compliance

The Telepack complies with the following standards:

AGENCY AND INDUSTRY STANDARDS

EN 60601-1:1990/IEC 60601-1:1988 and A1:1991 and A2:1995

EN 60601-2-27:1994/IEC 60601-2-27:1994

IEC 60601-1-2:2001

UL2601-1:1997

CSA Standard C22.2 No. 601.1 M90

ANSI/AAMI EC 13:2002

IEEE 802.11 Std 802.11:1999 - Part 11

ISTA: Test Procedure 2A

FDA Reviewer Guidance for Pre-Market Notification Submissions (1993 Draft) (m)(7)(ii)(f)

FCC:47CFR, Part 15, Sub Part C-Computing Devices, Part 95, Sub Part H - Wireless Medical Telemetry Service (WMTS)

16.10.7 Specific Absorption Rate

The Panorama Telepack meets the government's requirements for exposure to radio waves.

The Telepack is a radio transmitter and receiver. It is designed and manufactured not to exceed limits for exposure to radio frequency (RF) energy set forth by the Federal Communications Commission (FCC) of the U.S. Government and by Industry Canada. These limits are part of comprehensive guidelines and establish permitted levels of RF energy for the general population. These guidelines are based on standards that were developed by independent scientific organizations through periodic and thorough evaluation of scientific studies. These standards include a substantial safety margin designed to assure the safety of all persons, regardless of age or health.

The exposure standard employs a unit of measurement known as the Specific Absorption Rate, or SAR. The SAR limit set by the FCC and Industry Canada is 1.6 W/kg.

The Panorama Telepack has been evaluated for body-worn Specific Absorption Rate (SAR) compliance under FCC Bulletin OET 65C and found to be compliant to the requirements as set forth in CFR 47 Sections 2.1093 and 15.242 addressing RF exposure from radio frequency devices. The highest SAR level measured was 0.002 W/kg.

16.11 Nonin SpO₂ Module Specifications

16.11.1 Environmental Characteristics

The environmental characteristics for the Nonin SpO₂ module device are:

TABLE 16-12

SPECIFICATION	DESCRIPTION
Maximum Size of Telepack with Nonin SpO ₂ module	Height: 6.25" (158.75 mm) Width: 3.55" (90.17 mm) Depth: 1.75" (44.45 mm)
Maximum Weight (Nonin SpO ₂ module)	4.5 oz. excluding cable and sensor
Temperature	Operating: + 5 °C to + 40 °C Storage: - 20 °C to + 50 °C
Humidity	Operating: 10% to 90% maximum, non-condensing Storage: 10% to 95% maximum, non-condensing

16.11.2 Measurement Specifications

The measurement specifications for the Nonin SpO₂ module are:

SPECIFICATION	DESCRIPTION
Oxygen Saturation Range	0 to 100%
Pulse Rate Range	18 to 300 pulses per minute
Measurement wavelength red	660 nanometers @3mW nominal
	NOTE: Information about wavelength range can be especially useful to clinicians.
Measurement wavelength infrared	910 nanometers @3mW nominal
	NOTE: Information about wavelength range can be especially useful to clinicians.
SPO₂ ACCURACY	
SpO ₂ (70-100%) (±1 standard deviation)	
No Motion	reusable finger clip ± 2 digits disposable ± 3 digits low perfusion ± 2 digits
Motion	reusable finger clip ± 2 digits low perfusion ± 2 digits
PULSE RATE ACCURACY	
	no motion adults (18-300 bpm): ± 3 digits
	motion adults (40-240 bpm): ± 5 digits
	low perfusion adults (40-240 bpm): ± 3 digits
DATA UPDATE RATE	
	SpO ₂ value and heart rate is updated 3 times per second

16.11.3 Electromagnetic Compatibility

The following section describes the electromagnetic compatibility of the Nonin SpO₂ device.

The Nonin SpO₂ module meets the requirements of:

- IEC 60601-1-2
- ISO 9919

TABLE 16-13

GUIDANCE AND DECLARATION - ELECTROMAGNETIC EMISSIONS

It is important that the Nonin SpO₂ module is used in the electromagnetic environment specified in the following table.

EMISSIONS TEST	COMPLIANCE	ELECTROMAGNETIC ENVIRONMENT - GUIDANCE
RF emissions CISPR 11	Group 1	The Nonin SpO ₂ module uses RF energy only for its internal function and external data transmission. However, its RF emissions are very low and are not likely to cause any interference in nearby electronic equipment.
RF emissions CISPR 11	Class B	The Nonin SpO ₂ module is suitable for use in all establishments other than domestic establishments and those directly connected to the public low-voltage power supply network that supplies buildings used for domestic purposes.
Harmonic emissions IEC 61000-3-2	N/A	
IEC 61000-3-3 Voltage fluctuations/ Flicker emissions	N/A	

TABLE 16-14

GUIDANCE AND DECLARATION - ELECTROMAGNETIC IMMUNITY

It is important that the Nonin SpO₂ module is used in the electromagnetic environment specified in the following table.

IMMUNITY TEST	IEC 60601 TEST LEVEL	COMPLIANCE LEVEL	ELECTROMAGNETIC ENVIRONMENT - GUIDANCE
Electrostatic discharge (ESD) IEC 61000-4-2	±6 kV contact ±8 kV air	±6 kV contact ±8 kV air	Floors should be wood, concrete or ceramic tile. If floors are covered with synthetic material, the relative humidity should be at least 30%.
Electrical fast transient/burst IEC 61000-4-4	N/A	N/A*	Mains power quality should be typical of a commercial or hospital environment.

* *The Nonin SpO₂ module receives power from the Telepack which operates only from an internal battery.*

TABLE 16-14 (Continued)**GUIDANCE AND DECLARATION - ELECTROMAGNETIC IMMUNITY**

It is important that the Nonin SpO₂ module is used in the electromagnetic environment specified in the following table.

IMMUNITY TEST	IEC 60601 TEST LEVEL	COMPLIANCE LEVEL	ELECTROMAGNETIC ENVIRONMENT - GUIDANCE
Surge IEC 61000-4-5	N/A	N/A*	Mains power quality should be typical of a commercial or hospital environment. If the user of the device required continued operation during power mains interruptions, it is recommended that the device be powered from an uninterruptible power supply or battery pack.
Voltage dips, short interruptions and voltage variations on power supply input lines IEC 61000-4-11	N/A	N/A*	Mains power quality should be typical of a commercial or hospital environment. If the user requires continued operation during power mains interruptions, it is recommended that the device be powered from an uninterruptible power supply or a battery.
Power frequency (50/60 Hz) magnetic field IEC 61000-4-8	3 A/m	3 A/m	Power frequency magnetic fields should be at levels characteristic of a typical location in a typical commercial or hospital environment.

* *The Nonin SpO₂ module receives power from the Telepack which operates only from an internal battery.*

TABLE 16-15**GUIDANCE AND DECLARATION - ELECTROMAGNETIC IMMUNITY**

It is important that the Nonin SpO₂ module is used in the electromagnetic environment specified in the following table.

Portable and mobile RF communications equipment should be used no closer to any part of the device, including cables, than the recommended separation calculated from the equation applicable to the frequency of the transmitter.

IMMUNITY TEST	IEC 60601 TEST LEVEL	COMPLIANCE LEVEL	ELECTROMAGNETIC ENVIRONMENT - GUIDANCE
Conducted RF IEC 61000-4-6	3 Vrms 150 kHz to 80 MHz	3 V	Recommended separation distance $d = 1.17 \times \sqrt{P}$
Radiated RF IEC 61000-4-3	3 V/m 80 MHz to 2.5 GHz	3 V/m	$d = 1.17 \times \sqrt{P}$ 80 MHz to 800 MHz $d = 2.33 \times \sqrt{P}$ 80 MHz to 2.5 GHz Where P is the maximum output power rating of the transmitter in watts (W) according to the transmitter manufacturer and d is the recommended separation distance in meters (m). Field strengths from fixed RF transmitters, as determined by an electromagnetic site survey, ^a should be less than the compliance level in each frequency range. ^b Interference may occur in the vicinity of equipment marked with the following symbol: 

NOTE: At 80 MHz and 800 MHz, the higher frequency range applies.

NOTE: The EMC guidelines in Table 16-15 on page 16-33 may not apply in all situations. Electromagnetic propagation is affected by absorption and reflection from structures, objects and people.

- a* Field strengths from fixed transmitters, such as base stations for radio (cellular/cordless) telephones and land mobile radios, amateur radio, AM and FM radio broadcast and TV broadcast cannot be predicted theoretically with accuracy. To assess the electromagnetic environment, due to fixed RF transmitters, an electromagnetic site survey should be considered. If the measured field strength where the Nonin SpO₂ module is used exceeds the applicable RF compliance level, the Nonin SpO₂ module should be observed to verify normal operation. If abnormal performance is observed, additional measures may be necessary, such as reorienting or relocating the Nonin SpO₂ module.
- b* Over the frequency range 150 kHz to 80 MHz, field strengths should be less than 3 V/m.

TABLE 16-16**RECOMMENDED SEPARATION DISTANCES BETWEEN PORTABLE AND MOBILE RF COMMUNICATIONS EQUIPMENT AND THE NONIN SPO₂ MODULE**

The Nonin SpO₂ module is intended for use in an electromagnetic environment where radiated RF disturbances are controlled. Prevent electromagnetic interference by maintaining a minimum distance between portable and mobile RF communications equipment (transmitters) and the Nonin SpO₂ module as recommended in the following table, according to the maximum output power of the communications equipment.

RATED MAXIMUM OUTPUT POWER OF TRANSMITTER W (WATTS)	SEPARATION DISTANCE ACCORDING TO FREQUENCY OF TRANSMITTER M (METERS)		
	150 KHZ TO 80 MHZ	80 MHZ TO 800 MHZ	800 MHZ TO 2.5 GHZ
	$D = 1.17 \times \sqrt{P}$	$D = 1.17 \times \sqrt{P}$	$D = 2.33 \times \sqrt{P}$
0.01	0.12	0.12	0.23
0.1	0.37	0.37	0.74
1	1.2	1.2	2.3
10	3.7	3.7	7.4
100	12	12	23

For transmitters rated at a maximum output power not listed above, the recommended separation distance d in meters (m) can be determined using the equation applicable to the frequency of the transmitter, where P is the maximum output power rating of the transmitter in watts (W) according to the transmitter manufacturer.

NOTE: At 80 MHz and 800 MHz, the separation distance for the higher frequency range applies.

NOTE: The separation distances guidelines in Table 16-16 on page 16-34 may not apply in all situations. Electromagnetic propagation is affected by absorption and reflection from structures, objects and people.

16.12 Panorama Instrument Radio-608

16.12.1 Approved Accessory

Kit, Instrument Radio-608, Passport 2/Spectrum (P/N 0040-00-0361-01)

16.12.2 FCC Label

- Radio Transceiver - The Panorama Instrument Radio-608 (FCC ID:DXXRA0743-00000) utilizes the frequency range 608 MHz - 614 MHz and 1427MHz -1429.5 MHz. Modulation is 4-level FSK.
- This device complies with part 15 of the FCC Rules. Operation is subject to the following two conditions: 1) This device may not cause harmful interference, and 2) this device must accept any interference received, including interference that may cause undesired operation.

This section provides a glossary of terminology used throughout the Panorama Operating Instructions.

- Terms, Acronyms, and Abbreviations

17.1 Terms, Acronyms, and Abbreviations

TERMS	DEFINITIONS
Agent	The gas used to anesthetize a patient during surgery
Arrhythmia	Abnormal ECG rhythms
Bedside Monitor	A monitoring device that has its own user interface and does not require the Panorama Central Station to be its primary monitoring source
BSA	Body Surface Area
CI	Cardiac Index
CO	Cardiac Output
Heart Rate	Number of heartbeats detected during a one minute time period
Internet Protocol (IP)	TCP/IP is the standard protocol that defines the IP datagram as the unit of information passed across an Internet. IP provides the basis for connectionless, best effort packet delivery of services.
Invasive Blood Pressure (IBP) Monitoring Device	Method of obtaining blood pressure using an internal pressure sensor The instrumentation connected to the patient. The monitoring device acquires the patient data and then transmits it onto the network.
Non-Invasive Blood Pressure (NIBP)	Method of obtaining blood pressure using an external cuff
Panorama Central Network	Supports hardwired communication between Panorama Central Stations and laser printers
Panorama Patient Network	Supports hardwired communication of the real-time patient data collected by monitoring devices attached to the patient
Panorama Wireless Network	Supports wireless communications between the wireless monitoring devices and the Panorama Server.
PAWP	Pulmonary Artery Wedge Pressure
Persistent	Data or settings maintained and remain available until purposely edited or deleted
Respiration	Number of breaths during a one minute time period
SpO₂	Level of Oxygen Saturation in the blood
ST	The ST portion of the ECG waveform

ACRONYMS/ ABBREVIATIONS	DEFINITIONS
ADT	Admit Discharge Transfer
AHA	American Heart Association American Hospital Association
ART	Arterial Line
AXI	Axillary
BLA	Bladder
bpm	Beats per minute
C	Current ST Chest Lead (IEC)
CCI	Continuous Cardiac Index
CCI STAT	Continuous Cardiac Index STAT
CCO	Continous Cardiac Output
CCO STAT	Continous Cardiac Output STAT
cm	Centimeters
CIS	Clinical Information System
C-LAN	Panorama Central Network
CO₂	Carbon Dioxide
CVA	Cardiovascular Artifact
CVP	Central Venous Pressure
Des	Desoflurane
DL	Down Link
ECG	Electrocardiogram
E-LAN	Panorama Patient Network
EMC	Electromagnetic Compatibility
Enf	Enflurane
EMR	Electronic Medical Records
EPM	Spectrum/Spectrum OR External Parameter Module
ESO	Esophageal
ET	End-Tidal when referencing CO ₂ /O ₂ /N ₂ O/Agent parameters Elapsed Time when referencing NIBP
F	Left Leg when referring to ECG Leads (IEC)
Hal	Haloflurane
HIS	Hospital Information System
HR	Heart Rate

ACRONYMS/ ABBREVIATIONS	DEFINITIONS
IBP	Invasive Blood Pressure
ICP	Intracranial Pressure
IEC	International Electro-Technical Commission
in	Inches
INSP	Inspired
IP	Internet Protocol
ISO	Isoflurane when referencing Agent Isoelectric when referencing ST monitoring
kg	Kilograms
kPa	Kilopascals Per Atmosphere
L	Left Arm when referring to ECG Leads (IEC)
LA	Left Arm when referring to ECG Leads (AHA)
lbs	Pounds
LL	Left Leg when referring to ECG Leads (AHA)
LV	Left Ventricle
MAP	Mean Arterial Pressure
MDD	Medical Device Directive
mmHg	Millimeters of Mercury
N	Right Leg when referring to ECG Leads (IEC)
N₂O	Nitrous Oxide
NAS	Nasal
NIBP	Non-Invasive Blood Pressure
NSR	Normal Sinus Rhythm
O₂	Oxygen
PA	Pulmonary Artery
Pleth	Plethysmograph
PVC	Premature Ventricular Contraction
R	Right Arm when referring to ECG Leads (IEC) Referenced ST
RA	Right Atrium when referring to IBP Right Arm when referring to ECG Leads (AHA)
REC	Rectal
RESP	Respiration Rate
RL	Right Leg when referring to ECG Leads (AHA)

ACRONYMS/ ABBREVIATIONS	DEFINITIONS
rpm	Respirations per minute
ScvO₂	Central Venous Oxygen Saturation
Sev	Sevoflurane
SKI	Skin
SpO₂	Oxygen Saturation
SvO₂	Mixed Venous Saturation
SVR	System Vascular Resistance
SVRI	System Vascular Resistance Index
TEMP	Temperature
UA	Umbilical Artery
V	Chest Lead (AHA)

This page intentionally left blank.

A

- Abbreviations, 17-2
- AC Dropout, 16-16
- Access Points/Antennas, 16-18 (ISM), 16-18
- Access Points/Antennas (ISM), 16-18
- Accessing
 - Additional (More) Tabs, 9-39
 - Additional Reports, 8-40
 - Alarm Limits tab, 6-4
 - Alarm Responses tab, 6-12
 - All ECG Mode from the Bedside tab, 7-9
 - Bedside tab, 7-2
 - Care Group tab, 9-9
 - Date/Time tab, 9-41
 - Demographics tab, 5-3
 - Discharge tab, 5-37
 - Disclosure tab, 7-41
 - Display tab, 5-41
 - Equipment Setup tab, 9-33
 - Events tab, 7-24
 - Events tab Waveforms View, 7-34
 - Installation Setup tab, 9-7, 9-29
 - Parameter Color tab, 9-2
 - Patient Alarm Setup tab, 6-2
 - Patient Reports tab, 8-2, 8-29
 - Previous Tabs, 9-40
 - Print Setup tab, 5-57, 9-45
 - Recalibrate Touch Screen tab, 9-4
 - ST tab, 7-54
 - Standby tab, 5-51
 - Transfer tab, 5-23
 - Trends tab, 7-14
 - Unit Choices tab, 9-50
 - Unit Priorities tab, 9-47
 - Volume tab, 9-11
 - Wave Gain tab, 9-59
 - Wave Gain tab (Patient), 5-54
 - Wireless tab, 9-62
- Acronyms, 17-2
- Adding
 - a Pager, 15-4
 - All Patient Tiles to a Pager, 15-6
- Adding a Pager, 15-4
- Adding All Patient Tiles to a Pager, 15-6
- Additional Reports, 8-40
- Adjusting
 - Patient Wave Gain Settings, 5-55
 - System Wave Gain Settings, 9-59
- AHA and IEC, Lead Placement Methods, *See also* Lead Placement Methods, 4-3
- Alarm
 - Behaviors, 3-2, 3-6
 - Delay, 3-4
 - Indicator Area, 7-21
 - Indicators, 7-26
 - Limit Settings, 13-2
 - Limits, 2-24
 - Limits tab (Patient), 6-4
 - Options, 3-3, 3-6
 - Priorities, 3-4
 - Responses, 2-25, 3-6
 - Responses tab (Patient), 6-12
- Alarm Behaviors, 3-2, 3-6
- Alarm Limit Settings, 13-2
- Alarm Limits (Patient) tab sidebar buttons, 6-7
- Alarm Limits Tab (Patient), 6-4
- Alarm Options, 3-3, 3-6
- Alarm Priorities, 3-4
- Alarm Priority
 - 1, 3-5
 - 2, 3-5
 - 3, 3-5
 - Off, 3-5
- Alarm Response, 16-4
- Alarm Responses, 3-6
- Alarm Responses Tab (Patient), 6-12
- Alarm Responses tab (Patient) sidebar buttons, 6-15
- Alarms, 5-25, 5-29 technical, 13-19
- All
 - Patient Tiles from a Pager, Removing, *See also* Removing, 15-6
 - Strips Report (All Patients) *See also* Report, 8-30
- All ECG sidebar button, 7-8, 7-50
- All Patient Tile Assignments in the Network tab, Removing, *See also* Removing, 14-4
- All Strips (All Patients) Report, 8-30
- All Strips Report, 8-2
- AlIECG sidebar button, 7-8, 7-38
- Anesthetic Agents
 - Iso, Enf, Des, Sev, Hal, Agent, 12-7
- Apnea Latching, 3-4
- Approved Accessories, 10-15
- Approved Accessory, 16-34
- Approved Telepack Accessories, 10-15
- Arrhythmia, 5-20, 9-58 (Telepack), 9-58
- Alarms, 4-14
- Algorithm, 4-11
- Analysis, 16-5
- Setup, 5-13, 9-55
- Arrhythmia Alarms, 4-14
- Arrhythmia Algorithm, 4-11
- Arrhythmia Analysis, 16-5
- Arrhythmia Settings, 8-27, 8-57
- Arrhythmia Setup, 5-13
- Arrhythmia Setup (Telepack), 9-55
- Arrow buttons
 - Double Down Arrow button, 7-36, 7-48
 - Double Left Arrow button, 7-36, 7-49
 - Double Right Arrow button, 7-37, 7-49
 - Double Up Arrow button, 7-36, 7-48
 - Down Arrow button, 7-36, 7-48
 - Left Arrow button, 7-37, 7-38, 7-49, 7-50
 - Right Arrow button, 7-37, 7-38, 7-49, 7-50
 - Up Arrow button, 7-36, 7-48
- Assigning
 - Patient Tile to a Care Group, 9-10
 - Patient Tiles, 15-5
 - Patient Tiles in the Network tab, 14-2
- Assigning a Patient Tile to a Care Group, 9-10
- Assigning Patient Tiles in the Network Tab, 14-2
- Asystole Alarm, 4-15
- Attaching the Finger Clip Sensor, 10-13
- Attendant Present Buttons, 10-3
- Attendant Present buttons, Telepack, *See also* Telepack, 10-3
- Audio Indicators, 3-2, 3-6
- Auto Set Alarms button, 6-6
- Auto-Admitting a Patient, 2-21
- Auto-Admitting a Patient, Quick Reference Guide, *See also* Quick Reference Guide, 2-21

B

Battery
 Percentage, 12-12
 Status LED Indicator Light, 10-6
 Battery Percentage, 12-12
 Battery Status LED Indicator Light, 10-6
 Beat Detection and Typing, 4-13
 Bed field, 5-4
 Bedside
 Alarm Tracking, 3-3
 Bedside Tab, 7-2
 Bedside tab, 7-2
 All ECG View, 7-9
 All Waveforms View, 7-3
 sidebar buttons, 7-7, 7-11
 Bedside Tab (All ECG View), 7-9
 Bedside Tab (All Waveforms View), 7-3
 Bigeminy Alarm, 4-16
 Bradycardia (Brady) Alarm, 4-16

C

Cable Repeater, 16-20
 physical characteristics, 16-20
 Cancel
 selected print job, 8-39
 selected print job button, 8-39
 Cardiac
 Index, 12-10
 Output, 12-10
 Cardiac Index, 12-10
 Cardiac Output, 12-10, 12-11
 Care
 and Cleaning of the Touch Screen, 11-2
 Group, 5-20
 Care and Cleaning of the Touch Screen, 11-2
 Care Group
 Indicator, 2-8
 Care Group Tab, 9-9
 Care Group tab, 9-9
 Care Group tab (System), 9-9
 Central To Central Transfer Without Device, 5-25
 Changing
 a Patient's Wave Gain Settings, 5-55
 Displayed Waveform, 7-44
 Patient's Print Setup, 5-58

System Wave Gain Settings, 9-59
 Changing a Patient's Print Setup, 5-58
 Changing a Patient's Wave Gain Settings, 5-55
 Changing the Displayed Waveform, 7-44
 Changing the System Default Wave Gain Settings, 9-59
 Channel Type, 9-68
 CHECK Button, 10-4
 CHECK button, 10-4
 Choice Controls, 2-17
 Cleaning
 ECG Lead Sets, 11-4
 Telepack battery compartment, 11-4
 Telepack device, 11-3
 Cleaning and Disinfecting the Telepack Device, 11-3
 Cleaning the Battery Compartment, 11-4
 Cleaning the ECG Lead Sets, 11-4
 Cleaning the SpO2 Finger Clip Sensor, 11-6
 Cleaning the SpO2 Module, 11-5
 Clear sidebar button, 9-71
 Clearing Time Filters, 7-29, 9-19
 Clear button, 7-29, 9-19
 CO₂, 12-6
 Alarm, 16-7
 Performance Requirements, 16-7
 CO₂ , Parameter specifications, See also Parameter specifications, 12-6
 CO₂ Alarm, 16-7
 CO₂ Performance Requirements, 16-7
 Colored Vertical Cursor Line, 7-36, 7-48
 Comments
 field, 5-12
 sidebar button, 7-39, 7-51
 Comments Dialog Box (Optional), 7-38, 7-50
 Common Controls and Elements, 2-16
 buttons, 2-16
 Communication Range
 Telepack, 10-9
 Communications with the Panorama Gateway, 5-2
 Compliance, 16-28
 Components
 Bedside tab, 7-3

Bedside tab All ECG View, 7-10
 Disclosure tab Zoomed Out View, 7-42
 Display tab, 5-42
 Events tab Events Filter, 7-28, 9-19
 Events tab List View, 7-25
 ST tab, 7-55
 Trends tab Graphic View, 7-20
 Trends tab List View, 7-15
 Components of the All ECG View, 7-10
 Components of the All Waveforms View, 7-3
 Components of the Compressed View, 7-42
 Components of the Display Tab, 5-42
 Components of the Events Filter, 7-28, 9-19
 Components of the Graphic View, 7-20
 Components of the List View, 7-15, 7-25
 Components of the ST Tab, 7-55
 Components of the Waveforms View, 7-34, 7-47
 Config ST sidebar button, 7-58
 Configuring
 Alarm Responses, 6-14
 Care Groups, 5-15
 Default Report Waveform Parameters, 9-57
 Events tab Time Filters, 7-29, 9-19
 Parameter Filter, 7-31, 9-21
 Patient Alarm Limits, 6-5
 ST, 7-57
 ST (Device Dependent), 7-57
 the Display tab, 5-47
 Trend Display Interval, 5-48, 7-16
 Configuring a Trend Display Interval, 5-48, 7-16
 Configuring Alarm Responses, 6-14
 Configuring Care Groups, 5-15
 Configuring Default Report Waveform Parameters, 9-57
 Configuring Patient Alarm Limits, 6-5
 Configuring ST (Device Dependent), 7-57
 Configuring the Display Tab, 5-47
 Connect Field, 9-70

Couplet Alarm, 4-17
 Customizing a Patient's Print Setup, 5-58

D

Dashes (–) Digital Data, 12-13
 Data Display Area, 7-4, 7-10, 7-35, 7-48
 All ECG Mode, 7-10
 Normal Display Mode, 7-4
 Date
 and Time Text area, 7-38, 7-50
 area, 7-35
 field, 7-47
 Of Birth field, 5-11
 Date Of Birth field ranges, 5-11
 Date/Time
 area, 7-21
 Date/Time Tab, 9-41
 Date/Time tab, 9-41
 Delete
 All Print Jobs, 8-39
 All Print Jobs button, 8-39
 Events button, 7-27
 Failed Patient, 5-30
 Single Event button, 7-26
 Deleting
 Equipment in the Equipment List, 9-36
 Event Records, 7-26
 Deleting Equipment in the Equipment List, 9-36
 Deleting Event Records, 7-26
 Delta T Values, 12-8, 12-9
 Demographics, 5-25, 5-29
 Demographics Tab, 5-2
 Demographics tab, 5-2
 Bed field, 5-4
 Comments field, 5-12
 Device Label field, 5-4
 Doctor field, 5-12
 Entering data, 5-4
 First Name field, 5-5
 First name field, 5-5
 Gender field, 5-8
 Height field, 5-6
 ID field, 5-6
 Last Name field, 5-5
 DES INSP/ET ranges, 12-7
 Destination Panorama, 5-27
 Device
 ID, 9-66, 9-70
 Label field, 5-4

Device ID, 9-70
 Diastolic Pressure Measurement, 16-5
 Digital
 Data, 8-4, 8-32, 8-41, 8-45, 8-49
 Data Area, 7-4, 7-10, 7-35
 Data field, 7-47
 Data Tile, 2-9
 Parameter Data, 5-42
 Digital Data, 8-4, 8-32, 8-41, 8-45, 8-49
 Discharge, 2-22
 Quick Reference Guide, 2-22
 Discharge Tab, 5-37
 Discharging a Patient from a Telepack Device, 5-39
 Discharging a Patient from the Central Station, 5-38
 Discharging a Patient from the Central Station and the Bedside Monitor, 5-37
 Normal Screen button, 5-39
 Discharge tab, 5-37
 Accessing, 5-37, 7-41, 7-54
 Normal Screen button, 7-46, 7-59
 Discharge, Quick Reference Guide, See also Quick Reference Guide, 2-22
 Discharging a Patient, 5-37, 5-39
 Discharging a Patient from a Telepack-608 Device, 5-39
 Discharging a Patient from the Central Station, 5-38
 Discharging a Patient from the Central Station and the Bedside Monitor, 5-37
 Disclosure Data
 locating, 7-44
 Disclosure Tab, 7-41
 Disclosure tab, 7-41
 Waveforms View, 7-46
 Zoomed In View, 7-46
 Disclosure Tab (Waveforms View), 7-46
 Display, 2-23, 5-24, 5-28
 18.1" Flat Panel, 16-17
 19" Flat Panel, 16-17
 20" CRT, 16-17
 20" CRT Display, 16-17
 21" CRT, 16-16
 21" CRT Display, 16-16
 Choices sidebar button, 7-45

Time Interval, 7-21
 Display Tab, 5-41
 Display tab, 5-41
 sidebar buttons, 5-50
 Display, Quick Reference Guide, See also Quick Reference Guide, 2-23
 Displays, 16-16
 Disposal of the Telepack-608 Device, 11-6
 Disposing of Batteries, 11-7
 Doctor field, 5-12
 Double
 Down Arrow button, See also Arrows, 7-36, 7-48
 Left Arrow button, See also Arrows, 7-36, 7-49
 Right Arrow button, See also Arrows, 7-37, 7-49
 Up Arrow button, See also Arrows, 7-36, 7-48
 Down Arrow button, See also Arrows, 7-36, 7-48

E

ECG, 12-2
 Amplitude, 4-12
 Derived Heart Rate Meter Performance Requirements, 16-4
 Filters, 4-14
 Lead Sets, Cleaning, See also Cleaning, 11-4
 Performance Requirements, 16-2
 Respiration Performance Requirements, 16-6
 Thoracic Impedance, 12-3
 Waveform Format, 8-11
 Waveforms, 8-5, 8-32, 8-42, 8-46
 ECG Derived Heart Rate Meter Performance Requirements, 16-4
 ECG Lead Diagram LED Indicator Lights, 10-4
 ECG Performance Requirements, 16-2
 ECG Respiration Performance Requirements, 16-6
 ECG Waveform Measurements performing, 7-5, 7-11
 ECG Waveforms, 8-5, 8-42
 Editing
 Care Group Labels, 9-9

Paging numbers, 15-7
 Editing a Pager, 15-7
 Editing Care Group Labels, 9-9
 Effects of the Transfer, 5-24, 5-28
 Electrode Patches, 4-2
 Electrode Patches, placement, 4-2
 Electrode Placement
 neonatal, 4-9
 Electromagnetic Compatibility,
 16-12, 16-23, 16-31
 Entering
 Data in the Demographics
 tab, 5-4
 Data in the Display tab, 5-47
 New Equipment, 9-34
 Telepack to the Equipment
 List, 10-9
 Wireless Settings, 9-66
 Entering a Password, 6-2, 9-7,
 15-2
 Entering Data in the
 Demographics Tab, 5-4
 Entering New Equipment, 9-34
 Entering the Telepack-608 to the
 Equipment List, 10-9
 Entering Wireless Settings, 9-66
 Environmental Characteristics,
 16-23, 16-30
 Environmental Characteristics for
 the Panorama Wireless
 Transceiver/Splitters/
 Antennas, 16-20
 Equipment
 Report, 8-34
 Setup tab, 9-33
 Equipment Information, 8-34
 Equipment Report, 8-34
 Equipment Information, 8-34
 Equipment Setup Tab, 9-33
 Equipment Setup tab
 sidebar buttons, 9-36
 Error Log
 Data, 8-53
 Read sidebar button, 9-71
 sidebar button, 9-69
 Error Log Data, 8-53
 Error Log Sidebar Button, 9-69
 ET, 12-3
 Event
 Filter Text box, 7-28, 9-19
 Filtering, 7-28
 List Report, 8-21
 Markers, 7-42
 Record, 8-23
 Zoom In Report, 8-40
 Event Filtering, 7-28
 Event List Report, 8-21

Event Record, 8-23
 Event Zoom In Report, 8-40
 Events
 Filtering, 7-32
 Filtering sidebar button, 7-32
 List Alarm Indicators, 7-26
 List Filter sidebar button, 7-32
 Events Filter
 Cancel button, 7-29, 9-19
 Events Filtering
 Time Filters, 7-29, 9-19
 Time Interval Area, 7-35
 Time Interval field, 7-35, 7-47
 Events Tab, 7-24
 Events tab, 7-24
 Event Description Area, 7-35
 Event Description field, 7-47
 events filtering, 7-28
 List box Area, 7-25
 List View, 7-25
 See also List View, 7-25
 Waveforms View, 7-34
 Events Tab (List View), 7-25
 Events Tab (Waveforms View),
 7-34

F

FCC Label, 16-34
 Filtering
 Noise and Artifact Variables,
 4-11
 Pacer Signals, 4-12
 First
 name, 5-5
 First Name field, 5-5
 Footer, 8-6, 8-11, 8-16, 8-19,
 8-23, 8-27, 8-33, 8-35,
 8-37, 8-43, 8-46, 8-50,
 8-53, 8-57
 Free Channel Sidebar Button,
 9-72
 Free Channel sidebar button, 9-72
 Free Connected Channel Sidebar
 Button, 9-72
 Free Connected Channel sidebar
 button, 9-72
 Freeze sidebar button, 7-8
 Frequency Range, 16-19
 Full Disclosure
 Report, See also Reports, 8-6
 Zoom In Report, See also
 Reports, 8-43
 Zoom In ST dialog box, See
 also Reports, 7-49
 Full Disclosure Report, 8-6

Full Disclosure Zoom In Report,
 8-43

G

Gas Module, 12-3
 Gender field, 5-8
 General Alarm Behavior, 3-2
 Alarm behavior
 general, 3-2
 Generating a Graphic Trend
 Report, 7-22
 Generating a Paging Report, 15-9
 Generating a Patient Alarm
 Report, 6-9
 Generating an All Strips Report,
 7-8
 Generating an ST Report, 7-59
 Graphic Data, 8-49
 Graphic sidebar button, 7-18
 Graphic Trend Report, 8-47
 Graphic View of the Trends tab,
 7-20

H

Hardware Version field, 9-67
 Header, 8-4, 8-10, 8-15, 8-19,
 8-22, 8-26, 8-31, 8-34,
 8-36, 8-41, 8-45, 8-48,
 8-51, 8-53, 8-56
 Heart
 Rate, 12-2
 Rate-HR, 12-2
 Heart Rate
 HR, 12-2
 Meter, 4-12
 Source ECG, 12-2
 Source IBP, 12-2
 Source NIBP, 12-2
 Tile, 5-44
 Heart Rate Source
 ECG, 12-2
 IBP, 12-2
 NIBP, 12-2
 Height
 Dial dialog, 2-20
 field, 5-6
 Height field
 ranges, 5-7
 Horizontal Measurements
 (Amplitude), 7-6
 Horizontal Navigation buttons,
 7-36
 HR, 12-2

I

IBP, 12-2, 12-5
 (Dia), 12-5
 (Sys), 12-5
 Heart Rate Meter, 16-6
 Mean, 12-5
 mmHg, 12-5
 Pressure Range, 16-6
 Systolic, 12-5
 IBP Heart Rate Meter, 16-6
 IBP Pressure Range, 16-6
 ID field, 5-6
 Indicator Lights, 10-4
 Initial Setup of Telepack, 10-7
 Inserting Batteries, 10-7
 Inserting batteries
 Telepack, 10-7
 INSP/ET CO₂, 12-6
 INSP/ET CO₂, Parameter
 specifications, See also
 Parameter specifications,
 12-6
 INSP/ET N₂O, 12-7
 INSP/ET O₂, 12-6
 Installation Setup Tab, 9-7
 Installation Setup tab, 9-7
 Installing the Patient Cable, 10-12
 Installing the SpO₂ Module on the
 Telepack-608, 10-10
 Introduction, 10-2, 10-10
 Invalid Data Display, 12-13
 Irregular Heart Rate Alarm, 4-17
 Iso
 Enf, Des, Sev, Hal, Agent
 ,See also Anesthetic
 Agents, 12-7
 Iso Enf and Hal INSP/ET ranges,
 12-7

K

Keyboard, 16-16
 Keypad dialog box, 2-18

L

Last Name field, 5-5
 Latching, defined, 3-3
 Lead
 Placement Procedures, 4-2
 Selection, 9-67
 Lead II Monitoring, 4-7
 Lead Placement Methods
 AHA and IEC, 4-3

Lead Placement Procedures, 4-2
 LEAD SELECT Button, 10-3
 LEAD SELECT button, 10-3
 Lead Set
 10-wire, 4-6
 3-wire, 4-4
 5-wire, 4-4, 4-5
 Lead sets
 sterilizing, 11-5
 Lead sidebar button, 7-50
 Learning, 4-12, 4-14
 Lethal Arrhythmia Alarms, 4-15
 Licensing Key, 1-2
 Licensing Key, defined, 1-2
 Link Status LED Indicator Light,
 10-6
 List box, 9-70
 List sidebar button, 7-22
 List View
 Events tab, 7-25
 Trends tab, 7-14
 locating , See also Disclosure
 Data, 7-44
 Locating Specific Disclosure Data,
 7-44

M

Main Screen, defined, 2-7
 Mark Event sidebar button, 7-8
 Measure sidebar buttons, 7-8,
 7-39, 7-51
 Measurement Specifications,
 16-30
 Menu Bar, 2-10
 Menu Bar, defined, 2-10
 Menu buttons, defined, 2-11
 Message dialog boxes, defined,
 2-17
 Modified Chest Lead (MCL)
 Monitoring
 MCL, 4-8
 Modifying
 a Default Password, 9-30
 an Alarm Password, 9-30
 Equipment Included in the
 Equipment List, 9-35
 Equipment included in the
 Equipment List, 9-35
 Modifying a Default Password,
 9-30
 Modifying Equipment Included in
 the Equipment List, 9-35
 Monitoring a Pacemaker Patient,
 4-10
 More Tab, 9-39

More tab, 9-39
 Mouse, 16-16
 Setting the Waveform System
 Defaults, 9-48
 Muting Alarms, 2-25

N

N₂O, 12-7
 N₂O INSP/ET, 12-7
 Navigating in the
 Bedside tab All ECG Mode,
 7-11
 Bedside tab All ECG View,
 7-11
 Bedside tab All Waveforms
 View, 7-5
 Disclosure tab Waveform
 Area, 7-43
 Graphic View of the Trends
 tab, 7-22
 List View of the Events tab,
 7-26
 List View of the Trends tab,
 7-15
 List View of Trends tab, 7-15,
 7-26
 Normal Display Mode, 7-5
 Waveforms View of the
 Events tab, 7-36,
 7-48
 Navigating in the All ECG View,
 7-11
 Navigating in the All Waveforms
 View, 7-5
 Navigating in the Graphic View,
 7-22
 Navigating in the List View, 7-15,
 7-26
 Navigating in the Waveform
 Area, 7-43
 Navigating in the Waveforms
 View of the Disclosure Tab,
 7-48
 Navigating in the Waveforms
 View of the Events Tab, 7-36
 Neonatal Electrode Placement,
 4-9
 Network Printer, 1-20, 16-18
 Network Tab, 14-2
 Network tab, 14-2
 Next Event button, 7-15, 7-37,
 7-43, 7-49
 NIBP, 12-2, 12-3
 (Dia), 12-4
 (ET), 12-4

(Sys), 12-4
 Area, 7-3, 7-10, 7-35
 Diastolic, 12-4
 Mean, 12-4
 NIBP Area, 7-3
 NIBP field, 7-47
 NIBP Performance Characteristics, 16-5
 NIPB
 Systolic, 12-4
 Noise and Artifact, 4-11
 Variables, Filtering, See also Filtering, 4-11
 Non-ECG
 Waveform Format, 8-11
 Waveforms, 8-5, 8-33, 8-43, 8-46
 Non-ECG Waveforms, 8-43
 Nonin SpO₂, 12-5, 16-7
 Nonin SpO₂ Module
 Specifications, 16-30
 Non-Lethal Arrhythmia Alarms, 4-16
 Normal Screen
 button, 7-46, 7-59
 Normal Screen button, 5-39
 Normal Screen Sidebar Button, 5-39
 Nurse Call Button, 10-3
 Nurse Call button, 10-3
 Nurse Call button, Telepack, See also Telepack, 10-3

O

O₂, 12-6
 O₂ INSP/ET, 12-6
 Operating Altitude, 16-9, 16-21
 Operating Humidity, 16-9, 16-21
 Operating Instructions, 10-7
 operating instructions, Telepack, See also Telepack, 10-7
 Operating Temperature, 16-9, 16-20

P

Pacemaker Patient
 monitoring, 4-10
 Pacer, 5-20
 Signals, Filtering, See also Filtering, 4-12
 Pacer Configuration, 5-12
 Pager Information, 8-36
 Pager, Removing a, See also Removing a, 15-7

Paging
 adding a pager, 15-4
 Adding All Patient Tiles to a Pager, 15-6
 Comments sidebar button, 7-39, 7-51
 Password tab, 15-2
 Report, 8-35
 resending a failed page, 15-8
 Paging Delay Settings, 8-27, 8-57
 Paging Password Tab, 15-2
 Paging Report, 8-35
 Paging Tab, 15-4
 Paging tab, 15-4
 Panorama
 Central Station, about, 2-2
 Instrument Radio-608, 16-34
 Patient Monitoring Network, defined, 2-xvii
 Telemetry Server, defined, 2-xvii, 1-4
 Telemetry System, defined, 2-xvii
 Telepack-608, 1-18
 ViewStation, 1-3
 Wireless Transceiver, 1-4, 16-19, 16-21
 Panorama Antenna, 16-19
 physical characteristics, 16-19
 Panorama Central Station, 1-3
 performance specifications, 16-8
 Panorama Central Station and Panorama Telemetry Server, 16-8
 operating temperature, 16-9
 power supply, 16-9
 Panorama Central Station, defined, 2-2
 Panorama Instrument Radio-608, 16-34
 Panorama Server Analysis, 16-22
 Panorama Telemetry Server, 1-4
 Panorama Telepack, 1-18
 Panorama ViewStation and WorkStation, 1-3
 Panorama Wireless Transceiver, 1-4, 16-19
 Panorama Wireless Transceiver (Panorama Telepack-608 and Instrument Radio), 1-4
 Panorama Wireless Transceiver/Splitters/Antennas, 16-19
 Panorama Wireless Transceiver/Splitters/Antennas/Cable
 Repeaters, 16-19
 Parameter
 Areas, 7-21
 Color tab, 9-2
 Filters, 7-31, 9-20
 Specifications, 12-2
 Parameter Color Tab, 9-2
 Parameter Color tab, 9-2
 Parameter Filters, 7-31, 9-20
 Parameter Specifications
 N₂O INSP/ET, 12-7
 Parameter Specifications, 12-2
 Heart Rate, 12-2
 O₂, 12-6
 Parameter specifications
 CO₂, 12-3, 12-6
 ECG Thoracic Impedance, 12-3
 INSP/ET CO₂, 12-6
 INSP/ET N₂O, 12-7
 INSP/ET O₂, 12-6
 O₂ INSP/ET, 12-6
 Resp, 12-2
 SPO₂, 12-4
 ST, 12-9
 Paramter specifications
 T Blood Values, 12-9
 T1 and T2, 12-8
 Passport 2® Bedside Monitor, 1-5
 Passport 2® Bedside Monitor, 1-5
 Passwords Tab, 9-29
 Passwords tab, 9-29
 Patient
 Alarm Data, 8-26
 Alarm Report, 8-25
 Demographic Area, 7-25, 7-34
 Demographic field, 7-3, 7-10, 7-15, 7-20, 7-42, 7-47, 7-55
 Demographic Line, 7-42, 7-55
 Reports tab, 8-2
 Size field, defined, 5-11
 Patient Alarm Data, 8-26
 Patient Alarm Report, 8-25
 Patient Alarm Setup tab
 Optional, 6-2
 sidebar buttons, 6-3
 Patient Alarm Setup Tab (Optional), 6-2
 Patient Alarms, 2-24
 Patient from Standby Mode, Removing a, See also Removing a, 5-52
 Patient Reports Tab, 8-2
 Patient Setup functions

- Demographics tab, 5-2
 - Discharge tab, 5-37
 - Display tab, 5-41
 - Print Setup tab, 5-57
 - Standby tab, 5-51
 - Wave Gain tab, 5-54
 - Patient Size field
 - entering, 5-11
 - Patient Status Line, 2-10
 - Patient tile
 - REC button, 2-9
 - Patient Tile Assignment in the Network tab, Removing a, See also Removing a, 14-4
 - Patient Tile Assignment, Removing a, See also Removing a, 15-6
 - Patient Tiles, 2-7
 - Patient Tiles, defined, 2-7
 - Pause Alarm, 4-17
 - PAWP, 12-12
 - performance specifications, 16-20
 - Performing ECG Waveform Measurements, 7-5, 7-11
 - Physical Characteristics, 16-16, 16-19
 - Physiological
 - Alarm Event Messages, 13-13
 - Alarm Responses, 3-4
 - Physiological Alarm Event Messages, 13-14
 - Physiological Alarm Responses, 3-4
 - Physiological Alarms, 3-2
 - Physiological Alarms and Events, 13-2
 - Arrhythmias, 13-17
 - Placement Procedures, Lead, See also Lead, 4-2
 - Placing a Patient in Standby Mode, 5-51
 - Power Supply, 16-9, 16-19
 - power supply, Panorama Central Station and Panorama Telemetry Server, See also Panorama Central Station and Panorama Telemetry Server, 16-9
 - Power Up Sequence
 - Telepack, 10-9
 - Premature Ventricular Contraction (PVC), 12-8
 - Previous Event button, 7-15, 7-36, 7-43, 7-48
 - Previous sidebar button, 9-58
 - Previous Tab, 9-40
 - Previous tab, 9-40
 - Print on Alarm, 3-5
 - Print Setup Tab (Patient), 5-57
 - Print Setup tab (Patient), 5-57
 - sidebar buttons, 5-58
 - Print Setup Tab (System), 9-45
 - Print Setup tab (System), 9-45
 - Print Status Tab, 8-38
 - Print Status tab, 8-38
 - Print Status Tab List Box, 8-38
 - Print Status tab List box, 8-38
 - Printing a 12-lead Report, 8-52
 - Printing a Full Disclosure Report (ECG and Non-ECG Layout), 8-12
 - Printing a Full Disclosure Report from the Compressed View, 7-45
 - Printing a Full Disclosure Zoom In Report, 8-46
 - Printing a Full Disclosure Zoom In Report from the Waveforms View, 7-51
 - Printing a Graphic Trend Report, 8-50
 - Printing a Paging Report, 8-37
 - Printing a Patient Alarm Report, 8-27
 - Printing a System Alarm Report, 8-57
 - Printing a Telepack Error Log Report, 8-54
 - Printing a Trend List Report, 8-19
 - Printing a Trend List Report from the List View, 7-17
 - Printing an All Strips (All Patients) Report, 8-33
 - Printing an Event List Report, 8-23
 - Printing an Event Zoom In Report, 8-43
 - Printing an Event Zoom In Report from the Waveforms View, 7-39
 - Printing an Events List Report from the List View, 7-32
 - Printing an ST Report, 8-16
 - Printing the
 - 12-lead Report, 8-52
 - All Strips (All Patients) Report, 8-33
 - All Strips Report, 8-6
 - Equipment Report, 8-35
 - Event List Report, 8-23
 - Event Zoom In Report, 8-43
 - Events List Report from the List View, 7-32
 - Full Disclosure Report, 8-12
 - Full Disclosure Report (ECG and Non-ECG Layout), 8-12
 - Full Disclosure Report from the Zoomed Out View, 7-45
 - Full Disclosure Zoom In Report, 8-46
 - Graphic Trend Report, 8-50
 - Patient Alarm Report, 8-27
 - ST Report, 8-16
 - System Alarm Report, 8-57
 - Telepack Error Log Report, 8-54, 9-69
 - Trend Graphic Report, 8-50
 - Trend List Report, 8-19
 - Trend List Report from the List View, 7-17
 - Printing the Equipment Report, 8-35
 - Priority
 - 1 Alarms, 3-5
 - 2 Alarms, 3-5
 - 3 Alarms, 3-5
 - Off, 3-5
 - Program, 9-69
 - Program sidebar button, 9-69
 - Programming the Telepack, 10-8
 - Progress Bar, 2-17
 - Protocol Selection, 9-68
 - Pulmonary Artery Wedge Pressure (PAWP), 12-12
 - Pulse Rate, 16-6
 - PVC, 12-8
 - PVC/minute Alarm, 4-18
- ## Q
-
- Quick Reference Guide, 2-21
 - Auto-Admitting a Patient, 2-21
 - Discharge, 2-22
 - Display, 2-23
 - Viewing Disclosure data, 2-26
 - Viewing Events data, 2-26
 - Viewing List Trends, 2-25
 - Quick Reference Guide, Standby, See also Standby, 2-21
- ## R
-
- Range Bars, 7-21
 - Read, 9-68
 - Read sidebar button, 9-68
 - Real Time Clock, 16-8

REC button, 2-9
 Recalibrating the Touch Screen, 9-4
 Receiver Range, 16-19
 RECORD Button, 10-4
 RECORD button, 10-4
 Recording Password Changes, 9-31
 Recover Patient, 5-29
 Reference
 ST, 7-56
 Templates, 8-16
 Refreshing the
 Events List, 7-28
 List View, 7-28
 Network tab List box, 14-4
 Refreshing the List View, 7-28
 Refreshing the Network Tab List Box, 14-4
 Relearn sidebar button, 6-9
 Removing
 All Patient Tile Assignments in the Network tab, 14-4
 All Patient Tiles from a Pager, 15-6
 Print Jobs from the Print Queue, 8-38
 Removing a
 Pager, 15-7
 Patient from Standby Mode, 5-52
 Patient Tile Assignment, 15-6
 Patient Tile Assignment in the Network tab, 14-4
 Removing a Pager, 15-7
 Removing a Patient from Standby Mode, 5-52
 Removing a Patient Tile Assignment, 15-6
 Removing a Patient Tile Assignment in the Network Tab, 14-4
 Removing All Patient Tile Assignments in the Network Tab, 14-4
 Removing All Patient Tiles from a Pager, 15-6
 Removing Print Jobs from the Print Queue, 8-38
 Removing the Patient Cable, 10-14
 Removing the SpO2 Module from the Telepack, 10-11
 Report
 12-lead, 8-51
 12-lead Report, 8-51

Columns, 8-34
 Footer, 8-6, 8-11, 8-16, 8-19, 8-23, 8-27, 8-33, 8-35, 8-43, 8-46, 8-50, 8-53, 8-57
 Reports
 Additional, 8-40
 All Strips Report (All Patients), 8-30
 Equipment Report, 8-34
 Error Log Report, 8-53
 Event List Report, 8-21
 Event Zoom In Report, 8-40
 Full Disclosure Report, 8-6
 Full Disclosure Zoom In Report, 8-43
 Full Disclosure Zoom In ST dialog box, 7-49
 Graphic Trend Report, 8-47
 Paging Report, 8-35
 Patient Alarm Report, 8-25
 ST Report, 8-14
 System Alarm Report, 8-55
 Telepack Error Log Report, 8-53
 Trend Graphic Report, 8-47
 Trend List Report, 8-17
 Requirements, 16-18
 Resending a Failed Page, 15-8
 Respiration, 12-2
 CO2, 12-3
 ECG Thoracic Impedance, 12-3
 Gas Module, 12-3
 Resp, 12-2
 Respiration Source
 CO2, 12-3
 ECG Thoracic Impedance, 12-3
 Gas Module
 Parameter specifications
 Gas Module, 12-3
 Restore Previous Settings sidebar button, 5-50, 5-56, 5-58, 6-8, 6-15
 Retrieve Discharged Pt. sidebar button, 5-17
 Retrieving Discharged Patients, 5-17
 Right Arrow button, See also Arrows, 7-37, 7-38, 7-49, 7-50
 Room To Room Transfer Without Device, 5-23
 Run Alarm, 4-18

S

Safety and Electromagnetic Compatibility, 16-21
 Safety Designations, 16-22
 Save To Event, 3-5
 Save To Event, defined, 3-5
 Scrolling
 Parameters, 7-15, 7-22, 7-26
 Time Line, 7-22
 Trends List, 7-15, 7-26
 Securing the Telepack Device, 10-9
 Securing the Telepack-608 Device, 10-9
 Selecting a Color for Parameter Data, 9-2
 Selecting the
 Color for Parameter Data, 9-2
 Patient to be Set Up/Modified, 5-4
 Patient's Parameter Data, 5-47
 Unit Priority Order, 9-47
 Set Date/Time, 9-42
 Setting a Default Order in the Unit Priorities Tab, 9-47
 Setting the
 Date in the Date/Time tab, 9-42
 Default Order in the Unit Priorities tab, 9-47
 Patient Alarm Limits, 6-5
 Physiological Alarms Volume Level, 9-12
 System Alarms Limits, 9-23
 System Alarms Options, 9-15
 System Alarms Options (Central Station), 9-15
 System Alarms Options (ViewStation), 9-17
 System Alarms Responses, 9-27
 System Alarms Volume Level, 9-12
 System Default Print Setup, 9-46
 Time in the Date/Time tab, 9-43
 Unit Choices, 9-51
 Unit Choices (Central Station), 9-51
 Unit Choices (ViewStation), 9-55

- Volume Levels, 9-12
- Setting the System Alarm Limits, 9-23
- Setting the System Alarm Options (ViewStation and WorkStation), 9-17
- Setting the System Alarms Options (Central Station), 9-15
- Setting the System Alarms Responses, 9-27
- Setting the System Default Print Setup, 9-46
- Setting the Unit Choices (Central Station), 9-51
- Setting the Unit Choices (ViewStation and WorkStation), 9-55
- Settings (Telepack), 5-16, 9-56
- Sev INSP/ET ranges, 12-7
- Sidebar Button, 5-39
- Sidebar Button - Normal Screen, 5-39, 5-52, 9-2, 9-6, 9-8, 9-10, 9-13, 9-31, 9-44, 9-60, 9-72
- Sidebar Buttons, 2-15, 5-20, 5-29, 5-50, 5-56, 5-58, 6-3, 6-7, 6-15, 7-7, 7-11, 7-17, 7-22, 7-32, 7-38, 7-45, 7-50, 7-58, 8-39, 9-21, 9-24, 9-27, 9-36, 9-48, 9-58, 9-68, 15-3
- sidebar buttons
 - defined, 2-15
- Simultaneous
 - Alarm Limit Editing, 6-7
 - Patient Demographic tab Editing, 5-18
 - ST Configuration Editing, 7-58
- Simultaneous Alarm Limit Editing, 6-7
- Simultaneous Patient Demographic Tab Editing, 5-18
- Simultaneous ST Configuration Editing, 7-58
- Skin Preparation, 4-2
- Skip To sidebar button, 7-45
- Software Version field, 9-67
- Sorting
 - Network tab List box, 14-2
- Sorting the Contents of the Network Tab List Box, 14-2
- Source Panorama, 5-26
- Specifications
 - Heart Rate, 12-2
 - IBP, 12-5
 - NIBP, 12-3
 - PVC, 12-8
 - Respiration, 12-2
 - Telepack, 16-22
- Spectrum OR™ Bedside Monitor, 1-12
- Spectrum™ Bedside Monitor, 1-10, 1-12
- Splitter, 16-20
- SPO₂, 12-4
- SpO₂, 12-4, 16-6
- ST, 12-9
 - Alarm Delay, 3-4
 - button, 7-37, 7-49
 - Data, 8-15
 - Report, 8-14
 - Segment Analysis, 4-13, 16-4
 - Status field, 7-55
- ST Button, 7-37, 7-49
- ST Data, 8-15
- ST Report, 8-14
- ST Segment Analysis, 4-13, 16-4
- ST Tab, 7-54
- ST tab, 7-54
 - Current ST, 7-56
 - Current Templates, 8-16
 - Done sidebar button, 7-59
- ST Template Area (Device Dependent), 7-56
- ST Template Areas, 7-56
- Standby, 2-21
 - Quick Reference Guide, 2-21
- Standby Tab, 5-51
- Standby tab, 5-51
 - placing a patient in, 5-51
- Sterilization of the Lead Sets, 11-5
- Storage Altitude, 16-9, 16-21
- Storage Humidity, 16-9, 16-21
- Storage Temperature, 16-9, 16-21
- Storing the Telepack, 11-3
- Straight Line (Waveforms), 12-14
- Strip Setup sidebar button, 9-58
- Supported Devices, 1-3
- Suspend
 - All Alarms (Optional), 6-8, 6-15
 - Non-Lethal, 6-8, 6-15
- System Alarm
 - Information, 8-56
 - Limits, 9-28
 - Options, 9-24
 - Report, 8-55
- System Alarm Information, 8-56
- System Alarm Limits sidebar button, 9-28
- System Alarm Options sidebar button, 9-27
- System Alarm Report, 8-55
- System Alarm Responses, 9-24
- System Alarm Responses sidebar buttons, 9-24
- System Alarms, 3-6
- System Alarms (Alarm Limits) Tab, 9-23
- System Alarms (Alarm Limits) tab, 9-23
- System Alarms (Alarm Responses) Tab, 9-26
- System Alarms (Alarm Responses) tab, 9-26
- System Alarms (Options) Tab, 9-14
- System Alarms (Options) tab, 9-14
- System Alarms Tab, 9-14
- System Alarms tab, 9-14
 - sidebar buttons, 9-21, 9-24, 9-27
- System Alarms, defined, 3-6
- System Date/Time, defined, 2-14
- System Date/Time, location, 2-14
- System Event Filtering, 9-18
- System Events, 13-25
- System Reports Tab, 8-29
- System Reports tab, 8-29
- System Status Line, defined, 2-11
- System Status Line, location, 2-11

T

- T Blood Values, 12-9
- T1 and T2, 12-8
- Tabs, 2-14
- Tabs, defined, 2-14
- Technical
 - Alarms, 3-6
- Technical Alarms, 3-6
- Technical Alarms and Events, 13-19
- Technical Event Sound, 3-6
- Telepack
 - analysis of data, 16-22
 - Attendant Present buttons, 10-3
 - battery compartment,
 - Cleaning, See also Cleaning, 11-4
 - Communication Range, 10-9
 - communication range, 10-9
 - disposal, 11-6
 - disposal of batteries, 11-7
 - ECG Lead Indicator Lights,

- 10-4
- Error Log Report, 8-53
- FCC labeling, 16-34
- guidelines for cleaning, 11-4
- indicator lights, 10-4
- initial setup, 10-7
- inserting batteries, 10-7
- Nurse Call button, 10-3
- operating instructions, 10-7
- Power Up Sequence, 10-9
- programming, 10-8
- settings, 5-16, 9-56, 9-58
- sidebar button, 9-71
- skin preparation, 4-2
- Specifications, 16-22
- storing, 11-3
- Test button, 10-4
- User Maintenance, 11-3
- Telepack Communication Range, 10-9
- Telepack device
 - Cleaning, See also Cleaning, 11-3
 - securing, 10-9
- Telepack Error Log Report, 8-53
- Telepack Power Up Sequence, 10-9
- Telepack Specifications, 16-22
- Telepack User Maintenance, 11-3
- Telepack with Nonin SpO2
 - Module (Optional), 10-10
- Telepack, defined, 10-2
- Telepack-2.4, 10-9
- Telepack-608, 10-9
- Temp
 - T1, T2, Delta T, and T Blood, 12-8
- Temperature
 - T1, T2, Delta T, and T Blood, 12-8
- Temperature Performance
 - Requirements, 16-6
- Terms, 17-2
- Terms, Acronyms, and Abbreviations, 17-2
- Test, 10-4
- Testing Alarm Limits, 6-9
- The Main Screen, 2-7
- The Panorama Central Station, 2-2
- The ViewStation and WorkStation, 2-4
- Tile Display Rearrangement, 5-44
- Time Date, and Sensor Label, 7-42
- Time Filters, 7-29, 9-19
- Touch Screen, 16-18
- User Maintenance, 11-2
- Touch Screen Tab, 9-4
- Touch Screen User Maintenance, 11-2
- Transfer
 - Central To Central Transfer
 - Without Device, 5-25
 - destination Panorama, 5-27
 - effects of, 5-24, 5-28
 - from Failed List, 5-31
 - Room To Room Transfer
 - Without Device, 5-23
 - source Panorama, 5-26
- Transfer Tab, 5-23
- Transfer tab, 5-23
 - sidebar buttons, 5-29
- Transmit Range, 16-19
- Trend
 - Display, 5-50, 7-18
 - Graphic Report, 8-47
 - List Report, 8-17
 - Records, 8-19
 - Storage, 5-50
- Trend List Report, 8-17
- Trend Records, 8-19
- Trends Tab, 7-14
- Trends tab, 7-14
 - Plot Areas, 7-21
- Trends Tab (Graphic View), 7-20
- Trends tab (Graphic View), 7-20
- Trends Tab (List View), 7-14
- Trends tab (List View), 7-14
- Trends tab, See also List View, 7-14
- Trigeminy Alarm, 4-19
- Troubleshooting, 1-21, 2-27, 4-20, 5-21, 5-32, 5-39, 5-50, 5-53, 5-56, 5-59, 6-3, 6-10, 6-18, 7-9, 7-12, 7-18, 7-23, 7-32, 7-39, 7-46, 7-51, 7-59, 8-27, 8-39, 8-58, 9-3, 9-6, 9-8, 9-10, 9-13, 9-22, 9-25, 9-28, 9-31, 9-36, 9-44, 9-46, 9-49, 9-58, 9-61, 9-72, 10-17, 14-5, 15-3, 15-9
- Additional Reports, 8-58
- Admitting a Patient, 2-27
- Alarm Limits tab, 6-10
- Alarm Options tab, 9-22
- Alarm Responses tab, 6-18
- Arrhythmia & ST Analysis, 4-20
- Bedside tab, 7-12
- Care Group tab, 9-10
- Date Time tab, 9-44
- Demographics tab, 5-21
- Discharge Tab, 5-39
- Disclosure tab, 7-51
- Display tab, 5-50
- Equipment tab, 9-36
- Events tab, 7-39
- Installation Setup tab, 9-8
- Parameter Color tab, 9-3
- Passwords tab, 9-31
- Patient Alarm Setup tab, 6-3
- Patient Reports tab, 8-27
- Print Setup tab, 5-59, 9-46
- Print Status tab, 8-39
- Recalibration, 9-6
- ST tab, 7-59
- Standby tab, 5-53
- System Alarm Limits tab, 9-25
- System Alarm Responses tab, 9-28
- Telepack, 10-17
- Transfer tab, 5-32
- Trends tab, 7-23
- Unit Choices tab, 9-58
- Unit Priorities tab, 9-49
- Volume tab, 9-13
- Wave Gain tab, 5-56, 9-61
- Turning the Touch Screen On or Off, 9-4

U

- Unit Choices Tab, 9-50
- Unit Priorities Tab, 9-47
- Up Arrow button, See also Arrows, 7-36, 7-48
- User Maintenance
 - Telepack, 11-3
- User Selectable ST, 16-5
- Using a Transcutaneous Electrical Nerve Stimulator (TENS), 4-9

V

- Ventricular
 - Rhythm (V-Rhythm) Alarm, 4-19
 - Tachycardia (V-Tach) Alarm, 4-16
- Ventricular-Fibrillation (V-Fib) Alarm, 4-15
- Vertical
 - Calipers (Time), 7-6
 - Measurements (Time), 7-6
 - Navigation buttons, 7-36, 7-48

View

- Print Setup sidebar button, 9-58
- View 12™ Card, 4-6
- View List sidebar button, 7-38
- View Waveforms, 7-32
- VIEW/MUTE button, 2-8
- Viewing
 - Disclosure Data, 2-26
 - Events, 2-26
 - List Trends, 2-25
- Viewing Disclosure Data, 2-26
- Viewing Disclosure data, Quick Reference Guide, See also Quick Reference Guide, 2-26
- Viewing Events, 2-26
- Viewing Events data, Quick Reference Guide, See also Quick Reference Guide, 2-26
- Viewing List Trends, 2-25
- Viewing List Trends, Quick Reference Guide, See also Quick Reference Guide, 2-25
- ViewStation, about, 2-4
- Visual Indicators, 3-2, 3-6
- Volume Tab, 9-11
- Volume tab, 9-11
- V-Rhythm Alarm, 4-19

W

- Wave Gain tab, 5-54
 - (Patient), 5-54
 - (System), 9-59
- Wave Gain Tab (Patient), 5-54
- Wave Gain tab (Patient) sidebar buttons, 5-56
- Wave Gain Tab (System), 9-59
- Waveform
 - Area, 7-42
 - Data, 8-5, 8-11, 8-32, 8-42, 8-45, 8-52
 - Data Tile, 2-10
 - Parameter Data, 5-46
- Waveforms
 - CO2, 12-6
 - DES, 12-8
 - ECG, 12-2
 - ENF, 12-8
 - Generic, 12-8
 - HAL, 12-8
 - IBP, 12-5
 - ISO, 12-8
 - O2, 12-6
 - Respiration, 12-3
 - SEV, 12-8
 - SPO2, 12-4, 12-5
 - View sidebar buttons, 7-38, 7-50
 - View ST dialog box, 7-37

- Waveforms, Non-ECG, See also Non-ECG, 8-5, 8-33, 8-43, 8-46

Weight

- Dial dialog, 2-19
- field, 5-8
- fields, 5-8
- Weight field
 - ranges, 5-9, 5-10
- Wireless Tab, 9-62
- Wireless tab, 9-62
 - Connect field, 9-67, 9-70
 - hardware version, 9-67
 - Protocol Selection field, 9-68
 - sidebar buttons, 9-68
 - Software Version field, 9-67
- WMTS All sidebar button, 9-36
- WMTS Device sidebar button, 9-36

X

- Xs (XX) Digital Data, 12-13

Z

Zoom

- In button, 7-22, 7-43, 7-46
- Out, 7-50
- Out button, 7-22, 7-43

*Mindray DS USA, Inc. • 800 MacArthur Boulevard • Mahwah, NJ 07430 • USA •
Dom. Customer Service: 1.800.288.2121 • Intl. Customer Service: +1.201.995.8000 •
Dom. Fax: 1.800.926.4275 • Intl. Fax: +1.201.995.8680 • www.mindray.com*

*Mindray Medical Netherlands B.V. • Drs. W. van Royenstraat 8 • P.O. Box 26 • 3870 CA
Hoevelaken • The Netherlands • Tel: +31 33 25 44 911 • Fax: +31 33 25 37 621*

*Mindray (UK) Limited • 3 Percy Road • St. John's Park • Huntingdon • Cambridgeshire PE29 6SZ •
United Kingdom • Tel: 01480 416840 • Fax: 01480 436588*

*Mindray Medical France SARL • Europarc Créteil • 123, Chemin des Bassins •
94035 Créteil Cedex • France • Tel: (0)1.45.13.91.50 • Fax: (0)1.45.13.91.51*

*Mindray Medical Germany GmbH • Zwischen den Bächen 4 • 64625 Bensheim • Deutschland •
Tel: +49.6251.17524-0 • Fax: +49.6251.17524-20*

*Mindray Medical International Ltd. • 2813 Office Tower, Convention Plaza • No 1 Harbour Road •
Wanchai • Hong Kong • Tel: +852 2793 5596 • Fax: +852 2344 8824*

*Medstar Importação e Exportação Ltda • Av. Vereador José Diniz, 3300 • São Paulo, SP • CEP
04804-000 • Brazil • Tel: 55 11 2872-3385 • Fax: 55 11 2872-3385*