

DPM[™] | 7

Patient Monitor

Operator's Manual

mindray

Revision History

This manual has a revision number. This revision number changes whenever the manual is updated due to software or technical specification change. Contents of this manual are subject to change without prior notice.

Revision number: 17.0

Release time: 2017/25

© Copyright 2008-2017 Mindray DS USA, Inc. All rights reserved.

 **WARNING**

Federal Law (USA) restricts this device to sale by or on the order of a physician.

Intellectual Property Statement

Mindray DS USA, Inc. (hereinafter called Mindray DS) owns the intellectual property rights to this product and this manual. This manual may refer to information protected by copyrights or patents and does not convey any license under the copyright or patent rights of Mindray DS, nor the rights of others.

Mindray DS intends to maintain the contents of this manual as confidential information. Disclosure of the information in this manual in any manner whatsoever without the written permission of Mindray DS is strictly forbidden. Release, amendment, reproduction, distribution, rental, adaptation and translation of this manual in any manner whatsoever without the written permission of Mindray DS is strictly forbidden.

mindray[®] is a trademark or a registered trademark of Shenzhen Mindray Bio-Medical Electronics Co., Ltd. All third-party trademarks that appear in this manual are used solely for editorial purposes and are the property of their respective owners.

Contents of this manual are subject to changes without prior notice.

Manufacturer's Responsibility

All information contained in this manual is believed to be correct. Shenzhen Mindray Bio-Medical Electronics Co., Ltd. shall not be liable for errors or omissions for incidental or consequential damages in connection with the use of this manual.

Mindray will not be liable for the effects on safety, reliability and performance of this product if:

- any installation operations, expansions, changes, modifications or repairs of this product are not conducted by Mindray authorized personnel; and
- the electrical installation of the relevant room does not comply with the applicable national and local requirements; and
- the product is not used in accordance with the instructions for use.

Warranty

This warranty is exclusive and is in lieu of all other warranties, expressed or implied, including warranties of merchantability or fitness for any particular purpose.

Exemptions

Mindray's obligation or liability under this warranty does not include any transportation or other charges or liability for direct, indirect or consequential damages or delay resulting from the improper use or application of the product or the use of parts or accessories not approved by Mindray or repairs by people other than Mindray authorized personnel.

This warranty shall not extend to

- Any Mindray product which has been subjected to misuse, negligence or accident; or
- Any Mindray product from which Mindray's original serial number tag or product identification markings have been altered or removed; or
- Any product of any other manufacturer.

Return Policy

In the event that it becomes necessary to return a unit to Mindray DS, follow the instructions below.

1. Return authorization.

Contact the Customer Service Department and obtain a Customer Service Authorization number. This number must appear on the outside of the shipping container. Returned shipments will not be accepted if the number is not clearly visible. Please provide the model number, serial number, and a brief description of the reason for return.

2. Freight policy

The customer is responsible for freight charges when this product is shipped to Mindray DS for service (this includes customs charges).

3. Return address

Please send the part(s) or equipment to the address offered by the Customer Service Department.

Contact Information

Manufacturer:	Shenzhen Mindray Bio-Medical Electronics Co., Ltd.
Address:	Mindray Building, Keji 12th Road South, Hi-tech industrial park, Nanshan, Shenzhen 518057, P.R. China
Website:	www.mindray.com
E-mail Address	service@mindray.com.cn
Tel:	+86 755 81888998
Fax:	+86 755 26582680
Distributor:	Mindray DS USA, Inc.
Address:	800 MacArthur Boulevard, Mahwah, New Jersey 07430 USA
Tel:	1.800.288.2121, 1.201.995.8000
Website:	www.mindray.com

Preface

Manual Purpose

This manual contains the instructions necessary to operate the product safely and in accordance with its function and intended use. Observance of this manual is a prerequisite for proper product performance and correct operation and ensures patient and operator safety.

This manual is based on the maximum configuration and therefore some contents may not apply to your product. If you have any question, please contact us.

This manual is an integral part of the product. It should always be kept close to the equipment so that it can be obtained conveniently when needed.

Intended Audience

This manual is geared for clinical professionals who are expected to have a working knowledge of medical procedures, practices and terminology as required for monitoring of critically ill patients.

Illustrations

All illustrations in this manual serve as examples only. They may not necessarily reflect the setup or data displayed on your patient monitor.

Conventions

- *Italic* text is used in this manual to quote the referenced chapters or sections.
- [] is used to enclose screen texts.
- → is used to indicate operational procedures.

FOR YOUR NOTES

Contents

1 Safety	1-1
1.1 Safety Information	1-1
1.1.1 Warnings	1-2
1.1.2 Cautions	1-3
1.1.3 Notes	1-3
1.2 Equipment Symbols	1-4
2 The Basics	2-1
2.1 Monitor Description	2-1
2.1.1 Intended Use	2-1
2.1.2 Contraindications	2-1
2.1.3 Components	2-1
2.2 Main Unit	2-2
2.2.1 Front View	2-2
2.2.2 Side View	2-4
2.2.3 Bottom View	2-4
2.2.4 Rear View	2-5
2.3 Satellite Module Rack	2-7
2.4 Modules	2-8
2.4.1 Plug-In Modules	2-8
2.4.2 Multi-Parameter Module	2-9
2.5 Display Screen	2-10
2.6 QuickKeys	2-12
3 Basic Operations	3-1
3.1 Installation	3-1
3.1.1 Unpacking and Checking	3-2
3.1.2 Environmental Requirements	3-3
3.2 Getting Started	3-4
3.2.1 Turning Power On	3-4
3.2.2 Starting Monitoring	3-4
3.3 Disconnecting from Power	3-5
3.4 Using a mouse	3-5
3.5 Using Keys	3-6
3.6 Using Keyboards	3-6
3.7 Using the Touchscreen	3-6
3.8 Setting the Screen	3-7
3.9 Using the Main Menu	3-8
3.10 Setting Parameters	3-9

3.10.1 Accessing the Parameters Menu.....	3-9
3.10.2 Removing a Module Conflict.....	3-10
3.10.3 Removing a Label Conflict.....	3-10
3.11 Using a CF Storage Card.....	3-11
3.12 Changing General Settings.....	3-12
3.12.1 Setting up a Monitor.....	3-12
3.12.2 Changing Language.....	3-12
3.12.3 Adjusting the Screen Brightness.....	3-13
3.12.4 Showing/Hiding the Help.....	3-13
3.12.5 Setting the Date and Time.....	3-13
3.12.6 Adjusting Volume.....	3-14
3.13 Managing Configurations.....	3-15
3.13.1 Restoring the Latest Configuration Automatically.....	3-15
3.13.2 Setting Default Configuration at Startup.....	3-15
3.13.3 Saving as User Configuration.....	3-16
3.13.4 Deleting a User Default Configuration.....	3-16
3.13.5 Restoring Default Configuration Manually.....	3-17
4 Managing Patients.....	4-1
4.1 Admitting a Patient.....	4-1
4.2 Quick Admitting a Patient.....	4-2
4.3 Editing Patient Information.....	4-3
4.4 Discharging a Patient.....	4-3
4.5 Transferring a Patient.....	4-3
4.6 Connecting to Panorama™ Central Station.....	4-6
5 User Screens.....	5-1
5.1 Tailoring Your Screens.....	5-1
5.1.1 Setting the Waveform Sweep Mode.....	5-1
5.1.2 Changing the Wave Line Size.....	5-1
5.1.3 Changing Measurement Colors.....	5-1
5.1.4 Changing Screen Layout.....	5-2
5.2 Viewing Minitrends.....	5-3
5.2.1 Having a Split-Screen View of Minitrends.....	5-3
5.2.2 Setting Minitrends.....	5-4
5.3 Viewing oxyCRG.....	5-4
5.4 Viewing Other Patients.....	5-5
5.4.1 Care Group.....	5-5
5.4.2 Viewing the Care Group Overview Bar.....	5-5
5.4.3 Understanding the View Other Patient Window.....	5-6
5.5 Understanding the Big Numerics Screen.....	5-7
6 Alarms.....	6-1
6.1 Alarm Categories.....	6-1

6.2 Alarm Levels	6-2
6.3 Alarm Indicators.....	6-2
6.3.1 Alarm Lamp	6-2
6.3.2 Alarm Message.....	6-3
6.3.3 Flashing Numeric	6-3
6.3.4 Audible Alarm Tones.....	6-3
6.3.5 Reminder Tones.....	6-4
6.3.6 Alarm Status Symbols	6-4
6.4 Alarm Tone Configuration	6-5
6.4.1 Setting the Minimum Alarm Volume	6-5
6.4.2 Changing the Alarm Volume	6-5
6.4.3 Setting the Interval between Alarm Sounds	6-6
6.4.4 Changing the Alarm Tone Pattern	6-7
6.4.5 Setting the Reminder Tones	6-7
6.5 Understanding the Alarm Setup Menu	6-7
6.5.1 Setting Alarm Properties for All Parameters	6-8
6.5.2 Adjusting Alarm Limits Automatically	6-8
6.5.3 Setting Alarm Delay Time.....	6-13
6.5.4 Entering CPB Mode	6-13
6.6 Pausing Alarms	6-14
6.7 Silencing the Alarm Sound.....	6-14
6.8 Latching Alarms	6-14
6.9 Silencing Technical Alarms.....	6-15
6.10 Testing Alarms	6-15
6.11 When an Alarm Occurs	6-16
6.12 Using Care Group Alarms.....	6-16
6.12.1 Care Group Auto Alarms.....	6-16
6.12.2 Silencing Care Group Alarms	6-16
7 Monitoring ECG	7-1
7.1 Introduction.....	7-1
7.2 Safety	7-2
7.3 Preparing to Monitor ECG.....	7-3
7.3.1 Preparing the Patient and Placing the Electrodes.....	7-3
7.3.2 Choosing AHA or IEC Lead Placement.....	7-4
7.3.3 ECG Lead Placements.....	7-4
7.3.4 Checking Paced Status	7-7
7.4 Understanding the ECG Display	7-8
7.5 Changing ECG Settings	7-9
7.5.1 Accessing ECG Menus.....	7-9
7.5.2 Setting Pacemaker Rate (For Mortara only).....	7-9
7.5.3 Choosing the Alarm Source	7-9
7.5.4 Setting the ECG Lead Set	7-9
7.5.5 Choosing an ECG Display Screen	7-9

7.5.6 Changing the ECG Filter Settings.....	7-10
7.5.7 Switching the Notch Filter On or Off.....	7-10
7.5.8 About the Defibrillator Synchronization.....	7-11
7.5.9 Changing ECG Wave Settings.....	7-11
7.5.10 Choosing the Heart Rate Source.....	7-12
7.5.11 Enabling Smart Lead Off.....	7-12
7.5.12 Setting the Alarm Level for ECG Lead Off Alarms.....	7-12
7.5.13 Adjusting QRS Volume.....	7-12
7.6 About ST Monitoring.....	7-13
7.6.1 Switching ST On and Off.....	7-13
7.6.2 Changing ST Filter Settings.....	7-13
7.6.3 Understanding the ST Display.....	7-14
7.6.4 Changing the ST Alarm Limits.....	7-14
7.6.5 Setting the ST Alarm Delay Time.....	7-14
7.6.6 Adjusting ST Measurement Points.....	7-14
7.7 About Arrhythmia Monitoring.....	7-16
7.7.1 Understanding the Arrhythmia Events.....	7-17
7.7.2 Changing Arrhythmia Alarm Settings.....	7-18
7.7.3 Changing Arrhythmia Threshold Settings.....	7-18
7.7.4 Reviewing Arrhythmia Events.....	7-19
7.7.5 Initiating an ECG Relearning Manually.....	7-19
7.7.6 Automatic ECG Relearning.....	7-19
7.8 12-Lead ECG Monitoring.....	7-20
7.8.1 Entering the 12-lead ECG Monitoring Screen.....	7-20
8 Monitoring Respiration (Resp).....	8-1
8.1 Introduction.....	8-1
8.2 Safety Information.....	8-1
8.3 Understanding the Resp Display.....	8-2
8.4 Placing Resp Electrodes.....	8-2
8.4.1 Optimizing Lead Placement for Resp.....	8-3
8.4.2 Cardiac Overlay.....	8-3
8.4.3 Abdominal Breathing.....	8-3
8.4.4 Lateral Chest Expansion.....	8-4
8.5 Choosing the Respiration Lead.....	8-4
8.6 Changing the Apnea Alarm Delay.....	8-4
8.7 Changing Resp Detection Mode.....	8-4
8.8 Changing Resp Wave Settings.....	8-5
8.9 Setting RR Source.....	8-5
8.10 Setting alarm properties.....	8-6
8.11 Switching Resp Measurement On/Off.....	8-6
9 Monitoring PR.....	9-1
9.1 Introduction.....	9-1

9.2 Setting the PR Source	9-2
9.3 Selecting the Active Alarm Source	9-3
9.4 QRS Tone	9-3
10 Monitoring SpO2.....	10-1
10.1 Introduction	10-1
10.2 Safety	10-2
10.3 Identifying SpO2 Modules	10-3
10.4 Applying the Sensor	10-3
10.5 Changing SpO2 Settings	10-4
10.5.1 Accessing SpO ₂ Menus	10-4
10.5.2 Adjusting the Desat Alarm	10-4
10.5.3 Setting SpO ₂ Sensitivity	10-4
10.5.4 Changing Averaging Time.....	10-4
10.5.5 Monitoring SpO ₂ and NIBP Simultaneously.....	10-5
10.5.6 Sat-Seconds Alarm Management	10-5
10.5.7 Changing the Speed of the Pleth Wave	10-6
10.5.8 Setting the Alarm Level for SpO2 Sensor Off Alarm.....	10-6
10.5.9 Setting the SpO2 Tone Mode	10-7
10.6 Measurement Limitations.....	10-7
10.7 Masimo Information	10-8
10.8 Nellcor Information.....	10-8
11 Monitoring NIBP.....	11-1
11.1 Introduction	11-1
11.2 Safety	11-2
11.3 Measurement Limitations.....	11-3
11.4 Measurement Methods	11-3
11.5 Setting Up the NIBP Measurement	11-3
11.5.1 Preparing to Measure NIBP	11-3
11.5.2 Starting and Stopping Measurements	11-4
11.5.3 Correcting the Measurement if Limb is not at Heart Level.....	11-4
11.5.4 Enabling NIBP Auto Cycling and Setting the Interval.....	11-4
11.5.5 Starting a STAT Measurement.....	11-5
11.6 Understanding the NIBP Numerics	11-5
11.7 Changing NIBP Settings	11-6
11.7.1 Setting the Initial Cuff Inflation Pressure.....	11-6
11.7.2 Setting NIBP Alarm Properties.....	11-6
11.7.3 Displaying NIBP List	11-6
11.7.4 Setting the Pressure Unit	11-7
11.8 Assisting Venous Puncture	11-7
11.9 Resetting NIBP.....	11-7
11.10 NIBP Leakage Test.....	11-8
11.11 NIBP Accuracy Test	11-9

11.12 Calibrating NIBP.....	11-10
12 Monitoring Temp.....	12-1
12.1 Introduction.....	12-1
12.2 Safety	12-1
12.3 Making a Temp Measurement.....	12-2
12.4 Understanding the Temp Display.....	12-2
12.5 Setting the Temperature Unit	12-2
13 Monitoring IBP	13-1
13.1 Introduction.....	13-1
13.2 Safety	13-1
13.3 Setting Up the Pressure Measurement	13-2
13.4 Understanding the IBP Display.....	13-3
13.5 Changing IBP Settings	13-4
13.5.1 Changing a Pressure for Monitoring	13-4
13.5.2 Setting Alarm Properties	13-4
13.5.3 Changing Averaging Time.....	13-4
13.5.4 Setting the Pressure Unit.....	13-5
13.5.5 Setting Up the IBP Wave.....	13-5
13.6 Measuring PAWP	13-6
13.6.1 Preparing to Measure PAWP	13-7
13.6.2 Setting Up the PAWP Measurement.....	13-8
13.6.3 Understanding the PAWP Setup Menu.....	13-9
13.7 Zeroing the Transducer	13-9
14 Monitoring Cardiac Output.....	14-1
14.1 Introduction.....	14-1
14.2 Understanding the C.O. Display	14-2
14.3 Influencing Factors	14-2
14.4 Setting Up the C.O. Measurement	14-3
14.5 Measuring the Blood Temperature.....	14-6
14.6 Changing C.O. Settings.....	14-6
14.6.1 Setting the Temperature Unit	14-6
14.6.2 Setting Alarm Properties	14-6
15 Monitoring CCO/SvO2.....	15-1
15.1 Introduction.....	15-1
15.2 Safety	15-1
15.3 Automatic Communication Detection.....	15-2
15.4 Connecting the Vigilance II® Monitor	15-2
15.5 Understanding CCO Parameters	15-4
15.6 Understanding the CCO Display.....	15-4

15.7 Changing CCO Settings	15-5
15.7.1 Selecting Vascular Resistance Unit	15-5
15.7.2 Selecting the Displayed Parameters	15-5
15.7.3 Checking the C.O. Measurements	15-5
15.7.4 Setting Signal Output	15-5
15.7.5 Selecting Alarm Properties	15-6
15.8 Understanding SvO2 Parameters	15-6
15.9 Understanding the SvO2 Display	15-6
15.10 Changing SvO2 Settings	15-7
15.10.1 Setting Signal Output	15-7
15.10.2 Selecting Alarm Properties	15-7
16 Monitoring Carbon Dioxide	16-1
16.1 Introduction	16-1
16.2 Identifying CO2 Modules	16-2
16.3 Preparing to Measure CO2	16-3
16.3.1 Using a Sidestream CO ₂ Module	16-3
16.3.2 Using a Microstream CO ₂ Module	16-4
16.3.3 Using a Mainstream CO ₂ Module	16-5
16.4 Changing CO2 Settings	16-6
16.4.1 Accessing CO ₂ Menus	16-6
16.4.2 Entering the Standby Mode	16-6
16.4.3 Setting the CO2 Unit	16-6
16.4.4 Setting up Gas Compensations	16-7
16.4.5 Setting up Humidity Compensation	16-8
16.4.6 Setting the Apnea Alarm Delay	16-8
16.4.7 Choosing a Time Interval for Peak-Picking	16-9
16.4.8 Setting the Flow Rate	16-9
16.4.9 Setting up the CO ₂ Wave	16-9
16.4.10 Setting RR Source	16-9
16.5 Setting Barometric Pressure Compensation	16-10
16.6 Measurement Limitations	16-10
16.7 Troubleshooting the Sidestream CO2 Sampling System	16-11
16.8 Removing Exhaust Gases from the System	16-11
16.9 Zeroing the Sensor	16-11
16.9.1 For Sidestream and Microstream CO ₂ Modules	16-11
16.9.2 For Mainstream CO ₂ Modules	16-12
16.10 Calibrating the Sensor	16-12
16.11 Oridion Information	16-13
17 Monitoring AG	17-1
17.1 Introduction	17-1
17.2 Identifying AG Modules	17-1
17.3 Understanding the AG Display	17-2

17.4 MAC Values.....	17-3
17.5 Preparing to Measure AG.....	17-4
17.6 Changing AG Settings.....	17-5
17.6.1 Setting Gas Unit.....	17-5
17.6.2 Setting the Apnea Alarm Delay.....	17-5
17.6.3 Changing the Sample Flow Rate.....	17-6
17.6.4 Setting up the O ₂ Compensation.....	17-6
17.6.5 Entering the Standby Mode.....	17-6
17.6.6 Setting up the AG Wave.....	17-7
17.6.7 Setting RR Source.....	17-7
17.7 Changing the Anesthetic Agent.....	17-7
17.8 Measurement Limitations.....	17-7
17.9 Troubleshooting.....	17-8
17.9.1 When the Gas Inlet is Blocked.....	17-8
17.9.2 When an Internal Occlusion Occurs.....	17-8
17.10 Removing Exhaust Gases from the System.....	17-8
18 Monitoring ICG.....	18-1
18.1 Introduction.....	18-1
18.2 Safety.....	18-1
18.3 Understanding ICG Parameters.....	18-2
18.3.1 Measured Parameters.....	18-2
18.3.2 Calculated Parameters.....	18-2
18.4 Understanding the ICG Display.....	18-3
18.5 ICG Limitations.....	18-3
18.6 Preparing to Monitor ICG.....	18-4
18.6.1 Preparing the Patient.....	18-4
18.6.2 Placing ICG Sensors.....	18-4
18.6.3 Setting up the Patient Information.....	18-5
18.7 Changing ICG Settings.....	18-5
18.7.1 ICG Averaging.....	18-5
18.7.2 Selecting Secondary Parameters.....	18-6
18.7.3 Checking Sensors.....	18-6
18.7.4 Changing the ICG Wave Speed.....	18-6
19 Monitoring BIS.....	19-1
19.1 Introduction.....	19-1
19.2 Safety Information.....	19-2
19.3 Understanding the BIS Display.....	19-3
19.3.1 BIS Parameter Area.....	19-3
19.3.2 BIS Waveform Area.....	19-4
19.4 Setting up the BIS Measurement.....	19-5
19.5 Continuous Impedance Check.....	19-6
19.6 Cyclic Impedance Check.....	19-6

19.7 BIS Sensor Check Window	19-7
19.8 Choosing the BIS Smoothing Rate	19-8
19.9 Changing the Secondary Parameters.....	19-8
19.10 Changing the EEG Wave Size.....	19-8
19.11 Changing the Speed of the EEG Wave.....	19-8
19.12 Setting the Trend Length.....	19-8
20 Monitoring RM	20-1
20.1 Introduction.....	20-1
20.2 Safety Information	20-3
20.3 Preparing to Monitor RM.....	20-4
20.4 Understanding the RM Display.....	20-5
20.5 Changing RM Settings	20-6
20.5.1 Accessing RM Menus	20-6
20.5.2 Setting the Apnea Alarm Delay.....	20-6
20.5.3 Selecting TV or MV for Display	20-6
20.5.4 Selecting Flow or Vol Waveform for Display	20-6
20.5.5 Changing the Wave Sweep Speed.....	20-7
20.5.6 Changing the Wave Scale.....	20-7
20.5.7 Setting RR Source	20-7
20.6 Understanding the Respiratory Loops.....	20-8
20.7 Zeroing the RM Module.....	20-9
20.8 Calibrating the Flow Sensor.....	20-9
21 Freezing Waveforms	21-1
21.1 Freezing Waveforms	21-1
21.2 Viewing Frozen Waveforms.....	21-1
21.3 Unfreezing Waveforms	21-2
21.4 Recording Frozen Waveforms.....	21-2
22 Review	22-1
22.1 Accessing Respective Review Windows.....	22-1
22.2 Reviewing Graphic Trends.....	22-2
22.3 Reviewing Tabular Trends	22-3
22.4 Reviewing Events	22-5
22.5 Reviewing Waveforms	22-6
23 Calculations	23-1
23.1 Introduction.....	23-1
23.2 Dose Calculations	23-2
23.2.1 Performing Calculations.....	23-2
23.2.2 Selecting the Proper Drug Unit.....	23-3
23.2.3 Titration Table	23-3
23.3 Oxygenation Calculations	23-4

23.3.1 Performing Calculations.....	23-4
23.3.2 Entered Parameters.....	23-5
23.3.3 Calculated Parameters	23-5
23.4 Ventilation Calculations	23-6
23.4.1 Performing Calculations.....	23-6
23.4.2 Entered Parameters.....	23-7
23.4.3 Calculated Parameters	23-7
23.5 Hemodynamic Calculations	23-8
23.5.1 Performing Calculations.....	23-8
23.5.2 Entered Parameters.....	23-9
23.5.3 Calculated Parameters	23-9
23.6 Renal Calculations	23-10
23.6.1 Performing Calculations.....	23-10
23.6.2 Entered Parameters.....	23-11
23.6.3 Calculated Parameters	23-11
23.7 Understanding the Review Window.....	23-12
24 Recording.....	24-1
24.1 Using a Recorder.....	24-1
24.2 Overview of Recording Types.....	24-2
24.3 Starting and Stopping Recordings	24-3
24.4 Setting up the Recorder.....	24-4
24.4.1 Accessing the Record Setup Menu.....	24-4
24.4.2 Selecting Waveforms for Recording	24-4
24.4.3 Setting the Realtime Recording Length	24-4
24.4.4 Setting the Interval between Timed Recordings.....	24-4
24.4.5 Changing the Recording Speed.....	24-4
24.4.6 Clearing Recording Tasks	24-5
24.5 Loading Paper	24-5
24.6 Removing Paper Jam	24-6
24.7 Cleaning the Recorder Printhead	24-6
25 Printing	25-1
25.1 Printer.....	25-1
25.2 Connecting a printer.....	25-1
25.3 Setting Up the Printer.....	25-2
25.4 Starting Report Printouts.....	25-2
25.5 Stopping Reports Printouts	25-4
25.6 Setting Up Reports	25-4
25.6.1 Setting Up ECG Reports	25-4
25.6.2 Setting Up Tabular Trends Reports	25-4
25.6.3 Setting Up Graphic Trends Reports	25-5
25.6.4 Setting Up Realtime Reports.....	25-5
25.7 End Case Reports.....	25-5

25.8 Printer Statuses.....	25-5
25.8.1 Printer Out of Paper.....	25-5
25.8.2 Printer Status Messages.....	25-5
26 Other Functions.....	26-1
26.1 Marking Events.....	26-1
26.2 Privacy Mode.....	26-1
26.3 Night Mode.....	26-2
26.4 Analog Output.....	26-3
26.5 Transferring Data.....	26-3
26.5.1 Data Export System.....	26-3
26.5.2 Transferring Data by Different Means.....	26-4
26.6 Nurse Call.....	26-5
26.7 Remote Display.....	26-6
26.8 Wireless Network.....	26-7
27 Batteries.....	27-1
27.1 Overview.....	27-1
27.2 Installing the Batteries.....	27-2
27.3 Conditioning a Battery.....	27-3
27.4 Checking a Battery.....	27-4
27.5 Recycling a Battery.....	27-4
28 Care and Cleaning.....	28-1
28.1 General Points.....	28-1
28.2 Cleaning.....	28-2
28.3 Disinfecting.....	28-3
29 Maintenance.....	29-1
29.1 Safety Checks.....	29-1
29.2 Maintenance and Testing Schedule.....	29-2
29.3 Checking Monitor and Module Information.....	29-4
29.4 Calibrating ECG.....	29-4
29.5 Calibrating the Touchscreen.....	29-4
29.6 Calibrating CO2.....	29-5
29.7 Calibrating AG.....	29-6
29.8 Electrical Safety Tests.....	29-7
29.9 Setting up IP Address.....	29-7
29.10 Entering/Exiting Demo Mode.....	29-8
30 Accessories.....	30-1
30.1 ECG Accessories.....	30-2
30.2 SpO ₂ Accessories.....	30-3
30.3 NIBP Accessories.....	30-5

30.4 Temp Accessories	30-7
30.5 IBP Accessories	30-7
30.6 C.O. Accessories	30-8
30.7 CCO/SvO ₂ Accessories	30-9
30.8 CO ₂ Accessories	30-9
30.9 AG Accessories	30-10
30.10 ICG Accessories	30-10
30.11 BIS Accessories	30-10
30.12 RM Accessories	30-10
30.13 Others	30-10
A Product Specifications.....	A-1
A.1 Monitor Safety Specifications	A-1
A.2 Physical Specifications	A-4
A.3 Hardware Specifications	A-5
A.4 Data Storage	A-9
A.5 Wireless Network	A-9
A.6 Measurement Specifications	A-10
B EMC.....	B-1
C Factory Defaults	C-1
C.1 Patient Demographics	C-1
C.2 Alarm Setup	C-1
C.3 Screen Setup	C-1
C.4 ECG Setup	C-2
C.5 Resp Setup	C-4
C.6 PR	C-4
C.7 SpO ₂ Setup	C-5
C.8 NIBP Setup	C-6
C.9 Temp Setup	C-6
C.10 IBP Setup	C-7
C.11 C.O. Setup	C-8
C.12 CCO/SvO ₂ Setup	C-8
C.13 CO ₂ Setup	C-9
C.14 AG Setup	C-10
C.15 ICG Setup	C-11
C.16 BIS Setup	C-11
C.17 RM Setup	C-12
D Alarm Messages.....	D-1
D.1 Physiological Alarm Messages	D-2
D.2 Technical Alarm Messages	D-3

E Electrical Safety Inspection	E-1
E.1 Power Cord Plug.....	E-1
E.2 Device Enclosure and Accessories	E-2
E.3 Device Labelling.....	E-2
E.4 Protective Earth ResistanceSS	E-2
E.5 Earth Leakage Test	E-3
E.6 Patient Leakage Current	E-3
E.7 Mains on Applied Part Leakage.....	E-4
E.8 Patient Auxiliary Current.....	E-4
F Symbols and Abbreviations.....	F-1
F.1 Symbols.....	F-1
F.2 Abbreviations	F-3

FOR YOUR NOTES

1 Safety

1.1 Safety Information

WARNING

- Indicates a potential hazard or unsafe practice that, if not avoided, could result in death or serious injury.
-
-

CAUTION

- Indicates a potential hazard or unsafe practice that, if not avoided, could result in minor personal injury or product/property damage.
-
-

NOTE

- Provides application tips or other useful information to ensure that you get the most from your product.
-
-

1.1.1 Warnings

WARNINGS

- **Before putting the system into operation, the operator must verify that the equipment, connecting cables and accessories are in correct working order and operating condition.**
 - **The equipment must be connected to a properly installed power outlet with protective earth contacts only. If the installation does not provide for a protective earth conductor, disconnect it from the power line and operate it on battery power, if possible.**
 - **To avoid explosion hazard, do not use the equipment in the presence of flammable anesthetics, vapors or liquids.**
 - **Do not open the equipment housings. All servicing and future upgrades must be carried out by the personnel trained and authorized by our company only.**
 - **Do not come into contact with patients during defibrillation. Otherwise serious injury or death could result.**
 - **Do not rely exclusively on the audible alarm system for patient monitoring. Adjustment of alarm volume to a low level or off may result in a hazard to the patient. Remember that alarm settings should be customized according to different patient situations and always keeping the patient under close surveillance is the most reliable way for safe patient monitoring.**
 - **The physiological data and alarm messages displayed on the equipment are for reference only and cannot be directly used for diagnostic interpretation.**
 - **To avoid inadvertent disconnection, route all cables in a way to prevent a stumbling hazard. Wrap and secure excess cabling to reduce risk of entanglement or strangulation by patients or personnel.**
 - **Dispose of the package material, observing the applicable waste control regulations and keeping it out of children's reach.**
-

1.1.2 Cautions

CAUTIONS

- To ensure patient safety, use only parts and accessories specified in this manual.
 - At the end of its service life, the equipment, as well as its accessories, must be disposed of in compliance with the guidelines regulating the disposal of such products. If you have any questions concerning disposal of the equipment, please contact us.
 - Magnetic and electrical fields are capable of interfering with the proper performance of the equipment. For this reason make sure that all external devices operated in the vicinity of the equipment comply with the relevant EMC requirements. Mobile phone, X-ray equipment or MRI devices are a possible source of interference as they may emit higher levels of electromagnetic radiation.
 - Before connecting the equipment to the power line, check that the voltage and frequency ratings of the power line are the same as those indicated on the equipment's label or in this manual.
 - Always install or carry the equipment properly to avoid damage caused by drop, impact, strong vibration or other mechanical force.
-

1.1.3 Notes





























NOTES





- Put the equipment in a location where you can easily see the screen and access the operating controls.
 - Keep this manual in the vicinity of the equipment so that it can be obtained conveniently when needed.
 - The software was developed in compliance with IEC60601-1-4. The possibility of hazards arising from software errors is minimized.
 - This manual describes all features and options. Your equipment may not have all of them.
-

1.2 Equipment Symbols

NOTE

- Some symbols may not appear on your equipment.

	Attention: Consult accompanying documents (this manual).		
	Power ON/OFF (for a part of the equipment)		Battery indicator
	Alternating current (AC)		Alarms paused
	Alarm silenced		Record
	Freeze/unfreeze waveforms		Main menu
	NIBP start/stop key		Connector for satellite module rack
	Equipotential grounding		Video output
	USB connector		Network connector
	CIS connector		Auxiliary output
	Defibrillator		Zero key
	Check sensor		Calibrate key
	Measure/standby		Inserted direction
	Gas outlet		Serial number
	CIS connector		Manufacture date
	ESD warning symbol for electrostatic sensitive devices.		

	<p>Type CF applied part. Defibrillator-proof protection against electric shock.</p>
	<p>Type BF applied part. Defibrillator-proof protection against electric shock.</p>
	<p>The following definition of the WEEE label applies to EU member states only.</p> <p>This symbol indicates that this product should not be treated as household waste. By ensuring that this product is disposed of correctly, you will help prevent bringing potential negative consequences to the environment and human health. For more detailed information with regard to returning and recycling this product, please consult the distributor from whom you purchased it.</p> <p>* For system products, this label may be attached to the main unit only.</p>
<p>ETL CLASSIFIED</p>  <p>Intertek 3191955</p>	<p>Conforms to UL STD 60601-1, IEC 60601-2-27, IEC 60601-2-25, IEC 60601-2-34, IEC 60601-2-30, IEC 60601-2-49, IEC60601-1-1.</p> <p>Certified to CSA STD C22.2 NO 601.1, NO 60601-2-27, NO 60601-2-30, NO 60601-2-34, NO60601-2-49, CSA C22.2 NO.60601-1-1.</p>

FOR YOUR NOTES

2 The Basics

2.1 Monitor Description

2.1.1 Intended Use

The patient monitor is intended to be used for monitoring, displaying, reviewing, storing and alarming of multiple physiological parameters including ECG(3-lead or 5-lead or 12-lead selectable), arrhythmia detection, ST Segment analysis, heart rate(HR), respiration rate(RESPIR), temperature (TEMP), pulse oxygen saturation (SpO₂), pulse rate(PR), non-invasive blood pressure (NIBP), invasive blood pressure(IBP), carbon dioxide (CO₂), anesthetic gas (AG), impedance cardiograph (ICG), bispectral index (BIS), cardiac output (C.O.) and respiration mechanics (RM).

All the parameters can be applied for single adult, pediatric and neonatal patients with the exception of the follows: C.O. monitoring is restricted to adult patients only; the arrhythmia detection, ST Segment analysis, BIS and RM monitoring are not intended for neonatal patients; the ICG is only for use on adult patients who meet the following requirements: height: 122 to 229cm, weight: 30 to 159kg.

The monitors are to be used in healthcare facilities by clinical physicians or appropriate medical staff under the direction of physicians. It is not intended for helicopter transport, hospital ambulance, or home use.



WARNING

- **This patient monitor is intended for use only by clinical professionals or under their guidance. It must only be used by persons who have received adequate training in its use. Anyone unauthorized or untrained must not perform any operation on it.**
-

2.1.2 Contraindications

None.

2.1.3 Components

This patient monitor consists of a main unit, display, measurement module racks, SpO₂ sensor, NIBP cuff, IBP cables, C.O. cables, CO₂ components, AG components, RM components, BIS components, etc.

2.2 Main Unit

2.2.1 Front View

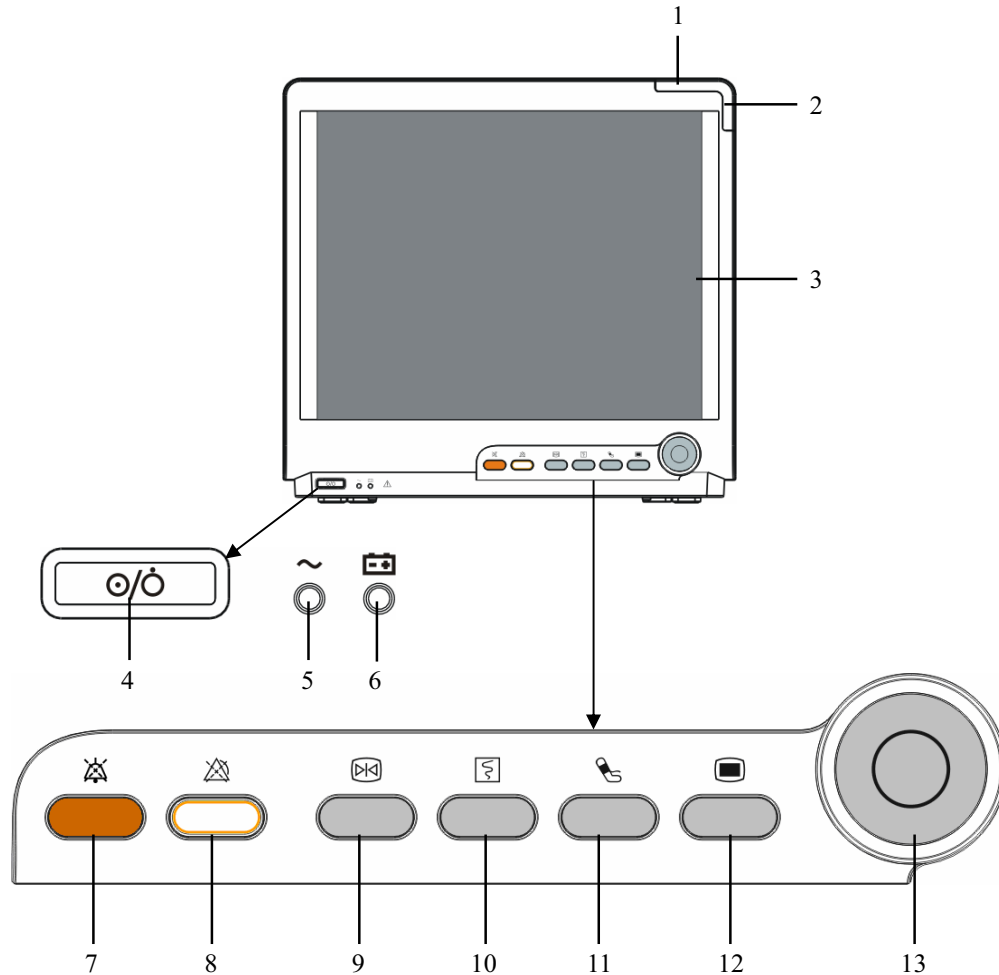

1. Alarm lamp

When a physiological alarm or technical alarm occurs, this lamp will flash as defined below.

- ◆ High level alarms: the lamp quickly flashes red.
- ◆ Medium level alarms: the lamp slowly flashes yellow.
- ◆ Low level physiological alarms: the lamp lights yellow without flashing.
- ◆ Low level technical alarms: the lamp does not light.

2. Technical alarm lamp

This lamp will light blue when a technical alarm occurs.

3. Display Screen

4. Power On/Off Switch

Press this switch to turn the patient monitor on. Press it again and hold for 2 seconds to turn the patient monitor off. An indicator is built in this switch. It turns on when the patient monitor is on and turns off when the patient monitor is off.

5. AC power LED

It turns on when AC power is connected.

6. Battery LED

- ◆ On: when the battery is being charged or already fully charged.
- ◆ Off: when no battery is installed or no AC source is connected.
- ◆ Flash: when the patient monitor operates on battery power.

7.  Press to silence all alarm sounds.

8.  Press to pause or restore alarms.

9.  Press to freeze or unfreeze waveforms.

10.  Press to start or stop recordings.

11.  Press to start or stop NIBP measurements.

12. 

If no menu is displayed on the screen, pressing it will enter the main menu. If there is a menu displayed on the screen, pressing it will close that menu.

13. Knob

Rotate the Knob clockwise or anti-clockwise. With each click, the highlight jumps to the neighboring item. When you reach your desired item, press the Knob to select it

2.2.2 Side View

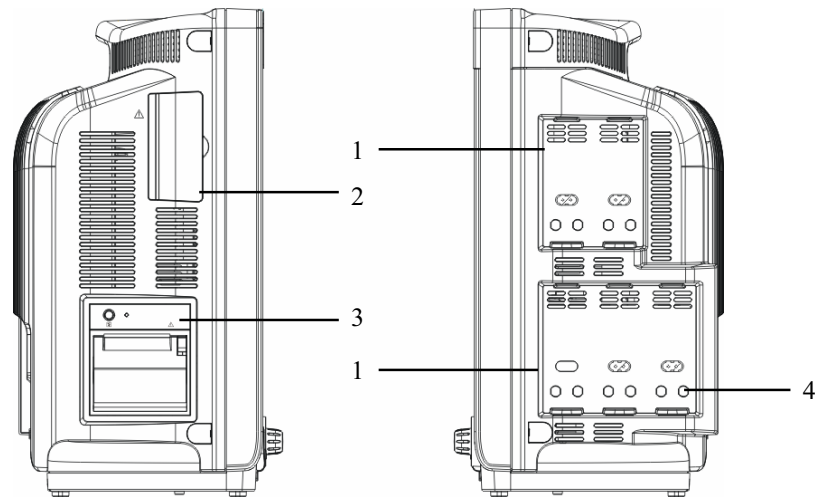

- 1. Integral Module Racks
- 2. Compartment for CF storage card slot
- 3. Recorder
- 4. Contact

NOTE

-
- To ensure a good contact, clean the contacts regularly, as dust and dirt may collect on them. When cleaning the contacts, wipe them with cotton, dampened with alcohol. (using forceps is recommended)
-

2.2.3 Bottom View

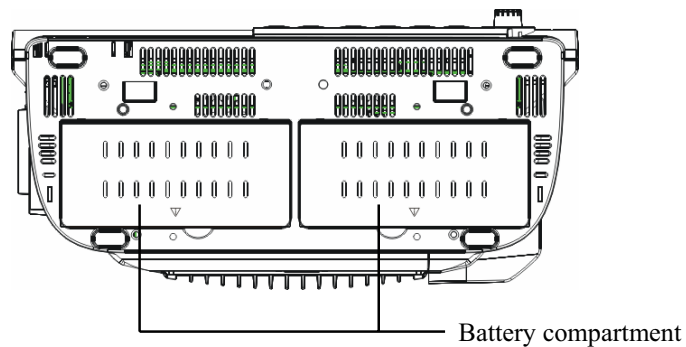

2.2.4 Rear View

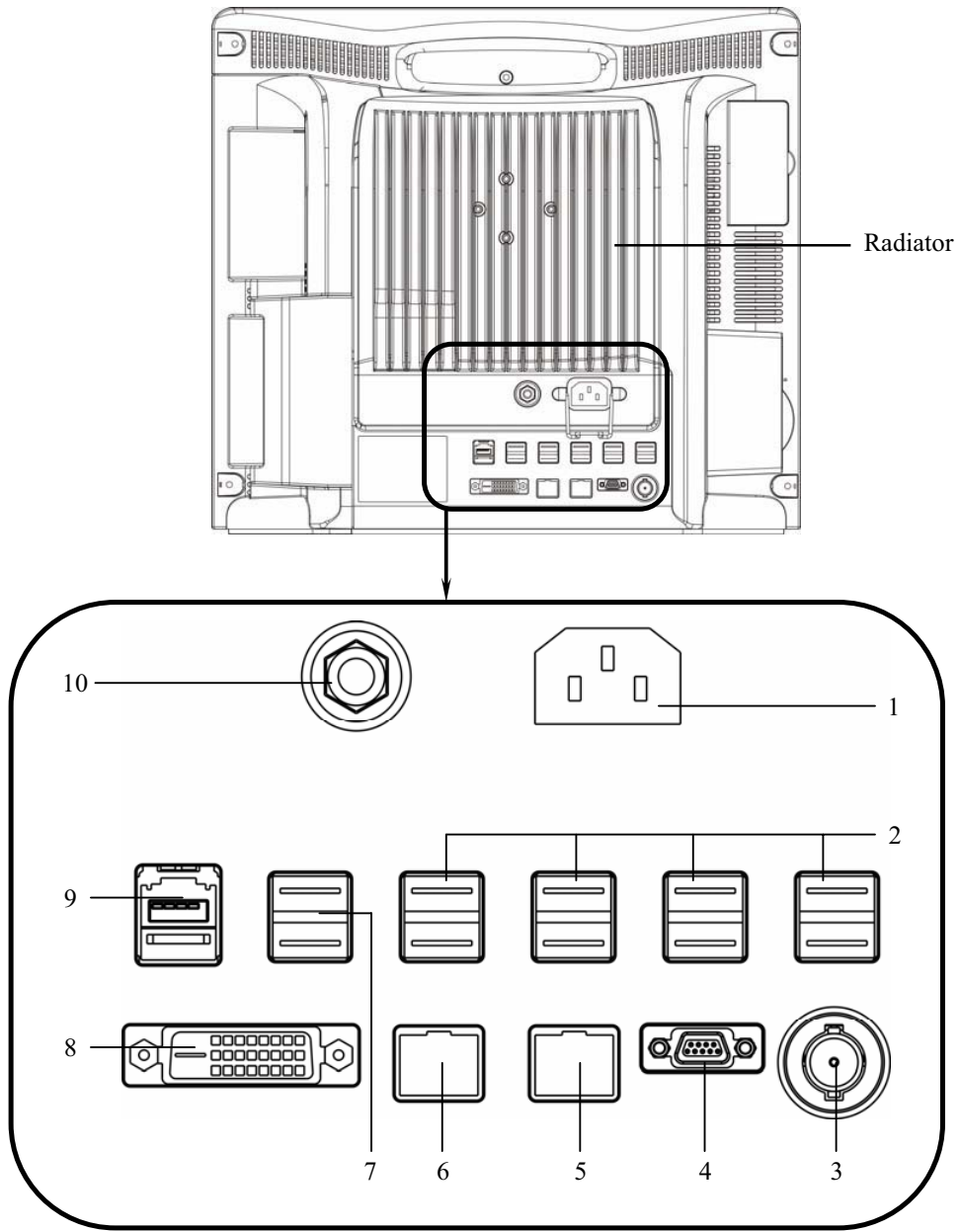

-
1. AC Power Input
 2. USB Connectors
They connect such devices as the USB mouse, USB keyboard, etc.
 3. Nurse Call Connector
It connects the patient monitor to the hospital's nurse call system. Alarms indications are alerted to nurses through the nurse call system, if configured to do so.
 4. Micro-D Connector
It outputs ECG, IBP and defibrillator synchronization signals simultaneously, among which the ECG signals supports pace pulses to be enhanced.
 5. Network Connector
It is a standard RJ45 connector that connects the patient monitor to the CMS.
 6. CIS Connector
It is a standard RJ45 connector that connects the patient monitor to the hospital's clinical information system (CIS). The CIS feature is available in China only.
 7. USB Connectors
They connect the controlling devices (USB mouse and USB keyboard) of the secondary display.
 8. Digital Video Interface (DVI)
It connects a secondary display, which extends the display capability of your monitor. The secondary display can be independently operated and controlled, and also display the contents different from the monitor screen.
 9. SMR Connector
It connects the satellite module rack (SMR).
 10. Equipotential Grounding Terminal
When the patient monitor and other devices are to be used together, their equipotential grounding terminals should be connected together, eliminating the potential difference between them.

2.3 Satellite Module Rack

The Satellite Module Rack (SMR) provides 8 slots for mounting measurement modules. The number of modules mounted in the SMR depends, as different modules may need different slots.

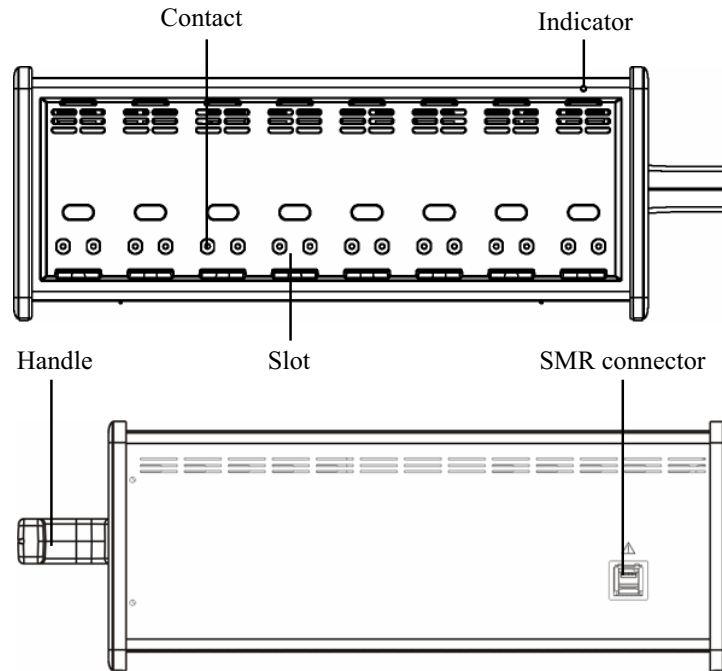

As shown in the figure above, there is an indicator telling the status of the SMR:

- On: when the SMR works normally.
- Off: when the SMR disconnects from the patient monitor, there is a problem with the power, or the patient monitor shuts down.

The SMR can be connected to the patient monitor through their SMR connectors via a SMR cable.

NOTE

- **To ensure a good contact, clean the contacts regularly, as dust and dirt may collect on them. When cleaning the contacts, wipe them with cotton, dampened with alcohol. (using forceps is recommended)**

2.4 Modules

As shown below, the patient monitor supports the following modules:



- **MPM:** Multi-parameter module. It can simultaneously monitor ECG, respiration, SpO₂, temperature, NIBP and IBP.
- **IBP module:** Invasive blood pressure module.
- **C.O. module:** Cardiac output module.
- **CCO/SvO₂ module:** CCO/SvO₂ interface module, used to interface with Edwards Vigilance II® monitor.
- **CO₂ module:** Carbon dioxide module (including sidestream, microstream and mainstream).
- **AG module:** Anaesthesia gas module. The functions of the O₂ and BIS modules can be incorporated into it.
- **ICG module:** Impedance cardiography module.
- **BIS module:** Bispectral index module.
- **RM module:** Respiration mechanics module.

Under the maximum configuration, the patient monitor has one two-slot module rack, one three-slot module rack and one satellite module rack. The number of modules mounted in the patient monitor depends, as different modules may need different slots.

2.4.1 Plug-In Modules

You can plug and unplug modules during patient monitoring. To plug a module, insert the module until the lever on the module clicks into place and then push the lock key at the bottom in position to lock the module. To remove a module, release the lock key, press the lever upwards and pull the module out.

Make sure that the indicator on the module lights on after the module is plugged in. Otherwise, re-plug the module until the indicator lights on.

2.4.2 Multi-Parameter Module

The multi-parameter module (MPM) incorporates multiple measurement modules. As shown below, the module name is located at the upper left corner, all hardkeys on the upper part, and all measurement connectors on the lower part. Other measurement modules look similar to the MPM.

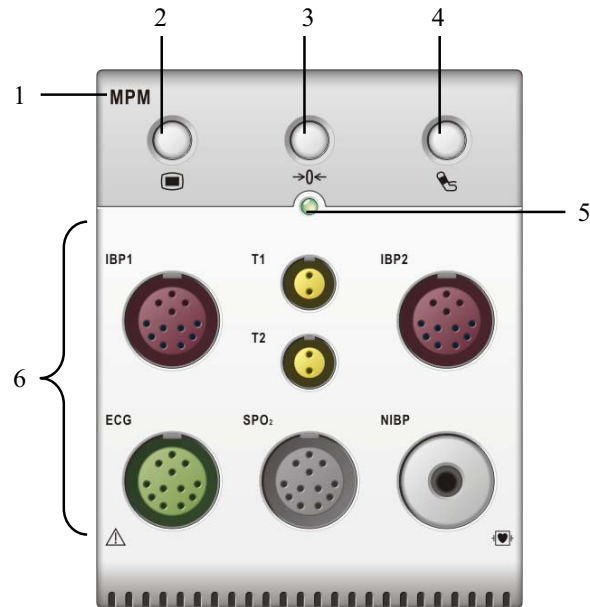

1. Module name
2. Setup key: press to enter the [**MPM Setup**] menu.
3. Zero key: press to enter the [**Zero IBP**] menu.
4. NIBP start/stop key: press to start or stop NIBP measurements.
5. Indicator
 - ◆ On: when the patient monitor works correctly.
 - ◆ Flash: when the module is being initialized.
 - ◆ Off: when the module is either unconnected or broken.
6. Measurement connectors

2.5 Display Screen

This patient monitor adopts a high-resolution TFT LCD to display patient parameters and waveforms. A typical display screen is shown below.

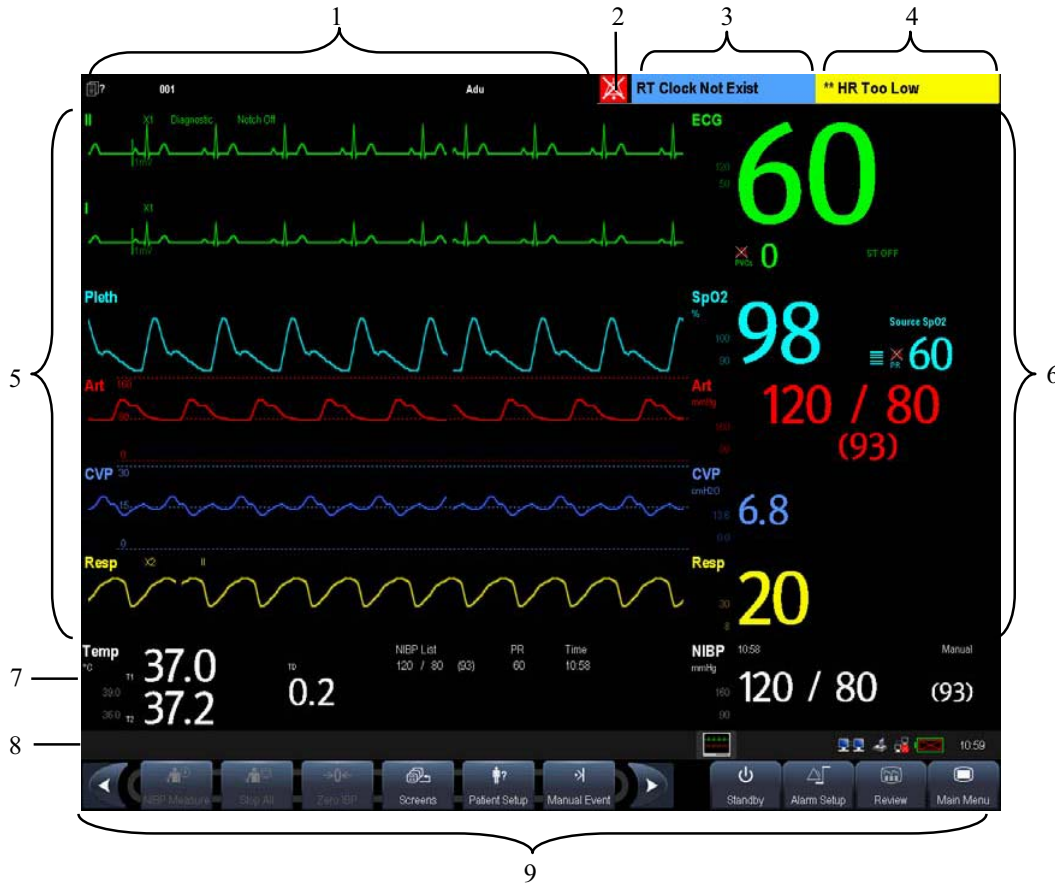

1. Patient Information Area

This area shows the patient information such as department, bed number, patient name, patient category and paced status.

- ◆ : indicates that no patient is admitted or the patient information is incomplete.
- ◆ : indicates that the patient has a pacer.

If no patient is admitted, selecting this area will enter the **[Patient Setup]** menu. If a patient has been admitted, selecting this area will enter the **[Patient Demographics]** menu.

2. Alarm Symbols

- ◆ indicates alarms are paused.
- ◆ indicates alarm sounds are paused.

-
- ◆  indicates alarm sounds are turned off.

3. Technical Alarm Area

This area shows technical alarm messages and prompt messages. When multiple messages come, they will be displayed circularly. Select this area and the technical alarm list will be displayed.

4. Physiological Alarm Area

This area shows physiological alarm messages. When multiple alarms occur, they will be displayed circularly. Select this area and the physiological alarm list will be displayed.

5. Waveform Area

This area shows measurement waveforms. The waveform name is displayed at the left upper corner of the waveform. Select this area and the corresponding measurement setup menu will be displayed.

6. Parameter Area A

This area shows measurement parameters. Each monitored parameter has a parameter window and the parameter name is displayed at the upper left corner. The corresponding waveform of each parameter is displayed in the same row in the waveform area. Select this area and the corresponding measurement setup menu will be displayed.

7. Parameter Area B

For the parameters displayed in this area, their corresponding waveform are not displayed.

8. Prompt Message Area

This area shows the prompt messages, network status icons, battery status icons, date and time, etc. For details about battery status symbols, refer to the chapter **27 Batteries**.

- ◆  indicates patient monitor is connected to a wire network successfully.

- ◆  indicates the patient monitor has failed to connect a wire network.

- ◆  indicates the wireless function is working.

- ◆  indicates the wireless function is not working.

- ◆  indicates a CF storage card is inserted.

- ◆  indicates a secondary display or remote display is connected.

- ◆  [Screen Setup] button

9. QuickKeys Area

This area contains QuickKeys that give you fast access to functions.

2.6 QuickKeys

A QuickKey is a configurable graphical key, located at the bottom of the main screen. They give you fast access to functions. Their availability and the order in which they appear on your screen, depend on how your patient monitor is configured.

By default, the following QuickKeys are displayed on the screen:



Scroll left to display more QuickKeys.



Scroll right to display more QuickKeys.



Enter the main menu



Enter standby mode



Change alarm settings



Review the patient's data



Enter the NIBP measurement menu



Stop all NIBP measurement



Zero IBP



Change screen



Enter the patient setup menu



Trigger a manual event



Start the realtime print



Print Setup



Have a split-screen view of minitrends



Enter the volume setup menu



Default configurations



Have the CIS view

You can also select your desired QuickKeys to display on the screen.

1. Select [**Main Menu**]→[**Maintenance >>**]→[**User Maintenance >>**]→enter the required password→[**Select QuickKeys >>**].
2. In the [**Select QuickKeys**] menu, select your desired QuickKeys and the order of them. Up to two pages of QuickKeys can be selected.
3. Select [**Ok**].

Besides the default QuickKeys listed above, there are still more QuickKeys:



Start cardiac output procedure (not available in USA)



View respiratory loops



Perform calculations



Have a split-screen view of another patient's conditions



Have a split-screen view of oxyCRG trends



Enter the interpretation of resting 12-lead ECG screen (not available in USA)



Enter the full-screen 7-lead ECG screen



Enter the [**Parameters**] menu



Start NIBP STAT measurement



Enter the PAWP measurement screen



Enter the CPB mode

FOR YOUR NOTES

3 Basic Operations

3.1 Installation

 **WARNING**

- The equipment shall be installed by personnel authorized by us.
 - The software copyright of the equipment is solely owned by us. No organization or individual shall resort to juggling, copying, or exchanging it or to any other infringement on it in any form or by any means without due permission.
 - Devices connected to the equipment must meet the requirements of the applicable IEC standards (e.g. IEC 60950 safety standards for information technology equipment and IEC 60601-1 safety standards for medical electrical equipment). The system configuration must meet the requirements of the IEC 60601-1-1 medical electrical systems standard. Any personnel who connect devices to the equipment's signal input/output port is responsible for providing evidence that the safety certification of the devices has been performed in accordance to the IEC 60601-1-1. If you have any question, please contact us.
 - If it is not evident from the equipment specifications whether a particular combination with other devices is hazardous, for example, due to summation of leakage currents, please consult the manufacturers or else an expert in the field, to ensure the necessary safety of patients and all devices concerned will not be impaired by the proposed combination.
-

3.1.1 Unpacking and Checking

Before unpacking, examine the packing case carefully for signs of damage. If any damage is detected, contact the carrier or us.

If the packing case is intact, open the package and remove the equipment and accessories carefully. Check all materials against the packing list and check for any mechanical damage. Contact us in case of any problem.

NOTE

-
- **Save the packing case and packaging material as they can be used if the equipment must be reshipped.**
-



WARNING

-
- **When disposing of the packaging material, be sure to observe the applicable waste control regulations and keep it out of children's reach.**
 - **The equipment might be contaminated during storage and transport. Before use, please verify whether the packages are intact, especially the packages of single use accessories. In case of any damage, do not apply it to patients.**
-

3.1.2 Environmental Requirements

The operating environment of the equipment must meet the requirements specified in this manual.

The environment where the equipment is used shall be reasonably free from noises, vibration, dust, corrosive, flammable and explosive substances. If the equipment is installed in a cabinet, sufficient space in front and behind shall be left for convenient operation, maintenance and repair. Moreover, to maintain good ventilation, the equipment shall be at least 2 inches (5cm) away from around the cabinet.

When the equipment is moved from one place to another, condensation may occur as a result of temperature or humidity difference. In this case, never start the system before the condensation disappears.



WARNING

- **Make sure that the operating environment of the equipment meets the specific requirements. Otherwise unexpected consequences, e.g. damage to the equipment, could result.**
-

3.2 Getting Started

3.2.1 Turning Power On

Once the patient monitor is installed, you can get ready for monitoring:

1. Before you start to make measurements, check the patient monitor, SMR and plug-in modules for any mechanical damage and make sure that all external cables, plug-ins and accessories are properly connected.
2. Plug the power cord into the AC power source. If you run the patient monitor on battery power, ensure that the battery is sufficiently charged.
3. Press the power on/off switch on the monitor's front. The start-up screens are displayed, and the technical alarm lamp and alarm lamp are lit in blue and yellow respectively. Then, the alarm lamp turns into red, and turns off together with the technical alarm lamp after the system gives a beep.
4. The monitor enters the main screen.



WARNING

- **Do not use the patient monitor for any monitoring procedure on a patient if you suspect it is not working properly, or if it is mechanically damaged. Contact your service personnel or us.**
-

3.2.2 Starting Monitoring

1. Decide which measurements you want to make.
2. Connect the required modules, patient cables and sensors.
3. Check that the patient cables and sensors are correctly connected.
4. Check that the patient settings such as [**Patient Cat.**], [**Paced**], etc, are appropriate for your patient.
5. Refer to the appropriate measurement section for details of how to perform the measurements you require.

3.3 Disconnecting from Power

To disconnect the patient monitor from the AC power source, follow this procedure:

1. Confirm that the patient monitoring is finished.
2. Disconnect the patient cables and sensors from the patient monitor.
3. Make sure to save or clear the patient monitoring data as required.
4. Press and hold the power on/off switch for above 2 seconds. The patient monitor shuts down and you can unplug the power cable.



CAUTION

- **Although not recommended, you can press and hold the power on/off switch for 10 seconds to forcibly shut down the monitor when it could not be shut down normally or under some special situations. This may cause loss of data of the patient monitor.**
-

3.4 Using a mouse

You can use the USB mouse supplied with the equipment as a monitor input device. The USB mouse can be plugged and unplugged with the monitor on.

When you are using a mouse:

- By default, the left mouse-button is the primary button and the right one the secondary button.
- Clicking the primary button equals to pressing the knob or selecting the touchscreen.
- The secondary button is disabled.

You can also define the right mouse-button as the primary button by following this procedure:

1. Select [**Main Menu**]→[**Maintenance >>**]→[**User Maintenance >>**]→enter the required password.
2. Select [**Others >>**] to enter the [**Others**] menu.
3. Select [**Primary Button**] and then select [**Right**] from the popup list.

3.5 Using Keys

The monitor has three types of keys:

- **Softkey:** A softkey is a graphic key on the screen, giving you fast access to certain menus or functions. The monitor has three types of softkeys:
 - ◆ **Waveform keys:** Each waveform area can be seen as a softkey. You can enter a waveform setup menu by selecting its corresponding waveform area.
 - ◆ **Parameter keys:** Each parameter area can be seen as a softkey. You can enter a parameter setup menu by selecting its corresponding parameter area.
 - ◆ **QuickKeys:** QuickKeys are configurable graphical keys, located at the bottom of the main screen. For details, refer to the section *QuickKeys*.
- **Hardkeys:** A hardkey is a physical key on a monitoring device, such as the main menu hardkey on the monitor's front.
- **Pop-Up Keys:** Pop-up keys are task-related keys that appear automatically on the monitor screen when required. For example, the confirm pop-up key appears only when you need to confirm a change.

3.6 Using Keyboards

The on-screen keyboard enables you to enter information. Use the **[Back]** key to delete the previously entered character. Use the **[Caps]** to toggle between uppercase and lowercase letters. Select **[Enter]** to confirm what you have entered and close the on-screen keyboard.

3.7 Using the Touchscreen

Select screen items by pressing them directly on the patient monitor's screen. You can enable or disable touchscreen operation by pressing and holding the **[Main Menu]**

QuickKey for 3 seconds. A padlock symbol  is displayed if touchscreen operation is disabled.

3.8 Setting the Screen

You can enter the [Screen Setup] window as shown below by selecting the [Screen Setup]

button  in the prompt message area. In this window, you can allocate the positions of the parameters and waveforms. The parameters or waveforms whose positions are not allocated will not be displayed.



The ECG parameter and the first ECG waveform always display in the first row. The configurable areas can be classified as Area A, Area B, and Area C.

- In Area A, you can choose to display the parameters (having waveforms) and their waveforms. Each parameter and the associated waveform are displayed in the same row.
- In Area B, you can choose to display the parameters and their waveforms. When there is no parameter displayed in area C, both the parameters and their waveforms will be displayed in area B. Otherwise, only the parameters will be displayed.
- In Area C, you can choose to display all the parameters whose associated waveforms will not be displayed.

The screen can automatically adjust to ensure the best view based on your screen setup.



If no corresponding parameter or waveform is displayed after the module is inserted, you should perform the following inspections:

- Check the connection between the module and lead, cable, sensor, or external device.
- Check whether there are the [The display setup for XX is disabled] message and the flashing [Screen Setup] button  in the prompt message area. If yes, select this button to enter the [Screen Setup] window for the desired display configuration.

 **WARNING**

- **The parameters whose positions are not allocated in the [Screen Setup] window will not be displayed. However, the monitor can still give alarms of these parameters.**
-

3.9 Using the Main Menu

To enter the main menu, select the  on-screen QuickKey or the  hardkey on the monitor's front. Most of monitor operations and settings can be performed through the main menu.

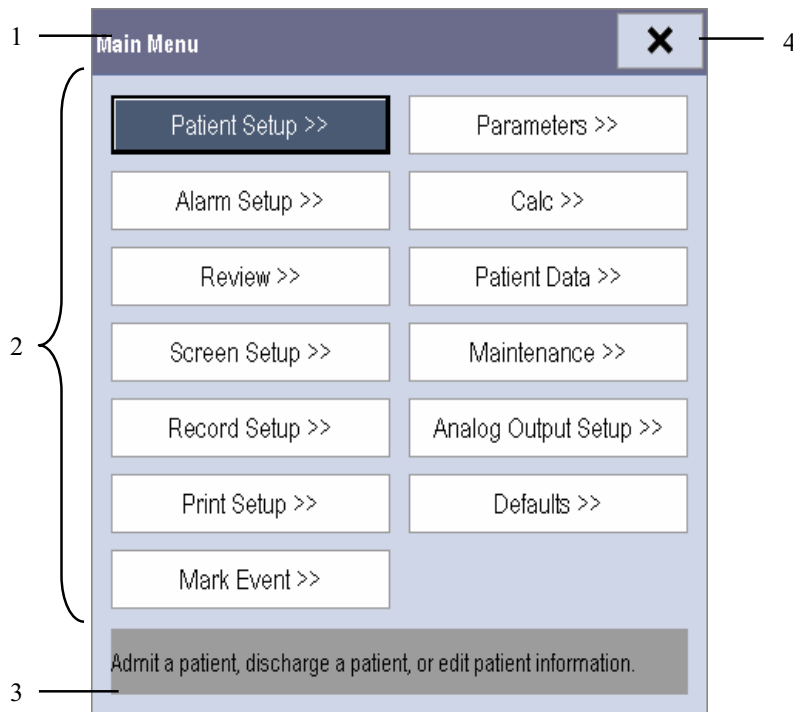

Other menus are similar to the main menu and contain the following parts:

1. Heading: gives a sum-up for the current menu.

2. Main body: displays options, buttons, prompt messages, etc. The menu button with “>>” enlarges a secondary window to reveal more options or information.
3. Online help area: displays help information for the highlighted menu item.
4. : select to exit the current menu.



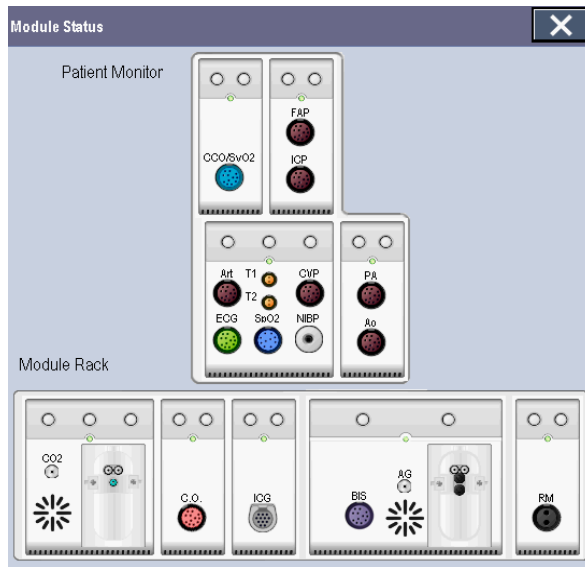

3.10 Setting Parameters

3.10.1 Accessing the Parameters Menu

Select [**Parameters >>**] from the main menu or select the [**Parameters**] QuickKey at the bottom of the screen to enter the [**Parameters**] menu where you can get the access of each parameter’s setup menu. You can further select [**Module Status >>**] to enter the menu as shown below. Your display may be configured to look slightly different depending on the modules mounted.



This menu displays the measurement modules mounted in the two-slot module rack, three-slot module rack and satellite module rack from top to bottom. Beside each measurement connector is the measurement label. The color in which a measurement connector appears matches the status as follows:

-  (colored) indicates that the module is turned on.
-  (grey) indicates that the module is turned off.
-  indicates a module name conflict.
-  indicates a module error.

3.10.2 Removing a Module Conflict

Besides three independent IBP modules and the IBP module on the MPM, the patient monitor supports only one more measurement module simultaneously. Otherwise, the message of module conflict will be prompted.

For example, if a CO₂ module (module A) is already loaded and then another CO₂ module (module B) is inserted, your patient monitor will then display module conflict. To use module A, just pull out module B. To use module B, pull both modules A and B out and then re-insert module B.

3.10.3 Removing a Label Conflict

Every label is unique and is assigned only once. The measurement label is stored inside the module. The system will prompt module name conflict when two measurement modules with the same name are used.

For example, an IBP module (module A) is already loaded and the Art label is used for module A. Then another IBP module (module B) is inserted and the Art label is also used for module B. In this case, your patient monitor will prompt the message of label conflict and display the [**Label**] menu.

- To use module A for Art measurement, just modify the label of module B on this channel in the [**Label**] menu. If the [**Label**] menu already exists inadvertently, you need to plug out and then plug in module B.
- To use module B for Art measurement, first exit the [**Label**] menu. Then select the Art parameter area on the screen and modify the label of module A on this channel in the popup menu. Finally, plug out and then plug in module B.

3.11 Using a CF Storage Card

A CF storage card is used to prevent data loss in case of a sudden power failure. The patient data such as trend data, waveform data, etc., will be automatically saved into the CF storage card during patient monitoring. In case of a sudden power failure, the patient data can be retrieved from the CF storage card after the patient monitor restarts.

Switching the patient monitor off before inserting or removing a CF card is a must. To insert a CF storage card, open the compartment and then insert the card until the button flips out. To remove the CF storage card, press the button until the CF storage card flips out.

To browse the data saved in the CF storage card, follow this procedure:

1. Select [**Main Menu**]→[**Patient Data >>**]→[**History Data >>**].
2. Select a patient whose data you want to view from the [**Patient Data List**] and then select [**Review**].
3. Select [**Data Review**].

As reviewing the history patient's data is just like reviewing the current patient's data, you can refer to the chapter **22 Review** for details.

If CF card problem occurs, you can refer to the following table for solutions.

Symptoms	Possible Cause	Corrective Action
CF card malfunctions	Wrong CF card or small memory space	Use only SanDisk-manufactured CF storage cards. Those with 1GB memory space are recommended.
	CF card full; data error; CF card error	Format CF card on PC.
	CF card failure	Replace the CF card.
	Cable defective or poorly connected	1. Check that the cable between CF card board and mother board is correctly connected. 2. Check that connecting cables and connectors not damaged.
	CF card board failure	Replace the CF card board.
	Mother board failure	Replace the mother board.

NOTE

- Data may be unable to be saved into the CF storage card when the patient monitor is just turned on.
 - If no CF storage card is used, all the data you have saved will get lost in case of monitor shut-down or sudden power interrupt.
-

CAUTION

- To avoid electrostatics, do not come into contact with the CF storage card when the patient monitor is on.
 - Do not insert or remove the CF storage card when the patient monitor is on. Otherwise it may cause damage to the CF storage card and the patient monitor.
 - Use only the CF storage card specified by Mindray.
-

3.12 Changing General Settings

This chapter covers only general settings such as language, brightness, date and time, etc. Measurement settings and other settings can be referred to in respective sections.

3.12.1 Setting up a Monitor

In situations where you install a patient monitor or change the patient monitor's application site, you need to setup the patient monitor as follows:

1. Select **[Main Menu]**→**[Maintenance >>]**→**[User Maintenance >>]**→enter the required password.
2. In the **[User Maintenance]** menu, select, in turn, **[Monitor Name]**, **[Department]** and **[Bed No.]**, and then change their settings.

3.12.2 Changing Language

1. Select **[Main Menu]**→**[Maintenance >>]**→**[User Maintenance >>]**→enter the required password.
2. In the **[User Maintenance]** menu, select **[Language]** and then select the desired language.
3. Restart the patient monitor.

3.12.3 Adjusting the Screen Brightness

1. Select the [Main Menu]→[Screen Setup >>]→[Brightness].
2. Select the appropriate setting for the screen brightness. 10 is the brightest, and 1 is the least bright.

If the patient monitor operates on battery power, you can set a less bright screen to prolong the operating time of the battery. When the patient monitor enters standby mode, the screen will change to the least brightness automatically.

3.12.4 Showing/Hiding the Help

The patient monitor provides online help information. The user can display or hide the help as required.

1. Select [Main Menu]→[Screen Setup >>].
2. Select [Help] and toggle between [On] and [Off].

3.12.5 Setting the Date and Time

1. Select [Main Menu] →[Maintenance >>]→[System Time >>].
2. Set the date and time.
3. Select [Date Format] and toggle between [yyyy-mm-dd], [mm-dd-yyyy] and [dd-mm-yyyy].
4. Select [Time Format] and toggle between [24h] and [12h].

If your patient monitor is connected to a central monitoring system (CMS), the date and time are automatically taken from that CMS. In that case, you cannot change the date and time settings on your patient monitor.



CAUTION

- **Changing date and time will affect the storage of trends and events and may cause data missing.**
-

3.12.6 Adjusting Volume

Alarm Volume

1. Select the **[Volume Setup]** QuickKey, or **[Main Menu]**→**[Alarm Setup >>]**→**[Others]**.
2. Select **[Alm Volume]** and then select the appropriate volume: X-10, in which X is the minimum volume, depending on the set minimum alarm volume (refer to the chapter Alarm), and 10 the maximum volume.

Key Volume

1. Select the **[Volume Setup]** QuickKey, or **[Main Menu]**→**[Screen Setup >>]**.
2. Select **[Key Volume]** and then select the appropriate volume. 0 means off, and 10 the maximum volume.

QRS Volume

The QRS tone is derived from either the HR or PR, depending on which is currently selected as the alarm source in **[ECG Setup]** or **[SpO2 Setup]**. When monitoring SpO₂, there is a variable pitch tone which changes as the patient's saturation level changes. The pitch of the tone rises as the saturation level increases and falls as the saturation level decreases. The volume of this tone is user adjustable.

1. Select the **[Volume Setup]** QuickKey, or the ECG parameter window→**[Others >>]**, or the SpO₂ parameter window.
2. Select **[QRS Volume]** or **[Beat Vol]** and then select the appropriate volume. 0 means off, and 10 the maximum volume.

3.13 Managing Configurations

3.13.1 Restoring the Latest Configuration Automatically

During operation, you may make changes to some settings. However, these changes may not be saved as user configuration. To prevent the changes from losing in case of a sudden power failure, the patient monitor stores the configuration in real time. The saved configuration is the latest configuration. The monitor restore the latest configuration if restarts within 60 seconds after the power failure. And it will restore the default configuration rather than the latest configuration if restarts 120 seconds later after the power failure. The monitor may load either the latest configuration or the default configuration if restarts from 60-120 seconds after the power failure.

3.13.2 Setting Default Configuration at Startup

When the patient monitor restarts after quitting over 120 seconds, it will load the pre-set default configuration to restore the system configuration. The default configuration can be either the latest configuration, or a factory or user configuration.

To set default configuration at startup:

1. Select [**Main Menu**]→[**Maintenance >>**]→[**User Maintenance >>**]→enter the required password→[**Manage Configuration >>**].
2. Select [**Select Default Config. >>**].
3. In the [**Select Default Config.**] menu, toggle between [**Load Last Config.**] and [**Load Specified Config.**].

When you select [**Load Specified Config.**], the configuration (adult, pediatric or neonate) to be restored is subject to the patient category. This configuration can be either factory configuration or saved user configuration. Take adult as an example, select [**Default Adu Config.**] and toggle between [**Factory Default Adu Config.**] or user configuration(s).

NOTE

- To know what configuration is restored when the patient monitor starts, enter the main screen to check the prompt information at the lower part of the screen (displayed for about 10 seconds).

3.13.3 Saving as User Configuration

You can change monitor settings as required and then save the changed settings into a user configuration. This patient monitor can save multiple user configurations, and you can name the saved user configurations.

1. Change monitor setting as required and make sure that the changes are suitable for your patient.
2. Select [**Main Menu**]→[**Maintenance>>**]→[**User Maintenance >>**]→enter the required password→[**Manage Configuration >>**].
3. Select [**Save as User Default Config. >>**].
4. Enter a name and select [**Save**]. If the entered name already exists, a message box will appear. Proceed by following the message.

The configuration name saved in the patient monitor is in the form of “entered name+patient category+Config”. e.g., if you enter the name “ICU1” and the current patient is an adult, the configuration name will be “ICU1 Adult Config”.

3.13.4 Deleting a User Default Configuration

You can delete an already saved user configuration.

1. Select [**Main Menu**]→[**Maintenance>>**]→[**User Maintenance >>**]→enter the required password→[**Manage Configuration >>**].
2. Select [**Delete User Default Config. >>**].
3. Select the configuration to be deleted. Select [**Delete**] and then select [**Yes**] from the popup menu.

3.13.5 Restoring Default Configuration Manually

You may make changes to some settings in some occasions. However, these changes may not be appropriate or correct, especially when a new patient is admitted. Therefore, in actual applications, you should restore the default configuration as required so as to ensure that the applied configuration is suitable for your patient.

To restore a certain default configuration:

1. Select [**Main Menu**]→[**Defaults >>**].
2. Select a factory or user configuration.
3. Select [**Yes**].

FOR YOUR NOTES

4 Managing Patients

4.1 Admitting a Patient

The patient monitor displays physiological data and stores them in the trends as soon as a patient is connected. This allows you to monitor a patient that is not admitted yet. However, it is recommended that you fully admit a patient so that you can clearly identify your patient, on recordings, reports and networking devices.

To admit a patient:

1. Select the [**Patient Setup**] QuickKey, or [**Main Menu**]→[**Patient Setup >>**].
2. Select [**Discharge Patient**] to clear any previous patient data. If you do not erase data from the previous patient, the new patient's data will be saved into the data of the previous patient. The monitor makes no distinction between the old and the new patient data.
3. If [**Discharge Patient**] button appears dimmed, directly select [**Admit Patient**] and then select:
 - ◆ [**Yes**] to apply the data saved in the patient monitor to the new patient, or
 - ◆ [**No**] to clear the data saved in the patient monitor.
4. In the [**Patient Demographics**] menu, enter the demographic details, of which:
 - ◆ [**Patient Cat.**] determines the way your patient monitor processes and calculates some measurements, and what safety and alarm limits are applied for your patient.
 - ◆ [**Paced**] determines whether to show pace pulse marks on the ECG waveform. When the [**Paced**] is set to [**No**], pace pulse marks are not shown in the ECG waveform.
5. Select [**Ok**].

 **WARNING**

- **[Patient Cat.] and [Paced] will always contain a value, regardless of whether the patient is fully admitted or not. If you do not specify settings for these fields, the patient monitor uses the default settings from the current configuration, which might not be correct for your patient.**
 - **For paced patients, you must set [Paced] to [Yes]. If it is incorrectly set to [No], the patient monitor could mistake a pace pulse for a QRS and fail to alarm when the ECG signal is too weak.**
 - **For non-paced patients, you must set [Paced] to [No]. If it is incorrectly set to [Yes], the patient monitor may be unable to detect premature ventricular beats (including PVCs) and perform ST segment analysis.**
-

4.2 Quick Admitting a Patient

Use **[Quick Admit]** only if you do not have the time or information to fully admit a patient. Complete the rest of the patient demographic details later. Otherwise, the  symbol will always be displayed in the patient information area.

1. Select the **[Patient Setup]** QuickKey, or **[Main Menu]→[Patient Setup >>]**.
2. Select **[Quick Admit]**. If a patient has been admitted at present, select **[OK]** to discharge the current patient. If no patient is admitted, you can choose either:
 - ◆ **[Yes]** to apply the data in your patient monitor to the new patient, or
 - ◆ **[No]** to clear any previous patient data.
3. Enter the patient category and paced status for the new patient, and then select **[Ok]**.

4.3 Editing Patient Information

To edit the patient information after a patient has been admitted, or when the patient information is incomplete, or when you want to change the patient information:

1. Select the **[Patient Setup]** QuickKey, or **[Main Menu]→[Patient Setup >>]**.
2. Select **[Patient Demographics]** and then make the required changes.
3. Select **[Ok]**.

4.4 Discharging a Patient

To discharge a patient:

1. Select the **[Patient Setup]** QuickKey, or **[Main Menu]→[Patient Setup >>]**.
2. Select **[Discharge Patient]**. In the popup dialog box, you can either:
 - ◆ Select **[Ok]**. The patient monitor enters the standby mode after discharging the current patient, or
 - ◆ Select **[Cancel]** to exit without discharging the patient.

NOTE

-
- **Discharging a patient clears all history data in the monitor.**
-

4.5 Transferring a Patient

You can transfer a patient with an MPM to a new location without re-entering the patient demographic information or changing the settings. Transferring of patient data enables you to understand the patient's history condition.

Familiarizing yourself with the data respectively stored in the patient monitor and MPM helps you understand the effects incurred by transferring patients with an MPM.

Contents stored		In the patient monitor	In the MPM
Data	Patient demographics (Name, Bed No., Gender, etc.)	Yes	Yes
	Trend data	Yes	Yes
	Calculation data (Dose calculations, oxygenation calculations, etc.)	Yes	No
	Event data (Marked events, alarm events, etc.)	Yes	No
Settings	Monitor settings (Alarm pause, alarm volume, etc.)	Yes	No
	Parameter settings (Alarm limits, measurement module on/off, etc.)	Yes	Yes

Before transferring a patient with an MPM, set on the desired monitor as follows:

1. Select [**Main Menu**]→[**Maintenance**]→[**User Maintenance >>**]→enter the required password.
2. Select [**Others >>**].
3. Set [**Transfer MPM Data**] to [**On**].
4. Set [**Apply MPM Settings**] to [**On**]. If your patient monitor does not have this option, the system applies MPM settings by default.

Then, follow this procedure to transfer the patient:

1. Disconnect the MPM from the original monitor.
2. Connect the MPM to the monitor.
3. If there is a mismatch between the MPM and monitor, the system will automatically display the [**Select Patient**] menu, from which you can choose the data set you want to continue using for this patient, either:
 - ◆ [**Continue Monitor**]:continue with the patient data and settings in the monitor, deleting all patient data and setting in the MPM and copying all data in the monitor to the MPM.
 - ◆ [**Continue MPM**]:continue with the patient data and settings in the MPM. Discharge the patient in the monitor. The monitor then automatically admits the patient and copies all data from the MPM.

- ◆ **[New Patient]**: select this button if none of the information is correct. This deletes all data in the monitor and MPM and lets you admit a new patient on the monitor. In this case, you need to re-enter the patient demographics. The monitor will restore the settings according to the patient category.
- ◆ **[Same Patient]**:select this button if the patient demographics are different, but it is the same patient. This merges the patient’s trend data in the monitor and MPM and copies the settings in the MPM to the monitor as well.

4. Select **[Yes]**.

Operations	Examples of applications
Continue Monitor	1. Replace the MPM during patient monitoring. 2. After the patient is admitted, connect the MPM.
Continue MPM	A patient is monitored using an MPM. You need to move the patient to a new location, e.g. from a ward (original monitor) to the operating room (destination monitor)
New Patient	Connect the MPM before admitting a new patient. However, the monitor and/or MPM store the previous patient’s data and settings.
Same Patient	A patient is admitted by a monitor, to which an MPM used in another monitor for monitoring this patient is connected.

 **WARNING**

- **After a patient is successfully transferred, check if the patient settings (especially patient category, paced status and alarm limits settings, etc) on the monitor are appropriate for this patient.**
 - **Only when you open MPM transfer function and select [Continue MPM], the IBP labels can be transferred along with the MPM module.**
-
-

4.6 Connecting to Panorama™ Central Station

If your patient monitor is connected to a Panorama Central Station:

- All patient information, measurement data and settings on the patient monitor can be transmitted to the Panorama Central Station.
- All patient information, measurement data and settings can be displayed simultaneously on the patient monitor and Panorama. For some functions such as editing patient information, admitting a patient, discharging a patient, etc., bi-directional control can be achieved between your patient monitor and Panorama. The patient monitor is also capable of bi-directional transmission of patient alarm settings with a Panorama.

For details, refer to the Panorama Operating Instructions Manual.

5 User Screens

5.1 Tailoring Your Screens

You can tailor your patient monitor's screens by setting:

- Waveform sweep mode
- Wave line size
- The color in which each measurement's numerics and waveform are displayed
- The parameter to be monitored.

Changing some settings may be hazardous. Therefore, those settings are password-protected and can be modified by authorized personnel only. Once change is made, those who use the patient monitor should be notified.

5.1.1 Setting the Waveform Sweep Mode

1. Select [**Main Menu**]→[**Screen Setup >>**].
2. Select [**Sweep Mode**] and toggle between [**Refresh**] and [**Scroll**].
 - ◆ [**Refresh**]: The waveforms keep stationary, being refreshed from left to right by a moving “erase bar”.
 - ◆ [**Scroll**]: The waveforms move from the right to the left with time passing by.

5.1.2 Changing the Wave Line Size

1. Select [**Main Menu**]→[**Maintenance >>**]→[**User Maintenance >>**]→enter the required password.
2. Select [**Others >>**].
3. Select [**Wave Line**] and toggle between [**Thick**], [**Mediate**] and [**Thin**].

5.1.3 Changing Measurement Colors

1. Select [**Main Menu**]→[**Screen Setup >>**]→[**Measurement Color Setup >>**].
2. Select the color box next to your desired measurement and then select a color from the popup menu.

5.1.4 Changing Screen Layout

Select the [Screens] QuickKey, or [Main Menu]→[Screen Setup >>]→[Screen Layout >>] to enter the [Screens] menu.

- You can choose the desired screen type in the [Choose Screen] window.
- You can select the parameters and waveforms you want to view in the [Screen Setup] window. For details, please refer to the section *Setting the Screen*.
- You can select the parameters you want to view on big numerics screen in the [Big Numerics Screen Setup] window.

5.2 Viewing Minitrends

5.2.1 Having a Split-Screen View of Minitrends

You can split the normal screen so that one part of the screen, on the left hand side, continuously shows graphic minitrends beside waveforms as shown in the figure below.

To have a split-screen view of minitrends, you can:

- Select [**Minitrends**] QuickKey, or
- Select [**Screens**] QuickKey→[**Minitrends Screen**]→**X**, or
- Select [**Main Menu**]→[**Screen Setup >>**]→[**Screen Layout >>**]→[**Minitrends Screen**]→**X**.

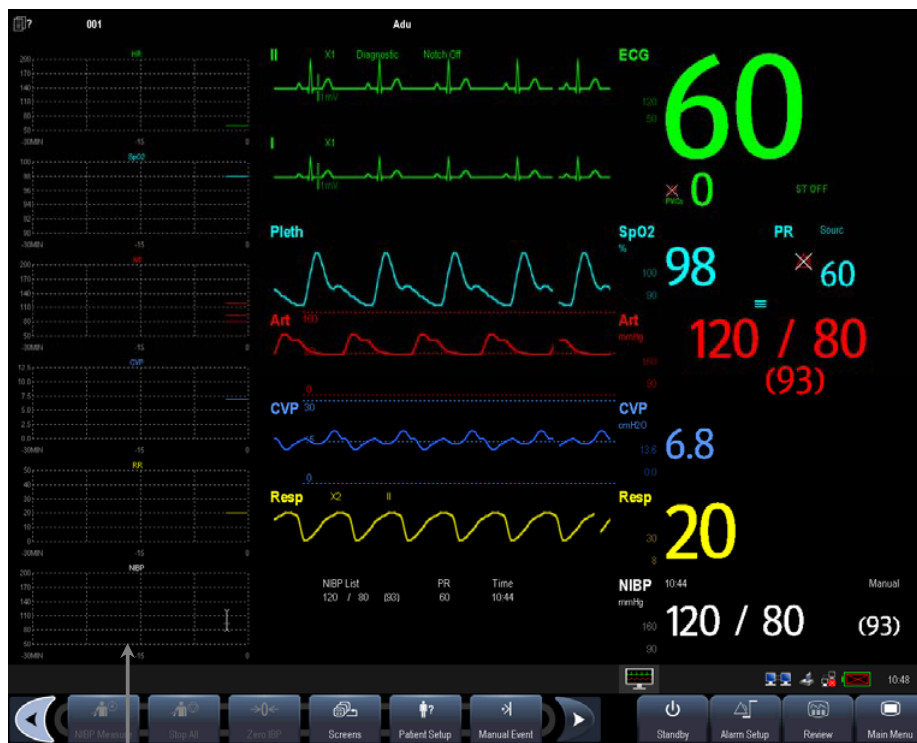

Minitrend View

The split-screen view provides minitrends for multiple parameters. In each field, the label, scale and time are respectively displayed at the top, left, and bottom as shown below.

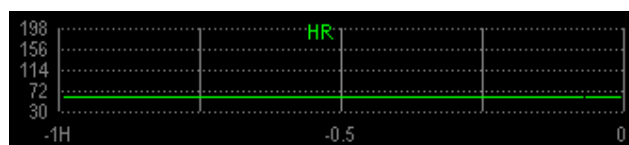

5.2.2 Setting Minitrends

Select the minitrends area. From the pop-up [**Minitrend Setup**] menu, you can:

- Select the parameters to be displayed, or
- Select [**Minitrend Length**] and then select the appropriate setting.

5.3 Viewing oxyCRG

To have a split screen view of oxyCRG, you can:

- Select [**oxyCRG**] QuickKey, or
- Select [**Screens**] QuickKey→[**OxyCRG Screen**]→**X**, or,
- Select [**Main Menu**]→[**Screen Setup >>**]→[**Screen Layout >>**]→[**OxyCRG Screen**]→**X**.

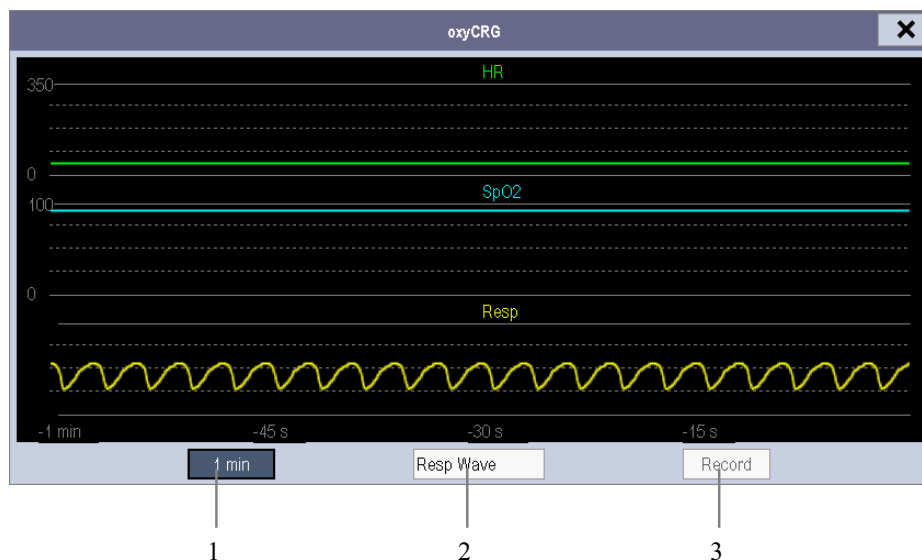

The split-screen view covers the lower part of the waveform area and shows HR trend, SpO₂ trend and RR trend (or Resp wave). At the bottom, there are controls:

1. Trend length list box
In the trend length list box, you can select [**1 min**], [**2 min**], [**4 min**], or [**8 min**].
2. Resp Wave (or RR Trend) list box
From this list box, you can select either [**Resp Wave**] or [**RR Trend**] for display.
3. Record
Through this button, you can print out the currently displayed oxyCRG trends by the recorder.

5.4 Viewing Other Patients

5.4.1 Care Group

If your patient monitor is connected to a central monitoring system, you can select up to 16 patient monitors (including telemetry connected to the same central monitoring system) into a Care Group. This lets you:

- View information on the monitor screen from another bed in the same Care Group.
- Be notified of physiological and technical alarm conditions at the other beds in the same Care Group.

To have a Care Group:

1. Open the [**View Other Patient**] window by:
 - ◆ Selecting [**Others**] QuickKey, or
 - ◆ Selecting [**Screens**] QuickKey→[**View Others Screen**]→**X**, or
 - ◆ Selecting [**Main Menu**]→[**Screen Setup >>**]→[**Screen Layout >>**]→[**View Others Screen**]→**X**.
2. Select [**Setup**] in the [**View Other Patient**] window.
3. Select the desired patient monitors from the [**Connected Monitor List**], and then select the **X** button. The selected patient monitors constitute a Care Group.

5.4.2 Viewing the Care Group Overview Bar



The Care Group overview bar locates at the bottom of the [**View Other Patient**] window. In the overview bar, the department and bed label for any Care Group beds are displayed. For telemetry, # is displayed before the department label. The color in which a Care Group bed appears matches its status:

- Red: indicates the bed is giving high-level physiological alarms or the telemetry is giving alarm, such as nurse call or event.
- Yellow: indicates the bed is giving medium- or low-level physiological alarms, or medium-level technical alarms.
- Blue: indicates the bed is giving low-level technical alarms.
- Grey: indicates the bed fails to be networked or stays in the standby mode.

You can view a Care Group bed's alarms by selecting it from the care group, and as well you can select the [**View This Patient**] button to view this bed in the [**View Other Patient**] window.

For more details about Care Group alarms, refer to the *Alarms* chapter.

5.4.3 Understanding the View Other Patient Window

When you first open the [View Other Patient] window, the patient monitor automatically selects a monitor from the network to display in the [View Other Patient] window.

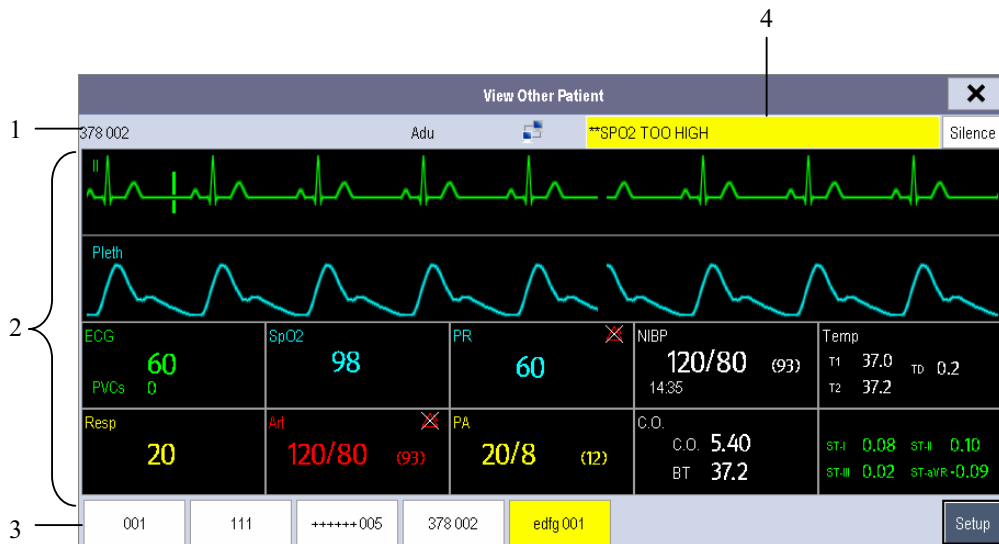

The [View Other Patient] window covers the lower part of the waveform area and consists of:

1. Information Area: shows the patient information (including department, bed number, patient name, etc.) and network status symbols.
2. View Area: shows physiological waveforms and parameters. You can switch a waveform area to a parameter area by selecting your desired waveform area and then selecting [Switch to Parameter Area], or switch a parameter area to a waveform area by selecting your desired parameter area and then selecting [Switch to Waveform Area].
3. Care Group Overview Bar.
4. Message Area: shows physiological and technical messages from the currently viewed patient monitor. It also shows the alarm given by the telemetry such as nurse call or event. By selecting this area, you can enter the [Alarm Information List] to view all physiological, technical and prompt messages coming from the currently viewed patient.

Additionally, you can change a waveform or parameter for viewing

- To change a waveform for viewing, select the waveform segment where you want a new waveform to appear and then select the waveform you want from the popup menu.
- To change a parameter for viewing, select the parameter window where you want a new parameter to appear and then select the parameter you want from the popup menu.

⚠ WARNING

- The data presented in the [View Other Patient] window have delay. Do not rely on this window for realtime data.
-

5.5 Understanding the Big Numerics Screen

To enter the big numerics screen:

1. Select the [Screens] QuickKey, or [Main Menu]→[Screen Setup >>]→[Screen Layout >>].
2. Select [Big Numerics]→**X**.

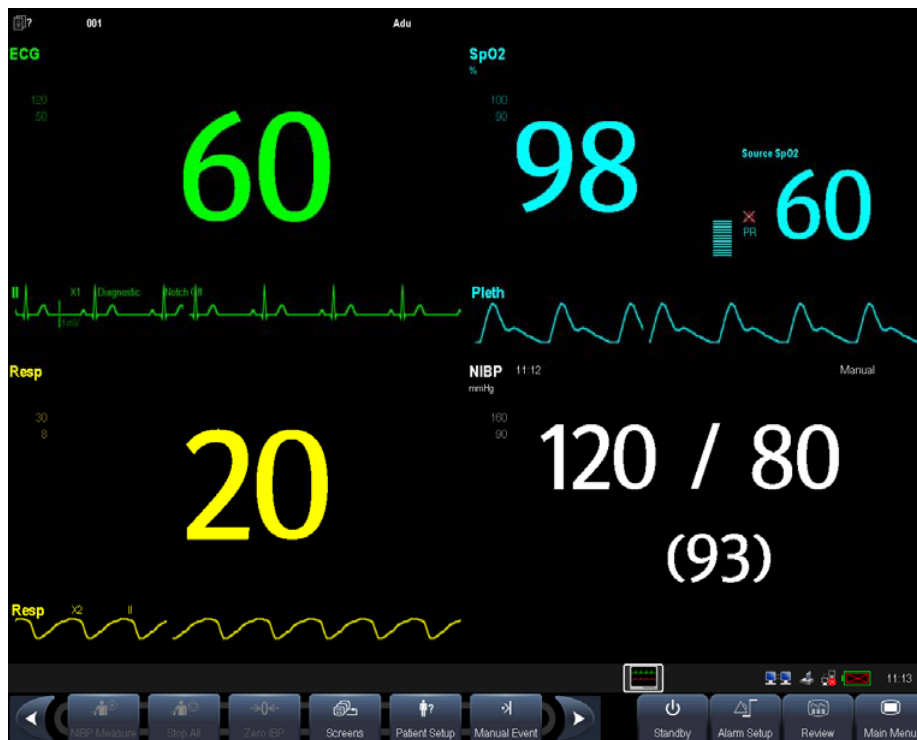

You can select your desired parameters to display in this screen: select the [Screens] QuickKey→[Big Numerics Screen Setup] and then select the parameters you want. For parameters having a waveform, the waveform will also be displayed.

FOR YOUR NOTES

6 Alarms

Alarms, triggered by a vital sign that appears abnormal or by technical problems of the patient monitor, are indicated to the user by visual and audible alarm indications.

WARNING

- **A potential hazard can exist if different alarm presets are used for the same or similar equipment in any single area, e.g. an intensive care unit or cardiac operating room.**
 - **If your patient monitor is connected to a CMS, remote suspension, inhibition, silence and reset of monitor alarms via the CMS may cause a potential hazard.**
-
-

6.1 Alarm Categories

By nature, the patient monitor's alarms can be classified into three categories: physiological alarms, technical alarms and prompt messages.

1. Physiological alarms

Physiological alarms, also called patient status alarms, are triggered by a monitored parameter value that violates set alarm limits or an abnormal patient condition.

Physiological alarm messages are displayed in the physiological alarm area.

2. Technical alarms

Technical alarms, also called system status alarms, are triggered by a device malfunction or a patient data distortion due to improper operation or mechanical problems. Technical alarm messages are displayed in the technical alarm area.

3. Prompt messages

As a matter of fact, prompt messages are not alarm messages. Apart from the physiological and technical alarm messages, the patient monitor will show some messages telling the system status. Messages of this kind are included into the prompt message category and usually displayed in the prompt information area. But for some measurements, their related prompt messages are displayed in their respective parameter windows.

6.2 Alarm Levels

By severity, the patient monitor's alarms can be classified into three categories: high level, medium level and low level..

	Physiological alarms	Technical alarms
High level	Indicate that your patient is in a life threatening situation, such as Asystole, Vfib/Vtac and so forth, and an emergency treatment is demanded.	Indicate a severe device malfunction or an improper operation, which could make it possible that the monitor cannot detect critical patient status and thus threaten the patient's life, such as low battery.
Medium level	Indicate that your patient's vital signs appear abnormal and an immediate treatment is required.	Indicate a device malfunction or an improper operation, which may not threaten the patient's life but may compromise the monitoring of vital physiological parameters.
Low level	Indicate that you patient's vital signs appear abnormal and an immediate treatment may be required.	Indicate a device malfunction or an improper operation, which may compromise a certain monitoring function but will not threaten the patient's life.

6.3 Alarm Indicators

When an alarm occurs, the patient monitor will indicate it to the user through visual or audible alarm indications.

- Alarm lamp
- Alarm message
- Flashing numeric
- Audible alarm tones
- Reminder Tones

6.3.1 Alarm Lamp

If a technical alarm occurs, the technical alarm lamp will turn blue. If a technical alarm or physiological alarm occurs, the alarm lamp will flash. The flashing color and frequency match the alarm level as follows:

- High level alarms: the lamp quickly flashes red.
- Medium level alarms: the lamp slowly flashes yellow.
- Low level physiological alarms: the lamp turns yellow without flashing.
- Low level technical alarms: the lamp does not light.

6.3.2 Alarm Message

When an alarm occurs, an alarm message will appear in the technical or physiological alarm area. For physiological alarms, the asterisk symbols (*) before the alarm message match the alarm level as follows:

- High level alarms: ***
- Medium level alarms: **
- Low level alarms: *

Additionally, the alarm message uses different background color to match the alarm level:

- High level alarms: red
- Medium level alarms: yellow
- Low level physiological alarms: yellow
- Low level technical alarms: blue

You can view the alarm messages by selecting the physiological or technical alarm area.

6.3.3 Flashing Numeric

If an alarm triggered by an alarm limit violation occurs, the numeric of the measurement in alarm will flash every second, and the corresponding alarm limit will also flash at the same frequency indicating the high or low alarm limit is violated.

6.3.4 Audible Alarm Tones

This monitor has three choices of alarm tones and patterns: ISO, Mode 1 and Mode 2. For each pattern, the alarm tones identify the alarm levels as follows:

- ISO pattern:
 - ◆ High level alarms: triple+double+triple+double beep.
 - ◆ Medium level alarms: triple beep.
 - ◆ Low level alarms: single beep.
- Mode 1:
 - ◆ High level alarms: high-pitched single beep.
 - ◆ Medium level alarms: double beep.
 - ◆ Low level alarms: low-pitched single beep.

-
- Mode 2:
 - ◆ High level alarms: high-pitched triple beep.
 - ◆ Medium level alarms: double beep.
 - ◆ Low level alarms: low-pitched single beep.

NOTE





- **When multiple alarms of different levels occur simultaneously, the patient monitor will select the alarm of the highest level and give visual and audible alarm indications accordingly.**
-

6.3.5 Reminder Tones

When alarm tones are silenced or turned off, the patient monitor will give a single beep in case of an active alarm condition.

6.3.6 Alarm Status Symbols

Apart from the aforementioned alarm indicators, the patient monitor still uses the following symbols telling the alarm status:

-  indicates alarms are paused.
-  indicates alarm sound is silenced.
-  indicates the alarm sound is turned off.
-  indicates individual measurement alarms are turned off.

6.4 Alarm Tone Configuration

6.4.1 Setting the Minimum Alarm Volume

1. Select [**Main Menu**]→[**Maintenance >>**]→[**User Maintenance >>**]→enter the required password.
2. Select [**Alarm Setup >>**] to enter the [**Alarm Setup**] menu.
3. Select [**Minimum Alarm Volume**] and toggle between 0 and 10.

The minimum alarm volume refers to the minimum value you can set for the alarm volume, which is not affected by user or factory default configurations. The setting of minimum alarm volume remains unchanged when the patient monitor shuts down and restarts.

6.4.2 Changing the Alarm Volume

1. Select the [**Volume Setup**] QuickKey or the [**Alarm Setup**] QuickKey→[**Others**], or [**Main Menu**]→[**Alarm Setup >>**]→[**Others**].
2. Select the appropriate volume from [**Alm Volume**]: X-10, in which X is the minimum volume, depending on the set minimum alarm volume, and 10 the maximum volume.

When alarm volume is set to 0, the alarm sound is turned off and a  symbol appears on the screen. The alarm volume returns to 2 automatically when:

- The patient monitor is shut down and then restarted.
- A certain user configuration which saves alarm volume as 0 is restored.
- The factory default configuration is restored.
- A switch between alarm statuses is made.

6.4.3 Setting the Interval between Alarm Sounds

You cannot change the interval between alarm tones if you choose mode 1 or 2 as your desired alarm tone pattern. For these two patterns, the interval between alarm tones identifies the alarm levels as follows:

- Mode 1:
 - ◆ Interval between high level alarm tones: continuously.
 - ◆ Interval between medium level alarm tones: 5 s.
 - ◆ Interval between low level alarm tones: 20 s.
- Mode 2:
 - ◆ Interval between high level alarm tones: 1 s.
 - ◆ Interval between medium level alarm tones: 5 s.
 - ◆ Interval between low level alarm tones: 20 s.

If you choose the ISO pattern, you can change the interval between alarm tones. To change the interval between alarm tones:

1. Select [**Main Menu**]→[**Maintenance >>**]→[**User Maintenance >>**]→enter the required password.
2. Select [**Alarm Setup >>**] to enter the [**Alarm Setup**] menu.
3. Select [**High Alarm Interval (s)**], [**Med Alarm Interval (s)**] and [**Low Alarm Interval (s)**] in turn and then select the appropriate settings.

WARNING

- **When the alarm sound is switched off, the patient monitor will give no audible alarm tones even if a new alarm occurs. Therefore the user should be very careful about whether to switch off the alarm sound or not.**
 - **Do not rely exclusively on the audible alarm system for patient monitoring. Adjustment of alarm volume to a low level may result in a hazard to the patient. Always keep the patient under close surveillance.**
-

6.4.4 Changing the Alarm Tone Pattern

To change the alarm tone pattern:

1. Select [**Main Menu**]→[**Maintenance >>**]→[**User Maintenance >>**]→enter the required password.
2. Select [**Alarm Setup >>**] to enter the [**Alarm Setup**] menu.
3. Select [**Alarm Sound**] and toggle between [**ISO**], [**Mode 1**]and [**Mode 2**].

User or factory default configurations exert no impact on the setup of alarm tone pattern. The alarm tone pattern remains unchanged after the monitor restarts.

6.4.5 Setting the Reminder Tones

1. Select [**Main Menu**]→[**Maintenance >>**]→[**User Maintenance >>**]→enter the required password.
2. Select [**Alarm Setup >>**] to enter the [**Alarm Setup**] menu.
 - ◆ To switch the reminder tones on or off, select [**Reminder Tones**] and toggle between [**On**] and [**Off**].
 - ◆ To set the interval between reminder tones, select [**Reminder Interval**] and toggle between [**1min**], [**2min**] and [**3min**].

In addition, you can set the volume of alarm reminder tones. To set the volume of alarm reminder tones, select [**Main Menu**]→[**Alarm Setup >>**]→[**Others**] or the [**Alarm Setup**] QuickKey→[**Others**]. Then, select [**Reminder Vol**] and toggle between [**High**], [**Medium**] and [**Low**].

6.5 Understanding the Alarm Setup Menu

Select the [**Alarm Setup**] QuickKey or [**Main Menu**]→[**Alarm Setup >>**] to enter the [**Alarm Setup**], where you can:

- Set alarm properties for all parameters.
- Change ST alarm settings.
- Change arrhythmia alarm settings.
- Set the threshold for some arrhythmia alarms.
- Change other settings.

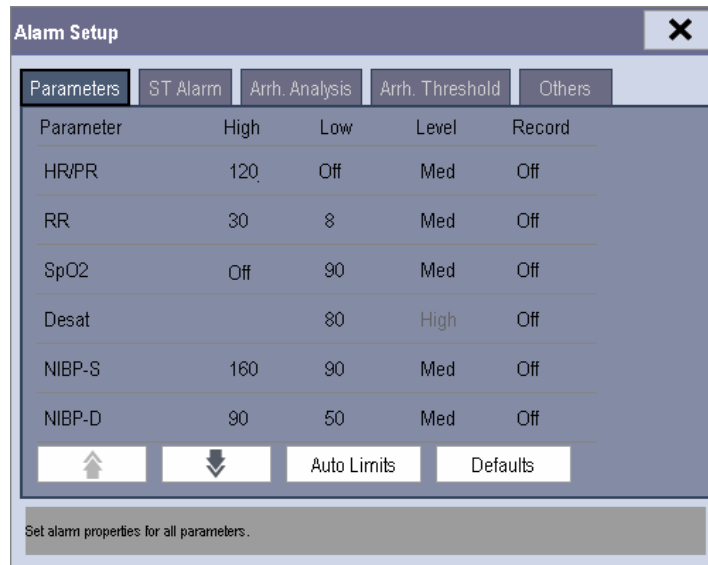

Please refer to the *ECG* section for how to change ST alarm settings, how to change arrhythmia alarm settings and how to set the threshold for some arrhythmia alarms.

6.5.1 Setting Alarm Properties for All Parameters

In the main menu, select [**Alarm Setup >>**]→[**Parameters**]. You can review and set alarm limits, alarm level and alarm recordings for all parameters.

When a measurement alarm occurs, automatic recording of all the measurement numerics and related waveforms is possible when the measurement’s high/low alarm limit and [**Record**] are set on.

WARNING

- **Make sure that the alarm limits settings are appropriate for your patient before monitoring.**
- **Setting alarm limits to extreme values may cause the alarm system to become ineffective. For example, High oxygen levels may predispose a premature infant to retrolental fibroplasia. If this is a consideration do NOT set the high alarm limit to 100%, which is equivalent to switching the alarm off.**

6.5.2 Adjusting Alarm Limits Automatically

The monitor can automatically adjust alarm limits according to the measured vital signs, using the auto limits function. When auto limits are selected, the monitor calculates safe auto limits based on the latest measured values.

To get accurate auto alarm limits, you need to collect a set of measured vital signs as a

baseline. Then, in the main menu, select [Alarm Setup >>]→[Parameters]→[Auto Limits] →[Ok]. The monitor will create new alarm limits based on the measured values.

Before applying these automatically created alarm limits, confirm if they are appropriate for your patient in the mass alarm setup menu. If not, you can adjust them manually. These alarm limits will remain unchanged until you select auto limits again or adjust them manually.

The monitor calculates the auto limits based on the following rules.

Module	Parameter	Low alarm limit		High alarm limit		Auto alarm limits range
		Adult/ pediatric	Neonate	Adult/ pediatric	Neonate	
ECG	HR/PR	HR×0.8 or 40bpm (whichever is greater)	HR-30 or 90bpm (whichever is greater)	HR×1.25 or 240bpm (whichever is smaller)	HR+40 or 200bpm (whichever is smaller)	Adult/pediatric: 35 to 240 Neonate: 55 to 225
Resp	RR	RR×0.5 or 6/min (whichever is greater)	RR-10 or 30/min (whichever is greater)	RR×1.5 or 30/min (whichever is smaller)	RR+25 or 85/min (whichever is smaller)	Adult/pediatric: 6 to 55 Neonate: 10 to 90
SpO2	SpO2	Same as the default alarm limit	Same as the default alarm limit	Same as the default alarm limit	Same as the default alarm limit	Same as the measurement range
NIBP	NIBP-S	SYS×0.68+10mmHg	SYS-15 or 45mmHg (whichever is greater)	SYS×0.86+38mmHg	SYS+15 or 105mmHg (whichever is smaller)	Adult: 45 to 270 Pediatric: 45 to 185 Neonate: 35 to 115
	NIBP-D	Dia×0.68+6mmHg	Dia-15 or 20mmHg (whichever is greater)	Dia×0.86+32mmHg	Dia+15 or 80mmHg (whichever is smaller)	Adult: 25 to 225 Pediatric: 25 to 150 Neonate: 20 to 90
	NIBP-M	Mean×0.68+8mmHg	Mean-15 or 35mmHg (whichever is greater)	Mean×0.86+35mmHg	Mean+15 or 95mmHg (whichever is smaller)	Adult: 30 to 245 Pediatric: 30 to 180 Neonate: 25 to 105
Temp	T1	T1-0.5℃	T1-0.5℃	T1+0.5℃	T1+0.5℃	1 to 49℃
	T2	T2-0.5℃	T2-0.5℃	T2+0.5℃	T2+0.5℃	1 to 49℃

Module	Parameter	Low alarm limit		High alarm limit		Auto alarm limits range
		Adult/ pediatric	Neonate	Adult/ pediatric	Neonate	
	TD	Same as the default alarm limit	Same as the default alarm limit	Same as the default alarm limit	Same as the default alarm limit	Same as the measurement range
IBP: ART/ Ao/ UAP/ BAP/ FAP/ LV/ P1-P4 (Arterial pressure)	IBP-S	$\text{SYS} \times 0.68 + 10\text{mmHg}$	$\text{SYS} - 15$ or 45mmHg (whichever is greater)	$\text{SYS} \times 0.86 + 38\text{mmHg}$	$\text{SYS} + 15$ or 105mmHg (whichever is smaller)	Adult: 45 to 270 Pediatric: 45 to 185 Neonate: 35 to 115
	IBP-D	$\text{Dia} \times 0.68 + 6\text{mmHg}$	$\text{Dia} - 15$ or 20mmHg (whichever is greater)	$\text{Dia} \times 0.86 + 32\text{mmHg}$	$\text{Dia} + 15$ or 80mmHg (whichever is smaller)	Adult: 25 to 225 Pediatric: 25 to 150 Neonate: 20 to 90
	IBP-M	$\text{Mean} \times 0.68 + 8\text{mmHg}$	$\text{Mean} - 15$ or 35mmHg (whichever is greater)	$\text{Mean} \times 0.86 + 35\text{mmHg}$	$\text{Mean} + 15$ or 95mmHg (whichever is smaller)	Adult: 30 to 245 Pediatric: 30 to 180 Neonate: 25 to 105

Module	Parameter	Low alarm limit		High alarm limit		Auto alarm limits range
		Adult/ pediatric	Neonate	Adult/ pediatric	Neonate	
PA	IBP-S	SYS×0.75	SYS×0.75	SYS×1.25	SYS×1.25	3 to 120mmHg
	IBP-D	Dia×0.75	Dia×0.75	Dia×1.25	Dia×1.25	
	IBP-M	Mean×0.75	Mean×0.75	Mean×1.25	Mean×1.25	
IBP: CVP/ ICP/ LAP/ RAP/ UVP/ P1-P4 (Venous pressure)	IBP-M	Mean×0.75	Mean×0.75	Mean×1.25	Mean×1.25	3 to 40mmHg
CO2	EtCO2	0-32mmHg: remains the same	0-32mmHg: remains the same	0-32mmHg: remains the same	0-32mmHg: remains the same	Same as the measurement range
		32-35mmHg: 29mmHg	32-35mmHg: 29mmHg	32-35mmHg: 41mmHg	32-35mmHg: 41mmHg	
		35-45mmHg: etCO2-6mmHg	35-45mmHg: etCO2-6mmHg	35-45mmHg: etCO2+6mmHg	35-45mmHg: etCO2+6mmHg	
		45-48mmHg: 39mmHg	45-48mmHg: 39mmHg	45-48mmHg: 51mmHg	45-48mmHg: 51mmHg	
	>48mmHg: remains the same	>48mmHg: remains the same	>48mmHg: remains the same	>48mmHg: remains the same		
FiCO2	N/A	N/A	Same as the default alarm limit	Same as the default alarm limit	Same as the measurement range	
awRR	awRR×0.5 or 6/min (whichever is greater)	awRR-10 or 30/min (whichever is greater)	awRR×1.5 or 30/min (whichever is smaller)	awRR+25 or 85/min (whichever is smaller)	Adult/pediatric: 6 to 55 Neonate: 10 to 90	

Module	Parameter	Low alarm limit		High alarm limit		Auto alarm limits range	
		Adult/ pediatric	Neonate	Adult/ pediatric	Neonate		
AG	EtCO2 (AG)	Same as CO2 module					Adult/pediatric: 6 to 55 Neonate: 10 to 90
	FiCO2 (AG)						
	awRR	awRR × 0.5 or 6/min (whichever is greater)	awRR - 10 or 30/min (whichever is greater)	awRR × 1.5 or 30/min (whichever is smaller)	awRR + 25 or 85/min (whichever is smaller)		
	FiAA/ EtAA	Same as the default alarm limit	Same as the default alarm limit	Same as the default alarm limit	Same as the default alarm limit		
	FiO2/ EtCO2	Same as the default alarm limit	Same as the default alarm limit	Same as the default alarm limit	Same as the default alarm limit		
	FiN2O/ EtN2O	Same as the default alarm limit	Same as the default alarm limit	Same as the default alarm limit	Same as the default alarm limit		
C.O.	BT	Adult: BT - 1 °C	N/A	Adult: BT + 1 °C	N/A	Same as the measurement range	
ICG	C.I.	N/A					
	TFC						
RM	RR(RM)	awRR × 0.5 or 6/min (whichever is greater)	N/A	awRR × 1.5 or 30/min (whichever is smaller)	N/A	Adult/pediatric: 6 to 55 Neonate: 10 to 90	
	PEEP	PEEP - 5	N/A	PEEP + 5	N/A	Same as the measurement range	
	PIP	PIP - 10	N/A	PIP + 10	N/A	Same as the measurement range	
	MVe	MVe - 2	N/A	MVe + 2	N/A	Same as the measurement range	
BIS	BIS	N/A					

Module	Parameter	Low alarm limit		High alarm limit		Auto alarm limits range	
		Adult/ pediatric	Neonate	Adult/ pediatric	Neonate		
CCO	CCO/ CCI, EDV/ EDVI, SVR/ SVRI, SV/SVI, RVEF	N/A					
SvO2	SvO2	SvO2 - 5	N/A	SvO2 + 5	N/A	Same as the measurement range	
	ScvO2	ScvO2 - 5	N/A	ScvO2 + 5	N/A	Same as the measurement range	

6.5.3 Setting Alarm Delay Time

You can set the alarm delay time for over-limit alarms of continuously measured parameters. If the alarm-triggered condition disappears within the delay time, the patient monitor will not give the alarm. You can set the [Alarm Delay], [Apnea Delay] and [ST Alarm Delay] in the [Others] window of [Alarm Setup] menu.

6.5.4 Entering CPB Mode

When performing Cardiopulmonary bypass (CPB), you can set the patient monitor to enter CPB mode in order to reduce unnecessary alarms. In the CPB mode, all the physiological alarms are switched off except for the following alarms.

- BIS-related alarms
- FiCO2/EtCO2 too high (for CO2 module and AG module)
- FiO2/EtO2 too high or too low
- FiAA/EtAA too high (AA represents Hal, Enf, Iso, Sev, or Des)
- FiN2O/EtN2O too high

In CPB mode, [CPB Mode] is displayed in the physiological alarm area with red background color.

To enter CPB mode:

Select the [CPB Mode] Quickkey or select [Enter CPB Mode] in the [Others] window of the [Alarm Setup] menu. Then select [Ok] in the popup dialog box.

6.6 Pausing Alarms

If you want to temporarily prevent alarms from sounding, you can pause alarms by pressing the  hardkey on the monitor's front. When alarms are paused:

- No alarm lamps flash and no alarms are sounded.
- No numeric and alarm limit flash.
- No alarm messages are shown.
- The remaining pause time is displayed in the physiological alarm area.
- The  alarms paused symbol is displayed in the sound symbol area.



The patient monitor enters into the alarm paused status as soon as it is turned on. The alarm pause time is fixed to be 2 minutes.

When the alarm pause time expires, the alarm paused status is automatically cancelled and the alarm tone will sound. You can also cancel the alarm paused status by pressing the  hardkey.

You can set the alarm pause time as desired. The default alarm pause time is 2 minutes.

1. Select [**Main Menu**] \rightarrow [**Maintenance >>**] \rightarrow [**User Maintenance >>**] \rightarrow enter the required password.
2. Select [**Alarm Setup >>**] \rightarrow [**Alarm Pause Time**] and then select the appropriate setting from the popup list.

6.7 Silencing the Alarm Sound

You can silence all alarm sounds by pressing the  hardkey on the monitor's front. In that case, the alarm lamp flashing and alarm tones are cleared and  appears in the sound symbol area. After the physiological alarm is silenced, \surd appears before the alarm message and the numeric and alarm limit still flash. For the performance after the technical alarm is silenced, please refer to the *Silencing Technical Alarms* section.

The alarm silenced status will be automatically cancelled if you switch the patient monitor to other alarm statuses or when a new physiological or technical alarm occurs.

6.8 Latching Alarms

The alarm latching setting for your patient monitor defines how the alarm indicators behave when you do not acknowledge them. When alarms are set to non-latching, their alarm indications end when the alarm condition ends. If you switch alarm latching on, all visual and audible alarm indications last until you acknowledge the alarms, except that the measurement

numeric and violated alarm limit stop flashing as soon as the initial alarm condition goes away.



To set alarms to latching or non-latching:

1. Select [**Main Menu**]→[**Maintenance >>**]→[**User Maintenance >>**]→enter the required password.
2. Select [**Alarm Setup >>**].
3. Select [**Latching Alarms**] and toggle between [**Yes**] and [**No**].

6.9 Silencing Technical Alarms

For some technical alarms, their alarm lamp flashing and alarm tones are cleared and the alarm messages change to prompt messages after the  hardkey is pressed. After the patient monitor restores the normal status, the patient monitor can give alarm indications correctly when these alarms are triggered again.

For some technical alarms, all their alarm indications are cleared after the  hardkey is pressed. After the patient monitor restores the normal status, the patient monitor can give alarm indications correctly when these alarms are triggered again.

For some other technical alarms, their alarm lamp flashing and alarm tones are cleared and  appears before the alarm message after the  hardkey is pressed. After the patient monitor restores the normal status, the patient monitor can give alarm indications correctly when these alarms are triggered again.

6.10 Testing Alarms

When the monitor starts up, a selftest is performed. In the meantime, the start-up screens are displayed, and the technical alarm lamp and alarm lamp are lit in blue and yellow respectively. Then, the alarm lamp turns into red, and turns off together with the technical alarm lamp after the system gives a beep. This indicates that the visible and audible alarm indicators are functioning correctly.

For further testing of individual measurement alarms, perform the measurement on yourself (for example SpO₂ or CO₂) or use a simulator. Adjust alarm limits and check that appropriate alarm behaviour is observed.

6.11 When an Alarm Occurs

When an alarm occurs, observe the following steps and take proper actions:

1. Check the patient's condition.
2. Confirm the alarming parameter or alarm category.
3. Identify the source of the alarm.
4. Take proper action to eliminate the alarm condition.
5. Make sure the alarm condition is corrected.

For troubleshooting specific alarms, see appendix *Alarm Messages*.

6.12 Using Care Group Alarms

6.12.1 Care Group Auto Alarms

When auto alarm is set on for viewing other patient and a Care Group is set up on your monitor, a flashing symbol will appear beside the QuickKeys area if any monitor in your Care Group, which is not currently viewed by your monitor, is alarming. The alarm symbol is shown as below.



The department and bed label of the alarming monitor appear on the symbol. You can enter the view other patient window by pressing this symbol.

To switch auto alarm on or off for viewing other patient:

1. In the main menu, select [**Screen Setup >>**]→[**Screen Layout >>**]→[**View Others Screen**]→**X**.
2. In the view other patient window, select the care group setup button. Then, select [**Auto Alarm**] and toggle between [**On**] and [**Off**].

6.12.2 Silencing Care Group Alarms

You can silence the alarm sound of the currently viewed bed in the view other patient window. This function can be set in the [**Alarm Setup**] menu from the [**User Maintenance**] menu only.

When the alarm silence function for other patients is active and the currently viewed bed is in normal alarm status or alarm sound off status, press the [**Silence**] button in the view other patient window. The currently viewed bed will then enter into the alarm silenced status.

Note that this button is disabled when the currently viewed bed is in alarms off or paused status.

 **WARNING**

-
- **Silencing care group alarms may cause a potential hazard. Please act with caution.**
-

FOR YOUR NOTES

7 Monitoring ECG

7.1 Introduction

The electrocardiogram (ECG) measures the electrical activity of the heart and displays it on the patient monitor as a waveform and a numeric. This patient monitor measures ECG using the MPM module. ECG monitoring provides two algorithms:

1. Basic algorithm

The Basic algorithm enables 3- and 5-lead ECG monitoring.

2. Mortara algorithm

The Mortara algorithm enables 3-, 5- and 12-lead ECG monitoring, ST-segment analysis and arrhythmia analysis.

You can select either algorithm as required.

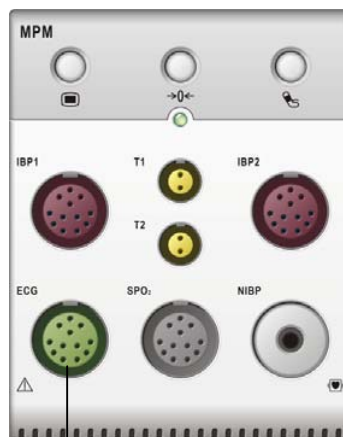

Connector for ECG cable

The MPM module incorporating Mortara algorithm is labelled with the logo of Mortara.

7.2 Safety



WARNING

- Use only ECG electrodes and cables specified by Mindray.
 - When connecting electrodes and/or patient cables, make sure that the connectors never come into contact with other conductive parts, or with earth. In particular, make sure that all of the ECG electrodes are attached to the patient, to prevent them from contacting conductive parts or earth.
 - Periodically inspect the electrode application site to ensure skin quality. If the skin quality changes, replace the electrodes or change the application site.
 - Use defibrillator-proof ECG cables during defibrillation.
 - Do not touch the patient, or table, or instruments during defibrillation.
 - After defibrillation, the screen display recovers within 10 seconds if the correct electrodes are used and applied in accordance with the manufacturer's instructions for use.
 - Interference from a non-grounded instrument near the patient and electrosurgery interference can cause problems with the waveform.
-

7.3 Preparing to Monitor ECG

7.3.1 Preparing the Patient and Placing the Electrodes

1. Prepare the patient's skin. Proper skin preparation is necessary for good signal quality at the electrode, as the skin is a poor conductor of electricity. To properly prepare the skin, choose flat areas and then follow this procedure:
 - ◆ Shave hair from skin at chosen sites.
 - ◆ Gently rub skin surface at sites to remove dead skin cells.
 - ◆ Thoroughly cleanse the site with a mild soap and water solution. We do not recommend using ether or pure alcohol, because this dries the skin and increases the resistance.
 - ◆ Dry the skin completely before applying the electrodes.
2. Attach the clips or snaps to the electrodes before placing them.
3. Place the electrodes on the patient.
4. Attach the electrode cable to the patient cable and then plug the patient cable into the ECG connector on the MPM.

7.3.2 Choosing AHA or IEC Lead Placement

1. Select the ECG parameter window or waveform area to enter the [ECG Setup] menu.
2. Select [Lead Set] and then select [3-lead], [5-lead], [12-lead] or [Auto] according to the applied electrodes.
3. Select [Main Menu]→[Maintenance >>]→[User Maintenance >>]→enter the required password
4. Select [Others >>]→[ECG Standard] and then select [AHA] or [IEC] according to the standard that is applied for your hospital.

7.3.3 ECG Lead Placements

The electrode placement illustrations in this chapter adopt the AHA standard.

3-Leadwire Electrode Placement

Following is an electrode configuration when using 3 leadwires:

- RA placement: directly below the clavicle and near the right shoulder.
- LA placement: directly below the clavicle and near the left shoulder.
- LL placement: on the left lower abdomen.

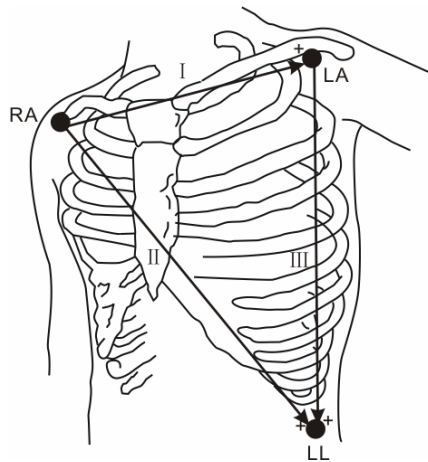

5-Leadwire Electrode Placement

Following is an electrode configuration when using 5 leadwires:

- RA placement: directly below the clavicle and near the right shoulder.
- LA placement: directly below the clavicle and near the left shoulder.
- RL placement: on the right lower abdomen.
- LL placement: on the left lower abdomen.
- V placement: on the chest.

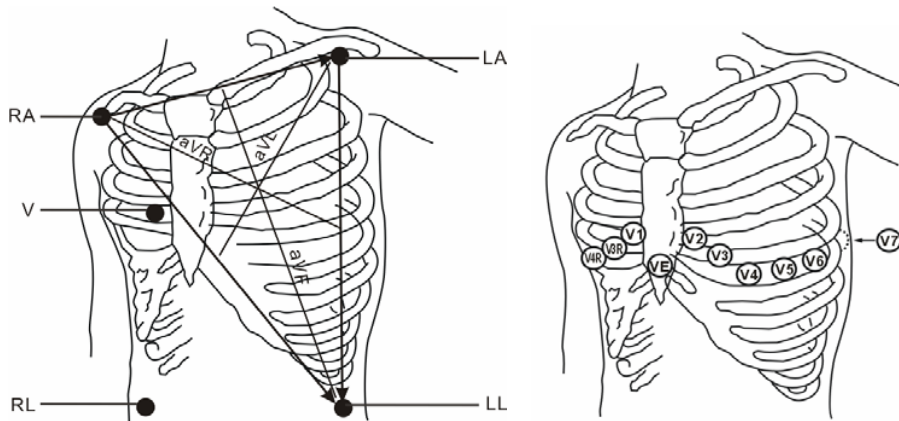

The chest (V) electrode can be placed on one of the following positions:

- V1 placement: on the fourth intercostal space at the right sternal border.
- V2 placement: on the fourth intercostal space at the left sternal border.
- V3 placement: midway between the V2 and V4 electrode positions.
- V4 placement: on the fifth intercostal space at the left midclavicular line.
- V5 placement: on the left anterior axillary line, horizontal with the V4 electrode position.
- V6 placement: on the left midaxillary line, horizontal with the V4 electrode position.
- V3R-V6R placement: on the right side of the chest in positions corresponding to those on the left.
- VE placement: over the xiphoid process.
- V7 placement: on posterior chest at the left posterior axillary line in the fifth intercostal space.
- V7R placement: on posterior chest at the right posterior axillary line in the fifth intercostal space.

12-Leadwire Electrode Placement

12-lead ECG uses 10 electrodes, which are placed on the patient's four limbs and chest. The limb electrodes should be placed on the soft skin and the chest electrodes placed according to the physician's preference.

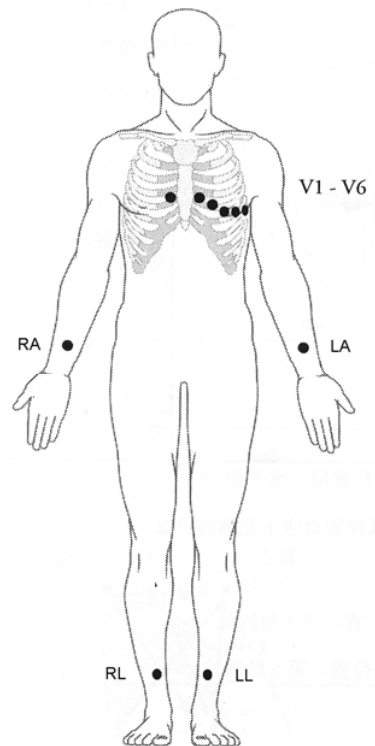



Lead Placement for Surgical Patients

The surgical site should be taken into consideration when placing electrodes on a surgical patient. e.g. for open-chest surgery, the chest electrodes can be placed on the lateral chest or back. To reduce artifacts and interference from electrosurgical units, you can place the limb electrodes close to the shoulders and lower abdomen and the chest electrodes on the left side of the mid-chest. Do not place the electrodes on the upper arm. Otherwise, the ECG waveform will be very small.

WARNING

- **When using electrosurgical units (ESU), patient leads should be placed in a position that is equal distance from the Electrosurgery electrotome and the grounding plate to avoid burns to the patient. Never entangle the ESU cable and the ECG cable together.**
 - **When using electrosurgical units (ESU), never place ECG electrodes near to the grounding plate of the ESU, as this can cause a lot of interference on the ECG signal.**
-

7.3.4 Checking Paced Status

It is important to set the paced status correctly when you start monitoring ECG. The paced symbol  is displayed when the [**Paced**] status is set to [**Yes**]. The pace pulse markers “” are shown on the ECG wave when the patient has a paced signal.

To change the paced status, you can select either:

- the patient information area, or
- [**Main Menu**]→[**Patient Setup**]→[**Patient Demographics**], or,
- the ECG parameter window or waveform area→[**Others >>**],

and then, select [**Paced**] from the popup menu and toggle between [**Yes**] and [**No**].

Warning

- **For paced patients, you must set [Paced] to [Yes]. If it is incorrectly set to [No], the patient monitor could mistake a pace pulse for a QRS and fail to alarm when the ECG signal is too weak. Do not rely entirely on rate meter alarms when monitoring patients with pacemakers. Always keep these patients under close surveillance.**
 - **For non-paced patients, you must set [Paced] to [No]. If it is incorrectly set to [Yes], the patient monitor may be unable to detect premature ventricular beats (including PVCs) and perform ST segment analysis.**
-

7.4 Understanding the ECG Display

Your display may be configured to look slightly different.

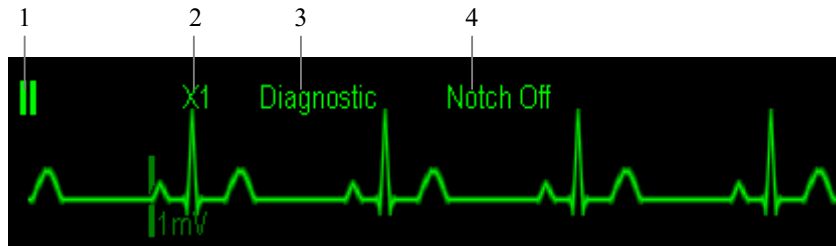

1. Lead label of the displayed wave
2. ECG gain
3. ECG filter label
4. Notch filter status

Besides, pace pulse marks “⁺” are shown above the ECG wave if the **[Paced]** has been set to **[Yes]** and a paced signal has been detected.



1. Current heart rate alarm limits
2. Current heart rate
3. Heart beat symbol

For 12-lead ECG display screen, refer to the section *12-Lead ECG Monitoring*.

7.5 Changing ECG Settings

7.5.1 Accessing ECG Menus

By selecting the ECG parameter window or waveform area, you can access the **[ECG Setup]** menu.

7.5.2 Setting Pacemaker Rate (For Mortara only)

Some pacemaker pulses can be difficult to reject. When this happens, the pulses are counted as a QRS complex and could result in an incorrect HR and failure to detect some arrhythmias. You can set **[Pacemaker Rate]** to the pacemaker's rate in the **[ECG Setup]** menu. In this way, the patient monitor can calculate HR and detect arrhythmias more accurately. When **[Paced]** is set to **[No]**, the pacemaker rate cannot be set.

7.5.3 Choosing the Alarm Source

In most cases the HR and PR numerics are identical. In order to avoid simultaneous alarms on HR and PR, the monitor uses either HR or PR as its active alarm source. To change the alarm source, select **[Alm Source]** in the **[ECG Setup]** menu and then select either:

- **[HR]**: if you want the HR to be the alarm source for HR/PR.
- **[PR]**: if you want the PR to be the alarm source for HR/PR.
- **[Auto]**: If the **[Alm Source]** is set to **[Auto]**, the patient monitor will use the heart rate from the ECG measurements as the alarm source whenever a valid heart rate is available. If the heart rate becomes unavailable, for example the ECG module is turned off or becomes disconnected, the patient monitor will automatically switch to PR as the alarm source.

7.5.4 Setting the ECG Lead Set

You can set the **[Lead Set]** from the **[ECG Setup]** menu. You can set the **[Lead Set]** as **[Auto]** if the auto lead detection function is available.

7.5.5 Choosing an ECG Display Screen

When monitoring with a 5-lead or 12-lead set, you can select the **[Screens]** Quickkey. In the **[Choose Screen]** window, choose the screen type as:

- **[Normal Screen]**: The ECG waveform area shows 2 ECG waveforms.
- **[ECG 7-Lead Full-Screen]**: The whole waveform area shows 7 ECG waveforms only.
- **[ECG 7-Lead Half-Screen]**: The upper half part of the whole waveform area displays 7 ECG waveforms.

When monitoring with a 12-lead set, you can also choose the screen type as **[ECG 12-Lead**

Full-Screen].

When the screen type is set to **[Normal Screen]** and **[Sweep Mode]** is set to **[Refresh]**, cascaded ECG waveforms can be displayed. To cascade ECG waveforms:

1. Select the **[Screens]** Quickkey→**[Screen Setup]**.
2. Select **[ECG1 Casc.]** in the second row. A cascaded waveform is displayed in two waveform positions.

7.5.6 Changing the ECG Filter Settings

The ECG filter setting defines how ECG waves are smoothed. To change the filter setting, select **[Filter]** from **[ECG Setup]** and then select the appropriate setting.

- **[Monitor]**: Use under normal measurement conditions.
- **[Diagnostic]**: Use when diagnostic quality is required. The unfiltered ECG wave is displayed so that changes such as R-wave notching or discrete elevation or depression of the ST segment are visible.
- **[Surgery]**: Use when the signal is distorted by high frequency or low frequency interference. High frequency interference usually results in large amplitude spikes making the ECG signal look irregular. Low frequency interference usually leads to wandering or rough baseline. In the operating room, the surgery filter reduces artifacts and interference from electrosurgical units. Under normal measurement conditions, selecting **[Surgery]** may suppress the QRS complexes too much and then interfere with ECG analysis.



WARNING

- **The **[Diagnostic]** filter is recommended when monitoring a patient in an environment with slight interference only.**
-

7.5.7 Switching the Notch Filter On or Off

The notch filter removes the line frequency interference. When **[Filter]** is not set to **[Diagnostic]**, the notch filter always stays on. When **[Filter]** is set to **[Diagnostic]**, you can switch the notch filter on or off as required.

1. Select the ECG parameter window or waveform area to enter its setup menu. Then select **[Others >>]**.
2. Select **[Notch Filter]** and toggle between **[On]** and **[Off]**. Switching the notch filter on is recommended when there is interference (such as spikes) with the waveform.
3. When **[Notch Filter]** is set on, select **[Main Menu]**→**[Maintenance >>]**→**[User Maintenance >>]**→enter the required password.
4. Select **[Others >>]**→**[Notch Freq.]** and then select **[50Hz]** or **[60Hz]** according to the power line frequency.

7.5.8 About the Defibrillator Synchronization

If a defibrillator is connected, a defibrillator synchronization pulse (100 ms, +5V) is outputted through the Defib. Sync Connector every time when the patient monitor detects an R-wave. The defibrillator synchronization function is always enabled.

WARNING

- **Improper use of a defibrillator may cause injury to the patient. The user should determine whether to perform defibrillation or not according to the patient's condition.**
 - **Before defibrillation, the user must ensure both defibrillator and monitor has passed the system test and can be safely used jointly.**
 - **Before defibrillation, make sure that the [Filter] is set to [Diagnostic].**
 - **After defibrillation is finished, select the filter mode as required.**
-

7.5.9 Changing ECG Wave Settings

In the [ECG Setup] menu:

- If the wave is too small or clipped, you can change its size by selecting an appropriate [Gain] setting. If you select [Auto] from [Gain], the patient monitor will automatically adjust the size of the ECG waves. In normal screen, only the selected ECG wave's size is adjusted. In other screens, all ECG waves' size is adjusted simultaneously.
- You can change the wave sweep speed by selecting [Sweep] and then selecting the appropriate setting.

7.5.10 Choosing the Heart Rate Source

For the Basic algorithm, to compute HR and to analyse and detect arrhythmia more accurately, you can choose a lead of best quality signals as the HR lead. To select a lead as the HR lead, select **[ECG1]** from the **[ECG Setup]** menu and then select the lead you want.

The selected lead should have the following characteristics:

- The QRS should be either completely above or below the baseline and it should not be biphasic.
- The QRS should be tall and narrow.
- The P-waves and T-waves should be less than 0.2mV.

For the Mortara algorithm, the system will analyze the ECG waveforms from multiple channels simultaneously so as to compute HR and to analyze and detect arrhythmia.

7.5.11 Enabling Smart Lead Off

When the smart lead off function is set on and there is a “lead off” in the lead that has an ECG waveform in filter mode and notch status, if another lead is available, this available lead automatically becomes that lead. The system will re-calculate HR and analyze and detect arrhythmia. When the “lead off” condition is corrected, the leads are automatically switched back.

To switch on/off the smart lead off function, select **[Others >>]** from the **[ECG Setup]** menu; select **[Smart Lead Off]** and toggle between **[On]** and **[Off]** from the popup menu.

7.5.12 Setting the Alarm Level for ECG Lead Off Alarms

Select **[Alarm Setup >>]** from the **[User Maintenance]** menu. You can set **[ECGLeadOff Lev.]** from the popup menu.

7.5.13 Adjusting QRS Volume

QRS sounds are produced based on the alarm source. To adjust the QRS volume, select **[Others >>]** from the **[ECG Setup]** menu; select **[QRS Volume]** from the popup menu and select the appropriate setting. When valid SpO2 measured value is available, the system adjusts the pitch tone of QRS sound based on the SpO2 value.

7.6 About ST Monitoring

- ST segment analysis is not intended for neonatal patients. The default setting is off.
- ST segment analysis calculates ST segment elevations and depressions for individual leads and then displays them as numerics in the ST1 and ST2 areas.
- A positive value indicates ST segment elevation; a negative value indicates ST segment depression.
- Measurement unit of the ST segment: mV or mm. You can set the unit in the [Unit Setup] menu from the [User Maintenance] menu.
- Measurement range of the ST segment: -2.0 mV to +2.0 mV.



WARNING

- **The ST algorithm has been tested for accuracy of the ST segment data. The significance of the ST segment changes need to be determined by a clinician.**
-

7.6.1 Switching ST On and Off

To switch ST monitoring on or off:

1. In the [ECG Setup] menu, select [ST Analysis >>].
2. Select [ST Analysis] to toggle between [On] and [Off].

Reliable ST monitoring can hardly be ensured if:

- You are unable to get a lead that is not noisy.
- Arrhythmias such as atrial fib/flutter cause irregular baseline.
- The patient is continuously ventricularly paced.
- The patient has left bundle branch block.

In these cases, you may consider switching ST monitoring off.

7.6.2 Changing ST Filter Settings

ST-segment analysis can be carried out only when the filter mode is set to [Diagnostic].

When ST-segment analysis is switched on, [Filter] will automatically switch to [Diagnostic] if it is not in the diagnostic mode. However, if you switch [Filter] to [Monitor] or [Surgery], ST-segment analysis will turn off automatically. In case that you change [Monitor] or [Surgery] to [Diagnostic] and ST-segment analysis keeps off, you can turn it on manually.

7.6.3 Understanding the ST Display

This example shows ST numerics with 5-lead ECG. Your monitor screen may look slightly different from the illustration.



Select the ST parameter window and you can enter the [ST Analysis] menu.

7.6.4 Changing the ST Alarm Limits

High and low ST alarm limits can be set individually for each ECG lead. Alarm limits can also be set separately for single-lead and multi-lead ST monitoring. You can select [ST Alarm Setup >>] from [ST Analysis] menu and then change ST alarm settings for each lead.

7.6.5 Setting the ST Alarm Delay Time

You can set the ST alarm delay time from the [Others] window of [Alarm Setup] menu.

7.6.6 Adjusting ST Measurement Points

As shown in the figure below, the ST measured for each beat complex is the vertical difference between two measurement points with the R-wave peak as the baseline for the measurement.

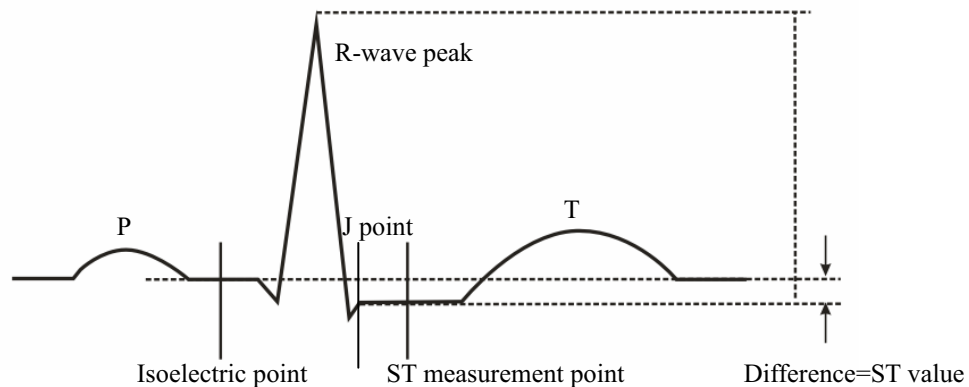

The ISO and ST points need to be adjusted when you start monitoring and if the patient's heart rate or ECG morphology changes significantly. Exceptional QRS complexes are not considered for ST-segment analysis.



WARNING

- **Always make sure that the positions of ST measurement points are appropriate for your patient.**
-

To adjust the ST measurement points:

1. In the [ST Analysis] menu, select [Adjust ST Points >>]. In the [Adjust ST Points] window, three vertical lines represent the ISO, J and ST point positions respectively.
2. Select [View Leads] and use the Knob to select an ECG lead with obvious J point and R wave.
3. Select [ISO], [J] or [ST] and then use the Knob to adjust the position of each point.
 - ◆ The ISO-point (isoelectric) position is given relative to the R-wave peak. Position the ISO-point in the middle of the flattest part of the baseline (between the P and Q waves of in front of the P wave).
 - ◆ The J-point position is given relative to the R-wave peak and helps locating the ST-point. Position the J-point at the end of the QRS complex and the beginning of the ST segment.
 - ◆ The ST-point is positioned a fixed distance from the J-point. Move the J-point to position the ST-point at the midpoint of the ST segment. Position the ST-point relative to the J-point at either J+60 or J+80.

7.7 About Arrhythmia Monitoring

Arrhythmia analysis provides information about your patient's condition, including heart rate, PVC rate, rhythm and ectopics.



WARNING

- **Arrhythmia analysis program is intended to detect ventricular arrhythmias. It is not designed to detect atrial or supraventricular arrhythmias. It may incorrectly identify the presence or absence of an arrhythmia. Therefore, a physician must analyze the arrhythmia information with other clinical findings.**
 - **The arrhythmia detection is not intended for neonatal patients.**
-

7.7.1 Understanding the Arrhythmia Events

Arrhythmia Message	Description	Category
Asystole	No QRS complex detected within the set time threshold (in absence of ventricular fibrillation or chaotic signals).	Lethal arrhythmia
Vfib	Ventricular fibrillation occurs and persists for 6 seconds.	
Vtac	Ventricular HR is greater or equal to the preset threshold and the number of consecutive PVCs is greater than the preset threshold.	
PVCs	PVCs/min exceeds high limit	Nonlethal arrhythmia
PNP	No pace pulse detected for (60*1000/pace rate +90) milliseconds following a QRS complex or a pacer pulse (for paced patients only).	
PNC	No QRS complex detected for 300 milliseconds following a pace pulse (for paced patients only).	
Multif. PVC	More than 2 PVCs of different forms occur in the predefined search window (3-31).	
Couplet	Paired PVCs are detected.	
VT > 2	Ventricular HR is greater than or equal to the preset threshold and the number of PVCs is greater than or equal to 3 but less than the preset threshold.	
Vent. Rhythm	Ventricular HR is less than the preset threshold and the number of PVCs is greater than or equal to 3.	
Bigeminy	A dominant rhythm of N, V,N, V, N, V.	
Trigeminy	A dominant rhythm of N, N, V,N, N, V, N, N, V.	
R on T	R on T is detected.	
Irr. Rhythm	Consistently irregular rhythm	
Missed Beats	No beat detected for 1.75x average R-R interval for HR <120, or No beat for 1 second with HR >120 (for non-paced patients only), or No beat detected for more than the set pause threshold.	
Brady	The HR is less than the set bradycardia low limit.	
Tachy	The HR is greater than the set tachycardia high limit.	

7.7.2 Changing Arrhythmia Alarm Settings

To change arrhythmia alarm settings, select the ECG parameter area or waveform area and then select [**Arrh. Analysis >>**]. In the pop-up menu, you can also switch on lethal arrhythmia analysis alarms only or switch on/off all arrhythmia analysis alarms. In the [**Alarm Setup**] menu from the [**User Maintenance**] menu, you can enable/disable turning off lethal arrhythmia analysis alarms.

WARNING

- **If you switch off all arrhythmia analysis alarms, the monitor cannot give any arrhythmia analysis alarm. Always keep the patient under close surveillance.**
-

7.7.3 Changing Arrhythmia Threshold Settings

To change arrhythmia threshold settings, select the ECG parameter window or waveform area→[**Arrh. Analysis >>**]→[**Arrh. Threshold**]. In case an arrhythmia violates its threshold, an alarm will be triggered.

Arrh. event	Range	Default	Step	Unit
PVCs High	1 to 10	10	1	/min
Asys. Delay	2 to 10	5	1	s
Vtac Rate	100 to 200	130	5	bpm
Vtac PVC	3 to 12	6	1	beats
Multif. PVC	3 to 31	15	1	beats
Tachy High	Adult: 100 to 300 Pediatric: 160 to 300	Adult: 100 Pediatric: 160	5	bpm
Brady Low	Adult: 15 to 60 Pediatric: 15 to 80	Adult: 60 Pediatric: 80	5	bpm

7.7.4 Reviewing Arrhythmia Events

Please refer to the *Review* chapter.

7.7.5 Initiating an ECG Relearning Manually

During ECG monitoring, you may need to initiate an ECG relearning when the patient's ECG template changes dramatically. A change in the ECG template could result in:

- incorrect arrhythmia alarms
- loss of ST measurement, and/or
- inaccurate heart rate

ECG relearning allows the monitor to learn the new ECG template so as to correct arrhythmia alarms and HR value, and restore ST measurements. To initiate relearning manually, select the ECG parameter window or waveform area→[**Relearn**]. When the patient monitor is learning, the message [**ECG Learning**] is displayed in the technical alarm area.

CAUTION

- **Take care to initiate ECG relearning only during periods of normal rhythm and when the ECG signal is relatively noise-free. If ECG learning takes place during ventricular rhythm, the ectopics may be incorrectly learned as the normal QRS complex. This may result in missed detection of subsequent events of V-Tach and V-Fib.**

7.7.6 Automatic ECG Relearning

ECG relearning is initiated automatically whenever:

- The ECG lead or lead label is changed
- The ECG lead is re-connected
- A new patient is admitted
- After the calibration is completed, select [**Stop Calibrating ECG**]
- A switch happens between the options of screen type during 5/12-lead ECG monitoring.

7.8 12-Lead ECG Monitoring

7.8.1 Entering the 12-lead ECG Monitoring Screen

1. Refer to the section **7.3.3 ECG Lead Placements** for placing the electrodes.
2. In the [ECG Setup] menu, select [Lead Set]→[12-Lead]. Select [Screens] Quickkey→[ECG 12-Lead Full-Screen].

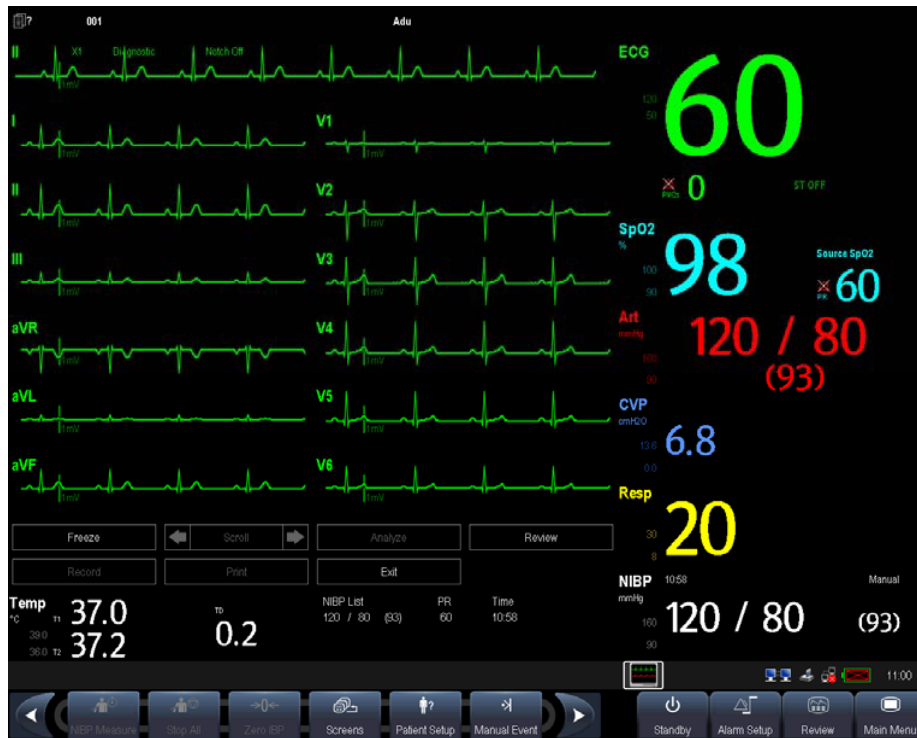

There are totally 12 ECG waves and 1 rhythm wave displayed on the screen. The rhythm lead is the HR-derived lead before entering the 12-lead ECG monitoring screen. The ST numerics are displayed in three groups:

- ST Ant (anterior): V1, V2, V3, V4
- ST Inf (inferior): II, III, aVF, (aVR)
- ST Lat (lateral): I, aVL, V5, V6

Although aVR is displayed in the ST Inf group, it is not an inferior lead.

Additionally, the 12-lead ECG monitoring has the following features:

- The [Filter] mode is fixed to [Diagnostic] and cannot be changed.
- In the adult mode, the  hardkey on the monitor's front is disabled.

8 Monitoring Respiration (Resp)

8.1 Introduction

Impedance respiration is measured across the thorax. When the patient is breathing or ventilated, the volume of air changes in the lungs, resulting in impedance changes between the electrodes. Respiration rate (RR) is calculated from these impedance changes, and a respiration waveform appears on the patient monitor screen.

8.2 Safety Information

Warning

- **When monitoring the patient's respiration, do not use ESU-proof ECG cables.**
 - **If you do not set the detection level for the respiration correctly in manual detection mode, it may not be possible for the monitor to detect apnea. If you set the detection level too low, the monitor is more likely to detect cardiac activity, and to falsely interpret cardiac activity as respiratory activity in the case of apnea.**
 - **The respiration measurement does not recognize the cause of apneas. It only indicates an alarm if no breath is detected when a pre-adjusted time has elapsed since the last detected breath. Therefore, it cannot be used for diagnostic purpose.**
 - **If operating under conditions according to the EMC Standard EN 60601-1-2 (Radiated Immunity 3V/m), field strengths above 1V/m may cause erroneous measurements at various frequencies. Therefore it is recommended to avoid the use of electrically radiating equipment in close proximity to the respiration measurement unit.**
-

8.3 Understanding the Resp Display

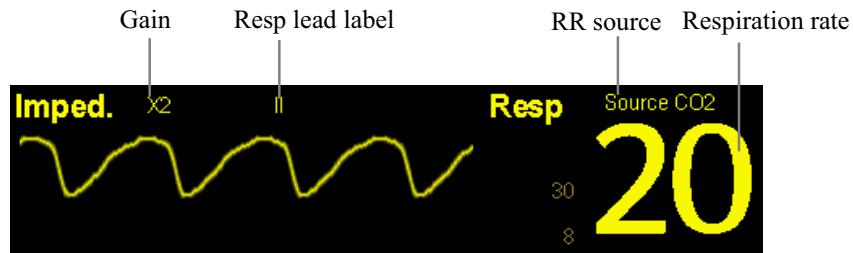

By selecting the waveform area or parameter area, you can enter the [Resp Waveform] menu.
By selecting the Resp parameter window, you can enter the [Resp Setup] menu.

NOTE

- **Respiration monitoring is not for use on the patients who are very active, as this will cause false alarms.**

8.4 Placing Resp Electrodes

As the skin is a poor conductor of electricity, preparing the skin is necessary for a good Respiration signal. You can refer to the ECG section for how to prepare the skin.

As the Respiration measurement adopts the standard ECG electrode placement, you can use different ECG cables (3-lead, 5-lead or 12-lead). Since the respiration signal is measured between two ECG electrodes, if a standard ECG electrode placement is applied, the two electrodes should be RA and LA of ECG Lead I, or RA and LL of ECG Lead II.

NOTE

- **To optimize the respiration waveform, place the RA and LA electrodes horizontally when monitoring respiration with ECG Lead I; place the RA and LL electrodes diagonally when monitoring respiration with ECG Lead II.**

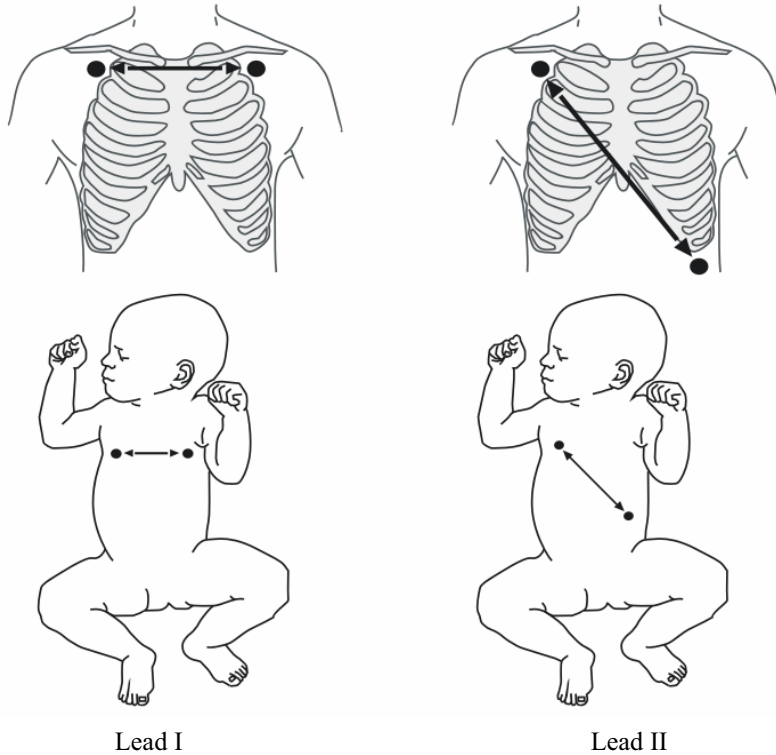

8.4.1 Optimizing Lead Placement for Resp

If you want to measure Resp and you are already measuring ECG, you may need to optimize the placement of the two electrodes between which Resp will be measured. Repositioning ECG electrodes from standard positions results in changes in the ECG waveform and may influence ST and arrhythmia interpretation.

8.4.2 Cardiac Overlay

Cardiac activity that affects the Resp waveform is called cardiac overlay. It happens when the Resp electrodes pick up impedance changes caused by the rhythmic blood flow. Correct electrodes placement can help to reduce cardiac overlay: avoid the liver area and the ventricles of the heart in the line between the respiratory electrodes. This is particularly important for neonates.

8.4.3 Abdominal Breathing

Some patients with restricted movement breathe mainly abdominally. In these cases, you may need to place the left leg electrode on the left abdomen at the point of maximum abdominal expansion to optimise the respiratory wave.

8.4.4 Lateral Chest Expansion

In clinical applications, some patients (especially neonates) expand their chests laterally, causing a negative intrathoracic pressure. In these cases, it is better to place the two respiration electrodes in the right midaxillary and the left lateral chest areas at the patient's maximum point of the breathing movement to optimise the respiratory waveform.

8.5 Choosing the Respiration Lead

In the [Resp Setup] menu, select [Resp Lead] and toggle between [I] and [II].

8.6 Changing the Apnea Alarm Delay

The apnea alarm is a high-level alarm used to detect apneas. You can set the apnea alarm delay time after which the patient monitor alarms if the patient stops breathing. In the [Resp Setup] menu, select [Apnea Delay] and then select the appropriate setting. The [Apnea Delay] of Resp, CO2, AG, and RM module keeps consistent with each other.

8.7 Changing Resp Detection Mode

In the [Resp Setup] menu, select [Detection Mode] and toggle between [Auto] and [Manual].

- In auto detection mode, the patient monitor adjusts the detection level automatically, depending on the wave height and the presence of cardiac artifact. Note that in auto detection mode, the detection level (a dotted line) is not displayed on the waveform.

Use auto detection mode for situations where:

- ◆ The respiration rate is not close to the heart rate.
- ◆ Breathing is spontaneous, with or without continuous positive airway pressure (CPAP).
- ◆ Patients are ventilated, except patients with intermittent mandatory ventilation (IMV).
- In manual detection mode, you adjust the dotted detection level line to the desired level by selecting [Upper Line] or [Lower Line] and then selecting ▲ or ▼ beside them. Once set, the detection level will not adapt automatically to different respiration depths. It is important to remember that if the depth of breathing changes, you may need to change the detection level.

Use manual detection mode for situations where:

- ◆ The respiration rate and the heart rate are close.
- ◆ Patients have intermittent mandatory ventilation.
- ◆ Respiration is weak. Try repositioning the electrodes to improve the signal.

In Auto Detection Mode, if you are monitoring Resp and ECG is switched off, the monitor cannot compare the ECG and Resp rates to detect cardiac overlay. The respiration detection level is automatically set higher to prevent the detection of cardiac overlay as respiration.

In Manual Detection Mode, cardiac overlay can in certain situations trigger the respiration counter. This may lead to a false indication of a high respiration or an undetected apnea condition. If you suspect that cardiac overlay is being registered as breathing activity, raise the detection level above the zone of cardiac overlay. If the Resp wave is so small that raising the detection level is not possible, you may need to optimize the electrode placement as described in the section "Lateral Chest Expansion".

8.8 Changing Resp Wave Settings

WARNING

- **When monitoring in manual detection mode, make sure to check the respiration detection level after you have increased or decreased the size of the respiration wave.**
-

In the [**Resp Setup**] menu, you can:

- Select [**Gain**] and then select an appropriate setting. The bigger the gain is, the larger the wave amplitude is.
- Select [**Sweep**] and then select an appropriate setting. The faster the wave sweeps, the wider the wave is.

8.9 Setting RR Source

To set RR source:

1. Enter the [**Resp Setup**] menu.
2. Select [**RR Source**] and then select a source or [**Auto**] from the dropdown list.

The dropdown list displays the currently available RR source. When you select [**Auto**], the system will automatically select the RR source according to the priority. When the current RR source does not have valid measurement, the system will automatically switch the [**RR**

Source] to **[Auto]**. RR source switches back to impedance respiration if you press the  silence hardkey on the monitor's front during an apnea alarm.

The priority of RR source is (from high to low): CO2 measurement, RM measurement and impedance respiration measurement.

The **[RR Source]** settings of Resp, CO2, AG and RM module are linked.
The RR source options and description are shown in the table below.

Option	Description
Auto	RR source is automatically selected according to the priority.
CO2	RR source is from CO2 measurement.
RM	RR source is from RM measurement.
ECG	RR source is from impedance respiration measurement.

8.10 Setting alarm properties

Select **[Alarm Setup >>]** from the **[Resp Setup]** menu. In the popup menu, you can set alarm properties for this parameter.

8.11 Switching Resp Measurement On/Off

To switch Resp measurement on, select **[Resp Measure. ON]** from the **[Resp Setup]** menu.
To switch Resp measurement off, select **[Resp Measure. OFF]** from the **[Resp Setup]** menu and then select **[Yes]** from the popup dialog box. Then, a line is displayed in the waveform area and no numeric but **[Measurement OFF]** message is displayed in the parameter area.

9 Monitoring PR

9.1 Introduction

The pulse numeric counts the arterial pulsations that result from the mechanical activity of the heart. You can display a pulse from any measured SpO₂ or any arterial pressure (see the IBP section). The displayed pulse numeric is color-coded to match its source.

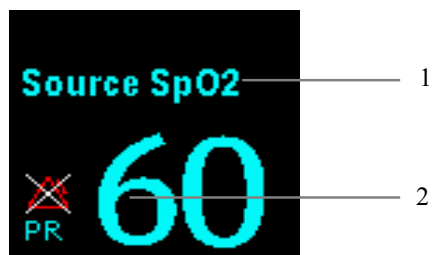

1. PR Source
2. PR: detected beats per minute.

9.2 Setting the PR Source

The current pulse source is displayed in the PR parameter area. The pulse rate chosen as pulse source:

- is monitored as system pulse and generates alarms when you select PR as the active alarm source;
- is stored in the monitor's database and reviewed in the graphic/tabular trends ; in trend graphs, as the PR curve is in the same color with the PR source , it is unlikely to distinguish the PR source ;
- is sent via the network to the central monitoring system, if available.

To set which pulse rate as PR source:

1. Enter the [**SpO2 Setup**] menu.
2. Select [**PR Source**] and then select a label or [**Auto**] from the popup menu.

The popup menu displays the currently available PR sources from top to bottom by priority. When you select [**Auto**], the system will automatically select the first option as the PR source from the popup menu. When the current PR source is unavailable, the system will automatically switch [**PR Source**] to [**Auto**]. When you select [**IBP**], the system will automatically select the first pressure label as the PR source from the popup menu.

9.3 Selecting the Active Alarm Source

In most cases the HR and pulse numerics are identical. In order to avoid simultaneous alarms on HR and Pulse, the monitor uses either HR or Pulse as its active alarm source. To change the alarm source, select [**Alm Source**] in the [**ECG Setup**] or [**SpO2 Setup**] menu and then select either:

- [**HR**]: The monitor will use the HR as the alarm source for HR/pulse.
- [**PR**]: The monitor will use the PR as the alarm source for HR/pulse.
- [**Auto**]: If the [**Alm Source**] is set to [**Auto**], the monitor will use the heart rate from the ECG measurement as the alarm source whenever the ECG measurement is switched on and a valid heart rate is available. If the heart rate becomes unavailable, for example if leads becomes disconnected, and a pulse source is switch on and available, the monitor will automatically switch to Pulse as the alarm source. When the Leads Off condition is corrected, the monitor will automatically switch back to the heart rate as the alarm source.

9.4 QRS Tone

When PR is used as the alarm source, the PR source will be used as a source for the QRS tone. You can change the QRS volume by adjusting [**Beat Vol**] in the [**SpO2 Setup**] menu. When a valid SpO₂ value exists, the system will adjust the pitch tone of QRS volume according to the SpO₂ value.

FOR YOUR NOTES

10 Monitoring SpO₂

10.1 Introduction

SpO₂ monitoring is a non-invasive technique used to measure the amount of oxygenated haemoglobin and pulse rate by measuring the absorption of selected wavelengths of light. The light generated in the probe passes through the tissue and is converted into electrical signals by the photodetector in the probe. The SpO₂ module processes the electrical signal and displays a waveform and digital values for SpO₂ and pulse rate.

This device is calibrated to display functional oxygen saturation. It provides four measurements:

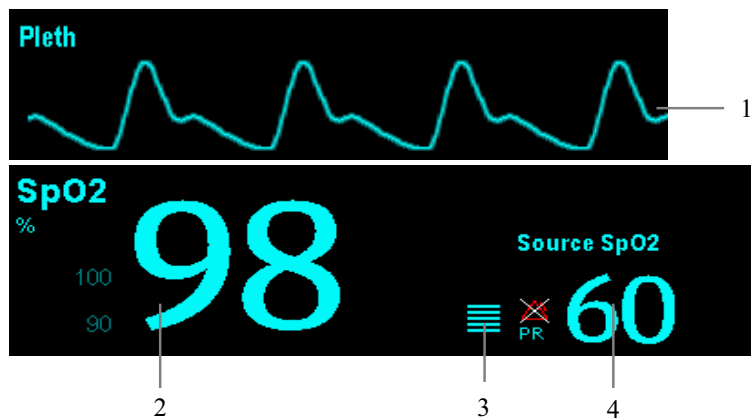

1. Pleth waveform (Pleth): visual indication of patient's pulse. The waveform is normalized.
2. Oxygen saturation of arterial blood (SpO₂): percentage of oxygenated hemoglobin in relation to the sum of oxyhemoglobin and deoxyhemoglobin.
3. Perfusion indicator: the pulsatile portion of the measured signal caused by arterial pulsation.
4. Pulse rate (derived from pleth wave): detected pulsations per minute.

10.2 Safety

WARNING

- **Use only SpO₂ sensors specified in this manual. Follow the SpO₂ sensor's instructions for use and adhere to all warnings and cautions.**
 - **When a trend toward patient deoxygenation is indicated, blood samples should be analyzed by a laboratory co-oximeter to completely understand the patient's condition.**
 - **Do not use SpO₂ sensors during magnetic resonance imaging (MRI). Induced current could potentially cause burns. The sensor may affect the MRI image, and the MRI unit may affect the accuracy of the oximetry measurements.**
 - **Prolonged continuous monitoring may increase the risk of undesirable changes in skin characteristics, such as irritation, reddening, blistering or burns. Inspect the sensor site every two hours and move the sensor if the skin quality changes. Change the application site every four hours. For neonates, or patients with poor peripheral blood circulation or sensitive skin, inspect the sensor site more frequently.**
-

10.3 Identifying SpO₂ Modules

To identify which SpO₂ module is incorporated into your MPM, see the company logo located at the right upper corner. The color of the cable connector matches the company as shown below:

- MPM SpO₂ module: a blue connector without logo.
- Masimo SpO₂ module: a white connector with a logo of Masimo SET.
- Nellcor SpO₂ module: a grey connector with a logo of Nellcor.

The connectors for these three SpO₂ sensors are mutually exclusive.

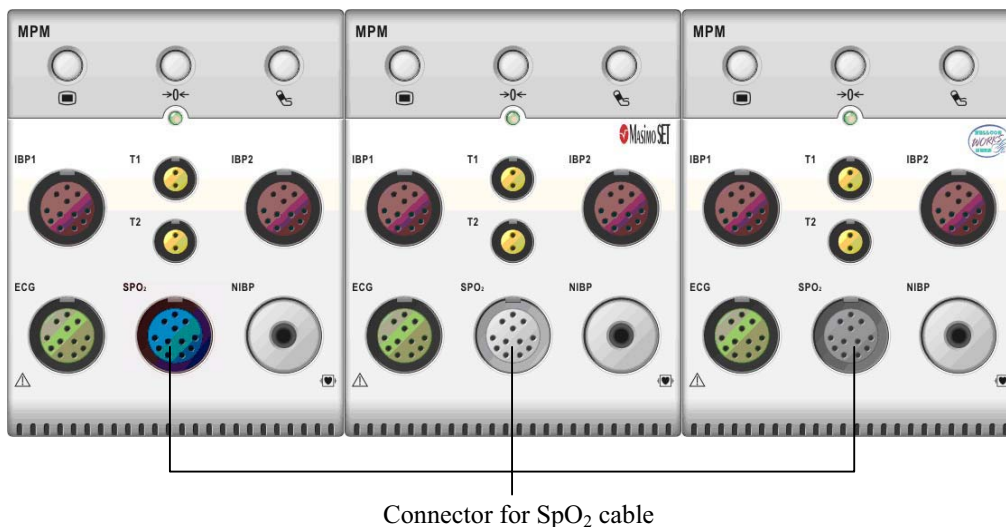

10.4 Applying the Sensor

1. Select an appropriate sensor according to the module type, patient category and weight.
2. Remove colored nail polish from the application site.
3. Apply the sensor to the patient.
4. Select an appropriate adapter cable according to the connector type and plug this cable into the MPM.
5. Connect the sensor cable to the adapter cable.

10.5 Changing SpO₂ Settings

10.5.1 Accessing SpO₂ Menus

By selecting the SpO₂ parameter window or waveform area, you can access the **[SpO₂ Setup]** menu.

10.5.2 Adjusting the Desat Alarm

The desat alarm is a high level alarm notifying you of potentially life threatening drops in oxygen saturation. Select **[Alarm Setup >>]** from the **[SpO₂ Setup]** menu. From the popup menu, you can set low alarm limit, alarm switch, and alarm recording for **[Desat]**. When the SpO₂ value is below the desat alarm limit and desat alarm switch is set on, the message **[SpO₂ Desat]** is displayed.

10.5.3 Setting SpO₂ Sensitivity

For Masimo SpO₂ module, you can set **[Sensitivity]** to **[Normal]** or **[Maximum]** in the **[SpO₂ Setup]** menu. When the **[Sensitivity]** is set to **[Maximum]**, the patient monitor is more sensitive to minor signals. When monitoring critically ill patients whose pulsations are very weak, it is strongly recommended that the sensitivity is set to **[Maximum]**. When monitoring neonatal or non-critically ill patients who tend to move a lot, noise or invalid signals may be caused. In this case, it is recommended that the sensitivity is set to **[Normal]** so that the interference caused by motion can be filtered and therefore the measurement stability can be ensured.

10.5.4 Changing Averaging Time

The SpO₂ value displayed on the monitor screen is the average of data collected within a specific time. The shorter the averaging time is, the quicker the patient monitor responds to changes in the patient's oxygen saturation level. Contrarily, the longer the averaging time is, the slower the patient monitor responds to changes in the patient's oxygen saturation level, but the measurement accuracy will be improved. For critically ill patients, selecting shorter averaging time will help understanding the patient's state.

To set the averaging time:

- For MPM SpO₂ module, select [**Sensitivity**] in the [**SpO2 Setup**] menu and then toggle between [**High**], [**Med**] and [**Low**], which respectively correspond to 7 s, 9 s and 11 s.
- For Masimo SpO₂ module, select [**Averaging**] in the [**SpO2 Setup**] menu and then toggle between [**2-4 s**], [**4-6 s**], [**8 s**], [**10 s**], [**12 s**], [**14 s**] and [**16 s**].

10.5.5 Monitoring SpO₂ and NIBP Simultaneously

When monitoring SpO₂ and NIBP on the same limb simultaneously, you can switch [**NIBP Simul**] on in the [**SpO2 Setup**] menu to lock the SpO₂ alarm status until the NIBP measurement ends. If you switch [**NIBP Simul**] off, low perfusion caused by NIBP measurement may lead to inaccurate SpO₂ readings and therefore cause false physiological alarms.

10.5.6 Sat-Seconds Alarm Management

With traditional alarm management, high and low alarm limits are set for monitoring oxygen saturation. During monitoring, as soon as an alarm limit is violated, an audible alarm immediately sounds. When the patient % SpO₂ fluctuates near an alarm limit, the alarm sounds each time the limit is violated. Such frequent alarm can be distracting. Nellcor's Sat-Seconds alarm management technique is used to reduce these nuisance alarms.

The Sat-Seconds feature is available with the Nellcor SpO₂ module to decrease the likelihood of false alarms caused by motion artifacts. To set the Sat-Seconds limit, select [**Sat-Seconds**] in the [**SpO2 Setup**] menu and then select the appropriate setting.

With Sat-Seconds alarm management, high and low alarm limits are set in the same way as traditional alarm management. A Sat-Seconds limit is also set. The Sat-Seconds limit controls the amount of time that SpO₂ saturation may be outside the set limits before an alarm sounds. The method of calculation is as follows: the number of percentage points that the SpO₂ saturation falls outside the alarm limit is multiplied by the number of seconds that it remains outside the limit. This can be stated as the equation:

$$\text{Sat-Seconds} = \text{Points} \times \text{Seconds}$$

Only when the Sat-Seconds limit is reached, the monitor gives a Sat-Seconds alarm. For example, the figure below demonstrates the alarm response time with a Sat-Seconds limit set at 50 and a low SpO₂ limit set at 90%. In this example, the patient % SpO₂ drops to 88% (2 points) and remains there for 2 seconds. Then it drops to 86% (4 points) for 3 seconds, and then to 84% (6 points) for 6 seconds. The resulting Sat-Seconds are:

% SpO ₂	Seconds	Sat-Seconds
2×	2=	4
4×	3=	12
6×	6=	36
Total Sat-Seconds=		52

After approximately 10.9 seconds, a Sat-Second alarm would sound, because the limit of 50 Sat-Seconds would have been exceeded.

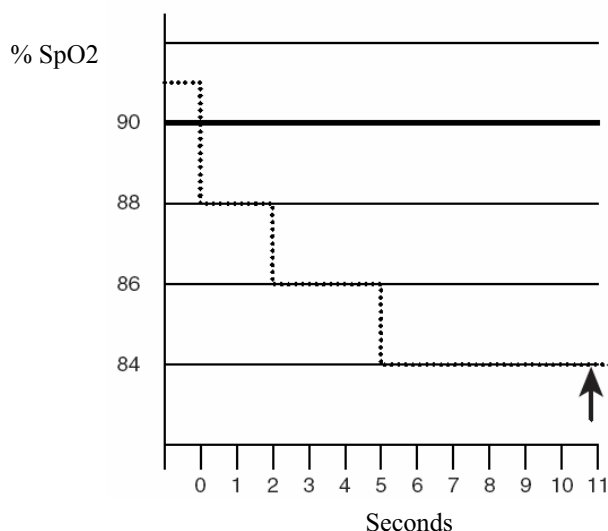

Saturation levels may fluctuate rather than remaining steady for a period of several seconds. Often, the patient % SpO₂ may fluctuate above and below an alarm limit, re-entering the non-alarm range several times. During such fluctuation, the monitor integrates the number of %SpO₂ points, both positive and negative, until either the Sat-Seconds limit is reached, or the patient %SpO₂ re-enters the non-alarm range and remains there.

10.5.7 Changing the Speed of the Pleth Wave

In the [SpO₂ Setup] menu, select [Sweep] and then select the appropriate setting. The faster the waveform sweeps, the wider the waveform is.

10.5.8 Setting the Alarm Level for SpO₂ Sensor Off Alarm

Select [Alarm Setup >>] from the [User Maintenance] menu. You can set the [SpO₂SensorOff Lev.] in the popup menu.

10.5.9 Setting the SpO2 Tone Mode

Select [**Others >>**] from the [**User Maintenance**] menu. In the popup menu, you can set [**SpO2 Tone**] as [**Mode 1**] or [**Mode 2**].

WARNING

- **The same SpO2 tone mode shall be used for the same patient monitors in a single area.**
-

10.6 Measurement Limitations

If you doubt the measured SpO2, check patient vital signs first. Then check the patient monitor and SpO2 sensor. The following factors may influence the accuracy of measurement:

- Ambient light
- Physical movement (patient and imposed motion)
- Diagnostic testing
- Low perfusion
- Electromagnetic interference, such as MRI environment
- Electrosurgical units
- Dysfunctional haemoglobin, such as carboxyhemoglobin (COHb) and methemoglobin (MetHb)
- Presence of certain dyes, such as methylene and indigo carmine
- Inappropriate positioning of the SpO2 sensor, or use of incorrect SpO2
- Drop of arterial blood flow to immeasurable level caused by shock, anemia, low temperature or vasoconstrictor.

10.7 Masimo Information



■ Masimo Patents

This device is covered under one or more the following U.S.A. patents: 5,758,644; 5,823,950; 6,011,986; 6,157,850; 6,263,222; 6,501,975; 7,469,157 and other applicable patents listed at: www.masimo.com/patents.htm.

■ No Implied License

Possession or purchase of this device does not convey any express or implied license to use the device with unauthorized sensors or cables which would, alone, or in combination with this device, fall within the scope of one or more of the patents relating to this device.

10.8 Nellcor Information



■ Nellcor Patents

This device is covered under one or more the following U.S. Patents: 4,802,486; 4,869,254; 4,928,692; 4,934,372; 5,078,136; 5,351,685; 5,485,847; 5,533,507; 5,577,500; 5,803,910; 5,853,364; 5,865,736; 6,083,172; 6,463,310; 6,591,123; 6,708,049; Re.35,122 and international equivalents. U.S.A international patents pending.

■ No Implied License

Possession or purchase of this device does not convey any express or implied license to use the device with unauthorized replacement parts which would, alone, or in combination with this device, fall within the scope of one or more of the patents relating to this device.

11 Monitoring NIBP

11.1 Introduction

The MPM uses the oscillometric method for measuring the non-invasive blood pressure (NIBP). This measurement can be used for adults, pediatrics and neonates.

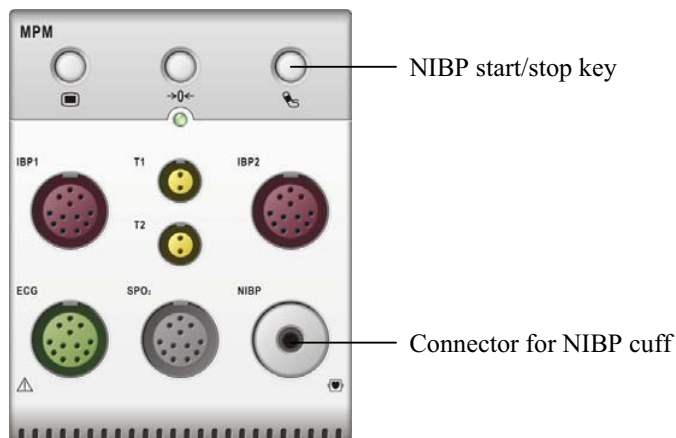

Automatic non-invasive blood pressure monitoring uses the oscillometric method of measurement. To understand how this method works, we'll compare it to the auscultative method. With auscultation, the clinician listens to the blood pressure and determines the systolic and diastolic pressures. The mean pressure can then be calculated with reference to these pressures as long as the arterial pressure curve is normal.

Since the monitor cannot hear the blood pressure, it measures cuff pressure oscillation amplitudes. Oscillations are caused by blood pressure pulses against the cuff. The oscillation with the greatest amplitude is the mean pressure. This is the most accurate parameter measured by the oscillometric method. Once the mean pressure is determined, the systolic and diastolic pressures are calculated with reference to the mean.

Simply stated, auscultation measures systolic and diastolic pressures and the mean pressure is calculated. The oscillometric method measures the mean pressure and determines the systolic and diastolic pressures.

As specified by IEC 60601-2-30/EN60601-2-30, NIBP measurement can be performed during electro-surgery and discharge of defibrillator.

NIBP diagnostic significance must be decided by the doctor who performs the measurement.

NOTE

- **Blood pressure measurements determined with this device are equivalent to those obtained by a trained observer using the cuff/stethoscope auscultatory method or an intra-arterial blood pressure measurement device, within the limits prescribed by the American National Standard, Manual, electronic, or automated sphygmomanometers.**
-

11.2 Safety

WARNING

- **Be sure to select the correct patient category setting for your patient before measurement. Do not apply the higher adult settings for pediatric or neonatal patients. Otherwise it may present a safety hazard.**
 - **Do not measure NIBP on patients with sickle-cell disease or any condition where skin damage has occurred or is expected.**
 - **Use clinical judgement to determine whether to perform frequent unattended blood pressure measurements on patients with severe blood clotting disorders because of the risk of hematoma in the limb fitted with the cuff.**
 - **Do not use the NIBP cuff on a limb with an intravenous infusion or arterial catheter in place. This could cause tissue damage around the catheter when the infusion is slowed or blocked during cuff inflation.**
 - **If you doubt the NIBP readings, determines the patient's vital signs by alternative means and then verify that the monitor is working correctly.**
-
-

11.3 Measurement Limitations

Measurements are impossible with heart rate extremes of less than 40bpm or greater than 240bpm, or if the patient is on a heart-lung machine.

The measurement may be inaccurate or impossible:

- If a regular arterial pressure pulse is hard to detect
- With excessive and continuous patient movement such as shivering or convulsions
- With cardiac arrhythmias
- Rapid blood pressure changes
- Severe shock or hypothermia that reduces blood flow to the peripheries
- Obesity, where a thick layer of fat surrounding a limb dampens the oscillations coming from the artery

11.4 Measurement Methods

There are three methods of measuring NIBP:

- Manual: measurement on demand.
- Auto: continually repeated measurements at set intervals.
- STAT: continually rapid series of measurements over a five minute period, then return to the previous mode.

11.5 Setting Up the NIBP Measurement

11.5.1 Preparing to Measure NIBP

1. Power on the monitor.
2. Verify that the patient category is correct. Change it if necessary.
3. Plug the air tubing into the NIBP connector on the MPM module.
4. Select a correct sized cuff and then apply it as follows:
 - ◆ Determine the patient's limb circumference.

-
- ◆ Select an appropriate cuff by referring to the limb circumference marked on the cuff. The width of the cuff should be 40% (50% for neonates) of the limb circumference, or 2/3 of the upper arm's length. The inflatable part of the cuff should be long enough to encircle at least 50% to 80% of the limb.
 - ◆ Apply the cuff to an upper arm or leg of the patient and make sure the Φ marking on the cuff matches the artery location. Do not wrap the cuff too tightly around the limb. It may cause discoloration, and ischemia of the extremities. Make sure that the cuff edge falls within the marked range. If it does not, use a larger or smaller cuff that will fit better.
5. Connect the cuff to the air tubing and make sure that the bladder inside the cover is not folded and twisted.

NOTE

-
- **The use of the equipment is restricted to one patient at a time;**
-

11.5.2 Starting and Stopping Measurements

Select the [NIBP Measure] QuickKey and you can start the desired measurement from the popup menu. You can select [Stop All] QuickKey to stop all NIBP measurements. You can also start and stop measurements by using the  hardkey on either the monitor's front panel or the MPM module.

11.5.3 Correcting the Measurement if Limb is not at Heart

Level

The cuff should be applied to a limb at the same level as the patient's heart. If the limb is not at the heart level, to the displayed value:

- Add 0.75 mmHg (0.10 kPa) for each centimetre higher, or
- Deduct 0.75 mmHg (0.10 kPa) for each centimeter lower.

11.5.4 Enabling NIBP Auto Cycling and Setting the Interval

1. Select the NIBP parameter window to enter the [NIBP Setup] menu.
2. Select [Interval] and then select a desired time interval. Selecting [Manual] switches to manual mode.
3. Start a measurement manually. The monitor will then automatically repeat NIBP measurements at the set time interval.

11.5.5 Starting a STAT Measurement

1. Select the NIBP parameter window to enter the [NIBP Setup] menu.
2. Select [NIBP STAT]. The STAT mode initiates 5 minutes of continuous, sequential, automatic NIBP measurements.

WARNING

- **Continuous non-invasive blood pressure measurements may cause purpura, ischemia and neuropathy in the limb with the cuff. Inspect the application site regularly to ensure skin quality and inspect the extremity of the cuffed limb for normal color, warmth and sensitivity. If any abnormality occurs, move the cuff to another site or stop the blood pressure measurements immediately.**
-

11.6 Understanding the NIBP Numerics

The NIBP display shows numerics only as below. Your display may be configured to look slightly different.

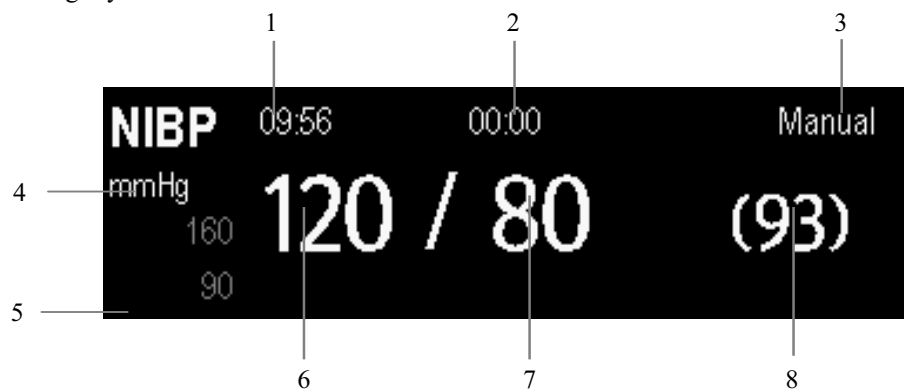

1. Time of last measurement
2. Time remaining to next measurement
3. Measurement mode
4. Unit of pressure: mmHg or kPa
5. Prompt message area: shows NIBP-related prompt messages
6. Systolic pressure
7. Diastolic pressure
8. Mean pressure obtained after the measurement and cuff pressure obtained during the measurement

11.7 Changing NIBP Settings

By selecting the NIBP parameter window, you can enter the **[NIBP Setup]** menu.

11.7.1 Setting the Initial Cuff Inflation Pressure

You can set the initial cuff inflation pressure manually. In the **[NIBP Setup]** menu, select **[Initial Pressure]** and then select the appropriate setting.

NOTE

- **The initial cuff inflation pressure may be different for respective patients, so the initial cuff inflation pressure is not saved in the configuration settings.**
-

11.7.2 Setting NIBP Alarm Properties

Select **[Alarm Setup >>]** from the **[NIBP Setup]** menu. You can set the alarm properties for this parameter in the popup menu.

11.7.3 Displaying NIBP List

Select **[Screens]** QuickKey→**[Screen Setup]**. You can set **[NIBP List]** to be displayed at the bottom area of the screen. Then, multiple sets of most recent NIBP measurements will be displayed. And PR displayed is derived from NIBP.

NIBP List	PR	Time
120 / 80 (93)	60	17:15
120 / 80 (93)	60	16:23
120 / 80 (93)	60	16:09
120 / 80 (93)	60	14:24

You can not display NIBP list in some screens such as the big numerics screen and the interpretation of resting 12-lead ECG screen.

11.7.4 Setting the Pressure Unit

Select [**Unit Setup >>**] from the [**User Maintenance**] menu. In the popup menu, select [**Press. Unit**] and toggle between [**mmHg**] and [**kPa**].

11.8 Assisting Venous Puncture

You can use the NIBP cuff to cause sub-diastolic pressure to block the venous blood vessel and therefore help venous puncture.

1. Select [**VeniPuncture >>**] from the [**NIBP Setup**] menu. In the popup menu, verify that the [**Cuff Press.**] value is appropriate. Change it if necessary.
2. Select [**VeniPuncture**].
3. Puncture vein and draw blood sample.
4. Select the  hardkey on the monitor's front, or the [**Stop All**] QuickKey to deflate the cuff. The cuff deflates automatically after a set time if you do not deflate it.

During measurement, the NIBP display shows the inflation pressure of the cuff and the remaining time in venous puncture mode.

11.9 Resetting NIBP

If the blood pressure pump works incorrectly but the monitor does not alarm for it, you can check the pump by resetting it. To reset the pump, select [**Reset**] from [**NIBP Setup**].

11.10 NIBP Leakage Test

The NIBP leakage test checks the integrity of the system and of the valve. It is required at least once every two years or when you doubt the measured NIBP. If the test failed, corresponding prompt messages will be given. If no message is displayed, it means no leakage is detected.

Tools required:

- An air tubing
- Metal container or vessel

Follow this procedure to perform the leakage test:

1. Set the patient category to [Adu].
2. Connect a rigid metal container or vessel with a capacity of 500 ml \pm 5% to the NIBP cuff connector of the monitor.

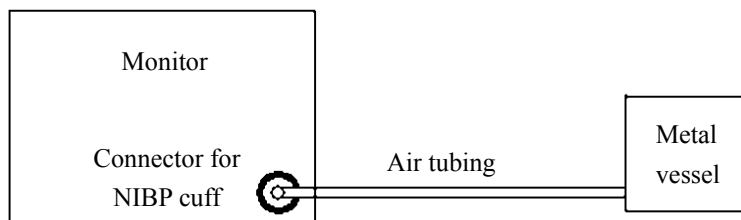

3. Select [Main Menu]→[Maintenance >>]→[NIBP Leakage Test]. The NIBP display shows [Leakage Testing...].
4. After about 20 seconds, the monitor will automatically deflate. This means the test is completed.
5. If the message [NIBP Pneumatic Leak] is displayed, it indicates that the NIBP airway may have leakages. Check the tubing and connections for leakages. If you ensure that the tubing and connections are all correct, perform a leakage test again.

If the problem persists, contact your service personnel.

NOTE

-
- **The leakage test is intended for use to simply determine whether there are leakages in the NIBP airway. It is not the same as that specified in the EN 1060-3 standard.**
-

11.11 NIBP Accuracy Test

The NIBP accuracy test is required at least once every two years or when you doubt the measured NIBP.

Tools required:

- T-piece connector
- Appropriating tubing
- Balloon pump
- Metal Vessel (volume 500 ± 25 ml)
- Reference manometer (calibrated with accuracy higher than 0.75 mmHg)

Follow this procedure to perform the accuracy test:

1. Connect the equipment as shown.

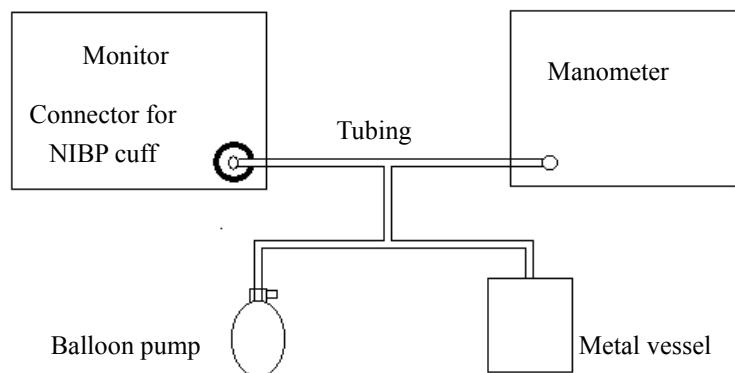

2. Before inflation, the reading of the manometer should be 0. If not, open the valve of the balloon pump to let the whole airway open to the atmosphere. Close the valve of the balloon pump after the reading is 0.
3. Select [**Main Menu**] \rightarrow [**Maintenance >>**] \rightarrow [**NIBP Accuracy Test**].
4. Check the manometer values and the monitor values. Both should be 0mmHg.
5. Raise the pressure in the rigid vessel to 50 mmHg with the balloon pump. Then, wait for 10 seconds until the measured values become stable.
6. Compare the manometer values with the monitor values. The difference should be 3 mmHg. If it is greater than 3 mmHg, contact your service personnel.
7. Raise the pressure in the rigid vessel to 200 mmHg with the balloon pump. Then, wait for 10 seconds until the measured values become stable and repeat step 6.

11.12 Calibrating NIBP

NIBP is not user-calibrated. Cuff-pressure transducers must be verified and calibrated once every two years by a qualified service professional. Contact your service personnel when a calibration is necessary.

12 Monitoring Temp

12.1 Introduction

You can simultaneously monitor two temperature sites using the MPM.

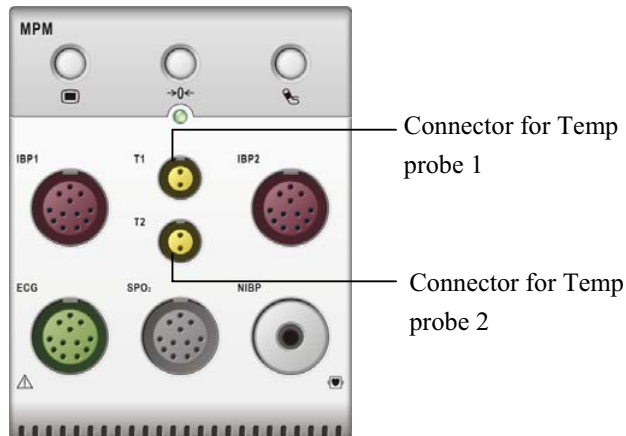

12.2 Safety

WARNING

- Verify that the probe detection program works correctly before monitoring. Plug out the temperature probe cable from the T1 or T2 connector, and the monitor can display the message [T1 Sensor Off] or [T2 Sensor Off] and give alarm tones correctly.
-

12.3 Making a Temp Measurement

1. Select an appropriate probe for your patient.
2. If you are using a disposable probe, connect the probe to the temperature cable.
3. Plug the probe or temperature cable to the temperature connector.
4. Attach the probe to the patient correctly.
5. Check that the alarm settings are appropriate for this patient.

12.4 Understanding the Temp Display

The temperature monitoring is displayed on the monitor as three numerics: T1, T2 and TD. By selecting this area, you can enter the [Alarm Setup] menu.



12.5 Setting the Temperature Unit

Select [Unit Setup >>] from the [User Maintenance] menu. In the popup menu, select [Temp Unit] and toggle between [°C] and [°F]

13 Monitoring IBP

13.1 Introduction

You can measure invasive blood pressure using the MPM, or the pressure plug-in module. The monitor can monitor up to 8 invasive blood pressures and displays the systolic, diastolic and mean pressures and a waveform for each pressure.

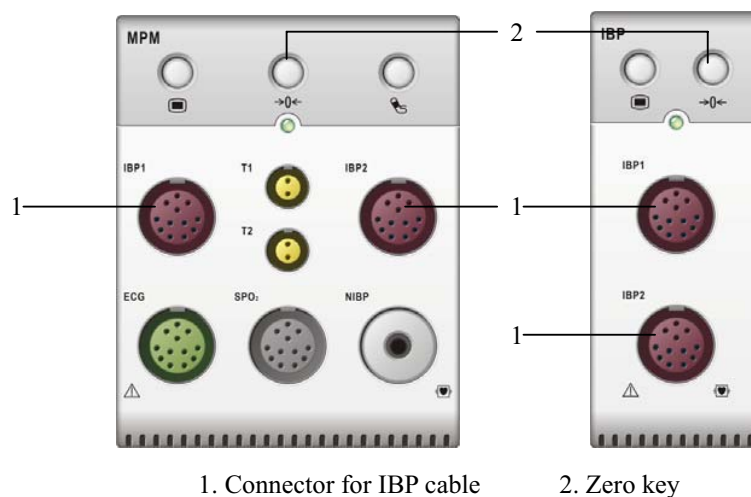

1. Connector for IBP cable

2. Zero key

13.2 Safety

WARNING

- Use only pressure transducers specified in this manual. Never reuse disposable pressure transducers.
 - Make sure that the applied parts never come into contact with other electric devices.
 - To reduce the hazard of burns during high-frequency surgical procedure, ensure that the monitor's cables and transducers never come into contact with the high-frequency surgical units.
 - When using accessories, their operating temperature should be taken into consideration. For details, refer to instructions for use of accessories.
-

13.3 Setting Up the Pressure Measurement

1. Plug the pressure cable into the IBP connector.
2. Prepare the flush solution.
3. Flush the system to exhaust all air from the tubing. Ensure that the transducer and stopcocks are free of air bubbles.

WARNING

- **If air bubbles appear in the tubing system, flush the system with the infusion solution again. Air bubble may lead to wrong pressure reading.**

4. Connect the pressure line to the patient catheter.
5. Position the transducer so that it is level with the heart, approximately at the level of the midaxillary line.
6. Select the appropriate label.
7. Zero the transducer. After a successful zeroing, turn off the stopcock to the atmosphere and turn on the stopcock to the patient.

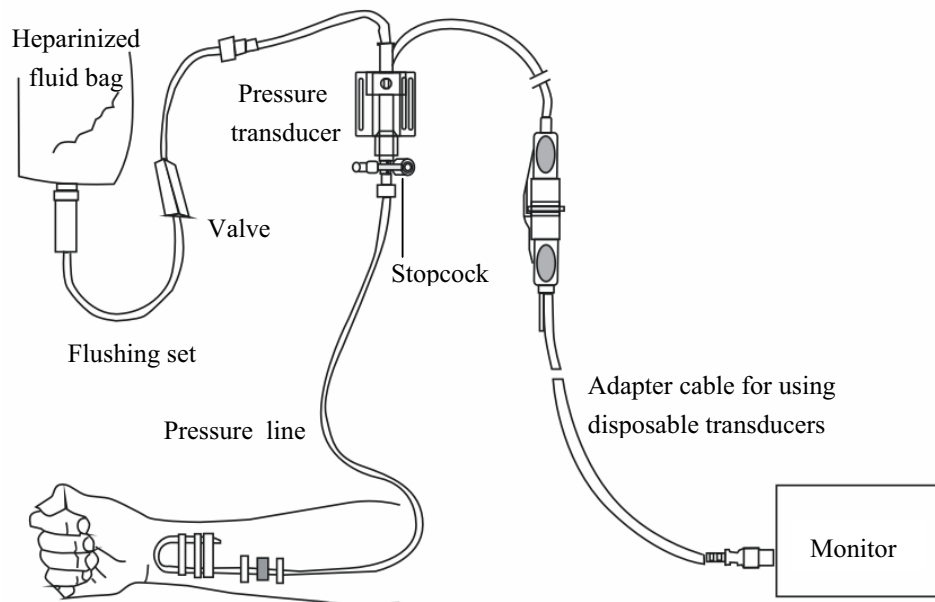

WARNING

- **If measuring intracranial pressure (ICP) with a sitting patient, level the transducer with the top of the patient's ear. Incorrect leveling may give incorrect values.**

13.4 Understanding the IBP Display

The IBP measurement is displayed on the monitor as a waveform and numeric pressures. The figure below shows the waveform and numerics for the Art pressure. For different pressures, this display may be slightly different.

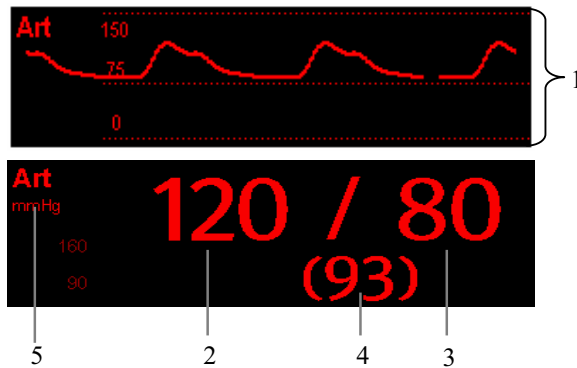

1. Waveform
2. Systolic pressure
3. Diastolic pressure
4. Mean pressure
5. Pressure unit

For some pressures, the parameter window may show the mean pressure only. For different pressures, their default unit may be different. If the Art and ICP pressures are measured simultaneously, the ICP parameter area will display numeric CPP, which is obtained by subtracting ICP from the Art mean.

13.5 Changing IBP Settings

13.5.1 Changing a Pressure for Monitoring

1. Select the pressure you want to change to enter its setup menu. In the menu, there is a figure showing the current IBP measurement connector.
2. Select [**Label**] and then select your desired label from the list. The already displayed labels cannot be selected.

Label	Description	Label	Description
PA	Pulmonary artery pressure	CVP	Central venous pressure
Ao	Aortic pressure	LAP	Left atrial pressure
UAP	Umbilical arterial pressure	RAP	Right atrial pressure
BAP	Brachial arterial pressure	ICP	Intracranial pressure
FAP	Femoral arterial pressure	UVP	Umbilical venous pressure
Art	Arterial blood pressure	LV	Left ventricular pressure

13.5.2 Setting Alarm Properties

Select [**Alarm Setup >>**] from the parameter setup menu. You can set alarm properties for this parameter in the popup menu.

13.5.3 Changing Averaging Time

The IBP value displayed on the monitor screen is the average of data collected within a specific time. The shorter the averaging time is, the quicker the patient monitor responds to changes in the patient's blood pressure. Contrarily, the longer the averaging time is, the slower the patient monitor responds to changes in the patient's blood pressure, but the measurement accuracy will be improved. For critically ill patients, selecting shorter averaging time will help understanding the patient's state.

To set the averaging time, in the parameter setup menu, select [**Sensitivity**] and toggle between [**High**], [**Med**] and [**Low**], the corresponding averaging time is about 1 s, 8 s and 12 s respectively.

13.5.4 Setting the Pressure Unit

Select [**Unit Setup >>**] from the [**User Maintenance**] menu. In the popup menu, select [**Press. Unit**] and toggle between [**mmHg**] and [**kPa**]. Select [**CVP Unit**] and toggle between [**mmHg**], [**cmH2O**] and [**kPa**].

13.5.5 Setting Up the IBP Wave

In the setup menu for the pressure, you can:

- Select [**Sweep**] and then select the appropriate setting. The faster the wave sweeps, the wider the wave is.
- Select [**Scale**] and then select the appropriate setting. If [**Auto**] is selected, the size of the pressure's waveform will be adjusted automatically.
- Select [**Filter**] and then select either:
 - ◆ [**No Filter**] to get the unfiltered IBP wave.
 - ◆ [**Normal**] to get the relatively smooth IBP wave.
 - ◆ [**Smooth**] to get the smoothest IBP wave.

13.6 Measuring PAWP

Pulmonary Artery Wedge Pressure (PAWP) values, used to assess cardiac function, are affected by fluid status, myocardial contractility, and valve and pulmonary circulation integrity.

Obtain the measurement by introducing a balloon-tipped pulmonary artery flotation catheter into the pulmonary artery. When the catheter is in one of the smaller pulmonary arteries, the inflated balloon occludes the artery allowing the monitor to record changes in the intrathoracic pressures that occur throughout the respiration cycle.

The pulmonary wedge pressure is the left ventricular end diastolic pressure when the airway pressure and valve function are normal. The most accurate PAWP values are obtained at the end of the respiration cycle when the intrathoracic pressure is fairly constant and the artifact caused by respiration is minimal.

13.6.1 Preparing to Measure PAWP

1. Prepare the same accessories as in the C.O. measurement. Connect the parts such as catheter, syringe, etc. following the C.O. measurement steps and use the balloon inflation port.
2. Connect the PAWP cable into the IBP connector on the monitor. Since PAWP is measured on PA, selecting [PA] as the IBP label is recommended.
3. Select the PA parameter window or waveform area to enter its setup menu. Then, select [PAWP] to enter the PAWP measurement window. You can also enter the PAWP measurement window from the P1-P4 parameter window.



NOTE

- After entering the PAWP measurement window, the monitor will turn off the PA alarm automatically.
-

13.6.2 Setting Up the PAWP Measurement

1. Wedge the flotation catheter into the pulmonary artery. Then inflate the balloon and pay attention to PA waveform changes on the screen.

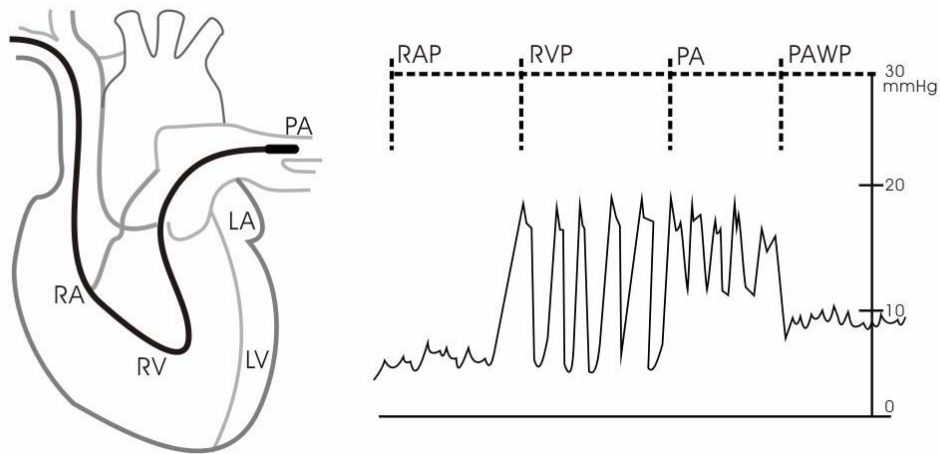

2. After obtaining a stable PAWP waveform, press the [**Freeze**] key to freeze the waveform and deflate the balloon.
3. You can adjust the PAWP scale to an appropriate position by adjusting ▲ or ▼ beside the [**Adjust**] button. Press the [**Confirm**] key to save one PAWP measurement.
4. If you need to start a new measurement, select [**Next Measure**].

WARNING

- Prolonged inflation can cause pulmonary hemorrhage, infarction or both. Inflate the balloon for the minimum time necessary to get an accurate measurement.
 - If the PAWP is greater than the PA (systolic), deflate the balloon and report the incident in accordance with hospital policy. Because the pulmonary artery could be accidentally ruptured, and the PAWP value derived will not reflect the patient's hemodynamic state, but will merely reflect the pressure in the catheter or balloon.
-

13.6.3 Understanding the PAWP Setup Menu

Select [**Setup**] to enter the [**PAWP Setup**] menu. In this menu, you can:

- Select a ECG lead wave as the first reference wave.
- Select a respiration wave as the second reference wave.
- Select a sweep speed for the displayed waveform.
- Change the size of the PA waveform by adjusting the scale height.

13.7 Zeroing the Transducer

To avoid inaccurate pressure readings, the monitor requires a valid zero. Zero the transducer in accordance with your hospital policy (at least once per day). Zero whenever:

- A new transducer or adapter cable is used.
- You reconnect the transducer cable to the monitor.
- The monitor restarts.
- You doubt the readings.

1. Turn off the stopcock to the patient.

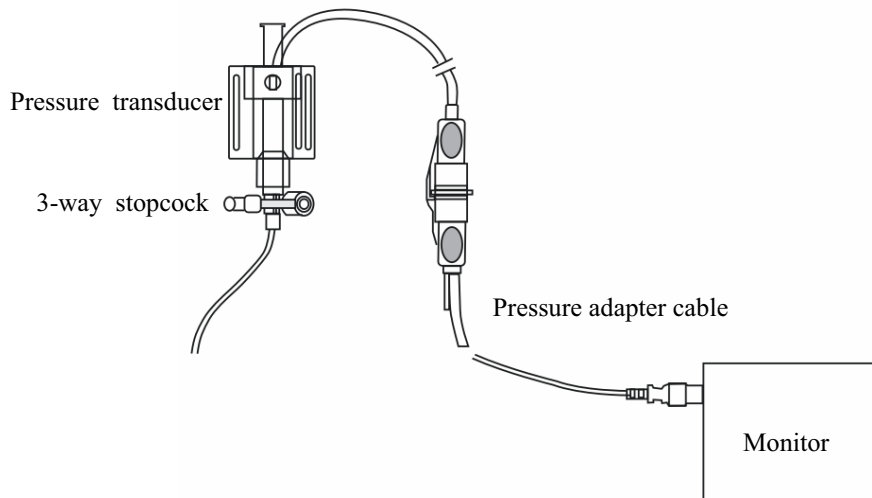

2. Vent the transducer to the atmospheric pressure by turning on the stopcock to the air.
3. Press the **→0←** hardkey on the module, or, in the setup menu for the pressure (e.g. Art), select [**Art Zero >>**]→[**Zero**]. During zero calibration, the [**Zero**] button appears dimmed. It recovers after the zero calibration is completed.
4. After the zero calibration is completed, close the stopcock to the air and open the stopcock to the patient.

NOTE

- **Your hospital policy may recommend that the ICP transducer is zeroed less frequently than other transducers.**
-

14 Monitoring Cardiac Output

14.1 Introduction

The cardiac output (C.O.) measurement invasively measures cardiac output and other hemodynamic parameters using the right heart (atria) thermodilution method. A cold solution of known volume and temperature is injected into the right atrium through the proximal port of a pulmonary artery (PA) catheter. The cold solution mixes with the blood in the right ventricle and the change in blood temperature is measured with a thermistor at the distal end of the catheter in the pulmonary artery. The temperature change is displayed as a curve in the C.O. split screen, and the monitor calculates the C.O. value from this curve. The C.O. value is inversely proportional to the area under the curve. As cardiac output varies continuously, a series of measurements must be carried out to achieve a reliable C.O. average value. Always use the average of multiple thermodilution measurements for therapy decisions. The monitor is capable of storing 6 measurements.

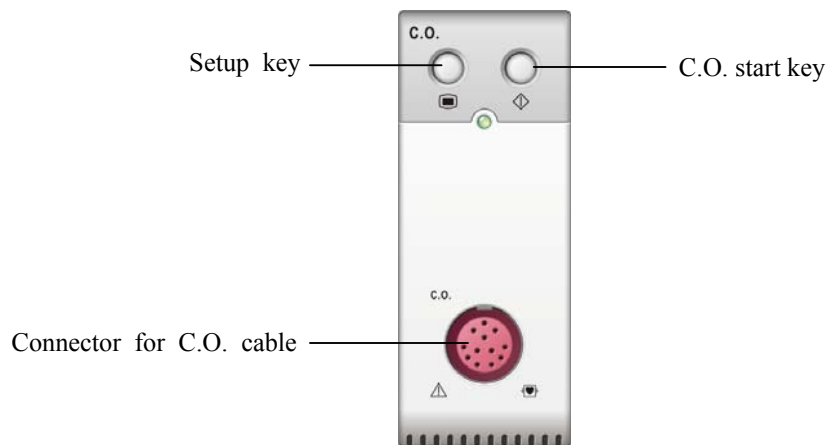

NOTE

- C.O. monitoring is restricted to adult patients only.

14.2 Understanding the C.O. Display

The C.O. measurement is displayed on the monitor as numeric C.O., C.I. and TB in the C.O. parameter window as shown below. To enter the [C.O. Setup] menu, select the C.O. parameter window.



1. Cardiac output
2. Time at which the C.O. average is calculated
3. Cardiac index
4. Blood temperature

14.3 Influencing Factors

The factors that affect cardiac output are:

- temperature of injectate solution,
- volume of injectate solution,
- patient's baseline blood temperature,
- patient's inspiratory/expiratory cycle,
- placement of catheter with relation to proximity of lung field,
- the catheter itself,
- the patient rhythm and hemodynamic status, and
- any other rapid IV solutions which are infused while the C.O. measurement is being performed.

Followings are some technique suggestions to obtain accurate C.O.:

- Injectate solution must be cooler than the patient's blood.
- Inject solution rapidly and smoothly.
- Inject at end expiration.

14.4 Setting Up the C.O. Measurement

WARNING

- Use only accessories specified in this manual. Make sure that the accessories never come into contact with conductive parts.
-

1. Connect the C.O. cable to the C.O. connector on the monitor.
2. Interconnect the C.O. module, catheter and syringe as shown below. Make sure that:
 - ◆ The module is securely inserted.
 - ◆ The PA catheter is in place in the patient.
 - ◆ The C.O. cable is properly connected to the module.

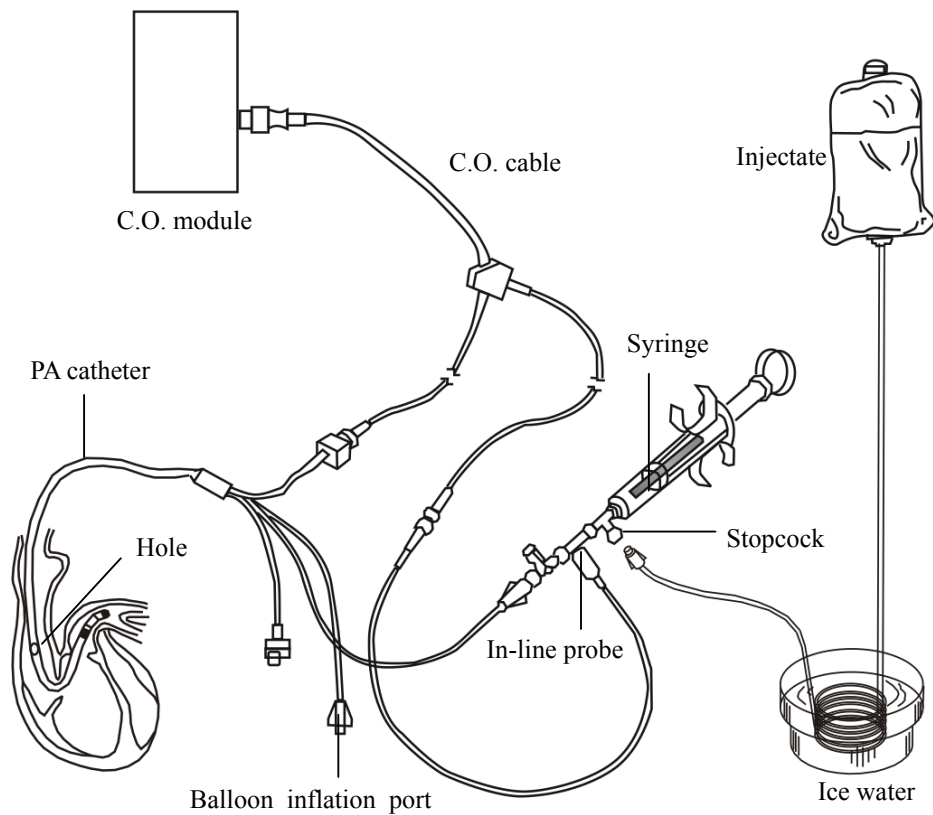

NOTE

- The above figure adopts TI sensor (PN: 6000-10-02079) for your reference.
-

3. Select the C.O. parameter window to enter the [**C.O. Setup**] menu. Check if the height and weight are appropriate for your patient. Change if necessary.
4. In the [**C.O. Setup**] menu:
 - ◆ Check that the correct computation constant is entered. Refer to the Instruction for Use of pulmonary artery catheter to determine the [**Comp. Const**] according to the entered injectate volume and temperature. To change the computation constant, select [**Comp. Const**] and then enter the correct value. When a new catheter is used, the computation constant should be adjusted in accordance with the manufacturer's instructions for use.
 - ◆ Switch [**Auto TI**] on and the injectate temperature is automatically obtained. When [**Auto TI**] is switched off, you can enter the injectate temperature in the [**Manual TI(°C)**] field.
 - ◆ Set the [**Measuring Mode**] to [**Auto**] or [**Manual**]. In [**Auto**] mode, the monitor automatically takes the C.O. measurement after establishing a baseline blood temperature. In this mode, it is not necessary to select the [**Start**] button in the C.O. measurement window. In [**Manual**] mode, the monitor takes the C.O. measurement after [**Start**] button is selected.
5. Select [**Enter C.O. Screen**] to enter the C.O. measurements window.

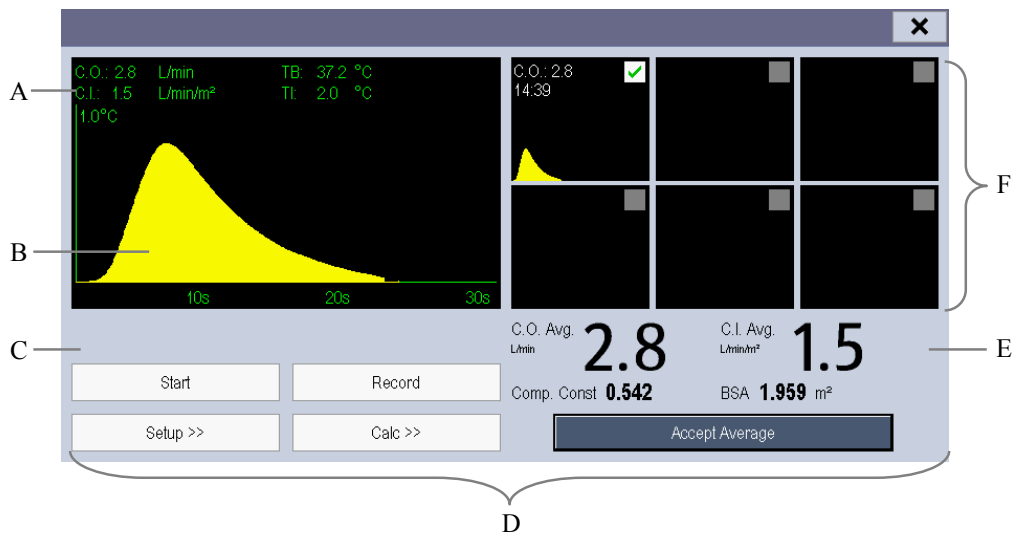

- A. Currently measured numeric
- B. Currently measured C.O. curve
- C. Prompt message area
- D. Buttons
- E. Averaged values
- F. Measurement windows

6. Proceed as follows.

- ◆ In [**Manual**] measure mode, when you see the message [**Ready for new set of measurement**], select the [**Start**] button and then inject the solution quickly. As shown in the figure above, during the measurement, the currently measured thermodilution curve is displayed. At the end of the measurement, the thermodilution curve is transferred to one of the 6 measurement windows and the monitor prompts you to wait for a certain period of time before starting a new measurement.
- ◆ In [**Auto**] measure mode, the C.O. measurements can be performed consecutively, without the need for pressing the [**Start**] button between measurements. A new thermodilution measurement is possible as soon as [**Inject now!**] is displayed on the screen. The patient monitor automatically detects further thermodilution measurements.

7. Perform 3 to 5 single measurements direct after each other as described in Step 6.

A maximum of 6 measurements can be stored. If you perform more than six measurements without rejecting any, the oldest will automatically be deleted when a seventh curve is stored. Select from the 6 measurement curves and the system will automatically calculate and display the averaged C.O. and C.I. values. Then select the [**Accept Average**] button to accept and store the averaged values.

When injecting, the stopcock to the PA catheter is open and the stopcock to the injectate solution is closed. After the measurement is completed, turn off the stopcock to the PA catheter and turn on the stopcock to the injectate solution, and then draw the injectate solution into the injectate syringe.

In the buttons area, you can:

- Select [**Start**] to start a C.O. measurement.
- Select [**Stop**] to stop the current measurement.
- Select [**Cancel**] during a measurement to cancel the measurement.
- Select [**Record**] to print out the curves selected for average calculation, numerics and averaged values by the recorder.
- Select [**Setup >>**] to access the [**C.O. Setup**] menu.
- Select [**Calc >>**]→[**Hemodynamic >>**] to access the [**Hemodynamic Calculation**] menu.

The system can automatically adjust the X-axis scale range to 30 s or 60 s and Y-axis scale range to 0.5°C, 1.0°C, or 2.0°C.

NOTE

- Starting measuring without blood temperature being stable yet may cause measuring failure.
 - During the cardiac output measurement, blood temperature alarms are inactive.
 - Please refer to the Instructions for Use of pulmonary artery catheter delivered with the patient monitor to determine the [Comp. Const] and the volume of injectate.
-

14.5 Measuring the Blood Temperature

As shown below, the blood temperature is measured with a temperature sensor at the distal end of the catheter in the pulmonary artery. During C.O. measurements, blood temperature alarms are suppressed to avoid false alarms. They will automatically recover as soon as the C.O. measurements are completed.

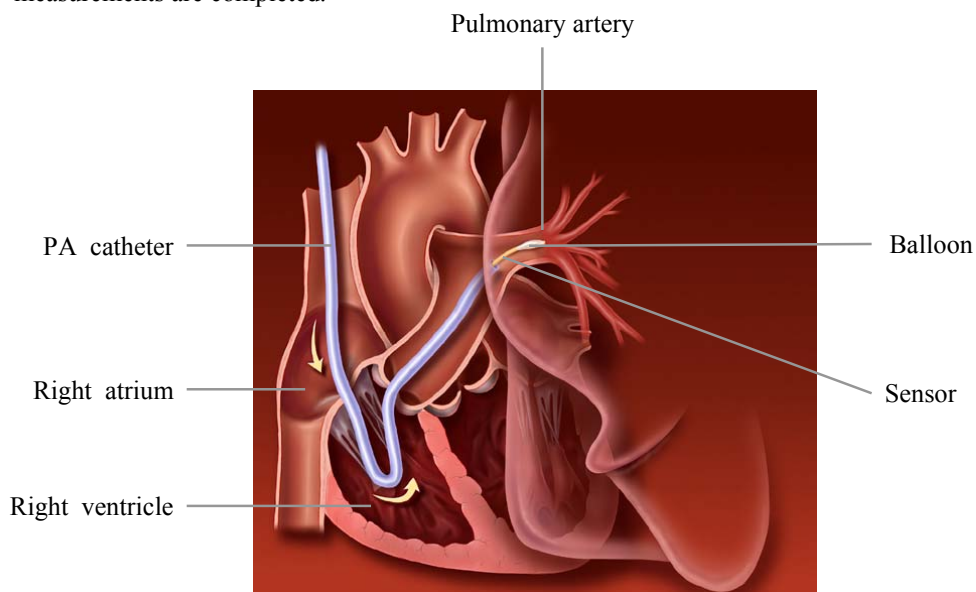

14.6 Changing C.O. Settings

14.6.1 Setting the Temperature Unit

Select [Unit Setup >>] from the [User Maintenance] menu. In the popup menu, select [Temp Unit] to toggle between [°C] and [°F].

14.6.2 Setting Alarm Properties

Select [Alarm Setup >>] from the [C.O. Setup] menu. You can set alarm properties for this parameter in the popup menu.

15 Monitoring CCO/SvO₂

15.1 Introduction

Edwards Vigilance II® monitor measures continuous cardiac output (CCO), mixed venous oxygen saturation (SvO₂), central venous oxygen saturation (ScvO₂) etc. It also calculates hemodynamic and oxygenation parameters. This patient monitor can be connected to the Vigilance II® monitor and can display, store, and review the measured and calculated parameter values from the Vigilance II® monitor. This patient monitor can also give alarms of these measured parameters. You must set alarm on/off, alarm limits, alarm level, and alarm record separately on this monitor. The alarm is Off by default.

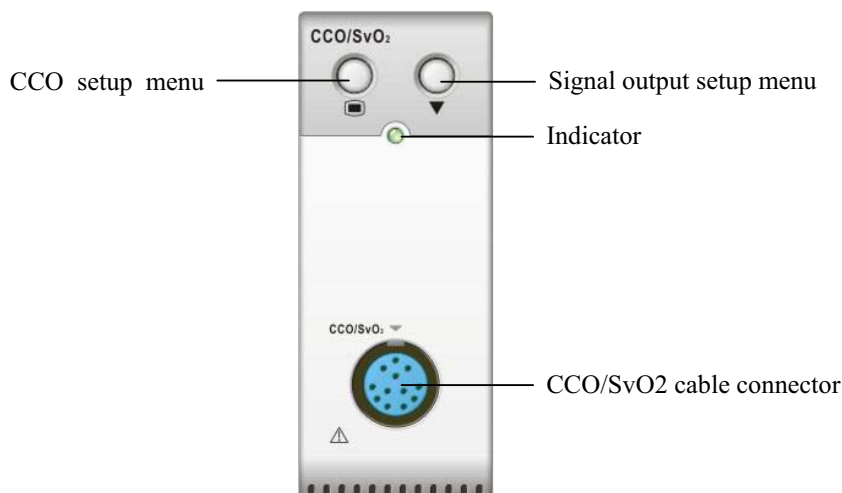

15.2 Safety

WARNING

- **The Vigilance II® monitor is manufactured by Edwards Lifesciences. This company provides the technology of measuring and calculating the relevant parameters. We only provide the connection between this patient monitor and Vigilance II® monitor.**
 - **If you have any doubts about the operation and maintenance of the Vigilance II® monitor, please read the Vigilance II® monitor Operator's Manual or contact Edwards Lifesciences (www.edwards.com) directly.**
 - **Fully observe the Vigilance II® monitor Operator's Manual to make settings and to connect the monitor with the patient.**
-

15.3 Automatic Communication Detection

The relevant parameter window is not displayed on the screen if this patient monitor detects communication failure between the CCO/SvO2 module and Vigilance II® monitor automatically.

15.4 Connecting the Vigilance II® Monitor



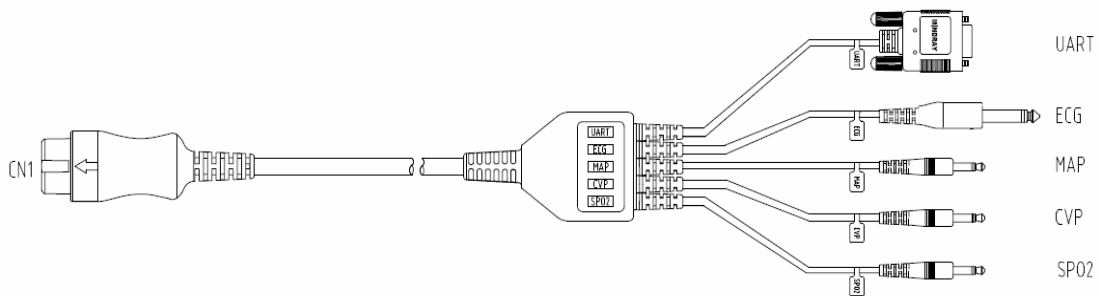

The following figure shows how to connect this patient monitor to the Vigilance II® monitor through cables.

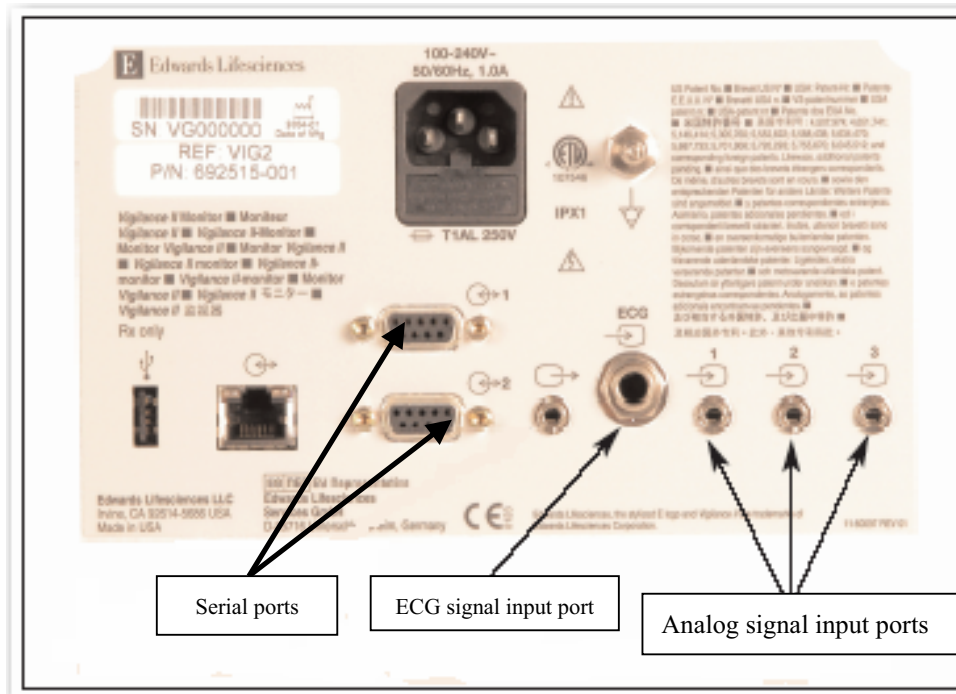

The following figure shows the rear housing of the Vigilance II® monitor.



To connect the Vigilance II® monitor,

1. Connect CN1 with the CCO/SvO2 connector on the patient monitor.
2. Insert the ECG signal end into the ECG signal input port marked  on the rear housing of the Vigilance II® monitor.
3. Insert the MAP signal end into the analog signal input port 1 marked , the CVP signal end into port 2 marked , and SPO2 signal end into port 3 marked  respectively on the rear housing of the Vigilance II® monitor.
4. Insert UART into either of the serial ports (marked ) on the rear housing of the Vigilance II® monitor
5. Set the Vigilance II® monitor as follows:
 - Access the [Serial Port Setup] menu.
 - ◆ Set [Device] to [IFMout], [Baud Rate] to [19200], [Parity] to [None], [Stop Bits] to [1], [Data Bits] to [8], and [Flow Control] to [2 s].
 - Access the [Analog Input Setup] menu.
 - ◆ For port 1, set [Parameter] to [MAP], [Voltage Range] to [0-5 v], [Full Scale Range] to 500 mmHg (66.7 kPa), [Simulated High Value] to 500 mmHg (66.7 kPa), and [Simulated Low Value] to 0 mmHg (0.0 kPa).
 - ◆ For port 2, set [Parameter] to [CVP], [Voltage Range] to [0-5 v], [Full Scale Range] to 100 mmHg (13.3 kPa), [Simulated High Value] to 100 mmHg (13.3 kPa), and [Simulated Low Value] to 0 mmHg (0.0 kPa).
 - ◆ For port 3, set [Parameter] to [SaO2], [Voltage Range] to [0-10 v], [Full Scale Range] to [100%], [Simulated High Value] to [100%], and [Simulated Low Value] to [0%].

Refer to the Vigilance II® Operator's Manual for the operation of the monitor.

WARNING

- **Calibrate the Vigilance II® monitor before monitoring. Refer to the Vigilance II® Operator's Manual for the calibration of the monitor.**

Notes

- **For the Vigilance II® monitor, [Flow Control] must be set to 2 seconds.**

15.5 Understanding CCO Parameters

By selecting the CCO parameter window→[**Hemodynamic Parameters >>**], you can view the hemodynamic parameters for evaluation of the patient's hemodynamic status.

Abbreviation	Unit	Full spelling
CCO	L/min	continuous cardiac output
CCI	L/min/m ²	continuous cardiac index
C.O.	L/min	cardiac output
C.I.	L/min/m ²	cardiac index
EDV	ml	end diastolic volume
EDVI	ml/m ²	end diastolic volume index
SV	ml/b	stroke volume
SVI	ml/b/m ²	stroke volume index
SVR	DS/cm ⁵ or kPa-s/l	systemic vascular resistance
SVRI	DS·m ² /cm ⁵ or kPa-s-m ² /l	systemic vascular resistance index
RVEF	%	right ventricular ejection fraction
BT	°C or °F	blood temperature
ESV	ml	end systolic volume
ESVI	ml/m ²	end systolic volume index
CVP	cmH ₂ O, kPa or mmHg	central venous pressure
MAP	mmHg or kPa	mean arterial pressure
HR	rpm	heart rate

15.6 Understanding the CCO Display

In the continuous measurement mode, the CCO parameter window displays the values of one primary parameter and up to three secondary parameters. You can select the desired parameter to be displayed through the menu. The default secondary parameters displayed are SVR, EDV and SV.



In the intermittent measurement mode, the CCO parameter window displays the values of two primary parameters and two secondary parameters. You can also select the desired parameter to be displayed through the menu.

15.7 Changing CCO Settings

15.7.1 Selecting Vascular Resistance Unit

1. Access the [CCO Setup] menu.
2. Select [Vascular Resistance Unit] and toggle between [DS/cm5] and [kPa-s/l].

15.7.2 Selecting the Displayed Parameters

1. Access the [CCO Setup] menu.
2. Select [Select Parameters >>].
3. Select the parameters to be displayed from the pop-up menu.

15.7.3 Checking the C.O. Measurements

You can check the C.O. measurements in the intermittent measurement mode.

1. Access the [CCO Setup] menu.
2. Select [C.O. Measurements >>].

15.7.4 Setting Signal Output

This patient monitor outputs analog signals for the Vigilance II® monitor. You can select [Signal Output Setup >>] from the [CCO Setup] menu to set the source of MAP signals. You can also select [Simulated High Value] or [Simulated Low Value] to provide simulated high value or low value signals for calibrating the Vigilance II® monitor. Refer to the Vigilance II® Operator's Manual for the calibration of the monitor.

Signal Type	Source	Value	Unit
ECG	II	60	bpm
MAP	Art	12.4	kPa
CVP	CVP	0.7	kPa
SpO2	SpO2	98	%

Simulated High Value Simulated Low Value

Output a simulated high value for calibrating Vigilance.

15.7.5 Selecting Alarm Properties

You can select [Alarm Setup >>] from the [CCO Setup] menu to set the alarm properties for the relevant parameters.

WARNING

- Because the alarm limits of the relevant measured parameters can be set on this patient monitor, the alarms of these parameters on this patient monitor may be different from those on the Vigilance II® monitor. Please pay special attention to the alarms on the Vigilance II® monitor.
 - The alarm of the relevant measured parameters on this patient monitor is Off by default. Please pay special attention to the alarms on the Vigilance II® monitor.
-

15.8 Understanding SvO2 Parameters

By selecting the SvO2 parameter window → [SvO2 Setup] → [Oxygenation Parameters >>], you can view all the oxygenation parameters.

Abbreviation	Unit	Full spelling
SvO2	%	mixed venous oxygen saturation
ScvO2	%	central venous oxygen saturation
SaO2	%	arterial oxygen saturation
DO2	ml/min	oxygen delivery
VO2	ml/min	oxygen consumption
O2EI	%	oxygen extraction index

15.9 Understanding the SvO2 Display

The parameter window displays the primary parameter, secondary parameter and SQI bargraph.



15.10 Changing SvO2 Settings

15.10.1 Setting Signal Output

This patient monitor outputs analog signals for the Vigilance II® monitor. You can select [**Signal Output Setup >>**] from the [**SvO2 Setup**] menu to set the source of MAP signals. You can also select [**Simulated High Value**] or [**Simulated Low Value**] to provide simulated high value or low value signals for the Vigilance II® monitor. Refer to the Vigilance II® Operator's Manual for the calibration of the monitor.

15.10.2 Selecting Alarm Properties

You can select [**Alarm Setup >>**] from the [**SvO2 Setup**] menu to set the alarm properties for the relevant parameters.

FOR YOUR NOTES

16 Monitoring Carbon Dioxide

16.1 Introduction

CO₂ monitoring is a continuous, non-invasive technique for determining the concentration of CO₂ in the patient's airway by measuring the absorption of infrared (IR) light of specific wavelengths. The CO₂ has its own absorption characteristic and the amount of light passing the gas probe depends on the concentration of the measured CO₂. When a specific band of IR light is passed through respiratory gas samples, some of IR light will be absorbed by the CO₂ molecules. The amount of IR light transmitted after it has been passed through the respiratory gas sample is measured with a photodetector. From the amount of IR light measured, the concentration of CO₂ is calculated.

There are two methods for measuring CO₂ in the patient's airway:

1. Mainstream measurement uses a CO₂ sensor attached to an airway adapter directly inserted into the patient's breathing system.
2. Sidestream/Microstream measurement samples expired patient gas at a constant sample flow from the patient's airway and analyzes it with a CO₂ sensor built into the CO₂ module.

The measurement provides:

1. A CO₂ waveform
2. End tidal CO₂ value (EtCO₂): the CO₂ value measured at the end of the expiration phase.
3. Fraction of inspired CO₂ (FiCO₂): the smallest CO₂ value measured during inspiration.
4. Airway respiration rate (awRR): the number of breaths per minute, calculated from the CO₂ waveform.

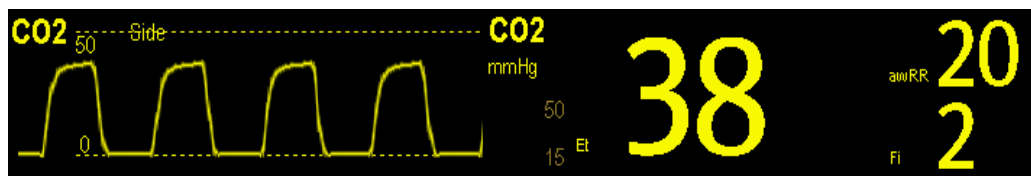

16.2 Identifying CO₂ Modules

From left to right are sidestream CO₂ module, microstream CO₂ module and mainstream CO₂.

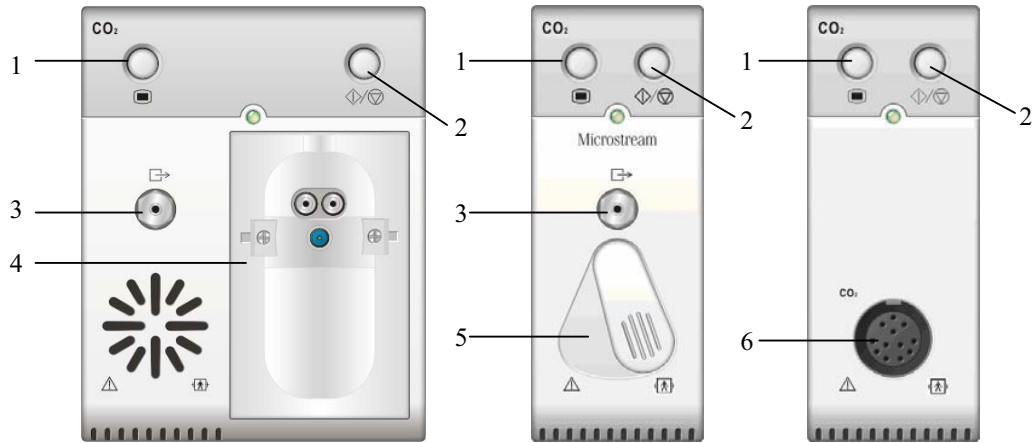

1. Setup key to enter the CO₂ setup menu
2. Measure/standby
3. Gas outlet
4. Slot for CO₂ watertrap
5. Connector for sampling line
6. Connector for CO₂ transducer

If you measure CO₂ using the AG module, see the section **Monitoring AG**.

16.3 Preparing to Measure CO₂

16.3.1 Using a Sidestream CO₂ Module

1. Attach the watertrap to the module and then connect the CO₂ components as shown below.

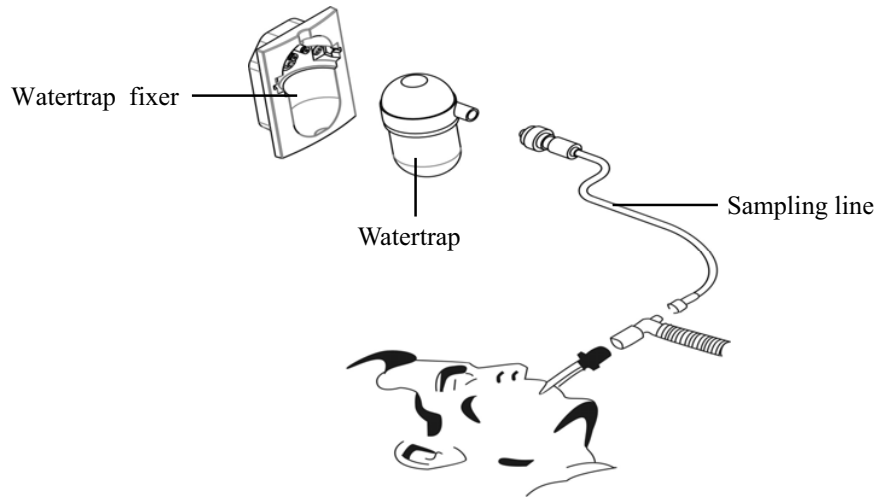

2. By default, the sidestream CO₂ module is in measure mode. The [**CO₂ Startup**] message appears on the screen when the CO₂ module is plugged.
3. After start-up is finished, the CO₂ module needs time to warm up to reach the operating temperature. The message [**CO₂ Sensor Warmup**] is displayed. If you perform CO₂ measurements during warm-up, the measurement accuracy may be compromised.
4. After warm-up is finished, you can perform CO₂ measurements.

NOTE

-
- **To extend the lifetime of the watertrap and module, disconnect the watertrap and set the operating mode to standby mode when CO₂ monitoring is not required.**
-

CAUTION

- The watertrap collects water drops condensed in the sampling line and therefore prevents them from entering the module. If the collected water reaches a certain amount, you should drain it to avoid blocking the airway.
 - The watertrap has a filter preventing bacterium, water and secretions from entering the module. After a long-term use, dust or other substances may compromise the performance of the filter or even block the airway. In this case, replace the watertrap. It is recommended to replace the watertrap once every two months, or when the watertrap is found leaky, damaged or contaminated.
-

16.3.2 Using a Microstream CO₂ Module

1. Connect the sampling line to the module and then connect the CO₂ components as shown below.

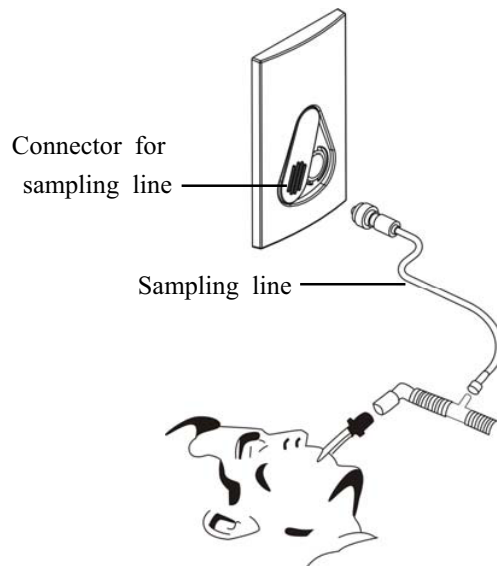

2. By default, the microstream CO₂ module is in measure mode. The message [**CO₂ Sensor Warmup**] appears on the screen when the CO₂ module is plugged.
3. After warm-up, you can perform CO₂ measurements.

16.3.3 Using a Mainstream CO₂ Module

1. Connect the sensor to the module.
2. By default, the mainstream CO₂ module is in measure mode. The message [CO₂ Sensor Warmup] appears on the screen when the CO₂ module is plugged.
3. After warm-up is finished, connect the transducer to the airway adapter.
4. Perform a zero calibration per the *Zeroing the Sensor* section.
5. After the zero calibration is finished, connect the airway as shown below.

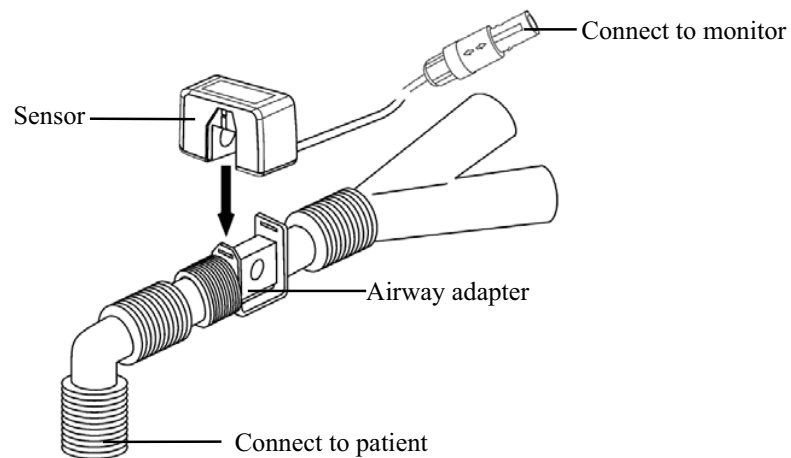

6. Make sure there are no leakages in the airway and then start a measurement.

NOTE

- Always position the sensor with the adapter in an upright position to avoid collection of fluids on the windows of the adapter. Large concentrations of fluids at this point will obstruct gas analysis.
-

16.4 Changing CO₂ Settings

16.4.1 Accessing CO₂ Menus



By selecting the CO₂ parameter window or waveform, you can access the **[CO₂ Setup]** menu.

16.4.2 Entering the Standby Mode

The standby mode of the CO₂ module relates to the standby mode of the monitor as follows:

- If the monitor enters the standby mode, the CO₂ module will also enter the standby mode.
- If the monitor exits the standby mode, the CO₂ module will also exit the standby mode.
- If the CO₂ module enters or exits the standby mode, it will not affect the monitor.

To enter or exit the standby mode manually,

- select the /  hardkey on the module, or
- select **[Operating Mode]** in the **[CO₂ Setup]** menu and then toggle between **[Standby]** and **[Measure]**.

When you set the sidestream CO₂ module to the standby mode, the CO₂ gas sample intake pump automatically sets the sample flow rate to zero. When exiting the standby mode, the CO₂ module continues to work at the preset sample flow rate with no need to warm up again. After nearly 1 minute, the module enters the full accuracy mode.

For the microstream CO₂ module, you can set a period of time after which the CO₂ module enters the standby mode if no breath is detected since the CO₂ module is powered on or the CO₂ module switches to the measuring mode or the automatic standby time is re-set. To set the standby time, in the **[CO₂ Setup]** menu, select **[Auto Standby]** and then select the appropriate setting.

16.4.3 Setting the CO₂ Unit

Select **[Unit Setup >>]** from the **[User Maintenance]** menu. In the popup menu, select **[CO₂ Unit]** and toggle between **[mmHg]**, **[%]** and **[kPa]**.

16.4.4 Setting up Gas Compensations

WARNING

- **Make sure that the appropriate compensations are used. Inappropriate compensations may cause inaccurate measurement values and result in misdiagnosis.**
-

For the sidestream CO₂ module:

1. Select [**CO2 Setup**].
2. According to the actual condition, set the concentration required for the following compensations:
 - ◆ [**O2 Compen**]
 - ◆ [**N2O Compen**]
 - ◆ [**Des Compen**]

For the microstream CO₂ module, gas compensations are not required.

For the mainstream CO₂ module, in the [**CO2 Setup**] menu, respectively select:

- [**Balance Gas**] and toggle between [**Room Air**] and [**N2O**]. Select [**Room Air**] when air predominates in the ventilation gas mixture and select [**N2O**] when N₂O predominates in the ventilation gas mixture and select [**He**] when He predominates in the ventilation gas mixture.
- [**O2 Compen**] and then select [**Off**] or an appropriate setting according to the amount of O₂ in the ventilation gas mixture. When the amount of O₂ is less than 30%, you'd better switch this compensation off.
- [**AG Compen**] and enter the concentration of anesthetic gas present in the ventilation gas mixture. This could compensate for the effect of AG on the readings.

16.4.5 Setting up Humidity Compensation

Sidestream and microstream CO₂ modules are configured to compensate CO₂ readings for either Body Temperature and Pressure, Saturated Gas (BTPS), to account for humidity in the patient's breath, or Ambient Temperature and Pressure, Dry Gas (ATPD).

1. ATPD: $P_{CO_2}(mmHg) = CO_2(vol\%) \times P_{amb} / 100$
2. BTPS: $P_{CO_2}(mmHg) = CO_2(vol\%) \times (P_{amb} - 47) / 100$

Where, P_{CO_2} = partial pressure, $vol\%$ = CO₂ concentration, P_{amb} = ambient pressure, and unit is mmHg.

As the mainstream CO₂ module has a built-in heating component to prevent water vapour from condensing, setting humidity compensation is not needed. For the sidestream and microstream CO₂ module, you can set the humidity compensation on or off according to the actual condition. To set the humidity compensation:

1. In the [CO₂ Setup] menu, select [BTPS Compen].
2. Select either [On] for BTPS or [Off] for ATPD, depending on which compensation applies.

16.4.6 Setting the Apnea Alarm Delay

In the [CO₂ Setup] menu, select [Apnea Delay] and then select the appropriate setting. The monitor will alarm if the patient has stopped breathing for longer than the preset apnea time. The [Apnea Delay] of Resp, CO₂, AG, and RM module keeps consistent with each other.

WARNING

- **The respiration measurement does not recognize the cause of apneas. It only indicates an alarm if no breath is detected when a pre-adjusted time has elapsed since the last detected breath. Therefore, it cannot be used for diagnostic purpose.**
-

16.4.7 Choosing a Time Interval for Peak-Picking

For microstream and mainstream CO₂ modules, you can select a time interval for picking the highest CO₂ as the EtCO₂ and the lowest as the FiCO₂.

In the [CO₂ Setup] menu, select [Max Hold] and toggle between [Single Breath], [10 s], [20 s] and [30 s].

- [Single Breath]: EtCO₂ and FiCO₂ are calculated for every breath.
- [10 s] or [20 s]: EtCO₂ and FiCO₂ are calculated using 10, 20 or 30 seconds of data.

16.4.8 Setting the Flow Rate

For the sidestream CO₂ module, you can change the sampling rate of respiratory gas in the patient's airway by setting the flow rate. To set the flow rate, enter the [CO₂ Setup] menu and select an appropriate setting from [Flow Rate].

WARNING

- Please consider the patient's actual bearing capability and select the appropriate flow rate when setting the flow rate.
-

16.4.9 Setting up the CO₂ Wave

In the [CO₂ Setup] menu, you can:

- Select [Wave Type] and toggle between [Draw] and [Fill]:
 - ◆ [Draw]: The CO₂ wave is displayed as a curved line.
 - ◆ [Fill]: The CO₂ wave is displayed as a filled area.
- Select [Sweep] and then select the appropriate setting. The faster the wave sweeps, the wider the wave is.
- Change the size of the CO₂ waveform by adjusting the wave [Scale].

16.4.10 Setting RR Source

To set RR source:

1. Enter the [CO₂ Setup] menu.
2. Select [RR Source] and then select a source or [Auto] from the dropdown list.

The [RR Source] settings of Resp, CO₂, AG and RM module are linked. For details, please refer to the section *Setting RR Source* of chapter *Resp*.

16.5 Setting Barometric Pressure Compensation

Both sidestream and microstream CO₂ modules have the function of automatic barometric pressure compensation (the system automatically measures the barometric pressure which the patient monitor is exposed to). However, the mainstream CO₂ module does not have such function. For the mainstream CO₂ module, the default barometric pressure is 760 mmHg. You must modify the barometric pressure based on the actual situation as follows:

1. Select [Main Menu]→[Maintenance >>]→[User Maintenance >>]→enter the required password→[Maintain CO₂ >>]→[Calibrate CO₂ >>].
2. Select [Barometric Pressure] and then enter the value of barometric pressure to which the patient monitor is exposed to.

WARNING

- **Be sure to set the barometric pressure properly before using the mainstream CO₂ module. Improper settings will result in erroneous CO₂ reading.**
-

16.6 Measurement Limitations

The following factors may influence the accuracy of measurement:

- Leaks or internal venting of sampled gas
- Mechanical shock
- Cyclic pressure up to 10 kPa (100 cmH₂O)
- Other sources of interference, if any

16.7 Troubleshooting the Sidestream CO₂ Sampling System

When the sampling system of the sidestream CO₂ module works incorrectly, check if the sampling line is kinked. If not, remove it from the watertrap. If the monitor gives a message indicating the airway still works incorrectly, it indicates that the watertrap must have been blocked, and you should replace with a new one. Otherwise, you can determine that the sampling line must have been blocked. Replace with a new sampling line.

16.8 Removing Exhaust Gases from the System

WARNING

- **Anesthetics: When using the Sidestream or Microstream CO₂ measurement on patients who are receiving or have recently received anesthetics, connect the outlet to a scavenging system, or to the anesthesia machine/ventilator, to avoid exposing medical staff to anesthetics.**
-

To remove the sample gas to a scavenging system, connect an exhaust tube to the gas outlet connector of the module.

16.9 Zeroing the Sensor

The zero calibration eliminates the effect of baseline drift during CO₂ measurement exerted on the readings and therefore maintains the accuracy of the CO₂ measurements.

16.9.1 For Sidestream and Microstream CO₂ Modules

For sidestream and microstream CO₂ modules, a zero calibration is carried out automatically when necessary. You can also start a manual zero calibration if necessary. To manually start a zero calibration, select [**Maintain CO₂ >>**] from the [**User Maintenance**] menu. Then select [**Calibrate CO₂ >>**]→[**Start Zero Cal.**]. Disconnecting the patient airway is not required when performing a zero calibration.

16.9.2 For Mainstream CO₂ Modules

For mainstream CO₂ modules, zero the sensor whenever:

- A new adapter is used;
- You reconnect the sensor to the module;
- You see the message [**CO₂ Zero Required**]. In this case, check the airway adapter for any blockage, e.g. mucus, etc. If a blockage is detected, clear or replace the adapter.

To zero the sensor, follow this procedure:

1. Connect the sensor to the module.
2. In the [**CO₂ Setup**] menu, set the [**Operating Mode**] to [**Measure**]. The message [**CO₂ Sensor Warmup**] is displayed.
3. After warm-up is finished, connect the sensor to a clean, dry airway adapter. The adapter should be vented to the air and isolated from CO₂ sources, such as ventilator, the patient's breathing, your own breathing, etc.
4. Select [**Start Zero Cal.**] in the [**CO₂ Setup**] menu. The message [**CO₂ Zero Running**] is displayed.
5. It takes about 15 to 20 seconds. The message disappears when the zero calibration is completed.

WARNING

- **When perform a zero calibration during the measurement, disconnect the transducer from the patient's airway first.**
-

16.10 Calibrating the Sensor

For sidestream or microstream CO₂ modules, a calibration should be performed once every year or when the readings go far beyond the range. For mainstream CO₂ modules, no calibration is required. For details, refer to the chapter *29 Maintenance*.

16.11 Oridion Information

Microstream

This trademark is registered in Israel, Japan, German and America.

Oridion Patents

This device and the CO₂ sampling consumables designed for use herewith is covered by one or more of the following USA patents: 4,755,675; 5,300,859; 5,657,750; 5,857,461 and international equivalents. USA and international patents pending.

No Implied License

Possession or purchase of this device does not convey any express or implied license to use the device with unauthorized CO₂ sampling consumables which would, alone, or in combination with this device, fall within the scope of one or more of the patents relating to this device and/or CO₂ sampling consumable.

FOR YOUR NOTES

17 Monitoring AG

17.1 Introduction

The anaesthetic gas (AG) module measures the patient's anesthetic and respiratory gases, and incorporates the features of the O₂ module and BIS module as well.

The AG module determines the concentration of certain gases using the infrared (IR) light absorption measurement. The gases that can be measured by the AG module absorb IR light. Each gas has its own absorption characteristic. The gas is transported into a sample cell, and an optical IR filter selects a specific band of IR light to pass through the gas. For multiple gas measurement, there are multiple IR filters. The higher the concentration of gas in a given volume the more IR light is absorbed. This means that higher concentration of IR absorbing gas cause a lower transmission of IR light. The amount of IR light transmitted after it has been passed through an IR absorbing gas is measured. From the amount of IR light measured, the concentration of gas present can be calculated.

Oxygen does not absorb IR light as other breathing gases and is therefore measured relying on its paramagnetic properties. Inside the O₂ sensor are two nitrogen-filled glass spheres mounted on a strong rare metal taut-band suspension. This assembly is suspended in a symmetrical non-uniform magnetic field. In the presence of paramagnetic oxygen, the glass spheres are pushed further away from the strongest part of the magnetic field. The strength of the torque acting on the suspension is proportional to the oxygen concentration. From the strength of the torque, the concentration of oxygen is calculated.

17.2 Identifying AG Modules

AG module can identify two anesthetic gases in a mixture automatically and distinguish between them according to their contributions to the MAC value for display as the primary and secondary anesthetic agent.

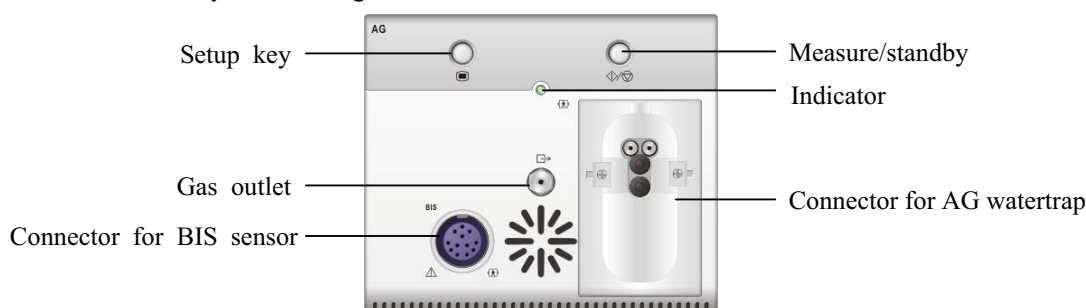

For details on BIS, refer to the chapter *19 Monitoring BIS*.

NOTE

- The AG module is configured with automatic barometric pressure compensation function.
-

17.3 Understanding the AG Display

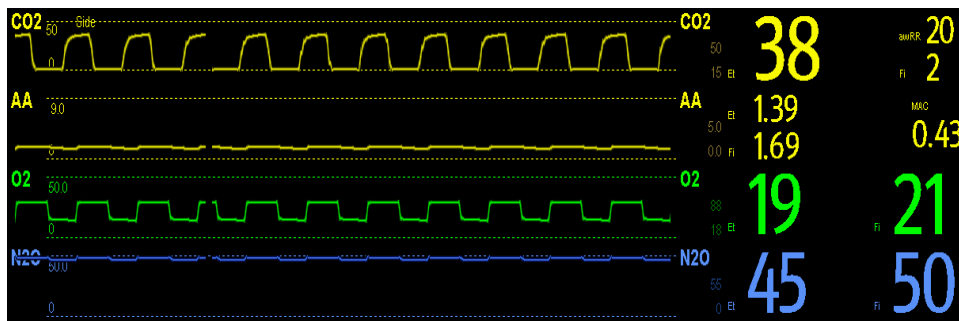

Gas	N2O %	O2 %	AA %	MAC
Et	45	19	1.39	0.43
Fi	50	21	1.69	

The AG module can send waves and numerics for all measured anesthetic gases for display on the monitor, including:

- CO₂, O₂, N₂O and AA waves
- awRR: airway respiratory rate
- MAC: minimum alveolar concentration
- End tidal (Et) and fraction of inspired (Fi) numerics for CO₂, O₂, N₂O and AA

Where AA represents Des (desflurane), Iso (isoflurane), Enf (enflurane), Sev (sevoflurane), or Hal (halothane).

The AA waveform area displays the primary anesthetic gas's waveform. When O₂ module does not exist, no O₂ waveform will be displayed. When O₂ module exists, the O₂ waveform will be displayed only when the O₂ waveform is currently switched on.

WARNING

- To avoid explosion hazard, do not use flammable anesthetic agent such as ether and cyclopropane for this equipment.
-

17.4 MAC Values

Minimum alveolar concentration (MAC) is the minimum concentration of the agent in the alveoli. It is a basic index to indicate the depth of anesthesia. The standard ISO 21647 defines MAC as this: alveolar concentration of an inhaled anesthetic agent that, in the absence of other anesthetic agents and at equilibrium, prevents 50% of patients from moving in response to a standard surgical stimulus.

Minimum alveolar concentration (MAC) values are listed below:

Agent	Des	Iso	Enf	Sev	Hal	N2O
1 MAC	7.3%*	1.15%	1.7%	2.1%	0.77%	105%**

* The data is taken from a patient of 25 years old.

** indicates 1 MAC nitrous oxide can only be reached in hyperbaric chamber.

NOTE

- **The MAC values shown in the table above are those published by the U.S. Food and Drug Administration for a healthy 40-year-old adult male patient.**
- **In actual applications, the MAC value may be affected by age, weight and other factors.**

The formula to calculate the MAC value is as follows:

$$MAC = \sum_{i=0}^{N-1} \frac{EtAgent_i}{AgentVol_i}$$

Where N is the number of all agents (including N₂O) that the AG module can measure, EtAgent_i is the concentration of each agent and AgentVol_i is the concentration of each agent at 1 MAC.

For example, the AG module measures there are 4% of Des, 0.5% of Hal and 50% of N₂O in the patient's end-tidal gas:

$$MAC = \frac{4.0\%}{7.3\%} + \frac{0.5\%}{0.77\%} + \frac{50\%}{105\%} = 1.67$$

NOTE

- **The formula mentioned above is intended for adult patients only.**

17.5 Preparing to Measure AG

1. Select an appropriate watertrap according to patient category and attach it to the module.
2. Connect the gas sample line to the connector of the watertrap.
3. Connect the other end of the gas sampling line to the patient via the airway adapter.
4. Connect the gas outlet to a scavenging system using an exhaust tube.

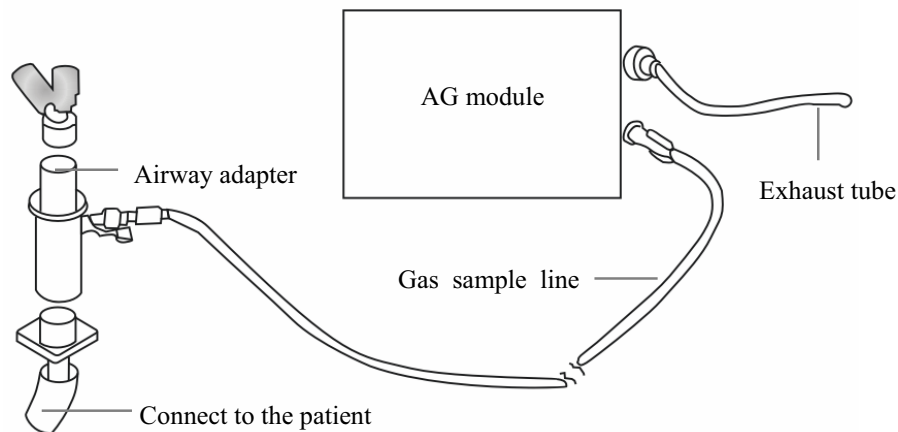

5. Insert the AG module into the SMR or the patient monitor and the patient monitor will prompt [**AG Startup**]. Within 10 minutes after startup is finished, the AG module enters the iso accuracy mode. After that, the module enters the full accuracy mode.

CAUTION

- **Position the airway adapter so that the part connecting to the gas sample line is pointing upwards. This prevents condensed water from passing into the gas sample line and causing an occlusion.**
 - **The watertrap collects water drops condensed in the sampling line and therefore prevents them from entering the module. If the collected water reaches to a certain amount, you should drain it to avoid blocking the airway.**
 - **The watertrap has a filter preventing bacterium, water and secretions from entering the module. After a long-term use, dust or other substances may compromise the performance of the filter or even block the airway. In this case, replace the watertrap. Replacing the watertrap once a month is recommended.**
-

 **WARNING**

- **Make sure that the connections are tight. Any leak in the system can result in erroneous readings due to ambient air mixing with patient gases.**
 - **Do not apply adult watertrap to the neonate patient. Otherwise, patient injury could result.**
 - **Using high-frequency electrosurgical units may increase the risk of skin burn. In this case, do not use antistatic or conductive respiratory tubing.**
-

17.6 Changing AG Settings

17.6.1 Setting Gas Unit

For N₂O and AA, the unit of the measured gas is fixed to “%”.

Select [Unit Setup >>] from the [User Maintenance] menu. In the popup menu, you can select [CO₂ Unit] or [O₂ Unit] and toggle between [mmHg], [%] and [kPa].

17.6.2 Setting the Apnea Alarm Delay

In the [AG Setup] menu, select [Apnea Delay] and select the appropriate setting. The monitor will alarm if the patient has stopped breathing for longer than the preset apnea time. The [Apnea Delay] of Resp, CO₂, AG, and RM module keeps consistent with each other.

 **WARNING**

- **The respiration measurement does not recognize the cause of apneas. It only indicates an alarm if no breath is detected when a pre-adjusted time has elapsed since the last detected breath. Therefore, it cannot be used for diagnostic purpose.**
-
-

17.6.3 Changing the Sample Flow Rate

In the setup menu for any gas, select [**Flow Rate**] and then choose either:

- [**High**]: 200 ml/min for adult and pediatric patients, and 120 ml/min for neonatal patients.
- [**Med**]: 150 ml/min for adult and pediatric patients, and 90 ml/min for neonatal patients.
- [**Low**]: 120 ml/min for adult and pediatric patients, and 70 ml/min for neonatal patients.

17.6.4 Setting up the O₂ Compensation

If the AG module does not incorporate the O₂ module, you need to manually select [**O₂ Compens**] and then select [**Off**] or an appropriate setting according to the amount of O₂ in the ventilation gas mixture. When the amount of O₂ is less than 30%, you'd better switch this compensation off.

If the AG module incorporates the O₂ module, the system will directly use the O₂ concentration detected by the O₂ module to make compensation. At this time, the [**O₂ Compens**] in the setup menu for any gas is fixed to [**Off**].

17.6.5 Entering the Standby Mode

For the AG module, the default operating mode is measure. When you set the AG module to the standby mode, the AG gas sample intake pump automatically sets the sample flow rate to zero. When exiting the standby mode, the AG module continues to work at preset sample flow rate with no need to warm up again. After nearly 1 minute, the module enters the full accuracy mode. The standby mode of the AG module relates to the standby mode of the monitor as follows:

- If the monitor enters the standby mode, the AG module will also enter the standby mode.
- If the monitor exits the standby mode, the AG module will also exit the standby mode.
- If the AG module enters or exits the standby mode, it will not affect the monitor.

To enter or exit the standby mode manually, in the agent's setup menu, select [**Operating Mode**] and then toggle between [**Standby**] and [**Measure**]. You can also set a period of time after which the AG module enters the standby mode automatically if no breath is detected since the last detected breath. To set the standby time, in the agent's setup menu, select [**Auto Standby (min)**] and then select the appropriate setting.

17.6.6 Setting up the AG Wave

In the [AG Setup] menu, you can:

- Select [CO₂ Wave Type] and toggle between [Draw] and [Fill]:
 - ◆ [Draw]: The CO₂ wave is displayed as a curved line.
 - ◆ [Fill]: The CO₂ wave is displayed as a filled area.
- Select [Sweep] and then select the appropriate setting. The faster the wave sweeps, the wider the wave is.
- Change the size of the waveform by adjusting the scale.

17.6.7 Setting RR Source

To set RR source:

1. Enter the [AG Setup] menu.
2. Select [RR Source] and then select a source or [Auto] from the dropdown list.

The [RR Source] settings of Resp, CO₂, AG and RM module are linked. For details, please refer to the section *Setting RR Source* of chapter *Resp*.

17.7 Changing the Anesthetic Agent

When the anesthetic agent used on the patient is changed, the AG module can detect the mixed anesthetic gas during the transition of two anesthetic agents. The time required for completing the replacement of anesthetic agent depends on anesthesia type (low flow or high flow) and the characteristics of anesthetic agents (pharmacokinetics). During the transition of two anesthetic agents, the patient monitor gives no prompt messages and the MAC value displayed may be inaccurate.

The AG module can identify two anesthetic agents automatically. When the proportion of the primary and secondary anesthetic agents in the mixture changes, the AG module can distinguish between them according to their contributions to the MAC value. Then the primary and secondary anesthetic agents will be exchanged for display.

17.8 Measurement Limitations

The following factors may influence the accuracy of measurement:

- Leaks or internal venting of sampled gas
- Mechanical shock
- Cyclic pressure up to 10 kPa (100 cmH₂O)

-
- Other sources of interference, if any

17.9 Troubleshooting

17.9.1 When the Gas Inlet is Blocked

If the gas inlet (including watertrap, sampling line and airway adapter) is occluded by condensed water, the message **[AG Airway Occluded]** will appear.

To remove the occlusion:

- Check the airway adapter for an occlusion and replace if necessary.
- Check the sampling line for an occlusion or kinking and replace if necessary.
- Check the watertrap for a build up of water. Empty the watertrap. If the problem persists, replace the watertrap.

17.9.2 When an Internal Occlusion Occurs

Condensed water may enter the module and cause contamination and/or internal occlusions. In this case, the message **[AG Airway Occluded]** will be displayed.

To remove the occlusion:

- Check for any occlusion in the gas inlet and/or outlet system.
- If the problem persists, internal occlusions may exist. Contact your service personnel.

17.10 Removing Exhaust Gases from the System

WARNING

- **Anesthetics: When using the AG measurement on patients who are receiving or have recently received anesthetics, connect the outlet to a scavenging system, or to the anesthesia machine/ventilator, to avoid exposing medical staff to anesthetics.**
-

To remove the sample gas to a scavenging system, connect an exhaust tube to the gas outlet connector of the module.

18 Monitoring ICG

18.1 Introduction

Impedance cardiography (ICG) measures a patient's hemodynamic status using a safe, non-invasive method based on thoracic electrical bioimpedance (TEB) technology. ICG uses four pairs of sensors to transmit a small electrical signal through the thorax. As velocity and volume of blood in the aorta change, the ICG measures the changes in impedance from systole to diastole to calculate hemodynamic parameters.

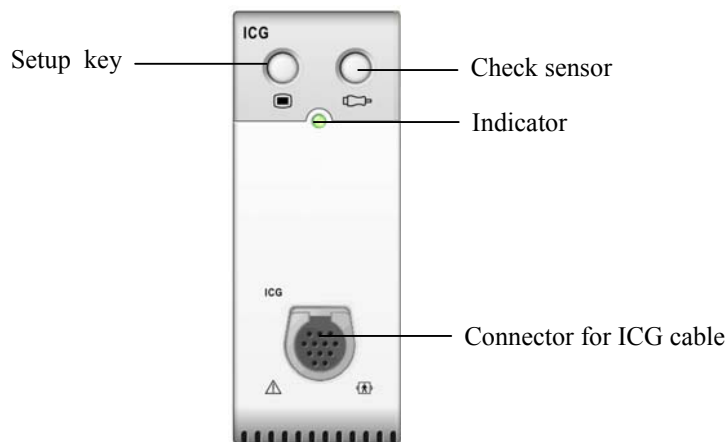

18.2 Safety

WARNING

- **Apply ICG monitoring to adult patients in height of 122 to 229 cm, weight of 30 to 159 kg (67 to 341 pounds) only.**
 - **ICG monitoring should not be used concurrently on patients with minute ventilation pacemakers when the MV sensor function is activated.**
 - **During ICG monitoring, make sure that the conductive paste on the ICG sensors never come into contact with other conductive parts.**
 - **ICG sensors are for single patient use only.**
-

18.3 Understanding ICG Parameters

By selecting the ICG parameter window→[ICG Setup]→[Hemodynamic Parameters >>], you can view the hemodynamic parameters for evaluation of the patient's hemodynamic status.

18.3.1 Measured Parameters

Abbreviation	Unit	Full spelling
ACI	/100s ²	acceleration index
VI	/1000s	velocity index
PEP	ms	Pre-ejection period
LVET	ms	Left ventricular ejection time
TFI	Ω	Thoracic fluid index
TFC	/kΩ	thoracic fluid content
HR*	bpm	heart rate

*The HR value is directly derived from the ICG module.

18.3.2 Calculated Parameters

Abbreviation	Unit	Full spelling
BSA	m ²	Body surface area
C.O.	L/min	Cardiac output
C.I.	L/min/m ²	Cardiac index
SV	ml	Stroke volume
SVI	ml/m ²	Stroke volume index
SVR	DS/cm ⁵	Systemic vascular resistance
SVRI	DS·m ² /cm ⁵	Systemic vascular resistance index
PVR	DS/cm ⁵	Pulmonary vascular resistance
PVRI	DS·m ² /cm ⁵	Pulmonary vascular resistance index
LCW	kg·m	Left cardiac work
LCWI	kg·m/m ²	Left cardiac work index
LVSW	g·m	Left ventricular stroke work
LVSWI	g·m/m ²	Left ventricular stroke work index
STR	none	Systolic time ratio
VEPT	ml	Volume of electrically participating tissue

18.4 Understanding the ICG Display

The ICG monitoring provides a continuous display of the impedance waveform and four numerics. Of four numerics, one is the primary parameter C.I. and the other three are secondary parameters. The secondary parameters are user-selectable, and C.O., SVR and TFC are the defaults.

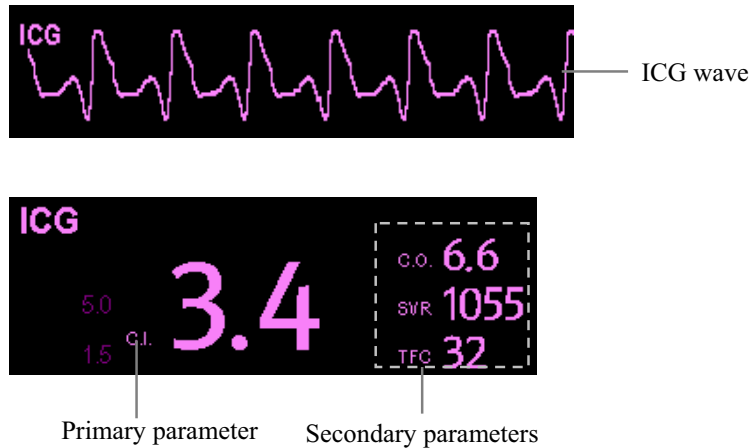

By selecting the ICG waveform area or ICG parameter window, you can access the [ICG Setup] menu.

18.5 ICG Limitations

The measurement accuracy may be compromised when patients present with the following conditions or anomalies:

- Septic shock.
- Aortic valve regurgitation.
- Severe hypertension (Art mean > 130 mmHg).
- The patient's weight and height are out of range.
- Connection to an intra-aortic balloon pump.
- With excessive and continuous patient movements such as shivering.
- Signal interference from cable connections and/or power cords.
- Open-chest surgeries that could result in changes in the normal pattern of blood flow and/or the electrical current through the chest cavity.

18.6 Preparing to Monitor ICG

1. Insert the ICG module into the monitor.
2. Connect the patient cable to the ICG module.
3. Prepare the patient's skin and place ICG sensors on the patient.
4. Connect the ICG sensor connector end to the patient cable lead wires.
5. Enter the patient information.

18.6.1 Preparing the Patient

Proper skin preparation is necessary for good signal quality at the sensor, as the skin is a poor conductor of electricity. To properly prepare the skin, choose flat, non-muscular areas and then follow this procedure:

1. Shave hair from skin at chosen sites.
2. Gently rub skin surface with a gauze pad at sites to remove dead skin cells.
3. Thoroughly cleanse the site with a mild soap and water solution. Be sure to remove all oily residue, dead skin cells, and abrasives. Leftover abrasion particles can be a source of noise.
4. Dry the skin completely before applying the sensor.

18.6.2 Placing ICG Sensors

Appropriate sensor placement is important for good signal quality and accurate measurements. Attach ICG sensors to the patient as shown below:

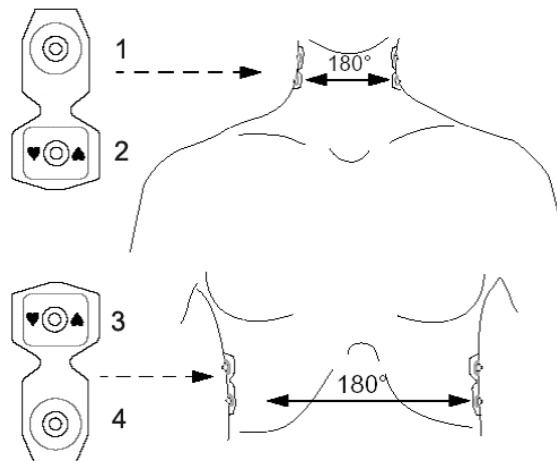

-
1. Two neck sensors placed on each side of the neck, with the rectangular shaped end of the sensor (2) placed at the base (or root) of the neck and the circular shaped end of the sensor (1) placed directly superior and in line with the earlobe.
 2. Two thorax sensors placed on each side of the thorax, with the rectangular shaped end of the sensor (3) at the level with the xyphoid process and the circular shaped end of the sensor (4) directly inferior and in line with the midaxillary line. Each pair of sensors should be opposite directly to each other (180°) as shown in the figure above.

18.6.3 Setting up the Patient Information

1. Enter the [**ICG Setup**] menu.
2. Select [**Patient Demographics >>**].
3. Select [**Height**] and [**Weight**] and then select the appropriate settings. The patient's height and weight are important for ICG monitoring. The system will automatically check them when an ICG module is connected. If no values are entered or the entered values do not meet the requirements, corresponding prompt messages will be given in the ICG parameter window.
4. If the mean arterial blood pressure (Art mean) is not obtained automatically from either IBP or NIBP module, then enter Art mean. Enter CVP and PAWP, obtained from invasive catheters or enter an assumed value. (Note: CVP and PAWP are used only in the calculation of SVR, SVRI, LCW, LCWI, LVSW, and LVSWI and the value of CVP and PAWP do not normally have a significant effect on the calculated parameters.)

18.7 Changing ICG Settings

18.7.1 ICG Averaging

The ICG value is the average of multiple measurements. You can select an interval (heart beats) for averaging ICG, ranging from 5-60 beats.

1. Enter the [**ICG Setup**] menu.
2. Select [**Averaging**] and then select the appropriate setting. The greater the averaging interval is, the less the ICG value is affected by human interference and vice versa.

18.7.2 Selecting Secondary Parameters

C.O., SVR and TFC are the default three secondary parameters. You can also select your desired secondary parameter for display.

1. Enter the [**ICG Setup**] menu.
2. Select [**Change Secondary Parameters >>**].
3. Select three parameters from the popup menu.

18.7.3 Checking Sensors

During ICG monitoring, the ICG sensors should be checked regularly to ensure that no sensor becomes disconnected. During sensor checking, the ICG waveform is displayed as a straight line and the message [**ICG Sensor Check**] is displayed. Once a disconnected sensor is detected, a prompt message in which the sensor's application site is indicated will be displayed.

To initiate a sensor check:

- In the [**ICG Setup**] menu, select [**Check Sensor**].
- Press the  hardkey.

18.7.4 Changing the ICG Wave Speed

1. Enter the [**ICG Setup**] menu.
2. Select [**Sweep**] and then select the appropriate setting. The faster the wave sweeps, the wider the wave is.

19 Monitoring BIS

19.1 Introduction

Bispectral index (BIS) monitoring is for use on adult and pediatric patients within a hospital or medial facility providing patient care to monitor the state of the brain by data acquisition of EEG signals.

The BIS, a processed EEG variable, may be used as an aid in monitoring the effects of certain anesthetic agents. Use of BIS monitoring to help guide anesthetic administration may be associated with the reduction of the incidence of awareness with recall during general anesthesia or sedation.

The BISx equipment must be used under the direct supervision of a licensed healthcare practitioner or by personnel trained in its proper use.

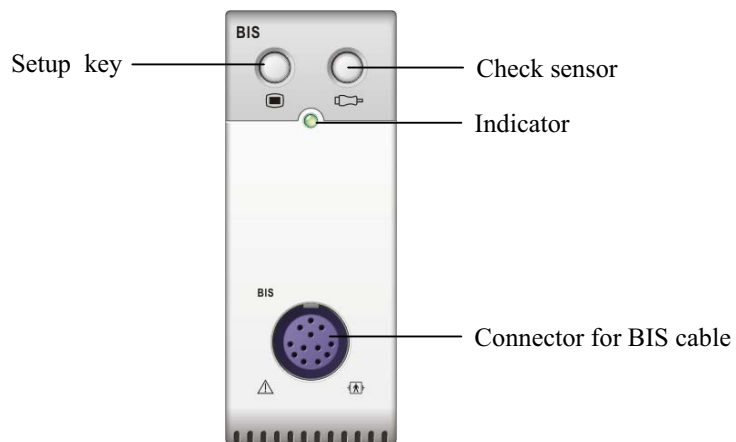

19.2 Safety Information

For patients with neurological disorders, patients taking psychoactive medication, and children below the age of 1 year, BIS values should be interpreted cautiously.

WARNING

- **The conductive parts of sensors and connectors should not come into contact with other conductive parts, including earth.**
 - **To reduce the hazard of burns in the high-frequency surgical neutral electrode connection, the BIS sensor should not be located between the surgical site and the electro-surgical unit return electrode.**
 - **The BIS sensor must not be located between defibrillator pads when a defibrillator is used on a patient connected to the patient monitor.**
 - **The BIS component using on our monitor is purchased from Aspect Medical System. It is important to recognize this index is derived using solely that company's proprietary technology. Therefore, it is recommended that clinicians have reviewed applicable information on its utility and/or risks in published articles and literature/web site information from Aspect Medical Systems, Inc. or contact that company itself at www.aspectmedical.com, if you have clinical-based BIS questions relating to this module portion of the patient monitor. Failure to do so could potentially result in the incorrect administration of anesthetic agents and/or other potential complications of anesthesia or sedation. We recommend that clinicians also review the following practice advisory (that includes a section on BIS monitoring): The American Society of Anesthesiologists, Practice Advisory for Intraoperative Awareness and Brain Function Monitoring (Anesthesiology 2006;104:847-64). Clinicians are also recommended to maintain current knowledge of FDA or other federal-based regulatory, practice or research information on BIS and related topics.**
 - **The Bispectral Index is a complex technology, intended for use only as an adjunct to clinical judgment and training.**
 - **The clinical utility, risk/benefit and application of the BIS component have not undergone full evaluation in the pediatric population.**
-

19.3 Understanding the BIS Display

19.3.1 BIS Parameter Area

The BIS parameter area displays the following parameters:



1. Bispectral Index (BIS)

The BIS numeric reflects the patient's level of consciousness. It ranges from 100 for wide awake to 0 in the absence of brain activity.

BIS numeric	Description
100	The patient is widely awake.
70	The patient is underdosed but still unlikely to become aware.
60	The patient is under general anesthesia and loses consciousness.
40	The patient is overdosed and in deep hypnosis.
0	The EEG waveform is displayed as a flat line, and the patient has no electrical brain activity.

2. Electromyograph (EMG)

EMG bar graph reflects the electrical power of muscle activity and high frequency artifacts. The minimum possible EMG is about 25 dB.

- ◆ EMG < 55 dB: this is an acceptable ECG.
- ◆ EMG ≤ 30 dB: this is an optimal EMG.

3. Suppression Ratio (SR)

SR numeric is the percentage of time over the last 63-second period during which the EEG is considered to be in a suppressed state.

4. Spectral Edge Frequency (SEF)

The SEF is a frequency below which 95% of the total power is measured.

5. Signal Quality Index (SQI)

The SQI numeric reflects signal quality and provides information about the reliability of the BIS, SEF, TP, and SR numerics during the last minute. It ranges from 0-100%:

- ◆ 0 to 15%: the numerics cannot be derived.
- ◆ 15% to 50%: the numerics cannot be reliably derived.
- ◆ 50% to 100%: the numerics are reliable.

6. Total Power (TP)

TP numeric which only monitors the state of the brain indicates the power in the frequency band 0.5-30Hz. The useful range is 40-100db.

7. Burst Count (BC)

A burst means a period (at least 0.5 second) of EEG activity followed and preceded by inactivity. The BC numeric helps you quantify suppression by measuring the number of EEG bursts per minute. This parameter is intended for the BIS module with the Extend Sensor only.

19.3.2 BIS Waveform Area

The BIS waveform area allows you to view either BIS EEG waveform or BIS trend.

1. Enter the [BIS Setup] menu.
2. Select [BIS Display] and then toggle between [BIS EEG] and [BIS Trend].

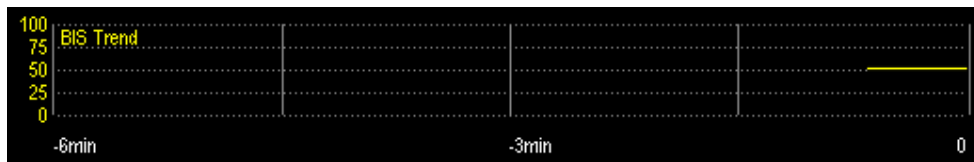
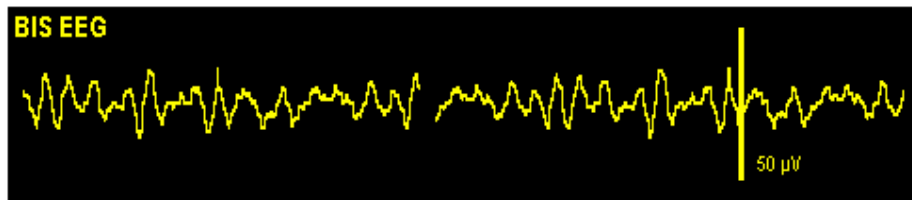

19.4 Setting up the BIS Measurement

1. Connect the BISx model to the BIS module.

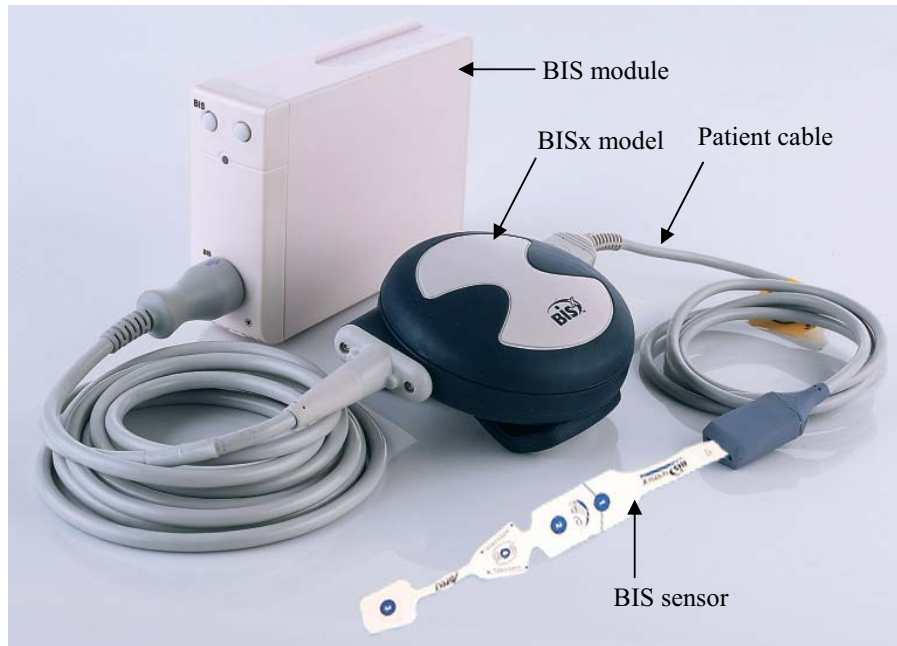

2. Use the attachment clip to secure the BISx model near, but not above the level of the patient's head.
3. Connect the BISx model to the patient cable.
4. Attach the BIS sensor to the patient following the instructions supplied with sensor.

NOTE

-
- **Make sure the patient's skin is dry. A wet sensor or a salt bridge could result in erroneous BIS and impedance values.**
-

5. Connect the BIS sensor to the patient interface cable. As soon as a valid sensor is detected, the impedances of all electrodes are measured automatically and the impedance value for each electrode is displayed in the sensor check window.

CAUTION

- **Do not attach the BISx model to the patient's skin for long time. Otherwise, the BISx heats while on the patient and may cause discomfort.**
-

19.5 Continuous Impedance Check

By default, this check is switched on. It checks:

- The combined impedance of the signal electrodes plus the reference electrode. This is done continuously and does not affect the EEG wave. As long as the impedances are within the valid range, there is no prompt message of this check or its results.
- The impedance of the ground electrode. This is done every ten minutes and takes approximately four seconds. It causes an artifact in the EEG wave, and the message **[BIS Ground Checking]** is displayed on the monitor during the check. If the ground electrode does not pass this check, another check is initiated. This continues until the ground electrode passes the check.

If the continuous impedance check interferes with other measurements, it can be switched off. To do this:



1. Select **[Sensor Check >>]** in the **[BIS Setup]** menu to open the sensor check window.
2. Select **[Stop Cont. Imped.Check]**.

CAUTION

- **Switching the continuous impedance check off will disable automatic prompt to the user of impedance value changes, which may lead to incorrect BIS values. Therefore, this should only be done if the check interferes with or disturbs other measurements.**
-

19.6 Cyclic Impedance Check

This measures the exact impedance of each individual electrode. It causes a disturbed EEG wave, and a prompt message is displayed on the monitor

- The cyclic impedance check is automatically initiated when a sensor is connected. To manually start a cyclic impedance check manually, you can either:
 - ◆ Press the  hardkey on the BIS module.
 - ◆ Select **[Start Sensor Check]** in the BIS sensor window.
- The cyclic impedance check stops automatically if the impedances of all electrodes are within the valid range. To manually stop a cyclic impedance check, you can either:
 - ◆ Press the  hardkey on the BIS module.
 - ◆ Select **[Stop Sensor Check]** in the sensor check window.

19.7 BIS Sensor Check Window

To open the sensor check window, select [**Sensor Check >>**] in the [**BIS Setup**] menu. The graphic in the BIS sensor check window automatically adapts to show the type of sensor you are using, show three or four electrodes as required. Each symbol in the graphic represents an electrode and illustrates the most recently-measured impedance status of the electrodes: ① is the reference electrode; ② the ground electrode; ③ and ④ are signal electrodes.

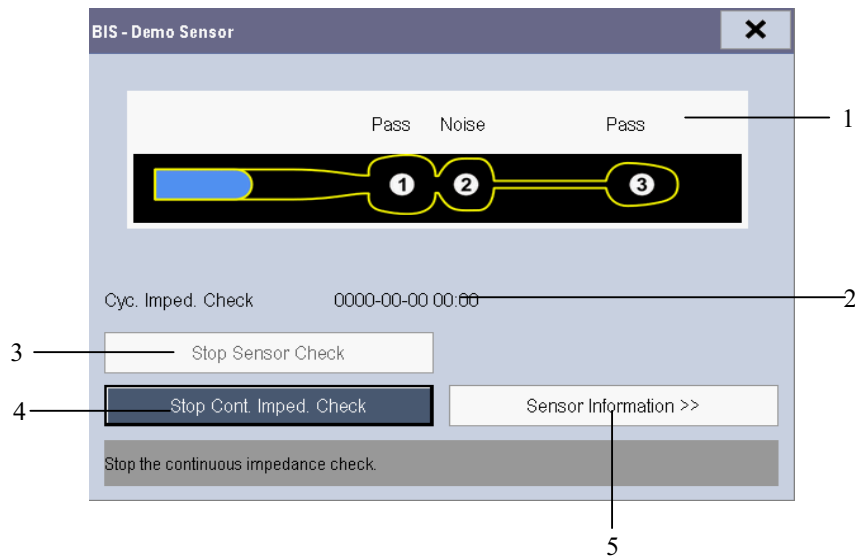

1. Electrode impedance check result
2. Time of the most recent impedance check
3. Start/stop cyclic impedance checks
4. Start/stop Cont. Imped. Check
5. Show sensor information

The measured electrode-to-skin impedance and electrode status are displayed above each electrode:

Status	Description	Action
[Lead Off]	Electrode falls off and has no skin contact	Reconnect electrode, or check the sensor-to-skin contact. If necessary, clean and dry skin.
[Noise]	The EEG signal is too noisy. Impedance cannot be measured	Check the sensor-to-skin contact. If necessary, clean and dry skin.
[High]	The impedance is above the limit	
[Pass]	The impedance is within valid range	No action necessary.

Although BIS may still be measured when the electrode status is [**Noise**] or [**High**], for best performance, all electrodes should be in [**Pass**] status.

19.8 Choosing the BIS Smoothing Rate

To change the smoothing rate:

1. Select the BIS parameter window to enter the **[BIS Setup]** menu.
2. Select **[Smoothing Rate]** and then toggle between **[10 s]**, **[15 s]** and **[30 s]**

The smoothing rate defines how the monitor averages the BIS value. With the smoothing rate becoming smaller, the monitor provides increased response to changes in the patient's state. Contrarily, the monitor provides a smoother BIS trend with decreased variability and sensitivity to artifacts.

19.9 Changing the Secondary Parameters

If you connect an extend sensor to the BIS module, you can choose at most 4 secondary parameters for display on the screen.

1. Enter the **[BIS Setup]** menu.
2. Select **[Change Secondary Parameter>>]** and then select your desired parameters from the popup menu.

19.10 Changing the EEG Wave Size

1. Enter the **[BIS Setup]** menu.
2. Select **[BIS EEG]** from **[BIS Display]**.
3. Select **[Scale]** and then select the appropriate setting.

19.11 Changing the Speed of the EEG Wave

1. Enter the **[BIS Setup]** menu.
2. Select **[BIS EEG]** from **[BIS Display]**.
3. Select **[Sweep]** and then select the appropriate setting. The faster the wave sweeps, the wider the wave is.

19.12 Setting the Trend Length

1. Enter the **[BIS Setup]** menu.
2. Select **[BIS EEG]** from **[BIS Display]**.
3. Select **[BIS Length]** and then select the appropriate BIS time length setting.

20 Monitoring RM

20.1 Introduction

 **WARNING**

- **RM monitoring is not intended for neonatal patients.**
-

In the respiratory mechanics measurement, the airway pressures are measured, from the part between the patient circuit and intubation tube, using a flow sensor between the Y-piece of patient circuit and the patient connection. The pressure is transferred to the monitor through the tube and measured by a pressure transducer in the RM module. The pressure difference together with the gas concentration information is used to calculate flow. The volume information is obtained by integrating the flow signal. From these three parameter, other parameter such as RR, I:E, Compl, etc. are derived.

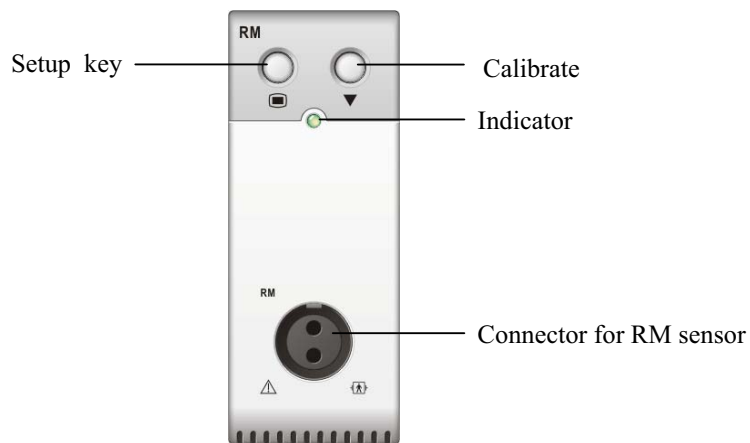

The RM monitoring enables clinicians to understand the ventilator operation and patient respiratory status.

RM monitoring displays the following waveforms and loops:

- Flow waveform
- Paw waveform
- Vol waveform
- FV (flow-volume) loop
- PV (paw-volume) loop

RM monitoring provides values for 15 parameters. The 15 parameters can be classified into 4 categories:

1. Paw parameters

- ◆ PIP: peak inspiratory pressure (unit: cmH₂O)
- ◆ Pplat: plateau pressure (unit:cmH₂O)
- ◆ PEEP: positive end expiratory pressure (unit: cmH₂O)
- ◆ Pmean: mean pressure (unit: cmH₂O)

2. Flow parameters

- ◆ PIF: peak inspiratory flow (unit: L/min)
- ◆ PEF: peak expiratory flow (unit: L/min)

3. Vol parameters

- ◆ TVi: inspiratory tidal volume (unit: ml)
- ◆ TVe: expiratory tidal volume (unit: ml)
- ◆ MVi: inspirator minute volume (L)
- ◆ MVe: expiratory minute volume (L)

4. Other parameters

- ◆ RR: respiratory rate (unit: rpm)
- ◆ I: E: ratio of the inspiratory and expiratory time
- ◆ Compl: compliance (unit: ml/cmH₂O)
- ◆ FEV1.0: first second forced expiratory volume ratio (unit: %)
- ◆ RSBI: rapid shallow breathing index (unit: rpm/L)

20.2 Safety Information

WARNING

- Check for leaks in the breathing circuit system, as they may significantly affect respiratory mechanics readings.
 - Match the airway adapter you select to the appropriate patient category. Improper sensor selection may produce excessive ventilation resistance or introduce excessive airway deadspace, as well as inaccurate scales and alarm limits.
 - Periodically check the flow sensor and tubing for excessive moisture or secretion build-up and purge if necessary.
-

NOTE

- To avoid the affects of excessive moisture in the measurement circuit, insert the flow sensor airway adapter in the breathing circuit with the tubes upright.
 - Do not place the airway adapter between the endotracheal tube and an elbow as this may allow patient secretions to block the adapter windows.
 - Measurement values provided by a ventilator may differ significantly from the values provided by the RM module, due to different locations of the flow sensor.
-

20.3 Preparing to Monitor RM

1. Select an appropriate flow sensor in accordance with the patient category.
2. Connect the small tubes of the flow sensor to the RM connector of the module using a color-coded adapter.
3. Insert the flow sensor between the Y-piece of the patient circuit and the patient connection.

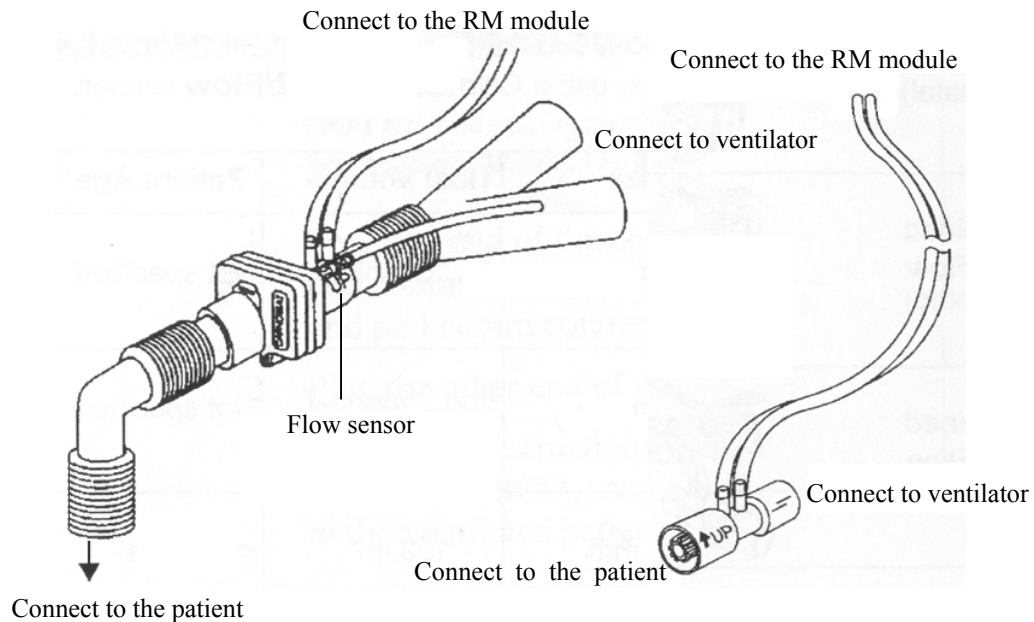

4. Calibrate the flow sensor: select the RM parameter window to open the [**Calibrate RM**] menu when you see the prompt message [**Calibration Required**] appears on the RM parameter window. Then calibrate the flow sensor according to the procedure described in *20.8 Calibrating the Flow Sensor*.
5. Select [**Sensor Type**] in the [**Calibrate RM**] menu and then choose [**Infant One-time**], [**Disposable**] or [**Reusable**] according to the selected sensor.

20.4 Understanding the RM Display

The RM display shows either the Paw and Flow waveforms, or the Paw and Vol waveforms in the waveform area.

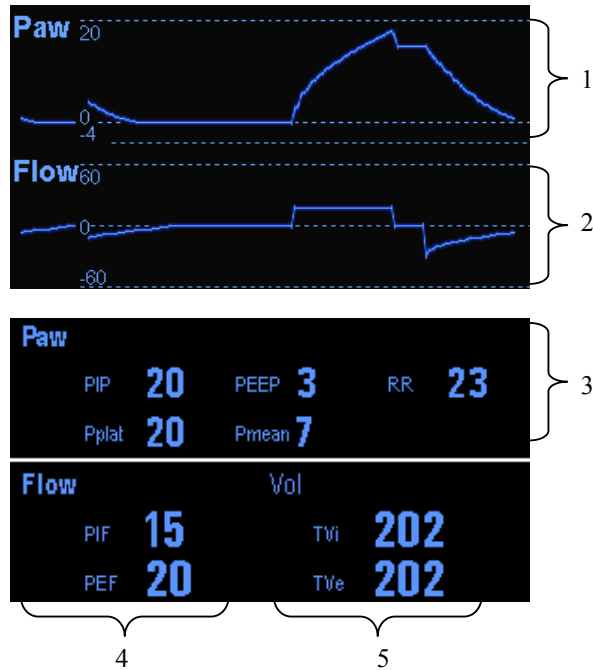

1. Paw waveform
2. Flow waveform
3. Paw parameter window
4. Flow parameter window
5. Vol parameter window

20.5 Changing RM Settings

20.5.1 Accessing RM Menus

- By selecting the RM parameter window or waveform area, you can access the **[RM Setup]** menu.
- By selecting the Paw wave, you can access the **[Paw Waveform]** menu.
- By selecting the Flow wave, you can access the **[Flow Waveform]** menu.
- By selecting the Vol wave, you can access the **[Vol Waveform]** menu.

20.5.2 Setting the Apnea Alarm Delay

In the **[RM Setup]** menu, select **[Apnea Delay]** and then select the appropriate setting. The monitor will alarm if the patient has stopped breathing for longer than the preset apnea time. The **[Apnea Delay]** of Resp, CO2, AG, and RM module keeps consistent with each other.

WARNING

- **The respiration measurement does not recognize the cause of apneas. It only indicates an alarm if no breath is detected when a pre-adjusted time has elapsed since the last detected breath. Therefore, it cannot be used for diagnostic purpose.**
-

20.5.3 Selecting TV or MV for Display

To select tidal volume (TV) or minute volume (MV) for display in the Vol parameter window, in the **[RM Setup]** menu, select **[TV/MV]** and toggle between **[TV]** and **[MV]**. By default, the Vol parameter window displays TV values.

20.5.4 Selecting Flow or Vol Waveform for Display

To select Flow or Vol waveform for display:

1. Enter the **[RM Setup]** menu.
2. Select **[Flow/Vol]** and toggle between **[Flow]** and **[Vol]**.

20.5.5 Changing the Wave Sweep Speed

1. Enter the [**RM Setup**] menu.
2. Select [**Sweep**] and select the appropriate setting. The faster the wave sweeps, the wider the wave is.

20.5.6 Changing the Wave Scale

1. Select [**Wave Scale >>**] from the [**RM Setup**] menu..
2. Select the appropriate settings in the popup menu.

20.5.7 Setting RR Source

To set RR source:

1. Enter the [**RM Setup**] menu.
2. Select [**RR Source**] and then select a source or [**Auto**] from the dropdown list.

The [**RR Source**] settings of Resp, CO2, AG and RM module are linked. For details, please refer to the section *Setting RR Source* of chapter *Resp*.

20.6 Understanding the Respiratory Loops

Select [**Respiratory Loop**] in the [**RM Setup**] menu. The following window will be displayed.

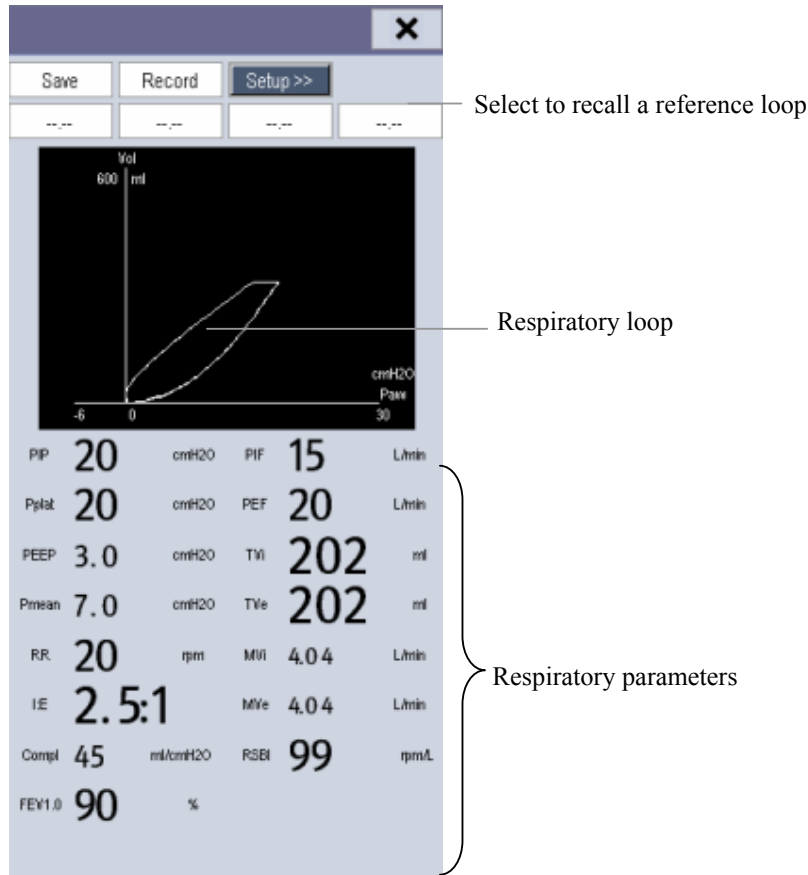

In this window, you can:

- Select [**Save**] to save the respiratory loops in the current respiratory cycle as the reference loops. Up to 4 groups of respiratory loops can be saved, and the saving time is displayed above the respiratory loops.
- Change the respiratory loops displayed on the screen: select [**Setup >>**]→[**Display Loop**] and then toggle between [**PV Loop**] and [**FV Loop**].
- Turn on/off reference loop: select [**Setup >>**]→[**Reference Loop**], and then toggle between [**On**] and [**Off**].
- Change the size of the PV and FV loops: select [**Setup >>**], and then adjust the [**Paw Scale**], [**Vol Scale**] or [**Flow Scale**].
- Select parameters for display: select [**Setup >>**]→[**Select RM Parameters >>**], and then select [**All RM Parameters**] or [**Select Desired RM Parameters**]. When you select [**Select Desired RM Parameters**], 6 parameters at maximum can be selected.

-
- Print out all parameters for a reference loop by selecting your desired reference loop and then selecting [**Record**].

20.7 Zeroing the RM Module

A zero calibration is carried out automatically every time when the patient monitor is switched on or the RM module connected, and then a zero calibration will automatically be triggered at a specific interval. Then, a zero calibration is triggered every 5 minutes. You can also start a manual zero calibration when there is a drift in the zero: in the [**RM Setup**] menu, select [**Zero RM**].

20.8 Calibrating the Flow Sensor

A calibration must be performed every time when the RM module is connected to the patient monitor or the flow sensor is connected.

1. When calibration is needed, the RM parameter window displays [**Calibration Required**]. Select the parameter window to enter the [**Calibrate RM**] menu. You can also enter the [**Calibrate RM**] menu by selecting [**Calibration**] from the [**RM Setup**] menu.
2. Select [**Sensor Type**] and then choose [**Infant One-time**], [**Disposable**] or [**Reusable**] according to the sensor used.
3. Enter the positive and negative factor provided on the flow sensor and select [**Calibrate**].

After the calibration is completed successfully, the last calibration time and the message [**Calibration Completed!**] are displayed. Otherwise, the message [**Calibration Failed!**] is displayed.

FOR YOUR NOTES

21 Freezing Waveforms

During patient monitoring, the freeze feature allows you to freeze the currently displayed waveforms on the screen so that you can have a close examination of the patient's status. Besides, you can select any frozen waveform for recording.

21.1 Freezing Waveforms

1. To freeze waveforms, select the  hardkey on the monitor's front.
2. The system closes the displayed menu (if any), and opens the **[Freeze]** menu.

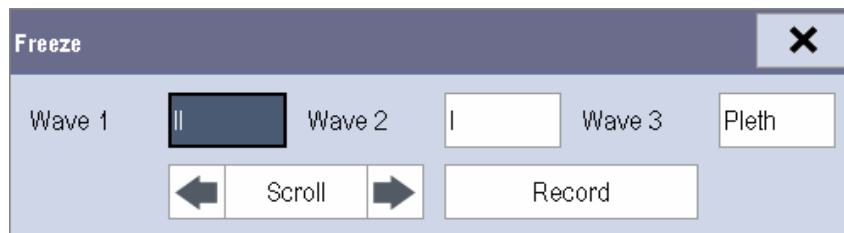



3. All displayed waveforms are frozen, i.e. the waveforms stop being refreshed or scrolling.

The freeze feature exerts no effect on the split-screen view of minitrends, oxyCRG and other patients.

21.2 Viewing Frozen Waveforms



To view the frozen waveforms, you can either:

- Select the **[Scroll]** button and then rotate the Knob clockwise or counter-clockwise, or
- Directly select the  or  beside the **[Scroll]** button using a mouse or through the touchscreen.

The frozen waveforms will scroll left or right accordingly. And meanwhile, at the lower right corner of the bottommost waveform, there is an upward arrow. The freeze time is displayed below the arrow and the initial frozen time is [0 s]. With the waveforms scrolling, the freeze time changes at intervals of 1 second. This change will be applied for all waveforms on the screen.

21.3 Unfreezing Waveforms

To unfreeze the frozen waveforms, you can either:

- Select the  button at the upper right corner of the [**Freeze**] menu,
- Select the  hardkey on the monitor's front, or
- Perform any other action that causes the screen to be readjusted or opens a menu, such as plugging in or out a module, pressing the  hardkey, etc.

21.4 Recording Frozen Waveforms

1. In the [**Freeze**] menu, select, in turn, [**Wave 1**], [**Wave 2**] and [**Wave 3**] and then select your desired waveforms.
2. Select the [**Record**] button. The selected waveforms and all numerics at the frozen time are printed out by the recorder.

22 Review

22.1 Accessing Respective Review Windows

1. Select the **[Review]** QuickKey, or **[Main Menu]**→**[Review >>]**.

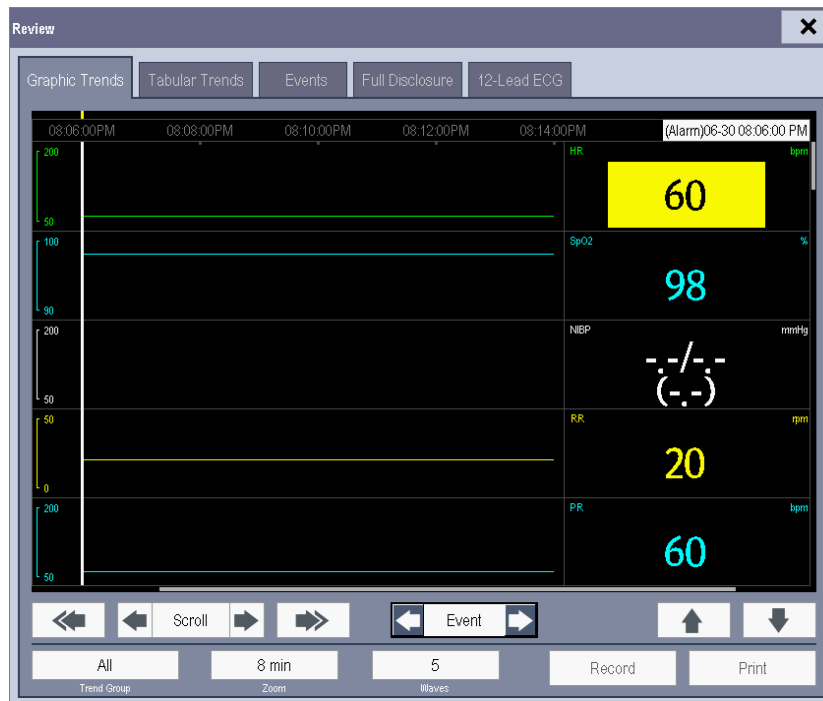

2. Select **[Graphic Trends]**, **[Tabular Trends]**, **[Events]**, **[Full Disclosure]** or **[12-lead ECG]** to access their respective review windows.

For details about reviewing interpretation of resting 12-lead ECG results, refer to the chapter *7 Monitoring ECG*.

22.2 Reviewing Graphic Trends

In the [Review] menu, select [Graphic Trends] to access the following window.

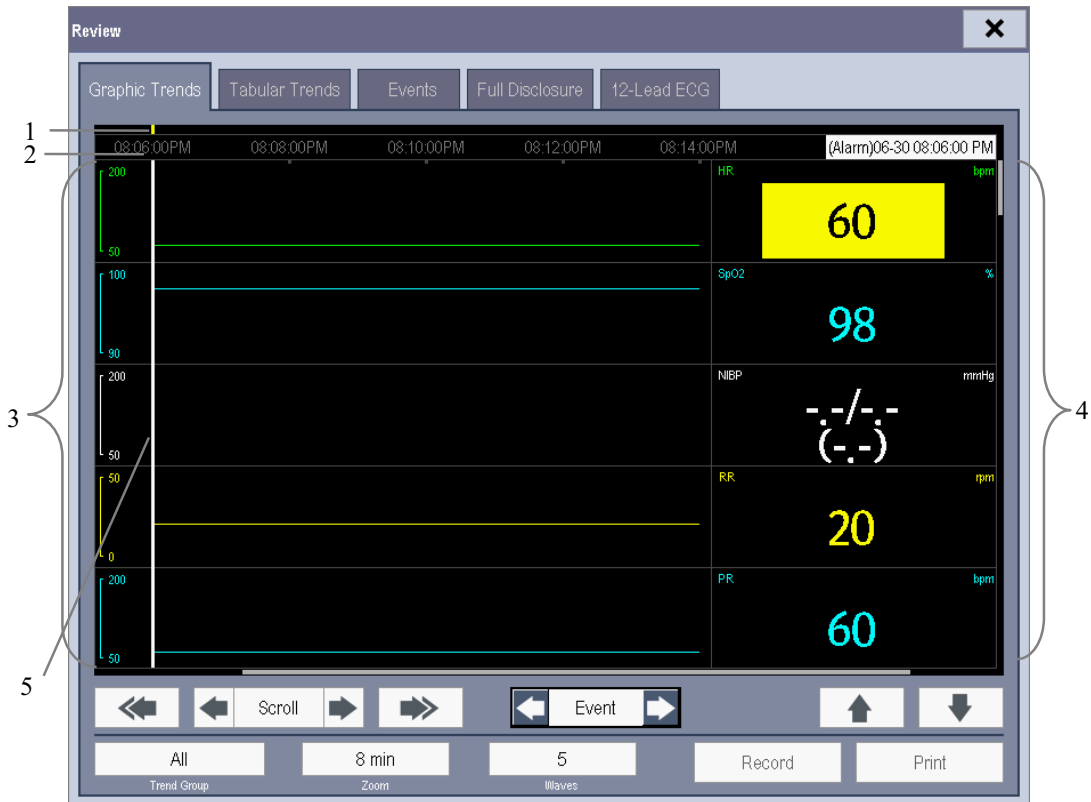





1. Event mark area
2. Time axis
3. Graphic trends area
4. Parameter area
5. Cursor



Events are marked with colors in the event mark area. Red represents high level alarm event. Yellow represents medium/low level alarm event. Green represents manual event.

In this review window:

- Select [**Trend Group**] and you can select a trend group for viewing in the popup menu. If [**Custom 1**] or [**Custom 2**] is selected, you can further select [**Define Trend Group**]. Then you can select the parameters for viewing in the popup menu.
- You can set the time length of the review window by selecting [**Zoom**].
- You can set the number of waves displayed in one page by selecting [**Waves**].
- To browse the graphic trends, you can either:

- ◆ Select  or  beside [**Scroll**] to move the cursor one step to the left or right to navigate through the graphic trends, or
- ◆ Select  or  to move the cursor one page to the left or right to navigate through the graphic trends.

A time indicating your current position is displayed above the parameter area. Numeric measurement values corresponding to the cursor location change as the cursor is moved. The measurement value that triggered high level alarm has red background. The one that triggered medium/low level alarm has yellow background.

- By selecting  or  beside [**Event**], you can position the cursor to different event time.
- By selecting the [**Record**] button, you can print out the currently displayed graphic trends by the recorder.
- By selecting the [**Print**] button, you can set and print out the graphic trends report by the printer. For how to set the graphic trends report, please refer to the *Print* chapter.

22.3 Reviewing Tabular Trends



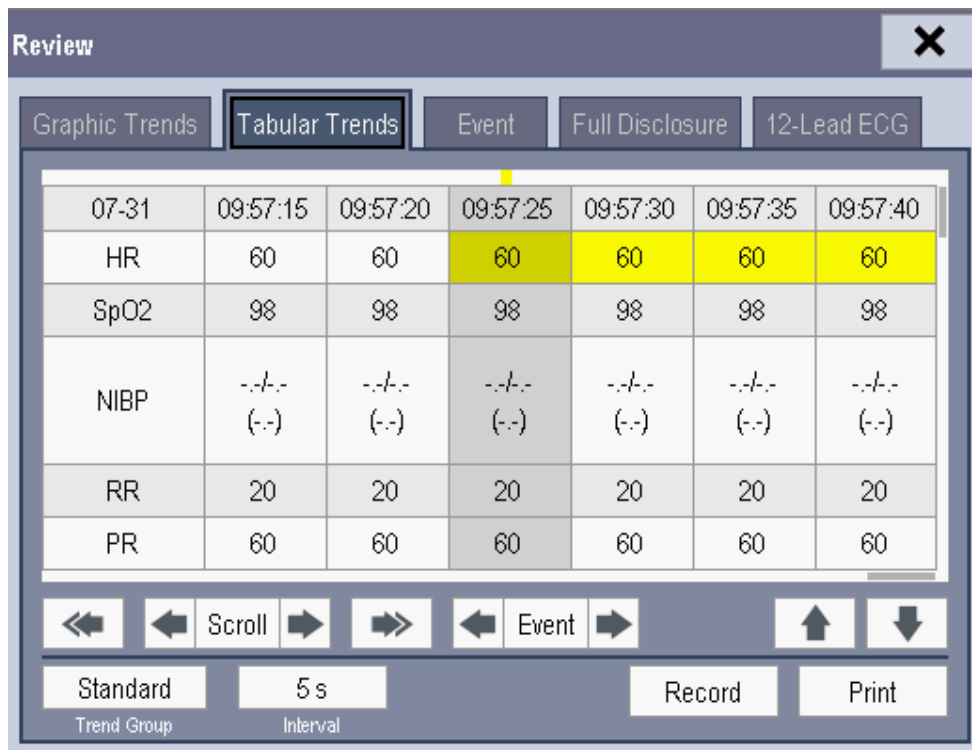

In the [**Review**] menu, select [**Tabular Trends**] to access the following window.





07-31	09:57:15	09:57:20	09:57:25	09:57:30	09:57:35	09:57:40
HR	60	60	60	60	60	60
SpO2	98	98	98	98	98	98
NIBP	-.- (-.)	-.- (-.)	-.- (-.)	-.- (-.)	-.- (-.)	-.- (-.)
RR	20	20	20	20	20	20
PR	60	60	60	60	60	60

Events are marked with colors in window's top area. Red represents high level alarm event. Yellow represents medium/low level alarm event. Green represents manual event.

In this review window:

- Select [**Trend Group**] and you can select a trend group for viewing in the popup menu. If [**Custom 1**] or [**Custom 2**] is selected, you can further select [**Define Trend Group**]. Then you can select the parameters for viewing in the popup menu.
- You can change the resolution of the trend data by selecting [**Interval**] and then selecting the appropriate setting:
 - ◆ [**5 s**] or [**30 s**]: select to view up to 4 hours of tabular trends at 5- or 30-second resolution.
 - ◆ [**1 min**], [**5 min**], [**10 min**], [**15 min**], [**30 min**], [**1 h**], [**2 h**] or [**3 h**]: select to view up to 120 hours of tabular trends at your selected resolution.
 - ◆ [**NIBP**]: select to view the tabular trends when NIBP measurements were acquired.
- To browse the tabular trends, you can either:
 - ◆ Select  or  beside [**Scroll**] to drag the scrollbar left or right to navigate through the trend database, or
 - ◆ Select  or  to scroll left or right to navigate through the trend database.

The measurement value that triggered high level alarm has red background. The one that triggered medium/low level alarm has yellow background.

- By selecting  or  beside [**Event**], you can position the cursor to different event time.
- By selecting the [**Record**] button, you can access the [**Record Setup**] menu and set the start and end time of the tabular trends you want to record. This feature is not available when reviewing a history patient. By further selecting [**Record**], you can print out the currently displayed tabular trends by the recorder.
- By selecting the [**Print**] button, you can set and print out the tabular trends report by the printer. For how to set the tabular trends report, please refer to the *Print* chapter.

22.4 Reviewing Events

In the **[Review]** menu, select **[Events]** to access the following window.

The events that can be reviewed include parameter alarm events, arrhythmia alarm events and manual events. When an event occurs, all the measurement numerics at the event trigger time and related waveforms 4 seconds respectively before and after the event trigger time are stored.

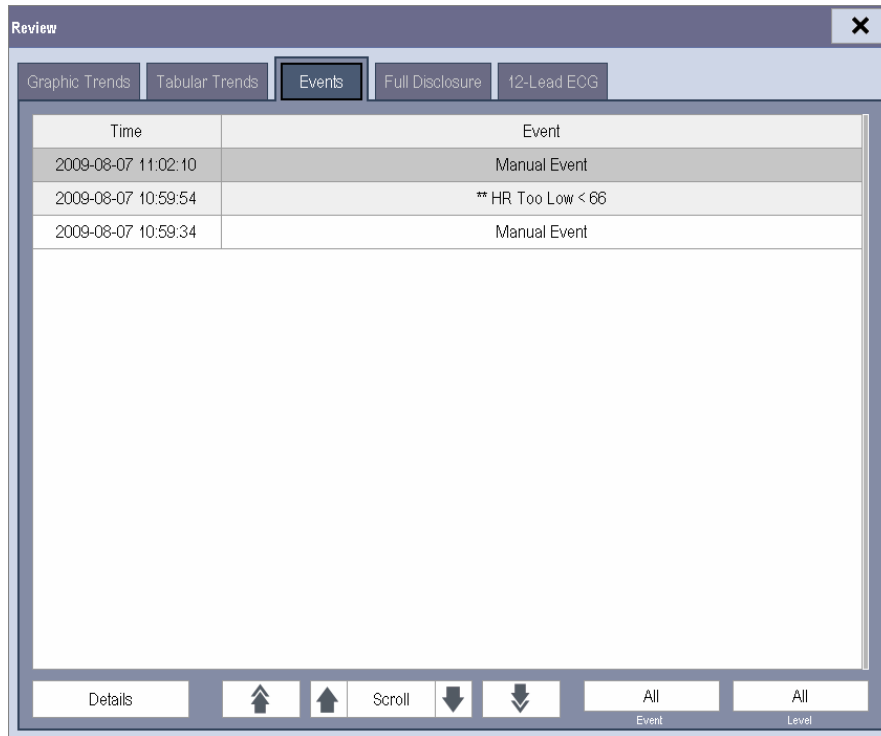

In this window:

- You can view the desired events by selecting **[Event]**.
- You can view the desired events according to the level by selecting **[Level]**.

After selecting the desired event, you can select [**Details**] to access the following window. In this window, the waveform area displays the waveforms related to the event, and the parameter area displays the parameter values happened at the event trigger time.

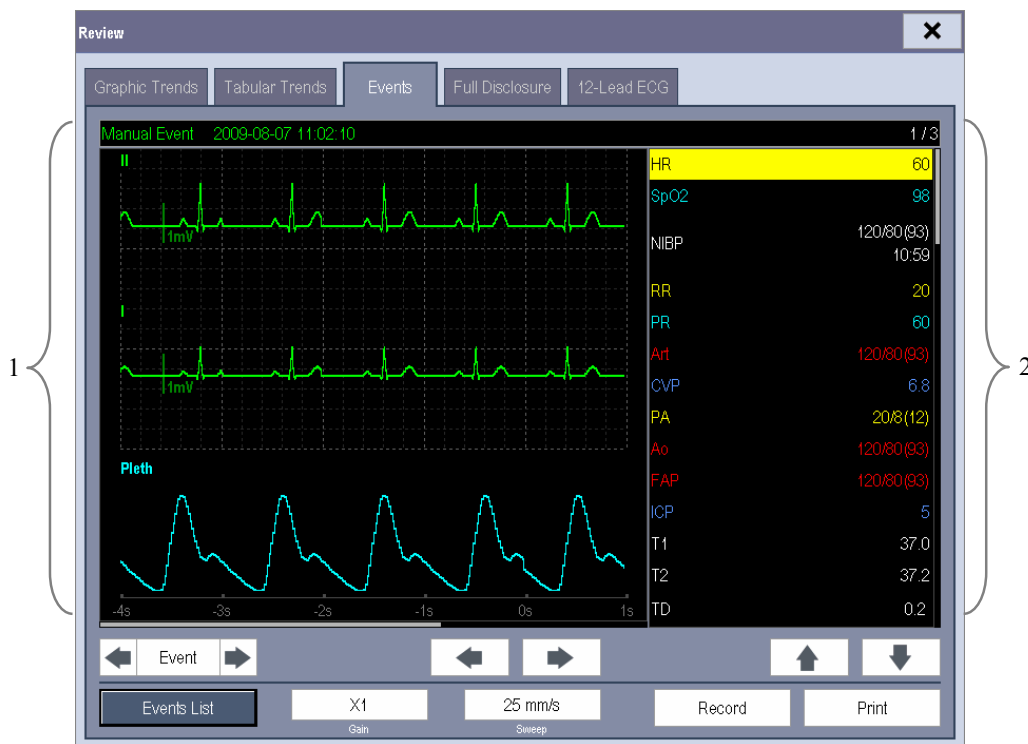

1. Waveform area 2. Parameter area

In this window:

- You can select ◀ or ▶ to navigate through the waveforms.
- You can select ◀ or ▶ beside the [Event] button to switch between events.
- You can set the desired [Gain] for ECG waveform.
- You can set the desired [Sweep].
- By selecting the [Record] button, you can print out the currently displayed alarm events by the recorder.
- By selecting the [Print] button, you can print out the currently displayed alarm events by the printer.
- By selecting the [Events List] button, you can view the events list.

22.5 Reviewing Waveforms





In the [Review] menu, select [Full Disclosure] to access the following window.





A. Waveform area

B. Parameter area

In this review window:

- To review full-disclosure waveforms, you need to save waveforms first. Select [**Save Waves >>**] and then select the parameters whose waveforms you want to view. To save full-disclosure waveform, your monitor must be equipped with a CF storage card.
- To view the waveforms, you can either:
 - ◆ Select  or  beside the [**Scroll**] button to move the cursor one step left or right to navigate through the waveforms, or
 - ◆ Select  or  to move the cursor one page left or right to navigate through the waveforms.

A time indicating your current position is displayed at the top of the waveform area. Numeric measurement values corresponding to the cursor location are displayed in the parameter area, and change as the cursor is moved.

- You can change the ECG wave gain by selecting [**Gain**] and then selecting the appropriate setting.
- You can change the waveform sweep speed by selecting [**Sweep**] and then selecting the appropriate setting.
- By selecting the [**Record**] button, you can print out the first three waveforms and measurement numerics by the recorder.
- By selecting  or  beside the [**Event**] button, you can position the cursor between events.

23 Calculations

23.1 Introduction

The calculation feature is available with your patient monitor. The calculated values, which are not directly measured, are computed based on the values you provide.

You can perform the following calculations:

- Dose calculations
- Oxygenation calculations
- Ventilation calculations
- Hemodynamic calculations
- Renal calculations

To perform a calculation, select **[Main Menu]** → **[Calc >>]**, or the **[Calculations]** QuickKey and then select the calculation you want to perform.

NOTE

- **The calculation feature is independent of other monitoring functions and can be therefore used for patients being monitored by other monitors. Any operation in a calculation window does not affect the patient monitoring by the local patient monitor and the changes in patient demographics in this window are not saved permanently.**
-



WARNING

- **Before the hemodynamic calculation is started, verify the entered hemodynamic values such as C.O. and heart rate are recorded as close to one another as possible in time of recording. For example, in calculating stroke volume via measured values of cardiac output and heart rate, the cardiac output and heart should be measured during the same recording session, in order to generate the correct stroke volume for this cardiac output and heart rate. After the calculation is finished, verify the entered values are correct and the calculated values are appropriate. We assume no responsibility for any consequences caused by wrong entries and improper operations.**
-

23.2 Dose Calculations

23.2.1 Performing Calculations

To perform a dose calculation:

1. Select [**Main Menu**]→[**Calculations >>**]→[**Dose >>**], or select [**Calculations**] QuickKey→[**Dose >>**].
2. Select, in turn, [**Patient Cat.**] and [**Drug Name**] and then select the appropriate settings. The dose calculation program has a library of commonly used drugs, of which Drug A through Drug E are for those not specified in this library.
 - ◆ Drug A, B, C, D, E
 - ◆ Aminophylline
 - ◆ Dobutamine
 - ◆ Dopamine
 - ◆ Epinephrine
 - ◆ Heparin
 - ◆ Isuprel
 - ◆ Lidocaine
 - ◆ Nipride
 - ◆ Nitroglycerin
 - ◆ Pitocin
3. The system gives a set of default values when the above steps are finished. However, these values cannot be used as the calculated values. The user must enter values following the doctor's instructions, and then the calculated values can only be used
4. Enter the patient's weight.
5. Enter other values.
6. Verify if the calculated values are correct.

23.2.2 Selecting the Proper Drug Unit

Each drug has its fixed unit or unit series. Among a unit series, one unit may change to another automatically depending on the entered value.

The units for each drug are as follows:

- Drug A, B, C, Aminophylline, Dobutamine, Dopamine, Epinephrine, Isuprel, Lidocaine, Nipride and Nitroglycerin use the unit series: g, mg and mcg.
- Drug D, Heparin and Pitocin use the unit series: Unit, KU (kilo units) and MU (million units).
- Drug E uses the unit: mEq (milli-equivalents).

You must select the proper drug name (A, B, C, D or E) according to the units when you define a drug not listed in this library.

NOTE

-
- For neonate patients, [Drip Rate] and [Drop Size] are disabled.
-

23.2.3 Titration Table





To open the titration table, select [**Titration Table >>**] in the [**Dose Calculation**] window after the dose calculation is finished.

In the titration table, when you change:

- [**Reference**]
- [**Interval**]
- [**Dose Type**]

The titrated values change accordingly.

You can also:

- Select  or , or  or  beside the vertical scrollbar to view more values.
- Select [**Record**] to print out the currently displayed titrated values by the recorder.

23.3 Oxygenation Calculations

23.3.1 Performing Calculations

To perform an oxygenation calculation:

1. Select [**Main Menu**]→[**Calculations >>**]→[**Oxygenation >>**], or select [**Calculations**] QuickKey→[**Oxygenation >>**].
2. Enter values for calculation.
3. Select the [**Calculate**] button. The system performs a calculation per the current settings and displays the calculated values.
 - ◆ If a calculated value is outside the range, its background will highlight in yellow. You can select [**Range**] to view its normal range in the unit field. For those who are within the range, their unit fields appear blank.
 - ◆ Invalid values are displayed as [---].

In the [**Oxygenation Calculation**] window, you can:

- Change the pressure unit, Hb unit and oxygen content unit by selecting [**Press. Unit**], [**Hb Unit**] and [**OxyCont Unit**] and then selecting the appropriate settings. The changes take effect automatically.
- Trigger a recording by selecting the [**Record**] button. The currently displayed oxygenation calculations are printed out by the recorder.
- Review the previously performed calculations by selecting [**Review**].

23.3.2 Entered Parameters

Abbreviation	Unit	Full spelling
C.O.	L/min	cardiac output
FiO ₂	%	percentage fraction of inspired oxygen
PaO ₂	mmHg	partial pressure of oxygen in the arteries
PaCO ₂	mmHg	partial pressure of carbon dioxide in the arteries
SaO ₂	%	arterial oxygen saturation
PvO ₂	mmHg	partial pressure of oxygen in venous blood
SvO ₂	%	venous oxygen saturation
Hb	g/L	hemoglobin
RQ	None	respiratory quotient
ATMP	mmHg	atmospheric pressure
Height	cm	height
Weight	kg	weight

23.3.3 Calculated Parameters

Abbreviation	Unit	Full spelling
BSA	m ²	body surface area
VO ₂	ml/min	oxygen consumption
C(a-v)O ₂	ml/L	arteriovenous oxygen content difference
O ₂ ER	%	oxygen extraction ratio
DO ₂	ml/min	oxygen transport
PAO ₂	mmHg	partial pressure of oxygen in the alveoli
AaDO ₂	mmHg	alveolar-arterial oxygen difference
CcO ₂	ml/L	capillary oxygen content
CaO ₂	ml/L	arterial oxygen content
CvO ₂	ml/L	venous oxygen content
Qs/Qt	%	venous admixture

23.4 Ventilation Calculations

23.4.1 Performing Calculations

To perform a ventilation calculation:

1. Select [**Main Menu**]→[**Calculations >>**]→[**Ventilation >>**], or select [**Calculations**] QuickKey→[**Ventilation >>**].
2. Enter values for calculation.
3. Select the [**Calculate**] button. The system performs a calculation per the current settings and displays the calculated values.
 - ◆ If a calculated value is outside the range, its background will highlight in yellow. You can select [**Range**] to view its normal range in the unit field. For those who are within the range, their unit fields appear blank.
 - ◆ Invalid values are displayed as [---].

In the [**Ventilation Calculation**] window, you can:

- Change the pressure unit by selecting [**Press. Unit**] and then selecting the appropriate setting. Corresponding pressure values shall convert and update automatically.
- Trigger a recording by selecting the [**Record**] button. The currently displayed ventilation calculations are printed out by the recorder.
- Review the previously performed calculations by selecting [**Review**].

23.4.2 Entered Parameters

Abbreviation	Unit	Full spelling
FiO ₂	%	percentage fraction of inspired oxygen
RR	rpm	respiration rate
PeCO ₂	mmHg	partial pressure of mixed expiratory CO ₂
PaCO ₂	mmHg	partial pressure of carbon dioxide in the arteries
PaO ₂	mmHg	partial pressure of oxygen in the arteries
TV	ml	tidal volume
RQ	None	respiratory quotient
ATMP	mmHg	atmospheric pressure

23.4.3 Calculated Parameters

Abbreviation	Unit	Full spelling
PAO ₂	mmHg	partial pressure of oxygen in the alveoli
AaDO ₂	mmHg	alveolar-arterial oxygen difference
Pa/FiO ₂	mmHg	oxygenation ratio
a/AO ₂	%	arterial to alveolar oxygen ratio
MV	L/min	minute volume
V _d	ml	volume of physiological dead space
V _d /V _t	%	physiologic dead space in percent of tidal volume
V _A	L/min	alveolar volume

23.5 Hemodynamic Calculations

23.5.1 Performing Calculations

To perform a hemodynamic calculation:

1. Select [**Main Menu**]→[**Calculations >>**]→[**Hemodynamic >>**], or select [**Calculations**] QuickKey→[**Hemodynamic >>**].
2. Enter values for calculation.
 - ◆ For a patient who is being monitored, [**HR**], [**Art mean**], [**PA mean**] and [**CVP**] are automatically taken from the currently measured values. If you just have performed C.O. measurements, [**C.O.**] is the average of multiple thermodilution measurements. [**Height**] and [**Weight**] are the patient's height and weight you have entered. If the monitor does not provide these values, their fields appear blank.
 - ◆ For a patient who is not being monitored, confirm the values you have entered.
3. Select the [**Calculate**] button. The system performs a calculation per the current settings and displays the calculated values.
 - ◆ If a calculated value is outside the range, its background will highlight in yellow. You can select [**Range**] to view its normal range in the unit field. For those who are within the range, their unit fields appear blank.
 - ◆ Invalid values are displayed as [---].

In the [**Hemodynamic Calculation**] window, you can:

- Trigger a recording by selecting the [**Record**] button. The currently displayed renal calculations are printed out by the recorder.
- Review the previously performed calculations by selecting [**Review**].

23.5.2 Entered Parameters

Abbreviation	Unit	Full spelling
C.O.	L/min	cardiac output
HR	bpm	heart rate
PAWP	mmHg	pulmonary artery wedge pressure
Art Mean	mmHg	artery mean pressure
PA Mean	mmHg	pulmonary artery mean pressure
CVP	mmHg	central venous pressure
EDV	ml	end-diastolic volume
Height	cm	height
Weight	kg	weight

23.5.3 Calculated Parameters

Abbreviation	Unit	Full spelling	Formula
BSA	m ²	body surface area	$Ht^{0.725}(\text{cm}) \times Wt^{0.425}(\text{kg}) \times 0.007184$
C.I.	L/min/m ²	cardiac index	C.O./BSA
SV	ml	stroke volume	(C.O./HR)×1000
SI	ml/m ²	stroke index	SV/BSA
SVR	DS/cm ⁵	systemic vascular resistance	$((\text{Art Mean} - \text{CVP})/\text{C.O.}) \times 79.96$
SVRI	DS·m ² /cm ⁵	systemic vascular resistance index	SVR×BSA
PVR	DS/cm ⁵	pulmonary vascular resistance	$((\text{PA Mean} - \text{PAWP})/\text{C.O.}) \times 79.96$
PVRI	DS·m ² /cm ⁵	pulmonary vascular resistance index	PVR×BSA
LCW	kg·m	left cardiac work	0.0136×Art Mean×C.O.
LCWI	kg·m/m ²	left cardiac work index	LCW/BSA
LVS	g·m	left ventricular stroke work	SV×(Art Mean -PAWP)×0.0136
LVSWI	g·m/m ²	left ventricular stroke work index	LVS/BSA
RCW	kg·m	right cardiac work	0.0136×PA mean×C.O.
RCWI	kg·m/m ²	right cardiac work index	RCW/BSA
RVS	g·m	right ventricular stroke work	SV×(PA Mean -CVP)×0.0136
RVSWI	g·m/m ²	right ventricular stroke work index	RVS/BSA
EF	%	ejection fraction	100×SV/EDV

Reference Sources

Source: Kinney M, Dunbar S, Brooks-Brunn J, Molter N, and Vitello-Cicciu J. AACN's Clinical Reference for Critical Care Nursing. St. Louis: Mosby, 1996.

Source: DuBois D, Dubois EF. A formula to estimate the approximate surface height and weight be known. Arch Intern Medicing. 1916; 17:863-71.

Source: Baxter Healthcare Corporation. Model COM-2 Cardiac Output Computer Operations Manual Software Version 2.2. Santa Ana: 1989.

23.6 Renal Calculations

23.6.1 Performing Calculations

To perform a renal calculation:

1. Selecting [**Main Menu**]→[**Calculations >>**]→[**Renal >>**], or select [**Calculations**] QuickKey→[**Renal >>**].
2. Enter values for calculation.
3. Select the [**Calculate**] button. The system performs a calculation per the current settings and displays the calculated values.
 - ◆ If a calculated value is outside the range, its background will highlight in yellow. You can select [**Range**] to view its normal range in the unit field. For those who are within the range, their unit fields appear blank.
 - ◆ Invalid values are displayed as [---].

In the [**Renal Calculation**] window, you can:

- Trigger a recording by selecting the [**Record**] button. The currently displayed renal calculations are printed out by the recorder.
- Review the previously performed calculations by selecting [**Review**].

23.6.2 Entered Parameters

Abbreviation	Unit	Full spelling
URK	mmol/L	urine potassium
URNa	mmol/L	urinary sodium
Urine	ml/24h	urine
Posm	mOsm/ kgH ₂ O	plasma osmolality
Uosm	mOsm/ kgH ₂ O	urine osmolality
SerNa	mmol/L	serum sodium
Cr	μmol/L	creatinine
UCr	μmol/L	urine creatinine
BUN	mmol/L	blood urea nitrogen
Height	cm	height
Weight	kg	weight

23.6.3 Calculated Parameters





Abbreviation	Unit	Full spelling
URNaEx	mmol/24h	urine sodium excretion
URKEx	mmol/24h	urine potassium excretion
Na/K	%	sodium potassium ratio
CNa	ml/24h	clearance of sodium
Clcr	ml/min	creatinine clearance rate
FENa	%	fractional excretion of sodium
Cosm	ml/min	osmolar clearance
CH ₂ O	ml/h	free water clearance
U/P osm	None	urine to plasma osmolality ratio
BUN/Cr	None*	blood urea nitrogen creatinine ratio
U/Cr	None	urine-serum creatinine ratio

*: BUN/Cr is a ratio under the unit of mol.

23.7 Understanding the Review Window

With the review feature, you can review oxygenation, ventilation, hemodynamic and renal calculations. The review window for each calculation is similar. Take the hemodynamic calculations review window for example, you can access it by selecting [**Review**] in the [**Hemodynamic Calculation**] window.

In this review window:

- You can select , ,  or  to view more values.
- The values that exceed the range are displayed in yellow background. The [**Unit**] field displays parameter units. If some parameter values are outside of their normal ranges, you can view their normal range in the [**Unit**] field by selecting [**Range**].
- You can review an individual calculation by selecting its corresponding column and then selecting [**Original Calc**]. You can record the currently displayed calculations or perform another calculation in this window.

24 Recording

24.1 Using a Recorder

The thermal recorder records patient information, measurement numerics, up to three waveforms, etc.

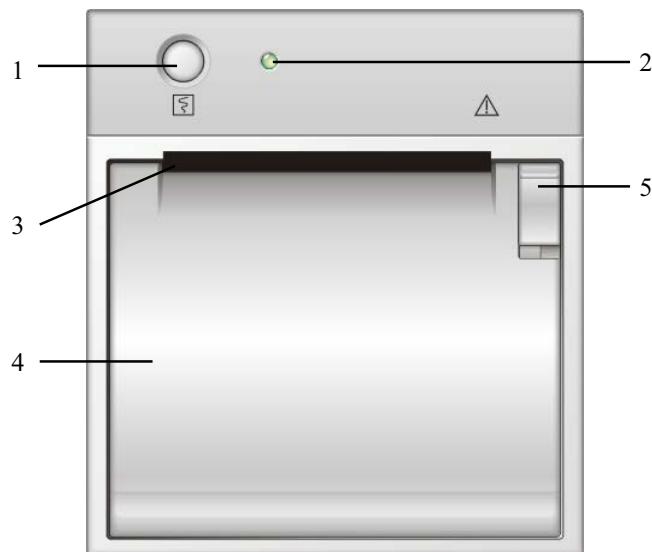

1. Start/Stop key: press to start a recording or stop the current recording.
2. Indicator
 - ◆ On: when the recorder works correctly.
 - ◆ Off: when the monitor is switched off.
 - ◆ Flashes: if an error occurred to the recorder, e.g., the recorder runs out of paper.
3. Paper outlet
4. Recorder door
5. Latch

24.2 Overview of Recording Types

By the way recordings are triggered, the recordings can be classified into the following categories:

- Manually-triggered realtime recordings.
- Timed recordings.
- Alarm recordings triggered by an alarm limit violation or an arrhythmia event.
- Manually-triggered, task-related recordings.

The task-related recordings include:

- Frozen wave recording
- Graphic trends recording
- Tabular trends recording
- Events recording: parameter alarm recording, arrh. alarm recording, manual events recording
- Wave review recording
- Interpretation of resting 12-lead ECG result recording
- Titration table recording
- Hemodynamic calculations recording
- Oxygenation calculations recording
- Ventilation calculations recording
- Renal calculations recording
- oxyCRG recording
- C.O. curve recording
- PAWP recording
- Respiratory loops recording
- Monitor information recording

NOTE

-
- For details about alarm recording, refer to the chapter 6 Alarms.
 - For details about task-related recordings, refer to respective sections of this manual.
-

24.3 Starting and Stopping Recordings

To manually start a recording, you can either:

- Select the  hardkey on the front of either the patient monitor or the recorder module, or
- Select the **[Record]** button from the current menu or window.

Automatic recordings will be triggered in the following conditions:

- Timed recordings will start automatically at preset intervals.
- If both **[Alarm]** and **[Alm Rec]** for a measurement are set on, an alarm recording will be triggered automatically as alarms occur.

To manually stop a recording, you can either:

- Select the  hardkey again, or
- Select **[Clear All Tasks]** in the **[Record Setup]** menu.

Recordings stop automatically when:

- The runtime is over.
- The recorder runs out of paper.
- When the recorder has an alarm condition.

24.4 Setting up the Recorder

24.4.1 Accessing the Record Setup Menu

By selecting [Main Menu]→[Record Setup >>], you can access the [Record Setup] menu.

24.4.2 Selecting Waveforms for Recording

The recorder can record up to 3 waveforms at a time. You can select, in turn, [Waveform 1], [Waveform 2] and [Waveform 3] in the [Record Setup] menu, and then select the waveforms you want. You can also turn off a waveform recording by selecting [Off]. These settings are intended for realtime and scheduled recordings.

24.4.3 Setting the Realtime Recording Length

After starting a realtime recording, the recording time depends on your monitor's settings. In the [Record Setup] menu, select [Length] and toggle between [8 s] and [Continuous].

- [8 s]: record 8-second waveforms from the current moment.
- [Continuous]: record the waveforms from the current moment until stopped manually.

24.4.4 Setting the Interval between Timed Recordings

Timed recordings start automatically at preset intervals. Each recording lasts 8 seconds. To set the interval between timed recordings: in the [Record Setup] menu, select [Interval] and then select the appropriate setting.

24.4.5 Changing the Recording Speed

In the [Record Setup] menu, select [Paper Speed] and toggle between [25 mm/s] and [50 mm/s]. This setting is for all recordings containing waveforms.

24.4.6 Clearing Recording Tasks

In the **[Record Setup]** menu, select **[Clear All Tasks]**. All queued recording tasks are cleared and the current recording is stopped.

24.5 Loading Paper

1. Use the latch at the upper right of the recorder door to pull the door open.
2. Insert a new roll into the compartment as shown below.
3. Close the recorder door.
4. Check if paper is loaded correctly and the paper end is feeding from the top.

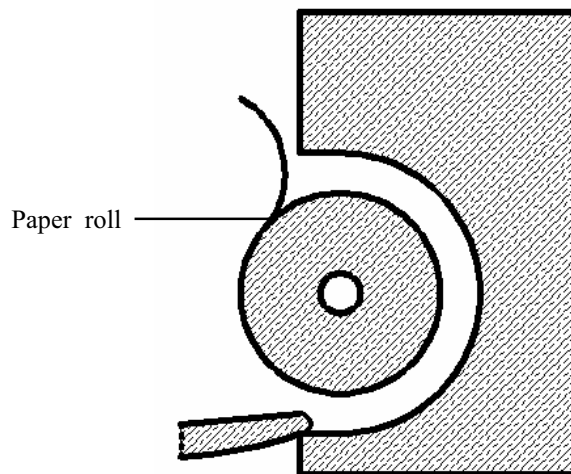

 **CAUTION**

- **Use only specified thermal paper. Otherwise, it may cause damage to the recorder's printhead, the recorder may be unable to print, or poor print quality may result.**
 - **Never pull the recorder paper with force when a recording is in process. Otherwise, it may cause damage to the recorder.**
 - **Do not leave the recorder door open unless you reload paper or remove troubles.**
-

24.6 Removing Paper Jam

If the recorder works incorrectly or produces unusual sounds, check if there is a paper jam first. If a paper jam is detected, follow this procedure to remove it:

1. Open the recorder door.
2. Take out the paper and tear off the draped part.
3. Reload the paper and close the recorder door.

24.7 Cleaning the Recorder Printhead

If the recorder has been used for a long time, deposits of paper debris may collect on the printhead compromising the print quality and shortening the lifetime of the roller. Follow this procedure to clean the printhead:

1. Take measures against the static electricity such as Disposable Wrist Strap for the work.
2. Open the recorder door and take out the paper.
3. Gently wipe around the printhead using cotton swabs dampened with alcohol.
4. After the alcohol has completely been dried, reload the paper and close the recorder door.

CAUTION

- **Do not use anything that may destroy the thermal element.**
 - **Do not add unnecessary force to the thermal head.**
-

25 Printing

25.1 Printer

The monitor can output patient reports via a connected printer. So far, the monitor supports the following printer:

- HP LaserJet 1505N
- HP LaserJet 2035N

The specifications of the reports the monitor prints are:

- Paper: A4, Letter
- Resolution: 300 dpi
- Print on One/Both Sides : printing on one and both sides are supported if the printer supports

For more details about the printer, see the document accompanying the printer. With the upgrading of products, the monitor will support more printers and no prior notice will be given. If you have any doubt about the printer you have purchased, contact our company.

25.2 Connecting a printer

To print the reports or the trend data of a patient, you can choose either:

- the local printer

Connect the printer and the patient monitor directly with a network cable, and then start printing what you want, or

- the Central Monitoring System

If your monitor is connected to a central monitoring system, it is recommended to use the central monitoring system for printing.

25.3 Setting Up the Printer

To set the printer's properties, select [Main Menu]→[Print Setup >>]→[Printer Setup >>]. In the [Printer Setup] menu, you can:

- Select a connected printer

Select [Printer] and then select a connected printer as the monitor's printer. If [Central Station] is selected, a printout will be sent to the printer associated with the Central Station.
- Search for a printer

If your selected printer is not in the list or a new printer is added into the network, you can select the [Search Printer] to re-search for all printers in the network.
- Set up the paper

Select [Paper Size] and toggle between [A4] and [Letter].
- Print on both sides

By default, the monitor prints out patient reports on one side. If you set [Print On Both Sides] to [On], the monitor will print out patient reports on both sides.

25.4 Starting Report Printouts

Reports	Contents	Procedures
ECG reports (unavailable when [Printer] is set to [Central Station])	ECG waveforms and relevant parameter values	Select [Main Menu]→[Print Setup >>]→[ECG Reports >>]→[Print]
Tabular trends	Depend on the selected parameter group, resolution and time period	Select [Main Menu]→[Print Setup >>]→[Tabular Trends Reports >>]→[Print], or select [Main Menu]→[Review >>]→[Tabular Trends]→[Print]→[Print]
Graphic trends	Depend on the selected parameter group, resolution and time period	Select [Main Menu]→[Print Setup >>]→[Graphic Trends Reports >>]→[Print], or select [Main Menu]→[Review >>]→[Graphic Trends]→[Print]→[Print]
Arrh. alarm review (unavailable when [Printer] is set to [Central Station])	ECG waveforms and relevant parameter values	Select [Print] in [Arrh. Events]

Parameter alarm review (unavailable when [Printer] is set to [Central Station])	Depend on the selected alarms	Select [Main Menu]→[Review >>]→[Alarms]→[Print]
Interpretation of resting 12-lead ECG (unavailable when [Printer] is set to [Central Station])	12-lead ECG waveforms and analysis results	Select [12-lead Analysis]→[Print] when a interpretation of resting 12-lead ECG is completed, or select [Main Menu]→[Review >>]→[12-lead Analysis]→[Print]
Realtime waves	Depend on the selected waveforms	Select [Main Menu]→[Print Setup >>]→[Realtime Reports >>]→[Print]

25.5 Stopping Reports Printouts

To stop report printouts, select [Main Menu]→[Print Setup >>]→[Stop All Reports].

25.6 Setting Up Reports

25.6.1 Setting Up ECG Reports

You can print out ECG reports only under full-screen, half-screen or 12-lead monitoring screen. To set up ECG reports, select [Main Menu]→[Print Setup >>]→[ECG Reports >>].

- [Amplitude]: set the amplitude of the ECG waveforms.
- [Sweep]: set the wave print speed.
- [Auto Interval]: If [Auto Interval] is set to [On], the system will automatically adjust the space between waveforms to avoid overlapping.
- [Gridlines]: choose whether to show gridlines.
- [12-Lead Format]: If you select [12X1], 12 waveforms will be printed on a paper from top to bottom. If you select [6X2], 12 waveforms will be printed from left to right with 6 waveforms on each half part and a rhythm waveform will be printed at the bottommost.

25.6.2 Setting Up Tabular Trends Reports

To set up tabular trends reports, select [Main Menu]→[Print Setup >>]→[Tabular Trends Reports >>].

- Start time: You can set a time period whose trend data will be printed out by setting [From] and [Back]. For example, if you set [From] as 2007-4-2 10:00:00 and [Back] as [2 h], the outputted data will be from 2007-4-2 08:00:00 to 2007-4-2 10:00:00. In addition, the [Back] can be set to either:
 - ◆ [Auto]: If [Report Layout] is set to [Time Oriented], the report will be printed by time. If [Report Layout] is set to [Parameter Oriented], the report will be printed by parameters.
 - ◆ [All]: If you select [All], all trend data will be printed out. In this case, it is no need to set [From].
- [Interval]: choose the resolution of the tabular trends printed on the report.
- [Report Layout]: If you select [Time Oriented], the report will be printed by time. If you select [Parameter Oriented], the report will be printed by parameters.

-
- [Select Parameter >>]: from the popup menu, you can:
 - ◆ [Currently Displayed Trended Parameters]: print the parameter trend data selected from the [Tabular Trends].
 - ◆ [Standard Parameter Group]: select the standard parameter group for printing.
 - ◆ [Custom]: You can define a parameter group for printing from the parameters displayed in the low part of the menu.

25.6.3 Setting Up Graphic Trends Reports

To set up graphic trends reports, select [Main Menu]→[Print Setup >>]→[Graphic Trends Reports >>]. As setting up graphic trends reports is similar with tabular trends reports, you can refer to the *Setting Up Tabular Trend Reports* section for details.

25.6.4 Setting Up Realtime Reports

To set up realtime reports, select [Main Menu]→[Print Setup >>]→[Realtime Reports >>].

- [Sweep]: set the wave print speed.
- [Select Wave >>]: from the popup menu, you can:
 - ◆ [Current]: select the currently displayed waves for printing.
 - ◆ [Select Wave]: select the desired waves for printing.

25.7 End Case Reports

ECG reports, tabular trends reports, graphic trends reports, NIBP review reports and realtime reports can be set as end case reports. When you discharge a patient, the system will automatically print out all contents that are set as end case reports.

For example, to set ECG report as end case report:

1. select [Main Menu]→[Print Setup >>]→[ECG Report >>].
2. select [End Case Report]→[Set as End Case Report] and then select [Ok] from the popup dialog box.
3. set as described in the *25.6.1 Setting Up ECG Reports*.

25.8 Printer Statuses

25.8.1 Printer Out of Paper

When the printer runs out of paper, the print request will not be responded. If there are too many print jobs that are not responded, a printer error may occur. In these cases, you need to install paper and then re-send the print request. Restart the printer if necessary.

Therefore, you'd better ensure that there is enough paper in the printer before sending a print request.

25.8.2 Printer Status Messages

Printer Status Message	Possible causes and suggested action
Printer unavailable	The selected printer is not available. Check if the printer is switched on or correctly connected or installed with paper.

26 Other Functions

26.1 Marking Events

During patient monitoring, some events may exert effects on the patient and as a result change the waveforms or numerics displayed on the monitor. To help analysing the waveforms or numerics at that time, you can mark these events.

Select [Main Menu]→[Mark Event >>]. In the popup menu, you can select the waves to be stored when a manual event is triggered. You can select [Trigger Manual Event] from the [Mark Event] menu or the [Manual Event] QuickKey to trigger a manual event and store it at the same time.

When you are reviewing graphic trends, tabular trends or full-disclosure waveforms, the manual event symbol is displayed at the time the event is triggered.

26.2 Privacy Mode

Privacy mode is only available when a patient who is admitted at a patient monitor is also monitored by the Hypervisor CMS.

To activate the privacy mode:

1. Select [Main Menu]→[Screen Setup >>].
2. Select [Privacy Mode] to activate the privacy mode. The button appears greyed out and is not selectable if the patient is not admitted at the central station.

The patient monitor behaves as follows as soon as the privacy mode is activated:

- The screen turns blank and [Under monitoring. Press any key to exit the privacy mode.] is displayed.
- Monitoring and data storing continue but patient data is only visible at the central station.
- Alarms can still be triggered. But all audible alarms are suppressed and the alarm light is deactivated at the patient monitor.
- All system sounds are suppressed, including heart beat tone, pulse tone, all prompt tones, etc.

WARNING

- **During privacy mode, all audible alarms are suppressed and the alarm light is deactivated at the patient monitor. Alarms sound only at the central station.**
-
-

To cancel the privacy mode, proceed as follows:

- Press any key.

The patient monitor exits the privacy mode automatically in one of the following situations:

- The patient monitor disconnects from central station.
- The alarm of **[Battery Too Low]** and **[The monitor will quit soon. Please use AC power.]** message appear.

26.3 Night Mode

To avoid disturbing the patient, night mode may be used. Night mode is available when **[Hypervisor]** is chosen in **[Factory Maintenance]** menu.

To activate the night mode:

1. Select the **[Night Mode]** QuickKey or **[Main Menu]→[Screen Setup >>]→[Night Mode >>]**.
2. In the pop-up menu, set the desired brightness, alarm volume, QRS volume, key volume, and set whether to stop NIBP measurement or not.
3. Select the **[Enter Night Mode]** button.

To cancel the night mode:

1. Select the **[Night Mode]** QuickKey or **[Main Menu]→[Screen Setup >>]→[Night Mode >>]**.
2. Select **[Ok]** in the popup.

26.4 Analog Output

The patient monitor provides analog output signals to accessory equipment via the Micro-D connector on the rear of the monitor. To obtain analog output signals, connect the accessory equipment such as an oscillograph, etc. to the monitor and then follow this procedure:

1. Select [**Main Menu**] then [**Analog Output Setup>>**].
2. Select [**Analog Out.**] and then select [**On**].

NOTE

-
- **The analog output feature is seldom applied in clinical applications. You can contact your service personnel for more details.**
-

26.5 Transferring Data

You can transfer the patient data saved in the monitor to a PC via a crossover network cable or CF storage card, or within a LAN for data management, review or print.

26.5.1 Data Export System

You must install the data export system on the intended PC before performing the data transfer operation. Refer to the document accompanying the installation CD-ROM for installation instructions.

The data transfer feature supports patient management, data review, data format conversion, print, etc. in addition to data transfer. Refer to the help file of the system software for more details.

26.5.2 Transferring Data by Different Means

NOTE

- **Never enter the data transfer mode when the patient monitor is in normal operation or performs monitoring. You must re-start the patient monitor to exit the data transfer mode.**
-

Transfer data via a crossover network cable

Before transferring data using a crossover network cable, do as follows:

1. Connect one end of the crossover network cable to the patient monitor and the other end to the PC.
2. Set the IP address of the PC. This IP address must be in the same network segment with that of the patient monitor.
3. Make sure that the data export system is active on the PC.

Then, follow this procedure to transfer data:

1. Select [**Main Menu**]→[**Patient Data >>**]→[**Transfer Data**].
2. Select [**Yes**] from the popup message box.
3. Input the IP address already set on the PC.
4. Select [**Start**] to start transferring data.

Transfer data within a LAN

Before transferring data within a LAN, do as follows:

1. Connect the patient monitor and the intended PC into the same LAN and acquire the PC's IP address.
2. Make sure that the data export system is active on the PC.

Follow the same procedure as via a crossover network cable to transfer data.

Transfer data via a CF storage card

1. Power off the patient monitor and remove the CF storage card from it. Refer to the *Basic Operations* section for details.
2. Run the data export system on the PC.
3. Insert the CF storage card into the card reader that connects the PC.
4. Perform the data transfer operation following the help file of the system software.

26.6 Nurse Call

The patient monitor also provides nurse call signals to a nurse call system connected to the monitor via the Nurse Call connector. To obtain nurse call signals, connect a nurse call system to the monitor and then follow this procedure:

1. Select [**Main Menu**]→[**Maintenance >>**]→[**User Maintenance >>**]→enter the required password.
2. Select [**Others >>**] to access the [**Others**] menu.
3. Select [**Nurse Call Setup**] to change the nurse call settings as follows:
 - Select [**Signal Type**] and toggle between [**Pulse**] and [**Continuous**].
 - ◆ [**Pulse**]: the nurse call signals are pulse signals and each pulse lasts 1 second. When multiple alarms occur simultaneously, only one pulse signal is outputted. If an alarm occurs but the previous one is not cleared yet, a new pulse signal will also be outputted.
 - ◆ [**Continuous**]: the nurse call signal lasts until the alarm ends, i.e. the duration of a nurse call signal equals to that of the alarm condition.
 - Select [**Contact Type**] and toggle between [**Normally Open**] and [**Normally Closed**].
 - ◆ [**Normally Open**]: select if your hospital's nurse call relay contact is normally open.

-
- ◆ [Normally Closed]: select if your hospital's nurse call relay contact is normally closed.
 - Select [Alm Lev] and set the alarm level for nurse call-triggering alarms.
 - Select [Alarm Cat.] and then select the category to which the nurse call-triggering alarms belong.

Alarm conditions are indicated to nurses only when:

- The nurse call system is enabled,
- An alarm that meets your preset requirements occurs, and
- The monitor is not in the alarm paused or silence status.

NOTE

-
- **If no setting is selected from [Alm Lev] or [Alarm Cat.], no nurse call signal will be triggered whatever alarms occur.**
-

WARNING

-
- **Do not rely exclusively on the nurse call system for alarm notification. Remember that the most reliable alarm notification combines audible and visual alarm indications with the patient's clinical condition.**
-

26.7 Remote Display

This monitor enables remote display. It allows remote displays to be connected to the bedside monitor through network. The information coming from the monitor will be displayed on the remote display through the remote display driver so that clinical professionals can conveniently observe the patient's conditions from distance.

For details about remote display features, refer to the instructions for use accompanying the remote display driver.

NOTE

-
- **The contents displayed on the remote display are for convenient observance only and cannot be used for diagnostic interpretation.**
 - **The user cannot operate the monitor through the remote display driver, namely, any operations performed through the remote display driver will not affect the monitor you observe.**
-

26.8 Wireless Network

The patient monitors, each equipped with a wireless network card, constitute a wireless network via AP (access point). The designated service engineer or personnel shall be responsible for installing and configuring the wireless network for you and perform relative performance tests as well.

The radio device used in the monitor is in compliance with the essential requirements and other relevant provisions of Directive 1999/5/EC (Radio Equipment and Telecommunications Terminal Equipment Directive).

NOTE

-
- **The design, installation, reconstruction and maintenance of the wireless network's distribution shall be performed by authorized service personnel of our company.**
 - **The existence of obstacles (such as wall) will exert impact on data transferring or even cause network interruption.**
 - **The Central Monitoring System is capable of connecting up to 16 bedside monitors via the wireless network.**
-





FOR YOUR NOTES

27 Batteries

27.1 Overview

The monitor is designed to operate on one or two rechargeable Lithium-ion battery whenever AC power supply is interrupted. The battery is charged whenever the patient monitor is connected to an AC power source regardless of whether or not the patient monitor is currently on. Since no external battery charger is supplied, the battery can only be charged inside the monitor so far. Whenever the AC power is interrupted during patient monitoring, the patient monitor will automatically run power from the internal batteries.

On-screen battery symbols indicate the battery status as follows:

-  Indicates that batteries work correctly. The solid portion represents the current charge level of the batteries in proportion to its maximum charge level.
-  Indicates that the batteries have low charge level and need to be charged.
-  Indicates that the batteries are almost depleted and need to be charged immediately.
-  Indicates that no batteries are installed or only one battery is installed.

The capacity of the internal battery is limited. If the battery capacity is too low, a technical alarm will be triggered and the **[Battery Too Low]** message displayed. At this moment, apply AC power to the patient monitor. Otherwise, the patient monitor will power off automatically before the battery is completely depleted.

NOTE

- **Take out the battery before the monitor is transported or will not be used for a long time.**
-

WARNING

- **Keep the battery out of children's reach.**
 - **Use only specified batteries.**
-
-

27.2 Installing the Batteries

The patient monitor uses two battery packs. If the two batteries have very different charge capacity, the message [**Diff. Battery Voltages**] is displayed. In this case, apply AC power to the patient monitor until the two batteries have approximately equal charge capacity or are both fully charged. You cannot use them before they have approximately equal charge capacity or are fully charged. In situations where no patient monitoring is performed or interrupting the patient monitoring is permitted, you can replace the batteries.

The patient monitor uses two batteries. You can install the batteries by following this procedure:

1. Turn off the patient monitor and disconnect the power cord and other cables.
2. Place the patient monitor with its face up.
3. Open the battery compartment door.

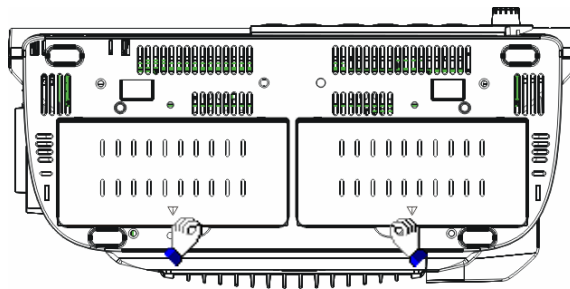

4. Place the batteries into the slots per the “+” and “-” indications.
5. Close the battery door and place the patient monitor upright.

27.3 Conditioning a Battery

A battery needs at least two conditioning cycles when it is put into use for the first time. A battery conditioning cycle is one complete, uninterrupted charge of the battery, followed by an uninterrupted discharge of the battery. Batteries should be conditioned regularly to maintain their useful life. Condition the batteries once when they are used or stored for two months, or when their run time becomes noticeably shorter.

To condition a battery, follow this procedure:

1. Disconnect the patient monitor from the patient and stop all monitoring and measuring procedures.
2. Insert the battery in need of conditioning into the battery slots of the patient monitor.
3. Apply AC power to the patient monitor and allow the battery to charge uninterruptedly for above 6 hours.
4. Remove AC power and allow the patient monitor to run from the battery until it shuts off.
5. Apply AC power again to the patient monitor and allow the battery to charge uninterruptedly for above 6 hours.
6. This battery is now conditioned and the patient monitor can be returned to service.

27.4 Checking a Battery

The performance of a rechargeable battery may deteriorate over time. To check the performance of a battery, follow this procedure:

1. Disconnect the patient monitor from the patient and stop all monitoring and measuring procedures.
2. Apply AC power to the patient monitor and allow the battery to charge uninterruptedly for above 6 hours.
3. Remove AC power and allow the patient monitor to run from the battery until it shuts off.
4. The operating time of the battery reflects its performance directly.

If the operating time of a battery is noticeably shorter than that stated in the specifications, replace the battery or contact your service personnel.

NOTE

-
- **Life expectancy of a battery depends on how frequent and how long it is used. For a properly maintained and stored lithium-ion battery, its life expectancy is about 3 years. For more aggressive use models, life expectancy can be less. We recommend replacing lithium-ion batteries every 3 years.**
 - **The operating time depends on the configuration and operation. For example, monitoring NIBP repeatedly will also shorten the operating time of the batteries.**
-

27.5 Recycling a Battery

When a battery has visual signs of damage, or no longer holds a charge, it should be replaced. Remove the old battery from the patient monitor and recycle it properly. To dispose of a battery, follow local laws for proper disposal.



WARNING

-
- **Do not disassemble batteries, or put them into fire, or cause them to short circuit. They may ignite, explode, or leak, causing personal injury.**
-

28 Care and Cleaning

Use only the substances approved by us and methods listed in this chapter to clean or disinfect your equipment. Warranty does not cover damage caused by unapproved substances or methods.

We make no claims regarding the efficacy of the listed chemicals or methods as a means for controlling infection. For the method to control infection, consult your hospital's Infection Control Officer or Epidemiologist.

Sterilization is not recommended for this monitor, related products, accessories or supplies unless otherwise indicated in the Instructions for Use that accompany the accessories and supplies.

To clean, disinfect and sterilize reusable transducers, sensors, cables, leads, and so forth, refer to the instructions delivered with the accessory.

28.1 General Points

Keep you equipment and accessories free of dust and dirt. To avoid damage to the equipment, follow these rules:

- Always dilute according the manufacturer's instructions or use lowest possible concentration.
- Do not immerse part of the equipment into liquid.
- Do not pour liquid onto the equipment or accessories.
- Do not allow liquid to enter the case.
- Never use abrasive materials (such as steel wool or silver polish), or erosive cleaners (such as acetone or acetone-based cleaners).

 **WARNING**

- **Be sure to shut down the system and disconnect all power cables from the outlets before cleaning the equipment.**
-
-

 **CAUTION**

- **If you spill liquid on the equipment or accessories, contact us or your service personnel.**
-

NOTE

- **To clean or disinfect reusable accessories, refer to the instructions delivered with the accessories.**
-

28.2 Cleaning

Your equipment should be cleaned on a regular basis. If there is heavy pollution or lots of dust and sand in your place, the equipment should be cleaned more frequently. Before cleaning the equipment, consult your hospital's regulations for cleaning the equipment.

Recommended cleaning agents are:

- mild soap (diluted)
- ammonia (diluted)
- sodium hypochlorite bleach (diluted)
- Hydrogen peroxide (3%)
- Ethanol (70%)
- Isopropanol (70%)

To clean your equipment, follow these rules:

1. Shut down the patient monitor and disconnect it from the power line.
2. Clean the display screen using a soft, clean cloth dampened with a glass cleaner.
3. Clean the exterior surface of the equipment using a soft cloth dampened with the cleaner.
4. Wipe off all the cleaning solution with a dry cloth after cleaning if necessary.
5. Dry your equipment in a ventilated, cool place.

28.3 Disinfecting

Disinfection may cause damage to the equipment and is therefore not recommended for this patient monitor unless otherwise indicated in your hospital's servicing schedule. Cleaning equipment before disinfecting is recommended.

The recommended disinfectants include: ethanol 70%, isopropanol 70%, glutaraldehyde-type 2% liquid disinfectants

CAUTION

-
- **Never use EtO or formaldehyde for disinfection.**
-

FOR YOUR NOTES

29 Maintenance

WARNING

- **Failure on the part of the responsible individual hospital or institution employing the use of this equipment to implement a satisfactory maintenance schedule may cause undue equipment failure and possible health hazards.**
 - **The safety checks or maintenance involving any disassembly of the equipment should be performed by professional servicing personnel. Otherwise, undue equipment failure and possible health hazards could result.**
 - **If you discover a problem with any of the equipment, contact your service personnel or us.**
-

29.1 Safety Checks

Before every use, after your patient monitor has been used for 6 to 12 months, or whenever your patient monitor is repaired or upgraded, a thorough inspection should be performed by qualified service personnel to ensure the reliability.

Follow these guidelines when inspecting the equipment:

- Make sure that the environment and power supply meet the requirements.
- Inspect the equipment and its accessories for mechanical damage.
- Inspect all power cords for damage, and make sure that their insulation is in good condition.
- Make sure that only specified accessories are applied.
- Inspect if the alarm system functions correctly.
- Make sure that the recorder functions correctly and the recorder paper meets the requirements.
- Make sure that the batteries meet the performance requirements.
- Make sure that the patient monitor is in good working condition.
- Make sure that the grounding resistance and leakage current meet the requirement.

In case of any damage or abnormality, do not use the patient monitor. Contact the hospital's biomedical engineers or your service personnel immediately.

29.2 Maintenance and Testing Schedule

The following maintenance and tests, except for visual inspection, power on test, touchscreen calibration, battery check and recorder check, shall be carried out by the service personnel only. Contact your service personnel if any maintenance is required. Make sure to clean and disinfect the equipment before any test and maintenance.

Check/Maintenance Item		Recommended Frequency
Preventative Maintenance Tests		
Visual inspection		1. When first installed or reinstalled.
NIBP test	Pressure check	1. If the user suspects that the measurement is incorrect. 2. Following any repairs or replacement of relevant module. 3. At least once a year.
	Leakage test	
	Calibration	
Sidestream and Microstream CO ₂ tests	Leakage test	
	Performance test	
	Calibration	
AG tests	Leakage test	
	Performance test	
	Calibration	
Performance Tests		
ECG test and calibration	Performance test	1. If the user suspects that the measurement is incorrect. 2. Following any repairs or replacement of relevant module. 3. At least once every two years. Note: At least once a year is recommended for NIBP, CO ₂ and AG test and calibration.
	Calibration	
Resp performance test		
SpO ₂ test		
NIBP test and calibration	Pressure check	
	Leakage test	
	Calibration	
Temp test		
IBP test and calibration	Performance test	
	Pressure calibration	
C.O. test		
Mainstream CO ₂ test and calibration		

Check/Maintenance Item		Recommended Frequency
Sidestream and Microstream CO ₂ tests and calibration	Leakage test	
	Performance test	
	Calibration	
AG test	Leakage test	
	Performance test	
	Calibration	
ICG test		
BIS test		
RM test		
CCO/SvO ₂ test	Interconnecting function	
	Output calibration	
Nurse call relay performance test		If the user suspects that the analog output does not work well.
Analog output performance test		
Electrical Safety Tests		
Electrical safety tests		At least once every two years.
Other Tests		
Power on test		1. When first installed or reinstalled. 2. Following any maintenance or the replacement of any main unit parts.
Touchscreen calibration		1. When the touchscreen appears abnormal. 2. After the touchscreen is replaced.
Recorder check		Following any repair or replacement of the recorder.
Network print test		1. When first installed. 2. Whenever the printer is serviced or replaced.
Battery check	Functionality test	1. When first installed. 2. Whenever a battery is replaced.
	Performance test	Once a year or if the battery run time reduced significantly.

29.3 Checking Monitor and Module Information

To view the information about system start time, selftest, etc., select [**Main Menu**]→[**Maintenance >>**]→[**Monitor Information >>**]. You can print out the information for the convenience of troubleshooting. The information will not be saved during shut down.

You can also view the information about the monitor configuration and system software version by selecting [**Main Menu**]→[**Maintenance >>**]→[**Software Version >>**].



29.4 Calibrating ECG

The ECG signal may be inaccurate due to hardware or software problems. As a result, the ECG wave amplitude becomes greater or smaller. In that case, you need to calibrate the ECG module.

1. Select the ECG parameter window or waveform area→[**Filter**]→[**Diagnostic**].
2. Select [**Main Menu**]→[**Maintenance >>**]→[**Calibrate ECG**]. A square wave appears on the screen and the message [**ECG Calibrating**] is displayed.
3. Compare the amplitude of the square wave with the wave scale. The difference should be within 5%.
4. After the calibration is completed, select [**Stop Calibrating ECG**].

You can print out the square wave and wave scale and then measure the difference between them if necessary. If the difference exceeds 5%, contact your service personnel.

29.5 Calibrating the Touchscreen

1. Select [**Main Menu**]→[**Maintenance >>**]→[**User Maintenance >>**]→enter the required password→[**Cal. Touchscreen**].
2.  will, in turn, appear at different positions of the screen.
3. Select each  as it appears on the screen.
4. After the calibration is completed, the message [**Screen Calibration Completed!**] is displayed. Select [**Ok**] to confirm the completion of the calibration.

29.6 Calibrating CO₂

For sidestream and microstream CO₂ modules, a calibration is needed every year or when the measured values have a great deviation. For maintream CO₂ module, no calibration is needed.

Tools required:

- A steel gas cylinder with 6±0.05% CO₂ and balance gas N₂
- T-shape connector
- Tubing

Follow this procedure to perform a calibration:

1. Make sure that the sidestream or microstream CO₂ module has been warmed up or started up.
2. Check the airway for leakage and perform a leakage test as well to make sure the airway has no leakage.
3. Select [**Main Menu**]→ [**Maintenance >>**]→ [**User Maintenance >>**]→ enter the required password→ [**Maintain CO₂ >>**]→ [**Calibrate CO₂ >>**].
4. In the [**Calibrate CO₂**] menu, select [**Zero**].
5. After the zero calibration is finished successfully, connect the equipment as follows:

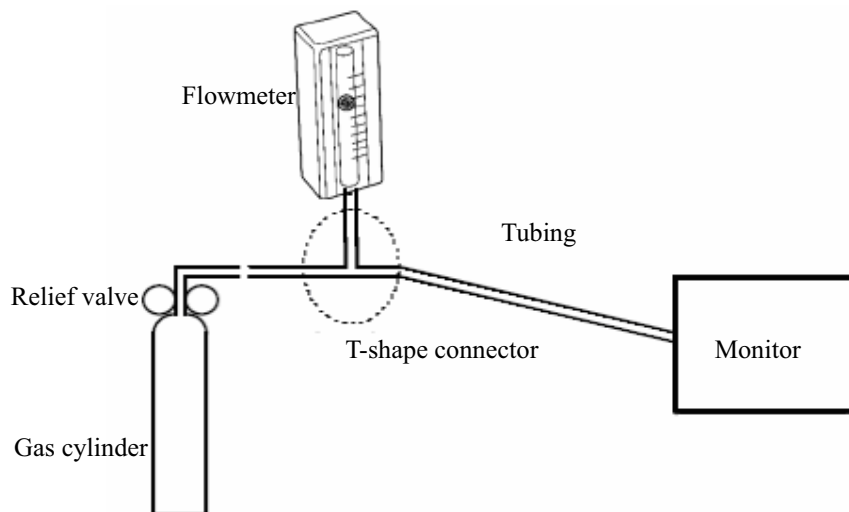

6. Turn on and adjust the relief valve to make the flowmeter reads within 10-50mL/min and keeps stable as well.

-
7. In the [**Calibrate CO2**] menu, enter the vented CO₂ concentration in the [**CO2**] field.
 8. In the [**Calibrate CO2**] menu, the measured CO₂ concentration is displayed. After the measured CO₂ concentration becomes stable, select [**Calibrate CO2**] to calibrate the CO₂ module.
 9. If the calibration is finished successfully, the message [**Calibration Completed!**] is displayed in the [**Calibrate CO2**] menu. If the calibration failed, the message [**Calibration Failed!**] is displayed. In this case, perform another calibration.

29.7 Calibrating AG

Calibrate the AG module every year or when the measured value has a great deviation.

Tools required:

- Gas bottle, with a certain standard gas or mixture gas. Gas concentration should meet the following requirements: AA>1.5%, CO₂>1.5%, N₂O>40%, O₂>40%, of which AA represents an anesthetic agent. $a/c \leq 0.01$ (a is the gas absolute concentration accuracy; c is the gas concentration)
- T-shape connector
- Tubing

Follow this procedure to perform a calibration:

1. Select [**Main Menu**]→[**Maintenance >>**]→[**User Maintenance >>**]→enter the required password→[**Calibrate AG >>**].
2. Check the airway and make sure that there are no occlusions or leaks.
 - ◆ Vent the tubing to the air and check if the [**Current FlowRate**] and [**Set FlowRate**] are approximately the same. If the deviation is great, it indicates that there is an occlusion in the tubing. Check the tubing for an occlusion.
 - ◆ Perform a leakage test to make sure that the airway has no leakage.
3. Connect the test system as follows:

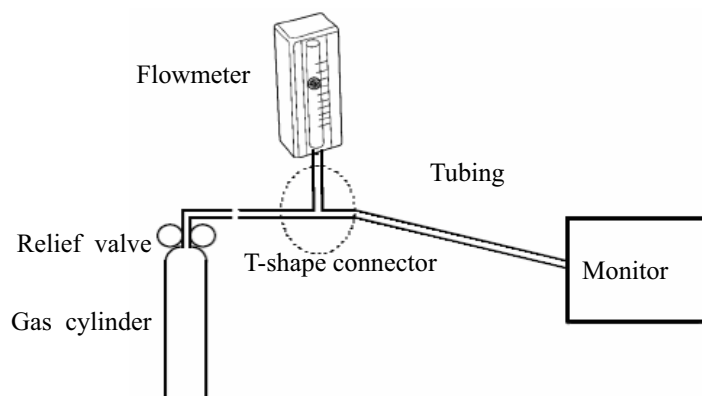

-
4. Open the relief valve and vent a certain standard gas or gas mixture. Adjust the relief valve to make the flowmeter reads within 10-50mL/min and keeps stable as well.
 5. In the [**Calibrate AG**] menu, the concentration and flowrate of each measured gas are displayed
 - ◆ If the difference between the measured gas concentration and the actual one is very small, a calibration is not needed.
 - ◆ If the difference is great, you should perform a calibration. Select [**Calibrate >>**] to enter the calibrate menu.
 6. Enter the vented gas concentration. If you use only one gas for calibration, set other gases' concentration to 0.
 7. Select [**Calibrate**] to start calibration.
 8. If the calibration is finished successfully, the message [**Calibration Completed!**] is displayed. If the calibration failed, the message [**Calibration Failed!**] is displayed. Perform another calibration.

 **CAUTION**

- **If the O2 module has been transported for long distance, calibrate it when installing the monitor.**
-

29.8 Electrical Safty Tests

Refer to *E Electrical Safty Inspection*.

29.9 Setting up IP Address

1. Select [**Main Menu**]→[**Maintenance >>**]→[**User Maintenance >>**]→enter the required password and then select [**Network Setup >>**] from the popup menu.
2. If your monitor is equipped with a wireless AP, you can set [**Network Type**] to [**WLAN**] in the network setup menu. Otherwise, the default setting is [**LAN**].
3. Set [**IP Address**].

If the patient monitor is connected to a CMS, its IP address should be set up. The user should not change the patient monitor's IP address randomly. If you want to know details about IP address setup, contact the technical personnel in charge of the CMS.

29.10 Entering/Exiting Demo Mode

To enter the Demo mode:

1. Select [**Main Menu**]→[**Maintenance >>**].
2. Select [**Demo >>**]. Enter the required password and then select [**Ok**].

To exit the Demo mode:

1. Select [**Main Menu**]→[**Maintenance >>**].
2. Select [**Exit Demo**] and then select [**Ok**].
3. The patient monitor exits the Demo mode.

WARNING

- **The Demo mode is for demonstration purpose only. To avoid that the simulated data are mistaken for the monitored patient's data, you must not change into Demo mode during monitoring. Otherwise, improper patient monitoring and delayed treatment could result.**
-

30 Accessories

WARNING

- **Use accessories specified in this chapter. Using other accessories may cause damage to the patient monitor or not meet the claimed specifications.**
 - **Single-use accessories are not designed to be reused. Reuse may cause a risk of contamination and affect the measurement accuracy.**
 - **Check the accessories and their packages for any sign of damage. Do not use them if any damage is detected.**
-

30.1 ECG Accessories

ECG Electrodes

Model	Quantity	Patient Category	Part No.
210	10 pieces	Adult	0010-10-12304

12-Pin Trunk Cables

Leadwire supported	Compatible with	Type	Patient Category	Part No.
3-leadwire	AHA, IEC	Defibrillator-proof	Pediatric, neonate	0010-30-42720
3-leadwire	AHA, IEC	ESU-proof		0010-30-42724
3/5-leadwire	AHA, IEC	Defibrillator-proof	Adult, pediatric	0010-30-42719
3/5-leadwire	AHA, IEC	ESU-proof		0010-30-42723

Cable Sets

3-Electrode Cable Sets					
Type	Compatible with	Model	Patient Category	Part No.	Remark
Clip	AHA	EL6303A	Adult, pediatric	0010-30-42731	Long
		EL6305A	Neonate	0010-30-42896	/
Snap	AHA	EL6301B	Adult, pediatric	0010-30-42734	/

5-Electrode Cable Sets					
Type	Compatible with	Model	Patient Category	Part No.	Remark
Clip	AHA	EL6501A	Adult, pediatric	0010-30-42727	/
		EL6503A		0010-30-42729	Long
Snap	AHA	EL6501B		0010-30-42735	/

30.2 SpO₂ Accessories

Extension Cable

Module type	Remarks	Part No.
MPM SpO ₂ Module	/	0010-20-42710
Masimo SpO ₂ Module	8 pins, purple connector	040-000332-00
	7 pins, white connector	0010-30-42738

SpO₂ Sensors

The SpO₂ sensor material that patients or other staff will come into contact with have undertaken the bio-compatibility test and is verified to be in compliance with ISO 10993-1.

MPM SpO ₂ Module			
Type	Model	Patient Category	Part No.
Single patient use	520A	Adult	520A-30-64101
	520P	Pediatric	520P-30-64201
	520I	Infant	520I-30-64301
	520N	Neonate	520N-30-64401
Reusable	518B	Adult, pediatric, neonate (Multi-sites)	518B-30-72107
	512F	Child, Infant, Neonate	512F-30-28263
	512H	Child, Infant, Neonate	734J /52/9; 283

Masimo SpO₂ Module				
Type	Model	Patient Category	Remark	Part No.
Reusable	\	Adult (>30 kg)	LNCS DCI	0600-00-0126
	\	Pediatric (10 to 50 kg)	LNCSDCIP	0600-00-0127
Single patient use	\	Adult (>30 kg)	LNCS Amtx	0600-00-0121
	\	Pediatric(10 to 50 kg)	LNCS Pmtx	0600-00-0122
	\	Infant (3 to 20 kg)	LNCS INF-L	0600-00-0124
	\	Neonate (<3 kg and > 40 kg)	LNCS NEO-L	0600-00-0158
	\	Neonate Pre-term (<1kg)	LNCS NEO PT-L	0600-00-0125

- Wavelength emitted by the sensors intended for MPM SpO₂ module red light: 660 nm, infrared light: 905 nm.
- Wavelength emitted by the sensors intended for Masimo SpO₂ module: red light: 660 nm, infrared light: 940 nm.
- The maximum photic output consumption of the sensor is less than 18 mW.

The information about the wavelength range and maximum photic output consumption can be especially useful to clinicians, for example, clinicians performing photodynamic therapy.

30.3 NIBP Accessories

Reusable Cuff

Model	Patient Category	Measurement Site	Limb Circumference (cm)	Bladder Width (cm)	Part No.
\	Child	Arm	10 to 19	9.2	0683-15-0001-01
\	Small adult		18 to 26	12.2	0683-15-0002-01
\	Adult		25 to 35	15.1	0683-15-0003-01
\	Large adult		33 to 47	18.3	0683-15-0004-01
\	Adult	Thigh	46 to 66	22.5	0683-15-0005-01
\	Blood Pressure Cuff Starter Kit			\	0020-00-0184-01

Single-Patient Cuff

Model	Patient Category	Measurement Site	Limb Circumference (cm)	Bladder Width (cm)	Part No.
CM1500A	Neonate	Arm	3.1 to 5.7	2.2	001B-30-70692
CM1500B			4.3 to 8.0	2.9	001B-30-70693
CM1500C			5.8 to 10.9	3.8	001B-30-70694
CM1500D			7.1 to 13.1	4.8	001B-30-70695

Disposable Cuff

Model	Patient Category	Measurement Site	Limb Circumference (cm)	Bladder Width (cm)	Part No.
\	Child	Arm	10 to 19	7.2	0683-14-0001-01
\	Small adult		18 to 26	9.8	0683-14-0002-01
\	Adult		25 to 35	13.1	0683-14-0003-01
\	Large adult		33 to 47	16.5	0683-14-0004-01
\	Adult	Thigh	46 to 66	20.5	0683-14-0005-01

30.4 Temp Accessories

Extension Cable

Type	Model	Temp probe	Part No.
Reusable	MR420B	MR411, MR412	0011-30-37391

Temp Probes

Type	Model	Patient Category	Measurement Site	Part No.
Reusable	MR401B	Adult	Esophageal/Rectal	0011-30-37392
	MR403B		Skin	0011-30-37393
	MR402B	Pediatric, neonate	Esophageal/Rectal	0011-30-37394
	MR404B		Skin	0011-30-37395
Disposable	MR411	Adult, pediatric, neonate	Esophageal/Rectal	0011-30-37398
	MR412		Skin	0011-30-37397

30.5 IBP Accessories

Accessories Kit No.	Components	Part No.
\	IM2202 12 Pin IBP Cable (for BD)	001C-30-70757
\	IM2201 12 Pin IBP Cable (for Hospira)	001C-30-70759
\	IBP cable adapter (12 pin to 6 pin)	0010-20-42795
\	12 Pin IBP Cable for Memscap (SP844 transducer)	0010-21-43082
\	12 Pin IBP Cable for Edwards	0010-21-12179

It is proved through tests that the following accessories are compatible with the patient monitor. Only the accessories preceded by “*” are available from our company. If you want to purchase other accessories, contact respective manufacturers and make sure if these accessories are approved for sale in local.

Manufacturer	Accessories
Smith Medical (Medex)	MX961Z14 Logical Cable, to be used in connection with the Adapter Cable (0010-20-42795) MX960 Reusable Transducer Kit MX9605A Logical 84in(213cm) Single Monitoring Kit MX960 Logical Transducer Mounting Plate MX261 Logical Clamp For Transducer Bracket MX262 Logical Clamp For 2 Transducer Mount Plates (More Logical Clamps are available from Medex. For detailed information, contact Medex.)
Braun	IBP Reusable Cable (REF: 5203511), to be used in connection with the Adapter Cable (0010-20-42795) Combitrans Monitoring Set (contact Braun for detailed information) Combitrans Attachment Plate Holder (REF: 5215800) Combitrans Attachment Plate (contact Braun for detailed information)
Memscap	*Truck cable (0010-21-43082) SP844 Physiological Pressure Transducer 844-26 Monitoring Line Set 84X-49 Mounting Bracket
Utah	Reusable Blood Pressure Monitor Interface Cable (REF: 650-206) Deltran Disposable Pressure Transducer System (More Deltran sensors are available from Utah. For detailed information, contact Utah.) Pole Mount Unit (ERF: 650-150) Deltran Three Slot Organizer, Attaches to I.V. Pole Mount (REF: 650-100) Deltran Four Slot Organizer, Attaches to I.V. Pole Mount (REF: 650-105)
Edwards	* IBP Truwave Reusable Cable (0010-21-12179) Pressure Monitoring Kit With Truwave Disposable Pressure Transducer. (More Truwave sensors are available from Edwards. For detailed information, contact Edwards.) DTSC IV Pole Clamp for Model DTH4 Backplate Holder DTH4 Disposable Holder for DPT

30.6 C.O. Accessories

Model	Material	Part No.
COC-001-SL	12Pin C.O. cable.	0010-30-42743
SP4042	TI Sensor	6000-10-02079
SP5045	TI Sensor Housing	6000-10-02080
MX387	12CC Control Syringe W/1CC Stop W/Rotator	6000-10-02081
131HF7	Thermodilution Catheter	6000-10-02183
9850A	Cable kit with TI Sensor	0012-00-1519

30.7 CCO/SvO₂ Accessories

Material	PN
CCO/SvO ₂ cable	009-000259-00

30.8 CO₂ Accessories

Sidestream CO₂ module

Material	Patient Category	Remark	Part No.
DRYLINE Watertrap	Adult, pediatric	Reusable	9200-10-10530
DRYLINE Watertrap	Neonate		9200-10-10574
Sampling Line, Adult 2.5m	Adult, pediatric	Disposable	9200-10-10533
Sampling Line, Neonate, 2.5m	Neonate		9200-10-10555
Adult Nasal CO ₂ Sample Cannula	Adult		M02A-10-25937
Pediatric Nasal CO ₂ Sample Cannula	Pediatric		M02A-10-25938
Infant Nasal CO ₂ Sample Cannula	Infant		M02B-10-64509
DRYLINE Airway Adapter	/	Straight	9000-10-07486

Ordion Microstream CO₂ module

Material	Patient Category	Remark	Part No.
Starter kit	\	\	6800-30-50619

Mainstream CO₂ Module

Material	Model	Patient Category	Remark	Part No.
Airway adapter	6063	Adult	Disposable	0010-10-42662
	6421		Disposable, with mouthpiece	0010-10-42663
	6312	Neonate	Disposable	0010-10-42664
Mask	9960STD	Adult	/	0010-10-42670
	9960LGE		Adult large	0010-10-42671
	9960PED	Pediatric	/	0010-10-42669
Cable management straps	/	/	/	0010-10-42667
Sensor holding clips	/	/	/	0010-10-42668
Sensor	/	Adult, pediatric, neonate	Reusable	6800-30-50760

30.9 AG Accessories

Material	Patient Category	Remark	Part No.
Watertrap	Adult, pediatric	Reusable	9200-10-10530
	Neonate		9200-10-10574
Sampling line	Adult, pediatric	Disposable	9200-10-10533
	Neonate		9200-10-10555
Airway adapter	Adult, pediatric, neonate	Disposable, straight	9000-10-07486
	Adult, pediatric, neonate	Disposable, elbow	9000-10-07487

30.10 ICG Accessories

Material	Part No.
BioZ tect ICG sensor	0010-10-43258
BioZ Dx ICG Patient Cable	040-000543-00
BioZ Dx ICG Lead Wire	040-000544-00

30.11 BIS Accessories

Material	Patient Category	Part No.
BIS Cable	Adult, pediatric	6800-30-50761

30.12 RM Accessories

Material	Patient Category	Remark	Part No.
Flow sensor	Adult, pediatric	Reusable	0010-30-42678
	Adult, pediatric	Disposable	0010-30-42679
	Infant	Disposable	0010-30-42680
RM connector	/	/	6800-20-50328

30.13 Others

Material	Part No.
Lithium battery	022-000008-00
	M05-010002-06
CF storage card	0000-10-11160
Analog output cable	6800-20-50146
Defibrillator synchronization cable	009-000027-00
Data output software package	6800-30-51213
Domestic power cord (America)	DA8K-10-14452

Power cord (Australia, orange, 10A, 1.5M)	009-002636-00
Grounding cable	1000-21-00122
Nurse call cable	8000-21-10361
Satellite module rack wall mount bracket	0010-30-42867
Main unit wall mount bracket	0010-30-42955
Display wall mount bracket	0010-30-42956
Roll stand (for DPM 6 only)	0010-30-43043
Roll stand (for DPM 7 only)	0010-30-42943 *
Thermal paper, one roll (50mm × 20 m)	0683-00-0505-01
Rolling Stand & SMR Mount (for DPM 6 only)	0010-30-43049
Rolling Stand & SMR Mount (for DPM 7 only)	0010-30-42944
6802 Transition plate kit (for DPM 6 only)	115-003441-00

* Not available in the United States.

FOR YOUR NOTES

A Product Specifications

A.1 Monitor Safety Specifications

A.1.1 Classifications

The patient monitor is classified, according to IEC60601-1:

Components	Type of protection against electrical shock	Degree of protection against electrical shock	Degree of protection against harmful ingress of water	Degree of protection against hazards of explosion	Mode of operation
Main unit	I	Not marked	Ordinary	Not suitable	Continuous
Secondary display		Not marked			
MPM	NA	CF(*)			
IBP module					
C.O. module					
BIS module					
AG module					
ICG module		BF(*)			
CO ₂ module					
RM module					
SMR	Not marked				
CCO/SvO ₂ module	Not marked				

- I: Class I equipment
- BF: Type BF applied part. (*Defibrillator-proof protection against electric shock.)
- CF: Type CF applied part. (*Defibrillator-proof protection against electric shock.)
- NA: Not applicable
- Ordinary: Ordinary equipment (enclosed equipment without protection against ingress of water)
- Not suitable: Equipment not suitable for use in the presence of a flammable anesthetic mixture with air with oxygen or nitrous oxide.

A.1.2 Environmental Specifications

Main unit, MPM, IBP module, C.O. module, Recorder, CCO/SvO2 module		
Item	Operating conditions	Storage conditions
Temperature (°C)	5 to 40	-20 to 60
Relative humidity (noncondensing)	15% to 95%	10% to 95%
Barometric (mmHg)	425 to 809	120 to 809

Microstream CO₂ module		
Item	Operating conditions	Storage conditions
Temperature (°C)	0 to 40	-20 to 60
Relative humidity (noncondensing)	15% to 95%	10% to 95%
Barometric (mmHg)	430 to 795	430 to 795

Sidestream CO₂ module		
Item	Operating conditions	Storage conditions
Temperature (°C)	5 to 35	-20 to 60
Relative humidity (noncondensing)	15% to 95%	15% to 95%
Barometric (mmHg)	428 to 790	428 to 790

Mainstream CO₂ module		
Item	Operating conditions	Storage conditions
Temperature (°C)	10 to 40	-10 to 50
Relative humidity (noncondensing)	10% to 90%	0% to 90%
Barometric (mmHg)	400 to 850	400 to 850

AG module		
Item	Operating conditions	Storage conditions
Temperature (°C)	10 to 40	-20 to 70
Relative humidity (noncondensing)	15% to 95%	10% to 95%
Barometric (mmHg)	525 to 900	525 to 900

RM module		
Item	Operating conditions	Storage conditions
Temperature (°C)	5 to 40	-20 to 60
Relative humidity (noncondensing)	15% to 95%	10% to 95%
Barometric (mmHg)	500 to 800	500 to 800

BIS module		
Item	Operating conditions	Storage conditions
Temperature (°C)	0 to 40	-20 to 50
Relative humidity (noncondensing)	10% to 95%	10% to 95%
Barometric (mmHg)	356 to 760	356 to 760

ICG module		
Item	Operating conditions	Storage conditions
Temperature (°C)	10 to 40	0 to 50
Relative humidity (noncondensing)	15% to 95%	15% to 95%
Barometric (mmHg)	619 to 780	619 to 780

A.1.3 Power requirements

Line voltage	100 to 240 VAC
Current	2.8 to 1.6 A
Frequency	50/60 Hz
Fuse	Time-lag 250V T4A

A.2 Physical Specifications

Components	Weight	Size	Equipment type
Main unit	<14.5 kg	400×370×193 mm	Includes a 17" touchscreen, an MPM, an AG module, two lithium batteries, a recorder, CF components, but no accessories.
SMR	<1.8 kg	142×402×151 mm	With no module inserted
MPM	<0.63 kg	136.5×80.5×102 mm	
IBP module	<0.25 kg	136.5×40×102 mm	
C.O. module	<0.25 kg	136.5×40×102 mm	Not available in USA
Sidestream CO ₂ module	<0.48 kg	136.5×80.5×102 mm	
Microstream CO ₂ module	<0.37 kg	136.5×40×102 mm	
Mainstream CO ₂ module	<0.50 kg	136.5×40×102 mm	
M-type AG module	<1.75 kg	136.5×121×102 mm	With O ₂ and BIS modules
A-type AG module	<1.75 kg	136.5×121×102 mm	With O ₂ and BIS modules
ICG module	<0.35 kg	136.5×40×102 mm	
BIS module	<0.25 kg	136.5×40×102 mm	
RM module	<0.27 kg	136.5×40×102 mm	
CCO/SvO ₂ module	<0.25 kg	136.5×40×102 mm	

A.3 Hardware Specifications

A.3.1 Display

Host display	
Screen type	Color TFT LCD
Screen Size (diagonal)	17"
Resolution	1280×1024 pixels
External display	
Screen type	Medical-grade TFT LCD
Screen Size	15", 17" or above
Resolution	1024×768 pixels
EMC	MPR II, CISPR 11B
Third certificate	UL, C-UL, TUV, CE, FCC

A.3.2 Recorder

Method	Thermal dot array
Horizontal resolution	16 dots/mm (25 mm/s paper speed)
Vertical resolution	8 dots/mm
Paper width	50 mm
Paper length	20 m
Paper speed	25 mm/s, 50 mm/s
Number of waveform channels	1, 2, or 3 (optional)

A.3.3 Battery

Size	147.5×60.4×23.8 mm
Weight	350 g
Number of batteries	2
Battery Type	Chargeable Lithium-Ion
Voltage	11.1 VDC
Capacity	4500 mAh
Run time	120 min when powered by two new fully-charged batteries respectively (25°C, ECG, SpO2, Auto NIBP measurements at intervals of 15 minutes)
Charge time	nearly 5.5 h to 90% nearly 6 h to 100%
Shutdown delay	at least 5 min (after a low battery alarm first occurs)

A.3.4 LEDs

Alarm lamp	1 (two color coded: yellow and red)
Technical alarm lamp	1 (blue)
Power on LED	1 (green)
AC power LED	1 (green)
Battery LED	1 (green)

A.3.5 Audio Indicator

Speaker	Give alarm tones (45 to 85 dB), key tones, QRS tones; support PITCH TONE and multi-level tone modulation; alarm tones comply with IEC60601-1-8.
---------	---

A.3.6 Monitor Interface Specifications

Power	1 AC power input connector
Wire network	2 RJ45 connector, 100 Base-TX, IEEE 802.3
USB	up to 10 connectors, USB 1.1
SMR connector	1 connector, not standard USB
CF	50-pin CF revision 2.0 connector
Video interface	1 connector, standard DVI-D
Nurse call	1 connector, standard BNC
Equipotential Grounding Terminal	1
Micro-D connector	1 connector, It outputs ECG, IBP and defibrillator synchronization signals simultaneously

A.3.7 Outputs

Auxiliary Output	
Standard	Meets the requirements of IEC60601-1 for short-circuit protection and leakage current
Output impedance	50Ω rating
ECG Analog Output	
Bandwidth (-3dB; reference frequency: 10Hz)	Diagnostic mode: 0.05 to 150 Hz Monitor mode: 0.5 to 40 Hz Surgical mode: 1 to 20 Hz
Max transmission delay	25 ms (in diagnostic mode, and with Notch off)
Sensitivity	1V/mV ±5%
PACE rejection/enhancement	Pace enhancement Signal amplitude: $V_{oh} \geq 2.5V$ Pulse width: 10ms±5% Signal rising and falling time: $\leq 100\mu s$
IBP Analog Output	
Bandwidth (-3dB; reference frequency: 1Hz)	DC to 50 Hz
Max transmission delay	30 ms (with Notch off)
Sensitivity	1 V/100 mmHg ±5%

Nurse Call Signal	
Output mode	Relay
Electrical requirements	$\leq 60\text{W}$, $\leq 2\text{A}$, $\leq 36\text{VDC}$, $\leq 25\text{VAC}$
Isolation voltage	1500 VAC
Contact type	Normally open or normally contact (optional)
Defib Sync Pulse	
Output impedance	50 Ω
Max time delay	35 ms (R-wave peak to leading edge of pulse)
Amplitude	High level: 3.5 to 5 V, providing a maximum of 1 mA output current; Low level: < 0.5 V, receiving a maximum of 5 mA input current.
Pulse width	100 ms $\pm 10\%$
Limited current	15 mA rating
Rising and falling time	≤ 1 ms
Digital video output (DVI-D connector)	
Video signals	Single Link TMDS
DDC signals	Signals 12C compliant

A.4 Data Storage

Trends	Trends: 120 hours, at 1 min resolution Mid-length trends: 4 hours, at 5 s resolution Minitrends: 1 hour, at 1 s resolution
Parameter alarms	100 alarms and manual events and related parameter waveforms. The waveform recording length can be 8s.
Arrh. events	100 arrhythmia events and relate waveforms and parameters. The waveform recording length can be 8s.
NIBP measurements	1000 sets
Interpretation of resting 12-lead ECG results	20 sets
Full-disclosure waveforms	48 hours at maximum. The specific storage time depends on the waveforms stored and the number of stored waveforms.

A.5 Wireless Network

Standards	IEEE 802.11g, Wi-Fi compatible						
Frequenct range	2.412 to 2.462GHz						
Operating channel	China	America	Canada	Europe	Spain	France	Japan
	1 to 11				10, 11		2
	For other country, please refer to your local law.						
Safe distance	a circle centering AP with the radius of 10 m						

A.6 Measurement Specifications

The adjustable range of alarm limits is the same with the measurement range of signals unless otherwise specified.

A.6.1 ECG

ECG	
Standards	Meet standards of EC11, EC13, EN60601-2-27/IEC60601-2-27 and IEC60601-2-25
Lead set	3-lead: I, II, III 5-lead: I, II, III, aVR, aVL, aVF, V 12-lead: I, II, III, aVR, aVL, aVF, V1 to V6
ECG standard	AHA, IEC
Display sensitivity	1.25 mm/mV (X0.125), 2.5 mm/mV (X0.25), 5 mm/mV (X0.5), 10 mm/mV (X1), 20 mm/mV (X2), 40 mm/mV (X4), Auto
Sweep speed	6.25 mm/s, 12.5 mm/s, 25 mm/s, 50 mm/s
Bandwidth (-3dB)	Diagnostic mode: 0.05 to 150 Hz Monitor mode: 0.5 to 40 Hz Surgical mode: 1 to 20 Hz
Common mode rejection ratio (with Notch off)	Diagnostic mode: ≥ 90 dB Monitor mode: ≥ 105 dB Surgical mode: ≥ 105 dB
Notch	50/60 Hz Monitor and surgical mode: Notch turns on automatically. Diagnostic mode: Notch is turned on/off manually
Differential input impedance	$\geq 5 \text{ M}\Omega$
Input signal range	$\pm 8 \text{ mV}$ (peak-to-peak value)
Accuracy of reappearing input signal	Use A and D methods based on EC11 to determine system total error and frequency response.
Electrode offset potential tolerance	$\pm 500 \text{ mV}$
Lead-off detection current	Measuring electrode: $< 0.1 \mu\text{A}$ Drive electrode: $< 1 \mu\text{A}$
Input offset current	$\leq 0.1 \mu\text{A}$
Baseline recovery time	$< 5 \text{ s}$ (after defibrillation)
Patient leakage current	$< 10 \mu\text{A}$
Calibration signal	1mV (peak-to-peak value)

ESU protection	<p>Cut mode: 300 W</p> <p>Coagulate mode: 100 W</p> <p>Recovery time: ≤10 s</p> <p>In compliance with the requirements in clause 4.2.9.14 of ANSI/AAMI EC 13:2002</p>
ESU noise suppression	Based on the test method in clause 5.2.9.14 of EC 13:2002, use ECG lead wires which are in compliance with AAMI. Compared with ECG baseline, the noise of peak to peak value ≤2 mV.
Pace Pulse	
Pace pulse markers	<p>Pace pulses meeting the following conditions are labelled with a PACE marker:</p> <p>Amplitude: ±2 to ±700 mV</p> <p>Width: 0.1 to 2 ms</p> <p>Rise time: 10 to 100 µs</p>
Pace pulse rejection	<p>When tested in accordance with the ANSI/AAMI EC13-2002: Sections 4.1.4.1 and 4.1.4.3, the heart rate meter rejects all pulses meeting the following conditions.</p> <p>Amplitude: ±2 to ±700 mV</p> <p>Width: 0.1 to 2 ms</p> <p>Rise time: 10 to 100 µs</p>

Basic algorithm

HR			
Measurement range	<table border="1"> <tr> <td>3-, 5-, and 12-lead ECG</td> <td> <p>Neonate: 15 to 350 bpm</p> <p>Pediatric: 15 to 350 bpm</p> <p>Adult: 15 to 300 bpm</p> </td> </tr> </table>	3-, 5-, and 12-lead ECG	<p>Neonate: 15 to 350 bpm</p> <p>Pediatric: 15 to 350 bpm</p> <p>Adult: 15 to 300 bpm</p>
3-, 5-, and 12-lead ECG	<p>Neonate: 15 to 350 bpm</p> <p>Pediatric: 15 to 350 bpm</p> <p>Adult: 15 to 300 bpm</p>		
Resolution	1 bpm		
Accuracy	3-, 5-, and 12-lead ECG: ±1 bpm or ±1%, whichever is greater.		
Sensitivity	200µV (lead II)		
HR averaging method	<p>In compliance with the requirements in Clause 4.1.2.1 d) of ANSI/AAMI EC13-2002, the following method is used:</p> <p>If the last 3 consecutive RR intervals are greater than 1200 ms, the 4 most recent RR intervals are averaged to compute the HR. Otherwise, heart rate is computed by subtracting the maximum and minimum ones from the most recent 12 RR intervals and then averaging them.</p> <p>The HR value displayed on the monitor screen is updated every second.</p>		
Response to irregular rhythm	In compliance with the requirements in Clause 4.1.2.1 e) of		

	ANSI/AAMI EC13-2002, the heart rate after 20 seconds of stabilization is displayed as follows: Ventricular bigeminy (3a): -80 ± 1 bpm Slow alternating ventricular bigeminy (3b): -60 ± 1 bpm Rapid alternating ventricular bigeminy (3c): -120 ± 1 bpm Bidirectional systoles (3d): -90 ± 2 bpm
Response time to heart rate change	Meets the requirements of ANSI/AAMI EC13-2002: Section 4.1.2.1 f). From 80 to 120 bpm: less than 11 s From 80 to 40 bpm: less than 11 s
Time to alarm for tachycardia (not available in USA)	Meets the requirements of ANSI/AAMI EC13-2002: section 4.1.2.1 g). Waveform 4ah - range: 11 s 4a - range: 11 s 4ad - range: 11 s Waveform 4bh - range: 11 s 4b - range: 11 s 4bd - range: 11 s
Tall T-wave rejection capability	When the test is performed based on part 4.1.2.1 c) of ANSI/AAMI EC 13-2002, the heart rate meter will reject all 100 ms QRS complexes with less than 1.2 mV of amplitude, and T waves with T-wave interval of 180 ms and those with Q-T interval of 350 ms.
Arrhythmia Analysis Classifications (Not available in USA)	Asystole, VFib/VTac, Couplet, Bigeminy, Trigeminy, R on T, VT>2, PVC, Tachy, Brady, Missed Beats, PNP, PNC
ST Segment Analysis (Not available in USA)	
Measurement range	-2.0 to 2.0 mV
Accuracy	-0.8 to 0.8 mV: ± 0.02 mV or $\pm 10\%$, whichever is greater. Beyond this range: Not specified.
Refreshing rate	10 s

Mortara algorithm

Only the differences from the Basic algorithm are listed.

HR	
HR averaging method	<p>In compliance with the requirements in Clause 4.1.2.1 d) of ANSI/AAMI EC13-2002, the following method is used:</p> <p>Heart rate is computed by averaging the most recent 16 RR intervals, unless the HR by averaging the most recent 4 heart beats is less than or equals to 48.</p> <p>The HR value displayed on the monitor screen is updated every second.</p>
Time to alarm for tachycardia	<p>Meets the requirements of ANSI/AAMI EC13-2002: section 4.1.2.1 g).</p> <p>Waveform</p> <p>4ah – range: 11 s</p> <p>4a – range: 11 s</p> <p>4ad – range: 11 s</p> <p>4bh – range: 11 s</p> <p>4b – range: 11 s</p> <p>4bd – range: 11 s</p>
Arrhythmia Analysis Classifications	<p>Asystole, Vfib, Vtac, Vent. Rhythm, Couplet, VT>2, Bigeminy, Trigeminy, R on T, Multif. PVC, Irr. Rhythm, Tachy, Brady, Missed Beats, PNP, PNC</p>
ST Segment Analysis	
Refreshing rate	per 16 heartbeats

A.6.2 Resp

Technique	Trans-thoracic impedance	
Lead	Options are lead I and II. The default is lead II.	
Respiration excitation waveform	<300 μ A, sinusoid, 62.8 kHz (\pm 10%)	
Respiration impedance range	0.3 to 5 Ω	
Baseline impedance range	200 to 2500 Ω (using an ECG cable with 1k Ω resistance)	
Differential input impedance	>2.5 M Ω	
Bandwidth	0.2 to 2 Hz (-3 dB)	
Sweep speed	6.25 mm/s, 12.5 mm/s or 25 mm/s	
Respiration Rate		
Measurement range	Adult: 0 to 120 rpm Pediatric, neonate: 0 to 150 rpm	
Resolution	1 rpm	
Accuracy	7 to 150 rpm: \pm 2 rpm or \pm 2%, whichever is greater 0 to 6 rpm: Not specified.	
Apnea alarm time	10 s, 15 s, 20 s, 25 s, 30 s, 35 s, 40 s	
Alarm limit	Range (rpm)	Step (rpm)
RR High	Off, (low limit + 2) to 100	1
RR Low	Off, 0 to (high limit - 2)	

A.6.3 SpO2

Alarm limit	Range (%)		Step (%)
SpO2 High	Off, (low limit + 1) to 100		1
SpO2 Low	Desat to (high limit – 1)		
Desat	MPM, Masimo:	0 to (high limit – 1)	
	Nellcor:	20 to (high limit – 1)	

MPM SpO2 Module

Standards	Meet standards of ISO9919		
<p>*Measurement accuracy verification: The SpO2 accuracy has been verified in human experiments by comparing with arterial blood sample reference measured with a CO-oximeter. Pulse oximeter measurement are statistically distributed and about two-thirds of the measurements are expected to come within the specified accuracy range compared to CO-oximeter measurements.</p>			
Measurement range	0 to 100%		
Resolution	1%		
Accuracy	70 to 100%: ±2% (measured without motion in adult/pediatric mode) 70 to 100%: ±3% (measured without motion in neonate mode) 70 to 100%: ±3% (measured with motion) 0% to 69%: Not specified.		
<p>*Studies were performed to validate the accuracy of Pulse Oximeter with neonatal SpO2 sensors by contrast with a CO-Oximeter. Some neonates aged from 1 day to 30 days with a gestation age of 22 weeks to full term were involved in this study. The statistical analysis of data of this study shows the accuracy (Arms) is within the stated accuracy specification. Please see the following table.</p>			
Sensor type	Totally neonates	Data	Arms
518B	97 (51 male & 46 female)	200 pairs	2.38%
520N	122 (65 male & 57 female)	200 pairs	2.88%
The Pulse Oximeter with neonatal SpO2 sensors was also validated on adult subjects.			
Refreshing rate	1 s		
SpO ₂ averaging time	7 s (When the sensitivity is set to High) 9 s (When the sensitivity is set to Medium) 11 s (When the sensitivity is set to Low)		

Masimo SpO2 Module

SpO2	
Measurement range	1 to 100%
Resolution	1%
Accuracy	70 to 100%: $\pm 2\%$ (measured without motion in adult/pediatric mode) 70 to 100%: $\pm 3\%$ (measured without motion in neonate mode) 70 to 100%: $\pm 3\%$ (measured with motion) 0% to 69%: Not specified.
Refreshing rate	1 s
SpO ₂ averaging time	2-4 s, 4-6 s, 8 s, 10 s, 12 s, 14 s, 16 s
Low perfusion conditions	Pulse amplitude: $>0.02\%$ Light penetration: $>5\%$
Low perfusion SpO ₂ accuracy	$\pm 2\%$

Nellcor SpO2 Module

Parameter	Specifications		
SpO ₂ measurement range and accuracy	Sensor	Range	Precision*
	MAX-A, MAX-AL, MAX-N	70 to 100%	$\pm 2\%$
	MAX-P, MAX-I, MAX-FAST	0% to 69%	Not specified.
	OxiCliq A, OxiCliq N	70 to 100%	$\pm 2.5\%$
	OxiCliq P, OxiCliq I	0% to 69%	Not specified.
	D-YS, DS-100A, OXI-A/N, OXI-P/I	70 to 100% 0% to 69%	$\pm 3\%$ Not specified.
MAX-R, D-YSE, D-YSPD	70 to 100% 0% to 69%	$\pm 3.5\%$ Not specified.	
Refreshing rate	1 s		
*: When the SpO ₂ sensor is applied for neonatal patients as indicated, the specified accuracy range is increased by $\pm 1\%$, to compensate for the theoretical effect on oximeter measurements of fetal hemoglobin in neonatal blood.			

A.6.4 PR

Alarm limit	Range (bpm)	Step (bpm)
PR High	Off, (low limit +2) to 300	1
PR Low	Off, 15 to (high limit-2)	

PR from MPM SpO2 Module

Measurement range	20 to 254 bpm
Resolution	1 bpm
Accuracy	±3 bpm (measured without motion) ±5 bpm (measured with motion)
Refreshing rate	1 s
SPO2 averaging time	7 s (when sensitivity is set to High) 9 s (when sensitivity is set to Medium) 11 s (when sensitivity is set to Low)

PR from Masimo SpO2 Module

Measurement range	25 to 240 bpm
Resolution	1 bpm
Accuracy	±3 bpm (measured without motion) ±5 bpm (measured with motion)
Refreshing rate	1 s
SPO2 averaging time	2-4 s, 4-6 s, 8 s, 10 s, 12 s, 14 s, 16 s
Low perfusion conditions	Pulse amplitude: >0.02% Light penetration: >5%
Low perfusion PR accuracy	±3 bpm

PR from Nellcor SpO2 Module

Measurement range	20 to 300 bpm
Resolution	1 bpm
Accuracy	20 to 250 bpm: ±3 bpm 251 to 300 bpm, not specified
Refreshing rate	1 s

PR from IBP Module

Measurement range	25 to 350 bpm
Resolution	1 bpm
Accuracy	25 to 200 bpm: ± 1 bpm or $\pm 1\%$, which is greater 201 to 350 bpm: $\pm 2\%$
Refreshing rate	1 s

A.6.5 NIBP

Standards	Meet standards of EN60601-2-30/IEC60601-2-30, EN1060-1, EN1060-3, EN1060-4 and SP10			
Technique	Oscillometry			
Mode of operation	Manual, Auto and STAT			
Auto mode repetition intervals	1, 2, 2.5, 3, 5, 10, 15, 20, 30, 60, 90, 120, 180, 240 or 480 min			
STAT mode cycle time	5 min			
Max measurement time	Adult, pediatric: 180 s Neonate: 90 s			
Heart rate range	40 to 240 bpm			
Measurement ranges (mmHg)		Adult	Pediatric	Neonate
	Systolic:	40 to 270	40 to 200	40 to 135
	Diastolic:	10 to 210	10 to 150	10 to 100
	Mean:	20 to 230	20 to 165	20 to 110
Accuracy	Max mean error: ± 5 mmHg Max standard deviation: 8 mmHg			
Resolution	1 mmHg			
Initial cuff inflation pressure range (mmHg)	Adult: 80 to 280 Pediatric: 80 to 210 Neonate: 60 to 140			
Default initial cuff inflation pressure (mmHg)	Adult: 160 Pediatric: 140 Neonate: 90			
Software overpressure protection	Adult: 297 ± 3 mmHg Pediatric: 240 ± 3 mmHg Neonate: 147 ± 3 mmHg			
PR				
Measurement range	40 to 240 bpm			
Resolution	1 bpm			
Accuracy	± 3 bpm or $\pm 3\%$, whichever is greater			

Alarm limit	Range (mmHg)	Step (mmHg)
Sys High	Adult: Off, (low limit+5) to 270 Pediatric: Off, (low limit+5) to 200 Neonate: Off, (low limit+5) to 135	5
Sys Low	Off, 40 to (high limit-5)	
Mean High	Adult: Off, (low limit+5) to 230 Pediatric: Off, (low limit+5) to 165 Neonate: Off, (low limit+5) to 110	
Mean Low	Off, 20 to (high limit-5)	
Dia High	Adult: Off, (low limit+5) to 210 Pediatric: Off, (low limit+5) to 150 Neonate: Off, (low limit+5) to 100	
Dia Low	Off, 10 to (high limit-5)	

*Measurement accuracy verification: In adult and pediatric modes, the blood pressure measurements measured with this device are in compliance with the American National Standard for Electronic or Automated Sphygmomanometers (ANSI/AAMI SP10-1992) in terms of mean error and standard deviation by comparing with intra-arterial or auscultatory measurements (depending on the configuration) in a typical patient population. For auscultatory reference, the 5th Korotkoff sound was used to determine the diastolic pressure.

In neonatal mode, the blood pressure measurements measured with this device are in compliance with the American National Standard for Electronic or Automated Sphygmomanometers (ANSI/AAMI SP10-1992 and AAMI/ANSI SP10A-1996) in terms of mean error and standard deviation by comparing with intra-arterial measurements (depending on the configuration) in a typical patient population.

A.6.6 Temp

Standards	Meet standard of EN12470-4
Technique	Thermal resistance
Measurement range	0 to 50 °C (32 to 122 °F)
Resolution	0.1 °C
Accuracy	±0.1 °C or ±0.2 °F (without probe)
Refreshing rate	1 s
Minimum time for accurate measurement	Body surface: <100 s Body cavity: <80 s

Alarm limit	Range	Step
T1/T2 High	Off, (low limit +1) to 50.0 °C Off, (low limit +1.8) to 122 °F	0.1 °C 0.1 °F
T1/T2 Low	Off, 0.1 to (high limit -1) °C Off, 32 to (high limit -1.8) °F	
TD High	Off, 0.1 to 50.0 °C Off, 0.2 to 90 °F	

A.6.7 IBP

Standards	Meet standard of EN60601-2-34/IEC60601-2-34.
Technique	Direct invasive measurement
IBP	
Measurement range	-50 to 300 mmHg
Resolution	1 mmHg
Accuracy	±2% or ±1 mmHg, whichever is greater (without sensor)
Refreshing rate	1 s
Pressure transducer	
Excitement voltage	5 VDC, ±2%
Sensitivity	5 μV/V/mmHg
Impedance range	300 to 3000Ω
Volume displacement (ABBOTT)	<0.04 mm ³ /100 mmHg

Alarm limit		Range (mmHg)	Step (mmHg)
ART Ao FAP BAP UAP LV	Sys High	(low limit + 2) to 300	1
	Mean High		
	Dia High		
	Sys Low	0 to (high limit – 2)	
	Mean Low		
	Dia Low		
PA	Sys High	(low limit + 2) to 120	1
	Mean High		
	Dia High		

	Sys Low	-6 to (high limit – 2)	
	Mean Low		
	Dia Low		
CVP, LAP RAP, ICP	Mean High	(low limit + 2) to 40	1
	Mean Low	-10 to (high limit – 2)	
P1 to P8	Sys High	(low limit + 2) to 300	1
	Mean High		
	Dia High		
	Sys Low	-50 to (high limit – 2)	
	Mean Low		
	Dia Low		

A.6.8 C.O.

Measurement method	Thermodilution method	
Measurement range	C.O.:	0.1 to 20 L/min
	BT:	23 to 43°C
	IT:	0 to 27°C
Resolution	C.O.:	0.1 L/min
	BT, IT:	0.1°C
Accuracy	C.O.:	±5% or ±0.1 L/min, whichever is greater, as measured using electronically generated flow curves. ±0.1°C (without sensor)
	BT, IT:	
Alarm range	BT:	23 to 43°C
Repeatability	C.O.:	±2% or ±0.1 L/min, whichever is greater, as measured using electronically generated flow curves.

Alarm limit	Range	Step
BT High	(low limit + 1) to 43 °C (low limit + 1.8) to 109.4 °F	0.1 °C 0.1 °F
BT Low	23 to (high limit - 1) °C 73.4 to (high limit - 1.8) °F	

A.6.9 CO₂

Measurement mode	Sidestream, microstream, mainstream
Technique	Infrared absorption

Sidestream CO₂ Module

Standard	Meet standard of ISO 21647
CO ₂ Measurement range	0 to 99 mmHg
Accuracy*	0 to 40 mmHg: ±2 mmHg 41 to 76 mmHg: ±5% of the reading 77 to 99 mmHg: ±10% of the reading
Accuracy drift	Meet the requirement for measurement accuracy within 6 hours
Resolution	1 mmHg
Sample flowrate	70 ml/min, 100 ml/min
Sample flowrate tolerance	15% or 15 ml/min, whichever is greater.
Warm-up time	<1 min, enter the iso accuracy mode After 1 min, enters the full accuracy mode,
Response time	Measured with a neonatal watertrap and a 2.5-meter neonatal sampling line: <3.5 s @ 100 ml/min <4 s @ 70 ml/min Measured with a neonatal watertrap and a 2.5-meter adult sampling line: <5.5 s @ 100 ml/min <7 s @ 70 ml/min
Gas sampling delay time	Measured with a neonatal watertrap and a 2.5-meter neonatal sampling line: <3 s @ 100 ml/min <3.5 s @ 70 ml/min Measured with a neonatal watertrap and a 2.5-meter adult sampling line: <5 s @ 100 ml/min <6.5 s @ 70 ml/min
awRR measurement range	0 to 120 rpm
awRR measurement precision	0 to 70 rpm: ±2 rpm 71 to 120 rpm: ±5 rpm
Apnea time	10 s, 15 s, 20 s, 25 s, 30 s, 35 s, 40 s

Effect of interference gases on CO ₂ measurements		
Gas	Concentration (%)	Quantitative effect*
N ₂ O	≤60	±1 mmHg
Hal	≤4	
Sev	≤5	
Iso	≤5	
Enf	≤5	
Des	≤15	±2 mmHg

*: means an extra error should be added in case of gas interference when CO₂ measurements are performed under 0-40mmHg.

Alarm limit	Range	Step
EtCO ₂ High	Off, (low limit + 2) to 99 mmHg	1 mmHg
EtCO ₂ Low	Off, 1 to (high limit - 2)mmHg	
FiCO ₂ High	Off, 1 to 99 mmHg	
awRR High	Off, (low limit + 2) to 100 rpm	1 rpm
awRR Low	Off, 0 to (high limit - 2) rpm	

* Accuracy applies for the following conditions:

1. Measurements begin after the CO₂ module warms up;
2. Ambient pressure is from 750 to 760 mmHg, and ambient temperature from 22 to 28°C;
3. The measured gas is a dry gas and the balance gas N₂;
4. Gas sample flow rate is 100 ml/min, respiration rate is 50 rpm with a fluctuation between ±3 rpm, and I:E is 1:2.

When the operating temperature (near the module detector) is 15-25°C or 50-55°C, or the respiration rate is greater than 50 rpm, the measurement accuracy is: ±4 mmHg (0 to 40 mmHg) or 12% of the reading (41 to 99 mmHg).

Microstream CO2 Module

Standard	Meet standard of ISO 21647	
CO ₂ Measurement range	0 to 99 mmHg	
Accuracy*	0 to 38 mmHg: ±2 mmHg 39 to 99 mmHg: ±5% of the reading+0.08% of (the reading-38)	
Accuracy drift	Meet the requirement for measurement accuracy within 6 hours	
<p>* Accuracy applies for respiration rate up to 80 rpm. For respiration rate above 80 rpm, the accuracy is 4 mmHg or ±12% of the reading, whichever is greater. for EtCO₂ exceeding 18 mmHg. For respiration rate above 60 rpm, the above accuracy can be achieved by using the CapnoLine H Set for Infant/Neonatal. In the presence of interfering gases, the above accuracy is maintained to within 4%.</p>		
Resolution	1 mmHg	
Sample flow rate	50 ^{-7.5} ₊₁₅ ml/min	
Initialization time	30 s (typical)	
Response time	2.9 s (typical) (The response time is the sum of the rise time and the delay time when using a FilterLine of standard length) Rise time: <190 ms (10% to 90%) Delay time: 2.7 s (typical)	
awRR measurement range	0 to 150 rpm	
awRR measurement accuracy	0 to 70 rpm: ±1 rpm 71 to 120 rpm: ±2 rpm 121 to 150 rpm: ±3 rpm	
Apnea alarm time	10 s, 15 s, 20 s, 25 s, 30 s, 35 s, 40 s	
Alarm limit	Range	Step
EtCO ₂ High	Off, (low limit + 2) to 99 mmHg	1 mmHg
EtCO ₂ Low	Off, 1 to (high limit - 2)mmHg	
FiCO ₂ High	Off, 1 to 99 mmHg	
awRR High	Off, (low limit + 2) to 100 rpm	1 rpm
awRR Low	Off, 0 to (high limit - 2) rpm	

Mainstream CO2 Module

Standard	Meet standard of ISO 21647	
CO ₂ Measurement range	0 to 150 mmHg	
Accuracy	0 to 40 mmHg:	±2 mmHg
	41 to 70 mmHg:	±5% of the reading
	71 to 100 mmHg:	±8% of the reading
	101 to 150 mmHg:	±10% of the reading
Accuracy drift	Meet the requirement for measurement accuracy within 6 hours	
Resolution	1 mmHg	
Response time	<60 ms	
awRR measurement range	0 to 150 rpm	
awRR measurement accuracy	1 rpm	
Alarm limit	Range	Step
EtCO ₂ High	Off, (low limit + 2) to 99 mmHg	1 mmHg
EtCO ₂ Low	Off, 1 to (high limit - 2)mmHg	
FiCO ₂ High	Off, 1 to 99 mmHg	
awRR High	Off, (low limit + 2) to 100 rpm	1 rpm
awRR Low	Off, 0 to (high limit - 2) rpm	

A.6.10 AG

Standards	Meet standard of ISO 21647		
Technique	Infrared absorption		
Warm-up time	Iso accuracy mode:	45 s	
	Full accuracy mode:	10 min	
Sample flow rate	Adult, pediatric:	120, 150, 200 ml/min	
	Neonate:	70, 90, 120 ml/min	
	Accuracy:	±10 ml/min or ±10%, whichever is greater	
Measurement range	CO ₂ :	0 to 30%	
	O ₂ :	0 to 100%	
	N ₂ O:	0 to 100%	
	Des:	0 to 30%	
	Sev:	0 to 30%	
	Enf:	0 to 30%	
	Iso:	0 to 30%	
	Hal:	0 to 30%	
	awRR:	2 to 100 rpm	
Resolution	CO ₂ :	1 mmHg	
	awRR:	1 rpm	
Iso accuracy	CO ₂ :	±0.3% _{ABS}	
	N ₂ O:	±(8% _{REL} +2% _{ABS})	
	Other anesthetic gases:	8% _{REL}	
Full accuracy	Gases	Range (% _{REL})	Accuracy (% _{ABS})
	CO ₂	0 to 1	±0.1
		1 to 5	±0.2
		5 to 7	±0.3
		7 to 10	±0.5
		>10	Not specified
	N ₂ O	0 to 20	±2
20 to 100		±3	
O ₂	0 to 25	±1	
	25 to 80	±2	
	80 to 100	±3	

	Des	0 to 1 1 to 5 5 to 10 10 to 15 15 to 18 >18	±0.15 ±0.2 ±0.4 ±0.6 ±1 Not specified
	Sev	0 to 1 1 to 5 5 to 8 >8	±0.15 ±0.2 ±0.4 Not specified
	Enf, Iso, Hal	0 to 1 1 to 5 >5	±0.15 ±0.2 Not specified
	awRR	2 to 60 rpm >60 rpm	±1 rpm Not specified
Accuracy drift	Meet the requirement for measurement accuracy within 6 hours		
Apnea alarm time	10 s, 15 s, 20 s, 25 s, 30 s, 35 s, 40 s		
Refreshing rate	1 s		
Rise time (10 % ~ 90%)	gas sample flow rate 120ml/min, using the DRYLINE™ watertrap and neonatal DRYLINE™ sampling line (2.5m):		
	CO ₂	≤250 ms (fall time: 200ms)	
	N ₂ O	≤250 ms	
	O ₂	≤600 ms	
	Hal, Iso, Sev, Des	≤300 ms	
	Enf	≤350 ms	
	gas sample flow rate 200ml/min, using the DRYLINE™ water trap and adult DRYLINE™ sampling line (2.5m):		
	CO ₂	≤250 ms (fall time: 200 ms)	
	N ₂ O	≤250 ms	
	O ₂	≤500 ms	
	Hal, Iso, Sev, Des	≤300 ms	
	Enf	≤350 ms	
Delay time	<4 s		
Anesthetic agent limit	Primary anesthetic agent		
	In full accuracy mode: 0.15%, In ISO accuracy mode: 0.4%		
	Second anesthetic agent:		
	In full accuracy mode: 0.3% or 5% REL (10% in ISO accuracy mode) of		

	primary agent if primary agent is greater than 10% In ISO accuracy mode: 0.5%
--	--

Effect of interference gases on AG measurements					
Gas	Concentration(%)	Quantitive effect(%ABS)3)			
		CO2	N2O	Agent 1)	O2
CO ₂	/	/	0.1	0	0.2
N ₂ O	/	0.1	/	0.1	0.2
Agent ¹⁾²⁾	/	0.1	0.1	0.1	1
Xenon	<100%	0.1	0	0	0.5
Helium	<50%	0.1	0	0	0.5
Ethanol	<0.1%	0	0	0	0.5
Acetone	<1%	0.1	0.1	0	0.5
Methane	<1%	0.1	0.1	0	0.5
Saturated Isopropanol vapour	/	0.1	0	0	0.5
Metered dose inhaler propellants,	/	Unspecified	Unspecified	Unspecified	0.5

1) Agent represents one of Des, Iso, Enf, Sev, and Hal.
2) Multiple agent interference on CO₂, N₂O and O₂ is typically the same as single agent interference.
3) For CO₂, N₂O and Agents, maximum interference from each gas at concentrations within specified accuracy ranges for each gas. The total interference of all gases is never larger than 5%_{REL}.

Alarm limit	Range	Step
EtCO2 High	Off, (low limit + 2) to 99 mmHg	1 mmHg
EtCO2 Low	Off, 1 to (high limit - 2)mmHg	
FiCO2 High	Off, 1 to 99 mmHg	
awRR High	Off, (low limit + 2) to 100 rpm	1 rpm
awRR Low	Off, 0 to (high limit - 2)rpm	
EtO2 High	Off, (low limit + 2) to 100 %	1%
EtO2 Low	Off, 18 to (high limit - 2)%	
FiO2 High	Off, (low limit + 2) to 100 %	
FiO2 Low	Off, 18 to (high limit - 2)%	
EtN ₂ O High	Off, (low limit + 2) to 100 %	1%
EtN ₂ O Low	Off, 0 to (high limit - 2)%	
FiN ₂ O High	Off, (low limit + 2) to 100 %	
FiN ₂ O Low	Off, 0 to (high limit - 2)%	
EtHal/Enf/Iso High	Off, (low limit + 0.2) to 5.0 %	0.1%
EtHal/Enf/Iso Low	Off, 0 to (high limit - 0.2)%	
FiHal/Enf/Iso High	Off, (low limit + 0.2) to 5.0 %	
FiHal/Enf/Iso Low	Off, 0 to (high limit - 0.2)%	
EtSev High	Off, (low limit + 0.2) to 8.0 %	0.1%
EtSev Low	Off, 0 to (high limit - 0.2)%	
FiSev High	Off, (low limit + 0.2) to 8.0 %	
FiSev Low	Off, 0 to (high limit - 0.2)%	
EtDes High	Off, (low limit + 0.2) to 18.0 %	0.1%
EtDes Low	Off, 0 to (high limit - 0.2)%	
FiDes High	Off, (low limit + 0.2) to 18.0 %	
FiDes Low	Off, 0 to (high limit - 0.2)%	

A.6.11 ICG

Technique	Thoracic electrical bioimpedance (TEB)	
Measurement range	SV: 5 to 250 ml/beat HR: 44 to 185 bpm C.O.: 1.4 to 15 L/min	
Accuracy	SV: Not specified. HR: ± 2 bpm C.O.: Not specified.	
Alarm limit	Range	Step
C.I. High	(low limit + 1.0) to 15.0 L/min/m ²	0.1 L/min/m ²
C.I. Low	0.0 to (high limit - 1.0)L/min/m ²	
TFC High	(low limit + 1) to 150 /k Ω	1 /k Ω
TFC Low	10 to (high limit - 1)/k Ω	

A.6.12 BIS

Standards	Meet standard of IEC 60601-2-26	
Technique	Bispectral index	
Measured parameters	EEG BIS: 0 to 100	
Calculated parameters	SQI: 0 to 100% EMG, SR, SEF, TP	
Impedance range	0 to 999 k Ω	
Sweep speed	6.25 mm/s, 12.5 mm/s, 25 mm/s or 50 mm/s	
Input impedance	>5 M Ω	
Noise (RTI)	<0.3 μ V (0.25 to 50 Hz)	
Input signal range	± 1 mV	
EEG bandwidth	0.25 to 100 Hz	
Patient leakage current	<10 μ A	
Alarm limit	Range	Step
BIS High	(low limit + 2) to 100	1
BIS Low	0 to (high limit - 2)	

A.6.13 RM

Technique	Flow sensor	
Frequency response	≥ 30 Hz	
Dead space	≤ 11 ml	
Flow		
Measurement range	Adult/pediatric*: $\pm (2 \text{ to } 120)$ L/min Infant: $\pm (0.5 \text{ to } 30)$ L/min	
Accuracy	Adult/pediatric*: 1.5 L/min or $\pm 10\%$ of the reading, whichever is greater Infant: 0.5 L/min or $\pm 10\%$ of the reading, whichever is greater	
Resolution	0.1 L/min	
Paw		
Measurement range	-20 to 120 cmH ₂ O	
Accuracy	$\pm 3\%$	
Resolution	0.1 cmH ₂ O	
MVe/MVi		
Measurement range	Adult/Pediatric*: 2 to 60 L/min Infant: 0.5 to 15 L/min	
Accuracy	$\pm 10\% \times \text{reading}$	
TVe/TVi		
Measurement range	Adult/Pediatric*: 100 to 1500 ml Infant: 20 to 500 ml	
Resolution	1 ml	
Accuracy	Adult/pediatric*: $\pm 10\%$ or 15 ml, whichever is greater Infant: $\pm 10\%$ or 6 ml, whichever is greater	
RR (RM)		
Measurement range	4 to 120 rpm	
Accuracy	4 to 99 rpm	± 1 rpm
	100 to 120 rpm	± 2 rpm

*Pediatric in this form does not include neonate and infant.

Calculated Parameters		
	Measurement range	Measurement accuracy
I:E	4:1 to 1:8	Not specified.
FEV1.0%	0 to 100%	Not specified.
Pmean	0 to 120 cmH ₂ O	±10%×reading
TV	20 to 1500 ml	Adult/pediatric: ±10% or ±25 ml, whichever is greater. Infant: ±10% or ±6 ml, whichever is greater.
MV	2 to 60 L	±10%×reading
PEEP	0 to 120 cmH ₂ O	Not specified.
PEF	2 to 120 L/min	±2L/min or ±10% of reading, whichever is greater.
PIF	2 to 120 L/min	±2L/min or ±10% of reading, whichever is greater.
PIP	0 to 120 cmH ₂ O	1cmH ₂ O or ±10% of reading, whichever is greater.
Pplat	0 to 120 cmH ₂ O	Not specified.
Compl	0 to 200 ml/cmH ₂ O	
RSBI	0 to 4095 rpm/L	

Alarm limit	Range	Step
RR High	(low limit +2) to 100 rpm	1 rpm
RR Low	0 to (high limit -2) rpm	
PEEP High	(low limit +1) to 120 cmH ₂ O	1 cmH ₂ O
PEEP Low	0 to (high limit -1) cmH ₂ O	
PIP High	(low limit +1) to 120 cmH ₂ O	1 cmH ₂ O
PIP Low	0 to (high limit -1) cmH ₂ O	
MVe High	Adult and pediatric: (low limit +1.0) to 60.0 L/min Infant:(low limit +1.0) to 15.0	0.5 L/min
MVe Low	Adult and pediatric: 2.0 to (high limit -1.0) Infant:0.5 to (high limit -1.0)	

A.6.14 CCO

Operating mode	Interfaces with Edwards Vigilance II monitor
Measured parameter	Consistent with CCO-related parameters outputted by Vigilance II monitor
Parameter alarm	CCO/CCI,EDV/EDVI,SVR/SVRI,SV/SVI,RVEF
Signal Outputs	
Standard	Meets the requirements of EN 60601-1 for short-circuit protection and leakage current
Output impedance	1000Ω
Isolation voltage	1500 VAC
ECG Analog Output	
Bandwidth (-3dB; reference frequency: 10Hz)	DC to 150Hz
Sensitivity	2V/mV ±5%
MAP Analog Signal Output	
Output voltage	0 to 5V (0 to 500mmHg)
Output voltage error	±5%
CVP Analog Signal Output	
Output voltage	0 to 5V (0 to 100mmHg)
Output voltage error	±5%

CCO-related Parameters Outputted by Vigilance II Monitor		
Name	Range	Resolution
CCO	1 to 20 L/min	0.1
CCI	0 to 20 L/min/m ²	0.1
CO	1 to 20 L/min	0.1
CI	0 to 20 L/min/m ²	0.1
EDV	40 to 800 ml	1
EDVI	20 to 400 ml/m ²	1
SVR	0 to 3000 DS/cm ⁵	1
SVRI	0 to 6000 DS·m ² /cm ⁵	1
SV	0 to 300 ml/beat	1
SVI	0 to 200 ml/beat/m ²	1
BT	25 to 45 °C	0.1
RVEF	10 to 60%	1
ESV	10 to 700 ml	1
ESVI	5 to 400 ml/m ²	1
HRavg	30 to 250 bpm	1
CVP	0 to 100 mmHg	1
MAP	0 to 500 mmHg	1

Alarm Limit	Range	Step
CCO High	(Low limit+0.1) to 20 L/min	0.1 L/min
CCO Low	0 to (high limit-0.1)L/min	
CCI High	(Low limit+0.1) to 20 L/min/m ²	0.1 L/min/m ²
CCI Low	0 to (high limit-0.1)L/min/m ²	
EDV High	(Low limit+10)to 800 ml	10 ml
EDV Low	0 to (high limit-10)ml	
EDVI High	(Low limit+10) to 400 ml/m ²	10 ml/m ²
EDVI Low	0 to (high limit-10)ml/m ²	
SVR High	(Low limit+20) to 5000 DS/cm ⁵ or (low limit+2) to 500 kPa-s/l	20 DS/cm ⁵ or 2 kPa-s/l
SVR Low	0 to (high limit-20)DS/cm ⁵ or 0 to (high limit-2)kPa-s/l	
SVRI High	(Low limit+50) to 9950 DS·m ² /cm ⁵ or(low limit+5) to 995 kPa-s-m ² /l	50 DS·m ² /cm ⁵ or 5 kPa-s-m ² /l

SVRI Low	0 to(high limit-5)DS·m ² /cm ⁵ or 0 to(high limit-5)kPa·s·m ² /l	
SV High	(Low limit+5) to 300 ml/b	5 ml/b
SV Low	0 to (high limit-5)ml/b	
SVI High	(Low limit+5) to 200 ml/b/m ²	5 ml/b/m ²
SVI Low	0 to(high limit-5)ml/b/m ²	
RVEF High	(Low limit+5) to 100 %	5 %
RVEF Low	0 to(High limit-5)%	

A.6.15 SvO2

Operating mode	Interfaces with Edwards Vigilance II monitors
Measured parameter	Consistent with SvO2-related parameters outputted by Vigilance monitors
Parameter alarm	SvO2,ScvO2
Signal Output	
Standard	Meets the requirements of EN 60601-1 for short-circuit protection and leakage current
Output impedance	1000Ω
Isolation voltage	1500 VAC
SpO2 Analog Signal Output	
Output voltage	0 to 10V (0 to 100%)
Output voltage error	±5%

SvO2-related Parameters Outputted by Vigilance II Monitor		
Name	Measurement Range	Resolution
SaO2	40 to 100%	1
VO2	0 to 999 ml/min	1
O2EI	0.0 to 99.9%	0.1
SNR	-10 to +20 dB	0.1
DO2	0 to 2000 ml/min	1
SvO2	10 to 99%	1
ScvO2	10 to 99%	1
SQI	1 to 4	1

Alarm Limit	Range (%)	Step (%)
SvO ₂ / ScvO ₂ High	(Low limit+0.1)to 99	1
SvO ₂ / ScvO ₂ Low	0 to(high limit-0.1)	

B EMC

The product is in radio-interference protection class A in accordance with EN55011. The product complies with the requirement of standard EN60601-1-2:2007 “Electromagnetic Compatibility – Medical Electrical Equipment”.

Note

- **Using accessories, transducers and cables other than those specified may result in increased electromagnetic emission or decreased electromagnetic immunity of the patient monitoring equipment.**
 - **The device or its components should not be used adjacent to or stacked with other equipment. If adjacent or stacked use is necessary, the device or its components should be observed to verify normal operation in the configuration in which it will be used.**
 - **The device needs special precautions regarding EMC and needs to be installed and put into service according to the EMC information provided below.**
 - **Other devices may affect this monitor even though they meet the requirements of CISPR.**
 - **When the inputted signal is below the minimum amplitude provided in technical specifications, erroneous measurements could result.**
-

Guidance and Declaration - Electromagnetic Emissions		
The device is suitable for use in the electromagnetic environment specified below. The customer or the user of the device should assure that it is used in such an environment.		
Emission tests	Compliance	Electromagnetic environment - guidance
Radio frequency (RF) emissions CISPR 11	Group 1	The device uses RF energy only for its internal function. Therefore, its RF emissions are very low and are not likely to cause any interference in nearby electronic equipment.
RF emissions CISPR 11	Class A	The device is suitable for use in all establishments other than domestic and those indirectly connected to the public low-voltage power supply network that supplies buildings used for domestic purposes.
Harmonic emissions IEC61000-3-2	Class A	
Voltage Fluctuations/Flicker Emissions IEC 61000-3-3	Complies	

Guidance and Declaration - Electromagnetic Immunity			
The device is suitable for use in the electromagnetic environment specified below. The customer or the user of the device should assure that it is used in such an environment.			
Immunity test	IEC60601 test level	Compliance level	Electromagnetic environment - guidance
Electrostatic discharge (ESD) IEC 61000-4-2	±6 kV contact ±8 kV air	±6 kV contact ±8 kV air	Floors should be wood, concrete or ceramic tile. If floors are covered with synthetic material, the relative humidity should be at least 30%.
Electrical fast transient/burst IEC 61000-4-4	±2 kV for power supply lines ±1 kV I/O for input/output lines (>3 m)	±2 kV for power supply lines ±1 kV I/O for input/output lines (>3 m)	Mains power quality should be that of a typical commercial or hospital environment.
Surge IEC 61000-4-5	±1 kV differential mode ±2 kV common mode	±1 kV differential mode ±2 kV common mode	
Voltage dips, short interruptions and voltage variations on power supply input lines IEC 61000-4-11	<5 % U_T (>95 % dip in U_T) for 0.5 cycle 40 % U_T (60 % dip in U_T) for 5 cycles 70 % U_T (30 % dip in U_T) for 25 cycles <5 % U_T (>95 % dip in U_T) for 5 s	<5 % U_T (>95 % dip in U_T) for 0.5 cycle 40 % U_T (60 % dip in U_T) for 5 cycles 70 % U_T (30 % dip in U_T) for 25 cycles <5 % U_T (>95 % dip in U_T) for 5 s	Mains power quality should be that of a typical commercial or hospital environment. If the user of our product requires continued operation during power mains interruptions, it is recommended that our product be powered from an uninterruptible power supply or a battery.
Power frequency (50/60 HZ) magnetic field IEC 61000-4-8	3 A/m	3 A/m	Power frequency magnetic fields should be at levels characteristic of a typical location in a typical commercial or hospital environment.
Note: U_T is the AC mains voltage prior to application of the test level.			

Guidance and Declaration - Electromagnetic Immunity		
The device is suitable for use in the electromagnetic environment specified below. The customer or the user of the device should assure that it is used in such an environment.		
Immunity test	IEC 60601 Test level	Compliance level
Conducted RF IEC61000-4-6	3 Vrms 150k to 80M Hz	3 Vrms (BIS, ICG: 1Vrms)
Radiated RF IEC61000-4-3	3V/m 80M to 2.5G Hz	3V/m (Resp: 1V/m)
Electromagnetic environment - guidance		
<p>Portable and mobile RF communications equipment should be used no closer to any part of the device, including cables, than the recommended separation distance calculated from the equation applicable to the frequency of the transmitter.</p> <p>Recommended Separation Distance:</p> $d = 1.2\sqrt{P} \text{ (BIS, ICG: } d = 3.5\sqrt{P} \text{)}$ $d = 1.2\sqrt{P} \text{ (Resp: } d = 3.5\sqrt{P} \text{) 80 to 800 MHz}$ $d = 2.3\sqrt{P} \text{ 800M to 2.5GHz}$ <p>where P is the maximum output power rating of the transmitter in watts (W) according to the transmitter manufacturer and d is the recommended separation distance in meters (m).</p> <p>Field strengths from fixed RF transmitters, as determined by an electromagnetic site survey,^a should be less than the compliance level in each frequency range^b Interference may occur in the vicinity of equipment marked with the following symbol: .</p>		
<p>Note 1: From 80 MHz to 800 MHz, the higher frequency range applies.</p> <p>Note 2: These guidelines may not apply in all situations. Electromagnetic propagation is affected by absorption and reflection from structures, objects and people.</p>		
<p>a Field strengths from fixed transmitters, such as base stations for radio (cellular/cordless) telephones and land mobile radios, amateur radio, AM and FM radio broadcast and TV broadcast cannot be predicted theoretically with accuracy. To assess the electromagnetic environment due to fixed RF transmitters, an electromagnetic site survey should be considered. If the measured field strength in the location in which the device is used exceeds the applicable RF compliance level above, the device should be observed to verify normal operation. If abnormal performance is observed, additional measures may be necessary, such as reorienting or relocating the device.</p> <p>b Over the frequency ranges 150kHz to 80MHz, field strengths should be less than 3V/m. For BIS and ICG monitoring, the field strength should be less than 1V/m</p>		

Recommended Separation Distances between Portable and Mobile RF Communications Equipment and The device

The device is suitable for use in an electromagnetic environment in which radiated RF disturbance are controlled. The customer or the user of the device can help prevent electromagnetic interference by maintaining a minimum distance between portable and mobile RF communications equipment (transmitters) and the device as recommended below, according to the maximum output power of the communication equipment.

Rated Maximum Output power of Transmitter Watts (W)	Separation Distance Meters (m) Corresponding to Frequency of Transmitter		
	150k to 80MHz $d = 3.5\sqrt{P}$	80M to 800MHz $d = 3.5\sqrt{P}$	800M to 2.5GHz $d = \left[\frac{7}{3}\right]\sqrt{P}$
0.01	0.35	0.35	0.23
0.1	1.11	1.11	0.74
1	3.5	3.5	2.34
10	11.07	11.07	7.38
100	35	35	23.34

For transmitters at a maximum output power not listed above, the separation distance can be estimated using the equation in the corresponding column, where P is the maximum output power rating of the transmitter in watts (W) according to the transmitter manufacturer.

Note 1: From 80 MHz to 800 MHz, the separation distance for the higher frequency range applies.

Note 2: These guidelines may not apply in all situations. Electromagnetic propagation is affected by absorption and reflection from structures, objects and people.

C Factory Defaults

This section lists the most important factory default settings. These settings are not user-adjustable. You can restore the factory default settings if necessary.

C.1 Patient Demographics

Patient Demographics	Factory Default Settings
Patient Cat.	Adu
Paced	No

C.2 Alarm Setup

Alarm Setup	Factory Default Settings
Alarm Volume	2
Latching Alarms	No
Minimum Alarm Volume	2
Alarm Pause Time	2 min
Reminder Tone	Off
Reminder Interval	1 min
Alarm Sound	ISO
High Alarm Interval (s)	10
Med Alarm Interval (s)	20
Low Alarm Interval (s)	20
Alarm Delay (s)	6
ST Alarm Delay (s)	30

C.3 Screen Setup

Screen Setup	Factory Default Settings
Help	On
Sweep Mode	Refresh
Key Volume	2
Brightness	5

C.4 ECG Setup

ECG Setup	Adult	Pediatric	Neonate
Alm Source	HR		
Alarm	On		
Alm Lev	Med		
Alm Rec	Off		
HR High	120	160	200
HR Low	50	75	100
Beat Vol	2		
Paced	No		
Pacemaker Rate	60		
Lead Set	Auto (if auto lead detection is available); 3-Lead (if auto lead detection is not available)		
ECG Display	Normal		
Filter	Monitor		
Notch Filter	On		
Smart Lead Off	On		

ST Analysis	Adult	Pediatric
ST Analysis	Off	
Alarm	Off	
Alm Lev	Med	
Alm Rec	Off	
ST-X High*	0.2	
ST-X Low*	-0.2	
*: X represents I, II, III, aVR, aVL, aVF, V, V1, V2, V3, V4, V5 or V6.		

Arrh. Analysis	Adult	Pediatric
Alm Lev	Med	
Alm Rec	Off	
PVCs High	10	

Arrh. Alarm Setup	Alarm	Alm Lev	Alm Rec
Asystole	On	High	Off
VFib/VTac	On	High	Off
PVCs	Off	Med	Off
R on T	Off	Med	Off
VT>2	Off	Med	Off
Couplet	Off	Med	Off
PVC	Off	Med	Off
Bigeminy	Off	Med	Off
Trigeminy	Off	Med	Off
Tachy	Off	Med	Off
Brady	Off	Med	Off
PNP	Off	Med	Off
PNC	Off	Med	Off
Missed Beat	Off	Med	Off
Multif. PVC	Off	Med	Off
Irr. Rhythm	Off	Med	Off
Vent. Rhythm	Off	Med	Off
Waveform X *	Adult	Pediatric	Neonate
HR Source**	II		
Gain	X1		
Filter	Monitor		
Sweep	25 mm/s		
*: X represents (lead) I, II, III, aVR, aVL, aVF, V, V1, V2, V3, V4, V5 or V6			
**: for lead II only.			

C.5 Resp Setup

Resp Setup	Adult	Pediatric	Neonate
Alarm	On		
Alm Lev	Med		
Alm Rec	Off		
Resp High	30	30	100
Resp Low	8	8	30
Apnea Delay	20 s		
Detection Mode	Auto		
RR Source	Auto		
Resp Waveform			
Resp Lead	II		
Sweep	6.25 mm/s		
Gain	X2		
Detection Mode	Auto		

C.6 PR

PR Setup	Adult	Pediatric	Neonate
PR Source	SpO2		
Alarm	On		
Alm Lev	Med		
Alm Rec	Off		
PR High	120	160	200
PR Low	50	75	100
Alm Source	HR		
Beat Vol	2		

C.7 SpO2 Setup

SpO2 Setup	Adult	Pediatric	Neonate
Alarm	On		
Alm Lev	Med		
Alm Rec	Off		
SpO2 High	100	100	95
SpO2 Low	90	90	90
Desat Limit	80	80	80
Sensitivity (MPM)	Med		
Sensitivity (Masimo)	Normal		
Averaging (Masimo)	8 s		
NIBP Simul	Off		
Sat-Seconds (Nellcor)	0 s		
Pleth Waveform			
Sweep	25 mm/s		

C.8 NIBP Setup

NIBP Setup	Adult	Pediatric	Neonate
Alarm	On		
Alm Lev	Med		
Alm Rec	Off		
Alm Source	All		
Sys High	160	120	90
Sys Low	90	70	40
Mean High	110	90	70
Mean Low	60	50	25
Dia High	90	70	60
Dia Low	50	40	20
Press. Unit	mmHg		
Interval	Manual		
Cuff Press.	80	60	40
Initial Pressure	160	140	90

C.9 Temp Setup

Temp Setup	Adult	Pediatric	Neonate
Alarm	On		
Alm Lev	Med		
Alm Rec	Off		
T1 High	39.0	39.0	39.0
T1 Low	36.0	36.0	36.0
T2 High	39.0	39.0	39.0
T2 Low	36.0	36.0	36.0
TD High	2.0	2.0	2.0
Unit	°C		

C.10 IBP Setup

IBP Setup		Adult	Pediatric	Neonate
Alarm		On		
Alm Lev		Med		
Alm Rec		Off		
Alm Source		All		
Sensitivity		Med		
Alarm Limits		Systolic/Diastolic (Mean) (mmHg)		
		Adult	Pediatric	Adult
Art, Ao, FAP, BAP, UAP, LV	High Limit	160/90 (110)	120/70 (90)	90/60 (70)
	Low Limit	90/50 (70)	70/40 (50)	55/20 (35)
PA	High Limit	35/16 (20)	60/4 (26)	60/4 (26)
	Low Limit	10/0 (0)	24/-4 (12)	24/-4 (12)
Alarm Limits		Mean (mmHg)		
		Adult	Pediatric	Adult
LAP, RAP, ICP, UVP	High Limit	10	4	4
	Low Limit	0	0	0
Alarm Limits		Mean (cmH2O)		
		Adult	Pediatric	Adult
CVP	High Limit	13.6	5.4	5.4
	Low Limit	0.0	0.0	0.0
IBP Waveform				
Sweep		25 mm/s		
Filter		No Filter		

C.11 C.O. Setup

C.O. Setup	Factory default settings
Alarm	On
Alm Lev	Med
TB High (°C)	39.0
TB Low (°C)	36.0
Comp. Const	0.542
Auto TI	Auto
Manual TI	2.0
Measuring mode	Manual

C.12 CCO/SvO₂ Setup

CCO/SvO ₂ Setup		Factory default settings	
Alarm		Off	
Alm Lev		Med	
Alm Rec		Off	
Alarm Limits	Adult/pediatric/neonate	Alarm Limits	Adult/pediatric/neonate
CCO High	14	RVEF High	50
CCO Low	2	RVEF Low	0
CCI High	7	SV High	120
CCI Low	1	SV Low	20
EDV High	300	SVI High	60
EDV Low	80	SVI Low	10
EDVI High	150	SvO ₂ High	99
EDVI Low	60	SvO ₂ Low	10
SVR High	1500 DS/cm ⁵	ScvO ₂ High	99
SVR Low	500 DS/cm ⁵	ScvO ₂ Low	10
SVRI High	3000 DS·m ² / cm ⁵		
SVRI Low	1000 DS·m ² / cm ⁵		

C.13 CO2 Setup

CO2 Setup	Factory default settings		
	Adult	Pediatric	Neonate
Alarm	On		
Alm Lev	Med		
Alm Rec	Off		
Humidity Compen (sidestream)	On		
Press. Unit	mmHg		
Max Hold (microstream)	20 s		
Max Hold (mainstream)	10 s		
Operating Mode	Measure		
Flow Rate	100 ml/min		
O2 Compen (sidestream)	0		
O2 Compen (mainstream)	Off		
N2O Compen (sidestream)	0		
Des Compen (sidestream)	0		
Balance Gas (mainstream)	Room Air		
Auto Standby (min) (microstream)	0		
EtCO2 High	50	50	45
EtCO2 Low	15	20	30
FiCO2 High	4	4	4
awRR High	30	30	100
awRR Low	8	8	30
Apnea Delay	20 s		
RR Source	Auto		
CO2 Waveform			
Wave Type	Draw		
Sweep	6.25 mm/s		

C.14 AG Setup

AG Setup		Factory default settings	
Alarm		On	
Alm Lev		Med	
Alm Rec		Off	
Apnea Delay		20 s	
RR Source		Auto	
Flow Rate		Low	
O2 Compen		Off	
Operating Mode		Measure	
Auto Standby		Off	
Wave Type (CO2)		Draw	
Sweep		6.25 mm/s	
Alarm Limits	Adult/pediatric/neonate	Alarm Limits	Adult/pediatric/neonate
awRR High	30/30/100	EtO2 High	88
awRR Low	8/8/30	EtO2 Low	18
EtCO2 High	50/50/45	FiO2 High	100/100/90
EtCO2 Low	15/20/30	FiO2 Low	18
FiCO2 High	4	EtHal High	3.0
EtN2O High	55	EtHal Low	0.0
EtN2O Low	0	FiHal High	2.0
FiN2O High	53	FiHal Low	0.0
FiN2O Low	0	EtIso High	3.0
EtEnf High	3.0	EtIso Low	0.0
EtEnf Low	0.0	FiIso High	2.0
FiEnf High	2.0	FiIso Low	0.0
FiEnf Low	0.0	EtDes High	8.0
EtSev High	6.0	EtDes Low	0.0
EtSev Low	0.0	FiDes High	6.0
FiSev High	5.0	FiDes Low	0.0
FiSev Low	0.0		

C.15 ICG Setup

ICG Setup	Factory default settings	
	Adult	
Alarm	On	
Alm Lev	Med	
Alm Rec	Off	
C.I. High	5.0	
C.I. Low	1.5	
TFC High	60	
TFC Low	10	
Averaging	30 beats	
Update Rate	10 beats	
ICG Waveform		
Sweep	12.5 mm/s	

C.16 BIS Setup

BIS Setup	Factory default settings	
	Adult	Pediatric
Alarm	On	
Alm Lev	Med	
Alm Rec	Off	
BIS High	70	
BIS Low	20	
Smoothing Rate	30 s	
BIS EEG Waveform		
Sweep	25 mm/s	
Scale	100 μ V	
Filters	On	
Display BIS	BIS EEG	
BIS Trend Waveform		
Trend Length	6 min	





C.17 RM Setup

RM Setup	Factory default settings		
	Adult	Pediatric	Neonate
Alarm	On		
Alm Lev	Med		
Alm Rec	Off		
Apnea Time	20 s		
TV / MV	TV		
Sensor Type	Disposable		
RR Source	Auto		
Alarm Limits Setup			
RR High	30	30	100
RR Low	8	8	30
PEEP High	10		
PEEP Low	0		
PIP High	40		
PIP Low	1		
MVe High	30.0	30.0	10.0
MVe Low	2.0	2.0	0.5
RM Waveform			
Sweep	6.25 mm/s		

D Alarm Messages

This chapter lists only the most important physiological and technical alarm messages. Some messages appearing on your monitor may not be included.

In this chapter:

The “I” field indicates how alarm indications are cleared: “A” means all alarm indications are cleared after the  hardkey is pressed, “B” indicates alarm lamp flashing and alarm tones are cleared and the alarm messages change to prompt messages after the  hardkey is pressed, and “C” indicates alarm lamp flashing and alarm tones are cleared and  appears before the alarm message after the  hardkey is pressed..

The “L” field indicates the alarm level: H means high, M means medium and L means low. “*” means the alarm level is user-adjustable.

XX represents a measurement or parameter label, such as ECG, NIBP, HR, ST-I, PVCs, RR, SpO₂, PR, etc.

In the “Cause and Solution” column, corresponding solutions are given instructing you to troubleshoot problems. If the problem persists, contact your service personnel.

D.1 Physiological Alarm Messages

Measurement	Alarm messages	L	Cause and solution
XX	XX Too High	M*	XX value has risen above the high alarm limit or fallen below the low alarm limit. Check the patient's condition and check if the patient category and alarm limit settings are correct.
	XX Too Low	M*	
ECG	ECG Weak Signal	H	The ECG signal is so weak that the monitor can't perform ECG analysis. Check the patient's condition and the ECG connections.
	Asystole	H	Arrhythmia has occurred to the patient. Check the patient's condition and the ECG connections.
	VFib/VTac	H	
	R on T	M*	
	VT>2	M*	
	Couplet	M*	
	PVC	M*	
	Bigeminy	M*	
	Trigeminy	M*	
	Tachy	M*	
	Brady	M*	
	Missed Beats	M*	
	Irr. Rhythm	M*	
	Vent. Rhythm	M*	
	Multif. PVC	M*	
PNP	M*	The pacer appears abnormal. Check the pacer.	
PNC	M*		
Resp	Apnea	H	The respiration signal was so weak that the monitor cannot perform respiration analysis. Check the patient's condition and the Resp connections.
	Resp Artifact	H	The patient's heartbeat has interfered with his respiration. Check the patient's condition and the Resp connections.
SpO ₂	SpO ₂ Desat	H	The SpO ₂ value has fallen below the desaturation alarm limit. Check the patient's condition and check if the alarm limit settings are correct.

Measurement	Alarm messages	L	Cause and solution
	No Pulse	H	The pulse signal was so weak that the monitor cannot perform pulse analysis. Check the patient's condition, SpO ₂ sensor and measurement site.
CO ₂	Apnea	H	The patient stops breathing, or the respiration signal was so weak that the monitor cannot perform respiration analysis. Check the patient's condition and the RM connections.
AG	Apnea	H	
RM	Apnea	H	
AG	FiO ₂ Too Low	H	Check the patient's condition, the ventilated O ₂ content and the AG connections.

D.2 Technical Alarm Messages

Measurement	Alarm message	L	I	Cause and solution	
XX	XX SelfTest Err	H	C	An error occurred to the XX module, or there is a problem with the communications between the module and the monitor. Re-plug the module and restart the monitor, or plug the module into another monitor.	
	XX Init Err	H	A		
	XX Init Err N	H	A		
	N is within 1 to 8				
	XX Comm Err	H	A		
	XX Comm Stop	H	C		
	XX Limit Err	L	C	XX parameter limit is accidentally changed. Contact your service personnel.	
	XX Overrange	L	C	The measured XX value is not within the specified range for XX measurement. Contact your service personnel.	
MPM	MPM 12V Err	H	C	An error occurred to the power supply part of the MPM module. Contact your service personnel.	
	MPM 5V Err	H	C		
ECG	ECG Lead Off	L*	B	The electrode has become detached from the patient or the lead wire has become disconnected from the adapter cable. Check the connections of the electrodes and leadwires.	
	ECG YY Lead Off	L*	B		
Note: YY represents the leadwires, V (V1, V2, V3, V4, V5, V6), LL, LA, RA, as per AHA standard, or C (C1, C2, C3, C4, C5, C6), F, L and R as per IEC standard.					

Measurement	Alarm message	L	I	Cause and solution
	ECG Noisy	L	A	The ECG signal is noisy. Check for any possible sources of signal noise around the cable and electrode, and check the patient for great motion.
	ECG Artifact	L	A	Artifacts are detected on the ECG analysis lead and as a result heart rate cannot be calculated and Asystole, Vfib and Vtac cannot be analyzed. Check the connections of the electrodes and leadwires and check for any possible source of interference around the cable and electrode. Check the patient's condition and check the patient for great motion.
	ECG High Freq. Noise	L	A	High frequency signals are detected on the ECG analysis lead. Check for any possible source of interference around the cable and electrode.
	ECG Low Freq. Noise	L	A	Low frequency signals are detected on the ECG analysis lead. Check for any possible source of interference around the cable and electrode.
	ECG Amplitude Too Small	L	C	The ECG amplitude didn't reach the detected threshold. Check for any possible source of interference around the cable and electrode.
	ECG Config. Err	L	C	ECG configuration is wrongly downloaded. Check the downloaded configuration and re-download the correct configuration.
Resp	Resp Disturbed	L	A	The respiration circuit is disturbed. Restart the monitor.
Temp	Temp Cal. Err	H	C	A calibration failed. Restart the monitor.
	T1 Sensor Off	L	A	The Temp sensor has become detached from the patient or the module. Check the sensor connections.
	T2 Sensor Off	L	A	
SpO ₂	SpO ₂ Sensor Off	L*	B	The SpO ₂ sensor has become detached from the patient or the module, or there is a fault with the SpO ₂ sensor, or an unspecified SpO ₂ sensor has been used. Check the sensor application site and the sensor type, and make sure if the sensor is damaged. Reconnect the sensor or use a new sensor.
	SpO ₂ Sensor Fault	L	C	
	SpO ₂ No Sensor	L	B	
	SpO ₂ Unrecognized Sensor	L	C	
	SpO ₂ Sensor Incompatible	L	C	

Measurement	Alarm message	L	I	Cause and solution
	SpO ₂ Too Much Light	L	C	There is too much light on the SpO ₂ sensor. Move the sensor to a place with lower level of ambient light or cover the sensor to minimize the ambient light.
	SpO ₂ Low Signal	L	C	The SpO ₂ signal is too low or too weak. Check the patient's condition and change the sensor application site. If the error persists, replace the sensor.
	SpO ₂ Weak Signal	L	C	
	SpO ₂ Weak Pulse	L	C	
	SpO ₂ Interference	L	C	The SpO ₂ signal has been interfered. Check for any possible sources of signal noise around the sensor and check the patient for great motion.
	SpO ₂ Board Fault	L	C	There is a problem with the SpO ₂ measurement board. Do not use the module and contact your service personnel.
NIBP	NIBP Loose Cuff	L	A	The NIBP cuff is not properly connected, or there is a leak in the airway.
	NIBP Air Leak	L	A	
	NIBP Pneumatic Leak	L	A	Check the NIBP cuff and pump for leakages.
	NIBP Cuff Type Wrong	L	A	The cuff type applied mismatches the patient category. Verify the patient category and replace the cuff.
	NIBP Air Pressure Err	L	A	An error occurred to the air pressure. Verify that the monitor application site meets the environmental requirements and check if there is any source that affects the air pressure.
	NIBP Weak Signal	L	A	The patient's pulse is weak or the cuff is loose. Check the patient's condition and change the cuff application site. If the error persists, replace the cuff.
	NIBP Signal Saturated	L	A	The NIBP signal is saturated due to excess motion or other sources.
	NIBP Overrange	L	A	The measured NIBP value is not within the specified range.
	NIBP Excessive Motion	L	A	Check the patient's condition and reduce the patient motion.
	NIBP Cuff Overpress.	L	A	The NIBP airway may be occluded. Check the airway and measure again.
	NIBP Equip Err	H	A	An error occurred during NIBP measurement

Measurement	Alarm message	L	I	Cause and solution
	NIBP Timeout	L	A	and therefore the monitor cannot perform analysis correctly. Check the patient's condition and NIBP connections, or replace the cuff.
	NIBP Measure Failed	L	A	
	NIBP Illegally Reset	L	A	An illegal reset occurred during NIBP measurement. Check if the airway is occluded.
IBP	YY Sensor Off	L	A	Check the sensor connection and reconnect the sensor.
	YY represents an IBP label.			
C.O.	BT Sensor Off	L	A	Check the sensor connection and reconnect the sensor.
CO2	CO ₂ Sensor High Temp	L	C	Check, stop using or replace the sensor.
	CO ₂ Sensor Low Temp	L	C	Check, stop using or replace the sensor.
	CO ₂ Temp Overrange	L	C	The operating temperature of the CO ₂ module goes beyond the specified range. After it restores within the specified range, the module will restart automatically.
	CO ₂ Airway High Press.	L	C	An error occurred in the airway pressure.
	CO ₂ Airway Low Press.	L	C	Check the patient connection and patient circuit, and then restart the monitor.
	CO ₂ High Barometric Press.	L	C	Check the CO ₂ connections, make sure that the monitor application site meets the requirements, and check for special sources that affect the ambient pressure. Restart the monitor.
	CO ₂ Low Barometric Press.	L	C	
	CO ₂ FilterLine Occluded	L	C	The airway or watertrap was occluded. Check the airway and remove the occlusion.
	CO ₂ No Watertrap	L	B	Check the watertrap connections.
	CO ₂ Check Adapter	L	A	There is a problem with the airway adapter. Check, clean or replace the adapter.
	CO ₂ FilterLine Err	L	C	Check if there is a leak in the CO ₂ sample line or the CO ₂ sample line has been occluded.
	CO ₂ Zero Failed	L	A	Check the CO ₂ connections. After the sensor's temperature becomes stabilized, perform a zero calibration again.
	CO ₂ System Err	L	A	Re-plug the module or restart the monitor.
	CO ₂ Check Cal.	L	C	Perform a calibration.
CO ₂ Check Airway	L	C	An error occurred to the airway.	
CO ₂ No Filterline	L	A	Make sure that the filterline is connected.	

Measurement	Alarm message	L	I	Cause and solution
	CO ₂ No Sensor	L	A	Make sure that the sensor is connected.
	CO ₂ Main Board Err	H	C	There is a problem with the CO ₂ module. Re-plug the module or restart the monitor.
	CO ₂ Checking Sensor	L	C	
	CO ₂ Replace Scrubber&Pump	L	C	
	CO ₂ 15V Overrange	H	C	
	CO ₂ Hardware Err	H	C	
AG	AG No Watertrap	L	B	Check the connections of the watertrap and re-connect it.
	AG Change Watertrap	L	A	Wait until the change is completed.
	AG Watertrap Type Wrong	L	A	Make sure that a correct watertrap has been used.
	O ₂ Accuracy Unspecified	L	A	The measured value has exceeded the specified accuracy range.
	N ₂ O Accuracy Unspecified	L	A	
	CO ₂ Accuracy Unspecified	L	A	
	Enf Accuracy Unspecified	L	A	
	Iso Accuracy Unspecified	L	A	
	Sev Accuracy Unspecified	L	A	
	Hal Accuracy Unspecified	L	A	
	Des Accuracy Unspecified	L	A	
	awRR Accuracy Unspecified	L	A	
	AG Hardware Err	H	A	
	AG Airway Occluded	L	A	Check the airway and remove the occlusion.
AG Zero Failed	L	A	Re-plug the module or restart the monitor, and then perform a zero calibration again.	
RM	RM No Sensor	L	A	Check and reconnect the sensor.

Measurement	Alarm message	L	I	Cause and solution
	RM Sensor Reversed	L	C	
	RM Zero Failed	L	C	Perform a zero calibration again.
	RM Power Err	L	A	There is a problem with the power supply. Re-plug the module or restart the monitor.
BIS	BIS High Imped.	L	A	Check and reconnect the BIS sensor.
	BIS Sensor Off	L	A	
	BIS DSC Err	L	C	An error occurred to the DSC during receiving signals. Check the DSC.
	BIS DSC Malf	L	C	The DSC automatically shuts down as a result of malfunction. Check the DSC.
	BIS No Cable	L	A	Check the BIS cables.
	BISx Disconnected	L	A	Check the BISx module.
	BIS No Sensor	L	A	Check the BIS sensor.
	BIS Wrong Sensor Type	L	A	Check or replace the sensor.
	BIS Sensor Too Many Uses	L	A	Replace the sensor.
	SQI<50%	L	A	The SQI value is too low. Check the patient's condition and the sensor connections.
	SQI<15%	L	A	
	BIS Sensor Expired	L	A	Replace the sensor.
	BIS Sensor Fault	L	C	Re-attach or Replace BIS Sensor
Disconnect/Reconnect BIS	L	C	Re-plug the BIS Module	
ICG	ICG Low Quality Signal	L	A	Check and reconnect the sensor.
	ICG Left Neck Sensor Off	L	A	
	ICG Right Neck Sensor Off	L	A	
	ICG L. Thorax Sensor Off	L	A	
	ICG R. Thorax Sensor Off	L	A	
	ICG Sensor Off	L	A	
Power	12V Too High	H	C	There is a problem with the system power supply. Restart the monitor.
	12V Too Low	H	C	
	5V Too High	H	C	

Measurement	Alarm message	L	I	Cause and solution
	5V Too Low	H	C	
	3.3V Too High	H	C	
	3.3V Too Low	H	C	
	Battery Too Low	H	C	Connect the monitor to an AC power source and allow the batteries to charge.
	Different Battery Voltages	M	C	The two batteries have different charge capacity, or the batteries unspecified have been used, or there is a problem with the batteries. Make sure that correct batteries are used and the batteries are not damaged, or replace the batteries.
	Battery Power Overload	H	C	The power consumption of the equipment is too high. Power the monitor using an AC power source.
	RT Clock Not Exist	H	C	Contact your service personnel.
Recorder	Recorder Init Err N	L	A	Restart the monitor.
	N is within 1 to 8.			
	Recorder SelfTest Err	L	A	Stop the recording and restart the monitor.
	Recorder Comm Err	L	A	
	Recorder S. Comm Err	L	A	
	Recorder Unavailable	L	A	
	Recorder Vlt High	L	C	An error occurred to the system power supply. Restart the monitor.
	Recorder Vlt Low	L	C	
	Recorder Head Hot	L	C	The recorder has been working for too long time. Stop the recording and resume the recording till the recorder's printhead cools down.
Rec Paper Wrong Pos.	L	A	Re-load the recorder paper.	
System	System Watchdog Err	H	C	An error occurred to the system. Restart the monitor.
	System Software Err	H	C	
	System CMOS Full	H	C	
	System CMOS Err	H	C	
	System FPGA Err	H	C	
	System Err N	H	C	
	N is within 2 to 12.			

FOR YOUR NOTES

E Electrical Safety Inspection

The following electrical safety tests are recommended as part of a comprehensive preventive maintenance program. They are a proven means of detecting abnormalities that, if undetected, could prove dangerous to either the patient or the operator. Additional tests may be required according to local regulations.

All tests can be performed using commercially available safety analyzer test equipment. These procedures assume the use of a 601PROXL International Safety Analyzer or equivalent safety analyzer. Other popular testers complying with IEC 60601-1 used in Europe, such as Fluke, Metron, or Gerb, may require modifications to the procedure. Please follow the instructions of the analyzer manufacturer.

The electrical safety inspection should be periodically performed every two years. The safety analyzer also proves to be an excellent troubleshooting tool to detect abnormalities of line voltage and grounding, as well as total current loads.

E.1 Power Cord Plug

Test Item		Acceptance Criteria
The power plug	The power plug pins	No broken or bent pin. No discolored pins.
	The plug body	No physical damage to the plug body.
	The strain relief	No physical damage to the strain relief. No plug warmth for device in use.
	The power plug	No loose connections.
The power cord		No physical damage to the cord. No deterioration to the cord.
		For devices with detachable power cords, inspect the connection at the device.
		For devices with non-detachable power cords, inspect the strain relief at the device.

E.2 Device Enclosure and Accessories

E.2.1 Visual Inspection

Test Item	Acceptance Criteria
The enclosure and accessories	No physical damage to the enclosure and accessories.
	No physical damage to meters, switches, connectors, etc.
	No residue of fluid spillage (e.g., water, coffee, chemicals, etc.).
	No loose or missing parts (e.g., knobs, dials, terminals, etc.).

E.2.2 Contextual Inspection

Test Item	Acceptance Criteria
The enclosure and accessories	No unusual noises (e.g., a rattle inside the case).
	No unusual smells (e.g., burning or smoky smells, particularly from ventilation holes).
	No taped notes that may suggest device deficiencies or operator concerns.

E.3 Device Labelling

Check the labels provided by the manufacturer or the healthcare facilities are present and legible.

- Main unit label
- Integrated warning labels

E.4 Protective Earth Resistance

1. Plug the probes of the analyzer into the device's protective earth terminal and protective earth terminal of the AC power cord.
2. Test the earth resistance with a current of 25 A.
3. Verify the resistance is less than limits.

LIMITS

For all countries, $R = 0.2 \Omega$ Maximum

E.5 Earth Leakage Test

Run an Earth Leakage test on the device being tested before performing any other leakage tests. The following outlet conditions apply when performing the Earth Leakage test:

- normal polarity(Normal Condition),
- reverse polarity(Normal Condition),
- normal polarity with open neutral(Single Fault Condition),
- reverse polarity with open neutral(Single Fault Condition)

LIMITS

For UL60601-1,

- ◆ 300 μ A in Normal Condition
- ◆ 1000 μ A in Single Fault Condition

For IEC60601-1,

- ◆ 500 μ A in Normal Condition
- ◆ 1000 μ A in Single Fault Condition

E.6 Patient Leakage Current

Patient leakage currents are measured between a selected applied part and mains earth. All measurements have a true RMS only.

The following outlet conditions apply when performing the Patient Leakage Current test.

- normal polarity(Normal Condition);
- reverse polarity(Normal Condition),
- normal polarity with open neutral(Single Fault Condition);
- reverse polarity with open neutral(Single Fault Condition).
- normal polarity with open earth(Single Fault Condition);
- reverse polarity with open earth(Single Fault Condition).

LIMITS

For CF  applied parts

- ◆ 10 μ A in Normal Condition
- ◆ 50 μ A in Single Fault Condition

For BF  applied parts

- ◆ 100 μ A in Normal Condition
- ◆ 500 μ A in Single Fault Condition

E.7 Mains on Applied Part Leakage

The Mains on Applied Part test applies a test voltage, which is 110% of the mains voltage, through a limiting resistance, to selected applied part terminals. Current measurements are then taken between the selected applied part and earth. Measurements are taken with the test voltage (110% of mains) to applied parts in the normal and reverse polarity conditions

The following outlet conditions apply when performing the Mains on Applied Part test.

- Normal Polarity;
- Reversed Polarity

LIMITS

- For CF  applied parts: 50 μ A
- For BF  applied parts: 5000 μ A

E.8 Patient Auxiliary Current

Patient Auxiliary currents are measured between any selected Applied Part connector and the remaining Applied Part connectors. All measurements may have a true RMS only response.

The following outlet conditions apply when performing the Patient Auxiliary Current test.

- normal polarity(Normal Condition);
- reverse polarity(Normal Condition),
- normal polarity with open neutral(Single Fault Condition);
- reverse polarity with open neutral(Single Fault Condition).
- normal polarity with open earth(Single Fault Condition);
- reverse polarity with open earth(Single Fault Condition).

LIMITS

For CF  applied parts,

- ◆ 10 μ A in Normal Condition
- ◆ 50 μ A in Single Fault Condition

For BF  applied parts,

- ◆ 100 μ A in Normal Condition
- ◆ 500 μ A in Single Fault Condition

NOTE

- **Make sure the safety analyzer is authorized comply with requirement of IEC61010-1.**
 - **Follow the instructions of the analyzer manufacturer.**
-

FOR YOUR NOTES.

F Symbols and Abbreviations

F.1 Symbols

μA	microampere
μV	microvolt
μs	Microsecond
A	ampere
Ah	ampere hour
bpm	beat per minute
bps	bit per second
$^{\circ}\text{C}$	centigrade
cc	cubic centimeter
cm	centimeter
dB	decibel
DS	dyne second
$^{\circ}\text{F}$	fahrenheit
g	gram
GHz	gigahertz
GTT	gutta
h	hour
Hz	hertz
in	inch
kg	kilogram
kPa	kilopascal
L	litre
lb	pound
m	meter
mAh	milliampere hour
Mb	mega byte
mcg	microgram
mEq	milli-equivalents
mg	milligram
min	minute

ml	milliliter
mm	millimeter
mmHg	millimeters of mercury
cmH ₂ O	centimeters of water
ms	millisecond
mV	millivolt
mW	milliwatt
MΩ	megaohm
nm	nanometer
rpm	breath per minute
s	second
V	volt
VA	volt ampere
Ω	ohm
W	watt
–	minus, negative
%	percent
/	per; divide; or
+	plus
=	equal to
<	less than
>	greater than
≤	less than or equal to
≥	greater than or equal to
±	plus or minus
×	multiply

F.2 Abbreviations

AaDO ₂	alveolar-arterial oxygen gradient
AAMI	Association for Advancement of Medical Instrumentation
AC	alternating current
ACI	acceleration index
Adu	adult
AG	anaesthesia gas
AHA	American Heart Association
ANSI	American National Standard Institute
Ao	aortic pressure
Art	arterial
aVF	left foot augmented lead
aVL	left arm augmented lead
aVR	right arm augmented lead
awRR	airway respiratory rate
BAP	brachial arterial pressure
BIS	bispectral index
BP	blood pressure
BPSK	binary phase shift keying
BSA	body surface area
BT	blood temperature
BTPS	body temperature and pressure, saturated
C.I.	cardiac index
C.O.	cardiac output
CaO ₂	arterial oxygen content
CCO	continuous cardiac output
CCU	cardiac (coronary) care unit
CE	Conformité Européenne
CIS	Clinical Information System
CISPR	International Special Committee on Radio Interference
CMOS	complementary metal oxide semiconductor
CMS	central monitoring system
C.O.	cardiac output
CO ₂	carbon dioxide

COHb	carboxyhemoglobin
CP	cardiopulmonary
CVP	central venous pressure
DC	direct current
Des	desflurane
Dia	diastolic
DPI	dot per inch
DVI	digital video interface
ECG	electrocardiograph
EDV	end-diastolic volume
EEC	European Economic Community
EEG	electroencephalogram
EMC	electromagnetic compatibility
EMG	electromyography
EMI	electromagnetic interference
Enf	enflurane
ESU	electrosurgical unit
Et	end-tidal
EtCO ₂	end-tidal carbon dioxide
EtN ₂ O	end-tidal nitrous oxide
EtO	ethylene oxide
EtO ₂	end-tidal oxygen
FAP	femoral arterial pressure
FCC	Federal Communication Commission
FDA	Food and Drug Administration
FEV1.0%	first second forced expiratory volume ratio
Fi	fraction of inspired
FiCO ₂	fraction of inspired carbon dioxide
FiN ₂ O	fraction of inspired nitrous oxide
FiO ₂	fraction of inspired oxygen
FPGA	field programmable gate array
FV	flow-volume
Hal	halothane
Hb	hemoglobin
Hb-CO	carbon mono-oxide hemoglobin
HbO ₂	oxyhemoglobin
HR	heart rate

I:E	inspiratory-expiratory ratio
IBP	invasive brood pressure
ICG	impedance cardiography
ICP	intracranial pressure
ICT/B	intracranial catheter tip pressure transducer
ICU	intensive care unit
ID	identification
IEC	International Electrotechnical Commission
IEEE	Institute of Electrical and Electronic Engineers
Ins	inspired minimum
IP	internet protocol
Iso	isoflurane
IT	injectate temperature
LA	left arm
LAP	left atrial pressure
Lat	lateral
LCD	liquid crystal display
LCW	left cardiac work
LCWI	left cardiac work index
LED	light emitting diode
LL	left leg
LVD	low voltage directive
LVDS	low voltage differential signal
LVET	left ventricular ejection time
LVSW	left ventricular stroke work
LVSWI	left ventricular stroke work index
MAC	minimum alveolar concentration
Art mean	mean arterial pressure
MDD	Medical Device Directive
MetHb	methemoglobin
MRI	magnetic resonance imaging
MVe	expiratory minute volume
MVi	inspiratory minute volume
N/A	not applied
N ₂	nitrogen
N ₂ O	nitrous oxide
Neo	neonate

NIBP	noninvasive blood pressure
O ₂	oxygen
O ₂ CI	oxygen consumption index
O ₂ R	oxygen extraction ratio
OR	operating room
oxyCRG	oxygen cardio-respirogram
PA	pulmonary artery
Paw	airway pressure
PAWP	pulmonary artery wedge pressure
PD	photodetector
Ped	pediatric
PEEP	positive end expiratory pressure
PEF	peak expiratory flow
PEP	pre-ejection period
PIF	peak inspiratory flow
PIP	peak inspiratory pressure
Pleth	plethysmogram
Pmean	mean pressure
Pplat	plateau pressure
PR	pulse rate
PVC	premature ventricular contraction
PVR	pulmonary vascular resistance
PVRI	pulmonary vascular resistance index
R	right
RA	right arm
RAM	random access memory
RAP	right atrial pressure
Rec	record, recording
Resp	respiration
RHb	reduced hemoglobin
RL	right leg
RM	respiratory mechanics
RR	respiration rate
RSBI	rapid shallow breathing index
SaO ₂	arterial oxygen saturation
SEF	spectral edge frequency
Sev	sevoflurane

SFM	self-maintenance
SI	stroke index
SMR	satellite module rack
SpO ₂	arterial oxygen saturation from pulse oximetry
SQI	signal quality index
SR	suppression ratio
STR	systolic time ratio
SV	stroke volume
SVR	systemic vascular resistance
SVRI	systemic vascular resistance index
Sync	synchronization
Sys	systolic pressure
Taxil	axillary temperature
TD	temperature difference
Temp	temperature
TFC	thoracic fluid content
TFI	thoracic fluid index
TFT	thin-film technology
Toral	oral temperature
TP	total power
Trect	rectal temperature
TVe	expiratory tidal volume
TVi	inspiratory tidal volume
UAP	umbilical arterial pressure
UPS	uninterruptible power supply
USB	universal serial bus
UVP	umbilical venous pressure
VAC	volts alternating current
VEPT	volume of electrically participating tissue
VI	velocity index
WLAN	wireless local area network

FOR YOUR NOTES

Mindray DS USA, Inc.
800 MacArthur Blvd.
Mahwah, New Jersey 07430
USA
Tel 1.800.288.2121
Tel 1.201.995.8000

www.mindray.com