

**Resona 7/Resona 7CV/Resona 7EXP/Resona 7S/Resona 7OB/Resona
7PRO/Resona R9 Exp/Resona R9 Pro/Resona R9S/Nuewa R9/Nuewa
R9 Exp/Nuewa R9 Pro/Nuewa R9S/Imagyn 7/Resona R9/Resona
Y/Resona R9W/Resona R7W/Nuewa R9W/Nuewa R7W**

Diagnostic Ultrasound System

Operator's Manual

[Advanced Volume]

Content

Content	i
Intellectual Property Statement	I
Preface	II
Safety Precautions	III
1 Overview	1-1
1.1 Basic Operations and Buttons.....	1-1
1.2 Measurement Menu	1-2
1.2.1 Measurement Location	1-5
1.2.2 Measurement Tool	1-5
1.2.3 Mode Switching	1-6
1.2.4 Measurement Library Switching	1-7
1.3 Measurement, Calculation and Study	1-7
1.4 Measurement Caliper.....	1-8
1.5 Results Window.....	1-8
1.5.1 Results Display	1-8
1.5.2 Moving the Results Window	1-8
1.5.3 Results Window Assignment	1-9
1.6 Cross-window Measurement.....	1-10
1.7 Report.....	1-10
1.7.1 Viewing Reports.....	1-10
1.7.2 Editing Reports	1-11
1.7.3 Viewing History Reports	1-17
1.7.4 Printing Reports	1-17
1.7.5 Fetal Growth Curve.....	1-17
1.7.6 Report Settings.....	1-17
2 Measurement Preset	2-1
2.1 Basic Preset Procedures.....	2-1
2.2 Measurement Parameters Preset	2-1
2.3 Obstetric Preset.....	2-3
2.3.1 Obstetric Formula	2-3
2.3.2 Obstetric Preset Operations	2-9
2.4 Measurement Preset.....	2-11
2.4.1 General Measurement Preset	2-11
2.4.2 Application Measurement Preset.....	2-15
2.4.3 Report Preset.....	2-22
2.5 Fast Measurement	2-24
3 General Measurement	3-1
3.1 Basic General Measurement Procedures	3-1
3.2 2D General Measurements	3-2
3.2.1 Depth	3-2
3.2.2 Distance.....	3-2
3.2.3 Distance P-L	3-2
3.2.4 Angle.....	3-2
3.2.5 Area & Circumference	3-3
3.2.6 Volume.....	3-4

3.2.7	Double Dist.	3-5
3.2.8	Parallel	3-6
3.2.9	Curve Length	3-6
3.2.10	Ratio (D)	3-6
3.2.11	Ratio (A)	3-7
3.2.12	B-Profile	3-7
3.2.13	B-Hist	3-7
3.2.14	B-Ratio	3-8
3.2.15	Color Vel.	3-8
3.2.16	Volume Flow	3-9
3.2.17	IMT	3-9
3.2.18	Strain	3-9
3.2.19	Strain Ratio	3-9
3.2.20	Strain.Hist	3-10
3.2.21	Elastography	3-10
3.2.22	Elas. Ratio	3-11
3.2.23	Elas. Hist.	3-12
3.2.24	Directional Ratio	3-13
3.2.25	TSM	3-14
3.2.26	RAC	3-14
3.2.27	Smart Trace	3-15
3.2.28	Smart Caliper	3-15
3.2.29	Color Pixel Percentage	3-15
3.3	M General Measurements	3-16
3.3.1	Distance	3-16
3.3.2	Time	3-16
3.3.3	Slope	3-17
3.3.4	Velocity	3-17
3.3.5	HR	3-17
3.3.6	HR (R-R)	3-18
3.4	Doppler General Measurements	3-18
3.4.1	Time	3-18
3.4.2	HR	3-18
3.4.3	D Vel.	3-18
3.4.4	Acceleration	3-18
3.4.5	D Trace	3-19
3.4.6	PS/ED	3-22
3.4.7	Volume Flow	3-22
3.4.8	Velocity Ratio	3-23
3.4.9	VTI Ratio	3-24
3.4.10	HR (R-R)	3-24
3.5	References	3-25
4	Abdomen	4-1
4.1	Abdomen Exam Preparations	4-1
4.2	Basic Abdomen Measurement Procedures	4-1
4.3	Abdomen Measurement Tools	4-2
4.4	Abdomen Measurement Operations	4-11
4.5	Calculation Tool Operations	4-12
4.6	Abdomen Exam Report	4-12
5	Obstetrics	5-1

5.1	Obstetric Exam Preparations	5-1
5.2	Basic Measurement Procedures	5-1
5.3	GA	5-2
5.3.1	Clinical GA	5-2
5.3.2	Ultrasound GA	5-2
5.4	Obstetric Measurement Tools	5-5
5.5	Obstetric Measurement Operations	5-14
5.5.1	Measurement Tool Operations	5-14
5.5.2	Calculation Tool Operations.....	5-15
5.5.3	Study Tool Operations	5-15
5.6	Multi-Fetus Exam	5-15
5.7	Obstetric Exam Report.....	5-17
5.7.1	Fetal Biophysical Profile	5-17
5.7.2	Comparison Bar.....	5-17
5.7.3	Z-Score	5-18
5.7.4	Fetal Growth Curve.....	5-18
5.8	References	5-19
6	Cardiology.....	6-1
6.1	Cardiac Exam Preparations	6-1
6.2	Basic Cardiac Measurement Procedures	6-1
6.3	Cardiac Measurement Tools	6-1
6.3.1	2D Cardiac Measurements.....	6-2
6.3.2	M Cardiac Measurements	6-6
6.3.3	Doppler Cardiac Measurements.....	6-8
6.3.4	TDI Cardiac Measurements.....	6-11
6.4	Cardiac Measurement Operations	6-12
6.4.1	Measurement Tool Operations	6-13
6.4.2	Calculation Tool Operations.....	6-15
6.4.3	Study Tool Operations	6-15
6.5	Cardiac Exam Report.....	6-37
6.6	References	6-38
7	Vascular.....	7-1
7.1	Vascular Exam Preparations.....	7-1
7.2	Basic Vascular Measurement Procedures	7-1
7.3	Vascular Measurement Tools	7-2
7.4	Vascular Measurement Operations.....	7-21
7.4.1	Measurement Tool Operations	7-21
7.4.2	Calculation Tool Operations.....	7-21
7.4.3	Study Tool Operations	7-22
7.5	Vascular Exam Report.....	7-23
7.6	References	7-24
8	Gynecology.....	8-1
8.1	Gynecology Exam Preparations.....	8-1
8.2	Basic Gynecology Measurement Procedures.....	8-1
8.3	Gynecology Measurement Tools.....	8-2
8.4	Gynecology Measurement Operations.....	8-6
8.4.1	Measurement Tool Operations	8-7
8.4.2	Calculation Tool Operations.....	8-7
8.4.3	Study Tool Operations	8-8
8.5	Gynecology Exam Report	8-9

8.6	References	8-9
9	Urology	9-1
9.1	Urology Exam Preparations	9-1
9.2	Basic Urology Measurement Procedures	9-1
9.3	Urology Measurement Tools	9-2
9.4	Urology Measurement Operations	9-5
9.4.1	Measurement Tool Operations	9-5
9.4.2	Calculation Tool Operations.....	9-5
9.4.3	Study Tool Operations	9-7
9.5	Urology Exam Report.....	9-8
9.6	References	9-8
10	Small Parts	10-1
10.1	Small Parts Exam Preparations	10-1
10.2	Basic Small Parts Measurement Procedures	10-1
10.3	Small Parts Measurement Tools	10-2
10.4	Small Parts Measurement Operations	10-4
10.4.1	Measurement Tool Operations	10-4
10.4.2	Calculation Tool Operations.....	10-4
10.4.3	Study Tool Operations	10-5
10.5	Small Parts Exam Report.....	10-5
10.6	References	10-5
11	Pediatrics.....	11-1
11.1	Pediatrics Exam Preparations.....	11-1
11.2	Basic Pediatrics Measurement Procedures	11-1
11.3	Pediatrics Measurement Tools	11-1
11.4	HIP Measurement Operations.....	11-3
11.5	Pediatrics Exam Report	11-5
11.6	References	11-5
12	Emergency & Critical.....	12-1
12.1	Basic Measurement Procedures	12-1
12.2	EM Measurement Tools.....	12-1
12.3	EM Exam Report.....	12-2
13	Nerve.....	13-1
13.1	Basic Measurement Procedures	13-1
13.2	Nerve Measurement Tools	13-1
13.3	Nerve Exam Report.....	13-1

© 2022 Shenzhen Mindray Bio-medical Electronics Co., Ltd. All Rights Reserved.

The issue date of this Operator's Manual is 2022-10.

Intellectual Property Statement

SHENZHEN MINDRAY BIO-MEDICAL ELECTRONICS CO., LTD. (hereinafter referred to as Mindray) owns the intellectual property rights to this Mindray product and this manual. This manual may refer to information protected by copyright or patents and does not convey any license under the patent rights or copyright of Mindray or of others.

Mindray intends to maintain the contents of this manual as confidential information. Disclosure of the information in this manual in any manner whatsoever without the written permission of Mindray is strictly forbidden.

Release, amendment, reproduction, distribution, rental, adaptation, translation or any other derivative work of this manual in any manner whatsoever without the written permission of Mindray is strictly forbidden.

IMPORTANT!

1. No part of this manual may be copied or reprinted, in whole or in part, without written permission.
2. The contents of this manual are subject to change without prior notice and without our legal obligation.

Preface

This manual details the procedures for operating the Diagnostic Ultrasound System. Carefully read and understand the manual before using the system to ensure its safe and correct operation.

NOTE: When operating the system, refer to the following manuals:

- Operator's Manual (Basic Volume)
- Acoustic output data

Depending on the software version, the preset settings and optional configuration, the actual interfaces may appear differently from those shown in this manual.

NOTE: The functions described in this manual are not provided for all systems sold in all regions. The functions available depend on the specific system purchased.

All the menus and screens in this manual take the system in full configuration as an example.

Safety Precautions

1. Meanings of Signal Words

In this manual, the signal words **⚠️ Danger**, **⚠️ WARNING**, **⚠️ CAUTION** and **NOTE** are used regarding safety and other important instructions. The signal words and their meanings are defined as follows. Please understand their meanings clearly before reading this manual.

Signal word	Meaning
⚠️ Danger	Indicates an imminently hazardous situation that, if not avoided, will result in death or serious injury.
⚠️ WARNING	Indicates a potentially hazardous situation that, if not avoided, could result in death or serious injury.
⚠️ CAUTION	Indicates a potentially hazardous situation that, if not avoided, may result in minor or moderate injury.
NOTE	Indicates a potentially hazardous situation that, if not avoided, may result in property damage.

2. Meaning of Safety Symbols

Symbol	Description
	General warning, caution, risk of danger.

3. Safety Precautions

Please observe the following precautions to ensure patient and operator safety when using this system.

 CAUTION:	<ol style="list-style-type: none"> 1. Select the proper patient image and measurement tools. Only qualified professionals can decide the appropriate measurements and results. 2. Confine measurement calipers to the actual Region of Interest (ROI). Measurements that extend beyond the ROI will be incorrect. 3. Before examining a new patient, it is necessary to click [End] on the touch screen to end the current scan and delete the patient information and data. Failure to do so will result in new patient data being combined with the previous patient's data. 4. When the system is turned OFF or the [End] button is clicked, all unsaved data are lost. 5. Changing modes during a measurement will delete the General Measurement data. 6. Pressing the <Freeze> key to unfreeze the image during a measurement will clear the General Measurement data. 7. Pressing the <Measure> key during a measurement will clear the General Measurement data.
---	--

8. Pressing the <Clear> key will clear the measurement caliper and all data in the result window, such as comments and body marks.
9. Tapping [Del Meas.] during a measurement will clear the Measurement data.
10. In dual-B imaging mode, the measurement results of the merged image can be inaccurate. Therefore, the results are provided for reference only, not for confirming diagnoses.
11. The quality of the extended image constructed in iScape (panoramic imaging) is dependent on the skill of the operator. Extra attention should be paid during the iScape measurement since the results could be inaccurate.
12. Ensure that measurement data correctly corresponds to the fetus during the Obstetric Measurement.
13. Fully understand the functionality of this system by referring to the *Operator's Manual - Basic Volume*.
14. When the result of auto trace does not match the image exactly, perform the measurement manually.

1 Overview

1.1 Basic Operations and Buttons

Tip: The following descriptions for buttons and keys are used in this manual:

- < >: Denotes a key/button on the control panel or keyboard. E.g. <Set>.
- []: Denotes a button/item on the screen menu or touch screen. E.g. [OK].

Click/Select [item/button]: to move the cursor over the item/button and press <Set>.

Basic Measurement Procedures

1. Click [End] on the touch screen to end the last exam.
2. Click [Info] on the touch screen and enter the patient information,
This includes patient ID, name, height, weight, etc. Enter manually for a new patient or load an existing patient from iStation or Worklist.
The patient information entered is used for measurement data storage, analysis and exam report. For more details, see “Exam Preparation → Patient Information” in the Operator's Manual [Basic Volume].
3. Click [Probe] on the touch screen and select a proper exam mode.
For more details, see “Select Exam Mode and Probe” chapter in the Operator's Manual [Basic Volume].
4. Measurement preset.
To preset measurement parameters, obstetric formula, general/application measurement packages, etc., see “2 Measurement Preset” for details.
5. Press <Measure> or <Caliper> to start measurement.
6. Select an item from the measurement menu or touch screen to start.
For general and application measurement items (tools), see chapter “3 General Measurement” of the specified application measurements for details.
7. Click [Report] on the touch screen to view the exam report.
For report editing and browsing, see “1.7 Report.”

Button Functions

Keys	Basic Operations
Measure	To enter/exit the application measurement.
Caliper	To enter/exit the general measurement.
Left/right Set key	To select an item in the measurement menu and press <Set> to activate it. Press <Set> to confirm and end the current operation during measurement.
Update	To switch between the fixed end and active end of the caliper during a measurement. In iWorks status, press to enter a measurement according to the prompt.

Keys	Basic Operations
Clear	Short press: to return to the previous measurement step or delete the caliper backwards. Long press: to clear all measurement calipers on the screen and data in the results window.
Cursor	To show/hide the cursor.
Trackball	To move the cursor.
Two-finger gesture	You can do fast measurement using two-finger gesture according to the gesture hints  on the bottom-right of the screen. For details about two-finger gesture function setting, see “Setup” chapter in Basic Volume. (Setting path: [Setup]→[System]→[Gesture])

For details on key functions, see “System Overview” chapter in the Operator's Manual [Basic Volume].

1.2 Measurement Menu

The General and Application measurement menus are different. For more information on the measurement menu, see “3 General Measurement” and the specified application measurement chapter.

- The measurement menu is as follows:
 - Non-mapping mode

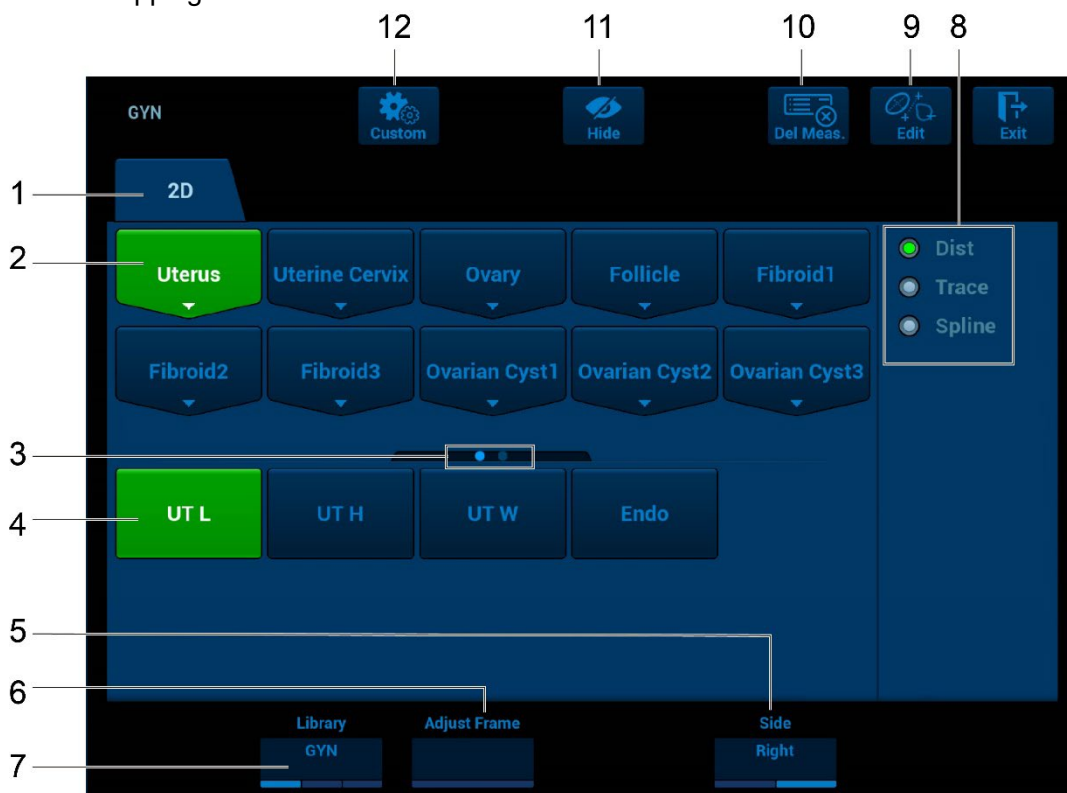

Item	Description
1.	Imaging mode
2.	Measurement item (main menu)

Item	Description
3.	Page up/down
4.	Measurement item (sub menu)
5.	Measurement location
6.	Select Frame
7.	Measurement library
8.	Measurement method
9.	Edit measurement
10.	Delete measurement
11.	Display or hide measurement results
12.	Customize the measurement font color and size

■ Mapping mode

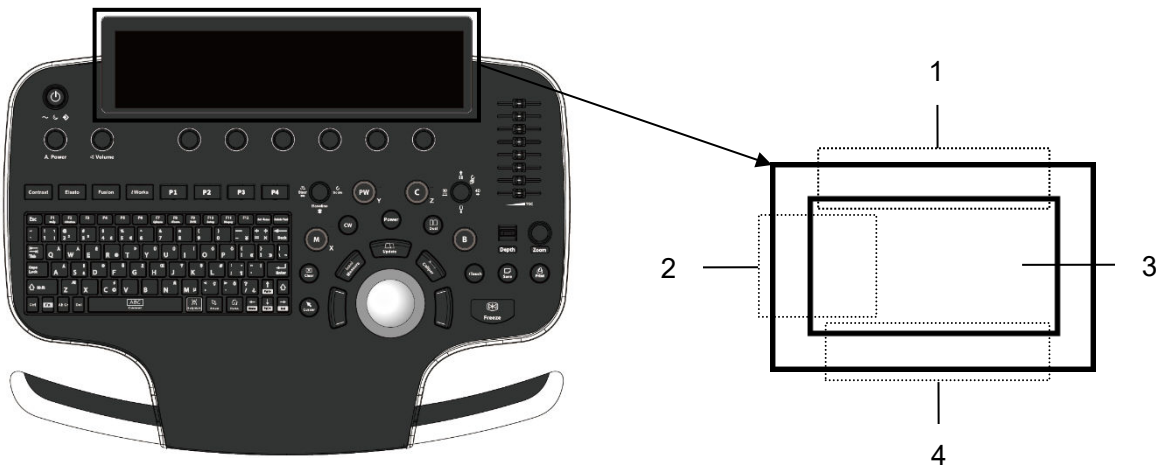

Operating region	Operations
1.	Swipe from this area to bottom to enter the mapping mode.
2.	Under mapping mode, swipe from this area to right to display the mapping menu.
3.	Under mapping mode, this area displays mapping menu, soft menu and tool bar, where you can adjust image parameters, perform measurement, image sending and review. Under mapping/non-mapping mode, you can do fast operation using two-finger gesture according to the gesture hints  on the bottom-right of the screen.
4.	Under mapping mode, swipe from this area to the top to exit mapping mode.

● Enter mapping mode

Swipe the touch screen from top (region 1) to bottom to enter the mapping mode. The system maps the image of the monitor onto the touch screen. See the figure below.

Tips: if there is dialogue box on the screen, mapping mode is not available.

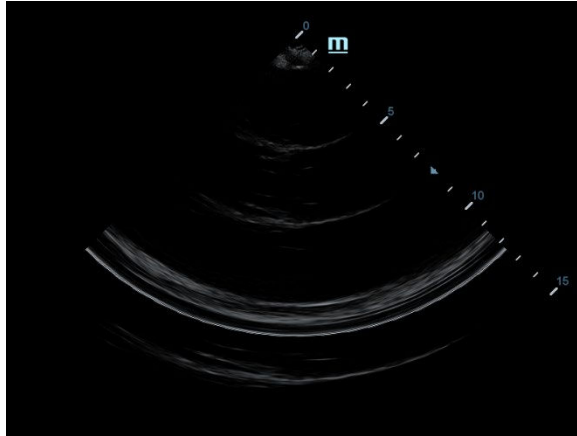

- **Menu Operations**
 Swipe the touch screen from left (region 2) to right to show the mapping menu. See the figure below.
 Touch the measurement menu to select measurement tools and start measurement.
 Touch any blank area on the touch screen to hide the mapping menu.

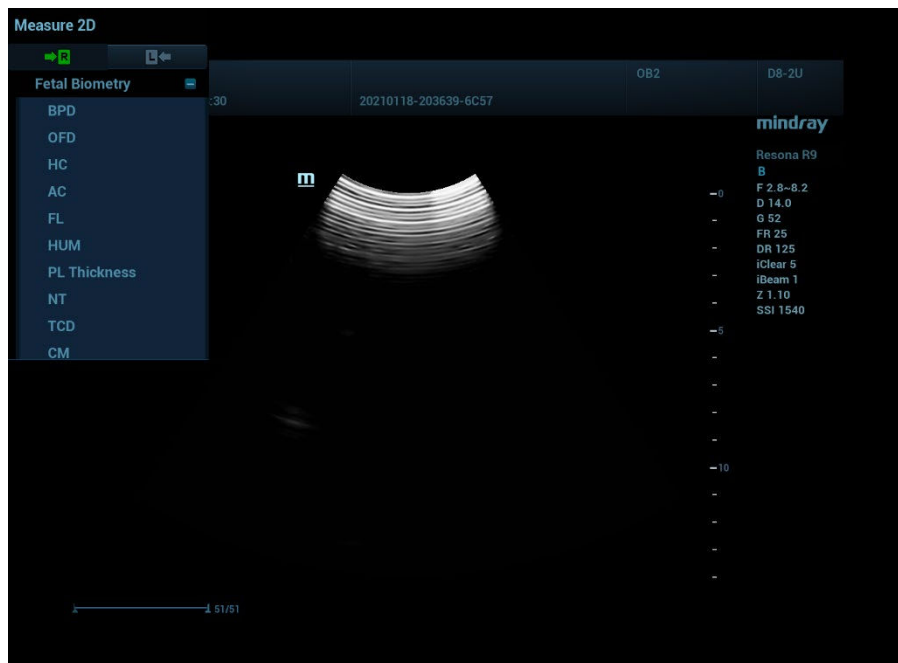

- Use the caliper to perform measurements, see “1.2.2 Measurement Tool” for details.
- **Soft Menu Operations**
 Under mapping mode, rotate the knobs beneath the touch screen to show the soft menu.
 Rotate the knob to complete the adjustment.

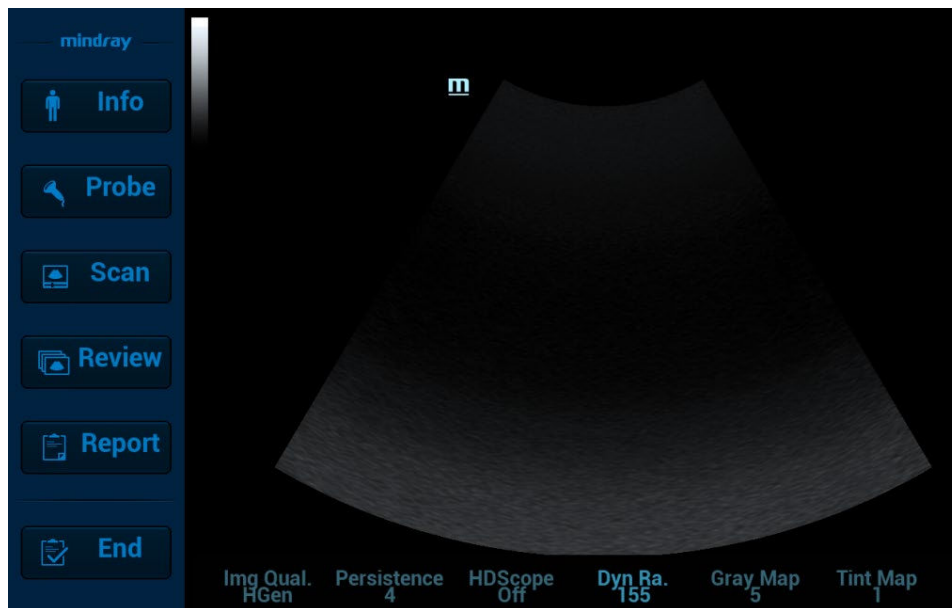

- Two-finger gesture
For details about two-finger gesture function setting, see “12.1.6 Key Configuration” chapter in operator’s manual [Basic Volume].
To start fast measurement: swipe the touch screen (region 3) with two fingers by the hint in user-defined key function display region on the bottom-right of the screen.
- Exit mapping mode
Swipe the touch screen from bottom to top to exit the mapping mode.

1.2.1 Measurement Location

The location widgets are used to select the measurement locations.

- Side (Left/Right): belongs to items (e.g., kidney) that contain measurements of left/right side parameters respectively.
- Location (Prox./Mid./Dist.): belongs to items (e.g., vascular) that contain measurements of Proximal, Middle or Distal parameters.
- Location (Far/near): belongs to items (e.g., carotid) that contain measurements of anterior or posterior parameters.
- Pole (U/M/L): belongs to items (e.g., some abdomen vessels) that contain measurements of upper, middle or lower parameters.

Tip: The location widgets are applicable only in the application measurements.

1.2.2 Measurement Tool

There are two kinds of measurement tools.

- General tools: basic measurement tools in General Measurement, such as the “distance” and “Area.”
- Application tools: the measurement tools in Application Measurement. These items are classified and combined in clinical application packages such as Abdomen, Obstetric, etc. For example, HC (head circumference) in the Obstetric measurements is one of the application tools.

Tip: 1. Most application tools use the general measurement method while measuring, e.g., an “Area” tool is used when measuring the HC. Only the application measurement results are recorded in the report.

2. For the definitions of measurement, calculation and study, see “1.3 Measurement, Calculation and Study.”

To Activate the Measurement Tool

The procedure is as follows:



1. Select the tool:
 - Move the cursor onto the tool on the measurement menu and press <Set>.
 - Or, touch the item on the touch screen or mapping menu to select the tool.
 - Or, use the two-finger gesture  on the touch screen. See “1.2 Measurement Menu” for details.
2. Perform the measurement according to the actual situation.
3. After finishing the measurement, perform the necessary operations.

Select Measurement Method

Some measurement tools have multiple methods to select.

Select measurement items and measurement tools on the touch screen.

Other Features

Features	Descriptions
Current measurement tool/item	Highlighted.
Measured item	A performed application item/tool is marked with a “√.” (If one or some items in a submenu (extended menu) of a study are already performed, this study will be marked as measured.)
Page up/down	Use the  in the menu. Touch  or  on the touch screen or swipe the screen from right to the left. Flip the mapping menu up/down under touch screen mapping mode.
Results window	Show/hide the results window by clicking [Hide] on the touch screen.
Measurement item	Tap [Edit]. Select the measurement caliper. Move the pointer of the measurement caliper. The measurement is updated in the result window.
Deleting measurement data	Tap [Del Meas.], the measurement data of the current exam will be cleared.

1.2.3 Mode Switching

Touch the mode tab to switch to other measurement menus available for other modes.

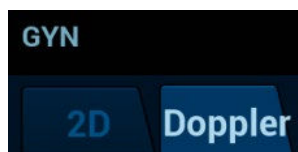

1.2.4 Measurement Library Switching

- During application measurement, rotate the knob under [Library] on the touch screen to select from the available measurement libraries under the current probe of the current exam mode.
- Click menu title in the top-left corner of the screen to switch, as shown below:



Available measurement libraries can be preset. See “2.4.2.2 Measurement Package Preset” chapter for details.

1.3 Measurement, Calculation and Study

There are three kinds of measurement items.

Measurement

Results of measurements are directly obtained via the measurement tools, which are indicated by “” in the preset screen ([Setup] -> [Measure]).

For example, “Distance” in the 2D general measurement or “HC” in the OB measurement.

On the touch screen, measurement tools are displayed using square button as



Renal L

Calculation

Results of calculations are automatically derived by the system using other measured or calculated values as parameters, they are indicated by “” in the preset screen ([Setup] -> [Measure]).

For example, EFW (Estimated Fetal Weight) in the OB measurement.

If all measurements related to a calculation tool are completed, the system will automatically calculate the result. If some measurement tools are performed again, the system will automatically update the calculation result using the latest measurement results.

On the touch screen, calculation tools are displayed using square button as



UT W

Study

A group of measurements and/or calculations for a specific clinical application, which are indicated by “” in the preset screen ([Setup] -> [Measure]).

For example, AFI in the OB measurement.

Fold/unfold the study to hide/show the measurement or calculation items included.



Uterine
Cervix

On the touch screen, study items are displayed as , with an arrow indicating the tools to be selected.

1.4 Measurement Caliper

A measurement caliper is a graphic consisting of several points and a straight line or curve drawn on the ultrasound image.

Fixed/Active End

The ends of calipers can be active or fixed. The active end is called a Cursor.

Caliper Color

An active caliper appears green, while a fixed one appears white in the system default preset. Tap [Custom] on the measurement menu of the touch screen to set the caliper color.

Caliper End Symbols

8 symbols are used as caliper ends, as shown in the figure below.

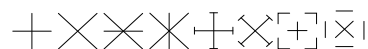

These symbols display in calipers as well as in the results window to identify different measurements.

NOTE: You can preset the cursor type in [Setup]->[System Preset] → [Application], see “2.2 Measurement Parameters Preset” for more information.

1.5 Results Window

The measurement window displays the conducted measurement's result and the engaging measurement in real time.

1.5.1 Results Display

Select [Hide] on the touch screen and the latest results display in the results window in time sequence.

When viewing the results:

- If the results window is full, the oldest value will be replaced according to the “first in, first out” rule.
A maximum of 16 results can display in the results window and a maximum of two graphical results windows can display in the screen.
- To identify the measurement results, symbols or numbers are used in the numerical results window (B-histogram, B-profile) while “No:1” or “No:2” is used in the graphical results window.

The results can display as follows:

- No result displays when a measurement item/tool is activated but without the start point fixed.
- The result displays as digits when the value obtained is within the clinical range.
- The result displays as “?” when it is out of the ultrasonic range.
- Tap [Custom] on the measurement menu of the touch screen to set the font color of result windows.

1.5.2 Moving the Results Window

To move the results window,

1. Place the cursor on the results window title and press <Set>.
2. Rotate the trackball to place the results window in the desired position.

3. Press <Set> to fix the results window.

1.5.3 Results Window Assignment

An application measurement result can be assigned to a general measurement item from the results window. The application item can be an existing item in the system or a new user-defined one.

Assigning an Existing Application Item

The procedure is as follows:

1. Move the cursor to a general measurement value in the results window. Press <Set> when the item is highlighted in green and the matching list appears as shown below.

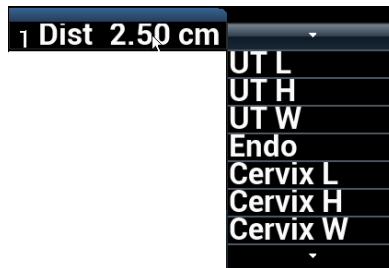

Application items that meet the following requirements are displayed:

- Contained in the current application package.
- The item to be assigned and the assigner should use the same general measurement tool for the result.

Application items in the current measurements that use the “Distance” method are listed as shown above.

2. Select an application item from the list, then press <Set>.
3. The assigned value displays in the results window and is saved in the exam report.

Assigning a New Application Item

When no (desired) item displays in the matching list, you can create a new application item. The procedure is as follows:

1. Select [new] at the bottom of the matching list.
2. The following dialog box appears.

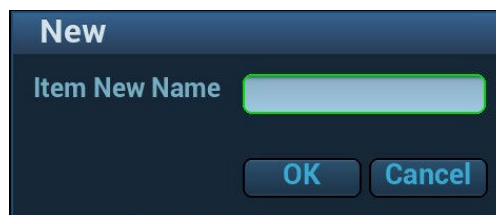

Type in the new name.

3. Click [OK] to assign the general result to the new item.

NOTE: Re-assignment for the assigned general result is not available.

Exiting Result Assignment

Press <Esc> on the keyboard, or select [Cancel] in the matching list to exit.

Auto-Spectrum Calculation Assignment

Like a general measurement result, you can assign the auto-spectrum calculation results to an application item, using the same steps as described above.

For details about auto-spectrum calculation, see “3.4.5 D Trace.”

NOTE: The application item to assign should be an item using D trace in the current application package.

1.6 Cross-window Measurement

For linear probing, cross-window measurement is available in dual-B mode when the left and right windows are imaging with the same probe, depth and invert mode.

Under Free Xros M mode (option), you can perform cross-window measurement of time and HR.

1.7 Report

The report records measurement results, which are automatically saved by the system after each measurement.

- Click [Report] on the touch screen to enter the report dialog box.
- The default report of the current exam appears.
- After viewing, press <Freeze> or <Esc>, or select [Report], [Cancel] or [Save] to exit the report page.

1.7.1 Viewing Reports

Items on the report page are described as follows:

Report Type:
Obstetrics

Name: _____ DOB: _____ Operator: _____
 ID: _____ Age: _____ Ref.Physician: _____
 LMP: _____ GA: _____ EDD(LMP): **AUA** 16w1d EDD(AUA): 06/01/2015

2D Measurements

EFW

EFW **Hadlock(AC,FL,HC,BPD)** 135g (5 oz) ±20g (1 oz)
 EFW-GA **Hadlock** 15w4d
 EFW-GP(AUA)(Hadlock) 19.77%

	Formula	Value	1	2	3	Method	GA	Range
BPD	Hadlock	3.83cm	4.74	2.91		Avg	17w5d	
HC	Hadlock	10.86cm	10.86			Avg	15w2d	
AC	Hadlock	10.20cm	10.20			Avg	16w2d	
FL	Hadlock	1.81cm	1.81			Avg	15w3d	

	Value	1	2	3	Method
OFD(HC)	3.47cm	3.47			Avg

CI(HC) 110.09* (70.00~86.00) HC/AC(Campbell) 1.07 (GA None) FL/BPD 47.32 (GA None)

1/2

Add Picture **Clear All** **Previous** **Next** **Save** **Cancel**

- Each measurement contains the three latest values and a final value.
- The report only displays results of tools that are displayed in the report template by default and are completed, as shown in the figure above.
- Select [Previous] or [Next] to switch between pages if the report has more than one page.

1.7.2 Editing Reports

Available report editing operations are:

- Editing measurement data
- Entering ultrasound remarks
- Selecting images
- Adding anatomy images
- Save/load report
- Analyzing report data

Editing Measurement Data

 **CAUTION:** Input appropriate data when editing the measurement values, otherwise misdiagnosis may occur.

- The three measurement values in the text boxes are editable. Move the cursor to the text box and press <Set>.
- The modified value(s) is/are underlined.
- The final value displays in the [Value] column. Select an option ([Last], [Avg.], [Max.] or [Min.]) from [Method] to determine the method in which the final value is calculated.
- For result values used to calculate GA (Gestational Age) and SD (Standard Deviation), the formula used in this calculation can be selected from [Formula]. The GA and SD values update with the formula change.

NOTE: 1. Only measurement values are editable while calculation values are not.
2. After a measurement value is modified, the average value of the tool and the corresponding calculation value will be updated automatically.

Entering Ultrasound Remarks

In the [Comments] box, enter the corresponding information.

You can also save or load the comments.

- Save comment: enter information in the Comments box and then touch [Save Comment] on the touch screen to save current information in the report comment database.
- Load comment: touch [Load Comment] on the touch screen to open the dialogue box to check history saved comment information. You can select related information to add to current report comment or select the location of the comments.

Selecting Images

Images saved for the current exam can be added to the report.

1. Click [Add Picture] on the report page to bring up the following dialog box.

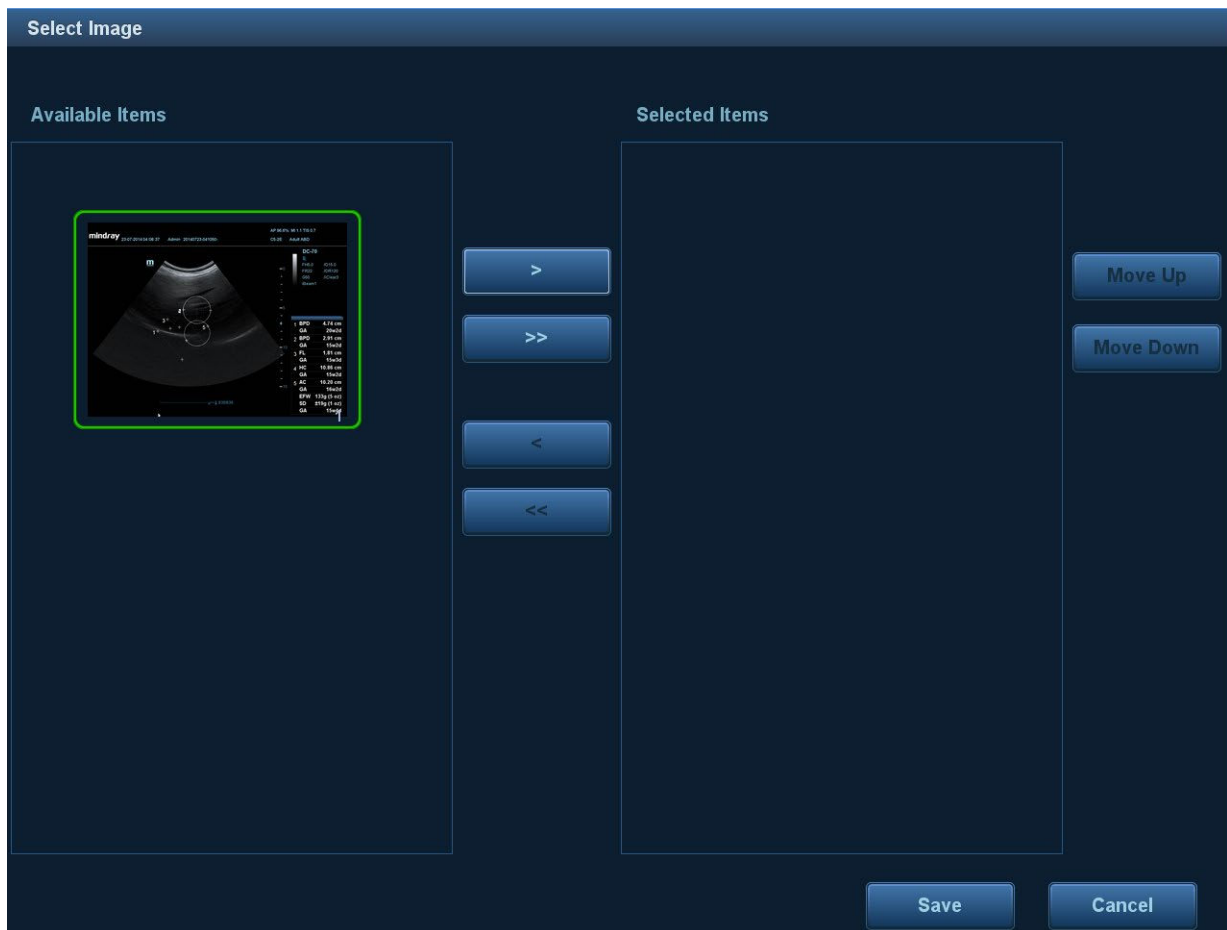

Left Column: Images saved for the current exam.

Right Column: Images selected to add to the report.

2. Select the image.

a) Add/Remove the image by pressing:

- [>] to add the selected image in the left column to the right column.
- [>>] to add all the images in the left column to the right column.
- [<] to remove the selected image from the right column.
- [<<] to remove all images from the right column.

b) Adjust the image arrangement.

Select an image in the right column and click [Move Up] or [Move Down] to adjust the sequence in which the images are arranged in the report.

3. Click [Save] to confirm.

Add Anatomical Picture

You may add anatomical graphics for illustration. OB, EM OB, IVF, Stress Echo and LV analysis reports do not support this function.

Touch [V-mapping] on the touch screen. The dialog box appears.

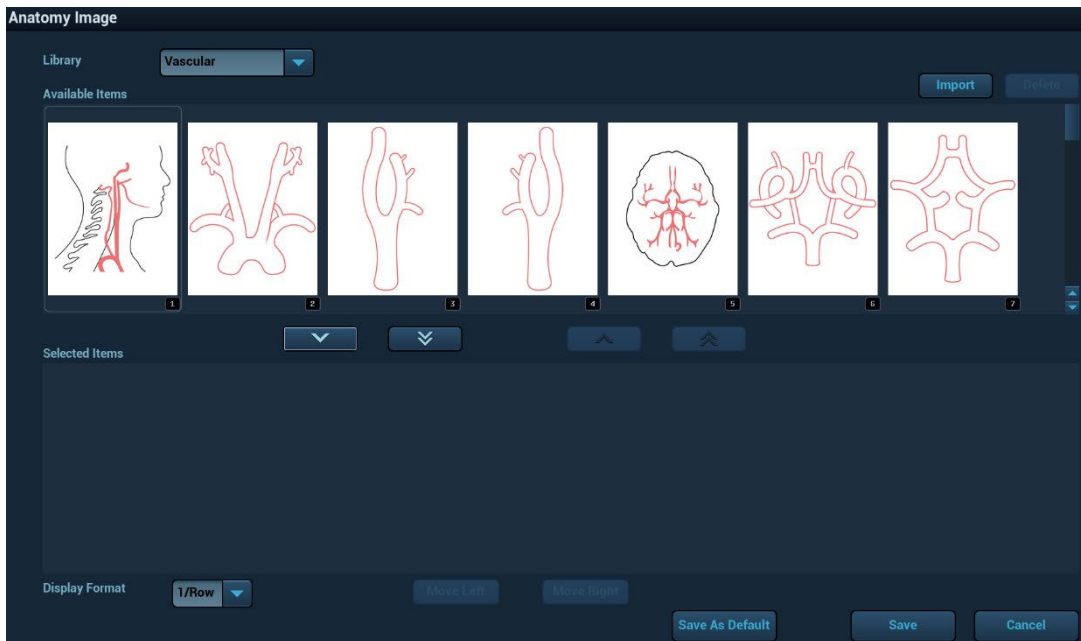





Available items: the graphic saved in the current exam can be added to the report.

Selected items: the selected graphic will be added to the report.

Select the graphic

Adding/ Removing the image with:

-  Adding the selected graphic.
-  Adding all optional graphics to the selected items.
-  Removing the selected single graphic.
-  Removing all added graphics.

Adjusting the graphic's sequence.

Select a graphic from the selected items. Click [Move Left] or [Move Right] to adjust the graphic sequence in the list.

The sequence of the graphic in the bottom column is that of the graphics in the report.

You may customize the anatomical graphic and import it to the report. Display effect of 480*640 works best.

Tap Right/Left or Prox/Mid/Dist/None. Select the measurement to be added to the anatomical curve (see the figure below).

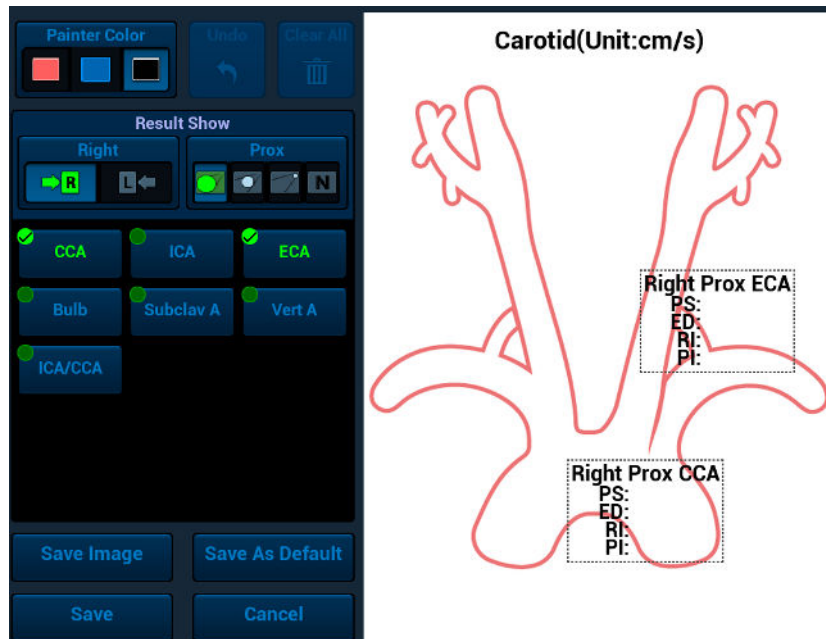

When measuring the results of the anatomical curve, the measurements appear on the curve.

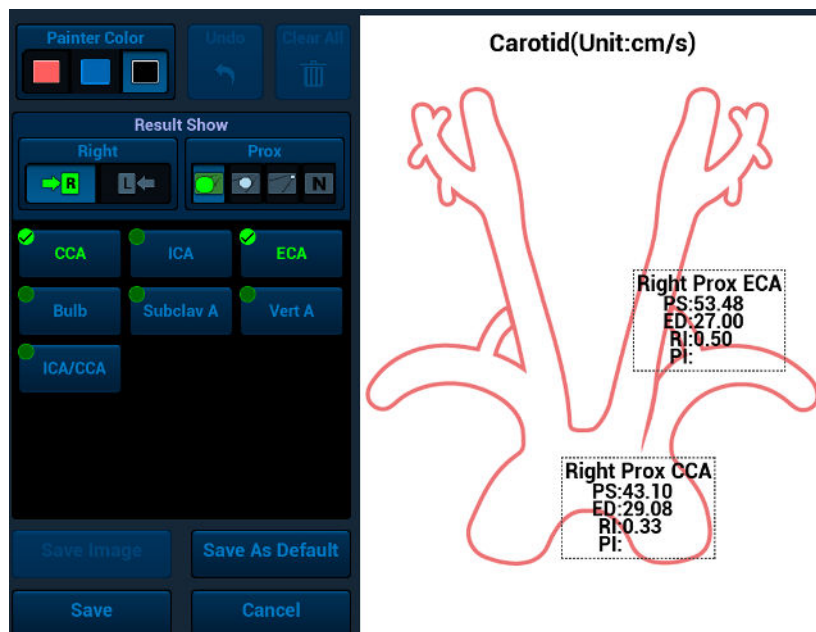

Select the painter color, and draw on the right anatomical area manually.
Click [Save] to add anatomical picture.

Save/Load Report

After the report template is edited, the history report archived in the system will change at the same time. The user may print or export the current report to make a copy in advance.

■ Save report

1. Under report status, touch [Save Report] to bring up the following dialog box.

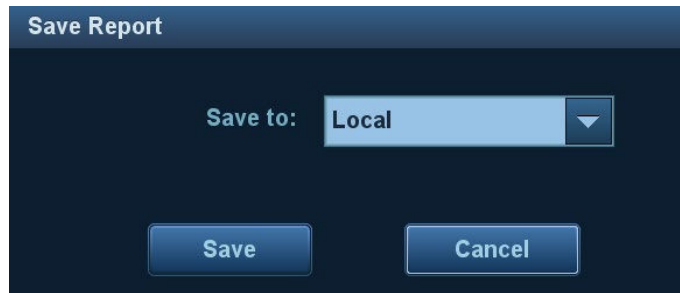

2. Select "Local" and click [Save] to save the information of the current report. You can click [Load Report] to export or print the report.

Note: The function is disabled for anonymous patient.

■ Export report

1. Under report status, touch [Save Report] to bring up the above dialog box.
2. Select "Other Medium" and click [Save] to see the following dialogue box, you can export the report directly.

Reports can be exported as RTF or PDF documents, which can be viewed and edited on a PC.

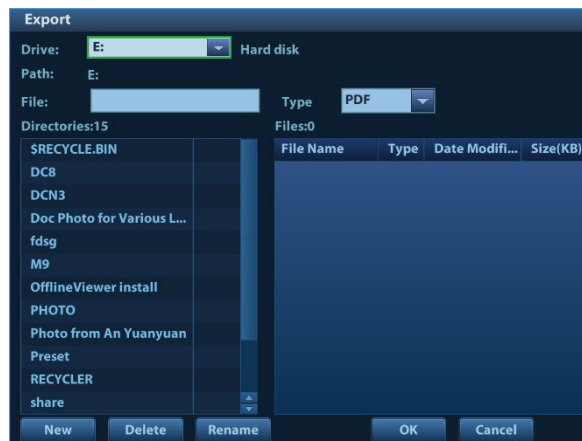

3. Select the drive and directory.
4. Enter the filename for the report to export and select the file type.
5. Select the file type.
6. Click [OK] to confirm.

Create, delete or rename the directory by pressing:

[New]: To create a new template.

[Delete]: To delete the selected directory. Make multiple selections using the <Shift> and <Set> keys.

[Rename]: To rename a selected directory.

Analyzing Report Data

You can preset and edit anatomy information in the report.

1. Click [Analyze].
2. Select or enter anatomy descriptions.

Tip: Descriptions of [Fetus Score] can only be selected from the drop-down list.

Use the [Previous]/[Next] buttons to switch between pages.

3. Click [Save] to confirm. Analysis information displays after the measurement values in the report.
- See “1.7.6 Report Setting” chapter for details about analysis result print setting.

Signature

Fill in the signature after completing the report.

1. Tap [Signature]. Draw the signature information on the touch screen. Tap [OK] to save the information.
2. Click [Save].
3. Print or preview the report to view the signature information.

1.7.3 Viewing History Reports

If more than one exam is performed for a patient, an [Exam] drop-down list appears in the top-left part on the report.

1. Select previous exams from the [Exam] drop-down list.
2. According to the exam mode, select a proper template from the [Report Type].
Make sure the template matches the exam mode, otherwise the measurement result will not display correctly. E.g. an abdomen measurement result will not display in an OB report template preset without any abdomen measurement items.
3. View the history report.

NOTE: 1. History reports can be viewed, but cannot be edited.
2. The patient's information can also be viewed in iStation, see “Patient Data Management” in the Operator's Manual [Basic Volume] for details.

1.7.4 Printing Reports

Touch [Print] on the touch screen to print the report.

Or touch [Preview] to preview. On the preview page, you can:

- | | |
|--------------------------|---|
| Print report: | Click [Print]. |
| Page up/down: | Select [Prev. Page] or [Next] to view the previous or next page. |
| Zoom in/out: | Select a zoom ratio from the drop-down list: whole page, 100%, page wide. |
| Exit the preview: | Click [Close]. |

1.7.5 Fetal Growth Curve

If [Obstetric] in the [Patient Info] is selected in the report template (see “5.7.4 Fetal Growth Curve”), you can view the fetal growth curve by touching [OB Graph] on the touch screen. See “5.7.4 Fetal Growth Curve” for details.

1.7.6 Report Settings

Click [Setting] in the bottom-left part of the Report screen to generally change the report display.

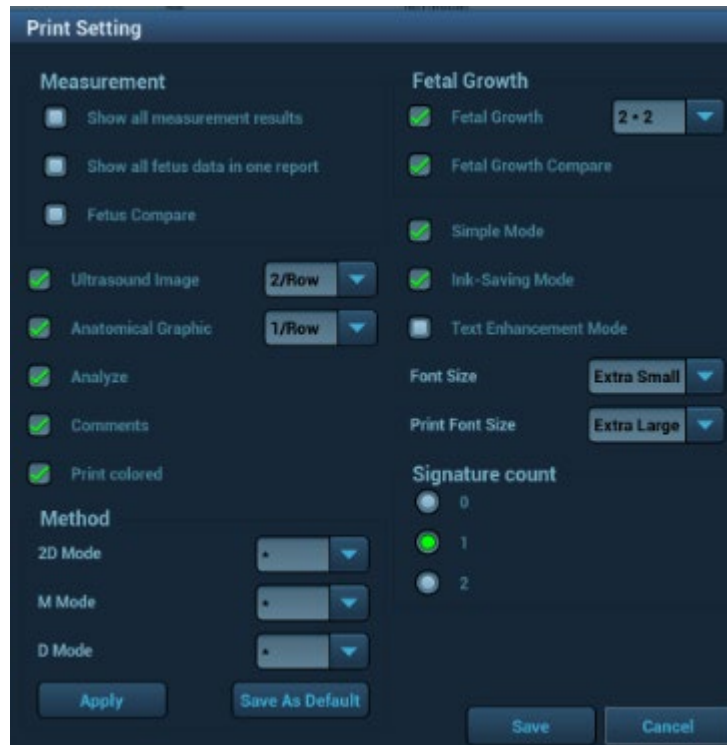

Type	Description	
Print information and layout	Choose the item (s) to be displayed on the report: ultrasound image, anatomical graphic, analysis and comments. Set the layout for ultrasound image and anatomical graphic for printing.	
	Ultrasound Image	Select the ultrasound image to be printed. Then, set the image layout for printing. If clicking "Ink-Saving Mode", the ultrasound image is printed in white background.
	Anatomical Graphic	Select the anatomical graphic to be printed. Then, set the graphic layout for printing.
	Analyze	Select to print the added analysis.
	Comments	Select to print the comment column.
	Print colored	After clicking it, WMS score mode of stress echo is displayed in color. If not clicking it, WMS score mode is displayed in numeric.
Measurement	Show all measurement results	Display all measurement results of each item for printing.
	Show all fetus data in one report	After clicking it, the report chooses and prints the multi-fetus data simultaneously.
	Fetus compare	Select the fetus comparison to be printed.
Fetal Growth	Fetal growth	Select to print fetal growth result. Then set the layout in the report.
	Fetal growth compare	Select the result of fetal growth comparison to be printed.

Type	Description	
Method	2D/M/D Mode	Select the method in which the final value is calculated for 2D/M/D mode. The sign “**” means methods for the same mode are not the same.
Others	Signature Count	Select the signature number: 0, 1, 2.
	Ink-Saving Mode	If it is selected, the printing background color is white. If it is deselected, the printing background color is black.
	Simple Mode	If it is selected, the report will be displayed in a compact layout.
	Text Enhancement Mode	If it is selected, characters on probe parameter area, patient information area and image parameter area will be printed in bold.
	Font Size	Set the font size for report viewing screen.
	Print Font Size	Set the font size for report preview screen and for printed report.

2 Measurement Preset

Before measuring, preset the following parameters:

- Measurement Parameters Preset
- Obstetric Preset
- General Measurement Preset
- Application Measurement Preset
- Report Preset

2.1 Basic Preset Procedures

The basic measurement preset procedures are as follows:

1. Press <F10 Setup> to enter the Preset:
2. Preset the measurement parameters.
Enter [Setup] → [System Preset] → [Application] to preset the measurement ruler, etc. See “2.2 Measurement Parameters Preset” for details.
3. Preset the Obstetric formula.
Enter [Setup] → [System Preset] → [OB].
Preset the GA (Fetal Gestational Age), FG (Fetal Growth) and the Fetal Weight. See “2.3 Obstetric Preset” for details.
4. Measurement preset.
Enter [Setup] → [Measure] → [Caliper], [Measure] and [Report] to preset the measurement menu and items. See “2.4 Measurement Preset” for details.
5. Exit the setup for the settings to take effect.
Select [Save] in the [Setup] menu to exit the setup.

NOTE: The settings are only brought into effect by clicking [Save] to exit the [Setup] menu.

2.2 Measurement Parameters Preset

Basic operation steps are as follows:

1. Press <F10 Setup> to display the [Setup] menu.
2. Select [Setup] → [System Preset] → [Application] to preset the following parameters:
 - Measurement Ruler
 - Left ventricular study
 - PW Measure
 - Follicle
 - Text
 - ICA/CCA && RAR
3. Click [Save] to confirm.

Measurement Parameter

Measure Parameter

Cursor Type: Number

Cursor Size: Large

Heart Beat: 2

Ellipse's style: Full line

Trace line style: Full line

Cursor Line Display

Ellipse CrossLine Display

Clear results while deleting caliper

Unit Setting

You can preset:

Tools	Descriptions
Cursor Type	Type of cursor displayed on the measurement caliper and results window. Value options: <ul style="list-style-type: none"> ■ Number: the cursor always displays as “+” while different measurements are marked with numbers. ■ Symbols: the cursor displays sequentially in 8 symbols to identify different measurements.
Cursor Size	The size of the cursor. Value options: Large, Medium, Small.
Heartbeat	The number of cardiac cycles in the heart rate calculation. (In heart rate measurement, the number of cardiac cycles should match the preset number.)
Ellipse’s style	To set the style of ellipse calipers.
Trace line style	To set the style of trace line calipers.
Cursor Line Display	If deselected, the connecting line between the measuring ends will be hidden after measurement.
Ellipse CrossLine Display	If deselected, the measuring axis within the ellipse area will be hidden after measurement.
Results are cleared if removing the caliper	Uncheck. The image is unfrozen or the image mode is changed after the measurement is completed. The measurement results are saved if the caliper is cleared.
Unit Setting	Set the units of measurement items for the application selected from the drop-down list “App Region”. Click [Apply] to complete the settings.

Left Ventricle Function Study Tool Setting

Set the tools used in the Cube/Teichholz/Gibson study.

Follicle

Set the method for calculating the follicle. Value options:

Follicle 3 distances/2 distances/1 distance

PW Measure

PW measure velocity displays absolute value.

All measurement results in PW mode are absolute values based on the unit of velocity after checking this item.

ICA/CCA && RAR

Set the measurement properties of ICA, CCA, Renal A and Aorta.

Cardiac Value Range Display

Set whether to display value range of EMINCA Study for cardiac measurement results.

2.3 Obstetric Preset

Basic procedures:

1. Press <F10 Setup> to display the [Setup] menu.
2. Select [System] → [OB].
You can preset the Fetal Gestational Age (GA), Fetal Growth (FG) and Fetal Weight (EFW) formulae.
You can also create a new OB item and use an imported user-defined OB formulae.
See “2.3.2 Obstetric Preset Operations” for details.
3. After setting, click [Save] to exit the page.

2.3.1 Obstetric Formula

The obstetric formulae are used in the GA, EFW calculations and Fetal Growth Curve.

GA and FG Formulae

GA will be automatically calculated after the corresponding measurements are completed. The system will recalculate the GA after new measurements are completed.

- | | |
|-------------|---|
| Tip: | <ol style="list-style-type: none">1. To preset the default formula, See “2.3.2.1 Basic Procedures” chapter.2. For more information about the GA and Fetal Growth Curve, see “5 Obstetrics.”3. You can add user-defined formulae for items (obstetric tools) that are not included in the GA and FG table below. See “2.3.2.2 User-defined OB .” |
|-------------|---|

The GA and FG formulae are shown in the table below:

Note: “/” means no formula provided for the item.

Tools	GA	FG
EFW/EFW2	Tokyo Hadlock	Hadlock Hansmann Tokyo Brenner William CFEF_2014 Persson
GS	Tokyo Rempen Hansmann China	Rempen Tokyo Hansmann Hellman
CRL	Hadlock Tokyo Jeanty Nelson Robinson Rempen Hansmann China ASUM Daya RobinsonBMUS Daya Verburg	Hadlock Tokyo Robinson Rempen Hansmann ASUM Medvedev
BPD	Hadlock Tokyo Jeanty Kurtz Hansmann Merz Rempen ChittyOI Osaka China Nicolaides ASUM CFEF Verburg	Hadlock Tokyo Jeanty Kurtz Sabbagha Hansmann Merz Rempen ChittyOI Osaka Nicolaides ASUM CFEF_2000/2006 INTERGROWTH-21 st Medvedev Verburg

Tools	GA	FG
HC	Hadlock Jeanty Hansmann Nicolaidis ASUM CFEF Chitty	Hadlock Merz Jeanty Hansmann Nicolaidis ASUM CFEF_2000/2006 Chitty INTERGROWTH-21 st Medvedev Verburg
AC	Hadlock Jeanty Merz Chitty Nicolaidis ASUM CFEF Hansmann	Hadlock Jeanty Merz Chitty Nicolaidis ASUM CFEF_2000/2006 Hansmann INTERGROWTH-21 st Medvedev Verburg
FL	Hadlock Tokyo Jeanty Hohler Merz Hansmann Warda Chitty Osaka China Nicolaidis ASUM CFEF	Hadlock Tokyo Jeanty Merz Hansmann O'Brien Warda Chitty Osaka Nicolaidis ASUM CFEF_2000/2006 INTERGROWTH-21 st Medvedev Verburg

Tools	GA	FG
OFD	Hansmann Nicolaides ASUM Jeanty	Hansmann Merz Nicolaides ASUM INTERGROWTH-21 st Jeanty Medvedev
APAD	/	Merz
TAD	CFEF	Merz CFEF
FTA	OSAKA	OSAKA
THD	Hansmann	Hansmann
HUM	Jeanty ASUM	Jeanty Merz ASUM Medvedev
Ulna	Jeanty	Merz Jeanty Medvedev
Tibia	Jeanty	Merz Jeanty Medvedev
RAD	Jeanty	Merz Jeanty
FIB	Jeanty	Merz Jeanty
CLAV	Yarkoni	Yarkoni
TCD	Hill Nicolaides	Hill Goldstein Nicolaides Verburg
OOD	Jeanty	Jeanty
Cist Magna	/	Nicolaides
Mean Sac Diam	Daya Hellman	/
MCA PI	/	JSUM
MCA RI	/	JSUM
Umb A PI	/	JSUM
Umb A RI	/	JSUM

Tools	GA	FG
AFI	/	Moore
FL/HC (Hadlock)	/	Hadlock
HC/AC (Campbell)	/	Cambell
AC(c)	Hadlock	Chitty Hadlock
Ut A PI	/	Merz
Ut A RI	/	Merz
Duct Veno PIV	/	Baschat
Duct Veno PVIV	/	Baschat
Duct Veno PLI	/	Baschat
Duct Veno S/a	/	Baschat
Foot	Mercer	Mercer
NBL	/	Bunduki Sonek

Fetal Weight Formulae

EFW is a calculation item. If all tools required for the EFW formula have been performed, EFW will be obtained automatically. The system will recalculate the EFW after new measurements are completed.

Tip:	Formulae of EFW and EFW2 of GA/FG are different from those on the [Fetal Calc] page ([Setup]->[System Preset]->[OB] page).
	<ul style="list-style-type: none"> ■ EFW formulae of GA/FG are used to perform the GA calculation or the Fetal Growth Curve based on EFW. ■ EFW formulae on the [Fetal Growth] page are used in the EFW calculation based on certain OB measurement results (e.g., AC).

The Fetal Weight formulae are shown in the following table:

Formulae	Descriptions	Units	
		EFW	Item
Hadlock (AC, FL)	$EFW = 10^{(1.304 + (0.05281 \cdot AC) + (0.1938 \cdot FL) - (0.004 \cdot AC \cdot FL))}$	g	cm
	SD = 0.154*EFW SD Type = ±2SD	g	g
Hadlock (AC, FL, BPD)	$EFW = 10^{(1.335 - (0.0034 \cdot AC \cdot FL) + (0.0316 \cdot BPD) + (0.0457 \cdot AC) + (0.1623 \cdot FL))}$	g	cm
	SD = 0.146*EFW SD Type = ±2SD	g	g
Hadlock (AC, FL, HC)	$EFW = 10^{(1.326 - (0.00326 \cdot AC \cdot FL) + (0.0107 \cdot HC) + (0.0438 \cdot AC) + (0.158 \cdot FL))}$	g	cm
	SD = 0.148*EFW SD Type = ±2SD	g	g

Formulae	Descriptions	Units	
		EFW	Item
Hadlock (AC, FL, HC, BPD)	EFW = $10^{(1.3596 - (0.00386 \cdot AC \cdot FL) + (0.0064 \cdot HC) + (0.00061 \cdot BPD \cdot AC) + (0.0424 \cdot AC) + (0.174 \cdot FL))}$	g	cm
	SD = $0.146 \cdot EFW$ SD Type = $\pm 2SD$	g	g
Hadlock (AC, BPD)	EFW = $10^{(1.1134 + 0.05845 \cdot AC - 0.000604 \cdot (AC^2) - 0.007365 \cdot (BPD^2) + 0.000595 \cdot (BPD \cdot AC) + 0.1694 \cdot BPD)}$	g	cm
Shepard (AC, BPD)	EFW (Kg) = $10^{(-1.7492 + (0.166 \cdot BPD) + (0.046 \cdot AC) - (2.646 \cdot AC \cdot BPD / 1000))}$	kg	cm
	SD = $0.202 \cdot EFW$ SD Type = $\pm 2SD$	g	g
Merz1 (AC, BPD)	EFW = $-3200.40479 + (157.07186 \cdot AC) + (15.90391 \cdot (BPD^2))$	g	cm
Merz2 (AC)	EFW = $0.1 \cdot (AC^3)$	g	cm
Hansmann (BPD, THD)	EFW = $(-1.05775 \cdot BPD) + (0.0930707 \cdot (BPD^2)) + (0.649145 \cdot THD) - (0.020562 \cdot (THD^2)) + 0.515263$	kg	cm
Tokyo (BPD, APTD, TTD, FL)	EFW = $(1.07 \cdot (BPD^3)) + (3.42 \cdot APTD \cdot TTD \cdot FL)$	g	cm
Osaka (FL, BPD, FTA)	EFW = $(1.25674 \cdot (BPD^3)) + (3.50665 \cdot FTA \cdot FL) + 6.3$	g	cm
Campbell (AC)	EFW (Kg) = $EXP(-4.564 + (0.282 \cdot AC) - (0.00331 \cdot (AC^2)))$	kg	cm
Schild(HC, AC, FL)	EFW = $5381.193 + 150.324 \cdot HC + 2.069 \cdot FL^3 + 0.0232 \cdot AC^3 - 6235.478 \cdot \log(HC)$	g	cm
Person(BPD, FL, MAD)	EFW = $(BPD \cdot 10)^{0.972} \cdot (MAD \cdot 10)^{1.743} \cdot (FL \cdot 10)^{0.367} \cdot 10^{(-2.646)}$	g	cm

Weight Percentile for Age

The Clinical Percentile (CP) and Ultrasound Percentile (UP) is calculated and displayed in the report in the following format according to the formula selected for EFW calculation.

- CP (Calc Method) (Formula) xx.xx%: Where Calc Method may be LMP, PRV, IVF, BBT, DOC and EDD.
- UP (Calc Method) (Formula) xx.xx%: Where Calc Method may be AUA, CUA.

■ Clinical Percentile (CP)

Find the average value and calculate the threshold range in the formula (to calculate EFW) in the FG table according to the clinical GA (obtained in patient information such as LMP, IVF).

If the actual EFW value is in the following range, keep calculating. If not, the CP will not be displayed.

$$\text{average EFW} \times 1.25 > \text{EFW} > \text{average EFW} \times 0.75$$

E.g. EFW-GP(LMP) is the EFW Clinical Percentile calculated from the LMP obtained from the patient information.

■ Ultrasound Percentile (UP)

This has the same calculation method as CP except for using the ultrasound GA instead of clinical GA.

E.g. EFW-GP(AUA) and EFW-GP(CUA) is the EFW Clinical Percentile calculated from the AUA and CUA respectively.

2.3.2 Obstetric Preset Operations

2.3.2.1 Basic Procedures

Basic procedures in the OB preset are as follows:

1. Enter the [Setup] → [System Preset] → [OB] page.
2. Set the default formula.
 - (1) On the [Fetal Gestational Age], [Fetal Growth] or [Fetal Weight] page, select an OB Item in the left column.
 - (2) Select a formula in the right column.
 - (3) Click [Default]. The default formula is marked with a ✓.

On the [Fetal Gestational Age] page, select whether to display the SD or EDD in the obstetric result.

On the [Fetal Gestational Age] page, select whether to display the EFW derived GA in the report.

3. Set the fetal weight display.
 - a) Enter the [Fetal Calc] page.
 - b) Select the [Fetal Weight Unit].
Select Metric, English or English & Metric from the drop-down list.
 - c) Select the formula for calculating the weight percentile.
Select the formula from the drop-down list of [EFW-GP].

4. Click [Save] to confirm.

Import/Export an OB Table or Formula

1. Select [Import] or [Export] on the Fetal Gestational Age or Fetal Growth page.
2. The system brings up the [Load Data] dialog box.
3. Select the drive and file path where the data is located.
4. Select the data file to load or export.
5. Click [OK] to confirm.

Tip: Only imported user-defined tables can be exported.

The imported user-defined table for FG and GA must be a *.csv file. The format of the *.csv file is described as follows:

■ FG table

Table Type	Author Name	SD Type	Meas. Value Unit	SD Unit
FG	The author name	Value of standard deviation	Unit of the measurement value	Unit of the standard deviation
Row Num.	Row number (N) of the table			
No.	GA	Min.	Meas. Value	Max.
1	GA value	Minimum value	Measurement value	Maximum value

2
...
N

NOTE:

- Fill in the table according to the actual clinical values, except for those cells with bold text.
- Value of standard deviation:
Select from one of the following:
 - None
 - ±1SD
 - ±2SD
 - 3%~97%
 - 5%~95%
 - 10%~90%
- Unit of the measurement value: according to the table to import, select from mm, cm, g, kg, cm² or mm².
- Row number (N) of the table: the maximum row number N in the column "No."
- The third row is empty.
- GA value, Minimum value, Measurement value, Maximum value: enter the number of days without the unit.

■ GA table

Table Type	Author Name	SD Type	Meas. Value Unit	
GA	The author name	Value of standard deviation	Unit of the standard deviation	
Row Num.	Row number (N) of the table			
No.	Meas. Value	SD(-)	GA	SD(+)
1	Measurement value	Standard deviation (-)	GA value	Standard deviation (+)
2
...
N

NOTE:

- Fill in the table according to the actual clinical values, except for those cells with bold text.
- Value of standard deviation:
Select from one of the following:
 - None
 - ±1SD
 - ±2SD
 - 3%~97%
 - 5%~95%
 - 10%~90%
- Unit of the measurement value: according to the table to import, select from mm, cm, g, kg, cm² or mm².
- Row number (N) of the table: the maximum row number N in the column "No."

- The third row is empty.
- Measurement value, Standard deviation (-), GA value, Standard deviation (+): enter the number of days without the unit.

2.3.2.2 User-defined OB Items

NOTE: The calculation results of the user-defined OB formulae are used for reference rather than clinical diagnosis.

You can add user-defined formulae for items (obstetric tools) that are not included in the GA and FG table in chapter “2.3.1 Obstetric Formula”.

1. Select [More OB Items] in the GA or FG tab sheet.
2. Select an item and click [OK].
The new item appears in the left column and the system asks if to add a formula.
3. Click [OK] to select the *.csv file (formula file) for the item. For user-defined formula, see "Import/Export an OB Table or Formula" in chapter “2.3.2.1 Basic Procedures”.
Or add a formula for the new item by clicking [Import].

■ Result Window

EDD display: the EDD is displayed in the result window after checking.

■ GA Cycle For EDD

Normal Cycle: GA is calculated according to 40 weeks after checking ($EDD=LMP+287(40 \text{ weeks})$).

French Cycle: GA is calculated according to 41 weeks after checking ($EDD=LMP+287(41 \text{ weeks})$).

■ Display EFW to estimate GA in the report

Estimate GA according to EFW data after checking.

2.4 Measurement Preset

Basic Procedures:

1. Press <F10 Setup> to display the [Setup] menu.
2. Select [Measure] in the [Setup] menu.
3. Preset the general measurement and application measurement.
For details, see “2.4.1 General Measurement Preset” and “2.4.2 Application Measurement Preset.”
4. Click [Save] to confirm.

Note: In [Setup]→[Measure] screen, “exam mode XX” on the upper left side refers to the currently configured exam mode. The configured general/application menus are only related to the current exam mode.

2.4.1 General Measurement Preset

You can preset the General Measurement packages for 2D (B/Color/Power Mode), M Mode, or Doppler (PW/CW) Mode respectively.

1. Select the [Caliper] on the [Measure] page, as shown in the figure below.

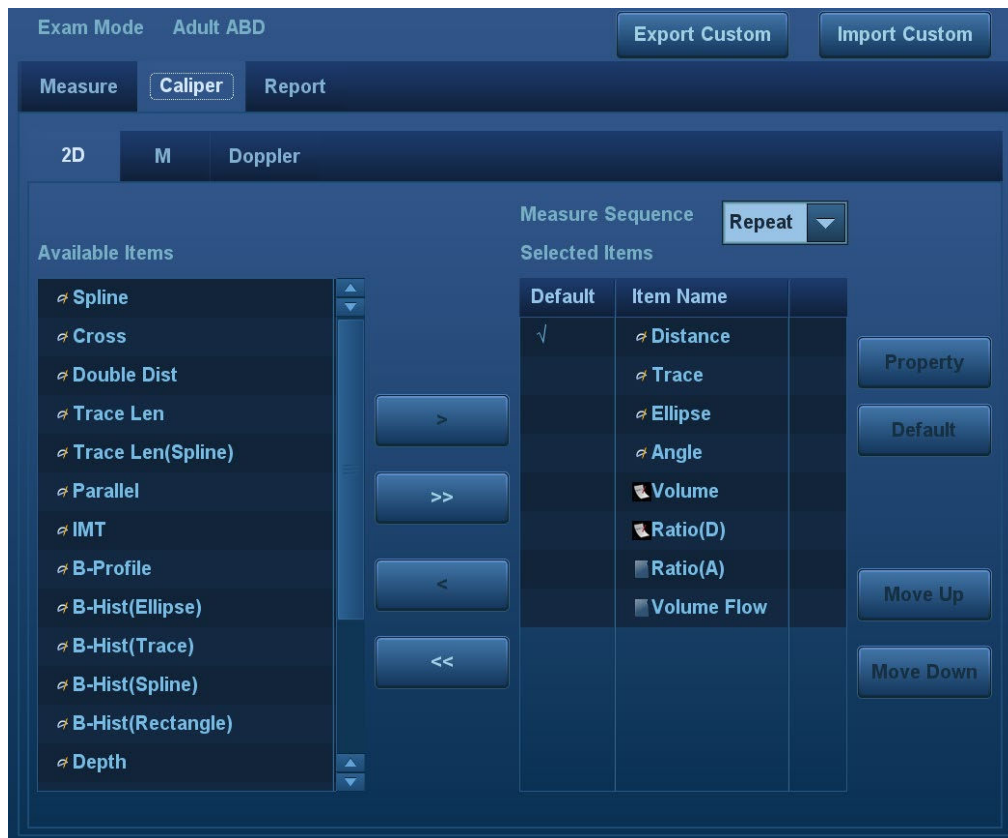

2. Select the [2D], [M] or [Doppler] tab to go to the corresponding preset menu.
 [Available Items]: general measurement tools configured by the system in the current scanning mode which are available but not assigned yet.
 [Selected Items]: displays the tools to be added to the menu.
3. Add/Remove the item.
 Add/Remove the general measurement item using the following buttons:
 - [>] To add the selected tool from the [Available Items] to the [Selected Items].
 - [>>] To add all tools in the [Available Items] to the [Selected Items].
 - [<] To remove the selected tool from the [Selected Items] to the [Available Items].
 - [<<] To remove all tools from the [Selected Items] to the [Available Items]. You do not need to select any items before removing.
4. Set the default item.
 Select an item from the [Selected Items], then click [Default]. The item is marked with a √.
 The default item is activated automatically when entering this general measurement menu.
5. Adjust the item position.
 Select an item from the right column and click [Up]/[Down] to adjust the sequence in which the items are arranged in the corresponding general measurement menu (touch screen display).
6. Modify the properties of a measurement item.
 The following takes D trace as an example to show how to set the properties of a measurement tool.
 - (1) Enter the [Measure] → [Caliper] → [Doppler] page.
 - (2) Select [D Trace] from the [Selected Items] and click [Property] to bring up the following dialog box.



Descriptions of the attributes are shown in the following table.

Attributes	Descriptions
Item Name & Result	<p>Results obtained from D trace are listed. The selected items will be displayed in the results window after measurement.</p> <ul style="list-style-type: none"> ■ If PV is selected, other results become deselected (except the temporary result “velocity”). ■ Some results, such as PS and ED, can be derived via a simple method (e.g., Velocity), but others, such as TAMAX, can only be derived via complicated methods such as Manual, Spline, Auto, etc. <ul style="list-style-type: none"> ● Only Vel. is available in [Method] if only PS or ED is selected. ● Methods for obtaining PS and TAMAX simultaneously (trace, spline and auto) should be chosen if both PS and TAMAX are selected (TAMEAN should use auto method).
Unit	<p>Select the measurement unit.</p> <p>Click “Unit” column of each item to select.</p>
Meas. Method	<p>Select the measurement method for the tool.</p> <p>Click “CalcMethod” column of each item to select.</p>

(3) Click [OK] to confirm the setting.

7. Select the measurement sequence.

- [Repeat]: after the current measurement is completed, the system automatically activates the current tool again.

- [Next]: after the current measurement is completed, the system automatically activates the next tool in the menu.
 - [None]: after the current measurement is completed, the cursor can be moved over the whole screen. And the cursor will automatically return to the menu of the corresponding measurement.
8. Click [Save] to confirm.

2.4.2 Application Measurement Preset

2.4.2.1 Basic Procedures

1. Select [Measure] in the [Measure] page, as shown in the figure below.



2. Select the 2D, M or Doppler scanning mode.
3. Choose or edit the Measurement Package.

The default package for current exam mode appears in the [Measurement Package].

 - Enter or edit the package name directly in the [Measurement Package] text box, then add items to edit the current package.
 - Or click [Advanced] to add or select a package.

For details about creating, deleting and setting the default package, see “2.4.2.2 Measurement Package Preset.”
4. Select an application region from the drop-down list under [Available Items].
5. Select [Measurement], [Calculate], [Study], [User Defined] or [All] from the drop-down list under [Available Items]. The corresponding items appear in the list.

For details about measurement, calculation and study, see “1.3 Measurement, Calculation and Study.”
6. Preset the measurement menu.

For details on adding, creating and setting default items, see “2.4.2.3 Measurement Menu Preset.”

For details on measurement tool property settings, see “2.4.1 General Measurement Preset.”

7. Select the measurement sequence.

- [Repeat]: after the current measurement is completed, the system automatically activates the current tool again.
- [Next]: after the current measurement is completed, the system automatically activates the next tool in the menu.
- [None]: after the current measurement is completed, the cursor can be moved over the whole screen. And the cursor will automatically return to the menu of the corresponding measurement.

8. Click [Save] to confirm.

2.4.2.2 Measurement Package Preset

During measurement, the preset package displays on the touch screen. Items in the package can be preset and may belong to different application regions.

You may configure more than one measurement package for current exam mode. Under actual measurement status, switch the measurement library if necessary (by rotating the knob under the [Library] button on the touch screen or clicking the menu title.)

Click [Advanced] to enter the following page.

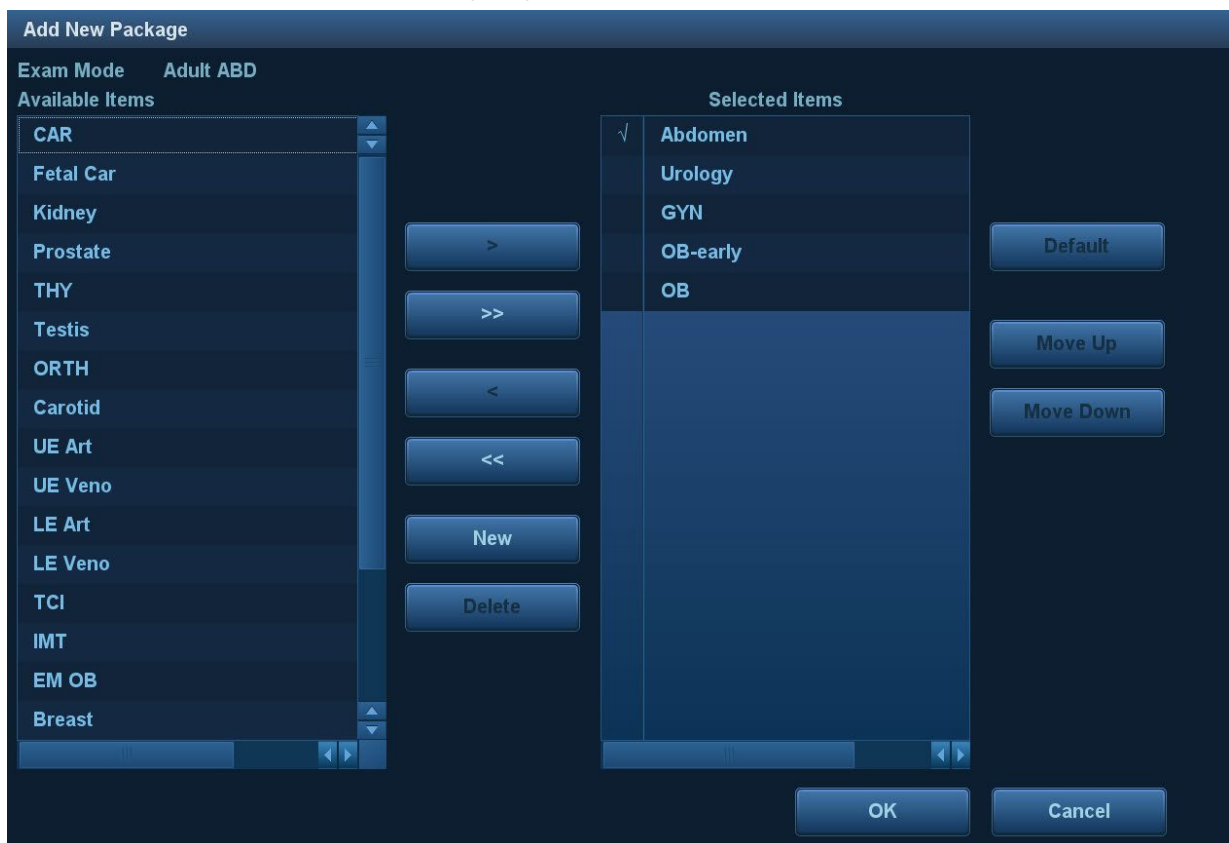

Here,

- [Available Items]: shows application packages configured in the system but not yet assigned to the current mode.
- [Selected Items]: shows application packages assigned to the current exam mode. If more than one package is assigned to the current exam mode, you can rotate the knob under the [Library] button on the touch screen or clicking menu title in the measuring status.

Package editing includes Creating Packages, Add/Remove Items, Deleting Measurement Packages, Setting Default Packages, Adjusting Package Positions.

Creating Packages

1. Click [New].
2. Enter a name for the new package in the dialog box pop-up.
3. Click [OK] to confirm.

The new package displays in the [Available Items] list.

Adding/Removing Packages

Add/remove the package by pressing:

- [>] To add the package selected from the [Available Items] to the [Selected Items].
- [>>] To add all packages in the [Available Items] to the [Selected Items].
- [<] To remove the package selected from the [Selected Items] to the [Available Items].
- [<<] To remove all packages in the [Selected Items] to the [Available Items].

Deleting Packages

1. Select a package from the [Available Items] list.
2. Click [Delete].

Tip: To delete an item from [Selected Items], you need to move it to the [Available Items] first.
--

Setting Default Packages

1. Select a package from the [Selected Items] list, then click [Default].
2. The default package is marked with a \surd .

Tip: <ol style="list-style-type: none">1. The default package displays when entering the [Measure] page.2. The measurement menu of the default package (corresponding to the exam mode) displays when entering the measuring status.
--

Adjusting Package Positions

Select a package from the [Selected Items] and click [Move Up]/[Move Down] to adjust the sequence that the packages in the menu are arranged in.

2.4.2.3 Measurement Menu Preset

The following operations are available.

- Adding/Removing Items
- Setting Default Items
- Adjusting Item Positions
- User-defined Measurement/ Calculation/ Study Items (see next section for details)

Adding/Removing Items

■ Adding Items

You can add measurements, calculations or study items in the [Available Items] to the [Selected Items] column, or to the study item in the [Selected Items] column (added items display as sub-items in the study). The selected items display in the menu and on the touch screen.

Add/Remove the general measurement item using the following buttons:

- [>] To add the selected tool from the [Available Items] to the [Selected Items].
- [>>] To add all tools in the [Available Items] to the [Selected Items].
- [<] To remove the selected tool from the [Selected Items] to the [Available Items].
- [<<] To remove all tools from the [Selected Items] to the [Available Items]. You do not need to select any items before removing.

■ Setting Default Items

You can set a measurement, calculation or study in the [Selected Items] as the default item. The default item will be activated automatically when entering the measurement menu containing it.

1. Select an item from the [Selected Items] list.
2. Click [Default]. The defaulted item is marked with a ✓.

To deselect the default tool, select it and click [Default] or set another item as the default.

Tip: If a particular item is set as the default item, it automatically displays the submenu of the study when entering this measurement menu.

Adjusting Item Positions

You can adjust the position of the measurement, calculation or study in the [Selected Items] list.

1. Select an item from the [Selected Items].
2. Click [Up]/[Down].

The order in the list is also the item position in the menu.

2.4.2.4 User-defined Measurement/Calculation/Study

NOTE: Please ensure the correctness and validity of the defined formula, otherwise Mindray will not be liable for damage caused by improper definition of the formula.

User-defined Measurement

1. Enter the [Measure] → [Measure] page.
2. Click [New].

The “Measurement Custom Wizard” dialog box appears, as shown in the following figure.

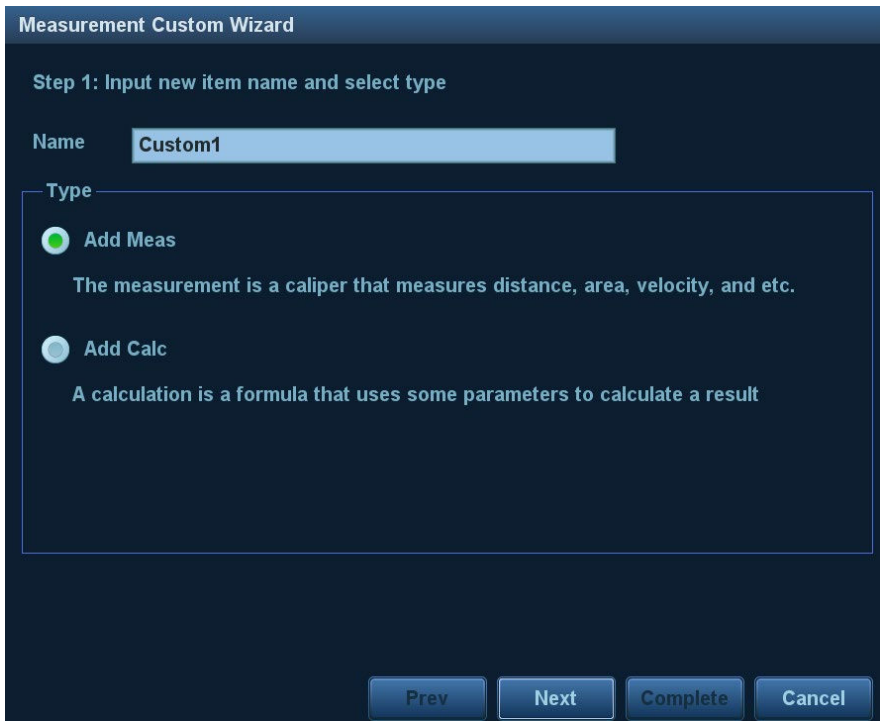

3. Enter the Name in the “Measurement Custom Wizard” dialog box, then click [Next].
4. Select the [Tool Type], [App Region] and the Measurement Result.

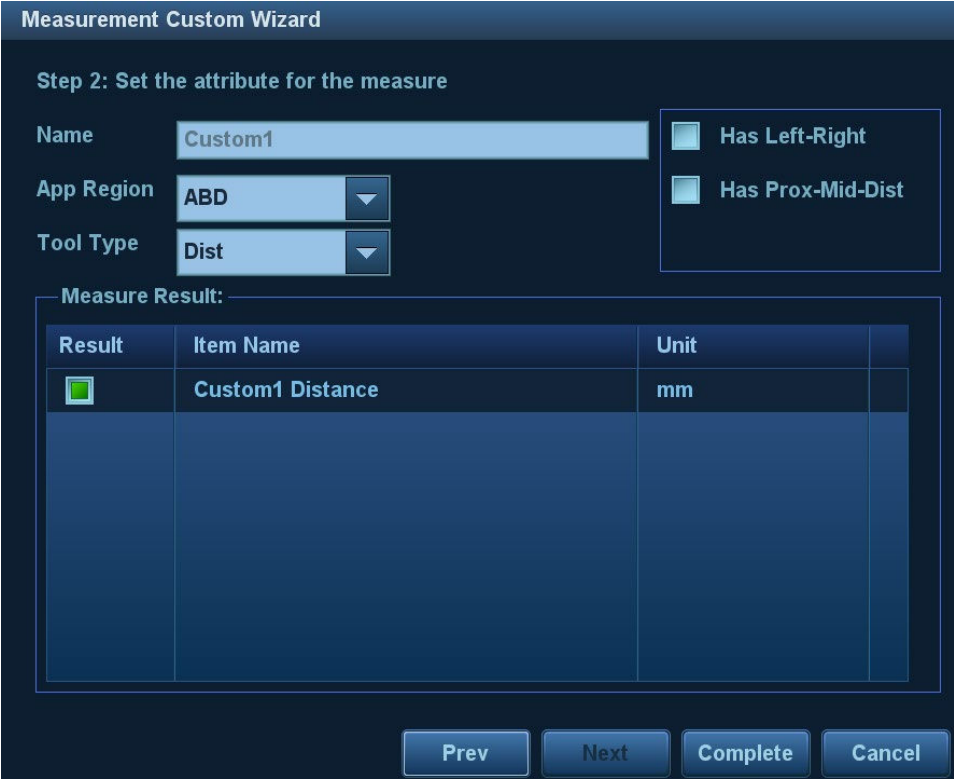

Descriptions of the attributes in the dialog box are shown in the following table.

Attributes	Descriptions						
Tool Type	General measurement tool type of the user-defined item. E.g. Select Dist. if you want to add a new item to measure the distance.						
Has Multi-Fetus	If selected, you can choose different fetuses in the measurement menu (available in the Obstetric application region only).						
Has Left-Right	If selected, you can choose left or right side in the measurement menu.						
Has Prox-Mid-Dist	If selected, you can choose proximal, middle or distal in the measurement menu.						
Measurement Result	<p>Choose the results to be displayed in the results window. The result name can be changed.</p> <p>Move the cursor over an item and press <Set>, then enter the name in the text box.</p> <table border="1"> <thead> <tr> <th>Result</th> <th>Item Name</th> <th>Unit</th> </tr> </thead> <tbody> <tr> <td><input type="checkbox"/></td> <td>Custom1 Distance</td> <td>mm</td> </tr> </tbody> </table>	Result	Item Name	Unit	<input type="checkbox"/>	Custom1 Distance	mm
Result	Item Name	Unit					
<input type="checkbox"/>	Custom1 Distance	mm					
Unit	<p>Select the measurement unit.</p> <p>Click "Unit" column of each item to select.</p>						

- Click [Complete] to finish setting. The user-defined measurement item is listed in the "Selected Items" menu and in the "User-defined" category of "Available Items." An asterisk appears after the user-defined item for identification.

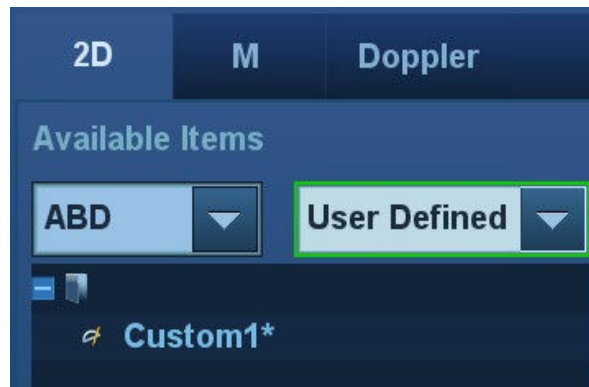

In the meantime, the user-defined measurement item will be added automatically to the "Selected Items" in the Report template. If the item is completed in an exam, the results will be displayed in the report. For detailed information about the Report template, see "2.4.3 Report Preset."

User-defined Calculations

User-defined calculations are derived from arithmetic operations in which the parameters are measurement, calculation or study results obtained in measurement items which exist in the system or are user-defined.

- Enter the [Measure] → [Measure] page.
- Click [New].
- Enter the Name in the "Measurement Custom Wizard" dialog box, choose [Add Calc.], then click [Next].
- Select the [App Region] and edit the formula.



Descriptions of the attributes in the dialog box are shown in the following table.

Attributes	Descriptions
Formula	Displays the user-defined formula.
Verify	Used to verify if the formula is valid.
Application Region	Select the application region for the user-defined item.
Measurement Item	All available measurement items of the application region selected in the previous step.
Calculator/Function	You can select from measurement/calculation/study items in 2D/M/Doppler mode.
Unit	Used to enter numbers and functions in the formula.

For example, to create a user-defined measurement item (HC/AC):

- a) Enter name for the item, such as “calculation 1.”
 - b) In Region select “Obstetric,” then select the measurement tool sources “2D” and “Measurement.”
 - c) Find HC in the “Item Name” list, click to select it, then double-click HC in the Result Name box on the right side. The index is added to the formula.
 - d) In the Calculator, click “/” and it is added to the formula.
 - e) Find AC in the “Item Name” list, click to select it, then double-click AC in Result Name box on the right side. The index is added to the formula.
5. Verify the formula, select the unit of the result, then click [Complete]. The user-defined calculation item is listed in the “User-defined” category of “Available Items.”

In the meantime, the user-defined calculation item will be added automatically to the “Selected Items” in the Report template. If the item is completed in an exam, the results will be displayed in the report. For detailed information about the Report template, see “2.4.3 Report Preset.”

- NOTE:**
1. Trigonometric functions are in degrees, not radians.
 2. PI is accurate to 15 digits.

User-defined Study Items

You can add or remove user-defined study items in the [Selected Items] column.

Enter the [Measure] → [Measure] page.

Click [Add Study] on the right.

Enter the study name in the dialog box that appears.

Click [OK] and the item will be added to the “Selected Items.”

Select a measurement/calculation item from the “Available Items” and click [>] to add the item to the user-defined study.

Repeat the last step to add more items if necessary.

Move the cursor to click on the study and click [Property] on the right to edit the sequence.

Edit User-defined Items

1. Select defined items in the “Available Items”.
2. Select the target item and click [Edit] on the right.

Remove User-defined Items

■ Remove Measurement/Calculation

1. Select “User-defined” in the “Available Items”, and select the desired item.
2. Click [Delete] on the right.

■ Remove Studies

Select a user-defined study, click [<].

NOTE: 1. Adding B-Hist or B-Profile to the study is not supported.
2. Click [Export Custom] in the measurement preset window to export the user-defined measurement.

2.4.3 Report Preset

NOTE: Deleting is not supported in IVF, IMT and EM reports.

Basic procedures:

1. Select [Report] on the [Measure] page.
2. Manage the report template. Available operations:
 - Adding new Report Templates
 - Deleting Report Templates
 - Editing Report Templates
 - Setting Default Report Templates
3. Continue setting other presets, or click [Save] in the [Setup] menu to bring the settings into effect.

2.4.3.1 Creating Report Templates

1. Enter the [Measure] → [Report] page.
2. Click [New] to bring up the following dialog box.
3. Select template: click the drop-down list under “Application Region” to select the template and click [OK] to confirm the template layout and exit the dialogue box.
4. Enter the name for the user-defined report template in the box after “Report Template Name”.
5. Click [Measurement] to select measurement results to be displayed in the report:

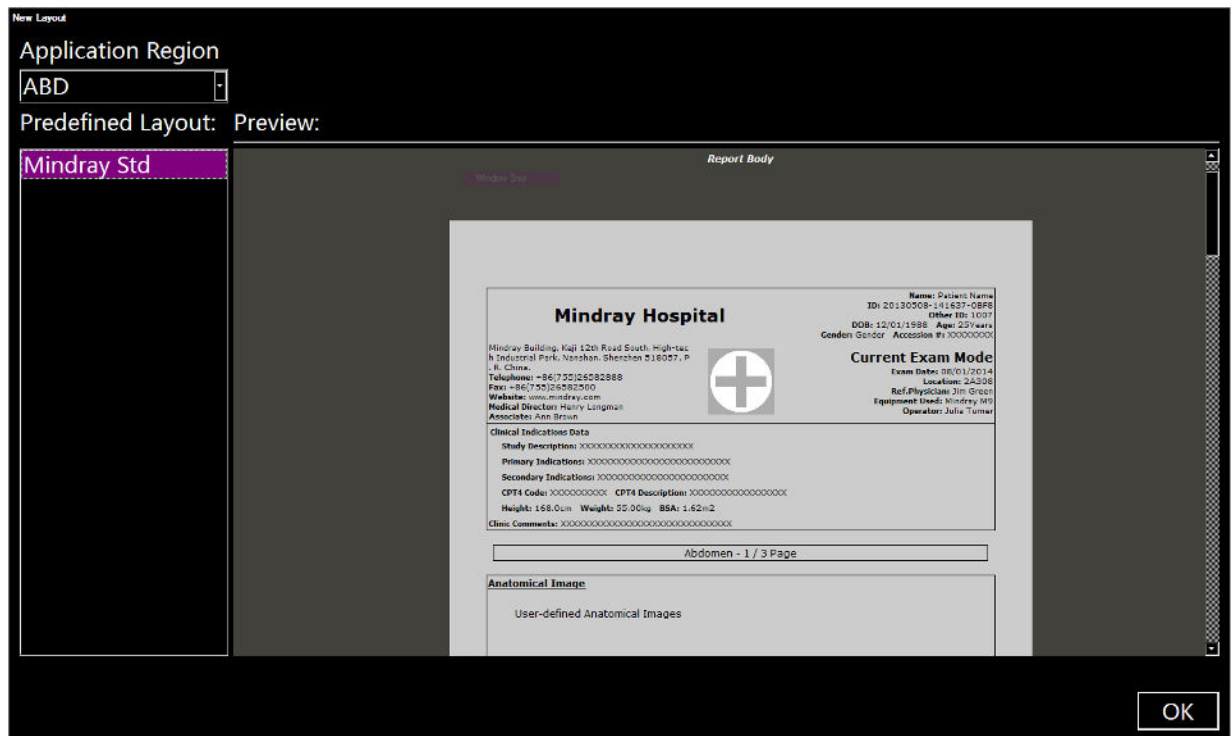

Select an application category from the drop-down list beside “Available Items”.

Select Measurement, Calculate, Study] or All from the drop-down list beside “Available Items”. The corresponding items appear in the list.

Use the [>] or [>>] buttons to add items to the “Selected Item” list.

Only tools which appear in the right column and are completed in the ultrasound exam can be displayed in the report.

Note: in cardiac mode, if result items of only one formula are selected in [Setup]→[Measurement]→[Property], only results of that one formula will be displayed after measurement. (For e.g., if only items suffixed with Teicholz are selected, not with Gibson or Cube, then only results suffixed with Teicholz after measurement are displayed.)

See chapter “2.4.1 General Measurement Preset” for details.

Add the study.

Click [Add Study] and enter the study name in the dialog box which appears, then click [OK].

The new added study appears in the “Selected Item” list.

Adjust the item position.

Select an item from the “Selected Item” list, click [Move Up]/[Move Down] to adjust the position of the item in the list, as well as in the report template.

Click [OK] to save the settings and exit the dialogue box.

6. Set the module display in the report: click [Setting] to make a selection;
 - Tick the small box in front of the module name to display the module in the report;
 - After selecting the module, click [Up] or [Down] to change the module sequence.
 - Click [OK] to save the setting and then exit.
7. Change the patient information layout in the report template:
 - Change the template used in the report layout: click [New Layout] to select another template.
 - Double click the information lines to be edited in “Report body”. The dialog box of font setting appears. Set the font size, font weight or hidden key words.

- Double click the blank of a module in “Report Body”. The dialog box of editing the content appears. Select the content to be displayed at current position.
 - Press left <Set> key on the blank of a module in “Report Body”. Choose to add or delete the line, or add the table, etc.
8. Click [Save] to save the setting.
 9. Click [Close] to quit the template.

Note: Watch the layout when setting the patient information layout of the report template. Do not set too many characters in one line; otherwise it may affect the display of the report.

2.4.3.2 Deleting Report Templates

1. Enter the [Measure] → [Report] page.
2. Select the template to be deleted from the list.
3. Click [Yes] to delete the selected template.
4. Click [Save] in the “Report” tab to confirm the settings.

2.4.3.3 Editing Report Templates

1. Enter the [Measure] → [Report] page.
2. Select the template to be modified from the list.
3. Select [Edit] to enter the [Measurement Report Preset] dialog box.
See section “2.4.3.1 Creating Report Templates” to edit the template.
4. Click [Save] in the “Report” tab to confirm the settings.

2.4.3.4 Setting Default Templates

1. Enter the [Measure] → [Report] page.
2. Select a report template from the list.
3. Click [Default].
4. Click [Save] to confirm.

2.5 Fast Measurement

Enter the [Setup] → [System Preset] → [Key Config.] page and assign functions in the “Measurement” list on the right side to the keys. For details, see the Operator’s Manual [Basic Volume].

3 General Measurement

General Measurement Tools:

- 2D (B/Color/Power/DirPower) Mode
- M General Measurements
- Doppler (PW/CW) Mode

3.1 Basic General Measurement Procedures

1. Start the exam.
2. Select the imaging mode (B/M/Doppler), then scan the image.
3. Press <Caliper> to enter the 2D/M/Doppler general measurement menu.
4. Select an item from the general measurement menu (or the touch screen) to start the measurement. See “1.2.2 Measurement Tool” chapter for details.

Or, enter the measurement tool by two-finger gesture . See “1.2 Measurement Menu” chapter for details.

- You can use the trackball and <Set> key to perform general measurement on the main screen (see 2D, M, Doppler general measurement for details);
- Or, use the measurement tool on the touch screen under mapping mode, see “1.2 Measurement Menu” chapter for details.

- | |
|---|
| <p>Tip:</p> <ol style="list-style-type: none">1. The order of the measurement items can be preset. See “2.4.1 General Measurement Preset” for details.2. A measurement tool can be activated by clicking the item either in the measurement menu or on the touch screen. It is described as “Select/Click ... in the measurement menu” in the following procedures.3. Under B+M or B+Doppler mode, touch mode tab on the touch screen to switch to the related measurement menu. |
|---|

3.2 2D General Measurements

3.2.1 Depth

Function:

- Sectoral surface probe: the depth is the distance from the center of the sector to the cursor.
- Convex array or linear array probe: the depth is the distance from the transducer surface to the measuring cursor in the direction of the ultrasonic wave.

Tip: The real-time depth displays in the results window only before the <Set> key is pressed to fix the starting point. The history value of the depth is not displayed in the results window.

1. Select [Depth] in the measurement menu or the touch screen. The cursor appears on the screen.
2. Use the trackball to move the cursor to the desired point.
3. Press <Set> to set the measurement point and the result displays in the results window.

3.2.2 Distance

Function: Measures the distance between two points on the image.

1. Select [Distance] in the measurement menu or the touch screen. The cursor appears on the screen.
2. Move the cursor to the starting point with the trackball.
3. Press <Set> to set the starting point.
4. Move the cursor to the end point with the trackball. Then press <Clear> to cancel setting the starting point. Or press <Update> to switch between the fixed end and the active end of the caliper.
5. Press <Set> to set the end point and the result displays in the results window.

3.2.3 Distance P-L

Function: measures the distance between two parallel line segments.

1. Select [Distance P-L] in the measurement menu or the touch screen. The cursor appears on the screen.
2. Move the cursor to the starting point with the trackball.
3. Press <Set> to set the starting point.
4. Move the cursor to the end point with the trackball. Then press <Clear> to cancel setting the starting point. Or press <Update> to switch between the fixed end and the active end of the caliper.
5. Press <Set> to set the end point and the result displays in the results window.

3.2.4 Angle

Function: measures the angle of two crossing planes on the image and the range is: 0°-180°.

1. Select [Angle] / [Angle 3P] in the measurement menu or the touch screen. The cursor appears on the screen.
2. Set two line segments as described in "3.2.2 Distance."
The angle appears in the results window after setting the line segments.

3.2.5 Area & Circumference

Function: measures the area and circumference of a closed region on the image. Four measurement methods are available:

- **Ellipse:** fix an ellipse region by two equal-cut perpendicular axes.
- **Trace:** fix a closed region by free tracing.
- **Spline:** fix a spline curve by a series of points (12 points at most).
- **Cross:** fix a closed region with two axes perpendicular to each other. The starting point and the end point of the axes can both be fixed freely.

Tip: These four methods are also applicable to other measurement items and will not be repeated when mentioned below. The operations are as follows:

Ellipse

1. Select [Ellipse] in the measurement menu or the touch screen. The cursor appears on the screen.
2. Move the cursor to an area of interest.
3. Press <Set> to set the starting point of the first axis of the ellipse.
4. Move the cursor to position the end point of the first axis of the ellipse. Then press <Update> to switch between the fixed end and the active end of the first axis. Or press <Clear> to cancel the start point of the first axis.
5. Press <Set> to set the end point of the first axis of the ellipse. The second axis appears on the screen.
6. Moving the trackball will increase or decrease the ellipse from the fixed axis. Move the trackball to trace the area of interest as closely as possible.
Or, press the <Update> or <Clear> key to return to the step before setting the first axis.
7. Press <Set> to anchor the ellipse region. The measurement result will be displayed in the results window.

Trace

1. Select [Trace] in the measurement menu or the touch screen. The cursor appears on the screen (and the touch screen).
2. Move the cursor to an area of interest.
3. Press <Set> to fix the starting point.
4. Move the cursor along the target to trace the outline of the target.
To modify the trace line, rotate the <Angle> knob:
 - Anticlockwise: to cancel a series of points.
 - Clockwise: to resume a series of points. You may also resume the points by rolling trackball back.
5. Press <Set> and the trace line will be closed with a straight line connecting the start and end points. The trace will also be closed when the cursor is very near to the starting point.

Spline

1. Select [Spline] in the measurement menu or the touch screen. The cursor appears on the screen.
2. Move the cursor to an area of interest.
3. Press <Set> to set the first reference point of the spline.
4. Move the cursor along the area of interest and press <Set> to anchor the second reference point.

5. Roll the trackball and a spline defined by three points of the first and second reference points and the active cursor appears on the screen.
6. Move the cursor along the edge of the target and set more reference points (12 at most) to make the spline approach the target region as closely as possible.
To correct a previous point, press <Clear>.
7. Press <Set> twice to anchor the last reference point. The spline is fixed and the results display in the results window.

Cross

1. Select [Cross] in the measurement menu or the touch screen. The cursor appears on the screen.
2. Move the cursor to an area of interest.
3. Press <Set> to fix the starting point of the first axis.
4. Use the trackball to position the end point of the first axis and then press <Set>. Then press <Update> to switch between the start point and the end point of the first axis. Or press <Clear> to cancel setting the starting point of the first axis.
5. Press <Set> to set the end point of the first axis. The second axis (perpendicular to the first axis) of the cross appears on the screen.
6. Move the trackball and press <Set> to fix the starting point of the second axis.
7. Move the cursor to the end point of the second axis. Then press <Update> to switch between the start point and the end point of the first axis. Or press <Clear> to cancel setting the starting point of the first axis.
8. Press <Set> to set the end point of the second axis and fix the region. The results appear in the result window.

3.2.6 Volume

Function: measures the volume of the target object.

Method:

■ 3 Dist.

For calculating the object's volume with 3 axes of two images scanned in the plane perpendicular to each other in B mode. The calculation formula is as follows:

$$Volume(cm^3) \square \frac{\pi}{6} \times D1(cm) \times D2(cm) \times D3(cm)$$

Where D1, D2 and D3 are the length of three axes of the target object.

■ Ellipse

To calculate the object's volume by its horizontal section area. The calculation formula is as follows:

$$Volume(cm^3) \square \frac{\pi}{6} \times a(cm) \times b^2(cm)$$

Where a is the length of the major axis of the ellipse while b the minor.

■ Ellipse Dist.

To calculate the object's volume by its horizontal and vertical section area. The calculation formula is as follows:

$$Volume(cm^3) \square \frac{\pi}{6} \times a(cm) \times b(cm) \times m(cm)$$

Here a, b and m indicate the length of the major, minor and the third axis of the ellipse respectively.

Operations:

Volume

1. Select [Volume] in the measurement menu or the touch screen. The cursor appears on the screen.
2. Here D1, D2 and D3 are the lengths of three axes of the target object.
See "3.2.2 Distance" for detailed procedures.
Generally D1, D2 and D3 should belong to different scanning planes.

Volume (Ellipse)

1. Select [Volume (Ellipse)] in the measurement menu or the touch screen. The cursor appears on the screen.
2. The procedure is similar to that of Ellipse in the area measurement, see "3.2.5 Area" for details.

Volume (Ellipse Dist.)

1. Select [Volume (E+ Dist.)] in the measurement menu or the touch screen. The cursor appears on the screen.
2. Use the Ellipse method to measure the vertical section area.
The procedure is similar to that of Ellipse in the Area measurement, see "3.2.5 Area" for details.
3. Unfreeze the image. Rescan the area of interest perpendicular to the previous image.
4. Measure the length of the third axis with the Distance measurement method, see "3.2.2 Distance" for detailed procedures.

3.2.7 Double Dist.

Function: measures the lengths of line segments A and B perpendicular to each other.

1. Select [Double Dist.] in the measurement menu or the touch screen. The cursor appears on the screen.
2. Move the cursor to the measurement starting point.
3. Press <Set> to set the starting point of the first line segment.
4. Use the trackball to position the end point of the first axis and then press <Set>. Then press <Update> to switch between the start point and the end point of the first axis. Or press <Clear> to cancel setting the starting point of the first axis.
5. Press <Set> to set the starting point of the first line segment. The second line segment perpendicular to the fixed line segment appears on the screen.
6. Move the cursor to the starting point of the second line segment.
7. Press <Set> to set the starting point of the second line segment. Or, press <Update> or <Clear> to return to the last step.
8. Move the cursor to the end point of the second line segment. Then press <Update> to switch between the starting point and the end point of the second axis. Or press <Clear> to cancel setting the starting point of the second axis.
9. Press <Set> to confirm the end point of the second line segment.

3.2.8 Parallel

Function: measures the distance between every two line segments of five parallel line segments, namely, four distances in total.

1. Select [Parallel] in the measurement menu or the touch screen. Two lines perpendicular to each other appear on the screen. The intersection is the starting point of the line segment.
2. Rotate the <Angle> knob to change the angle of the lines and press <Set> to confirm.
3. Move the cursor to the starting point of the line segment.
4. Press <Set> to confirm the starting point and the first line.
5. Move the cursor and press <Set> to confirm the other four parallel lines when the last parallel line is set and the end point of the line that is perpendicular to the five parallel lines is confirmed. During the measurement, press <Set> twice to set the last parallel line and complete the measurement.

3.2.9 Curve Length

Function: measures the length of a curve on the image. Measurement methods available include Trace and Spline.

Trace

1. Select [Trace Len] in the measurement menu or the touch screen. The cursor appears on the screen.
2. Move the cursor to an area of interest.
3. Press <Set> to fix the starting point.
4. Move the cursor along the target to trace the outline of the target.
To modify the trace line, rotate the <Angle> knob:
 Anticlockwise: to cancel a series of points.
 Clockwise: to resume a series of points. You may also resume the points by rolling trackball back.
5. Press <Set> to anchor the end point of the trace line.

Spline

1. Select [Trace Len (Spline)] in the measurement menu or the touch screen. The cursor appears on the screen.
2. Move the cursor to an area of interest.
3. Press <Set> to fix the starting point.
4. Move the trackball along the target and press <Set> to anchor the second, third, fourth, etc., points. A maximum of 12 points can be anchored.
 To correct a previous point, press <Clear>.
5. Press <Set> twice to set the end point of the spline.

3.2.10 Ratio (D)

Function: measures the lengths of two line segments and then calculates their ratio.

1. Select [Ratio (D)] in the measurement menu or the touch screen. The cursor appears on the screen.
2. Measure the length of the two line segments, see "3.2.2 Distance" for detailed procedures.
 The results display in the results window after the measurement of the second line is completed.

3.2.11 Ratio (A)

Function: measures the area of two closed regions and then calculates their ratio. The methods are Ellipse, Trace, Cross and Spline.

1. Select [Ratio (A)] in the measurement menu or the touch screen. The cursor appears on the screen.
2. Measure the area of the two closed regions; you may select different measurement methods for each region. See “3.2.5 Area” for details.

Under STE and STQ imaging mode, in B+E dual display mode, click [Sync] on the touch screen to On. Measurements on either of the two windows will be displayed in the other window.

3.2.12 B-Profile

Function: measures the gray distribution of ultrasonic echo signals on a line.

Tip: The following operations are performed on Freeze images by default.

1. Select [B-Profile] in the measurement menu or the touch screen. The cursor appears on the screen.
2. Set a line segment, see “3.2.2 Distance” for detailed procedures.

The result is shown in the figure below:



Where

- No:** The number of the graph. Value: 1 or 2.
The last two results will be displayed on the screen.
- Gmax:** The maximum gray.
- Gmin:** The minimum gray.
- Gmean:** The average gray.
- Gsd:** The variance of gray.

3.2.13 B-Hist

Function: measures and counts the gray distribution of ultrasonic echo signals within a closed region. The methods to set a closed region are Ellipse, Trace, Spline and Rect. (Rectangle).

Tip: The following operations are performed on Freeze images by default.

Rectangle

Rect. sets a rectangle with two points on the cross. The operations are:

1. Select [B-Hist (Rectangle)] in the measurement menu or the touch screen. The cursor appears on the screen.
2. Move the cursor to the first vertex of the rectangle, press <Set>.
3. Move the cursor to the second vertex of the rectangle, press <Set>. The result is shown in the following figure:



Where

Horizontal axis: The gray of the image

The vertical axis: The gray distribution percentage.

No: The number of the graph. The last two results will be displayed on the screen.

N: The total pixel number in the area to be measured.

M: $M = \sum D_i / N$;

MAX: MAX = the pixel number in the maximum gray/ $N \times 100\%$

SD: Standard deviation. $SD = (\sum D_i^2 / N - (\sum D_i / N)^2)^{1/2}$

D_i : the gray at each pixel point

$\sum D_i$: the total grays of all pixels.

Ellipse

See "Ellipse" in the "3.2.5 Area" for detailed procedures.

Trace

See "Trace" in the "3.2.5 Area" for detailed procedures.

Spline

See "Spline" in the "3.2.5 Area" for detailed procedures.

3.2.14 B-Ratio

- Tip:**
1. This measurement item is meant for a general estimation, not for accurate measurement.
 2. B-Ratio should be performed on frozen images.

Function: measures gray statistics ratio of normal tissue to abnormal tissue.

1. Select [B Ratio] in the measurement menu or the touch screen. A circle appears on the screen.
2. Move the circle to the position to be measured, and rotate the <Angle> knob to adjust the size of the circle.
3. Press <Set> to fix the first circle, and the second circle appears.
4. Move the second circle to the position to be measured, and rotate the <Angle> knob to adjust the size of the circle.
5. Press <Set> to fix the second circle. The result displays in the results window.

3.2.15 Color Vel.

- Tip:**
1. This measurement item is meant for a general estimation, not for accurate measurement.
 2. The following operations are performed on Freeze images by default.

Function: measures the velocity of blood flow on the Color Mode image.

1. Select [Color Vel.] in the measurement menu or the touch screen. The cursor appears on the screen.
2. Move the cursor to the point to be measured for blood flow velocity.
3. Press <Set> to fix the point, a floating line is displayed in the direction parallel to the ultrasonic wave beam at that point.
The compensation angle is currently 0°. You can change the angle (0°-80°) by rotating the <Angle> knob to align the floating line in the same direction as the blood flow at the point to be measured.
4. Press <Set> to set the direction of the blood flow. The result displays in the results window.

3.2.16 Volume Flow

Function: measures blood flow through a vascular cross section per unit time.

For details, see “3.4.7 Volume Flow.”

3.2.17 IMT

Tip: The IMT should be performed on frozen images.

IMT (Intima-Media Thickness) measures the distance between LI (Lumen-Intima) and MA (Media-Adventia). For details, see “7.4.3 Study Tool Operations IMT.”

3.2.18 Strain

Function: Support making measurement and calculation of the strain in a region.

Tip: only elastography imaging supports this function. For details see [Basic Volume].

1. Under Strain Elasto mode, acquire the image and freeze. Select [Strain] in the measurement menu or the touch screen.
2. Adjust the circle size by rotating <Angle> after select [Strain (Circle)]. Set the shell thickness and select whether to turn on the shadow function.
 - In B+E dual display mode, click [Sync] on the touch screen to On. Measurements on either of the two windows will be displayed in the other window.
 - Rotate the knob under [Shell Thick] on the touch screen to set the mass shell size. After the strain is measured, select the [Shell Thick] to be more than 0 mm. The system extends from lesion A automatically according to the shell thick value.
3. Perform measurements. You may select different measurement methods for each region. For details, see “3.2.11 Ratio (A).”

Check the result window of the strain measurement after the measurement is completed. Tap [E Export]. The data of the strain measurement is exported in batch.

3.2.19 Strain Ratio

Tip: The Strain Ratio should be performed on frozen images.
--

Function: measures the strain ratio in the image, strain ratio = strain (normal tissue)/strain (lesion).

Tip: only elastography imaging supports this function. For details see [Basic Volume].

In the image, the region selected from lesions is defined as A and the region selected from normal tissue is defined as B, where A' is the region extended from lesions and shell thick. refers to the thickness of the mass shell.

Tissue strain is related to forces on the probe and tissue depth. It is recommended to use regions of the same depth and same area for comparison.

1. Under Elasto mode, acquire the image and freeze. Select [Strain Ratio] in the measurement menu or the touch screen.

- Adjust the circle size by rotating <Angle> after select [Strain Ratio (Circle)].
2. Set the shell thickness and select whether to turn on the shadow function.
 - In B+E dual display mode, click [Sync] on the touch screen to On. Measurements on either of the two windows will be displayed in the other window.
 - Rotate the knob under [Shell Thick] on the touch screen to set the mass shell size.
 3. Perform measurements. You may select different measurement methods for each region. For details, see “3.2.11 Ratio (A).”
 4. After the strain ratio is measured, select the [Shell Thick] to be more than 0 mm. The system extends from lesion A automatically according to the shell thick value. The results window will display the results: B/A', B/Shell, A/Shell.

3.2.20 Strain.Hist

Tip: The Strain-Hist should be performed on frozen images.

Function: displays the strain ratio using the histogram, strain ratio = strain (normal tissue)/strain (lesion).

1. Under Elasto mode, acquire the image and freeze. Select [Strain-Hist (Ellipse)] or [Strain-Hist (Trace)] in the measurement menu or the touch screen.
2. Set the shell thickness and select whether to turn on the shadow function.
 - In B+E dual display mode, change [Sync] on the touch screen to On. Measurements on either of the two windows will be displayed in the other window.
 - Rotate the knob under [Shell Thick.] on the touch screen to set the mass shell size.
3. Perform measurements. You can select between ellipse or trace method. For details, see “3.2.13 B-Hist.”

After the Strain-Hist is measured, select the [Shell Thick.] to be more than 0 mm. The histogram will display data for A as well as A'.Elas.

3.2.21 Elastography

Function: it supports the elasto measurement and the elasto calculation of the area.

1. In STE mode:
 - a: capture the image
 - b: freeze the image;
 - c: enter the general measurement;
 - d: select [Elasto Ellipse], [Elasto Trace] or [Elasto Circle] from the measurement menu.

Adjust the circle size by rotating <Angle> after select [Elasto Circle].
2. Perform elasto measurements, you can select between ellipse or trace method, for details, please refer to “3.2.11 Ratio (A)”
3. Rotate [Shell Thickness] knob to set the size of the mass. The system expands inside or outside automatically in lesion A. The tissue of the lesion that is expanded appears in A'. The expansion thickness depends on the shell's.

Due to the tumor infiltration to the peripheral organs, adjust the shell thickness according to the tumor expansion scope.

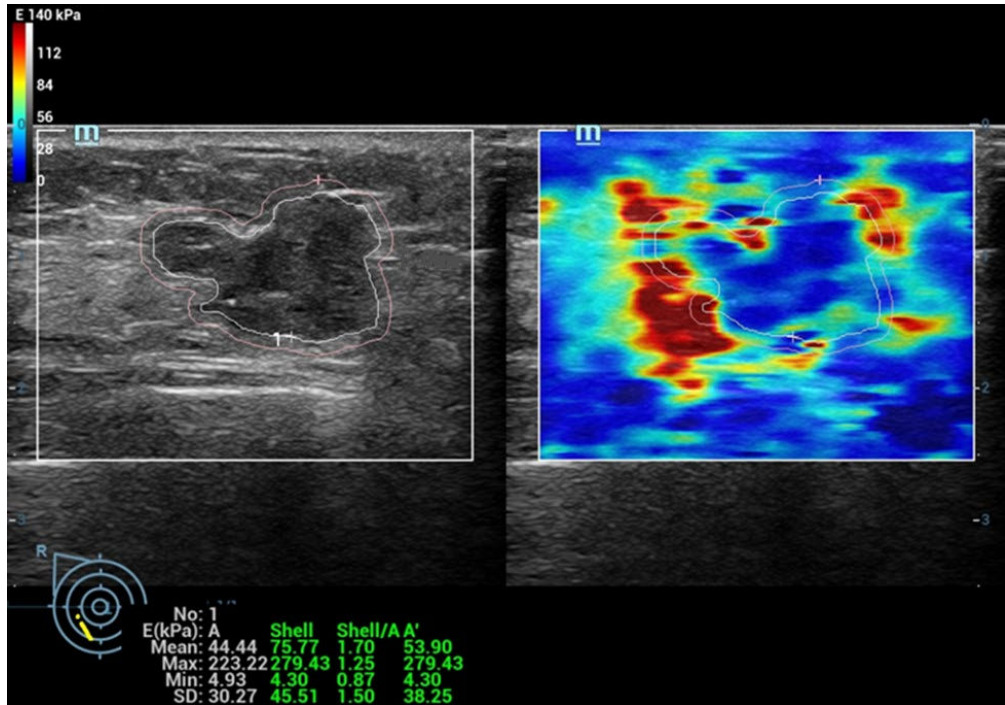

After the elasto measurement is completed ([Shell Thickness is enabled]), the results are displayed beneath the image.

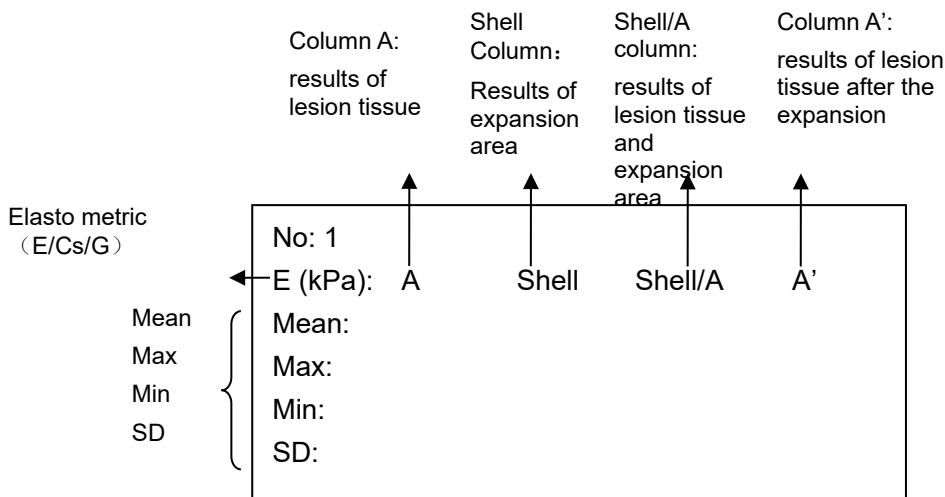

Check the result window of the elasto measurement after the measurement is completed. Tap [E Export]. The data of the strain measurement is exported in batch.

3.2.22 Elas. Ratio

Function: obtain the elasto ratio. $\text{Elas. ratio} = \frac{\text{elasto metric of the lesion tissue}}{\text{elasto metric of the normal tissue}}$

In the image, region selected from lesions is defined as A, and region selected from normal tissue is defined as B; while A' is the lesion region that is extended outside, and shell thickness refers to the size of the mass shell.

1. In STE mode:
 - a: capture the image;
 - b: freeze the image;
 - c: enter the general measurement;
 - d: select [Elas. Ratio Ellipse], [Elas. Ratio Circle] or [Elas. Ratio Trace] from the measurement menu.

Adjust the circle size by rotating <Angle> after select [Elas. Ratio Circle].

2. Perform elasto ratio measurements, you can select between ellipse or trace method, for details, please refer to “3.2.11 Ratio (A)”
3. Rotate [Shell Thickness] knob to set the size of the mass. The system expands inside or outside automatically in lesion A. The tissue of the lesion that is expanded appears in A'. The expansion thickness depends on the shell's.

Due to the tumor infiltration to the peripheral organs, adjust the shell thickness according to the tumor expansion scope.

After the elasto ratio measurement is completed ([Shell Thickness is enabled]), the results are displayed beneath the image.

A: The tissue elasto of the lesion region;

A': The tissue elasto of the lesion region after the expansion;

Shell: The tissue elasto of inside the expansion;

Shell/A: Tissue elasto ratio between the expansion region and the lesion region;

B: The elasto of the normal tissue;

A/B: Elasto ratio between the lesion region and the normal region;

A'/B: Elasto ratio between the lesion region after the expansion and the normal region;

Shell/B: Elasto ratio between the expansion region and the normal region;

Elasto metric type (E/Cs/G) ←

Elasto metric: E

A

A'

Shell

A/B

A'/B

Shell/A

Shell/B

Elasto metric: E

B

A/B

A'/B

Shell/B

Shell expand outside



$$A' = A + \text{Shell}$$

Shell expand inside



$$A' = A - \text{Shell}$$

3.2.23 Elas. Hist

Function: it shows the elasto metrics which are drawn by the user in histograms.

1. In STE mode:
 - a: capture the image;
 - b: freeze the image;
 - c: enter the general measurement;
 - d: select [Elas. Hist Ellipse] or [Elas. Hist Trace] from the measurement menu. The measurement cursor appears on the screen.
2. Perform elasto histogram measurements, you can select between ellipse or trace method, for details, please refer to "3.2.11 Ratio (A)".
3. Rotate [Shell Thickness] knob to set the size of the mass. The system expands inside or outside automatically in lesion A. The tissue of the lesion that is expanded appears in A'. The expansion thickness depends on the shell's.

Due to the tumor infiltration to the peripheral organs, adjust the shell thickness according to the tumor expansion scope.

After the elasto histogram measurement is completed ([Shell Thickness is enabled]), the results are displayed beneath the image.

E/Cs/G (kPa) column:	Shell column:
The tissue elasto of the lesion region	Elasto results of the tissue inside the expansion region
<div style="display: flex; justify-content: space-around; width: 100%;"> <div style="text-align: center;">↑</div> <div style="text-align: center;">↑</div> </div>	
Mean	No: 1
Max	Metric: E (kPa) Shell
Min	Mean: 121.89 144.06
SD	Max: 156.39 165.64
	Min: 65.29 99.55
	SD: 14.3 10.2

Y-axis: the occurrence frequency of one certain elasto metric, only the highest ratio of the occurrence frequency appears.

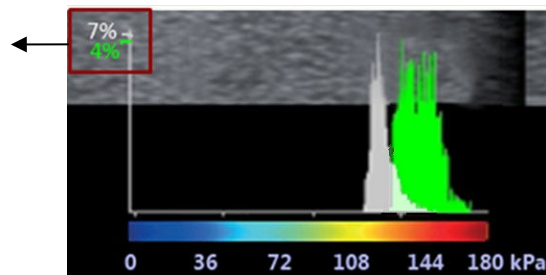

X-axis: elasto metric graphics (same with the color bar at the top left of the image)

3.2.24 Directional Ratio

This function applies for the directional ratio measurements. There is a difference in the elasto metrics if the transmission angle of the probe' acoustic beam and the muscle fiber are different.

Function: it supports the elasto ratio measurement and the calculation on the target tissue of various planes. It is helpful to know the directional situation of target elasto tissue.

Directional ratio= Direc 1 metrics of the target tissue/ Direc 2 metrics of the target tissue

1. In STE mode:
 - a: capture the target tissue
 - b: freeze the image; c: enter the general measurement;
 - d: select [Directional Ratio]→[Direc1: (Ellipse/Trace)] (the measurements include the ellipse method and trace method; refer to “3.2.13 B-Hist”).
 - e: measure the Direc 1 mean metrics on the target tissue.
2. a: Unfreeze the image.
 - b: adjust the probe scanning direction.
 - c: recapture the image, and the freeze the image.
 - d: enter the general measurement.
 - e: select [Directional Ratio]→[Direc2: (Ellipse/Trace)].
 - f: measure the Direc 2 mean metrics on the target tissue.

The results are displayed beneath the image after the elasto directional ratio is completed.

Elasto metric (E/G): elasto metric types:

D1 Diam:

Direction 1: =Direction 1 mean metric of the target tissue;

D2 Diam:

Direction 2: =Direction 2 mean metric of the target tissue;

Direction 1/Direction 2: Direction 1 mean metric of the target tissue/Direction 2 mean metric of the target tissue;

Direction 2/Direction 1: Direction 2 mean metric of the target tissue/Direction 1 mean metric of the target tissue;

3.2.25 TSM

This function applies for the tissue stiffness measurement.

1. In STE mode:
 - a. Capture the image.
 - b. Freeze the image.
 - c. Enter the general measurement.
 - d. Select [TSM] from the measurement menu.
Adjust the circle size by rotating <Angle>.
2. Move the circle to the desired position, and press <Set> key to confirm the position.
The measurement results are displayed on the result window, including Depth, Diameter and RLB index of the target tissue; Mean, Max, Min and SD value of the target tissue stiffness.

3.2.26 RAC

RAC (Relative Anisotropy Coefficient) is calculated though detecting Sagittal and Axial plane of the target tissue.

$$\text{RAC} = (\text{Sagittal } V_{\text{mean}} - \text{Axial } V_{\text{mean}}) / \text{Sagittal } V_{\text{mean}}$$

Sagittal V_{mean} : The average value of strain is calculated on Sagittal plane of the target tissue.

Axial V_{mean} : The average value of strain is calculated on Axial plane of the target tissue.

Tip: Only [Elas. Metric] is Cs unit, RAC can be calculated.

1. In STE imaging mode, scan the image of Sagittal plane and freeze, enter caliper measure status and select RAC item in the measure menu, the average value of strain is calculated on Sagittal plane of the target tissue.
2. Unfreeze the image. Move the probe, scan the image of Axial plane and freeze, enter caliper measure status and select RAC item in the measure menu, the average value of strain is calculated on Axial plane of the target tissue.

The result window displays:

Elas. Metric (Cs): the scale unit of Elas. Metric;

Slag: The average value of strain is calculated on Sagittal plane of the target tissue.

XS: The average value of strain is calculated on Axial plane of the target tissue.

3.2.27 Smart Trace

Function: helps the operator to trace the contour of the target by automatically recognizing the margin of the target and measures the lengths of major axis and minor axis, area and circumference of the closed region.

Tip: Smart Trace should be performed on frozen images.

1. After the image is frozen, select [Smart Trace] in the measurement menu or the touch screen. The cursor appears on the screen (and the touch screen).
2. Move the cursor to an area of interest.
3. Press <Set> to fix the starting point.
4. Move the cursor along the target to trace the outline of the target.
During tracing, you can roll the trackball backwards to delete latest tracing. Or, you can press <Set> to fix the traced contour.
The faster the cursor moving speed, the bigger the cursor, and the larger the recognized area.
5. Press <Set> key twice and the trace line will be closed with a straight line connecting the start and end points. The trace will also be closed when the cursor is very near to the starting point.

3.2.28 Smart Caliper

Tip: This feature should be performed on frozen images.

Function: helps the operator to measure lengths of the major axis and the minor axis by automatically recognizing the lesions under breast or thyroid exam mode. Measurement calipers can be modified by the operator.

1. Select [Smart Caliper] in the measurement menu or the touch screen. The cursor appears on the screen.
2. Move the cursor to the center of the target, and press <Set>. The major axis and the minor axis of the target are displayed on the screen.
If necessary, press <Update> to switch the four end points of the two axes, and use the trackball to move the activated end point of the axis.
3. Press <Set> to fix the two axes. The results appear in the result window.

3.2.29 Color Pixel Percentage

Tip: 1. This feature should be performed on frozen images.
2. It is not suggested to perform CPP measurement on color mixing area.

Function: measures the pixel proportion of blood flow signal in the region of interest under Color or Power mode.

The feature is not supported under TDI mode.

CPP(Ellipse)

1. Select [CPP(Ellipse)] in the measurement menu or the touch screen. The ellipse appears on the screen.
2. Rotate the knob under [CPP ROI] to adjust the ellipse of the ROI, and use the trackball to move the ellipse to the desired position.
If [Manual] is selected, you can draw the ellipse. For details on procedure of drawing ellipse, see "3.2.5 Area".

The ellipse should be in the color ROI.

3. Press <Set> key to fix the ellipse.

CPP(Rect)

1. Select [CPP(Rect)] in the measurement menu or the touch screen. The rectangle appears on the screen.
2. Rotate the knob under [CPP ROI] to adjust the ellipse of the ROI, and use the trackball to move the rectangle to the desired position.

If [Manual] is selected, you can draw the rectangle. For details on procedure of drawing rectangle, see "3.2.13 B-Hist".

The rectangle should be in the color ROI.

3. Press <Set> key to fix the rectangle.

CPP(Trace)

1. Select [CPP(Trace)] in the measurement menu or the touch screen.
2. See "Trace" in the "3.2.5 Area" for detailed procedures.

CPP(Recall)

Select [CPP(Recall)] in the measurement menu or the touch screen to repeat the last CPP measurement.

If CPP measurement has not been performed since the ultrasound system is powered on, the measurement result is based on the default size and position of an ellipse.

3.3 M General Measurements

3.3.1 Distance

Function: measures the distance between two points on the M Mode image.

1. Select [Distance] in the measurement menu or the touch screen. Two dotted lines perpendicular to each other appear on the screen.
2. Move the crossing point of the dotted lines to the measurement starting point and press <Set>.
3. Move the crossing point to the end point. The crossing point can then only be moved in a vertical direction. Then
press <Update> to switch between the fixed end and active end of the caliper. Or
press <Clear> to cancel setting the starting point.
4. Press <Set> to set the end point.

3.3.2 Time

Function: measures the time interval between two points on the M Mode image.

1. Select [Time] in the measurement menu or the touch screen. Two dotted lines perpendicular to each other appear on the screen.
2. Move the crossing point of the dotted lines to the measurement starting point and press <Set>.
3. Move the crossing point to the measurement end point. The crossing point can only be moved in a horizontal direction. Then
press <Update> to switch between the fixed end and active end of the caliper. Or
press <Clear> to cancel setting the starting point.
4. Press <Set> to set the end point.

3.3.3 Slope

Function: measures the distance and time between two points on the M Mode image and calculates the slope between the two points.

1. Select [Slope] in the measurement menu or the touch screen. Two dotted lines perpendicular to each other appear on the screen.
2. Move the crossing point of the dotted lines to the measurement starting point and press <Set>.
3. Move the crossing point to the measurement end point. The crossing point is connected to the starting point by a dashed line. Then
press <Update> to switch between the fixed end and active end of the caliper. Or
press <Clear> to cancel setting the starting point.
4. Press <Set> to set the end point.

3.3.4 Velocity

Function: measures the distance and time between two points on the M Mode image and then calculates the average velocity between the two points.

1. Select [Velocity] in the measurement menu or the touch screen. Two dotted lines perpendicular to each other appear on the screen.
2. Move the crossing point of the dotted lines to the measurement starting point and press <Set>.
3. Move the crossing point to the end point. The crossing point can then only be moved in a vertical direction.
Then press <Update> to switch between the fixed end and active end of the caliper. Or
press <Clear> to cancel setting the starting point.
4. Press <Set> to set the end point.

3.3.5 HR

Function: measures the time interval of n ($n \leq 8$) cardiac cycles on the M Mode image and calculates the heart rate.

The number of cardiac cycles “ n ” can be preset in the [System Preset] → [Application] preset dialog box. See “2.2 Measurement Parameters Preset” for details.

	CAUTION: During the measurement, the number of cardiac cycles between the measurement start and end points must be exactly the same as preset ([Setup]→[System Preset]→[Application]). Otherwise, misdiagnosis may occur.
---	--

1. Select [HR] in the measurement menu or the touch screen. Two dotted lines perpendicular to each other appear on the screen.
2. Select n cardiac cycles.

The HR result in the results window displays the measured heart rate value and the preset number of cardiac cycles, as shown in the figure below.

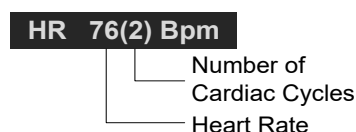

3.3.6 HR (R-R)

Function: measures the time interval between the R peaks of n ($n \leq 8$) cardiac cycles on the ECG image and calculates the heart rate.

The number of cardiac cycles “n” can be preset in the [System Preset] → [Application] preset dialog box. See “2.2 Measurement Parameters Preset” for details.



CAUTION:

During the measurement, the number of cardiac cycles between the measurement start and end points must be exactly the same as preset ([Setup]→[System Preset]→[Application]). Otherwise, misdiagnosis may occur.

1. Select [HR (R-R)] in the measurement menu or the touch screen. Two dotted lines perpendicular to each other appear on the screen.
2. Move the cursor onto the starting R peak point and press <Set>.
3. Move the cursor onto the end R peak point and press <Set>.

3.4 Doppler General Measurements

3.4.1 Time

Function: measures the time interval between two points on the Doppler image.

The operations are similar to the Time measurement in M Mode. See “3.3.2 Time” for details.

3.4.2 HR

Function: measures the time interval between n ($n \leq 8$) cardiac cycles on the Doppler Mode image and calculates the number of heart beats per minute (BPM).

The operations are similar to the Heart Rate measurement in M Mode. See “3.3.5 HR” for details.

3.4.3 D Vel.

Function: measures the velocity, pressure gradient and correction angle of a certain point on the Doppler spectrum.

Tip: The real-time velocity displays in the results window only before the <Set> key is pressed to fix the starting point. The history value of the velocity is not displayed in the results window.

1. Select [D Vel.] in the measurement menu or the touch screen. The cursor appears on the screen.
2. Move the cursor to the point to be measured for velocity.
3. Press <Set> and the result displays in the results window.

3.4.4 Acceleration

Function: measures the velocities of two points and their time interval on the Doppler image, and calculates the acceleration, pressure gradient, velocity difference and correction angle.

1. Select [Acceleration] in the measurement menu or the touch screen. The cursor appears on the screen.
2. Move the cursor to the first point to be measured for velocity.
3. Press <Set> to fix the first point.

4. Move the cursor to the second point to be measured for velocity.
5. Press <Set> to fix the second point. The results display in the results window.

3.4.5 D Trace

Function: measures clinical indices using spectral Doppler tracing. Measurement methods available are Trace, Auto, Spline, Vel. (Velocity) and 2 PT (Two Points).

A sketch of a Doppler spectrum is shown below:

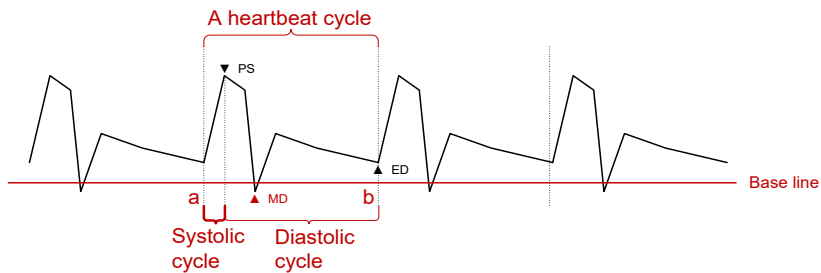

NOTE: When doing D trace, please set systolic starting time as the starting point and diastolic ending time as end point. That is, by tracing the Doppler spectrum from systolic to diastolic to calculate indices.

■ Operations:

1. Select [D Trace] in the measurement menu or the touch screen. The cursor appears on the screen.
2. Move the cursor to the starting point to be measured and press the [Set] key to fix the point.
3. Move the cursor around the object.
Move the cursor right: draw a trace line overlapping the spectrum as much as possible.
Move the cursor left to correct the trace line already drawn.
4. Trace the end point to be measured and press <Set> to fix the point.

Result parameters

The results obtained from D trace are:

Parameters	Descriptions	
PS	Peak Systolic Velocity	The highest velocity of the red blood cells crossing the sample volume.
ED	End-Diastolic Velocity	Measures the blood velocity at the end of the cardiac cycle.
MD	Min-Diastolic Velocity	Minimum absolute Velocity in the diastolic cycle.
Vel.	/	Flow velocity

Parameters	Descriptions	
Average velocity	/	<p>The average flow velocity in the whole traced Doppler spectrum.</p> <ul style="list-style-type: none"> ■ TAMAX (Time Averaged Maximum Velocity): $TAMAX(cm/s) = \int_{T_a}^{T_b} V(t) dt / (T_b - T_a)$ <p>Where V(t) is the maximum velocity</p> <ul style="list-style-type: none"> ■ TAMEAN (Time Averaged Mean Velocity): Obtained by auto-spectrum calculation. $TAMEAN(cm/s) = \int_{T_a}^{T_b} V(t) dt / (T_b - T_a)$ <p>Where V(t) is the mean velocity.</p>
PPG	Peak Pressure Gradient	The corresponding pressure gradient of the peak systolic velocity. PPG (mmHg) = 4 × PS (m/s) ²
Average Pressure Gradient	/	<p>The average pressure gradient in the whole traced Doppler spectrum.</p> <ul style="list-style-type: none"> ■ MPG: Maximum Pressure Gradient. $MPG(mmHg) = \int_{T_a}^{T_b} 4(V(t))^2 dt / (T_b - T_a)$ <p>Where V(t) is the peak systolic velocity.</p> <ul style="list-style-type: none"> ■ MMPG: Mean velocity Mean Pressure Gradient. (Obtained during auto-spectrum calculation.) $MMPG(mmHg) = \int_{T_a}^{T_b} 4(V(t))^2 dt / (T_b - T_a)$ <ul style="list-style-type: none"> ■ Where V(t) is the mean systolic velocity.
VTI	Velocity-Time Integral	<p>Velocity-time integral. The integral of the product of Doppler instantaneous velocity and the total time interval.</p> $VTI(m) = \int_{T_a}^{T_b} V(t) dt$
AT	Acceleration Time	The time of the blood velocity accelerating from the end of diastole to the systolic peak. This is usually the time interval between the end of the first cardiac cycle and the peak of the next cardiac cycle. Choose the first peak when two peaks exist in the systolic cycle.
DT	Deceleration Time	Deceleration Time.
HR	Heart Rate	Calculates the heart rate per minute by measuring the time interval of one cardiac cycle.
S/D	/	PS/ED. S/D (No unit) = PS (m/s) / ED (m/s)
D/S	/	ED/PS. D/S (No unit) = ED (m/s) / PS (m/s)
PI	Pulsatility Index	Pulsatility index. PI (No unit) = (PS (m/s) – ED (m/s)) / TAMAX (m/s)

Parameters	Descriptions	
RI	Resistive Index	Resistance index. $RI \text{ (No unit)} = (PS \text{ (m/s)} - ED \text{ (m/s)}) / PS \text{ (m/s)} $
θ	/	The correction angle is the spectrum angle during measurement, which is a result obtained from a non D trace measurement tool and is usually displayed together with the spectral measurement results.
PV	Peak Velocity	The peak velocity in systolic or diastolic cycles (with no difference), which is the highest velocity of the red blood cells that cross the sample volume. It can be used to examine the venous vessel.

NOTE:

1. In the formulae above, T means time, the unit is s; V means the velocity at each point during T, the unit is cm/s; a is the traced starting point, while b is the traced end point.
2. The above parameters are all the information obtained in D trace, while in application the system only displays part of them according to the operation and preset.

Measurement Method

The measurement method varies according to the result selected.

■ Velocity

Function: measures the velocity, pressure gradient and correction angle of a certain point on the Doppler spectrum.

The operations are similar to the Time measurement in M Mode. See “3.4.3 D Vel.” for details.

■ 2 PT

Function: measures the velocity, pressure gradient and correction angle between two points on the Doppler spectrum.

1. Select items using the [2 PT] method in the measurement menu, the cursor displays as a large “+.”
2. Move the cursor to the starting point to be measured and press <Set> to fix the point.
3. Move the cursor to the end point to be measured and press <Set> to fix the point.

■ Spline

1. Select items using the [Spline] method from the measurement menu.
2. Move the cursor to the starting point to be measured and press <Set> to fix the point.
3. Move the cursor along the edge of the desired region. Continue to fix the second, third, etc., point (50 points at most) of the spectrum.
4. Press <Set> twice to anchor the last reference point. Or
the measurement ends automatically when there are 50 reference points.

■ Auto-Spectrum Calculation

You can also acquire the above results by auto calculation, which calculates the recent cardiac cycles.

- Click [Auto Calc.] in the PW image menu to activate it. The system traces automatically and displays the results in the top-right part of the screen.
- Touch “Auto Calc” tab on the touch screen, and click [Auto Calc. Param.] in the PW image menu. You can select the parameters to be calculated.
- Click [Auto Cardiac Cycle] in the PW image menu. You can select the cycle number to be calculated.

3.4.6 PS/ED

Function: measures the Peak Systolic (PS) velocity and End Diastolic (ED) velocity on the Doppler spectrum, and calculates their resistance index (RI), S/D and correction angle.

1. Select [PS/ED] in the measurement menu or the touch screen. The cursor appears on the screen.
2. Move the cursor to the Systolic Peak and press <Set> to fix the point.
3. Move the cursor to the Diastolic End and press <Set> to fix the point.

3.4.7 Volume Flow

Function: measures blood flow through a vascular cross section per unit time.

1. Select [Volume Flow] in the measurement menu or the touch screen. The submenu displays.

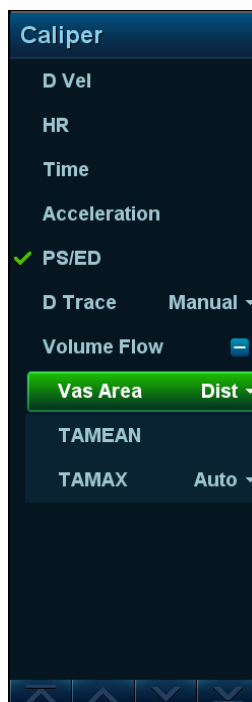

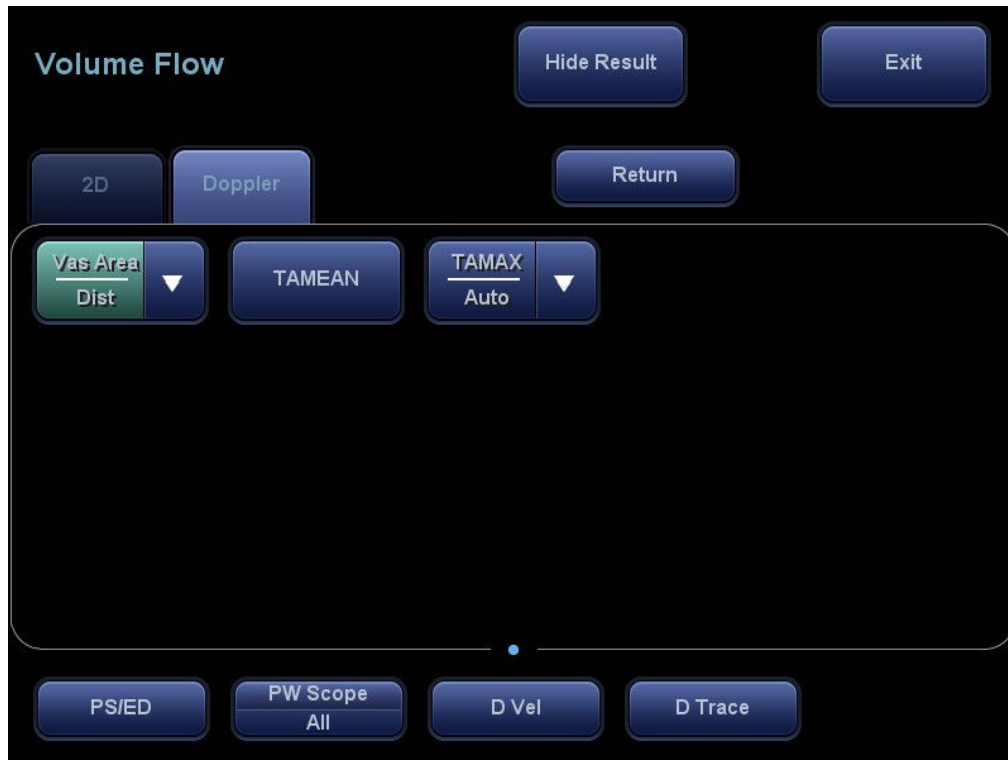

- Click [Vas. Area] to select the method for calculating the area: dist. or trace.
 - Click [PW Scope] to select the scope to be traced.
2. Measure the vascular area.
 3. Click [TAMEAN] or [TAMAX] to calculate the volume flow.

Item		Description	Methods or formulae
Vas. Area	Dist.	Obtain the area by measuring the vascular diameter.	$\text{Vas. Area} = \pi \times \text{Vas Diam (cm)}^2 / 4$
	Trace	Obtain the area using the trace method.	Area in 2D General Measurements
TAMEAN		Vol Flow(Area) - TAMEAN	$\text{Vol Flow(A) (ml/min)} = \text{Vas TAMEAN (cm/s)} \times \text{Vas. Area (cm}^2) \times 60 \text{ (s)}$ Vas. TAMEAN - Time Averaged Mean Velocity, obtained from the Vas. Trace measurement.
TAMAX		Vol Flow(Area) - TAMAX	$\text{Vol Flow(A) (ml/min)} = \text{Vas TAMAX (cm/s)} \times \text{Vas Area (cm}^2) \times 60 \text{ (s)}$ Vas. TAMAX - Time Averaged Maximum Velocity, obtained from the Vas. Trace measurement.

3.4.8 Velocity Ratio

Function: measure two D velocity values on one or two spectrums and calculate the ratio to analyze the flow information.

1. Select [Ratio (Vel)] in the measurement menu or the touch screen. The cursor appears on the screen.

2. Move the cursor and press <Set> to obtain two velocity values.
3. The system calculates the ratio automatically.

Where

$$Vel\ Ratio(Nounit) = |Vel1(cm / s) / Vel2(cm / s)|$$

3.4.9 VTI Ratio

Function: measure two VTI values on the spectrum and calculate the ratio.

1. Select [Ratio (VTI)] in the measurement menu or the touch screen. The cursor appears on the screen.
2. Move the cursor to obtain VTI1 and VTI2 values using the D trace method.
3. The system calculates the ratio automatically.

Where

$$VTI\ Ratio(Nounit) = |VTI1(cm) / VTI2(cm)|$$

3.4.10 HR (R-R)

Function: measures the time interval between R peaks of n (n≤8) cardiac cycles on the ECG image and calculates the number of heart beats per minute (BPM).

The operations are similar to the Heart Rate measurement in M Mode. See “3.3.5 HR” for details.

3.5 References

- 3Dist Volume:** Emamian, S.A., et al., "Kidney Dimensions at Sonography: Correlation With Age, Sex, and Habitus in 665 Adult Volunteers," American Journal of Radiology, January, 1993, 160:83-86.
- HR (M general measurement):** Dorland's Illustrated Medical Dictionary, ed. 27, W. B. Sanders Co., Philadelphia, 1988, p. 1425.
- PG:** Powis, R., Schwartz, R. Practical Doppler Ultrasound for the Clinician. Williams & Wilkins, Baltimore, Maryland, 1991, p. 162.
- Acceleration:** Starvos, A.T., et.al. "Segmental Stenosis of the Renal Artery Pattern Recognition of Tardus and Parvus Abnormalities with Duplex Sonography." Radiology, 184:487-492, 1992.
Taylor, K.W., Strandness, D.E. Duplex Doppler Ultrasound. Churchill-Livingstone, New York, 1990.
- PPG:** Yoganathan, Ajit P., et al., "Review of Hydrodynamic Principles for the Cardiologist: Applications to the Study of Blood Flow and Jets by Imaging Techniques," Journal of the American College of Cardiology, 1988, Vol. 12, pp. 1344-1353
- MPG:** Yoganathan, Ajit P., et al., "Review of Hydrodynamic Principles for the Cardiologist: Applications to the Study of Blood Flow and Jets by Imaging Techniques," Journal of the American College of Cardiology, 1988, Vol. 12, pp. 1344-1353
- VTI:** Degroff, C. G. Doppler Echocardiography. Third Edition. Lippincott-Raven, Philadelphia, 1999, p. 102-103
- RI:** Burns, P.N., "The Physical Principles of Doppler and Spectral Analysis," Journal of Clinical Ultrasound, November/December 1987, Vol. 15, No. 9, p. 586
- PI:** Burns, Peter N., "The Physical Principles of Doppler and Spectral Analysis," Journal of Clinical Ultrasound, November/December 1987, Vol. 15, No. 9, p. 585
- S/D:** Ameriso S, et al., "Pulseless Transcranial Doppler Finding in Takayasu's Arteritis," J Clin Ultrasound, September 1990; 18:592-6
- D/S:** Ameriso S, et al., "Pulseless Transcranial Doppler Finding in Takayasu's Arteritis," J Clin Ultrasound, September 1990; 18:592-6
- Volume Flow(Diam)-TAMAX** Burns, P.N., "The Physical Principles of Doppler and Spectral Analysis," Journal of Clinical Ultrasound, November/December 1987, 15(9):587.
- Volume Flow(Area)-TAMAX** Burns, P.N., "The Physical Principles of Doppler and Spectral Analysis," Journal of Clinical Ultrasound, November/December 1987, 15(9):587.

4 Abdomen

4.1 Abdomen Exam Preparations

Make the following preparations before measuring:

1. Confirm that the current probe is appropriate.
2. Check that the current system date is correct.
3. Click [Info] on the touch screen and register the patient information in the [Patient Info] → [ABD] dialog box.
4. Switch to the correct exam mode.

4.2 Basic Abdomen Measurement Procedures

1. Click [Info] on the touch screen and register the patient information in the [Patient Info] → [ABD] dialog box.
2. Press <Measure> to enter the Application Measurements.
If the current menu is not the one containing the Abdomen Measurement tools, move the cursor to the menu title and select the package with the Abdomen Measurement tools.
3. Select the measurement tool in the menu (or the touch screen) to start the measurement.
See section “4.3 Abdomen Measurement Tools” and steps in “3 General Measurement” for measurement methods.
4. Click [Report] on the touch screen to view the exam report. See “4.6 Abdomen Exam Report” for details.

4.3 Abdomen Measurement Tools

NOTE: The measurement tools mentioned below are configured in the system. The application measurement packages provided in this system are generally different combinations of measurement tools.

Measurement, calculation and study measurement items in 2D and Doppler mode (no M mode measurement items) are listed below:

2D Abdomen Measurements

Types	Tools	Descriptions	Methods or formulae
Measurement	Liver L	Liver Long Diameter	Distance in 2D General Measurements
	Liver H	Liver Anterior-Posterior Diameter	
	Liver W	Liver Trans Diameter	
	Renal L	Renal Length	
	Renal H	Renal Height	
	Renal W	Renal Width	
	Cortex	Renal Cortical Thickness	
	Adrenal L	Adrenal Length	
	Adrenal H	Adrenal Height	
	Adrenal W	Adrenal Width	
	CBD	Common bile duct	
	Portal V Diam	Portal Vein Diameter	
	CHD	Common hepatic duct	
	GB L	Gallbladder Length	
	GB H	Gallbladder Height	
	GB W	Gall Bladder Width	
	GB wall th.	Gallbladder wall thickness	
	Panc. duct	Pancreatic duct	
Panc. head	Pancreatic head		

Types	Tools	Descriptions	Methods or formulae
	Panc. body	Pancreatic body	
	Panc. tail	Pancreatic tail	
	Spleen L	Spleen Length	The system automatic calculates Spleen Vol value. $\text{Spleen Vol} = \frac{\pi}{6} \times \text{Spleen L} \times \text{Spleen W} \times \text{Spleen H}$
	Spleen W	Spleen Width	
	Skin-L.Capsule Dist.	/	
	Spleen H	Spleen Height	
	Spleen Area	/	
	Spleen V Diam	Spleen vein Diam	
	Spleen A Diam	Spleen artery Diam	Distance in 2D General Measurements
	Aorta AP	Abdominal Aorta Anterior-Posterior Diameter	
	Aorta Trans	Abdominal Aorta Trans Diameter	
	Aorta Bif.	Aorta Bifurcation	
	Aorta Aneurysm Long	Abdominal Aorta Aneurysm Long Diameter	
	Aorta Aneurysm AP	Abdominal Aorta Aneurysm Anterior-Posterior Diameter	
	Aorta Aneurysm Trans	Abdominal Aorta Aneurysm Trans Diameter	
	Iliac Diam.	Iliac Diameter	
	Hepatic Lesion1-3, d1-3	/	
	Hepatic Cyst1-3, d1-3	/	
	Renal Cyst1-3, d1-3	/	

Types	Tools	Descriptions	Methods or formulae
	Renal Lesion1-3, d1-3	/	
	Pre-BL L	Pre-void Bladder Length	
	Pre-BL H	Pre-void Bladder Height	
	Pre-BL W	Pre-void Bladder Width	
	Post-BL L	Post-void Bladder Length	
	Post-BL H	Post-void Bladder Height	
	Post-BL W	Post-void Bladder Width	
	CHD	Common Hepatic Duct	
	Shunt Diam	Shunt Diameter	
	Cystic Duct	Cystic Duct	
	CBD	Common Bile Duct	
	Panc duct	Pancreatic Duct	
	Panc neck	Pancreatic Neck	
	Appendix	Appendix	
	Appendix Wall	Appendix Wall	
	Pylorus	Pylorus	
	Pylorus Wall	Pylorus Wall	
	Portal V Diam	Portal Vein Diameter	
	M Portal V Diam	Main Portal Vein Diameter	
	Splenic V Diam	Splenic Vein Diameter	
	PS Conflnc Diam	Portal Splenic Confluence Diameter	
	Renal V Diam	Renal Vein Diameter	
	SMV Diam	Superior Mesenteric Vein Diameter	
	IMV Diam	Inferior Mesenteric Vein Diameter	

Types	Tools	Descriptions	Methods or formulae
	Cortex(Renal Transplant1-2)	Renal Cortical Thickness	
	Renal V Diam(Renal Transplant1-2)	Renal Vein Diameter	
	Ureter Diam(Renal Transplant1-2)	Ureter Diameter	
	Ureter	/	
	Hepatic Lesion1~3 Elas.	Hepatic Lesion1~3 Elastography	Elastography in 2D General Measurements
	LSM	Liver Stiffness Measurement	
	Aorta Aneurysm Status	Abdominal Aorta Aneurysm Status	Tick the shape of Abdominal Aorta Aneurysm. Choose from: Fus (Fusiform); Sacc (Saccular); Pseudo; N/A
	Smart HRI		See below
	Free Fluid	Free Fluid Status	Tick the organs or tissues containing free fluid. Choose from: Hepat (Hepatic); Spln (Splenic); Card (Cardiac); Pelv (Pelvis); N/A
Calculation	Aorta Stan D	Aorta Stenosis Diameter	Aorta Stenosis D (No unit) = (Normal Diam. (cm) – Resid Diam. (cm)) / Normal Diam. (cm) × 100% Stenosis D (No unit) = (D1-D2) / MAX (D1, D2) *100% Where D1 and D2 refer to the measured Aorta diameter, and MAX (D1, D2) represents the larger value of the two.
	Aorta Stan A	Aorta Stenosis Area	Stenosis A (No unit) = (A1-A2) / MAX (A1, A2) *100% Where A1 and A2 refer to the measured Aorta area, and MAX (A1, A2) represents the larger value of the two.
	Renal Vol.	Renal Volume	See “Renal Vol.”
	Pre-BL Vol.	Pre-void Bladder Volume	See “Pre-BL Vol.”
	Post-BL Vol.	Post-void Bladder Volume	See “Post-BL Vol.”
	Mictur. Vol.	Micturated Volume	See “Mictur. Vol.”
Study	Spleen	/	Spleen L、Spleen W、Spleen H、Spleen Area

Types	Tools	Descriptions	Methods or formulae
	Aorta Aneurysm	/	Aorta Aneurysm H、 Aorta Aneurysm W、 Aorta Aneurysm L
	Hepatic Lesion1-3	/	Hepatic Lesion1-3 d1-3
	Hepatic Cyst1-3	/	Hepatic Cyst1-3 d1-3
	Renal Cyst1-3	/	Renal Cyst1-3 d1-3
	Renal Lesion1-3	/	Renal Lesion1-3 d1-3
	Kidney	/	See "Kidney"
	Adrenal	/	See "Adrenal"
	Bladder	/	See "Bladder"
	Hepatic Lesion1~3 ElasRatio	/	Elastography ratio in 2D General Measurements
	Celiac Axis	/	Anterior-Posterior, Transverse Same as the Distance measurement in 2D General Measurements
	SMA	Superior Mesenteric Artery	
	C Hepatic A	Common Hepatic Artery	
	Proper Hepatic A	Proper Hepatic Artery	
	Hepatic A	Hepatic Artery	
	Splenic A	Splenic Artery	
	GDA	Gastroduodenal Artery	
	IMA	Inferior Mesenteric Artery	
	Celiac Axis Aneurysm	/	Long, Anterior-Posterior, Transverse Same as the Distance measurement in 2D General Measurements
	SMA Aneurysm	Superior Mesenteric Arterial Aneurysm	
	C Hepatic A Aneurysm	Common Hepatic Artery Aneurysm	
	Proper Hepatic A Aneurysm	Proper Hepatic Artery Aneurysm	
	Hepatic A Aneurysm	Hepatic Artery Aneurysm	

Types	Tools	Descriptions	Methods or formulae	
	Splenic A Aneurysm	Splenic Arterial Aneurysm		
	GDA Aneurysm	Gastroduodenal Arterial Aneurysm		
	IMA Aneurysm	Inferior Mesenteric Arterial Aneurysm		
	EVAR Residual Aneurysm Sac(2D)	Aortic Endograft Residual Aneurysm Sac	Anterior-Posterior, Transverse Same as the Distance measurement in 2D General Measurements	
	EVAR Inflow(2D)	Aortic Endograft Inflow		
	EVAR Graft Body(2D)	Aortic Endograft Graft Body		
	EVAR Limb(2D)	Aortic Endograft Limb		
	EVAR Outflow(2D)	Aortic Endograft Outflow		
	Aortic Bypass Graft Anast(2D)	Aortic Bypass Graft Anastomosis		
	Aortic Bypass Graft Graft(2D)	Aortic Bypass Graft Graft		
	ABD Stenosis 1-4 2D	Abdominal Arterial Stenosis 1-4		<ul style="list-style-type: none"> Anterior-Posterior, Transverse Same as the Distance measurement in 2D General Measurements Stenosis Stenosis Diameter (No unit) = $(\text{Outer D} - \text{Inner D}) / \text{MAX}(\text{Outer D}, \text{Inner D}) * 100\%$ Where Outer D and Inner D refer to the measured vascular diameter, and MAX (Outer D, Inner D) represents the larger value of the two. Stenosis Area (No unit) = $(\text{Outer A} - \text{Inner A}) / \text{MAX}(\text{Outer A}, \text{Inner A}) * 100\%$ Where Outer A and Inner A refer to the measured vascular area, and MAX (Outer A, Inner A) represents the larger value of the two.

Types	Tools	Descriptions	Methods or formulae
	R Liver Lobe	Right Liver Lobe	Height, Width, Length Same as the Distance measurement in 2D General Measurements
	L Liver Lobe	Right Liver Lobe	
	GB	Gall Bladder	
	Kidney(Renal Transplant1-2)	/	
	Adrenal(Renal Transplant1-2)	/	
	Finding 1(Renal Transplant1-2)	/	
	GB Finding 1-5	Gall Bladder Finding 1-5	d1-3 Same as the Distance measurement in 2D General Measurements
	Panc Finding 1-5	Pancreas Finding 1-5	
	IVC(2D)	Inferior Vena Cava	<ul style="list-style-type: none"> Anterior-Posterior, Transverse, Depth Same as the Distance measurement in 2D General Measurements Checklist Tick the status of Inferior Vena Cava. Choose from: Cmp (Compression); Sp (Spontaneity); Ph (phasicity); Aug (Augmentation); Rflx (Reflux); N/A
	Hepatic V(2D)	Hepatic Vein	Anterior-Posterior, Transverse Same as the Distance measurement in 2D General Measurements
	Lt Hepatic V(2D)	Left Hepatic Vein	
	M Hepatic V(2D)	Middle Hepatic Vein	
	Rt Hepatic V(2D)	Right Hepatic Vein	
	Renal A Aneurysm	Renal Arterial Aneurysm	Long, Anterior-Posterior, Transverse Same as the Distance measurement in 2D General Measurements

Doppler Abdomen Measurements

Types	Tools	Descriptions	Methods or formulae
Measurement	Arcuate A	Arcuate Artery	D trace in General D measurements
	Segment A	Segmental Artery	
	Interlobar A	Interlobar Artery	

Types	Tools	Descriptions	Methods or formulae
	Renal A	Renal Artery	
	M Renal A	Main Renal Artery	
	Aorta	/	
	Aorta(Post)	Arterial Post Abdominal Aorta	
	Celiac Axis	/	
	Celiac Axis(Post)	Arterial Post Celiac Axis	
	SMA	Superior Mesenteric Artery	
	SMA(Post)	Arterial Post Superior Mesenteric Artery	
	GDA	Gastroduodenal Artery	
	GDA(Post)	Arterial Post Gastroduodenal Artery	
	IMA	Inferior Mesenteric Artery	D trace and PS/ED in General D measurements
	IMA(Post)	Arterial Post Inferior Mesenteric Artery	
	C Hepatic A	Common Hepatic Artery	D trace in General D measurements
	C Hepatic A(Post)	Common Hepatic Artery	
	Proper Hepatic A	Proper Hepatic Artery	
	Proper Hepatic A(Post)	Arterial Post Proper Hepatic Artery	
	Hepatic A	Hepatic Artery	
	Hepatic A(Post)	Arterial Post Hepatic Artery	
	Splenic A	Splenic Artery	
	Splenic Artery(Post)	Arterial Post Splenic Artery	
	EVAR Residual Aneurysm Sac	Aortic Endograft Residual Aneurysm Sac	
	EVAR Inflow	Aortic Endograft Inflow	
	EVAR Graft Body	Aortic Endograft Graft Body	
	EVAR Limb	Aortic Endograft Limb	
	EVAR Outflow	Aortic Endograft Outflow	
	Aortic Bypass Graft Anast	Aortic Bypass Graft Anastomosis	
	Aortic Bypass Graft Graft	Aortic Bypass Graft Graft	
	IVC(Liver Transplant)	Inferior Vena Cava	

Types	Tools	Descriptions	Methods or formulae
	Hep V Confl(Liver Transplant)	Hepatic Vein Confluence	Time in M General Measurements
	Donor IVC(Liver Transplant)	Inferior Vena Cava from the donor, not the recipient	
	Renal A1	Renal Artery A1	
	Renal A2	Renal Artery A2	
	Hilum	/	
	TIPS	Transjugular Intrahepatic Portosystemic Shunt	
	IVC	Inferior Vena Cava	
	IVC Reflux	Inferior Vena Cava Reflux	
	Portal V	Portal Vein	D trace in General D measurements
	M Portal V	Main Portal Vein	
	Hepatic V	Hepatic Vein	
	Lt Hepatic V	Left Hepatic Vein	
	Rt Hepatic V	Right Hepatic Vein	
	M Hepatic V	Middle Hepatic Vein	
	Splenic V	Splenic Vein	
	Renal V	Renal Vein	
	Hepatic A Anast(Liver Transplant)	Hepatic A Anastomosis	
	Hepatic V Anast(Liver Transplant)	Hepatic V Anastomosis	
	Portal V Anast(Liver Transplant)	Portal V Anastomosis	
	Artery Anast(Renal Transplant1-2)	Artery Anastomosis	
	Artery Anast 2(Renal Transplant1-2)	Artery Anastomosis 2	
	Vein Anast(Renal Transplant1-2)	Vein Anastomosis	
	Vein Anast 2(Renal Transplant1-2)	Vein Anastomosis 2	
	Renal A(Renal Transplant1-2)	Renal Artery	

Types	Tools	Descriptions	Methods or formulae
	Renal A1(Renal Transplant1-2)	Renal Artery A1	
	Renal A2(Renal Transplant1-2)	Renal Artery A2	
	Hilum(Renal Transplant1=2)	Hilum	
	Interlobar A(Renal Transplant1-2)	Interlobar Artery	
	Arcuate A(Renal Transplant1-2)	Arcuate Artery	
	Segmental A(Renal Transplant1-2)	Segmental Artery	
	Renal Vein 1/2(Renal Transplant1-2)	Renal Vein 1/2	
	SMV	Superior Mesenteric Vein	
	IMV	Inferior Mesenteric Artery	
Calculation	RAR	Ratio of Renal Artery PS the Abdominal Aorta PS	$RAR \text{ (no unit)} = \frac{ Renal A PS \text{ (cm/s)} }{ Aorta PS \text{ (cm/s)} }$
	SMA/Ao	Ratio of Superior Mesenteric Artery PS and Abdominal Aorta PS	$SMA/Ao \text{ (no unit)} = \frac{ SMA PS \text{ (cm/s)} }{ Aorta PS \text{ (cm/s)} }$
	CA/Ao	Ratio of Celiac Axis PS and Abdominal Aorta PS	$CA/Ao \text{ (no unit)} = \frac{ Celiac Axis PS \text{ (cm/s)} }{ Aorta PS \text{ (cm/s)} }$
Study	ABD Stenosis 1-4	Abdominal Arterial Stenosis 1-4	D trace in General D measurements
	Renal Transplant 1-2(Doppler)	/	

4.4 Abdomen Measurement Operations

- Tip:**
1. See the table in “4 Abdomen Measurement Tools” above for measurement tools and methods.
 2. For the definitions of measurement, calculation and study, see “1.3 Measurement, Calculation and Study”.
 3. The order of the measurement items can be preset. See “2.4.2 Application Measurement Preset” for details.
 4. A measurement tool can be activated by clicking the item in the measurement menu or on the touch screen. It is described as “Select/Click ... in the measurement menu” in the following procedures.

1. Select the item/tool in the measurement menu.
2. Perform the measurement referring to the methods in the table above.

■ Auto HRI Measurement (Smart HRI)

Smart HRI is an auto measurement method for Hepatorenal Index (HRI). HRI is the brightness ratio of liver to right renal cortex. The procedure is as follows:

1. Scan the proper image.
2. Select the Smart HRI measurement item from the menu.
3. The system positions the ROI of Liver (marked by L) and the ROI of right renal (marked by RC) automatically. The measurement results are displayed on the screen
If necessary, you can rotate the trackball to move the ROI or rotate the <Angle> knob to adjust the size of the ROI. Press <Update> to switch ROIs.
4. Press <Set> to confirm the measurement.

4.5 Calculation Tool Operations

Stenosis D

Function: measures the Normal Diam. and Resid. Diam., calculates the Stenosis D.

1. Select [Stenosis D] in the measurement menu or the touch screen.
2. Use the Distance measurement method in 2D General Measurements to measure the Normal (D) and Resid (D).

The Stenosis D is calculated automatically.

Stenosis A

Function: measures the Normal Area and Resid. Area, calculates the Stenosis A.

1. Select [Stenosis A] in the measurement menu or the touch screen.
2. Use the Area measurement method in 2D General Measurements to measure the Normal(A) and Resid(A).

The Stenosis A is calculated automatically.

4.6 Abdomen Exam Report

During or after a measurement, Click [Report] on the touch screen to browse the report.

For details about report browsing, printing and exporting, etc., see "1.7 Report."

5 Obstetrics

Obstetric measurements are used to estimate the GA and EDD and calculate the growth indices, including the EFW. The growth estimate is determined by the growth curve and fetal biophysical profile.

5.1 Obstetric Exam Preparations

Make the following preparations before measuring:

1. Confirm that the current probe is appropriate.
2. Check that the current system date is correct.
3. Click [Info] on the touch screen and register the patient information in the [Patient Info] → [OB] dialog box.

For more details, see “Exam Preparation → Patient Information” in the Operator's Manual [Basic Volume].

4. Switch to the correct exam mode.



CAUTION:

Ensure the system date is correct, otherwise the GA and EDD calculated will be wrong.

5.2 Basic Measurement Procedures

1. Click [Info] on the touch screen and register the patient information in the [Patient Info] → [OB] dialog box.

The clinical GA is calculated when the corresponding data is entered on this page. See “5.3.1 Clinical GA” for details.

2. Press <Measure> to enter the Application Measurements.
3. Select the measurement tool from the menu or the touch screen to start the measurement.
See the table in “5.4 Obstetric Measurement Tools” below for measurement tools.
See section “5.5 Obstetric Measurement Operations” and steps in “3 General Measurement” for measurement methods.
4. Click [Report] on the touch screen to view the exam report. See “5.7 Obstetric Exam Report” for details.

5.3 GA

5.3.1 Clinical GA

The GA (Gestational Age) and EDD (Estimated Delivery Date) are calculated according to clinical parameters.

1. Click [Info] on the touch screen and register the patient information in the [Patient Info] → [OB] dialog box.

The system automatically calculates the GA and EDD after entering the relative information.

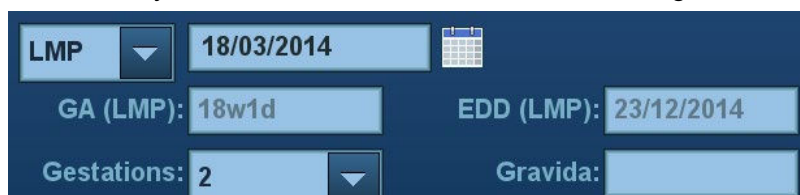

The calculation methods are listed as follows:

- LMP: enter the LMP, the system will calculate the GA and EDD.
- DOC: enter the DOC, the system will calculate the GA and EDD.
- IVF: after you enter IVF, the system will calculate the GA and EDD.
- PRV: enter the date and GA of the last exam, the system will calculate a new GA and EDD.
- BBT: after you enter BBT, the system will calculate the GA and EDD.
- EDD: enter the EDD, the system will calculate the GA and LMP.

2. The clinical GA is shown at the top of the obstetric report.

Tip: The latest EDD and GA calculation is considered as the final value if more than one EDD and GA calculations are valid.

5.3.2 Ultrasound GA

The ultrasound GA and ultrasound EDD are calculated according to the parameters obtained in the measurements.

- GA in OB Items
- AUA (Average Ultrasound Age)
- CUA (Composite Ultrasound Age)

GA in OB Items

The GA in the OB items is calculated from the related GA tables/formulae. It is independent from the clinical GA.

1. You can preset the GA formulae and whether to display the EDD or not in [System Preset] → [OB]. See “2.3 Obstetric Preset” for details.
2. The GA and other measurement values display in the results window after a measurement. If the Diagnostic GA exceeds the threshold, an OOR (out of range) displays in the results window and this result is not recorded in the report.
3. The GA of an OB item displays to the right of the item measurements.
4. For result values used to calculate GA (Gestational Age) and EDD (Estimated Date of Delivery), the formula used in this calculation can be selected from [Formula].

AUA

AUA is the average of the valid GAs that are calculated according to the biparietal diameter (BPD), head circumference (HC), abdomen circumference (AC), femur length (FL), Gestational Sac (GS), crown rump length (CRL), etc.

1. All valid values of all the above items will be included in the AUA calculation in the system default method.
2. Click the checkboxes to the right of the related items to select whether to include the item in the AUA calculation or not. The AUA value varies according to the selection.

Name:	DOB:	Operator: Admin
ID: 20140723-041050-	Age:	Ref.Physician: Fetus A
LMP: 14/04/2014	GA: 14w2d	EDD(LMP): 19/01/2015 AUA 15w5d EDD(AUA): 09/01/2015

2D Measurements

EFW

EFW Hadlock(AC,FL,HC,BPD) 135g (5 oz) ±20g (1 oz)

EFW-GA Hadlock 15w5d

EFW-GP(LMP)(Hadlock) >97% EFW-GP(AUA)(Hadlock) 45.22%

	Formula	Value	1	2	3	Method	GA	Range
CRL	Hadlock	9.96cm	9.96			Avg	15w6d	15w1d-16w4d
BPD	Hadlock	2.98cm 89.62%	2.98			Avg	15w3d	14w2d-16w4d
HC	Hadlock	11.69cm 94.74%	11.69			Avg	15w5d	14w4d-16w6d
AC	Hadlock	10.04cm 96.25%	10.04			Avg	16w1d	14w3d-17w6d
FL	Hadlock	1.86cm 88.69%	1.86			Avg	15w4d	14w1d-17w0d

CUA

The CUA is calculated according to formulae based on certain measurement items (the items involved include the biparietal diameter (BPD), head circumference (HC), abdomen circumference (AC) and femur length (FL)). To calculate the CUA, all the GA formulae of the parameters involved must be Hadlock, the unit of the parameters is cm and unit of CUA is week. The formulae are listed as follows:

1. $CUA(BPD) = 9.54 + 1.482 * BPD + 0.1676 * BPD^2$
2. $CUA(HC) = 8.96 + 0.540 * HC + 0.0003 * HC^3$
3. $CUA(AC) = 8.14 + 0.753 * AC + 0.0036 * AC^2$
4. $CUA(FL) = 10.35 + 2.460 * FL + 0.170 * FL^2$
5. $CUA(BPD, HC) = 10.32 + 0.009 * HC^2 + 1.3200 * BPD + 0.00012 * HC^3$
6. $CUA(BPD, AC) = 9.57 + 0.524 * AC + 0.1220 * BPD^2$
7. $CUA(BPD, FL) = 10.50 + 0.197 * BPD * FL + 0.9500 * FL + 0.7300 * BPD$
8. $CUA(HC, AC) = 10.31 + 0.012 * HC^2 + 0.3850 * AC$
9. $CUA(HC, FL) = 11.19 + 0.070 * HC * FL + 0.2630 * HC$
10. $CUA(AC, FL) = 10.47 + 0.442 * AC + 0.3140 * FL^2 - 0.0121 * FL^3$
11. $CUA(BPD, HC, AC) = 10.58 + 0.005 * HC^2 + 0.3635 * AC + 0.02864 * BPD * AC$
12. $CUA(BPD, HC, FL) = 11.38 + 0.070 * HC * FL + 0.9800 * BPD$
13. $CUA(BPD, AC, FL) = 10.61 + 0.175 * BPD * FL + 0.2970 * AC + 0.7100 * FL$

$$14. \text{CUA}(\text{HC}, \text{AC}, \text{FL}) = 10.33 + 0.031 * \text{HC} * \text{FL} + 0.3610 * \text{HC} + 0.0298 * \text{AC} * \text{FL}$$

$$15. \text{CUA}(\text{BPD}, \text{HC}, \text{AC}, \text{FL}) = 10.85 + 0.060 * \text{HC} * \text{FL} + 0.6700 * \text{BPD} + 0.1680 * \text{AC}$$

The default method of calculating the CUA is to use the formula that involves more measurement items. You can also select the parameters by clicking the checkboxes to the right of the related items.

OB Growth Percentile

The obstetric growth percentile is used to estimate the fetal growth. It calculates the difference between the ultrasound measurement results and the measurement results corresponding to the clinical GA in the FG table. The percentile will not be calculated when there is no clinical GA, or no FG table, or the SD Type of the FG table is set to "None."

The premise is: data in the FG table are (approximately) normally distributed and support "lower-limit < average value < upper-limit."

The system does not calculate the OB growth percentile if:

- An FG table is not normally distributed.
- There is no upper/lower deviation set in the FG table.
- The FG table has the upper/lower deviation set, but certain clinical GA values have no upper/lower deviation or the deviation value is not plus. The fetal growth curve is not affected. E.g. Jeanty FG table of RAD.

The OB growth percentile is displayed in the results window, the measurement report, the exported PDF/RTF report and the OB structured report, and it supports print viewing and printing.

5.4 Obstetric Measurement Tools

The system supports the following 2D/M/Doppler obstetric measurements.

- NOTE:**
1. The measurement tools mentioned below are configured in the system. The application measurement packages provided in this system are generally different combinations of measurement tools. For more information about package preset, see “2.4.2.2 Application Measurement Preset.”
 2. The Smart NT must be used with convex-wide probe and good image quality. If an evident inaccurate recognition exists, confirm the target profile manually and adjust the result.
 3. If the results of the calculation items of CI, FL/BPD, FL/AC, HC/AC and FL/HC exceed the clinical range, the result value displays as “value*.”

2D Obstetric Measurements

Types	Tools	Descriptions	Methods or formulae
Measurement	GS	Gestational Sac Diameter	Distance in 2D General Measurements
	YS L	Yolk Sac Length	
	CRL	Crown Rump Length	Dist (same as Distance in 2D General Measurements), Trace, Spline
	NT	Nuchal Translucency	Distance in 2D General Measurements (Support Smart NT method if the Smart NT function is configured)*
	BPD	Biparietal Diameter	Distance in 2D General Measurements (Support Smart OB method if the Smart OB function is configured)
	OFD	Occipital Frontal Diameter	
	FL	Femur Length	The system automatic calculates GA value.
	HC ¹	Head Circumference	Circumference in 2D General Measurements (Support Smart OB method if the Smart OB function is configured)
	AC	Abdominal Circumference	
	IT	Intracranial Translucency	Distance in 2D General Measurements
	TAD	Abdominal Transversal Diameter	
	APAD	Anteroposterior Abdominal Diameter	

¹ Head Circumference: in the HC measurement, if the measurement cursor of BPD appears on the screen, then the measurement starting point will be automatically positioned at the measurement cursor starting point of the last BPD. If you use “Ellipse” to measure the HC, the measurement cursor of the last BPD will be the first axis of the ellipse in the default status.

Types	Tools	Descriptions	Methods or formulae
	TCD	Cerebellum Diameter	
	Cist Magna	Cist Magna	
	LVW	Lateral Ventricle Width	
	HW	Hemisphere Width	
	OOD	Outer Orbital Diameter	
	NBL	Nasal Bone Length	
	IOD	Inter Orbital Diameter	
	HUM	Humerus Length	
	Ulna	Ulna Length	
	RAD	Radius Length	
	Tibia	Tibia Length	
	FIB	Fibula Length	
	CLAV	Clavicle Length	
	Vertebrae	Length of Vertebrae	
	MP	Middle Phalanx Length	
	Foot	Foot Length	The GA is calculated automatically after foot measurements are completed.
	Ear	Ear Length	
	APTD	Anteroposterior trunk diameter	Distance in 2D General Measurements
	TTD	Transverse trunk diameter	
	FTA	Fetal Trunk Cross-sectional Area	Area in 2D General Measurements
	THD	Thoracic Diameter	Distance in 2D General Measurements
	HrtC	Heart Circumference	Area in 2D General Measurements
	TC	Thoracic circumference	
	Umb. VD	Umbilical Vein Diameter	
	F-kidney L	Fetal kidney Length	
	F-kidney H	Fetal kidney Height	
	F-kidney W	Fetal kidney Width	
	Mat. Kidney	Matrix Kidney Length	Distance in 2D General Measurements
	Lung	Lung Length	
	Stomach	Stomach Length	
	YS H	Yolk Sac Height	
	YS W	Yolk Sac Width	

Types	Tools	Descriptions	Methods or formulae
	Amniotic Sac L	Amniotic Sac Length	
	Amniotic Sac H	Amniotic Sac Height	
	Amniotic Sac W	Amniotic Sac Width	
	Ovary Cyst L	Ovary Cyst Length	
	Ovary Cyst H	Ovary Cyst Height	
	Ovary Cyst W	Ovary Cyst Width	
	UT AW	UT Anterior wall thickness	
	UT PW	UT Posterior wall thickness	
	Cervix L	Cervical Length	
	AF	Amniotic Fluid	
	NF	Nuchal Fold	
	Orbit	Orbit	
	PL Thickness	Placental Thickness	
	Sac Diam1	Gestational Sac Diameter 1	
	Sac Diam2	Gestational Sac Diameter 2	
	Sac Diam3	Gestational Sac Diameter 3	
	AF1	Amniotic Fluid 1	
	AF2	Amniotic Fluid 2	
	AF3	Amniotic Fluid 3	
	AF4	Amniotic Fluid 4	
	LVIDd	Left Ventricular Internal Diameter at End-diastole	
	LVIDs	Left Ventricular Internal Diameter at End-systole	
	LV Diam.	Left Ventricular Diameter	
	LA Diam.	Left Atrium Diameter	
	RVIDd	Right Ventricular Internal Diameter at End-diastole	
Measurement	RVIDs	Right Ventricular Internal Diameter at End-systole	
	RV Diam.	Right Ventricular Diameter	
	RA Diam.	Right Atrium Diameter	

Types	Tools	Descriptions	Methods or formulae
	IVSd	Interventricular Septal Thickness at End-diastole	Distance in 2D General Measurements
	IVSs	Interventricular Septal Thickness at End-systole	
	IVS	Interventricular Septal Thickness	
	LV Area	Left Ventricular Area	
	LA Area	Left Atrium Area	
	RV Area	Right Ventricular Area	
	RA Area	Right Atrium Area	
	Ao. Diam.	Aorta Diameter	
	MPA Diam.	Main Pulmonary Artery Diameter	
	LVOT Diam.	Left Ventricular Outflow Tract Diameter	
	RVOT Diam.	Right Ventricular Outflow Tract Diameter	
	Facial Angle	Angle of the two lines: one from fetus nasal base to forehead and the other from nasal base to ear base.	Angle in 2D General Measurements
	HrtA	Heart area	Area in 2D General Measurements
	MV Diam(Z-Score)	Mitral Valve diameter	Distance in 2D General Measurements
	PV Diam(Z-Score)	Pulmonary Valve Diameter	
	Ao. Asc. Diam(Z-Score)	Ascending Aorta Diameter	
	Ao. Desc. Diam(Z-Score)	Descending Aorta Diameter	
	Duct. Art. Diam(Z-Score)	Ductus Arteriosus Diameter	
	TV Diam(Z-Score)	Tricuspid Valve Diameter	
	LPA Diam(Z-Score)	Left Pulmonary Artery Diameter	
	RPA Diam(Z-Score)	Right Pulmonary Artery Diameter	
	AV Diam(Z-Score)	Aorta Valve Diameter	
	IVC Diam(Z-Score)	Inferior Vena Cava Diameter	
	MPA Diam(Z-Score)	/	

Types	Tools	Descriptions	Methods or formulae
	RV Diam(Z-Score)	/	
	LV Diam(Z-Score)	/	
	RV Area(Z-Score)	/	
	LV Area(Z-Score)	/	
	RVIDd(Z-Score)	/	
	IVIDd(Z-Score)	/	
	UT L	Uterine Length	Distance, Trace and Spline in 2D General Measurements
	UT H	Uterine Height	
	UT W	Uterine Width	
	Endo.	Endometrium Thickness	
	AH	Lateral Ventricle Anterior	
	PH	Lateral Ventricle Posterior	
	3rd Ventricle	/	
	NT Above Cord	/	
	NT Below Cord	/	
	Mandible	/	
	Prenasal th	Prenasal thickness	
	Heart (AP)	Heart Anterior-Posterior	
	Heart (T)	Heart Transverse	
	LV Width	Left Ventricular Width	Distance in 2D General Measurements
	LV Length	Left Ventricular Length	
	RV width	Right Ventricular Width	
	RV Length	Right Ventricular Length	
	RA width	Right Atrium Width	
	LA width	Left Atrium Width	
	LVWd	Left Ventricular Wall Thickness at End-diastole	
	LVWs	Left Ventricular Wall Thickness at End-systole	
	RVWd	Right Ventricular Wall Thickness at End-diastole	
	RVWs	Right Ventricular Wall Thickness at End-systole	
	CSP	Cavum Septum Pellucidum	Distance in 2D General Measurements

Types	Tools	Descriptions	Methods or formulae
	FMF	Frontomaxillary facial angle	Angle in 2D General Measurements
	MMF	Mandibulomaxillary facial angle	
	Lung CCAM L	Lung Congenital Cystic Adenomatoid Malformation Length	Distance in 2D General Measurements
	Lung CCAM H	Lung Congenital Cystic Adenomatoid Malformation Height	
	Lung CCAM W	Lung Congenital Cystic Adenomatoid Malformation Width	
	AD	Abdominal Diameter	
	Liac Wing Angle	/	Angle in 2D General Measurements
	FAGL	Fetal Adrenal Gland length	Distance in 2D General Measurements
	FAG	Fetal Adrenal Gland	Area in 2D General Measurements
	Intestinum Crassum	/	Distance in 2D General Measurements
	Liver Length	/	
	Rib Length	/	
	Shoulder Blade	/	
	AV Area	Aorta Valve Area	Area in 2D General Measurements
	PV Area	Pulmonary Valve Area	
	AC (c)	/	Cross for area in 2D General Measurements $AC(c) = \pi(TAD+APAD)/2$
	Calculation	Mean Sac Diam	Mean Gestational Sac Diameter
AFI		/	Measure the maximum AFs of the four amniotic fluid pockets of pregnant woman. $AFI = AF1+AF2+AF3+AF4$
EFW		Estimated Fetal Weight 1	EFW is calculated by the default EFW formula, based on multiple measured parameters. See "2.3.1 Obstetric Formula." The formula can be reselected in the OB report.
EFW2		Estimated Fetal Weight 2	
HC/AC		/	HC/AC

Types	Tools	Descriptions	Methods or formulae
	FL/AC	/	FL/AC×100
	FL/BPD	/	FL/BPD ×100%
	AXT	/	APTD × TTD
	CI	/	BPD/OFD ×100%
	FL/HC	/	FL/AC×100
	HC(c)	/	$HC(c) = 2.325 \times (BPD^2 + OFD^2)^{1/2}$
	HrtC/TC	/	HrtC/TC
	TCD/AC	/	TCD/AC
	LVW/HW	/	LVW/HW × 100%
	LVD/RVD	/	LV Diam/RV Diam
	LAD/RAD	/	LA Diam/RA Diam
	AoD/MPAD	/	Ao Diam/MPA Diam
	LAD/AoD	/	LA Diam/Ao Diam
	UT Vol.	UT Volume	See “UT Vol” in 8.4.2
	Uterus Body	/	See “Uterus Body” in 8.4.2
UT-L/ CX-L	/	See “UT-L/ CX-L” in 8.4.2	
Study	AFI	/	Measures AF1, AF2, AF3, AF4, calculates AFI
	Uterus	/	See “Uterus” in 8.4.3

M Obstetric Measurements

Types	Tools	Descriptions	Methods or formulae
Measurement	OB_FHR(M)	Fetal Heart Rate	Heart Rate in M General Measurements
	LVIDd	Left ventricular short-axis diameter at end diastole	Distance in 2D General Measurements
	LVIDs	Left ventricular short-axis diameter at end systole	
	RVIDd	Right ventricular short-axis diameter at end diastole	
	RVIDs	Right ventricular short-axis diameter at end systole	
	IVSd	interventricular septal thickness at end diastole	

Types	Tools	Descriptions	Methods or formulae
	IVSs	interventricular septal thickness at end systole	
	RVIDd(Z-Score)	/	
	LVIDd(Z-Score)	/	
	MVE	Mitral Valve Extent	
	TVE	Tricuspid Valve Extent	
	TAPSE	Tricuspid Annular Plane Systolic Excursion	Distance in M General Measurements
	MAPSE	Mitral Annular Plane Systolic Excursion	
	AVE	Aorta Valve Extent	
	LV ICT	LV Isovolumil Contraction Time	
	LV IRT	LV Isovolumic Relaxation Time	Time in M General Measurements
	LV ET	LV Ejection Time	The system calculates TEI index automatically. $\text{Tei index} = \frac{(\text{ICT} + \text{IRT})}{\text{ET}}$
	RV ICT	RV Isovolumil Contraction Time	
	RV IRT	RV Isovolumic Relaxation Time	
	RV ET	RV Ejection Time	
Calculation	/	/	
Study	/	/	

Doppler Obstetric Measurements

Types	Tools	Descriptions	Methods or formulae
Measurement	Umb A	Umbilical Artery	D trace in General D measurements
	Placenta A	Placenta Artery	
	MCA	Middle Cerebral Artery	
	Fetal Ao.	Fetal Aorta	
	Desc. Aorta	Descending Aorta	
	Ut. A	Uterine Artery	
	Ovarian A	Ovarian Artery	

Types	Tools	Descriptions	Methods or formulae
	Duct. Veno	Ductus Venosus	D trace in General D measurements Acquire Duct Venosus D by 3-PT method to measure peak value of ventricular systole (S), peak value of early diastole (D) and minimum value of atrial contraction (a).
	OB_FHR(Doppler)	Fetal Heart Rate	HR in General D measurements
	Asc. Aorta	Ascending Aorta	
	RVOT	Right Ventricle Outflow Tract	D Trace in General D measurements
	LVOT	Left Ventricle Outflow Tract	
	MV E	Mitral Valve E-wave	D Vel. in Doppler General Measurements
	MV A	Mitral Valve A-wave	
	TV E	Tricuspid Valve E-wave	These measurement items should be performed on Doppler mode
	TV A	Tricuspid Valve A-wave	
	MV E'	Mitral Valve E'-wave	
	MV A'	Mitral Valve A'-wave	D Vel. in Doppler General Measurements
	MV S'	Mitral Valve S'-wave	
	TV E'	Tricuspid Valve E'-wave	These measurement items should be performed on TDI mode
	TV A'	Tricuspid Valve A'-wave	
	TV S'	Tricuspid Valve S'-wave	
	AV PV	Aorta Valve Peak velocity	
	AV VTI	Aorta Valve Flow velocity integral	
	PV PV	Pulmonary Valve Peak velocity	
	PV VTI	Pulmonary Valve Flow velocity integral	D Trace in General D measurements
	Duct Art PV	Duct Art Peak velocity	
	Duct Art VTI	Duct Art Flow velocity integral	
	Thoracic Aorta	/	
	Hepatic Vein	/	
	IVC	Inferior Vena Cava	
	Umb V	Umbilical vein	D Vel. in Doppler General Measurements
	Ovary	/	D Trace in General D

Types	Tools	Descriptions	Methods or formulae
	Endometrium	/	measurements
	Cervical Cancer	/	
	Fibroid	/	
	Duct Art	Ductus Arteriosus	
	ICA	Internal Carotid Artery	
	Celiac A	Celiac Artery	
Calculation	MV E/A	Mitral Valve E-Vel./A-Vel.	$MV E/A = MV E \text{ Vel. (cm/s)} / MV A \text{ Vel. (cm/s)} $
	TV E/A	Tricuspid Valve E-Vel./A-Vel.	$TV E/A = TV E \text{ Vel(cm/s)} / TV A \text{ Vel(cm/s)} $
	MV E/E'	Mitral Valve E-Vel./E'-Vel.	$MV E/E' = MV E \text{ Vel. (cm/s)} / MV E' \text{ Vel. (cm/s)} $
	TV E/E'	Tricuspid Valve E-Vel./E'-Vel.	$TV E/E' = TV E \text{ Vel(cm/s)} / TV E' \text{ Vel(cm/s)} $
Study	/	/	/

5.5 Obstetric Measurement Operations

Operations of measurement, calculation and study are described using examples.

- Tip:**
1. See the table in “5.4 Obstetric Measurement Tools” above for measurement tools and methods.
 2. For the definitions of measurement, calculation and study, see “1.3 Measurement, Calculation and Study.”
 3. The order of the measurement items can be preset. See “2.4.2 Application Measurement Preset” for details.
 4. A measurement tool can be activated by clicking the item in the measurement menu or on the touch screen. It is described as “Select/Click ... in the measurement menu” in the following procedures.

5.5.1 Measurement Tool Operations

Take the HC measurement as an example.

1. Select the [HC] item/tool in the measurement menu or the touch screen.
See “Select Measurement Method” for details on how to select a method online.
2. Measure the area according to the Area method in 2D General Measurements.
The measurement results, GA calculation and OB growth percentile display in the results window.
You can preset whether to display the EDD or not in [System Preset] → [OB] → [Fetal Gestational Age].

For more details about GA, see “5.3 GA.”

■ Auto OB Measurement (Smart OB)

There is an auto measurement method for commonly-used OB measurement items (BPD, HC, AC, FL, HUM, OFD, NT and etc.). The procedure is as follows:

1. Scan the proper image.
2. Select the OB measurement item from the menu and select the [Auto] method.
3. The measurement caliper is drawn on the image automatically.
You can rotate the trackball to modify the caliper if the result of the auto measurement does not match the image exactly.
4. Press <Set> to confirm the measurement.
Or, press <Update>/<Clear> to modify the caliper for a more accurate result.

5.5.2 Calculation Tool Operations

Take the HC/AC measurement as an example.

1. Select the [HC/AC] item/tool in the measurement menu or the touch screen.
2. Measure the HC and AC according to the Area method in 2D General Measurements.
The second measurement is activated automatically when the first one is completed. The results display in the results window after measurement.

5.5.3 Study Tool Operations

The operation of the AFI measurement is as follows:

1. Select [AFI] in the measurement menu or the touch screen. Enter the submenu.
2. Measure the maximum AFs of the four amniotic fluid pockets of pregnant woman. The AFI is calculated automatically.

5.6 Multi-Fetus Exam

The system allows multi-fetus examination (4 at most).

NOTE: Ensure that the fetus displayed in the multi-fetus measurement menu is the one on which you intend to perform the measurements.

In a similar way to the OB measurement:

1. Set the number of fetuses in [Gestations] via [Info] → [OB].
If [Gestations] is set to be more than 1, the [Fetus] widget displays in the OB measurement menu (and on the touch screen), as shown in the figure below.



(in the menu)

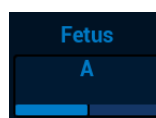

(on the touch screen)

You can switch between [Fetus A], [Fetus B], [Fetus C] or [Fetus D] via the widget (or the [Fetus] button on the touch screen).

2. Carry out the measurement of the fetus respectively.
The measurement results in the results window are marked with fetus label A, B, C or D.

1	HC(A)	10.64 cm	35.9 %
	GA	15w0d ±1w1d	
2	HC(B)	10.89 cm	45.6 %
	GA	15w2d ±1w1d	

3. In the Obstetric report, select [Fetus A], [Fetus B], [Fetus C] or [Fetus D] to switch between the results for different fetuses.
 4. Touch [Fetus Compare] on the touch screen to see a visualized comparison result.
 5. In the [OB Graph] dialog box, select [A], [B], [C] or [D] on the left to display the growth curves of the different fetuses.
 - Data of Fetus: different symbols are used on the growth curves to identify measurement data of different fetuses.
 - Historic/current data: symbol size is used to differentiate, with historic data appearing in smaller symbols.
- Tip: you can select whether to print multi-fetus data in one report via [Report]->[Setting].

5.7 Obstetric Exam Report

During or after a measurement, Click [Report] on the touch screen to browse the report.

See “5.6 Multi-Fetus Exam” for multi-fetus exam reports.

For details about report browsing, printing and exporting, etc., see “1.7 Report.”

5.7.1 Fetal Biophysical Profile

Fetal Biophysical Profile means to first obtain a few indices related to fetal growth through experiment or measurement and then evaluate the hazardous situation that the fetus is facing by grading these indices respectively.

1. Under OB report status, touch [Analyze] on the touch screen, the fetus Score is listed after the fetal analysis.

The scoring criteria the system provides are based on the Vintzileos formula, as shown in the table below.

Fetal growth index	Score 0	Score 2	Observation time	Remarks
FHR	<2, or Reactive FHR ≤15 bpm	Reactive FHR ≥ 15 bpm, duration ≥ 15s, ≥ 2 times	30 minutes	The score(s) can be manually entered into the system.
FM	≥ 2 fetal movements	FM ≥ 3 times (continuous movement is deemed as 1 time)	30 minutes	
FBM	No FBM or duration ≤ 30s	FBM ≥ 1 times; duration ≥ 30s	30 minutes	
FT	Limbs stretch, no bend, fingers loose	Limbs and spine stretch/bend ≥ 1 times	/	
AF	No AF, or AF volume < 2 × 2 cm	One or more AF volumes > 2 × 2 cm	/	

Fetal scoring results criteria:

Total scores	Growth condition
8-10	Normal, chronic asphyxia risk low
4-6	Chronic asphyxia risk suspicious
0-2	Chronic asphyxia risk high

2. The scores of each index as well as the total score will be appended to the report.

5.7.2 Comparison Bar

This function compares the clinical GA, the ultrasound GA obtained from OB measurements and the AUA (CUA).

1. Enter the patient's basic information and obstetric information in the [Patient Info] → [OB] dialog box.
2. Perform one or more GA related parameter tools.
3. Under report status, touch [Compare Bar] on the touch screen to bring up the following figure.



- Select the [Print] checkbox to determine whether to include the bar in the printed report or not.

5.7.3 Z-Score

As the FL, BPD and GA are most relevant to the fetus cardiac structure and the Z-Score regression equation is related to the natural logarithm value of the FL, BPD and GA variables, the Z-Score of cardiac structures can be obtained by looking at the Z-Score table, which is important in fetus cardiac growth evaluation and intrauterine interventional therapy.

$$\ln(\text{predicted cardiac dimension}) = m \cdot \ln(\text{FL, GA or BPD}) + c$$

$$\text{Z-Score} = (\ln(\text{actual}) - \ln(\text{predicted cardiac dimension})) / \text{root MSE}$$

Where the unit of FL and BPD is cm, GA is week, m is multiplier, c is intercept and root MSE is root-mean-square error, which can be obtained from the table.

1. Enter the patient's basic information and obstetric information in the [Patient Info] → [OB] dialog box.
2. Measure the BPD and FL.
3. Select Z-Score parameters (with Z-Score tag in the name) from the measurement menu.
4. Open the report to check the Z-Score result.

Tip: the Z-Score study is effective for fetuses aged 15~40 weeks.

5.7.4 Fetal Growth Curve

The fetus growth curve compares the measured data of the fetus with the normal growth curve to judge whether the fetus is in normal growth state. The growth curve data is sourced from the Fetal Growth Table.

1. Enter patient information and obstetric information in [Patient Info] → [OB] dialog box.
2. Perform one or more fetal growth parameter tools.
3. Touch [OB Graph] on the report touch screen to display the Obstetric Growth Curve dialog box. The dialog box displays the growth curve and the position of the measurement value.

- Two drop-down lists above the curve display the measurement item/tool and the formula of the curve, which can be changed.
 - Different symbols are used on the growth curves to identify measurement data of different fetuses.
 - Current and historic data of a fetus are displayed in the same symbols, with the historic data appearing in smaller symbols.
 - Click the [Print] checkbox to determine whether to include the growth curve in the printed report or not.
 - The green dotted line indicates the clinical GA on the X-axis.
 - Select the number and layout of the curves from [Display Layout].
 - 1*1: one curve displays in the screen.
 - 2*1: two curves (up/down) display in the screen.
 - 2*2: four curves display in the screen.
 - Click [Previous]/[Next] to turn the growth curve pages.
4. Click [Save] to confirm the setting and exit the page.

Tip: If the patient ID is blank, the clinical GA is not calculated or the measurement value is not valid, the measurement values will not be displayed on the curve.

5.8 References

GS

Rempen A., 1991

Arztliche Fragen. Biometrie in der Frühgraviditat (i. Trimenon): 425-430.

Hansmann M., Hackelöer B.J., Staudach A.

Ultraschalldiagnostik in Geburtshilfe und Gynäkologie 1985

Hellman L.M., Kobayashi M., Fillisti L., et al. Growth and development of the human fetus prior to the 20th week of gestation. Am J Obstet Gynecol 1969; 103:784-800.

Studies on Fetal Growth and Functional Developments, Takashi Okai, Department of Obstetrics and Gynecology, Faculty of Medicine, University of Tokyo

China

Written by Zhou Yiongchang & Guo Wanxue

in Chapter 38 of "Ultrasound Medicine" (3rd edition) Science & Technology Literature Press, 1997

Daya S., Wood S., Ward S., et al. Early pregnancy assessment with transvaginal ultrasound scanning Can Med Assoc J, 1991;144(4):441-446

CRL

Rempen A., 1991
Arztliche Fragen. Biometrie in der Fruhgraviditat (i. Trimenon): 425-430.

Hansmann M., Hackelöer B.J., Staudach A.
Ultraschalldiagnostik in Geburtshilfe und Gynäkologie 1985

Hadlock F.P., et al. *Fetal Crown-Rump Length: Reevaluation of Relation to Menstrual Age (5-18 weeks) with High-Resolution Real-time US. Radiology 182:501-505.*

Jeanty P., Romero R. *Obstetrical Sonography*, p. 56. New York, McGraw-Hill, 1984.

Nelson L. *Comparison of methods for determining crown-rump measurement by realtime ultrasound. J Clin Ultrasound February 1981; 9:67-70.*

Robinson H.P., Fleming J.E. *A critical evaluation of sonar crown rump length measurements. Br J Obstetric and Gynaecologic September 1975; 82:702-710.*

Fetal Growth Chart Using the Ultrasonotomographic Technique
Keiichi Kurachi, Mineo Aoki
Department of Obstetrics and Gynecology, Osaka University Medical School
Revision 3 (September 1983)

Studies on Fetal Growth and Functional Developments
Takashi Okai Department of Obstetrics and Gynecology, Faculty of Medicine, University of Tokyo

Pam Loughna¹, Lyn Chitty, Tony Evans, Trish Chudleigh. *Fetal size and dating: charts recommended for clinical obstetric practice. British Medical Ultrasound Society. ULTRASOUND August 2009 Volume 17 Number 3*

China

Written by Zhou Yiongchang & Guo Wanxue

in Chapter 38 of "Ultrasound Medicine" (3rd edition) Science & Technology Literature Press, 1997

Ultrasonic fetal Measurement Standards for an Australian Population, compiled by Susan Campbell Westerway - Faculty of Health Sciences University of Sydney

<http://www.asum.com.au/open.home.htm> Date: December 2003

BPD

Merz E., Werner G. & Ilan E. T. "Ultrasound in Gynecology and Obstetrics" *Textbook and Atlas 312, 326-336. 1991 Georg Thieme Verlag, pp.326~327*

Rempen A., 1991 *Arztliche Fragen. Biometrie in der Fruhgraviditat (i. Trimenon): 425-430.*

Hansmann M., Hackelöer B.J., Staudach A. Ultraschalldiagnostik in Geburtshilfe und Gynäkologie 1985

Jeanty P., Romero R. "Obstetrical Ultrasound." McGraw-Hill Book Company, 1984, pp. 57-61.

Sabbagha R.E., Hughey M. Standardization of sonar cephalometry and gestational age. Obstetrics and Gynecology October 1978; 52:402-406.

Kurtz A.B., Wapner R.J., Kurtz R.J., et al. Analysis of biparietal diameter as an accurate indicator of gestational age. J Clin Ultrasound 1980;8:319-326.

Fetal Growth Chart Using the Ultrasonotomographic Technique, Keiichi Kurachi, Mineo Aoki, Department of Obstetrics and Gynecology, Osaka University Medical School Revision 3 (September 1983)

Studies on Fetal Growth and Functional Developments, Takashi Okai, Department of Obstetrics and Gynecology, Faculty of Medicine, University of Tokyo

Chitty L.S., Altman D.G. British Journal of Obstetrics and Gynaecology January 1994, Vol.101 P29-135.

China

Written by Zhou Yiongchang & Guo Wanxue

in Chapter 38 of "Ultrasound Medicine" (3rd edition) Science & Technology Literature Press, 1997

Altmann D.G.; Chitty L.S. New charts for ultrasound dating of pregnancy Obstetrics and Gynecology Vol. 10: 174-191, 1997

Hadlock F.P., et al. Estimating Fetal Age: Computer-Assisted Analysis of Multiple Fetal Growth Parameters. Radiology 1984;152: 497-501

Hansmann, Hackeloer, Staudach, Wittmann. Ultrasound Diagnosis in Obstetrics and Gynecology. Springer-Verlag, New York, 1985

Jeanty P., Cousaert E., Hobbins J.C., Tack B., Bracken M., Cantraine F. A longitudinal Study of fetal head biometry. American Journal of Perinatology; Volume1; Number 2; January 1984; pages 118-128

R. J. M. Snijders and K. H. Nicolaidis. Fetal biometry at 14-40 weeks' gestation. Ultrasound Obstet. Gynecol. 4 (1994) 34-48

Norio Shinozuka, Takashi Okai, Masahiko Mizuno. Issued by Shindan & Tiryō Sya Tokyo University, School of Medicine, OB/GYN dept. How to interpret OB/GYN ultrasound measurement data. 80. Fetal Measurement Obstetrics & Gynecology Chapter 56 Separate volume; 1989, Oct. 27th

Publication

OFD

Merz E., Werner G. & Ilan E. T., 1991
Ultrasound in Gynecology and Obstetrics Textbook and Atlas 312, 326-336.

Hansmann M., Hackelöer B.J., Staudach A.
Ultraschalldiagnostik in Geburtshilfe und Gynäkologie 1985

Jeanty P., Coussaert E., Hobbins J.C., Tack B., Bracken M., Cantraine F., "A longitudinal study of fetal head biometry" *American Journal of Perinatology; Volume 1; Number 2; January 1984*

Ultrasonic fetal Measurement Standards for an Australian Population. compiled by Susan Campbell Westerway - Faculty of Health Sciences University of Sydney <http://www.asum.com.au/open.home.htm> Date: December 2003

Hansmann, Hackelöer, Staudach, (Wittmann). Ultrasound Diagnosis in Obstetrics and Gynecology. Springer- Verlag, New York, 1986, p.433

R. J. M. Snijders and K. H. Nicolaidis. Fetal biometry at 14-40 weeks' gestation. Ultrasound Obstet. Gynecol. 4 (1994) 34-48

HC

Merz E., Werner G. & Ilan E. T., 1991
Ultrasound in Gynecology and Obstetrics Textbook and Atlas 312, 326-336.

Jeanty P., Romero R. "Obstetrical Ultrasound." McGraw-Hill Book Company, 1984.

Hadlock F.P., et al. *Estimating Fetal Age: Computer-Assisted Analysis of Multiple Fetal Growth Parameters. Radiology 1984; 152 (No. 2):499.*

Hansmann M., Hackelöer B.J., Staudach A.
Ultraschalldiagnostik in Geburtshilfe und Gynäkologie 1985

Chitty L.S., Altman D.G.
British Journal of Obstetrics and Gynaecology January 1994, Vol.101 P29-135.

Chitty L.S., Altman D.G., Hendesson A., Campell S., *Charts of fetal size: 2 Head measurements, Br J Obstetric Gynecology 1994, Vol 101, P 35-43.*

Altmann D.G.; Chitty L.S. "New charts for ultrasound dating of pregnancy" *Ultrasound in Obstetrics and Gynecology Vol. 10: 174-191, 1997*

Jeanty P., Coussaert E., Hobbins J.C., Tack B., Bracken M., Cantraine F., "A longitudinal study of fetal head biometry" *American Journal of Perinatology; Volume 1; Number 2; January 1984*

Ultrasonic fetal Measurement Standards for an Australian Population. compiled by Susan Campbell Westerway - Faculty of Health Sciences

University of Sydney <http://www.asum.com.au/open.home.htm> Date:
December 2003

R. J. M. Snijders and K. H. Nicolaidis. Fetal biometry at 14-40 weeks' gestation. *Ultrasound Obstet. Gynecol.* 4 (1994) 34-48

AC

Merz E., Werner G. & Ilan E. T., 1991
Ultrasound in Gynecology and Obstetrics Textbook and Atlas 312, Georg Thieme Verlag, 326-336.

Hadlock F.P., et al. Estimating Fetal Age: Computer-Assisted Analysis of Multiple Fetal Growth Parameters. *Radiology* 1984; 152 (No. 2):499.

Jeanty P., Romero R. A longitudinal study of fetal abdominal growth, "Obstetrical Ultrasound." MacGraw-Hill Book Company, 1984.

Chitty L.S., Altman D.G.

British Journal of Obstetrics and Gynaecology January 1994, Vol.101
P29-135.

Ultrasonic fetal Measurement Standards for an Australian Population.
compiled by Susan Campbell Westerway - Faculty of Health Sciences
University of Sydney <http://www.asum.com.au/open.home.htm> Date:
December 2003

Crequat, J., Duyme, M., Brodaty, G. *Biometry 2000. Fetal growth charts by the French College of fetal ultrasonography and the Inserm U 155.*
Gynecol.Obstet Fertil., Vol. 28 No. 2, 2000, pages 435-455

Chitty L.S. Altman D.G. Hendesson A. Campell S. *Charts of fetal size: 3. Abdominal measurements. Br J Obstetric Gynaecology* 1994, Vol 101, pages 35-43.

Chitty, L.S., Altman, D.G., Henderson, A., Campbell, S. *Charts of fetal size: 3. Abdominal measurements Br.J.Obstet.Gynaecol.* Vol. 101 No. 2, 1994, pages 125-131

Hansmann, Hackeloer, Staudach, Wittmann. *Ultrasound Diagnosis in Obstetrics and Gynecology* Springer- Verlag, New York, 1986, p.431.

Jeanty P., Cousaert E., Cantraine F. *Normal Growth of the Abdominal Perimeter. American Journal of Perinatology; Volume 1 Number 2; January 1984;*
pages 129-135

R. J. M. Snijders and K. H. Nicolaidis. Fetal biometry at 14-40 weeks' gestation. *Ultrasound Obstet. Gynecol.* 4 (1994) 34-48

FL

Merz E., Werner G. & Ilan E. T., 1991
Ultrasound in Gynaecology and Obstetrics Textbook and Atlas 312, 326-336.

Hansmann M., Hackelöer B.J., Staudach A.

Ultraschalldiagnostik in Geburtshilfe und Gynäkologie 1995

Hadlock F.P., et al. Estimating Fetal Age: Computer-Assisted Analysis of Multiple Fetal Growth Parameters. Radiology 1984; 152 (No. 2):499.

*Warda A. H., Deter R. L. & Rossavik, I. K., 1985.
Fetal femur length: a critical re-evaluation of the relationship to menstrual age. Obstetrics and Gynaecology, 66,69-75.*

*O'Brien G.D., Queenan J.T. (1981)
Growth of the ultrasound femur length during normal pregnancy,
American Journal of Obstetrics and Gynecology 141:833-837.*

*Jeanty P., Rodesch F., Delbeke D., Dumont J. Estimation of gestational age from
measurements of fetal long bones. Journal of Ultrasound Medicine
February 1984; 3:75-79.*

Hohler C., Quetel T. Fetal femur length: equations for computer calculation of gestational age from ultrasound measurements. American Journal of Obstetrics and Gynecology June 15, 1982; 143 (No. 4):479-481.

*Keiichi Kurachi, Mineo Aoki
Department of Obstetrics and Gynecology, Osaka University Medical
School
Revision 3 (September 1983)*

*Studies on Fetal Growth and Functional Developments
Takashi Okai Department of Obstetrics and Gynecology, Faculty of
Medicine, University of Tokyo*

*Chitty L.S., Altman D.G.
British Journal of Obstetrics and Gynaecology January 1994, Vol.101
P29-135.*

Jeanty P., Cousaert E., Cantraine F., Hobbins J.C., Tack B., Struyven J. "A longitudinal Study of fetal limb growth" American Journal of Perinatology; Volume 1; Number 2; January 1984;136-144

*Jeanty P., Rodesch F., Delbeke D., Dumont J. "Estimation of Gestational Age from
Measurements of Fetal Long Bones" Journal of Ultrasound Medicine, 3: 75-79, February, 1984*

China

Written by Zhou Yiongchang & Guo Wanxue in Chapter 38 of "Ultrasound Medicine" (3rd edition) Science & Technology Literature Press, 1997

ASUM

Ultrasonic fetal Measurement Standards for an Australian Population, compiled by Susan Campbell Westerway - Faculty of Health Sciences University of Sydney. <http://www.asum.com.au/open/home.htm> Date:

December 2003

R. J. M. Snijders and K. H. Nicolaidis; Fetal biometry at 14-40 weeks' gestation *Ultrasound Obstet. Gynecol.* 4 (1994) 34-48

- TAD** Merz E., Werner G. & Ilan E. T., 1991
Ultrasound in Gynaecology and Obstetrics Textbook and Atlas 312, 326-336.
- APAD** Merz E., Werner G. & Ilan E. T., 1991
Ultrasound in Gynecology and Obstetrics Textbook and Atlas 312, 326-336.
- THD** Hansmann M., Hackelöer B.J., Staudach A.
Ultraschalldiagnostik in Geburtshilfe und Gynäkologie 1985
- FTA** *Fetal Growth Chart Using the Ultrasonotomographic Technique*
Keiichi Kurachi, Mineo Aoki
Department of Obstetrics and Gynecology, Osaka University Medical School
Revision 3 (September 1983)
- HUM** Merz E., Werner G. & Ilan E. T., 1991
Ultrasound in Gynaecology and Obstetrics Textbook and Atlas 312, 326-336.
- Jeanty P., Rodesch F., Delbeke D., Dumont J. Estimation of gestational age from measurements of fetal long bones. *Journal of Ultrasound Medicine* February 1984; 3:75-79.
- Jeanty P., Cousaert E., Cantraine F., Hobbins J.C., Tack B., Struyven J. "A longitudinal Study of fetal limb growth" *American Journal of Perinatology*; Volume 1; Number 2; January 1984;136-144
- Ultrasonic fetal Measurement Standards for an Australian Population, compiled by Susan Campbell Westerway - Faculty of Health Sciences University of Sydney. <http://www.asum.com.au/open/home.htm> Date: December 2003*
- CLAV** "Clavicular Measurement: A New Biometric Parameter for Fetal Evaluation." *Journal of Ultrasound in Medicine* 4:467-470, September 1985.
- TCD** Goldstein I., et al. Cerebellar measurements with ultrasonography in the evaluation of fetal growth and development. *Am J Obstet Gynecol* 1987; 156:1065-1069.
- Hill L.M., et al. Transverse cerebellar diameter in estimating gestational age in the large for gestational age fetus, *Obstet Gynecol* 1990; 75:981-985.
- R. J. M. Snijders and K. H. Nicolaidis; Fetal biometry at 14-40 weeks' gestation *Ultrasound Obstet. Gynecol.* 4 (1994) 34-48
- GS** Hellman LM, Kobayashi M, Fillisti L, et al. Growth and development of the human fetus prior to the twentieth week of gestation. *Am J Obstet Gynecol*, 1969;103(6):789-800
- Ulna** Merz E., Werner G. & Ilan E. T., 1991

Ultrasound in Gynaecology and Obstetrics Textbook and Atlas 312, 326-336.
Jeanty P., Rodesch F., Delbeke D., Dumont J., "Estimation of Gestational Age from Measurements of Fetal Long Bones." *J Ultrasound Med 3:75-79, 1984*

Jeanty P., Cousaert E., Cantraine F., Hobbins J.C., Tack B., Struyven J. "A longitudinal Study of fetal limb growth" *American Journal of Perinatology; Volume 1; Number 2; January 1984;136-144*

Tibia

Merz E., Werner G. & Ilan E. T., 1991
Ultrasound in Gynaecology and Obstetrics Textbook and Atlas 312, 326-336.

Jeanty P., Rodesch F., Delbeke D., Dumont J., "Estimation of Gestational Age from Measurements of Fetal Long Bones." *J Ultrasound Med 3:75-79, 1984*

Jeanty P., Cousaert E., Cantraine F., Hobbins J.C., Tack B., Struyven J. "A longitudinal Study of fetal limb growth" *American Journal of Perinatology; Volume 1; Number 2; January 1984;136-144*

RAD

Merz E., Werner G. & Ilan E. T., 1991
Ultrasound in Gynecology and Obstetrics Textbook and Atlas 312, 326-336.

Fetal Limb Bimetry (Letter), Radiology 147:602, 1983

FIB

Merz E., Werner G. & Ilan E. T., 1991
Ultrasound in Gynaecology and Obstetrics Textbook and Atlas 312, 326-336.

Fetal Limb Bimetry (Letter), Radiology 147:602, 1983

OOD

Jeanty P., Cantraine R., Cousaert E., et al. *The Binocular Distance: A New Way to Estimate Fetal Age. J Ultrasound Med 1984; 3: 241-243.*

Ultrasound GA

Hadlock, Radiology, 1984 152:497-501

Cist Magna

R. J. M. Snijders and K. H. Niicolaides. Fetal biometry at 14-40 weeks' gestation. Ultrasound Obstet. Gynecol. 4 (1994) 34-48

FL/HC (Hadlock)

Hadlock, F.P., Harrist, R.B., Shah, Y., Park, S.K., "The femur length/head circumference relation in obstetric sonography" J Ultrasound Med 1984, 3: 439-442 (Fetal Growth)

HC/AC(Campbell)

Campbell S., "Ultrasound Measurement of Fetal Head and Abdomen Circumference Ratio in the Assessment of Growth Retardation". Obstetrics and Gynaecology, Vol 84, 165- 174, March 1977

Estimated Fetal Weight (EFW)

Merz E., Werner G. & Ilan E. T., *Ultrasound in Gynaecology and Obstetrics. Textbook and Atlas* 1991 Georg Thieme Verlag, 308-338

Hansmann M., Hackelöer B.J., Staudach A., *Ultraschalldiagnostik in Geburtshilfe und Gynäkologie* 1995

Campbell S., Wilkin D. "Ultrasonic Measurement of Fetal Abdomen Circumference in the Estimation of Fetal Weight." *Br J Obstetrics and Gynaecology* September 1975; 82 (No. 9):689-697.

Hadlock F.P., Harrist R., et al. Estimation of fetal weight with the use of head, body, and femur measurements - a prospective study. *American Journal of Obstetrics and Gynecology* February 1, 1985; 151 (No. 3):333-337.

Shepard M., Richards V., Berkowitz R., Warsof S., Hobbins J. An Evaluation of Two Equations for Predicting Fetal Weight by Ultrasound. *American Journal of Obstetrics and Gynecology* January 1982; 142 (No. 1): 47-54.

Fetal Growth Chart Using the Ultrasonotomographic Technique, Keiichi Kurachi, Mineo Aoki
Department of Obstetrics and Gynecology, Osaka University Medical School Revision 3
(September 1983)

Studies on Fetal Growth and Functional Developments, Takashi Okai Department of Obstetrics and Gynecology, Faculty of Medicine, University of Tokyo

Brenner W.E., Edelman D.A., Hendricks C.H. A standard of fetal growth for the United States of America. VOL. 91, NO. 6, JUNE 1998

Hadlock F.P., Harrist R., Martinez-Poyer J. In utero analysis of fetal growth: A sonographic standard. *Radiology* 1991;181:129-133

Ronald Williams, Robert Creasy, George Cunningham, Warren Hawes, Rank Norris, Michiko Tashiro. *Fetal Growth and Perinatal Viability in California*. *Obstetric & Gynecology* Vol. 59, NO. 5, May 1982

Hansmann, Hackelöer, Staudach, Wittmann. *Ultrasound Diagnosis in Obstetrics and Gynecology*. Springer-Verlag, New York, 1986

Shinozuka N., Okai T., Kohzuma S., Mukubo M., Shih C.T., Maeda T., et al. Formulas for Fetal Weight Estimation by Ultrasound Measurements based on Neonatal Specific Gravities and Volumes. *American Journal of Obstetrics and Gynecology* 157: 1140-1145; 1987

Hadlock FP, et al, "Sonographic Estimation of Fetal Weight", *Radiology* 1984:150:535-540

Fetal Biophysical Profile

Manning FA. *Dynamic ultrasound-based fetal assessment: the fetal biophysical profile score*. Women's Hospital, Department of Obstetrics and Gynecology, Winnipeg, Manitoba, Canada.

Dynamic ultrasound-based fetal Assessment: The Fetal Biophysical Profile Score, *Clinical obstetrics and gynecology*, Manning FA,38:26-44,1995a.

Weight Percentile for Age

Hadlock F.P., Harrist R., Martinez-Poyer J. In utero analysis of fetal growth: A sonographic standard. Radiology 1991;181:129-133.

AFI

Thomas R., Moore M.D., Jonathan E., Cayle M.D. The amniotic fluid index in normal human pregnancy. American Journal of Obstetrics and Gynecology May 1990; 162: 1168-1173.

Z-Score

Schneider C. et. al., "Development of Z-scores for fetal cardiac dimensions from echocardiography", Ultrasound Obstet Gynecol. Vol. 26, 2005: 599-605.

CI

Hadlock, F., Deter, R., Carpenter, R., Park, D. Estimating Fetal Age: effect of Head Shape on BPD. American Journal of Roentgenology, 137: 83-85, July 1981

FL/AC

Hadlock F., Deter R., Harrist R., Roecker E., Park S. A Date-Independent Predictor of Intrauterine Growth Retardation: Femur Length/Abdominal Circumference Ratio American Journal of Roentgenology, 141:979-984, November 1983

FL/HC(Hadlock)

Hadlock, F.P., Harrist, R.B., Shah, Y., Park, S.K. The femur length/head circumference relation in obstetric sonography. J Ultrasound Med 1984, 3: 439-442 (Fetal Growth)

HC/AC(Campbell)

Campbell S. Ultrasound Measurement of Fetal Head and Abdomen Circumference Ratio in the Assessment of Growth Retardation. Obstetrics and Gynaecology, Vol 84, 165- 174, March 1977

FL/BPD

Hohler C.W., Quetel, T.A: Comparison of Ultrasound Femur Length and Biparietal Diameter in Late pregnancy. American Journal of Obstetrics and Gynecology, volume 14, No. 7: 759-762, 1-Dec.-1981

Ut A RI/MCA RI

Kurmanavicius J., Florio I., Wisser J., Hebisch G., Zimmermann R., Muller R. et al. Reference resistance indices of the umbilical, fetal middle cerebral and uterine arteries at 24-42 weeks of gestation. Ultrasound Obstet. Gynecol. 1997;10:112-20.

Duct Venosus

A. A. BASCHAT. Relationship between placental blood flow resistance and precordial venous Doppler indices. Ultrasound Obstet Gynecol 2003; 22: 561–566

IT

Bunduki V, Ruano R, Miguelez J, Yoshizaki CT, Kahhale S, Zugaib M. Fetal nasal bone length: reference range and clinical application in ultrasound screening for trisomy 21. *Ultrasound Obstet Gynecol* 2003; 21: 156-160

Sonek JD, McKenna D, Webb D, Croom C, Nicolaidis K. Nasal bone length throughout gestation: normal ranges based on 3537 fetal ultrasound measurements. *Ultrasound Obstet Gynecol* 2003; 21: 152-155

CFEF

L. J. SALOMON, M. DUYME, J. CREQUAT, G. BRODATY, C. TALMANT, N. FRIES and M. ALTHUSER. French fetal biometry: reference equations and comparison with other charts. *Ultrasound Obstet Gynecol* 2006; 28: 193–198

M Massoud, M Duyme, M Fontanges, D Combourieu. Chart for estimation of fetal weight 2014 by the French College of Fetal Sonography (CFEF). *J Gynecol Obstet Biol Reprod (Paris)* (2015).

Verburg

B.O. VERBURG, E. A. P. STEEGERS, M. DE RIDDER, R. J.M. SNIJDERS, E. SMITH, A. HOFMAN, H. A. MOLL, V. W. V. JADDOE and J. C. M. WITTEMAN. New charts for ultrasound dating of pregnancy and assessment of fetal growth: longitudinal data from a population-based cohort study. *Ultrasound Obstet Gynecol* 2008; 31: 388–396 Published online 17 March 2008 in Wiley InterScience (www.interscience.wiley.com). DOI:10.1002/uog.5225

INTERGROWTH-21st

Aris T Papageorgiou, Eric O Ohuma, Douglas G Altman, Tullia Todros, Leila Cheikh Ismail, Ann Lambert, Yasmin A Jaffer, Enrico Bertino, Michael G Gravett, Manorama Purwar, J Alison Noble, Ruyan Pang, Cesar G Victora, Fernando C Barros, Maria Carvalho, Laurent J Salomon, Zulfiqar A Bhutta*, Stephen H Kennedy*, José Villar*. International standards for fetal growth based on serial ultrasound measurements: the Fetal Growth Longitudinal Study of the INTERGROWTH-21st Project. *The Lancet* 2014; 384: 869-879

6 Cardiology

6.1 Cardiac Exam Preparations

Make the following preparations before measuring:

1. Confirm that the current probe is appropriate.
2. Check that the current system date is correct.
3. Click [Info] on the touch screen and enter the patient information on the [Patient Info] → [CARD] page.

For more details, see “Exam Preparation → Patient Information” in the Operator’s Manual [Basic Volume].

4. Switch to the correct exam mode.

6.2 Basic Cardiac Measurement Procedures

1. Click [Info] on the touch screen and enter the patient information on the [Patient Info] → [CARD] page.
2. Press <Measure> to enter the Application Measurement.
3. Select the measurement tool from the menu or the touch screen to start the measurement.
See the table in “6.3 Cardiac Measurement Tools” for measurement tools.
See section “6.3 Cardiac Measurement Tools” and steps in “3 General Measurement” for measurement methods.
4. Click [Report] on the touch screen to view the exam report. See “6.5 Cardiac Exam Report” for details.

6.3 Cardiac Measurement Tools

The system supports the following cardiac measurements:

- | |
|---|
| <p>NOTE:</p> <ol style="list-style-type: none">1. The measurement tools mentioned below are configured in the system. The application measurement packages provided in this system are generally different combinations of measurement tools. For more information about package preset, see “2.4.2.2 Application Measurement Preset.”2. The heartbeat of the traced spectrum in VTI measurement should be equal to that preset, otherwise the obtained HR (Heart Rate) will be incorrect. See “2.2 Measurement Parameters Preset” for the relevant preset.3. Some application items in the measurement preset library (and matching list in the results assignment) are displayed different from those in the measurement menu and results window.
In the preset library (and matching list in the results assignment), the item is followed with the word indicating the mode or location. |
|---|

6.3.1 2D Cardiac Measurements

Types	Tools	Descriptions	Methods or formulae
Measurement	LA Diam.	Left Atrium Diameter	Distance in 2D General Measurements
	LA Major	Left Atrium Major Diameter	
	LA Minor	Left Atrium Minor Diameter	
	RA Major	Right Atrium Major Diameter	
	RA Minor	Right Atrium Minor Diameter	
	LV Major	Left Ventricular Major Diameter	
	LV Minor	Left Ventricular Minor Diameter	
	LVLd apical	Left Ventricular Long-axis Length at End-diastole in apical view	
	LVLs apical	Left Ventricular Long-axis Length at End-systole in apical view	
	RV Major	Right Ventricular Major Diameter	Distance in 2D General Measurements
	RV Minor	Right Ventricular Minor Diameter	
	LA Area	Left Atrium Area	Area in 2D General Measurements
	RA Area	Right Atrium area	
	LV Area(d)	Left Ventricular area at end-diastole	The system automatic calculates FAC value.
	LV Area(s)	Left Ventricular area at end-systole	$FAC = ((LV\ Area(d) - LV\ Area(s)) / LV\ Area(d)) * 100\%$
	RV Area(d)	Right Ventricular area at end-diastole	The system automatic calculates RV FAC value.
	RV Area(s)	Right Ventricular area at end-systole	$RV\ FAC = ((RV\ Area(d) - RV\ Area(s)) / RV\ Area(d)) * 100\%$
	LVA d sax MV	Left Ventricular Area at Mitral Valve level at End-diastole in Short-axis view	Area in 2D General Measurements
	LVA s sax MV	Left Ventricular Area at Mitral Valve level at End-systole in Short-axis view	
	LVA d apical	Left Ventricular Long-axis Area at End-diastole in apical view	

Types	Tools	Descriptions	Methods or formulae
	LVAAs apical	Left Ventricular Long-axis Area at end-systole in apical view	
	LVAAd sax Epi	Left Ventricular Epicardial Area at Papillary Muscle level at end-diastole in Short-axis view	
	LVAAd sax Endo	Left Ventricular Endocardial Area at Papillary Muscle level at end-diastole in Short-axis view	
	LVIDd	Left Ventricular Internal Diameter at end-diastole	The system automatic calculates RWT value. RWT=(LVPWd(cm)×2)/LVIDd(cm)
	LVPWd	Left Ventricular Posterior wall thickness at end-diastole	
	LVIDs	Left Ventricular Internal Diameter at end-systole	Distance in 2D General Measurements
	RVDd	Right Ventricular Diameter at end-diastole	
	RVDs	Right Ventricular Diameter at end-systole	
	LVPWs	Left Ventricular Posterior wall thickness at end-systole	
	RVAWd	Right Ventricular Anterior wall thickness at end-diastole	
RVAWs	Right Ventricular Anterior wall thickness at end-systole		
IVSd	Interventricular Septal Thickness at end-diastole		
Measurement	IVSs	Interventricular Septal Thickness at end-systole	
	Ao. Diam.	Aorta Diameter	
	Ao. Arch Diam.	Aorta Arch Diameter	
	Ao. Asc. Diam.	Ascending Aorta Diameter	
	Ao. Desc. Diam.	Descending Aorta Diameter	
	Ao. Isthmus	Aorta Isthmus Diameter	
	Ao. ST Junct.	Aorta ST Junction Diameter	

Types	Tools	Descriptions	Methods or formulae
	Ao. Sinus Diam.	Aorta Sinus Diameter	
	Duct. Art. Diam.	Ductus Arteriosus Diameter	
	Pre Ductal	Previous Ductal Diameter	
	Post Ductal	Posterior Ductal Diameter	
	ACS	Aortic Valve Cusp Separation	
	LVOT Diam.	Left Ventricular Outflow Tract Diameter	Distance in 2D General Measurements
	AV Diam.	Aorta Valve Diameter	
	AVA	Aortic Valve Area	Area in 2D General Measurements
	PV Diam.	Pulmonary Valve Diameter	
	LPA Diam.	Left Pulmonary Artery Diameter	
	RPA Diam.	Right Pulmonary Artery Diameter	
	MPA Diam.	Main Pulmonary Artery Diameter	Distance in 2D General Measurements
	RVOT Diam.	Right Ventricular Outflow Tract Diameter	
	MV Diam.	Mitral Valve diameter	
	MVA	Mitral Valve Area	Area in 2D General Measurements
	MCS	Mitral Valve Cusp Separation	
	MV EPSS	Distance between point E and Interventricular Septum when mitral valve is fully open	Distance in 2D General Measurements
	TV Diam.	Tricuspid Valve Diameter	
	TVA	Tricuspid Valve Area	Area in 2D General Measurements
	IVC Diam.(Insp.)	Inferior Vena Cava Inspiration Diameter	
	IVC Diam.(Expir.)	Inferior Vena Cava Expiration Diameter	
Measurement	SVC Diam.(Insp.)	Superior Vena Cava Inspiration Diameter	
	SVC Diam.(Expir.)	Superior Vena Cava Expiration Diameter	The system automatic calculates IVC Depth(Expir), IVC Depth(Insp), IVC Diam(Expir), IVC Diam(Insp), SVC Depth(Insp), SVC Diam(Insp), SVC Depth(Expir), SVC Diam(Expir), IVC-CI, IVC-DI, SVC-CI, SVC-DI value. *1

Types	Tools	Descriptions	Methods or formulae
	LCA Diam	Left Coronary Artery	Distance in 2D General Measurements
	RCA Diam	Right Coronary Artery	
	VSD Diam.	Ventricular Septal Defect Diameter	
	ASD Diam.	Atrial Septal Defect Diameter	
	PDA Diam.	Patent Ductus Arteriosus Diameter	
	PFO Diam.	Patent Oval Foramen Diameter	
	PEd	Pericardial Effusion at diastole	
	PEs	Pericardial Effusion at systole	
	HR	Heart Rate	Heart Rate in M General Measurements
	Diastole	End-diastolic Left Ventricular Measurement	FoldLine in 2D mode
	Systole	End-systolic Left Ventricular Measurement	
	RA Vol(A4C)	Right Atrium Volume (4-chamber)	See "Simpson" study
	AutoEF	Automatic measuring of the diastolic and systolic sectional planes	
	RAP	Right Atrium Pressure	Select from the pop-up dialog box or enter a value manually. See RAP measurement in "RVSP"
Calculation	LA/Ao.	Left Atrium Diameter/Aorta Diameter	LA Diam. (cm)/Ao. Diam. (cm)
Study	See below	/	/

*1 means:

$$\text{IVC-CI} = |\text{IVC Diam(Expir)} - \text{IVC Diam(Insp)}| / \text{Max}(\text{IVC Diam(Expir)}, \text{IVC Diam(Insp)})$$

$$\text{IVC-DI} = |\text{IVC Diam(Expir)} - \text{IVC Diam(Insp)}| / \text{Min}(\text{IVC Diam(Expir)}, \text{IVC Diam(Insp)})$$

$$\text{SVC-CI} = |\text{SVC Diam(Expir)} - \text{SVC Diam(Insp)}| / \text{Max}(\text{SVC Diam(Expir)}, \text{SVC Diam(Insp)})$$

$$\text{SVC-DI} = |\text{SVC Diam(Expir)} - \text{SVC Diam(Insp)}| / \text{Min}(\text{SVC Diam(Expir)}, \text{SVC Diam(Insp)})$$

6.3.2 M Cardiac Measurements

Types	Tools	Descriptions	Methods or formulae
Measurement	LA Diam.	Left Atrium Diameter	Distance in M General Measurements
	LVIDd	Left Ventricular Internal Diameter at end-diastole	The system automatic calculates RWT value. RWT=(LVPWd(cm)*2)/LVIDd(cm)
	LVPWd	Left Ventricular Posterior wall thickness at end-diastole	
	LVIDs	Left Ventricular Internal Diameter at end-systole	Distance in M General Measurements
	RVDd	Right Ventricular Diameter at end-diastole	
	RVDs	Right Ventricular Diameter at end-systole	
	LVPWs	Left Ventricular Posterior wall thickness at end-systole	
	RVAWd	Right Ventricular Anterior wall thickness at end-diastole	
	RVAWs	Right Ventricular Anterior wall thickness at end-systole	
	IVSd	Interventricular Septal Thickness at end-diastole	
	IVSs	Interventricular Septal Thickness at end-systole	
	Ao. Diam.	Aorta Diameter	
	Ao. Arch Diam.	Aorta Arch Diameter	
	Ao. Asc. Diam.	Ascending Aorta Diameter	
	Ao. Desc. Diam.	Descending Aorta Diameter	
	Ao. Isthmus	Aorta Isthmus Diameter	
	Ao. ST Junct.	Aorta ST Junction Diameter	
	Ao. Sinus Diam.	Aorta Sinus Diameter	
	LVOT Diam.	Left Ventricular Outflow Tract Diameter	
	ACS	Aortic Valve Cusp Separation	

Types	Tools	Descriptions	Methods or formulae
	LPA Diam.	Left Pulmonary Artery Diameter	
	RPA Diam.	Right Pulmonary Artery Diameter	
	MPA Diam.	Main Pulmonary Artery Diameter	
	RVOT Diam.	Right Ventricular Outflow Tract Diameter	
	MV E Amp.	Amplitude of the Mitral Valve E wave	
	MV A Amp.	Amplitude of the Mitral Valve A wave	
	MV E-F Slope	Mitral Valve E-F slope	Slope in M General Measurements
	MV D-E Slope	Mitral Valve D-E slope	
	MV D-E Amp	Amplitude of the Mitral Valve DE wave	Distance in M General Measurements
	MCS	Mitral Valve Cusp Separation	
	MV EPSS	Distance between point E and the interventricular septum	
	PEd	Pericardial Effusion at diastole	
	PEs	Pericardial Effusion at systole	
	LVPEP	Left Ventricular pre-ejection period	Time in M General Measurements
	LVET	Left Ventricular Ejection Time	
	RVPEP	Right Ventricular Pre-Ejection Period	
	RVET	Right Ventricular Ejection Time	
	HR	Heart Rate	Heart Rate in M General Measurements
	Diastole	End-diastolic Left Ventricular Measurement	Parallel method in M mode
	Systole	End-systolic Left Ventricular Measurement	
	MAPSE	Mitral Annular Plane Systolic Excursion	Time in M General Measurements

Types	Tools	Descriptions	Methods or formulae
	TAPSE	Tricuspid Annular Plane Systolic Excursion	Distance in M General Measurements
	MV ALL	M wave measurement of mitral valve anterior leaflet	See below
Calculation	LA/Ao.	Left Atrium Diameter/Aorta Diameter	LA Diam. (cm)/Ao. Diam. (cm)
Study	See below		

6.3.3 Doppler Cardiac Measurements

Types	Tools	Descriptions	Methods or formulae
Measurement	MV Vmax	Mitral Valve Maximum Velocity	D Vel. in Doppler General Measurements
	MV E Vel.	Mitral Valve E-wave Velocity	
	MV A Vel.	Mitral Valve A-wave Velocity	
	MV E VTI	Mitral Valve E-wave Velocity-Time Integral	D Trace in Doppler General Measurements
	MV A VTI	Mitral Valve A-wave Velocity-Time Integral	
	MV VTI	Mitral Valve Velocity-Time Integral	
	MV AccT	Mitral Valve Acceleration Time	Acceleration in Doppler General Measurements
	MV DecT	Mitral Valve Deceleration Time	
	IVRT	Mitral Valve Isovolumic Relaxation Time	Time in Doppler General Measurements
	IVCT	Mitral Valve Isovolumic Contraction Time	
	MV E Dur.	Mitral Valve E-wave Duration	
	MV A Dur.	Mitral Valve A-wave Duration	
Measurement	LVOT Vmax	Left Ventricular Outflow Tract Maximum Velocity	D Vel. in Doppler General Measurements
	LVOT VTI	Left Ventricular Outflow Tract Velocity-Time Integral	D Trace in Doppler General measurements
	LVOT AccT	Left Ventricular Outflow Tract Acceleration Time	Acceleration in Doppler General Measurements
	AAo Vmax	Ascending Aorta Maximum Velocity	D Vel. in Doppler General Measurements
	DAo Vmax	Descending Aorta Maximum Velocity	
	AV Vmax	Aorta Valve Maximum Velocity	
	AV VTI	Aorta Valve Velocity-Time Integral	D Trace in Doppler General measurements

Types	Tools	Descriptions	Methods or formulae
	LVPEP(Doppler)	Left Ventricular Pre-Ejection Period	Time in Doppler General Measurements
	LVET(Doppler)	Left Ventricular Ejection Time	
	AV AccT	Aorta Valve Acceleration Time	
	AV DecT	Aorta Valve Deceleration Time	
	RVET(Doppler)	Right Ventricular Ejection Time	Time in Doppler General Measurements
	RVPEP(Doppler)	Right Ventricular Pre-Ejection Period	
	TV Vmax	Tricuspid Valve Maximum Velocity	D Vel. in Doppler General Measurements
	TV E Vel.	Tricuspid Valve E-wave Flow Velocity	
	TV A Vel.	Tricuspid Valve A-wave Flow Velocity	
	TV VTI	Tricuspid Valve Velocity-Time Integral	D Trace in Doppler General measurements
	TV AccT	Tricuspid Valve Acceleration Time	Acceleration in Doppler General Measurements
	TV DecT	Tricuspid Valve Deceleration Time	
	TV A Dur.	Tricuspid Valve A-wave Duration	Time in Doppler General Measurements
	RVOT Vmax	Right Ventricular Outflow Tract Maximum Velocity	D Vel. in Doppler General Measurements
	RVOT VTI	Right Ventricular Outflow Tract Velocity-Time Integral	D Trace in Doppler General measurements
	PV Vmax	Pulmonary Valve Maximum Velocity	D Vel. in Doppler General Measurements
	PV VTI	Pulmonary Valve Velocity-Time Integral	D Trace in Doppler General measurements
	PV AccT	Pulmonary Valve Acceleration Time	Acceleration in Doppler General Measurements
	MPA Vmax	Main Pulmonary Artery Maximum Velocity	D Vel. in Doppler General Measurements
	RPA Vmax	Right Pulmonary Artery Maximum Velocity	
	LPA Vmax	Left Pulmonary Artery Maximum Velocity	
	PVein S Vel.	Pulmonary Vein S-wave Flow Velocity	D Vel. in Doppler General Measurements
	PVein D Vel.	Pulmonary Vein D-wave Flow Velocity	

Types	Tools	Descriptions	Methods or formulae
	PVein A Vel.	Pulmonary Vein A-wave Flow Velocity	
	PVein A Dur.	Pulmonary Vein A-wave Duration	Time in Doppler General Measurements
	PVein S VTI	Pulmonary Vein S-wave Velocity-time Integral	D Trace in Doppler General measurements
	PVein D VTI	Pulmonary Vein D-wave Velocity-time Integral	
	PVein DecT	Pulmonary Vein Deceleration Time	Time in Doppler General Measurements
	IVC Vel. (Insp.)	Inferior Vena Cava Inspiration Maximum Velocity	D Vel. in Doppler General Measurements
	IVC Vel. (Expir.)	Inferior Vena Cava Expiration Maximum Velocity	
	SVC Vel. (Insp.)	Superior Vena Cava Inspiration Maximum Velocity	
	SVC Vel. (Expir.)	Superior Vena Cava Expiration Maximum Velocity	
	MR Vmax	Mitral Valve Regurgitation Maximum Velocity	
	MR VTI	Mitral Valve Regurgitation Velocity-Time Integral	D Trace in Doppler General measurements
	MS Vmax	Mitral Valve Stenosis Maximum Velocity	D Vel. in Doppler General Measurements
	dP/dt	Rate of Pressure change	dP/dt Measurement
	AR Vmax	Aortic Valve Regurgitation Maximum Velocity	D Vel. in Doppler General Measurements
	AR VTI	Aortic Valve Regurgitation Velocity-Time Integral	D Trace in Doppler General measurements
	AR DecT	Aortic Valve Regurgitation Deceleration Time	Acceleration in Doppler General Measurements
	AR PHT	Aortic Valve Regurgitation Pressure Half Time	Doppler Measurement
	AR Ved	Aortic Valve Regurgitation Velocity at end-Diastole	D Vel. in Doppler General Measurements
	TR Vmax	Tricuspid Valve Regurgitation Maximum Velocity	
	TR VTI	Tricuspid Valve Regurgitation Velocity-Time Integral	D Trace in Doppler General measurements
	PR Vmax	Pulmonary Valve Regurgitation Maximum Velocity	D Vel. in Doppler General Measurements

Types	Tools	Descriptions	Methods or formulae
	PR VTI	Pulmonary Valve Regurgitation Velocity-Time Integral	D Trace in Doppler General measurements
	PR PHT	Pulmonary Valve Regurgitation Pressure Half Time	Doppler Measurement
	PR Ved	Pulmonary Valve Regurgitation Velocity at end-Diastole	D Vel. in Doppler General Measurements
	VSD Vmax	Ventricular Septal Defect Maximum Velocity	
	ASD Vmax	Atrial Septal Defect Maximum Velocity	
	PDA Vel(d)	Patent Ductus Arteriosus Velocity at End-diastole	
	PDA Vel(s)	Patent Ductus Arteriosus Velocity at End-systole	
	Coarc. Pre-Duct.	Coarctation of Pre-Ductus	
	Coarc. Post-Duct.	Coarctation of Post-Ductus	
	AV/TV/MV/PV HR	Heart Rate	
	RAP	Right Atrium Pressure	
	Hepatic V S Vel.	Hepatic Vein Systolic Peak Velocity	D Vel. in Doppler General Measurements
	Hepatic V D Vel.	Hepatic Vein Diastolic Peak Velocity	
	Tau(BAI)	Left Ventricular Diastolic Time Constant	Tau(BAI) Measurement
Calculation	MV E/A	Mitral Valve E-Vel./A-Vel.	MV E Vel. (cm/s)/MV A Vel. (cm/s)
	MVA(PHT)	Mitral Valve Orifice Area (PHT)	$MVA(PHT) (cm^2) = 220 / MV PHT (ms)$
	TV E/A	Tricuspid Valve E-Vel./A-Vel.	$TV E/A = TV E Vel(cm/s) / TV A Vel(cm/s)$
	TVA(PHT)	Tricuspid Valve Orifice Area (PHT)	$TVA(PHT) = 220 / TV PHT(cm^2)$
Study	See below	/	/

6.3.4 TDI Cardiac Measurements

The following measurement items are performed in TDI mode.

Types	Tools	Descriptions	Methods or formulae
Measurement	MV Aa(medial)	Mitral Valve medial Late diastolic motion	D Vel. in Doppler General Measurements
	MV Sa(medial)	Mitral Valve medial Systolic motion	
	MV Aa(lateral)	Mitral Valve lateral Late diastolic motion	
	MV Sa(lateral)	Mitral Valve lateral Systolic motion	
	MV ARa(medial)	Mitral Valve medial Acceleration Rate	Acceleration in Doppler General Measurements
	MV DRa(medial)	Mitral Valve medial Deceleration Rate	
	MV ARa(lateral)	Mitral Valve lateral Acceleration Rate	
	MV DRa(lateral)	Mitral Valve lateral Deceleration Rate	
	MV Ea(lateral)	Mitral Valve lateral Early diastolic motion	Measure MV E Vel item to get E/Ea result. D Vel. in Doppler General Measurements *1
	MV Ea(medial)	Mitral Valve medial Early diastolic motion	Measure MV E Vel item to get E/Ea result. D Vel. in Doppler General Measurements *2
Calculation	/	/	/
Study	See below	/	/

*1 means:

$$E / Ea(lateral)(Nounit) = \frac{MV\ E\ Vel(cm / s)}{Ea(lateral)(cm / s)}$$

*2 means:

$$E / Ea(medial + lateral)(Nounit) = \frac{MV\ E\ Vel(cm / s)}{(Ea(medial)(cm / s) + Ea(lateral)(cm / s)) / 2}$$

6.4 Cardiac Measurement Operations

- Tip:**
1. See the table in “6.3 Cardiac Measurement Tools” above for measurement tools and methods.
 2. For the definitions of measurement, calculation and study, see “1.3 Measurement, Calculation and Study.”

3. The order of the measurement items can be preset. See “2.4.2 Application Measurement Preset” for details.
4. A measurement tool can be activated by clicking the item in the measurement menu on the touch screen. It is described as “Select/Click ... in the measurement menu” in the following procedures.
5. The measurements of some tools described in this chapter are to be performed in several imaging modes. Select the appropriate imaging mode before measurement.

6.4.1 Measurement Tool Operations

1. Select the item/tool in the measurement menu or the touch screen.
2. Perform the measurement referring to the methods in the table above.

MV ALL

Function: Measure M wave of mitral valve anterior leaflet.

■ Measure items

Item	Description
MV D Point	End of systolic, immediately before the opening of the Mitral Valve.
MV E Point	The anterior leaflet of the mitral valve opens, it peaks at E.
MV F Point	Lowest point of the initial diastolic closing.
MV A Point	In atria systole, blood is propelled through the mitral orifice and the mitral leaflets reopen. The peak of this phase of mitral valve motion is indicated as A.
MV C Point	Complete closure occurs after the onset of the ventricular systole.

■ Measurement Result

Item	Description	Method
MV E Amp	Amplitude of the Mitral Valve E wave to C point	Distance in M General Measurements
MV D-E Amp	Distance between the onset of the opening of the mitral valve at D and the maximum opening of the anterior mitral valve leaflet at E.	Distance in M General Measurements
MV D-E Slope	The rate of change that exists between two point (D, E).	Slope in M General Measurements
MV E-F Slope	The rate of change that exists between two point (E, F).	Slope in M General Measurements
MV A Amp	Amplitude of the Mitral Valve A wave to C point	Distance in M General Measurements
MV A-C Interval	The time interval between the A point and the C point.	Time in M General Measurements

■ Operation

Select the [MV ALL] in the measure menu.

Roll the trackball to move the cursor, press <Set> to fix points D, E, F, A and C in turn. Corresponding character symbol will display at the right side of the point.

After D point and E point are fixed, MV D-E Amp and MV D-E Slope values are acquired.

MV E-F Slope value is acquired by fixing F point.

MV E Amp, MV A Amp and MV A-C Interval values are acquired by fixing A point and C point.

You can end measurement in advance by pressing <Set> twice on point E, F, A or C.

AutoEF

Function: Measure the systole and diastole planes automatically.

Tip: Only cardiac exam mode supports this function.

Recommend to connect ECG, capture the cine of standard A2C and A4C planes, and select cardiac cycles which have the clear plane of the cardiac muscle and less interference to perform AutoEF measure.

■ Measure items

Item	Description
LVLd (A2C)	Left ventricular long-axis length at end diastole (A2C)
LVAAd (A2C)	Left ventricular long-axis area at end diastole (A2C)
LVLs (A2C)	Left ventricular long-axis length at end systole (A2C)
LVAAs (A2C)	Left ventricular long-axis area at end systole (A2C)
LVLd (A4C)	Left ventricular long-axis length at end diastole (A4C)
LVAAd (A4C)	Left ventricular long-axis area at end diastole (A4C)
LVLs (A4C)	Left ventricular long-axis length at end systole (A4C)
LVAAs (A4C)	Left ventricular long-axis area at end systole (A4C)

■ Measurement Result

Item	Description
EDV (A2C/A4C/BP)	End-diastolic Left Ventricular Volume
EDV Index (A2C/A4C/BP)	End-diastolic Left Ventricular Volume Index
ESV (A2C/A4C/BP)	End-systolic Left Ventricular Volume
ESV Index A2C/A4C/BP)	End-systolic Left Ventricular Volume Index
SV (A2C/A4C/BP)	Stroke Volume
SI (A2C/A4C/BP)	SV Index
EF (A2C/A4C/BP)	Ejection Fraction
CO (A2C/A4C/BP)	Cardiac Output
CI (A2C/A4C/BP)	Cardiac output index

■ Operation

1. Select the [AutoEF] in the measure menu.
2. In apical two-chamber view, measure the following parameters:
Left ventricular endocardium at end-diastolic, the EDV(A2C) is obtained automatically.
Left ventricular endocardium at end-systolic, the ESV(A2C) is obtained automatically.
3. In apical four-chamber view, measure the following parameters:
Left ventricular endocardium at end-diastolic, the EDV(A4C) is obtained automatically.
Left ventricular endocardium at end-systolic, the ESV(A4C) is obtained automatically.
4. If the height and weight have already been entered, the SV, EF, SI, EDV Index and ESV Index are calculated. ECG obtains the HR automatically.

- The CO and CI are calculated automatically using the entered height and weight values.
- If necessary, drag the ED/ES ventricular contour by moving the cursor to modify the ventricular volume (EDV/ESV) if necessary. Then, the EF is changed according to the formula $EF = (EDV - ESV) / EDV$.

Tau(BAI)

Function: Measure the diastolic function of left ventricular.

Notes:

During the measurement, the range of the velocity axis in the spectrum window should be larger than the range of -1m/s to -3m/s.

- Select [Tau(BAI)] in the measurement menu. The cursor appears on the screen.
- Move the vertical dotted line by using the trackball to the starting point, which is the intersection of the horizontal dotted line of -3m/s and the descending portion of mitral valve regurgitation spectrum.
- Press <Set> to set the starting point.
- Move the vertical dotted line by using the trackball to the end point, which is the intersection of the horizontal dotted line of -1m/s and the descending portion of mitral valve regurgitation spectrum. Then
press <Clear> to cancel setting the starting point. Or
press <Update> to switch between the fixed end and the active end.
- Press <Set> to set the end point and the result is displayed in the result window.

6.4.2 Calculation Tool Operations

- Select the item/tool in the measurement menu or the touch screen.
- The system calculates and displays the results after the measurement items have been completed.

6.4.3 Study Tool Operations

6.4.3.1 Left Ventricular Function

This group of studies estimates the Left Ventricular (LV) diastolic and systolic capabilities using a series of clinical indices measured on the B or M image. As well as calculating the left ventricular volume and end diastole and end systole, they may calculate the following indices (not all indices are calculated in every study, see the Study Results table for each study for reference).

Results	Descriptions	Formulae
SV	Stroke Volume	$SV(ml) = EDV(ml) - ESV(ml)$
CO	Cardiac Output	$CO(l/min) = SV(ml) \times HR(bpm) / 1000$
EF	Ejection Fraction	$EF(\text{No unit}) = SV(ml) / EDV(ml)$
SI	SV Index	$SI(\text{No unit}) = SV(ml) / \text{Body Surface Area (m}^2\text{)}$
CI	Cardiac output index	$CI(\text{No unit}) = CO(l/min) / \text{Body Surface Area (m}^2\text{)}$
FS	Fractional Shortening	$FS(\text{No unit}) = (LVIDd (cm) - LVIDs [cm]) / LVIDd (cm)$

Results	Descriptions	Formulae
MVCF	Mean Velocity of Circumferential Fiber Shortening	$MVCF = (LVIDd(cm) - LVIDs(cm)) / (LVIDd (cm) \times ET (s))$

NOTE: The HR value entered manually should be within the range 1~999.

S-P Ellipse

■ Study Items

Tools	Descriptions	Operations
LVLd apical	Left Ventricular Long-axis Length at End-diastole in apical view	Distance in 2D General Measurements
LVA d apical	Left Ventricular Long-axis Area at End-diastole in apical view	Area in 2D General Measurements
LVLs apical	Left Ventricular Long-axis Length at End-systole in apical view	Distance in 2D General Measurements
LVA s apical	Left Ventricular Long-axis Area at end-systole in apical view	Area in 2D General Measurements
HR	Heart Rate	Obtained by ECG, HR(R-R) measurement or entered directly

■ Study Results

Tools	Descriptions	Formulae
EDV(SP Ellipse)	End-diastolic Left Ventricular Volume	$EDV(SP Ellipse)(ml) \square \frac{8}{3\pi} \times \frac{LVA d apical(cm^2)^2}{LVLd apical(cm)}$
ESV(SP Ellipse)	End-systolic Left Ventricular Volume	$ESV(SP Ellipse)(ml) \square \frac{8}{3\pi} \times \frac{LVA s apical(cm^2)^2}{LVLs apical(cm)}$
EDV Index(SP Ellipse)	End-diastolic Left Ventricular Volume Index	EDV Index=EDV/BSA
ESV Index(SP Ellipse)	End-systolic Left Ventricular Volume Index	ESV Index=ESV/BSA
SV(SP Ellipse)	Stroke Volume	See table in "6.4.3.1 Left Ventricular Function"
CO(SP Ellipse)	Cardiac Output	
EF(SP Ellipse)	Ejection Fraction	
SI(SP Ellipse)	SV Index	
CI(SP Ellipse)	CO Index	

■ Operating Procedures

1. Select [S-P Ellipse] in the measurement menu or the touch screen.
2. In apical long-axis view at end-diastole, measure the following parameters:

LVLd apical

LVA d apical

The EDV value is then calculated.

3. In apical long-axis view at end-systole, measure the following parameters:

LVLs apical

LVA s apical

The ESV value is then calculated.

The system calculates the SV and EF.

If the height and weight have already been entered, the SI, EDV Index and ESV Index are calculated.

4. Use the menu to select the HR source: HR(R-R) measurement, ECG or entered.

The CO and CI are calculated automatically using the entered height and weight values.

B-P Ellipse

■ Study Items

Tools	Descriptions	Operations
LVIDd	Left Ventricular Internal Diameter at End-diastole	Distance in 2D General Measurements
LVIDs	Left Ventricular Internal Diameter at End-systole	
LVA d sax MV	Left Ventricular Area at Mitral Valve level at End-diastole in Short-axis view	Area in 2D General Measurements
LVA s sax MV	Left Ventricular Area at Mitral Valve level at End-systole in Short-axis view	
LVA d apical	Left Ventricular Long-axis Area at End-diastole in apical view	
LVA s apical	Left Ventricular Long-axis Area at end-systole in apical view	
HR	Heart Rate	Obtained by ECG, HR(R-R) measurement or entered directly

■ Study Results

Tools	Descriptions	Formulae
EDV(BP Ellipse)	End-diastolic Left Ventricular Volume	*1
ESV(BP Ellipse)	End-systolic Left Ventricular Volume	*2
EDV Index(BP Ellipse)	End-diastolic Left Ventricular Volume Index	EDV Index=EDV/BSA
ESV Index(BP Ellipse)	End-systolic Left Ventricular Volume Index	ESV Index=ESV/BSA
SV(BP Ellipse)	Stroke Volume	See table in "6.4.3.1 Left Ventricular Function"
CO(BP Ellipse)	Cardiac Output	
EF(BP Ellipse)	Ejection Fraction	
SI(BP Ellipse)	SV Index	

Tools	Descriptions	Formulae
CI(BP Ellipse)	CO Index	

*1 means:

$$EDV(BP\ Ellipse)(ml) = \frac{8}{3\pi} \times LVAd\ apical(cm^2) \times LVAd\ sax\ MV(cm^2) / LVIDd(cm)$$

*2 means:

$$ESV(BP\ Ellipse)(ml) = \frac{8}{3\pi} \times LVAs\ apical(cm^2) \times LVAs\ sax\ MV(cm^2) / LVIDs(cm)$$

■ Operating Procedures

1. Select [B-P Ellipse] in the menu or the touch screen.
2. In left ventricular short-axis view, measure the following parameters:
 - At end diastole: LVIDd
 - At end systole: LVIDs
3. In short-axis view at mitral valve level, measure the following parameters:
 - At end diastole: LVAd sax MV
 - At end systole: LVAs sax MV
4. In apical long-axis view, measure the following parameters:
 - LVAd apical, the EDV is calculated
 - LVAs apical, the ESV is calculated

The system calculates the SV and EF after the LVAs apical has been measured.
If the height and weight have already been entered, the SI, EDV Index and ESV Index are calculated.
5. Use the menu to select the HR source: ECG, HR(R-R) measurement or entered.
The CO and CI are calculated automatically using the entered height and weight values.

Bullet

■ Study Items

Tools	Descriptions	Operations
LVLd apical	Left Ventricular Long-axis Length at End-diastole in apical view	Distance in 2D General Measurements
LVLs apical	Left Ventricular Long-axis Length at End-systole in apical view	
LVAd sax MV	Left Ventricular Area at Mitral Valve level at End-diastole in Short-axis view	Area in 2D General Measurements
LVAs sax MV	Left Ventricular Area at Mitral Valve level at End-systole in Short-axis view	
HR	Heart Rate	Obtained by ECG, HR(R-R) measurement or entered directly

■ Study Results

Tools	Descriptions	Formulae
EDV(Bullet)	End-diastolic Left Ventricular Volume	$EDV(ml) = 5/6 \times LVLd\ apical(cm) \times LVAd\ sax\ MV(cm^2)$

Tools	Descriptions	Formulae
ESV(Bullet)	End-systolic Left Ventricular Volume	$ESV(ml) = 5/6 \times LVLs \text{ apical}(cm) \times LVAs \text{ sax MV}(cm^2)$
EDV Index(Bullet)	End-diastolic Left Ventricular Volume Index	$EDV \text{ Index} = EDV/BSA$
ESV Index(Bullet)	End-systolic Left Ventricular Volume Index	$ESV \text{ Index} = ESV/BSA$
SV(Bullet)	Stroke Volume	See table in "6.4.3.1 Left Ventricular Function"
CO(Bullet)	Cardiac Output	
EF(Bullet)	Ejection Fraction	
SI(Bullet)	SV Index	
CI(Bullet)	CO Index	

■ Operating Procedures

- Select [Bullet] in the measurement menu or the touch screen.
In apical long-axis view, measure the following parameters:
At end diastole: LVLd apical
At end systole: LVLs apical.
- In short-axis view at mitral valve level, measure the following parameters:
At end diastole: LVAd sax MV, the EDV is calculated
At end systole: LVAs sax MV, the ESV is calculated
The system calculates the SV and EF. If the height and weight have already been entered, the SI, EDV Index and ESV Index are calculated.
- Use the menu to select the HR source: ECG, HR(R-R) measurement or entered.
The CO and CI are calculated automatically using the entered height and weight values.

Mod.Simpson

■ Study Items

Tools	Descriptions	Operations
LVLd apical	Left Ventricular Long-axis Length at End-diastole in apical view	Distance in 2D General Measurements
LVLs apical	Left Ventricular Long-axis Length at End-systole in apical view	
LVAd sax MV	Left Ventricular Area at Mitral Valve level at End-diastole in Short-axis view	Area in 2D General Measurements
LVAs sax MV	Left Ventricular Area at Mitral Valve level at End-systole in Short-axis view	
LVAd sax PM	Left Ventricular Area at Papillary Muscle level at end-diastole in short axis view	
LVAs sax PM	Left Ventricular Area at Papillary Muscle level at end-systole in short axis view	

Tools	Descriptions	Operations
HR	Heart Rate	Obtained by ECG, HR(R-R) measurement or entered directly

■ Study Results

Tools	Descriptions	Formulae
EDV(Mod.Simpson)	End-diastolic Left Ventricular Volume	*1
ESV(Mod.Simpson)	End-systolic Left Ventricular Volume	*2
EDV Index(Mod.Simpson)	End-diastolic Left Ventricular Volume Index	EDV Index=EDV/BSA
ESV Index(Mod.Simpson)	End-systolic Left Ventricular Volume Index	ESV Index=ESV/BSA
SV(Mod.Simpson)	Stroke Volume	See table in "6.4.3.1 Left Ventricular Function"
CO(Mod.Simpson)	Cardiac Output	
EF(Mod.Simpson)	Ejection Fraction	
SI(Mod.Simpson)	SV Index	
CI(Mod.Simpson)	CO Index	

*1 means:

$$EDV[mL] = \frac{LVLd_{apical} [cm]}{9} \times \left(4 \times LVA_{dsax} MV [cm^2] + 2 \times LVA_{dsax} PM [cm^2] + \sqrt{LVA_{dsax} MV [cm^2] \times LVA_{dsax} PM [cm^2]} \right)$$

*2 means:

$$ESV[mL] = \frac{LVLs_{apical} [cm]}{9} \times \left(4 \times LVA_{ssax} MV [cm^2] + 2 \times LVA_{ssax} PM [cm^2] + \sqrt{LVA_{ssax} MV [cm^2] \times LVA_{ssax} PM [cm^2]} \right)$$

■ Operating Procedures

1. Select [Mod.Simpson] in the measurement menu or the touch screen.
2. In apical long-axis view, measure the following parameters:
 - At end diastole: LVLd apical
 - At end systole: LVLs apical
3. In short-axis view at mitral valve level, measure the following parameters:
 - At end diastole: LVAd sax MV
 - At end systole: LVAs sax MV
4. In short-axis view at papillary muscle level, measure the following parameters:
 - At end diastole: LVAd sax PM, the EDV is calculated
 - At end systole: LVAs sax PM, the ESV is calculated

The system calculates the SV and EF.

If the height and weight have already been entered, the SI, EDV Index and ESV Index are calculated.
5. Use the menu to select the HR source: ECG, HR(R-R) measurement or entered.

The CO and CI are calculated automatically using the entered height and weight values.

Simpson

You may select to measure single plane (A2C or A4C) only or both planes (A2C and A4C) to study.

■ Study Items

Tools	Descriptions	Operations
A2Cd	Left ventricular long-axis length at end diastole in A2C view	Simpson measurement (Trace/Spline/Auto)
A2Cs	Left ventricular long-axis length at end systole in A2C view	
A4Cd	Left ventricular long-axis length at end diastole in A4C view	
A4Cs	Left ventricular long-axis length at end systole in A4C view	
HR	Heart Rate	Obtained by ECG, HR(R-R) measurement or entered directly

■ Study Results

Tools	Descriptions	Formulae
EDV(A2C/A4C)	End-diastolic Left Ventricular Volume (A2C/A4C)	$EDV(ml) \square \pi \times \frac{LVLd\ apical(cm)}{20} \times \sum_{i=1}^{20} r_i^2 (cm)$ <p>LVLd apical: Left Ventricular Long-axis Length at End-diastole in apical view, i.e. the long-axis length obtained in measurement.</p> <p>r_i : Radii obtained from diastolic measurement</p>
EDV (BP)	End-diastolic Left Ventricular Volume (BP)	*1
ESV(A2C/A4C)	End-systolic Left Ventricular Volume (A2C/A4C)	$ESV(ml) \square \pi \times \frac{LVLs\ apical(cm)}{20} \times \sum_{i=1}^{20} r_i^2 (cm)$ <p>LVLs apical: Left Ventricular Long-axis Length at End-systole in apical view, i.e. the long-axis length obtained in measurement.</p> <p>r_i : Radii obtained from systolic measurement</p>
ESV (BP)	End-systolic Left Ventricular Volume (BP)	*2
EDV Index (A2C/A4C/BP)	End-diastolic Left Ventricular Volume Index (A2C/A4C/BP)	EDV Index=EDV/BSA
ESV Index (A2C/A4C/BP)	End-systolic Left Ventricular Volume Index (A2C/A4C/BP)	ESV Index=ESV/BSA
SV	Stroke Volume	See table in "6.4.3.1 Left Ventricular Function"
CO	Cardiac Output	
EF	Ejection Fraction	
SI	SV Index	
CI	CO Index	

*1 means:

$$EDV(ml) = \pi \times \frac{MAX\{LVLd_{2i}(cm), LVLd_{4i}(cm)\}}{20} \times \sum_{i=1}^{20} (r_{2i}(cm) \times r_{4i}(cm))$$

*2 means:

$$ESV(ml) = \pi \times \frac{MAX\{LVLS_{2i}(cm), LVLS_{4i}(cm)\}}{20} \times \sum_{i=1}^{20} (r_{2i}(cm) \times r_{4i}(cm))$$

Calculate the LV volume on the apical 2-chamber view image:

$$EDV2(ml) = \pi \times \frac{LVLd_{2i}(cm)}{20} \times \sum_{i=1}^{20} r_{2i}^2(cm)$$

$$ESV2(ml) = \pi \times \frac{LVLS_{2i}(cm)}{20} \times \sum_{i=1}^{20} r_{2i}^2(cm)$$

Calculate the LV volume on the apical 4-chamber view image:

$$EDV4(ml) = \pi \times \frac{LVLd_{4i}(cm)}{20} \times \sum_{i=1}^{20} r_{4i}^2(cm)$$

$$ESV4(ml) = \pi \times \frac{LVLS_{4i}(cm)}{20} \times \sum_{i=1}^{20} r_{4i}^2(cm)$$

Where

$LVLd_{2i}$ – Left ventricular long-axis length at end diastole at apical two-chamber view, which is the long-axis length obtained by EDV(A2C) measurement

$LVLd_{4i}$ – Left ventricular long-axis length at end diastole at apical four-chamber view, which is the long-axis length obtained by EDV(A4C) measurement

$LVLS_{2i}$ – Left ventricular long-axis length at end systole at apical two-chamber view, which is the long-axis length obtained by ESV(A2C) measurement

$LVLS_{4i}$ – Left ventricular long-axis length at end systole at apical four-chamber view, which is the long-axis length obtained by ESV(A4C) measurement

r_{2i} – Radii obtained by EDV(A2C) or ESV(A2C) at apical two-chamber view

r_{4i} – Radii obtained by EDV(A4C) or ESV(A4C) at apical four-chamber view

(1) Simpson single plane measurement (measure apical A2C or A4C only)

■ Operating Procedures

1. Select [Simpson] in the measurement menu or the touch screen.
2. Measure the endocardium.

Measure the left ventricular endocardium at end-diastolic and set the long axis, the EDV is obtained.

Measure the left ventricular endocardium at end-systolic and set the long axis, the ESV is obtained.

The system calculates the SV and EF.

If the height and weight have already been entered, the SI, EDV Index and ESV Index are calculated.

3. Use the menu to select the HR source: ECG, HR(R-R) measurement or entered.

The CO and CI are calculated automatically using the entered height and weight values.

■ Measurement Methods

The endocardium can be measured using trace, spline or auto, click items on the menu to select the method.

- Trace

Trace the endocardium along the edge of the target area using a method similar to the “Trace” method in 2D Area measurements, then set the long axis.

- Spline

Set reference points (up to 12) along the edge of the endocardium using a method similar to the “Spline” method in 2D Area measurements, then set the long axis.

- Auto

(1) Set points A and B using the trackball and <Set> key, where

- A: Left ventricular interventricular septal and mitral valve junction;
- B: Left ventricular wall and mitral valve junction;

(2) After setting A and B, the cursor will be automatically displayed at point D (where is considered as the apical part by system detecting). After point D is set, the long axis (line segment CD) and the line that traces the endocardium are displayed. Where

- C: Midpoint of A and B.
- D: Apical part of left ventricle.

You can:

- Adjust the long axis

- Rotate the trackball to position the cursor on the long axis (which turns yellow), then press <Set>
- Rotate the trackball and adjust point D (with point C unchanged) after the cursor changes to .

- Adjust the trace line

- Rotate the trackball to position the cursor on the trace line (which turns yellow), and then press <Set>
- Rotate the trackball and move the cursor along the endocardium edge to adjust the line after the cursor changes to .

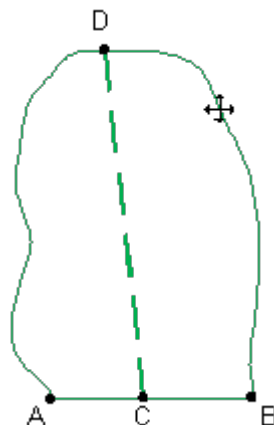

(3) Press <Set> outside the line to confirm the adjustment.

(2) Simpson Bi-plane measurement

⚠ CAUTION: When using Simpson to measure LV function, be sure to keep the apical four-chamber view and apical two-chamber view perpendicular. Otherwise the measurement result will be incorrect.

- Operating Procedures

1. Select [Simpson] in the measurement menu or the touch screen.
2. In apical two-chamber view, measure the following parameters:

- Left ventricular endocardium at end-diastolic and set the long axis, the EDV(A2C) is obtained
 Left ventricular endocardium at end-systolic and set the long axis, the ESV(A2C) is obtained
- In apical four-chamber view, measure the following parameters:
 Left ventricular endocardium at end-diastolic and set the long axis, the EDV(A4C) is obtained
 Left ventricular endocardium at end-systolic and set the long axis, the ESV(A4C) is obtained
 - If the height and weight have already been entered, the SV, EF, SI, EDV Index and ESV Index are calculated.
 - Use the touch screen to select the HR source: ECG, HR(R-R) measurement or entered.
 The CO and CI are calculated automatically using the entered height and weight values.

LV (2D)

■ Study Items

Tools	Descriptions	Operations
Diastole	End-diastolic Left Ventricular Measurement	FoldLine in 2D mode Parallel method in M mode
Systole	End-systolic Left Ventricular Measurement	
LVIDd	Left Ventricular Internal Diameter at End-diastole	Distance in 2D/M General Measurements
LVIDs	Left Ventricular Internal Diameter at End-systole	
HR	Heart Rate	Obtained by ECG, HR(R-R) measurement or entered directly

■ Study Results

Tools	Descriptions	Formulae
IVSd	Interventricular Septal Thickness at End-diastole	Distance in 2D/M General Measurements
LVPWd	Left Ventricular Posterior Wall Thickness at End-diastole	
IVSs	Interventricular Septal Thickness at End-systole	
LVPWs	Left Ventricular Posterior Wall Thickness at End-systole	
EDV	End-diastolic Left Ventricular Volume	$EDV(ml) = LVIDd(cm)^3$
ESV	End-systolic Left Ventricular Volume	$ESV(ml) = LVIDs(cm)^3$
EDV Index	End-diastolic Left Ventricular Volume	$EDV\ Index = EDV/BSA$
ESV Index	End-systolic Left Ventricular Volume	$ESV\ Index = ESV/BSA$
SV	Stroke Volume	See table in "6.4.3.1 Left Ventricular Function"
CO	Cardiac Output	
EF	Ejection Fraction	
FS	Fractional Shortening	
MVCF	Mean Velocity of Circumferential Fiber Shortening	

Tools	Descriptions	Formulae
SI	SV Index	
CI	CO Index	

- Operating Procedures (taking the method using LVIDd, LVIDs, HR as an example)
 1. Select [LV (2D)] in the measurement menu or the touch screen.
 2. Measure LVIDd in 2D or M mode.
The LVIDd and EDV are obtained.
 3. Measure the LVIDs in 2D or M mode.
The LVIDs and ESV are obtained.
The system calculates the SV, EF and FS.
 4. Using the menu to select the HR source: ECG, HR(R-R) measurement or entered.
If the height and weight have already been entered, the SI, CO, CI, EDV Index and ESV Index are calculated.
The MVCF is calculated if the LVET is measured.
- In the [Setup]-[System Preset]-[Application] screen, you can set the method for the Cube/Teichholz/HR study.
- Click [Property] in [Setup]->[Measure] to select formula for LV measurement by selecting result items: Cube, Teichholz or Gibson.

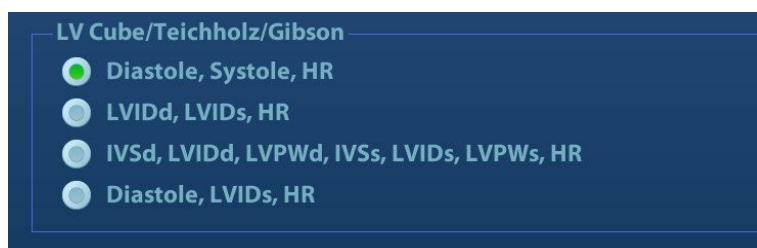

For example, select Diastole (2D) item and click [Property] as shown in the following figure. Check items with (Teich) symbol, then items will be calculated by Teichholz.(If all items are selected, then results of three methods are displayed.)

6.4.3.2 Left Ventricular Mass (LV Mass)

Estimates the Index of Left Ventricular Mass (LV Mass-I) by calculating the LV Mass.

$$\text{LV MASS-I (No unit)} = \text{LV Mass (g)} / \text{Body Surface Area (m}^2\text{)}$$

LV Mass (Cube)

- Study Items

Tools	Descriptions	Operations
IVSd	Interventricular Septal Thickness at End-diastole	Distance in 2D/M General Measurements
LVIDd	Left Ventricular Internal Diameter at End-diastole	
LVPWd	Left Ventricular Posterior Wall Thickness at End-diastole	

- Study Results

Tools	Descriptions	Formulae
LV Mass (Cube)	Left Ventricular Mass	$\text{LV Mass (g)} = 1.04 \times ((\text{LVPWd(cm)} + \text{IVSd(cm)} + \text{LVIDd(cm)})^3 - \text{LVIDd(cm)}^3) - 13.6$

Tools	Descriptions	Formulae
LV MASS-I (Cube)	Index of Left Ventricular Mass	See the LV Mass-I formula in “Left Ventricular Mass (LV Mass)”

■ Operating Procedures

1. Select [LV Mass (Cube)] in the measurement menu or the touch screen.
2. At end diastole, measure the following parameters:
IVSd
LVIDd
LVPWd

The LV Mass (Cube) is calculated.

If the height and weight have already been entered, the LV Mass-I(Cube) is calculated.

LV Mass (A-L)

■ Study Items

Tools	Descriptions	Operations
LVAd sax Epi	Left Ventricular Epicardial Area at Papillary Muscle level at end-diastole in Short-axis view	Area in 2D General Measurements
LVAd sax Endo	Left Ventricular Endocardial Area at Papillary Muscle level at end-diastole in Short-axis view	
LVLd apical	Left Ventricular Long-axis Length at End-diastole in apical view	Distance in 2D General Measurements

■ Study Results

Tools	Descriptions	Formulae
LV Mass (A-L)	Left Ventricular Mass	*1
LV MASS-I (A-L)	Index of Left Ventricular Mass	See the LV Mass-I formula in “Left Ventricular Mass (LV Mass)”

*1 means:

$$\text{LV Mass(g)} = 1.05 \times 5/6 \times (\text{LVAd sax Epi}(\text{cm}^2) \times (\text{LVLd apical}(\text{cm}) + t(\text{cm})) - \text{LVAd sax Endo}(\text{cm}^2) \times \text{LVL}(\text{cm}))$$

Where

$$t(\text{cm}) = \sqrt{(\text{LVAd sax Epi}(\text{cm}^2) / \pi)} - \sqrt{(\text{LVAd Sax Endo}(\text{cm}^2) / \pi)}$$

■ Operating Procedures

1. Select [LV Mass (A-L)] in the measurement menu or the touch screen.
2. In long-axis view at end diastole, measure the LVLd apical.
3. In short-axis view at papillary muscle level at end diastole, measure the following parameters:
Endocardium area: LVAd sax Endo
Epicardium area: LVAd sax Epi

The LV Mass (A-L) is calculated.

If the height and weight have already been entered, the LV Mass-I(A-L) is calculated.

LV Mass (T-E)

■ Study Items

Tools	Descriptions	Operations
LVAAd sax Epi	Left Ventricular Epicardial Area at Papillary Muscle level at end-diastole in Short-axis view	Area in 2D General Measurements
LVAAd sax Endo	Left Ventricular Endocardial Area at Papillary Muscle level at end-diastole in Short-axis view	
a	Semi-major axis from widest minor axis radius to apex	Distance in 2D General Measurements
d	Truncated semi-major axis from widest minor axis radius to mitral annulus plane	

■ Study Results

Except for the values in the upper table, the following results can be obtained in this study:

Tools	Descriptions	Formulae
LV Mass (T-E)	Left Ventricular Mass	*1
LV MASS-I (T-E)	Index of Left Ventricular Mass	See the LV Mass-I formula in “Left Ventricular Mass (LV Mass)”

*1 means:

$$LV\ Mass(g) = 1.05\pi \times \left\{ (b+t)^2 \times \left[\frac{2(a+t)}{3} + d - \frac{d^3}{3(a+t)^2} \right] - b^2 \times \left(\frac{2a}{3} + d - \frac{d^3}{3a^2} \right) \right\}$$

Where units of a, b, d, t are cm.

a: Semi-major axis from widest minor axis radius to apex

d: Truncated semi-major axis from widest minor axis radius to mitral annulus plane

t: Thickness of the myocardium

$$t\ (cm) = \sqrt{(LVAAd\ sax\ Epi(cm^2) / \pi)} - \sqrt{(LVAAd\ Sax\ Endo(cm^2) / \pi)}$$

b: Short axis radius, usually measured where the radius is largest.

$$b(cm) = \sqrt{(LVAAd\ Sax\ Endo(cm^2) / \pi)}$$

■ Operating Procedures

1. Select [LV Mass(T-E)] in the measurement menu or the touch screen.
2. In short-axis view at papillary muscle level at end diastole, measure the following parameters:
Endocardium area: LVAAd sax Endo
Epicardium area LVAAd sax Epi
3. Measure a and d.
The LV Mass(T-E) is calculated.
If the height and weight have already been entered, the LV Mass-I(T-E) is calculated.

6.4.3.3 Mitral Valve Area (MVA)

The Mitral Valve Area (MVA) can be calculated using two methods: pressure half time (PHT) or velocity-time integral (VTI).

Tip: The MVA Calculation by PHT method should be performed in CW mode. See MVA(PHT) in “6.3.3 Doppler Cardiac Measurement” for the formula for MVA calculated using the PHT method.

MVA(VTI)

■ Study Items

Tools	Descriptions	Operations
LVOT Diam.	Left Ventricular Outflow Tract Diameter	Distance in 2D General Measurements
LVOT VTI	Left Ventricular Outflow Tract Velocity-Time Integral	D trace in General D measurements
MV VTI	Mitral Valve Velocity-Time Integral	

■ Study Results

Except for the values in the upper table, the following results can be obtained in this study:

Tools	Descriptions	Formulae
MVA(VTI)	Mitral Valve Area	$MVA(VTI)(cm^2) = \frac{\pi \times LVOT VTI(cm) \times LVOT Diam(cm)^2}{4 \times MV VTI(cm) }$

■ Operating Procedures

See the table above for methods and formulae for the measurement items.

6.4.3.4 AVA(VTI)

The Aortic Valve Area (AVA) can be calculated by velocity-time integral (VTI). The measurements should be performed on 2D and Doppler images

■ Study Items

Tools	Descriptions	Operations
LVOT Diam.	Left Ventricular Outflow Tract Diameter	Distance in 2D General Measurements
LVOT VTI	Left Ventricular Outflow Tract Velocity-Time Integral	D trace in General D measurements
AV VTI	Aortic Valve Velocity-Time Integral	

■ Study Results

Except for the values in the upper table, the following results can be obtained in this study:

Tools	Descriptions	Formulae
AVA(VTI)	Aortic Valve Area	$AVA(VTI)(cm^2) = \frac{\pi \times LVOT VTI(cm) \times LVOT Diam(cm)^2}{4 \times AV VTI(cm) }$

■ Operating Procedures

See the table above for methods and formulae for the measurement items.

6.4.3.5 LA Vol.

LA Vol. (Left Atrium Volume) used to estimate the size of the left atrium.

LA Vol.(A-L)

Estimates the Left Atrium Volume using area and length.

■ Study Items

Tools	Descriptions	Operations
LA apical	Left Atrium Diameter	Distance in 2D General Measurements
LAA(A2C)	Left Atrium Area at apical 2-chamber view	Area in 2D General Measurements
LAA(A4C)	Left Atrium Area at apical 4-chamber view	

■ Study Results

Except for the values in the upper table, the following results can be obtained in this study:

Tools	Descriptions	Formulae
LA Vol.(A-L)	Left Atrium Area	$LA\ Vol(A-L)(ml) = \frac{8}{3\pi} LAA(A4C)(cm^2) \times LAA(A2C)(cm^2) / LA\ apical(cm)$
LA Vol. Index (A-L)	Left Atrium Area	LA Vol. Index = LA Vol./BSA

■ Operating Procedures

See the table above for methods and formulae for the measurement items.

LA Vol. (Simp)

Estimates the left atrium volume using the Simpson method. Performed at apical two-chamber view and apical four-chamber view.

■ Study Items and Results

Tools	Descriptions	Operations
LA Vol.(A2C)	Left Atrium Volume at apical 2-chamber view	Same as the Simpson SP measurement
LA Vol.(A4C)	Left Atrium Volume at apical 4-chamber view	
LA Vol. Index (A2C/A4C)	Left Atrium Volume Index	LA Vol. Index = LA Vol./BSA

■ Operating Procedures

See "Simpson" for measurement procedures.

6.4.3.6 LVIMP (LV Tei Index)

The LVIMP (Left Ventricular Index of Myocardial Performance) is used to analyze the integrative ventricular diastolic and systolic capabilities.

■ Study Items

Tools	Descriptions	Operations
MV C-O Dur.	Mitral Valve Close-Open Duration	Time in M/Doppler General Measurements

Tools	Descriptions	Operations
LVET	Left Ventricular Ejection Time	

■ Study Results

Except for the values in the upper table, the following results can be obtained in this study:

Tools	Descriptions	Formulae
LV Tei Index	Left Ventricular Index of Myocardial Performance	$LVIMP(Nounit) = \frac{MV C - O \text{ dur}(s) - LVET(s)}{LVET(s)}$

■ Operating Procedures

See the table above for methods and formulae for the measurement items.

6.4.3.7 RVSP

The RVSP measures the right ventricular systolic pressure.

■ Study Items

Tools	Descriptions	Operations
TR Vmax	Tricuspid Valve Regurgitation Maximum Velocity	D Vel. in Doppler General Measurements
RAP	Right Atrium Pressure	See below

■ Study Results

Except for the values in the upper table, the following results can be obtained in this study:

Tools	Descriptions	Formulae
TR PGmax	Tricuspid Valve Regurgitation Pressure Gradient	$TR PGmax (mmHg) = 4 \times TR Vmax (m/s)^2$
RVSP	Right Ventricular Systolic Pressure	$RVSP(mmHg) = RAP(mmHg) + 4 \times (TR V max(m / s))^2$

■ Operating Procedures

1. Select [RVSP] in the measurement menu or the touch screen.
2. Measure the TR Vmax in Doppler mode.
The TR PGmax is calculated.
3. Select [RAP] in the [RVSP] sub-menu and select (or enter) the pressure in the dialog box which appears, as shown in the figure below:

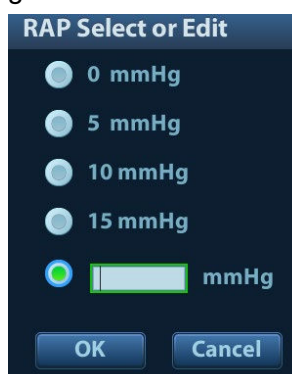

The range of input values is [0, 50.0 mmHg].

4. Click [OK] after selecting (or entering) the pressure. The RAP is obtained.

RVSP is calculated.

6.4.3.8 PAEDP

The PAEDP measures the pulmonary artery end diastolic pressure.

■ Study Items

Tools	Descriptions	Operations
PR Ved	Pulmonary Valve Regurgitation Velocity at end-Diastole	D Vel. in Doppler General Measurements
RAP	Right Atrium Pressure	See RAP measurement in "RVSP"

■ Study Results

Except for the values in the upper table, the following results can be obtained in this study:

Tools	Descriptions	Formulae
PR PGed	Pulmonary Valve Regurgitation Pressure Gradient at end-Diastole	/
PAEDP	Pulmonary Pressure at end-Diastole	$PAEDP(mmHg) = RAP(mmHg) + 4 \times (PR Ved(m/s))$

■ Operating Procedures

See the table above for methods and formulae for the measurement items.

6.4.3.9 RVIMP (RV Tei Index)

The measurement of RVIMP (Right Ventricular Index of Myocardial Performance) is similar to that of LVIMP.

■ Study Items

Tools	Descriptions	Operations
TV C-O Dur.	Tricuspid Valve Close-Open Duration	Time in Doppler General Measurements
RVET	Right Ventricular Ejection Time	

■ Study Results

Except for the values in the upper table, the following results can be obtained in this study:

Tools	Descriptions	Formulae
RV Tei Index	Right Ventricular Index of Myocardial Performance	$RVIMP(Nounit) = \frac{TV C - O dur(s) - RVET(s)}{RVET(s)}$

■ Operating Procedures

See the table above for methods and formulae for the measurement items.

6.4.3.10 Qp/Qs

Flow ratio of pulmonary circulation and systemic circulation.

■ Study Items

Tools	Descriptions	Operations
RVOT Diam.	Right Ventricular Outflow Tract Diameter	Distance in 2D General Measurements
LVOT Diam.	Left Ventricular Outflow Tract Diameter	

Tools	Descriptions	Operations
RVOT VTI	Right Ventricular Outflow Tract Velocity-Time Integral	D Trace in Doppler General Measurements
LVOT VTI	Left Ventricular Outflow Tract Velocity-Time Integral	

■ Study Results

Except for the values in the upper table, the following results can be obtained in this study:

Item	Description	Operations
RVOT SV	Right Ventricular Outflow Tract Stroke Volume	Obtained from the RVOT VTI measurement
RVOT CO	Right Ventricular Outflow Tract Cardiac Output	
RVOT SI	Right Ventricular Outflow Tract SV Index	
RVOT CI	Right Ventricular Output Tract CO Index	
RVOT Vmax	Right Ventricular Outflow Tract Maximum Velocity	
RVOT Vmean	Right Ventricular Outflow Tract Minimum Average Velocity	
RVOT PGmax	Right Ventricular Outflow Tract Maximum Pressure Gradient	
RVOT PGmean	Right Ventricular Outflow Tract Average Pressure Gradient	
LVOT SV	Left Ventricular Outflow Tract Stroke Volume	Obtained from the LVOT VTI measurement
LVOT SI	Left Ventricular Outflow Tract SV Index	
LVOT CO	Left Ventricular Outflow Tract Cardiac Output	
LVOT CI	Left Ventricular Output Tract CO Index	
LVOT Vmax	Left Ventricular Outflow Tract Maximum Velocity	
LVOT PGmax	Left Ventricular Outflow Tract Maximum Pressure Gradient	
LVOT Vmean	Left Ventricular Outflow Tract Average Velocity	
LVOT PGmean	Left Ventricular Outflow Tract Minimum Pressure Gradient	
Qp/Qs	Flow ratio of Pulmonary circulation and Systemic circulation	See below
Qp-Qs	Flow difference of Pulmonary circulation and Systemic circulation	

Where

$$Qp(ml) = RVOT\ SV(ml) = \pi(RVOT\ Diam(cm)/2)^2 \times RVOT\ VTI(cm)$$

$$Qs(ml) = LVOT\ SV(ml) = \pi(LVOT\ Diam(cm)/2)^2 \times LVOT\ VTI(cm)$$

$$Qp / Qs(Nounit) = \frac{RVOT\ SV(ml)}{LVOT\ SV(ml)}$$

$$Q_p - Q_s(\text{Nounit}) = \text{RVOT SV(ml)} - \text{LVOT SV(ml)}$$

■ Operating Procedures

See the table above for methods and formulae for the measurement items.

6.4.3.11 PISA

The PISA (Proximal Isovelocity Surface Area) is used in the quantitative analysis of the mitral valve regurgitation (PISA MR), aortic valve regurgitation (PISA AR), tricuspid valve regurgitation (PISA TR) and pulmonary valve regurgitation (PISA PR) in color mode.

The PISA measurement procedure is as follows:

1. Start PISA and move the semicircular caliper by rotating the trackball.
2. Fix the center of the semicircular caliper by pressing <Set>.
3. Adjust the radius length orientation of the semicircular caliper by rotating the trackball.
4. Press <Set> to fix the caliper.

PISA MR

Mitral valve regurgitation (PISA MR) needs to be measured in Color and Doppler modes.

■ Study Items

Tools	Descriptions	Operations
MR Rad	Mitral Valve Stenosis Radius	PISA measurement
MR VTI	Mitral Valve Regurgitation Velocity-Time Integral	D Trace in Doppler General Measurements
MR Als.Vel.	Mitral Valve Regurgitation Aliasing Maximum Velocity	You can choose to use the top aliasing velocity or bottom aliasing velocity, or enter the value directly.

■ Study Results

Tools	Descriptions	Formulae
MR Vmax	Mitral Regurgitation Maximum Velocity	Obtained from the MR VTI measurement
MR Flow	Mitral Regurgitation Flow	$\text{MR Flow(ml)} = \frac{2\pi \text{MR Rad(cm)}^2 \times \text{MR Als.Vel(cm/s)}}{ \text{MRV max(cm/s)} } \times \text{MR VTI(cm)} $
MR Flow Rate	Mitral Regurgitation Flow Rate	$\text{MR Flow Rate(ml/s)} = 2\pi \text{MR Rad(cm)}^2 \times \text{MR Als.Vel(cm/s)}$
MR Fraction	Mitral Valve Regurgitation Fraction	$\text{MR Fraction (Nounit)} = \frac{\text{MR Flow(ml)}}{\text{MV SV(ml)}} \times 100\%$
MR EROA	Mitral Valve Effective Regurgitant Orifice Area	$\text{MREROA(cm}^2\text{)} = \frac{2\pi \text{MR Rad(cm)}^2 \times \text{MR Als.Vel(cm/s)}}{ \text{MRVmax(cm/s)} }$

■ Operating Procedures

1. Enter color mode and adjust the color map until the aliasing appears.
2. Select [PISA MR] in the measurement menu or the touch screen.
3. Measure MR Rad using the PISA caliper.
Input MR Als.Vel.

4. Measure the MR spectrum using D trace to obtain:

MR Vmax

MR VTI

The MR Flow, MR Flow Rate and MR EROA are calculated automatically.

If the MV SV is measured, the MR Fraction will be calculated automatically.

PISA AR

Aortic valve regurgitation (PISA AR) needs to be measured in Color and Doppler modes.

■ Study Items

Tools	Descriptions	Operations
AR Rad.	Aortic Valve Stenosis Radius	PISA measurement
AR VTI	Aortic Valve Regurgitation Velocity-Time Integral	D Trace in Doppler General Measurements
AR Als.Vel.	Aortic Valve Regurgitation Aliasing Maximum Velocity	You can choose to use the top aliasing velocity or bottom aliasing velocity, or enter the value directly.

■ Study Results

Tools	Descriptions	Formulae
AR Vmax	Aortic Regurgitation Maximum Velocity	Obtained from the AR VTI measurement
AR Flow	Aortic Regurgitation Flow	$AR\ Flow(ml) = \frac{2\pi AR\ Rad(cm)^2 \times AR\ Als.Vel(cm/s)}{ ARV\ max(cm/s) } \times AR\ VTI(cm)$
AR Flow Rate	Aortic Regurgitation Flow Rate	$AR\ Flow\ Rate(ml/s) = 2\pi AR\ Rad(cm)^2 \times AR\ Als.Vel(cm/s)$
AR Fraction	Aortic Valve Regurgitation Fraction	$AR\ Fraction\ (Nounit) = \frac{AR\ Flow(ml)}{AV\ SV(ml)} \times 100\%$
AR EROA	Aortic Valve Effective Regurgitant Orifice Area	$AREROA(cm^2) = \frac{2\pi ARRad(cm)^2 \times ARAls.Vel(cm/s)}{ ARVmax(cm/s) }$

■ Operating Procedures

Same as the PISA MR measurement.

PISA TR

Tricuspid valve regurgitation (PISA TR) needs to be measured in Color and Doppler modes.

■ Study Items

Tools	Descriptions	Operations
TR Rad.	Tricuspid Valve Stenosis Radius	PISA measurement
TR VTI	Tricuspid Valve Regurgitation Velocity-Time Integral	D Trace in Doppler General Measurements

Tools	Descriptions	Operations
TR Als.Vel.	Tricuspid Valve Regurgitation Aliasing Maximum Velocity	You can choose to use the top aliasing velocity or bottom aliasing velocity, or enter the value directly.

■ Study Results

Tools	Descriptions	Formulae
TR Vmax	Tricuspid Regurgitation Maximum Velocity	Obtained from TR VTI measurement
TR Flow	Tricuspid Regurgitation Flow	$\text{TR Flow(ml)} = \frac{2\pi \text{TR Rad(cm)}^2 \times \text{TR Als.Vel(cm/s)}}{ \text{TRV max(cm/s)} } \times \text{TR VTI(cm)} $
TR Flow Rate	Tricuspid Regurgitation Flow Rate	$\text{TR Flow Rate(ml/s)} = 2\pi \text{TR Rad(cm)}^2 \times \text{TR Als.Vel(cm/s)}$
TR Fraction	Tricuspid Valve Regurgitation Fraction	$\text{TR Fraction (Nounit)} = \frac{\text{TR Flow(ml)}}{\text{TV SV(ml)}} \times 100\%$
TR EROA	Tricuspid Valve Effective Regurgitant Orifice Area	$\text{TR EROA(cm}^2\text{)} = \frac{2\pi \text{TR Rad(cm)}^2 \times \text{TR Als.Vel(cm/s)}}{ \text{TRVmax(cm/s)} }$

■ Operating Procedures

Same as the PISA MR measurement.

PISA PR

Pulmonary valve regurgitation (PISA PR) needs to be measured in Color and Doppler modes.

■ Study Items

Tools	Descriptions	Operations
PR Rad.	Pulmonary Valve Stenosis Radius	PISA measurement
PR VTI	Pulmonary Valve Regurgitation Velocity-Time Integral	D Trace in Doppler General Measurements
PR Als.Vel.	Pulmonary Valve Regurgitation Aliasing Maximum Velocity	You can choose to use the top aliasing velocity or bottom aliasing velocity, or enter the value directly.

■ Study Results

Tools	Descriptions	Formulae
PR Vmax	Pulmonary Regurgitation Maximum Velocity	Obtained from PR VTI measurement
PR Flow	Pulmonary Regurgitation Flow	$\text{PR Flow(ml)} = \frac{2\pi \text{PR Rad(cm)}^2 \times \text{PR Als.Vel(cm/s)}}{ \text{PRV max(cm/s)} } \times \text{PR VTI(cm)} $

Tools	Descriptions	Formulae
PR Flow Rate	Pulmonary Regurgitation Flow Rate	$PR \text{ Flow Rate(ml/s)} = 2\pi PR \text{ Rad(cm)}^2 \times PR \text{ Als.Vel(cm/s)}$
PR Fraction	Pulmonary Valve Regurgitation Fraction	$PR \text{ Fraction (Nounit)} = \frac{PR \text{ Flow(ml)}}{PV \text{ SV(ml)}} \times 100\%$
PR EROA	Pulmonary Valve Effective Regurgitant Orifice Area	$PR \text{ EROA(cm}^2) = \frac{2\pi PR \text{ Rad(cm)}^2 \times PR \text{ Als.Vel(cm/s)}}{ PR \text{ Vmax(cm/s)} }$

■ Operating Procedures

Same as the PISA MR measurement.

6.4.3.12 TDI

■ Study Items

Tools	Descriptions	Operations
MV Sa(medial)	Mitral Valve medial Systolic motion	D Vel. in Doppler General Measurements
MV Ea(medial)	Mitral Valve medial Early diastolic motion	
MV Aa(medial)	Mitral Valve medial Late diastolic motion	
MV ARa(medial)	Mitral Valve medial Acceleration Rate	Acceleration in Doppler General Measurements
MV DRa(medial)	Mitral Valve medial Deceleration Rate	
MV Sa(lateral)	Mitral Valve lateral Systolic motion	D Vel. in Doppler General Measurements
MV Ea(lateral)	Mitral Valve lateral Early diastolic motion	
MV Aa(lateral)	Mitral Valve lateral Late diastolic motion	
MV ARa(lateral)	Mitral Valve lateral Acceleration Rate	Acceleration in Doppler General Measurements
MV DRa(lateral)	Mitral Valve lateral Deceleration Rate	

■ Study Results

Tools	Descriptions	Formulae
MV Ea/Aa(medial)	MV medial E-Vel./A-Vel.	$Ea/Aa(medial)(Nounit) = \frac{Ea(medial)}{Aa(medial)}$
ATa(medial)	MV medial E-wave Acceleration Time	Obtained from the ARa(medial) measurement
DTa(medial)	MV medial E-wave Deceleration Time	Obtained from the DRa(medial) measurement
MV Ea/Aa(lateral)	MV lateral E-Vel./A-Vel.	$Ea/Aa(lateral)(Nounit) = \frac{Ea(laterall)}{Aa(laterall)}$
MV E/Ea(medial)	Used to estimate the diastolic function of left ventricular	Calculate after measuring MV E Vel and MV Ea(medial): $MV \text{ E/Ea(medial)(Nounit)} = \frac{MV \text{ E Vel}}{MV \text{ Ea(medial)}}$

Tools	Descriptions	Formulae
MV E/Ea(lateral)		Calculate after measuring MV E Vel and MV Ea(lateral): $MV\ E/Ea(lateral)(Nounit) = \frac{MV\ E\ Vel}{MV\ Ea(lateral)}$
MV E/Ea(medial+lateral)		Calculate after measuring MV E Vel, MV Ea(medial) and MV Ea(lateral) $E / Ea(medial + lateral)(Nounit) = \frac{MV\ E\ Vel(cm / s)}{(MVEa(medial)(cm / s) + MVEa(lateral)(cm / s))/2}$
ATa(lateral)	MV lateral E-wave Acceleration Time	Obtained from the ARa(lateral) measurement
DTa(lateral)	MV lateral E-wave Deceleration Time	Obtained from the DRa(lateral) measurement

■ Operating Procedures

See the table above for methods and formulae for the measurement items.

6.4.3.13 Z Score

Z Score indicates the standard deviation of the individually measured value against the mean value. Referenced pediatric cardiac value is corrected by the height, weight, and body surface. Z Scores that is standardly transformed is used to evaluate the cardiac measurement values, to define the distribution of the measurement result of an individual pediatric among those of the healthy pediatrics.

The Z-Score study is effective for pediatrics aged under 18 years old.

Formula:

Z-Score = (measured actual value - population mean value)/population standard deviation

Operating procedures:

1. Input the DOB (age), weight, and height in the <Patient>→ [CARD];
2. Select Z-Score related items in the measurement menu for performing measurement.
3. Check the Z-Score result in the <Report> page.

6.5 Cardiac Exam Report

During or after a measurement, click [Report] on the touch screen to browse the report.

For details about report browsing, printing and exporting, etc., see “1.7 Report.”

6.6 References

Body Surface Area (BSA):

- DuBois, D., DuBois, E.F., "A Formula to Estimate the Approximate Surface Area if Height and Weight Be Known," *Nutrition*, Sept-Oct 1989, Vol. 5, No. 5, pp. 303-313.

EDV(S-P Ellipse):

- Folland, E.D., et al., "Assessment of Left Ventricular Ejection Fraction and Volumes by Real-Time, Two-Dimensional Echocardiography," *Circulation*, October 1979, Vol. 60, No.4, pp. 760-766

ESV(S-P Ellipse):

- Folland, E.D., et al., "Assessment of Left Ventricular Ejection Fraction and Volumes by Real-Time, Two-Dimensional Echocardiography," *Circulation*, October 1979, Vol. 60, No.4, pp. 760-766.

Stroke Volume (SV):

- Gorge, G., et al., "High Resolution Two-dimensional Echocardiography Improves the Quantification of Left Ventricular Function," *Journal of the American Society of Echocardiography*, 1992, 5: 125-34.
- Roelandt, Joseph, *Practical Echocardiology*, vol. 1 of *Ultrasound in Medicine Series*, ed. Denis White, Research Studies Press, 1977, p. 124.

Ejection Fraction (EF):

- Pombo, J.F., "Left Ventricular Volumes and Ejection by Echocardiography," *Circulation*, 1971, Vol. 43, pp. 480-490.

Stroke Volume Index (SI):

- Gorge, G., et al., "High Resolution Two-dimensional Echocardiography Improves the Quantification of Left Ventricular Function," *Journal of the American Society of Echocardiography*, 1992, 5: 125-34.
- Roelandt, Joseph, *Practical Echocardiology*, vol. 1 of *Ultrasound in Medicine Series*, ed. Denis White, Research Studies Press, 1977, p. 124.

Cardiac Output (CO):

- Belenkie, Israel, et al., "Assessment of Left Ventricular Dimensions and Function by Echocardiography," *American Journal of Cardiology*, June 1973, Vol. 31

Cardiac output Index (CI):

- *The Merck Manual of Diagnosis and Therapy*, ed. 15, Robert Berkon, ed., Merck and Co., Rahway, NJ, 1987, p. 378.
- Schiller, N.B., et al., "Recommendations for Quantification of the LV by Two-Dimensional Echocardiography," *J Am Soc Echo*, Sept.-Oct., 1989, Vol. 2, No. 5,p. 364.

EDV(B-P Ellipse):

- Folland, E.D., et al., "Assessment of Left Ventricular Ejection Fraction and Volumes by Real-Time, Two-Dimensional Echocardiography," *Circulation*, October 1979, Vol. 60, No.4, pp. 760-766

ESV(B-P Ellipse):

- Folland, E.D., et al., "Assessment of Left Ventricular Ejection Fraction and Volumes by Real-Time, Two-Dimensional Echocardiography," *Circulation*, October 1979, Vol. 60, No.4, pp. 760-766

EDV (Bullet):

- Folland, E.D., et al., "Assessment of Left Ventricular Ejection Fraction and Volumes by Real-Time, Two-Dimensional Echocardiography," *Circulation*, October 1979, Vol. 60, No.4, pp. 760-766

ESV (Bullet):

- Folland, E.D., et al., "Assessment of Left Ventricular Ejection Fraction and Volumes by Real-Time, Two-Dimensional Echocardiography," *Circulation*, October 1979, Vol. 60, No.4, pp. 760-766

EDV (Simpson):

- Weyman, Arthur E., *Cross-Sectional Echocardiography*, Lea & Febiger, 1985, p. 295. Folland, E.D., et al., "Assessment of Left Ventricular Ejection Fraction and Volumes by Real-Time, Two-Dimensional Echocardiography," *Circulation*, October 1979, Vol. 60, No.4, pp. 760-766

ESV (Simpson):

- Weyman, Arthur E., *Cross-Sectional Echocardiography*, Lea & Febiger, 1985, p. 295. Folland, E.D., et al., "Assessment of Left Ventricular Ejection Fraction and Volumes by Real-Time, Two-Dimensional Echocardiography," *Circulation*, October 1979, Vol. 60, No.4, pp. 760-766

EDV (Simpson SP):

- Schiller, N.B., et al., "Recommendations for Quantification of the LV by Two-Dimensional Echocardiography," *Journal of the American Society of Echocardiography*, Sept-Oct 1989, Vol.2, No. 5, p. 364

ESV (Simpson SP):

- Schiller, N.B., et al., "Recommendations for Quantification of the LV by Two-Dimensional Echocardiography," *Journal of the American Society of Echocardiography*, Sept-Oct 1989, Vol.2, No. 5, p. 364

EDV (Simpson BP):

- Schiller, N.B., et al., "Recommendations for Quantification of the LV by Two-Dimensional Echocardiography," *Journal of the American Society of Echocardiography*, Sept-Oct 1989, Vol.2, No. 5, p. 364

ESV (Simpson BP):

- Schiller, N.B., et al., "Recommendations for Quantification of the LV by Two-Dimensional Echocardiography," *Journal of the American Society of Echocardiography*, Sept-Oct 1989, Vol.2, No. 5, p. 364

EDV (Cube):

- Dodge, H.T., Sandler, D.W., et al., "The Use of Biplane Angiography for the Measurement of Left Ventricular Volume in Man," *American Heart Journal*, 1960, Vol. 60, pp. 762-776.
- Belenkie, Israel, et al., "Assessment of Left Ventricular Dimensions and Function by Echocardiography," *American Journal of Cardiology*, June 1973, pg. 31.

ESV (Cube):

- Dodge, H.T., Sandler, D.W., et al., "The Use of Biplane Angiography for the Measurement of Left Ventricular Volume in Man," *American Heart Journal*, 1960, Vol. 60, pp. 762-776.
- Belenkie, Israel, et al., "Assessment of Left Ventricular Dimensions and Function by Echocardiography," *American Journal of Cardiology*, June 1973, pg. 31.

Fractional Shortening (FS):

- Belenkie, Israel, et al., "Assessment of Left Ventricular Dimensions and Function by Echocardiography," *American Journal of Cardiology*, June 1973, Vol. 31.

MVCF:

- Colan, S.D., Borow, K.M., Neumann, A., "Left Ventricular End-Systolic Wall Stress-Velocity of Fiber Shortening Relation: A Load-Independent Index of Myocardial Contractility," *J Amer Coll Cardiol*, October, 1984, Vol. 4, No. 4, pp. 715-724.
- Snider, A.R., Serwer, G.A., *Echocardiography in Pediatric Heart Disease*, Year Book Medical Publishers, Inc., Littleton, MA, 1990, p. 83.

Teichholz:

- Teichholz, L.E., et al., "Problems in Echocardiographic Volume Determinations: Echocardiographic-Angiographic Correlations in the Presence or Absence of Asynergy," American Journal of Cardiology, January 1976, Vol. 37, pp. 7-11

LVMW:

- John H. Phillips, "Practical Quantitative Doppler Echocardiography", CRC Press, 1991, Page 96.

LV MASS-I:

- John H. Phillips, "Practical Quantitative Doppler Echocardiography", CRC Press, 1991, Page 96.

LA/Ao:

- Roelandt, Joseph, Practical Echocardiology, Ultrasound in Medicine Series, Vol. 1, Denis White, ed., Research Studies Press, 1977, p. 270.
- Schiller, N.B., et al., "Recommendations for Quantification of the LV by Two-Dimensional Echocardiography," J Am Soc Echo, Sept-Oct, 1989, Vol. 2, No. 5, p. 364.

MV CA/CE:

- Maron, Barry J., et al., "Noninvasive Assessment of Left Ventricular Diastolic Function by Pulsed Doppler Echocardiography in Patients with Hypertrophic Cardiomyopathy," J Am Coll Cardio, 1987, Vol. 10, pp. 733-742.

MV E/A:

- Maron, Barry J., et al., "Noninvasive Assessment of Left Ventricular Diastolic Function by Pulsed Doppler Echocardiography in Patients with Hypertrophic Cardiomyopathy," Journal of the American College of Cardiology, 1987, Vol. 10, pp. 733-742.

Pressure Half Time (PHT):

- Oh, J.K., Seward, J.B., Tajik, A.J. The Echo Manual. Boston: Little, Brown and Company, 1994, p.59-60

Mitral valve area:

- Goldberg, Barry B., Kurtz, Alfred B., Atlas of Ultrasound Measurements, Year Book Medical Publishers, Inc., 1990, p. 65.
- Stamm, R. Brad, et al., "Quantification of Pressure Gradients Across Stenotic Valves by Doppler Ultrasound," J Am Coll Cardiol, 1983, Vol. 2, No. 4, pp. 707-718.

Right Ventricular Systolic Pressure:

- Stevenson, J.G., "Comparison of Several Noninvasive Methods for Estimation of Pulmonary Artery Pressure," Journal of the American Society of Echocardiography, June 1989, Vol. 2, pp. 157-171.
- Yock, Paul G. and Popp, Richard L., "Noninvasive Estimation of Right Ventricular Systolic Pressure by Doppler Ultrasound in Patients with Tricuspid Regurgitation," Circulation, 1984, Vol. 70, No. 4, pp. 657-662.

E/Ea:

- Recommendations for the Evaluation of Left Ventricular Diastolic Function by Echocardiography" 2009 Published by Elsevier Inc. on behalf of the American Society of Echocardiography.

LVIDd/LVPWd

"Recommendations for Cardiac Chamber Quantification by Echocardiography in Adults: An Update from the American Society of Echocardiography and the European Association of Cardiovascular Imaging" J Am Soc Echocardiogr 2015;28:1-39.

Cantinotti M;Scalese M;Murzi B;Assanta N;Spadoni I;Festa P;De Lucia V;Crocetti M;Marotta M;Molinari S;Lopez L;Iervasi G. Echocardiographic nomograms for ventricular, valvular and arterial dimensions in caucasian children with a special focus on neonates, infants and toddlers. J Am Soc Echocardiogr 2014; 27: 179-191 (e2).

Cantinotti M, Scalese M, Murzi B, Assanta N, Spadoni I, et al. Echocardiographic Nomograms for Chamber Diameters and Areas in Caucasian Children. *J Am Soc Echocardiogr* 2014; 27: 1279-1292 (e2).

Tau(BAI)

Bai Xufang, Wen Chaoyang, "Current situation and prospects of left ventricular diastolic time constant (Tau) non-invasive measurement", *Chin J Med Imaging Technol*, 2015, Vol 31, No 10

Z-Score

- Cantinotti M;Scalese M;Murzi B;Assanta N;Spadoni I;Festa P;De Lucia V;Crocetti M;Marotta M;Molinaro S;Lopez L;Iervasi G. Echocardiographic nomograms for ventricular, valvular and arterial dimensions in caucasian children with a special focus on neonates, infants and toddlers. *J Am Soc Echocardiogr* 2014; 27: 179-191 (e2).
- Cantinotti M, Scalese M, Murzi B, Assanta N, Spadoni I, et al. Echocardiographic Nomograms for Chamber Diameters and Areas in Caucasian Children. *J Am Soc Echocardiogr* 2014; 27: 1279-1292 (e2).

7 Vascular

7.1 Vascular Exam Preparations

Make the following preparations before measuring:

1. Confirm that the current probe is appropriate.
2. Check that the current system date is correct.
3. Click [Info] on the touch screen and enter the patient information on the [Patient Info] → [VAS] page.
For more details, see “Exam Preparation → Patient Information” in the Operator’s Manual [Basic Volume].
4. Switch to the correct exam mode.

7.2 Basic Vascular Measurement Procedures

1. Click [Info] on the touch screen and enter the patient information on the [Patient Info] → [VAS] page.
2. Press <Measure> to enter the Application Measurement.
3. Select the measurement tool from the menu or the touch screen to start the measurement.
See the table in “7.3 Vascular Measurement Tools” below for measurement tools.
See section “7.4 Vascular Measurement Operations” and steps in “3 General Measurement” for measurement methods.
4. Click [Report] on the touch screen to view the exam report. See “7.5 Vascular Exam Report” for details.

7.3 Vascular Measurement Tools

Vascular measurements are mainly used for carotid, cerebral, upper and lower extremity vessels. The system supports the following 2D and Doppler vascular measurements.

NOTE: The measurement tools mentioned below are configured in the system. The application measurement packages provided in this system are generally different combinations of measurement tools.

2D Vascular Measurements

Types	Tools	Descriptions	Methods or formulae
Measurement	CCA IMT	Common Carotid Artery IMT	ROI measurement in IMT
	Bulb IMT	Bulb IMT	
	ICA IMT	Internal Carotid Artery IMT	
	ECA IMT	External Carotid Artery IMT	
	Axillary V AP	Axillary Vein Anterior-Posterior	Distance in 2D General Measurements
	Brachial V AP	Brachial Vein Anterior-Posterior	
	Radial V AP	Radial Vein Anterior-Posterior	
	Ulnar V AP	Ulnar Vein Anterior-Posterior	
	Cephalic V AP	Cephalic Vein Anterior-Posterior	
	Basilic V AP	Basilic Vein Anterior-Posterior	
	C.Iliac V AP	Common Iliac Vein Anterior-Posterior	
	Ex.Iliac V AP	External Iliac Vein Anterior-Posterior	
	IIV AP	Internal Iliac Vein Anterior-Posterior	
	CFV AP	Common Femoral Vein Anterior-Posterior	
Femoral V AP	Femoral Vein Anterior-Posterior		
DFV AP	Deep Femoral Vein Anterior-Posterior		

Types	Tools	Descriptions	Methods or formulae
	Pop V AP	Popliteal Vein Anterior-Posterior	
	P.Tib. V AP	Posterior Tibial Vein Anterior- Posterior	
	Peroneal V AP	Peroneal Vein Anterior-Posterior	
	Sural V AP	Sural Vein Anterior-Posterior	
	Soleal V AP	Soleal Vein Anterior-Posterior	
	A.Tib. V AP	Anterior Tibial Vein Anterior-Posterior	
	TP Trunk V AP	Tibial Peroneal Trunk Vein Anterior-Posterior	
	Saph V AP	Great Saphenous Vein Anterior- Posterior	
	SSV AP	Small Saphenous Vein Anterior- Posterior	
	C.Iliac V Trans	Common Iliac Vein Trans	
	Ex.Iliac V Trans	External Iliac Vein Trans	
	IIV Trans	Internal Iliac Vein Trans	
	CFV Trans	Common Femoral Vein Trans	
	Femoral V Trans	Femoral Vein Trans	
	DFV Trans	Deep Femoral Vein Trans	
	Pop V Trans	Popliteal Vein Trans	
	P.Tib. V Trans	Posterior Tibial Vein Trans	
	Peroneal V Trans	Peroneal Vein Trans	
	Sural V Trans	Sural Vein Trans	
	Soleal V Trans	Soleal Vein Trans	

Types	Tools	Descriptions	Methods or formulae
	A.Tib. V Trans	Anterior Tibial Vein Trans	
	TP Trunk V Trans	Tibial Peroneal Trunk Vein Trans	
	SF Junction AP	the Junction of Great Saphenous Vein and Femoral Vein Anterior- Posterior	
	GSV Thigh AP	Great Saphenous Vein Thigh Anterior-Posterior	
	GSV Knee AP	Great Saphenous Vein Knee Anterior-Posterior	
	GSV Calf AP	Great Saphenous Vein Calf Anterior- Posterior	
	SP Junction AP	the Junction of Small Saphenous Vein and Popliteal Vein Anterior- Posterior	
	SSV Thigh Extension AP	Small Saphenous Vein Thigh Extension Anterior- Posterior	
	AASV AP	Anterior Accessory Saphenous Vein Anterior-Posterior	
	PASV AP	Posterior Accessory Saphenous Vein Anterior-Posterior	
	SFV	Superficial Femoral Vein	
	Saph V Trans	Great Saphenous Vein Trans	
	SSV Trans	Small Saphenous Vein Trans	
	SF Junction Trans	the Junction of Great Saphenous Vein and Femoral Vein Trans	
	GSV Thigh Trans	Great Saphenous Vein Thigh Trans	

Types	Tools	Descriptions	Methods or formulae
	GSV Knee Trans	Great Saphenous Vein Knee Trans	
	GSV Calf Trans	Great Saphenous Vein Calf Trans	
	SP Junction Trans	the Junction of Small Saphenous Vein and Popliteal Vein Trans	
	SSV Thigh Extension Trans	Small Saphenous Vein Thigh Extension Trans	
	AASV Trans	Anterior Accessory Saphenous Vein Trans	
	PASV Trans	Posterior Accessory Saphenous Vein Trans	
	Int Jug V AP	Internal Jugular Vein Anterior-Posterior	
	Innom V AP	Innominate Vein Anterior-Posterior	
	Subclav V AP	Subclavian Vein Anterior-Posterior	
	Volar V AP	Volar Vein Anterior-Posterior	
	Axillary V Trans	Axillary Vein Trans	
	Brachial V Trans	Brachial Vein Trans	
	Radial V Trans	Radial Vein Trans	
	Ulnar V Trans	Ulnar Vein Trans	
	Int Jug V Trans	Internal Jugular Vein Trans	
	Innom V Trans	Innominate Vein Trans	
	Subclav V Trans	Subclavian Vein Trans	
	Volar V Trans	Volar Vein Trans	

Types	Tools	Descriptions	Methods or formulae
	CA Junction AP	Cephalic Vein and Axillary Vein Junction Anterior-Posterior	
	Upper Arm Cephalic V AP	Upper Arm Cephalic Vein Anterior-Posterior	
	Cephalic-Antecubital V AP	Cephalic AnteCubital Vein Anterior-Posterior	
	Forearm Cephalic V AP	Forearm Cephalic Vein Anterior-Posterior	
	BA Junction AP	Basilic Vein and Axillary Vein Junction Anterior-Posterior	
	Upper Arm Basilic V AP	Upper Arm Basilic Vein Anterior-Posterior	
	Basilic-Antecubital V AP	Basilic AnteCubital Vein Anterior-Posterior	
	Forearm Basilic V AP	Forearm Basilic Vein Anterior-Posterior	
	Digital V AP	Digital Vein Anterior-Posterior	
	Median Cubital V AP	Median Cubital V Anterior-Posterior	
	Cephalic V Trans	Cephalic Vein Trans	
	Basilic V Trans	Basilic Vein Trans	
	CA Junction Trans	Cephalic Vein and Axillary Vein Junction Trans	
	Upper Arm Cephalic V Trans	Upper Arm Cephalic Vein Trans	
	Cephalic-Antecubital V Trans	Cephalic AnteCubital Vein Trans	
	Forearm Cephalic V Trans	Forearm Cephalic Vein Trans	

Types	Tools	Descriptions	Methods or formulae
	BA Junction Trans	Basilic Vein and Axillary Vein Junction Trans	
	Upper Arm Basilic V Trans	Upper Arm Basilic Vein Trans	
	Basilic-Antecubital V Trans	Basilic AnteCubital Vein Trans	
	Forearm Basilic V Trans	Forearm Basilic Vein Trans	
	Digital V Trans	Digital Vein Trans	
	Median Cubital V Trans	Median Cubital V Trans	
	C.Iliac V Status	Common Iliac Vein Status	
	Ex.Iliac V Status	External Iliac Vein Status	
	IIV Status	Internal Iliac Vein Status	
	CFV Status	Common Femoral Vein Status	
	Femoral V Status	Femoral Vein Status	
	DFV Status	Deep Femoral Vein Status	
	Pop V Status	Popliteal Vein Status	Tick the status.
	P.Tib. V Status	Posterior Tibial Vein Status	Choose from: Cmp (Compression); Sp (Spontenaity); Ph (phasicity); Aug (Augmentation); Rflx (Reflux); N/A
	Peroneal V Status	Peroneal Vein Status	
	Sural V Status	Sural Vein Status	
	Soleal V Status	Soleal Vein Status	
	A.Tib. V Status	Anterior Tibial Vein Status	
	TP Trunk V Status	Tibial Peroneal Trunk Vein Status	
	Saph V Status	Great Saphenous Vein Status	

Types	Tools	Descriptions	Methods or formulae
	SSV Status	Small Saphenous Vein Status	
	SF Junction Status	the Junction of Great Saphenous Vein and Femoral Vein Status	
	GSV Thigh Status	Great Saphenous Vein Thigh Status	
	GSV Knee Status	Great Saphenous Vein Knee Status	
	GSV Calf Status	Great Saphenous Vein Calf Status	
	SP Junction Status	the Junction of Small Saphenous Vein and Popliteal Vein Status	
	SSV Thigh Extension Status	Small Saphenous Vein Thigh Extension Status	
	AASV Status	Anterior Accessory Saphenous Vein Status	
	PASV Status	Posterior Accessory Saphenous Vein Status	
	Axillary V Status	Axillary Vein Status	
	Brachial V Status	Brachial Vein Status	
	Radial V Status	Radial Vein Status	
	Ulnar V Status	Ulnar Vein Status	
	Int Jug V Status	Internal Jugular Vein Status	
	Innom V Status	Innominate Vein Status	
	Subclav V Status	Subclavian Vein Status	
	Volar V Status	Volar Vein Status	
	Cephalic V Status	Cephalic Vein Status	
	Basilic V Status	Basilic Vein Status	

Types	Tools	Descriptions	Methods or formulae
	CA Junction Status	Cephalic Vein and Axillary Vein Junction Status	
	Upper Arm Cephalic V Status	Upper Arm Cephalic Vein Status	
	Cephalic-Antecubital V Status	Cephalic AnteCubital Vein Status	
	Forearm Cephalic V Status	Forearm Cephalic Vein Status	
	BA Junction Status	Basilic Vein and Axillary Vein Junction Status	
	Upper Arm Basilic V Status	Upper Arm Basilic Vein Status	
	Basilic-Antecubital V Status	Basilic AnteCubital Vein Status	
	Forearm Basilic V Status	Forearm Basilic Vein Status	
	Digital V Status	Digital Vein Status	
	Median Cubital V Status	Median Cubital V Status	
Calculation	Stenosis D	Stenosis Diameter	<p>Stenosis D (No unit) = (Normal Diam. (cm) – Resid Diam. (cm)) / Normal Diam. (cm) × 100%</p> <p>Stenosis D (No unit) = $(D1-D2) / \text{MAX}(D1, D2) \times 100\%$</p> <p>Where D1 and D2 refer to the measured vascular diameter, and MAX (D1, D2) represents the larger value of the two.</p>
	Stenosis A	Stenosis Area	<p>Stenosis A (No unit) = $(A1-A2) / \text{MAX}(A1, A2) \times 100\%$</p> <p>Where A1 and A2 refer to the measured vascular area, and MAX (A1, A2) represents the larger value of the two.</p>
Study	IMT	Intima-Media Thickness	See below
	CCA	Common Carotid Artery	<ul style="list-style-type: none"> Anterior-Posterior, Transverse Same as the Distance measurement in 2D General Measurements
	Bulb	Bulbillate	

Types	Tools	Descriptions	Methods or formulae
	Carotid Bifurcation	Carotid Bifurcation	<ul style="list-style-type: none"> ● Stenosis <p>Stenosis Diameter (No unit) = $(Outer\ D - Inner\ D) / MAX(Outer\ D, Inner\ D) * 100\%$</p> <p>Where Outer D and Inner D refer to the measured vascular diameter, and MAX (Outer D, Inner D) represents the larger value of the two.</p> <p>Stenosis Area (No unit) = $(Outer\ A - Inner\ A) / MAX(Outer\ A, Inner\ A) * 100\%$</p> <p>Where Outer A and Inner A refer to the measured vascular area, and MAX (Outer A, Inner A) represents the larger value of the two.</p>
	ICA	Internal Carotid Artery	
	ECA	External Carotid Artery	
	Vert A	Vertebral Artery	
	Subclav A	Subclavian Artery	
	Innom A	Brachiocephalic	
	Mammary A	Mammary A	
	CCA Aneurysm	Common Carotid Arterial Aneurysm	<p>Anterior-Posterior, Transverse, Long</p> <p>Same as the Distance measurement in 2D General Measurements</p>
	Bulb Aneurysm	Bulbillate Aneurysm	
	Carotid Bifurcation Aneurysm	Carotid Bifurcation Aneurysm	
	ICA Aneurysm	Internal Carotid Arterial Aneurysm	
	ECA Aneurysm	External Carotid Arterial Aneurysm	
	Vert A Aneurysm	Vertebral Arterial Aneurysm	
	Subclav A Aneurysm	Subclavian Arterial Aneurysm	
	Innom A Aneurysm	Brachiocephalic Aneurysm	
	Mammary A Aneurysm	Mammary Arterial Aneurysm	
	Carotid Graft 1-3 Anast	Carotid Graft 1-3 Anastomosis	
	Carotid Graft 1-3 Graft	Carotid Graft 1-3 Graft	
	Carotid Stent 1-3	/	
	Carotid Stenosis 1-4 2D	/	
	Axill A	Axillary Artery	<ul style="list-style-type: none"> ● Anterior-Posterior, Transverse ● Stenosis <p>Same as the Distance measurement in 2D General Measurements</p> <p>Stenosis Diameter (No unit) = $(Outer\ D - Inner\ D) / MAX(Outer\ D, Inner\ D) * 100\%$</p>
	Brachial A	Brachial Artery	
	Radial A	Radial Artery	

Types	Tools	Descriptions	Methods or formulae
	Ulnar A	Ulnar Artery	Where Outer D and Inner D refer to the measured vascular diameter, and MAX (Outer D, Inner D) represents the larger value of the two. Stenosis Area (No unit) = $ (Outer A - Inner A) / MAX (Outer A, Inner A) * 100%$ Where Outer A and Inner A refer to the measured vascular area, and MAX (Outer A, Inner A) represents the larger value of the two.
	Axill A Aneurysm	Axillary Artery Aneurysm	Anterior-Posterior, Transverse, Long Same as the Distance measurement in 2D General Measurements
	Brachial A Aneurysm	Brachial Artery Aneurysm	
	Radial A Aneurysm	Radial Artery Aneurysm	
	Ulnar A Aneurysm	Ulnar Artery Aneurysm	
	UE A Graft 1-3 Native Inflow	Upper External Arterial Graft 1-3 Native Inflow	Anterior-Posterior, Transverse Same as the Distance measurement in 2D General Measurements
	UE A Graft 1-3 Anast	Upper External Arterial Graft 1-3 Anastomosis	
	UE A Graft 1-3 Graft	Upper External Arterial Graft 1-3 Graft	
	UE A Graft 1-3 Native Outflow	Upper External Arterial Graft 1-3 Native Outflow	
	UE A Stent 1-3	Upper External Arterial Stent 1-3	Anterior-Posterior, Transverse, Long, Depth Same as the Distance measurement in 2D General Measurements
	UE A Stenosis 1-4 2D	Upper External Arterial Stenosis 1-4	<ul style="list-style-type: none"> ● Anterior-Posterior, Transverse Same as the Distance measurement in 2D General Measurements ● Stenosis Stenosis Diameter (No unit) = $(Outer D - Inner D) / MAX (Outer D, Inner D) * 100%$ Where Outer D and Inner D refer to the measured vascular diameter, and MAX (Outer D, Inner D) represents the larger value of the two. Stenosis Area (No unit) = $(Outer A - Inner A) / MAX (Outer A, Inner A) * 100%$ Where Outer A and Inner A refer to the
	C.Iliac A	Common Iliac Artery	
	Ex.Iliac A	External Iliac Artery	
	IIA	Internal Iliac Artery	
	CFA	Common Femoral Artery	
	DFA	Deep Femoral Artery	

Types	Tools	Descriptions	Methods or formulae
	SFA	Superficial Femoral Artery	measured vascular area, and MAX (Outer A, Inner A) represents the larger value of the two.
	Pop A	Popliteal Artery	
	TP Trunk A	Tibial Peroneal Trunk Artery	
	A.Tib A	Anterior Tibial Artery	
	Peroneal A	Peroneal Artery	
	P.Tib A	Posterior Tibial Artery	
	Dors.Ped. A	Dorsalis Pedis Artery	
	C.Iliac A Aneurysm	Common Iliac Artery Aneurysm	Anterior-Posterior, Transverse, Long Same as the Distance measurement in 2D General Measurements
	Ex.Iliac A Aneurysm	External Iliac Artery Aneurysm	
	IIA Aneurysm	Internal Iliac Artery Aneurysm	
	CFA Aneurysm	Common Femoral Artery Aneurysm	
	DFA Aneurysm	Deep Femoral Artery Aneurysm	
	SFA Aneurysm	Superficial Femoral Artery Aneurysm	
	Pop A Aneurysm	Popliteal Artery Aneurysm	
	TP Trunk A Aneurysm	Tibial Peroneal Trunk Artery Aneurysm	
	A.Tib. A Aneurysm	Anterior Tibial Artery Aneurysm	
	Peroneal A Aneurysm	Peroneal Artery Aneurysm	
	P.Tib. A Aneurysm	Posterior Tibial Artery Aneurysm	
	Dors.Ped. A Aneurysm	Dorsalis Pedis Artery Aneurysm	
	LE A Graft 1-3 Native Inflow	Lower External Arterial Graft 1-3 Native Inflow	
	LE A Graft 1-3 Anast	Lower External Arterial Graft 1-3 Anastomosis	

Types	Tools	Descriptions	Methods or formulae
	LE A Graft 1-3 Graft	Lower External Arterial Graft 1-3 Graft	
	LE A Graft 1-3 Native Outflow	Lower External Arterial Graft 1-3 Native Outflow	
	LE A Stent 1-3	Lower External Arterial Stent 1-3	Anterior-Posterior, Transverse, Long, Depth Same as the Distance measurement in 2D General Measurements
	LE A Stenosis 1-4 2D	Lower External Arterial Stenosis 1-4	<ul style="list-style-type: none"> ● Anterior-Posterior, Transverse Same as the Distance measurement in 2D General Measurements ● Stenosis Stenosis Diameter (No unit) = $(Outer\ D - Inner\ D) / MAX(Outer\ D, Inner\ D) * 100\%$ Where Outer D and Inner D refer to the measured vascular diameter, and MAX (Outer D, Inner D) represents the larger value of the two. Stenosis Area (No unit) = $(Outer\ A - Inner\ A) / MAX(Outer\ A, Inner\ A) * 100\%$ Where Outer A and Inner A refer to the measured vascular area, and MAX (Outer A, Inner A) represents the larger value of the two.
	LE A Finding 1-6	Lower External Arterial Finding 1-6	Anterior-Posterior, Transverse, Long, Depth Same as the Distance measurement in 2D General Measurements
	AVF-Inflow Artery	Arteriovenous Fistula-Inflow Artery	
	AVF-Anast	Arteriovenous Fistula-Anastomosis	
	AVF-Outflow Vein Level 1-6	Arteriovenous Fistula-Outflow Vein Level 1-6	Anterior-Posterior, Transverse, Depth Same as the Distance measurement in 2D General Measurements
	AVF-Stenosis 1-3	Arteriovenous Fistula-Stenosis 1-3	
	AVF-Aneurysm 1-3	Arteriovenous Fistula-Aneurysm 1-3	
	AV Graft-Inflow Artery	Arteriovenous Graft-Inflow Artery	

Types	Tools	Descriptions	Methods or formulae
	AV Graft-Arterial Anast	Arteriovenous Graft-Arterial Anastomosis	
	AV Graft-Graft	Arteriovenous Graft-Graft	
	AV Graft-Venous Anast	Arteriovenous Graft-Venous Anastomosis	
	AV Graft-Outflow Vein Level 1-6	Arteriovenous Graft-Outflow Vein Level 1-6	
	Stenosis A	/	<p>Stenosis (No unit) $= (A1-A2) / \text{MAX}(A1, A2) * 100\%$ Where A1 and A2 refer to the measured vascular area, and MAX (A1, A2) represents the larger value of the two. You may select different method for the two area measurement.</p>
	Thigh Perf	Thigh Perforators	<ul style="list-style-type: none"> ● Anterior-Posterior, Transverse Same as the Distance measurement in 2D General Measurements ● Checklist Tick the status. Choose from: Cmp (Compression); Sp (Spontenaity); Ph (phasicity); Aug (Augmentation); Rflx (Reflux); N/A
	Prox Calf Perf	Proximal Calf Perforators	
	Mid Calf Perf	Middle Calf Perforators	
	Dist Calf Perf	Distal Calf Perforators	

Doppler Vascular Measurements

Types	Tools	Descriptions	Methods or formulae
Measurement	CCA	Common Carotid Artery	D trace in General D measurements
	Bulb	Bulbillate	
	ICA	Internal Carotid Artery	
	Carotid Bifurcation	/	
	ECA	External Carotid Artery	
	Vert. A	Vertebral Artery	
	Innom. A	Innominate Artery	
	Subclav. A	Subclavian Artery	
	Mammary A	/	
	CCA Aneurysm	Common Carotid Arterial Aneurysm	
	Bulb Aneurysm	Bulbillate Aneurysm	
	Carotid Bifurcation Aneurysm	Carotid Bifurcation Aneurysm	
	ICA Aneurysm	Internal Carotid Arterial Aneurysm	
	ECA Aneurysm	External Carotid Arterial Aneurysm	
	Vert A Aneurysm	Vertebral Arterial Aneurysm	
	Subclav A Aneurysm	Subclavian Arterial Aneurysm	
	Innom A Aneurysm	Innominate Artery Aneurysm	
	Carotid Graft 1-3 Native Inflow	/	
	Carotid Graft 1-3 Anst Pre	/	
	Carotid Graft 1-3 Anst Max	/	
	Carotid Graft 1-3 Anst Post	/	
	Carotid Graft 1-3 Graft	/	
	Carotid Graft 1-3 Native Outflow	/	
	Carotid Stent 1-3	/	
	UE A Graft 1-3 Native Inflow	Upper External Arterial Graft 1-3 Native Inflow	
UE A Graft 1-3 Anast	Upper External Arterial Graft 1-3 Anastomosis		

Types	Tools	Descriptions	Methods or formulae
	UE A Graft 1-3 Graft	Upper External Arterial Graft 1-3 Graft	
	UE A Graft 1-3 Native Outflow	Upper External Arterial Graft 1-3 Native Outflow	
	UE A Stent 1-3	Upper External Arterial Stent 1-3	
	LE A Graft 1-3 Native Inflow	Lower External Arterial Graft 1-3 Native Inflow	
	LE A Graft 1-3 Anst Pre	Lower External Arterial Graft 1-3 Anastomosis Pre	
	LE A Graft 1-3 Anst Max	Lower External Arterial Graft 1-3 Anastomosis Max	
	LE A Graft 1-3 Anst Post	Lower External Arterial Graft 1-3 Anastomosis Post	
	LE A Graft 1-3 Graft	Lower External Arterial Graft 1-3 Graft	
	LE A Graft 1-3 Native Outflow	Lower External Arterial Graft 1-3 Native Outflow	
	LE A Stent 1-3	Lower External Arterial Stent 1-3	
	AVF-Inflow Artery	Arteriovenous Fistula-Inflow Artery	
	AVF-Anast	Arteriovenous Fistula-Anastomosis	
	AVF-Outflow Vein Level 1-6	Arteriovenous Fistula-Outflow Vein Level 1-6	
	AVF-Stenosis 1-3	Arteriovenous Fistula-Stenosis 1-3	
	AV Graft-Inflow Artery	Arteriovenous Graft-Inflow Artery	
	AV Graft-Arterial Anast	Arteriovenous Graft-Arterial Anastomosis	
	AV Graft-Graft	Arteriovenous Graft-Graft	
	AV Graft-Venous Anast	Arteriovenous Graft-Venous Anastomosis	
	AV Graft-Outflow Vein Level 1-6	Arteriovenous Graft-Outflow Vein Level 1-6	
	SF Junction	the Junction of Great Saphenous Vein and Femoral Vein	
	GSV Thigh	Great Saphenous Vein Thigh	

Types	Tools	Descriptions	Methods or formulae
	GSV Knee	Great Saphenous Vein Knee	
	GSV Calf	Great Saphenous Vein Calf	
	SP Junction	the Junction of Small Saphenous Vein and Popliteal Vein	
	SSV Thigh Extension	Small Saphenous Vein Thigh Extension	
	AASV	Anterior Accessory Saphenous Vein	
	PASV	Posterior Accessory Saphenous Vein	
	Mammary A Aneurysm	Mammary Arterial Aneurysm	
	Axill. A	Axillary Artery	
	Brachial A	Brachial Artery	
	Ulnar A	Ulnar Artery	
	Radial A	Radial Artery	
	Subclav. A	Subclavian Artery	
	Axill. V	Axillary Vein	
	Cephalic V	Cephalic Vein	
	Basilic V	Basilic Vein	
	Ulnar V	Ulnar Vein	
	Radial V	Radial Vein	
	C.Iliac A	Common Iliac Artery	
	Ex.Iliac A	External Iliac Artery	
	CFA	Common Femoral Artery	
	SFA	Superficial Femoral Artery	
	Pop. A	Popliteal Artery	
	TP Trunk A	Tibial Peroneal Trunk Artery	
	Peroneal A	Peroneal Artery	
	P.Tib. A	Posterior Tibial Artery	
	A.Tib. A	Anterior Tibial Artery	
	Dors.Ped. A	Dorsalis Pedis Artery	
	C.Iliac V	Common Iliac Vein	
	Ex.Iliac V	External Iliac Vein	
	Femoral V	Femoral Vein	
	Saph. V	Great Saphenous Vein	
Measurement			D trace in General D measurements
			D trace in General D measurements

Types	Tools	Descriptions	Methods or formulae
	Pop. V	Popliteal Vein	
Measurement	TP Trunk V	Tibial Peroneal Trunk Vein	D trace in General D measurements
	Sural V	Sural Vein	
	Soleal V	Soleal Vein	
	Peroneal V	Peroneal Vein	
	P.Tib. V	Posterior Tibial Vein	
	A.Tib. V	Anterior Tibial Vein	
	ACA	Anterior Cerebral Artery	
	A1 ACA	Anterior Cerebral Artery A1	
	MCA	Middle Cerebral Artery	
	M1 MCA	Middle Cerebral Artery M1	
	M2 MCA	Middle Cerebral Artery M2	
	PCA	Posterior Cerebral Artery	
	P1 PCA	Posterior Cerebral Artery P1	
	P2 PCA	Posterior Cerebral Artery P2	
	AComA	Ant.communicating br.	
	Terminal ICA	Terminal Internal Carotid Artery	
	PComA	Post.communicating br.	
	Ophthalmic A	Ophthalmic Artery	
	ICA Siphon	Internal Carotid Artery Siphon	
	Terminal Vert A	Terminal Vertebral Artery	
BA	Basilar Artery		
Measurement	IIA	Internal Iliac Artery	D trace in General D measurements
	DFA	Deep Femoral Artery	
	Ba V	Basilar Vein	
	Brachial V	Brachial Vein	
	IIV	Internal Iliac Vein	
	CFV	Common Femoral Vein	
	SFV	Superficial Femoral Vein	
	DFV	Deep Femoral Vein	
	SSV	Small Saphenous Vein	
	C.Iliac V Reflux	Common Iliac Vein Reflux	
	Ex.Iliac V Reflux	External Iliac Vein Reflux	

Types	Tools	Descriptions	Methods or formulae
	Femoral V Reflux	Femoral Vein Reflux	
	Saph. V Reflux	Great Saphenous Vein Reflux	
	Pop. V Reflux	Popliteal Vein Reflux	
	TP Trunk V Reflux	Tibial Peroneal Trunk Vein Reflux	
	Sural V Reflux	Sural Vein Reflux	
	Soleal V Reflux	Soleal Vein Reflux	
	Peroneal V Reflux	Peroneal Vein Reflux	
	P.Tib. V Reflux	Posterior Tibial Vein Reflux	
	A.Tib. V Reflux	Anterior Tibial Vein Reflux	
	IIV Reflux	Internal Iliac Vein Reflux	
	CFV Reflux	Common Femoral Vein Reflux	
	SFV Reflux	Superficial Femoral Vein Reflux	
	DFV Reflux	Deep Femoral Vein Reflux	
	SSV Reflux	Small Saphenous Vein Reflux	
	SF Junction Reflux	the Junction of Great Saphenous Vein and Femoral Vein Reflux Time	
	GSV Thigh Reflux	Great Saphenous Vein Thigh Reflux Time	
	GSV Knee Reflux	Great Saphenous Vein Knee Reflux Time	
	GSV Calf Reflux	Great Saphenous Vein Calf Reflux Time	
	SP Junction Reflux	the Junction of Small Saphenous Vein and Popliteal Vein Reflux Time	
	SSV Thigh Extension Reflux	Small Saphenous Vein Thigh Extension Reflux Time	
	AASV Reflux	Anterior Accessory Saphenous Vein Reflux Time	
	PASV Reflux	Posterior Accessory Saphenous Vein Reflux Time	
	ASP	Ankle Systolic Pressure	Type in
	BSP	Brachial Systolic Pressure	

Types	Tools	Descriptions	Methods or formulae
Calculation	ICA/CCA(PS)	/	See below
Study	ABI	Ankle Brachial Index	See below
	CCA(Sten)	Common Carotid Artery Stenosis	D trace in General D measurements
	Bulb(Sten)	Bulbillate Stenosis	
	Carotid Bifurcation(Sten)	Carotid Bifurcation Stenosis	
	ICA(Sten)	Internal Carotid Artery Stenosis	
	ECA(Sten)	External Carotid Artery Stenosis	
	Vert A(Sten)	Vertebral Artery Stenosis	
	Subclav A(Sten)	Subclavian Artery Stenosis	
	Innom A(Sten)	Innominate Artery Stenosis	
	Mammary A(Sten)	Mammary A Stenosis	
	Carotid Stenosis 1-4	/	
	Axill A(Sten)	Axillary Artery Stenosis	
	Brachial A(Sten)	Brachial Artery Stenosis	
	Radial A(Sten)	Radial Artery Stenosis	
	Ulnar A(Sten)	Ulnar Artery Stenosis	
	UE A Stenosis 1-4	Upper External Arterial Stenosis 1-4	
	C.Iliac A(Sten)	Common Iliac Artery Stenosis	
	Ex.Iliac A(Sten)	External Iliac Artery Stenosis	
	IIA(Sten)	Internal Iliac Artery Stenosis	
	CFA(Sten)	Common Femoral Artery Stenosis	
	DFA(Sten)	Deep Femoral Artery Stenosis	
	SFA(Sten)	Superficial Femoral Artery Stenosis	
	Pop A(Sten)	Popliteal Artery Stenosis	
	TP Trunk A(Sten)	Tibial Peroneal Trunk Artery Stenosis	
A.Tib A(Sten)	Anterior Tibial Artery Stenosis		
Peroneal A(Sten)	Peroneal Artery Stenosis		

Types	Tools	Descriptions	Methods or formulae
	P.Tib A(Sten)	Posterior Tibial Artery Stenosis	<ul style="list-style-type: none"> ● PV, Reflux D trace and Time in General D measurements ● Checklist Tick the status. Choose from: Cmp (Compression); Sp (Spontaneity); Ph (phasicity); Aug (Augmentation); Rflx (Reflux); N/A
	Dors.Ped. A(Sten)	Dorsalis Pedis Artery Stenosis	
	LE A Stenosis 1-4	Lower External Arterial Stenosis 1-4	
	Thigh Perf	Thigh Perforators	
	Prox Calf Perf	Proximal Calf Perforators	
	Mid Calf Perf	Middle Calf Perforators	
	Dist Calf Perf	Distal Calf Perforators	

7.4 Vascular Measurement Operations

- Tip:**
1. See the table in “7.3 Vascular Measurement Tools” above for measurement tools and methods.
 2. For the definitions of measurement, calculation and study, see “1.3 Measurement, Calculation and Study.”
 3. The order of the measurement items can be preset. See “2.4.2 Application Measurement Preset” for details.
 4. A measurement tool can be activated by clicking the item in the measurement menu or on the touch screen. It is described as “Select/Click ... in the measurement menu” in the following procedures.
 5. The measurements of some tools described in this chapter are to be performed in several imaging modes. Select the appropriate imaging mode during measurement.

7.4.1 Measurement Tool Operations

1. Select the item/tool in the measurement menu.
2. Perform the measurement referring to the methods in the table above.

7.4.2 Calculation Tool Operations

Stenosis D

Function: measures the Normal Diam. and Resid. Diam., calculates the Stenosis D.

1. Select [Stenosis D] in the measurement menu or the touch screen.
2. Use the Distance measurement method in 2D General Measurements to measure the Normal(D) and Resid(D).

The Stenosis D is calculated automatically.

Stenosis A

Function: measures the Normal Area and Resid. Area, calculates the Stenosis A.

1. Select [Stenosis A] in the measurement menu or the touch screen.
2. Use the Area measurement method in 2D General Measurements to measure the Normal(A) and Resid(A).

The Stenosis A is calculated automatically.

ICA/CCA (PS)

Function: measures the flow velocity ratio between ICA and CCA to calculate the stenosis.

1. Select [ICA/CCA (PS)] in the measurement menu or the touch screen.
2. Measure the PS value of the ICA and CCA using the 2 PT method in D trace, and the system calculates the stenosis. Where, the ICA value adopts the maximum PS value of proximal, middle and distal and the CCA adopts the latest measured value after changing the Prox./Mid./Dist. attribute (the default CCA adopts the distal PS value).

7.4.3 Study Tool Operations

IMT

- NOTE:**
1. The IMT function is unavailable on the product not configured with IMT.
 2. The IMT measurement is available on frozen (or history) linear array images only.

Function: IMT (Intima-Media Thickness) measures the distance between LI (Lumen-Intima) and MA (Media-Adventia).

The IMT values at 4 positions: CCA (Common Carotid Artery), ICA (Internal Carotid Artery), ECA (External Carotid Artery) and Bulb (Bulbillate) need to be measured here.

1. Enter the IMT exam mode, scan and freeze the image (or review a historic image).
2. Select [IMT] in the measurement menu and enter the IMT measurement.
3. Select the side (Left/Right), angle and vessel wall (Near/Far).
4. Select an item such as [ICC, IMT], and the ROI box displays on the screen.

It appears as  when Near is selected

It appears as  when Far is selected

- Tip** Make sure that you select the correct vessel wall (Near/Far) before the IMT measurement. Otherwise the intima may be recognized incorrectly due to different algorithms that are applied in near/far wall recognition.

5. Move the ROI box to the desired position, then press <Set>. Two auto trace lines appear in the box.

While the ROI box is green, you can:

- Adjust the size of the ROI box.
- Trace manually
 - a) Move the cursor to a trace line. The trace line turns yellow. Press <Set>.
 - b) Move the cursor along the interface of the vessel. Press <Set> to confirm the trace after re-adjusting.
- Erase the trace lines inside the box by pressing <Clear>. (Long press <Clear> to clear all measurement calipers on the screen.)

6. Press <Set> outside the box to confirm the adjustment result after the manual trace is complete. The results are recorded in the IMT report.

The system calculates:

- IMT Max.
- IMT Min.
- IMT Mean
- IMT SD
- IMT ROI Length
- IMT Measure Length
- IMT Quality Index

The Quality Index indicates the reliability of one measurement. Manual trace or re-scan of an image with clear endocardium edges is recommended if the Quality Index value is small.

Tip: To achieve a good trace result, try to place the ROI box parallel with the vessel and adjust the box size to reduce unwanted interference.

For multiple measurements on the same side, vessel and angle, the system calculates the following parameters in the report:

- Average Mean IMT
- Average Max. IMT
- Standard deviation

It also provides the Composite Mean IMT, which is an overall mean value of all IMT mean values derived from the measured items.

ABI

Function: calculates the Ankle Brachial Index (ABI) by measuring the Ankle Systolic Pressure (ASP) and the Brachial Systolic Pressure (BSP) on a Doppler image.

$$\text{ABI} = \text{ASP}/\text{BSP}$$

NOTE: needs to be measured on the left and right sides respectively.

Select [ABI] in the measurement menu.

1. Click [ASP] from the [ABI] menu and enter the value.
2. Click [BSP] from the [ABI] menu and enter the value.

The ABI is calculated by the system automatically.

7.5 Vascular Exam Report

During or after a measurement, click [Report] on the touch screen to browse the report.

For details about report browsing, printing and exporting, etc., see “1.7 Report.”

An IMT report is applied to the record results in the IMT measurements, where selecting patient conditions (smoker/non-smoker, diabetic/not diabetic, etc.) and modifying the result data are available.

7.6 References

- Stenosis D:** Honda, Nobuo, et al., "Echo-Doppler Velocimeter in the Diagnosis of Hypertensive Patients: The Renal Artery Doppler Technique," *Ultrasound in Medicine and Biology*, 1986, Vol. 12(12), pp. 945-952.
- Stenosis A:** Jacobs, Norman M., et al., "Duplex Carotid Sonography: Criteria for Stenosis, Accuracy, and Pitfalls," *Radiology*, 1985, 154:385-391.

8 Gynecology

8.1 Gynecology Exam Preparations

Make the following preparations before measuring:

1. Confirm that the current probe is appropriate.
2. Check that the current system date is correct.
3. Register the patient information in the [Patient Info] → [GYN] dialog box.

For more details, see “Exam Preparation → Patient Information” in the Operator's Manual [Basic Volume].

4. Switch to the correct exam mode.

8.2 Basic Gynecology Measurement Procedures

1. Register the patient information in the [Patient Info] → [GYN] dialog box.
2. Press <Measure> to enter the Application Measurement.
3. Select the measurement tool from the menu or the touch screen to start the measurement.
See the table in “8.3 Gynecology Measurement Tools” below for measurement tools.
See section “8.4 Gynecology Measurement Operations” and steps in “3 General Measurement” for measurement methods.
4. Click [Report] on the touch screen to view the exam report. See “8.5 Gynecology Exam Report” for details.

8.3 Gynecology Measurement Tools

The system supports the following gynecology measurements.

NOTE: The measurement tools mentioned below are configured in the system. The application measurement packages provided in this system are generally different combinations of measurement tools. For more information about package preset, see “2.4.2.2 Application Measurement Preset.”

Modes	Types	Tools	Descriptions	Methods or formulae
2D	Measurement	UT H	Uterine Height	Same as the Distance measurement in 2D General Measurements
		UT W	Uterine Width	
		UT L	Uterine Length	Same as the Distance, Trace and Spline measurements in 2D General Measurements
		Cervix L	Uterine Cervix Length	
		Cervix H	Uterine Cervix Height	
		Cervix W	Uterine Cervix Width	Same as the Distance measurement in 2D General Measurements
		Endo	Endometrium Thickness	
		Ovary L	Ovary Length	
		Ovary H	Ovary Height	
		Ovary W	Ovary Width	
		Follicle1~16 L	Follicle 1~16 Length	
		Follicle1~16 W	Follicle 1~16 Width	
		Follicle1~16 H	Follicle1~16 Height	
		Fibroid1-3 d1-3	/	
		GYN Lesion1-3 d1-3	/	
		Ovarian Cyst1-3 d1-3	/	
		DWT	Detrusor Wall Thickness	
		Intus. Depth	Intussusceptions Depth	
		BSD (R)	Bladder Neck–Symphysis Distance (Rest)	Same as the Parallel measurement in 2D General Measurements
		BSD (Va)	Bladder Neck–Symphysis Distance (Valsalva)	

Modes	Types	Tools	Descriptions	Methods or formulae
		Cx-SP Dist. (R)	Cervix - Symphysis Publis Distance (Rest)	
		Cx-SP Dist. (Va)	Cervix - Symphysis Publis Distance (Valsalva)	
		RA-SP Dist. (R)	Rectal Ampulla - Symphysis Publis Distance (Rest)	
		RA-SP Dist. (Va)	Rectal Ampulla - Symphysis Publis Distance (Valsalva)	
		Rectocele Depth	/	
		Shuttle (R)	Bladder Neck–Symphyseal Distance (Rest)	The system automatic calculates BSD, BPW-SP Dist., Cx-SP Dist. and RA-SP Dist. values. See “Shuttle” study
		Shuttle (Va)	Bladder Neck–Symphyseal Distance (Valsalva)	
		RVA (R)	Retrovesical Angle (Rest)	Same as the Angle measurement in 2D General Measurements
		RVA (Va)	Retrovesical Angle (Valsalva)	
		UTA (R)	Urethral Tilt Angle (Rest)	
		UTA (Va)	Urethral Tilt Angle (Valsalva)	
		URA	Urethral Rotation Angle	
		PVA (R)	Pubovesical Angle (Rest)	
		PVA (Va)	Pubovesical Angle (Valsalva)	
		PUA (R)	Pubourethral Angle (Rest)	
		PUA (Va)	Pubourethral Angle (Valsalva)	
		ARA (R)	Anorectal Angle (Rest)	
		ARA (Va)	Anorectal Angle (Valsalva)	
		ARA (C)	Anorectal Angle (Contraction)	

Modes	Types	Tools	Descriptions	Methods or formulae
		LH AP Diam (R)	Levator Hiatal Anteroposterior Diameter (Rest)	Same as the Distance measurement in 2D General Measurements
		LH AP Diam (Va)	Levator Hiatus Anteroposterior Diameter (Valsalva)	
		LH AP Diam (C)	Levator Hiatus Anteroposterior Diameter (Contraction)	
		LH Lateral Diam (R)	Levator Hiatus Lateral Diameter (Rest)	
		LH Lateral Diam (Va)	Levator Hiatus Lateral Diameter (Valsalva)	
		LH Lateral Diam (C)	Levator Hiatus Lateral Diameter (Contraction)	
		LA Thickness (R)	Levator Ani Thickness (Rest)	
		LA Thickness (Va)	Levator Ani Thickness (Valsalva)	
		LA Thickness (C)	Levator Ani Thickness (Contraction)	
		LH Area (R)	Levator Hiatus Area (Rest)	Same as the Area measurement in 2D General Measurements
		LH Area (Va)	Levator Hiatus Area (Valsalva)	
		LH Area (C)	Levator Hiatus Area (Contraction)	
		LA Angle (R)	Levator Ani Angle (Rest)	Same as the Angle measurement in 2D General Measurements
		LA Angle (Va)	Levator Ani Angle (Valsalva)	
		LA Angle (C)	Levator Ani Angle (Contraction)	
		LUG (R)	Levator Urethra Gap (Rest)	Same as the Distance measurement in 2D General Measurements
		LUG (Va)	Levator Urethra Gap (Valsalva)	
		LUG (C)	Levator Urethra Gap (Contraction)	

Modes	Types	Tools	Descriptions	Methods or formulae
		BPW-SP Dist. (S)	Bladder Post Wall - Symphysis Publis Distance (Stress)	Same as the Parallel measurement in 2D General Measurements
		BPW-SP Dist. (Va)	Bladder Post Wall - Symphysis Publis Distance (Valsalva)	
		Lesion1-3 Elas.	/	Elastography in 2D General Measurements
		Fibroid1-3 Elas.	/	
		Fibroid1-3 Strain	/	Same as the Strain measurement in 2D General Measurements
		GYN Lesion1~3 Strain	/	
	Calculation	Ovary Vol.	Ovary Volume	See below
		UT Vol.	UT Volume	
		Uterus Body	/	
		UT-L/ CX-L	/	
		Follicle 1-16	/	
		Mean DWT	Mean Detrusor Wall Thickness	Same as the Distance measurement in 2D General Measurements Mean DWT = (DWT1 + DWT2 + DWT3) /3
		IAS Damage	/	Damage ratio= the length of sphincter muscle of anus damage / the length of sphincter muscle of anus
		EAS Damage	/	
Study	Uterus	/	Length, height and width of uterus, endometrium thickness	
	Uterine Cervix	/	Length, height and width of uterine cervix	
	Ovary	/	Length, height and width of ovary	
	Follicle 1~16	/	Length, height and width of follicle 1~16	
	Fibroid1-3 d1-3	/	Same as the Distance measurement in 2D General Measurements	
	GYN Lesion1-3 d1-3	/		
	Ovarian Cyst1-3 d1-3	/		

Modes	Types	Tools	Descriptions	Methods or formulae
		BL Height	Bladder Height	The system automatic calculates Residual Urine value. Dietz formula: Residual Urine (ml) = BL Height (cm) * BL Depth (cm) * 5.6, or
		BL Depth	Bladder Depth	Haylen formula: Residual Urine (ml) = BL Height (cm) * BL Depth (cm) * 5.9 – 14.6, or Dicuio formula: Residual Urine (ml) = BL Height (cm) * BL Depth (cm) * BL Transverse Diameter (cm)* 0.52
		GYN Lesion1~3 StrRatio	/	Same as the Strain Ratio measurement in 2D General Measurements
		Uterine Finding 1-6	/	Same as the Distance measurement in 2D General Measurements Uterine Finding Volume(cm ³)= $\pi/6 \times$ Uterine Finding D1(cm) \times Uterine Finding D2(cm) \times Uterine Finding D3(cm)
		Ovarian Finding 1-6	/	Same as the Distance measurement in 2D General Measurements Ovarian Finding Volume(cm ³)= $\pi/6 \times$ Ovarian Finding D1(cm) \times Ovarian Finding D2(cm) \times Ovarian Finding D3(cm)
M	/	/	/	/
Doppler	/	/	/	/

8.4 Gynecology Measurement Operations

- Tip:**
1. See the table in “8.3 Gynecology Measurement Tools” above for measurement tools and methods.
 2. For the definitions of measurement, calculation and study, see “1.3 Measurement, Calculation and Study.”
 3. The order of the measurement items can be preset. See “2.4.2 Application Measurement Preset” for details.
 4. A measurement tool can be activated by clicking the item in the measurement menu or on the touch screen. It is described as “Select/Click ... in the measurement menu” in the following procedures.

8.4.1 Measurement Tool Operations

All items are measured using the Distance method except for UT L and Cervix L which support the Distance, Trace and Spline methods.

Shuttle

The measurement of reference line distance: measure the distance from BN, front point, middle point, back point of pelvis floor to the reference line of the symphysis pubis.

1. Move the bigger cursor to a certain point.
2. Rotate <Angle> to adjust the orientation of the reference line.
3. Press <Set> to fix the reference line.
4. Press <Set> to fix BN position. Measure the distance from this point to the reference line (BN distance). Then, measure BPW-SP Dist., Cx-SP Dist. and RA-SP Dist..

Press <Clear> to remove the last measurement result. Double-click <Set> to complete the measurement in advance. Press <Update> to start a new measurement.

8.4.2 Calculation Tool Operations

Ovary Vol.

Function: measures the Ovary L, Ovary H and Ovary W, calculates the Ovary Vol.

NOTE: needs to be measured on the left and right sides respectively.

1. Select [Ovary Vol.] in the measurement menu or the touch screen.
2. Use the Distance method in 2D General Measurements to measure the Ovary L, Ovary H and Ovary W. The Ovary Vol. is calculated automatically.

UT Vol

Function: measures the UT L, UT H and UT W, calculates the UT Vol.

1. Select [UT Vol.] in the measurement menu or the touch screen.
2. Use the Distance method in 2D General Measurements to measure the UT L, UT H and UT W. The UT Vol. and Uterus Body are calculated automatically.

Uterus Body

Function: measures the UT L, UT H and UT W, calculates Uterus Body.

$$\text{Uterus Body (cm)} = \text{UT L (cm)} + \text{UT H (cm)} + \text{UT W (cm)}$$

1. Select [Uterus Body] in the measurement menu or the touch screen.
2. Use the Distance method in 2D General Measurements to measure the UT L, UT H and UT W. The UT Vol. and Uterus Body are calculated automatically.

UT-L/ CX-L

Function: measures the UT L and Cervix L, calculates the ratio UT-L/CX-L.

$$\text{UT-L/CX-L (No unit)} = \text{UT L (cm)} / \text{Cervix L (cm)}$$

1. Select [UT-L/CX-L] in the measurement menu or the touch screen.
2. Use the Distance method in 2D General Measurements to measure the UT L and Cervix L. The system calculates the UT-L/CX-L.

8.4.3 Study Tool Operations

Uterus

Function: measures the UT L, UT H, UT W and Endo, calculates the UT Vol., Uterine Body and UT-L/CX-L.

1. Select [Uterus] in the measurement menu or the touch screen.
2. Use the Distance method in 2D General Measurements to measure the UT L, UT H, UT W and Endo.

The UT Vol. and Uterus Body are calculated automatically.

If the Uterus and Cervix L has been measured, the system also calculates the UT-L/CX-L.

Uterine Cervix

Function: measures the Cervix L, Cervix H and Cervix W, calculates the UT-L/CX-L.

1. Select [Uterine Cervix] in the measurement menu or the touch screen.
2. Use the Distance method in 2D General Measurements to measure the Cervix L, Cervix H and Cervix W.

Ovary

Function: measures the Ovary L, Ovary H and Ovary W, calculates the Ovary Vol.

NOTE: needs to be measured on the left and right sides respectively.

1. Select [Ovary] in the measurement menu or the touch screen.
2. Use the Distance method in 2D General Measurements to measure the Ovary L, Ovary H and Ovary W. The Ovary Vol. is calculated automatically.

Follicle

Function: measures the length, width and height of the follicle using the Distance method and calculates the length, width and height averages as well as the follicle volume.

Results	Method	Formulae
Average Diameter	2-distance	Average Diam $\square \frac{(Length + Width)}{2}$
	3-distance	Average Diam $\square \frac{(Length + Width + Height)}{3}$
Follicle Volume	1-distance	Vol $\square \frac{\pi}{6} (Length)^3$
	2-distance	Vol $\square \frac{\pi}{6} (Length)^2 \times Width$
	3-distance	Vol $\square \frac{\pi}{6} length \times Width \times Height$

Up to 16 follicles can be measured. Specify the follicle serial numbers before measuring a follicle.

NOTE: needs to be measured on the left and right sides respectively.

Take Follicle1 as an example. The measurements of other items are similar.

1. Select [Follicle1] in the measurement menu or the touch screen.
2. Use the Distance measurement method in 2D General Measurements to measure Follicle1 L, Follicle1 W and Follicle1 H.

The system automatically calculates the average value of Follicle1 L, Follicle1 W and Follicle1 H as well as the volume of Follicle1.

The calculation methods of the follicle diameter and volume can be preset via [Setup] → [System Preset] → [Application].

8.5 Gynecology Exam Report

During or after a measurement, click [Report] on the touch screen to browse the gynecology/IVF/pelvic floor report.

For details about report browsing, printing and exporting, etc., see “1.7 Report.”

8.6 References

- Uterus Body:** Feng Kui, Sun Yanling, Li Hezhou. Ultrasonic diagnosis of adenomyosis. Journal of Henan Medical University, 1995; 30 (2).
- UT-L/ CX-L:** Ji Jindi, et al. Ultrasonographic study of the intersex problems and the internal genitalia abnormalities. Journal of China medical ultrasound. 1996, Volume 12, No8 P40.
- Residual Urine:**
1. Dietz HP, et al. Determination of postvoid residual by translabial ultrasound. Int Urogynecol J 2012; 23: 1749-1752.
 2. Haylen BT. Verification of the accuracy and range of transvaginal ultrasound in measuring bladder volumes in women. Br J Urol 1989;64:350-352.
 3. Cassadó, J., Espu?a-Pons, M., Díaz-Cuervo, H., Rebollo, P. and on behalf of the GISPEM Group (2015), How can we measure bladder volumes in women with advanced pelvic organ prolapse?. Ultrasound Obstet Gynecol, 46: 233–238. doi:10.1002/uog.14678
- Levator Hiatus Diam, Area, Thickness and LA Angle**
1. 3-Dimensional transvaginal ultrasonography evaluation of femal pelvic floor structure and function.
 2. Dan V. Valsky, MD, Simcha Yagel, MD. Three-Dimensional Transperineal Ultrasonography of the Pelvic Floor. J Ultrasound Med 2007; 26:1373–1387.
- LUG (Levator Urethra Gap)**
1. H. P. DIETZ, A. ABBU and K. L. SHEK. The levator–urethra gap measurement: a more objectivemeans of determining levator avulsion? Ultrasound Obstet Gynecol 2008; 32: 941–945.

**Smart
Pelvic**

1. Svabik K, Shek KL, Dietz HP. How much does the levator hiatus have to stretch during childbirth? *BJOG* 2009;116:1657–62
2. Abdool Z, Shek KL, Dietz HP. The effect of levator avulsion on hiatal dimensions and function. *Am J Obstet Gynecol* 2009;201(1). 89.e1–5.
3. Dietz H, Hoyte L, Steensma A. (2008). *Atlas of Pelvic Floor Ultrasound*. United Kingdom: Springer-Verlag London Ltd.
4. Dietz H, De Leon J, Shek K. Ballooning of the levator hiatus. *Ultrasound Obstet Gynecol* 2008; 31: 676–680.
5. Eisenberg VH, Chantarasorn V, Shek KL, Dietz HP. Does levator ani injury affect cystocele type? *Ultrasound Obstet Gynecol* 2010; 36: 618–623.
6. Oerno A, Dietz H. Levator co-activation is a significant confounder of pelvic organ descent on Valsalva maneuver. *Ultrasound Obstet Gynecol* 2007; 30: 346–350.
7. Dietz H, Lanzarone V. Levator trauma after vaginal delivery. *Obstet Gynecol* 2005;106: 707–712.
8. Dietz HP, Abbu A, Shek KL. The levator–urethra gap measurement: a more objective means of determining levator avulsion? *Ultrasound Obstet Gynecol* 2008; 32: 941–945.
9. Dietz HP, Schierlitz L. Pelvic floor trauma in labour—myth or reality? *Aust N Z J Obstet Gynaecol* 2005;45:3–11.
10. Dietz H, Abbu A, Shek K (2008) The levator urethral gap measurement: a more objective means of determining levator avulsion? *Ultrasound Obstet Gynecol* 32:941–945
11. Valsky DV, Yagel S. Three-dimensional transperineal ultrasonography of the pelvic floor: improving visualization for new clinical applications and better functional assessment. *J Ultrasound Med* 2007; 26: 1373–1387
12. Dietz HP. Pelvic floor ultrasound: a review. *Am J Obstet Gynecol* 2010; 202: 321–334

9 Urology

9.1 Urology Exam Preparations

Make the following preparations before performing a urology exam:

1. Confirm that the current probe is appropriate.
2. Check that the current system date is correct.
3. Click [Info] on the touch screen and register the patient information in the [Patient Info] → [URO] dialog box.
For more details, see “Exam Preparation → Patient Information” in the Operator’s Manual [Basic Volume].
4. Switch to the correct exam mode.

9.2 Basic Urology Measurement Procedures

1. Click [Info] on the touch screen and register the patient information in the [Patient Info] → [URO] dialog box.
2. Press <Measure> to enter the Application Measurements.
3. Select the measurement tool from the menu or the touch screen to start the measurement.
See the table in “9.3 Urology Measurement Tools” below for measurement tools.
See section “9.4 Urology Measurement Operations” and steps in “3 General Measurement” for measurement methods.
4. Click [Report] on the touch screen to view the exam report. See “9.5 Urology Exam Report” for details.

9.3 Urology Measurement Tools

NOTE: The measurement tools mentioned below are configured in the system. The application measurement packages provided in this system are generally different combinations of measurement tools. For more information about package preset, see "2.4.2.2 Application Measurement Preset."

The system supports the following measurements (no measurement tools in M mode).

Modes	Types	Tools	Descriptions	Methods or formulae
2D	Measurement	Renal L	Renal Length	Distance in 2D General Measurements
		Renal H	Renal Height	
		Renal W	Renal Width	
		Cortex	Renal Cortical Thickness	
		Cortex(Renal Transplant1-2)	Renal Cortical Thickness	
		Renal V Diam(Renal Transplant1-2)	Renal Vein Diameter	
		Ureter Diam(Renal Transplant1-2)	Ureter Diameter	
		Adrenal L	Adrenal Length	
		Adrenal H	Adrenal Height	
		Adrenal W	Adrenal Width	
		Prostate L	Prostate Length	
		Prostate H	Prostate Height	
		Prostate W	Prostate Width	
		Seminal L	Seminal Vesicle Length	
		Seminal H	Seminal Vesicle Height	
		Seminal W	Seminal Vesicle Width	
		Testis L	Testicular Length	
		Testis H	Testicular Height	
		Testis W	Testicular Width	
		Ureter Diam	Ureter Diameter	
		Urethra	/	
Pre-BL L	Pre-void Bladder Length			
Pre-BL H	Pre-void Bladder Height			

Modes	Types	Tools	Descriptions	Methods or formulae
		Pre-BL W	Pre-void Bladder Width	
		Post-BL L	Post-void Bladder Length	
		Post-BL H	Post-void Bladder Height	
		Post-BL W	Post-void Bladder Width	
		Renal Cyst1-3 d1-3	/	
		Renal Lesion1-3 d1-3	/	
	Measurement	Prostate Mass1 d1-3	/	Distance in 2D General Measurements
		Prostate Mass2 d1-3	/	
		Prostate Mass3 d1-3	/	
		Testis Mass1 d1-3	/	
		Testis Mass2 d1-3	/	
		Testis Mass3 d1-3	/	
		Epididymis L	Epididymis Length	
		Epididymis W	Epididymis Width	
		Epididymis H	Epididymis Height	
		Scrotal Wall Thickness	/	
	Calculation	Renal Vol.	Renal Volume	See below
		Prostate Vol.	Prostate Volume	
		Testicular Vol.	Testicular Volume	
		Pre-BL Vol.	Pre-void Bladder Volume	
Post-BL Vol.		Post-void Bladder Volume		
Mictur. Vol.		Micturated Volume		
Study	Kidney	/	See below	
	Adrenal	/		
	Prostate	/		
	Seminal Vesicle	/		

Modes	Types	Tools	Descriptions	Methods or formulae
		Testis	/	
		Bladder	/	
		Mass1-10	/	
		Prostate mass 1-3	/	
		Testis mass 1-3	/	
		Epididymis	/	
		Renal Cyst1-3 d1-3	/	Distance in 2D General Measurements
		Renal Lesion1-3 d1-3	/	
		Kidney(Superior)	/	Distance in 2D General Measurements
		Kidney(Mid)	/	
		Kidney(Inferior)	/	
		Kidney(Renal Transplant1-2)	/	Distance in 2D General Measurements
		Adrenal(Renal Transplant1-2)	/	
Finding 1-6(Renal Transplant1-2)	/			
Doppler	Measurement	Testicular A	Testicular Aorta	D trace in General D measurements
		Testicular V	Testicular Vein	
		Epididymis A	Epididymis Aorta	
		Epididymis V	Epididymis Vein	
		Artery Anast(Renal Transplant1-2)	/	
		Artery Anast 2(Renal Transplant1-2)	/	
		Renal A(Renal Transplant1-2)	/	
		Renal A1(Renal Transplant1-2)	/	
		Renal A2(Renal Transplant1-2)	/	
		Hilum(Renal Transplant1-2)	/	
		Interlobar A(Renal Transplant1-2)	/	
		Arcuate A(Renal Transplant1-2)	/	

Modes	Types	Tools	Descriptions	Methods or formulae
		Segmental A(Renal Transplant1-2)	/	
		Renal Vein 1-2(Renal Transplant1-2)	/	
		Vein Anast(Renal Transplant1-2)	Vein Anastomosis	
		Vein Anast 2(Renal Transplant1-2)	Vein Anastomosis 2	
	Study	Renal Transplant 1-2 (Doppler)	/	D trace in General D measurements

9.4 Urology Measurement Operations

Tip:	<ol style="list-style-type: none"> 1. See the table in “9.3 Urology Measurement Tools” above for measurement tools and methods. 2. For the definitions of measurement, calculation and study, see “1.3 Measurement, Calculation and Study.” 3. The order of the measurement items can be preset. See “2.4.2 Application Measurement Preset” for details. 4. A measurement tool can be activated by clicking the item in the measurement menu or on the touch screen. It is described as “Select/Click ... in the measurement menu” in the following procedures.
-------------	---

9.4.1 Measurement Tool Operations

All Urology measurement tool operations are the same as the Distance measurement of 2D General Measurements.

The measurement procedures are as follows, taking the Prostate L measurement as an example:

1. Select [Prostate L] in the measurement menu or the touch screen.
2. Use the Distance tool in 2D General Measurements to measure the Prostate L.

9.4.2 Calculation Tool Operations

Renal Vol.

Function: measures the Renal L, Renal H and Renal W, calculates the Renal Vol.

NOTE: needs to be measured on the left and right sides respectively.

1. Select [Renal Vol] in the measurement menu or the touch screen.
2. Use the Distance measurement method in 2D General Measurements to measure the Renal L, Renal H and Renal W. The Renal Vol. is calculated automatically.

Prostate Vol.

Function: measures the Prostate L, Prostate H and Prostate W, calculates the Prostate Vol. and PPSA. If [Serum PSA] in [Patient Info] → [URO] has been entered, PSAD (Prostate Special Antigen Density) will also be calculated.

$$\text{PPSA (ng/ml)} = \text{PPSA Coefficient (ng/ml}^2\text{)} \times \text{Prostate Vol (ml)}$$

$$\text{PSAD (ng/ml}^2\text{)} = \text{Serum PSA (ng/ml)} / \text{Prostate Vol. (ml)}$$

Here, the PPSA Coefficient and Serum PSA are entered in the [Patient Info] → [URO] dialog box. The default value of the PPSA Coefficient is 0.12.

1. Select [Prostate Vol.] in the measurement menu or the touch screen.
2. Use the Distance method in 2D General Measurements to measure the Prostate L, Prostate H and Prostate W.

The system calculates the Prostate Vol. and PPSA.

The PSAD displays in the report if the PSA value is entered.

Testicular Vol.

Function: measures the Testis L, Testis H and Testis W, calculates the Testis Vol.

NOTE: needs to be measured on the left and right sides respectively.

1. Select [Testicular Vol.] in the measurement menu or the touch screen.
2. Use the Distance measurement method in 2D General Measurements to measure the Testis L, Testis H and Testis W. The Testis Vol. is calculated automatically.

Pre-BL Vol.

Function: measures the Pre-BL L, Pre-BL H and Pre-BL W, calculates the Pre-BL Vol.

1. Select [Pre-BL Vol] in the measurement menu or the touch screen.
2. Use the Distance method in 2D General Measurements to measure the Pre-BL L, Pre-BL H and Pre-BL W. The Pre-BL Vol. is calculated automatically. The Mictur.Vol is displayed in the report if the Post-BL Vol is measured.

Post-BL Vol.

Function: measures the Post-BL L, Post-BL H and Post-BL W, calculates the Post-BL Vol.

1. Select [Post-BL Vol] in the measurement menu or the touch screen.
2. Use the Distance method in 2D General Measurements to measure Post-BL L, Post-BL H and Post-BL W. The Post-BL Vol is calculated automatically. The Mictur.Vol is displayed in the report if the Pre-BL Vol is measured.

Mictur. Vol.

Function: measures the Pre-BL Vol and Post-BL Vol, calculates the Mictur.Vol.

1. Select [Mictur.Vol] in the measurement menu or the touch screen.
2. Use the Distance method in 2D General Measurements to measure the Pre-BL L, Pre-BL H and Pre-BL W. The Pre-BL Vol. is calculated automatically and displayed in the report.
3. Use the Distance method in 2D General Measurements to measure Post-BL L, Post-BL H and Post-BL W. The Post-BL Vol. and Mictur.Vol. are calculated automatically, the Post-BL Vol. is displayed in the report.

9.4.3 Study Tool Operations

Kidney

Function: measures the Renal L, Renal H and Renal W, calculates the Renal Vol.

NOTE: needs to be measured on the left and right sides respectively.

1. Select [Kidney] in the measurement menu or the touch screen.
2. Use the Distance measurement method in 2D General Measurements to measure the Renal L, Renal H and Renal W. The Renal Vol. is calculated automatically.
3. Use the method of Distance measurement of 2D General Measurements to measure Cortex.

Adrenal

Function: measures Adrenal L, Adrenal H and Adrenal W.

NOTE: needs to be measured on the left and right sides respectively.

1. Select the [Adrenal] in the measurement menu or the touch screen.
2. Use the method of Distance measurement of 2D General Measurements to measure Adrenal L, Adrenal H and Adrenal W.

Prostate

Function: measures the Prostate L, Prostate H and Prostate W, calculates the Prostate Vol. and PPSA. If [Serum PSA] in [Patient Info] → [URO] has been entered, PSAD (Prostate Special Antigen Density) will also be calculated.

$$\text{PPSA (ng/ml)} = \text{PPSA Coefficient (ng/ml}^2\text{)} \times \text{Prostate Vol (ml)}$$

$$\text{PSAD (ng/ml}^2\text{)} = \text{Serum PSA (ng/ml)} / \text{Prostate Vol. (ml)}$$

Here, the PPSA Coefficient and Serum PSA are entered in the [Patient Info] → [URO] dialog box. The default value of the PPSA Coefficient is 0.12.

1. Select the [Prostate] in the measurement menu or the touch screen.
2. Use the Distance method in 2D General Measurements to measure the Prostate L, Prostate H and Prostate W.

The system calculates the Prostate Vol. and PPSA.

The PSAD displays in the report if the PSA value is entered.

Seminal Vesicle

Function: measures the Seminal L, Seminal H and Seminal W.

NOTE: needs to be measured on the left and right sides respectively.

1. Select [Seminal Vesicle] in the measurement menu or the touch screen.
2. Use the Distance measurement method in 2D General Measurements to measure the Seminal L, Seminal H and Seminal W.

Testis

Function: measures the Testis L, Testis H and Testis W, calculates the Testis Vol.

NOTE: needs to be measured on the left and right sides respectively.

1. Select [Testis] in the measurement menu or the touch screen.
2. Use the Distance measurement method in 2D General Measurements to measure the Testis L, Testis H and Testis W. The Testis Vol. is calculated automatically.

Bladder

Function: measures the Pre-BL L, Pre-BL H, Pre-BL W, Post-BL L, Post-BL H and Post-BL W, calculates the Pre-BL Vol., Post-BL Vol and Mictur.Vol.

1. Select [Bladder] in the measurement menu or the touch screen.
2. Use the Distance method in 2D General Measurements to measure the Pre-BL L, Pre-BL H and Pre-BL W. The Pre-BL Vol. is calculated automatically.
3. Use the Distance method in 2D General Measurements to measure Post-BL L, Post-BL H and Post-BL W. The Post-BL Vol. and Mictur.Vol. are calculated automatically.

Mass

Function: measures 3 distances in the mass.

Taking Mass1 as an example, the procedure is as follows:

1. Select [Mass1] in the measurement menu or the touch screen.
2. Use the Distance tool in the 2D General Measurement to measure Mass1 d1, Mass1 d2 and Mass1 d3.

Epididymis

Function: measures the Epididymis L, Epididymis H and Epididymis W.

NOTE: needs to be measured on the left and right sides respectively.

1. Select [Epididymis] in the measurement menu or the touch screen.
2. Use the Distance measurement method in 2D General Measurements to measure Epididymis L, Epididymis H and Epididymis W.

9.5 Urology Exam Report

During or after a measurement, click [Report] on the touch screen to browse the report.

For details about report browsing, printing and exporting, etc., see "1.7 Report."

9.6 References

PPSA: Peter J. Littrup M.D., Fed LeE. M.D., Curtis Mettin. P.D. Prostate Cancer Screening: Current Trends and Future Implications. CA-A CANCER JOURNAL FOR CLINICIANS, Jul/Aug 1992, Vol.42, No.4.

PSAD: MITCHELL C. BENSON, IHN SEONG, CARLA. OLSSON, J., McMahon, WILLIAM H.COONER. The Use of Prostate Specific Antigen Density to Enhance the Predictive Value of the Intermediate Levels of Serum Prostate Specific Antigen. THE JOURNAL OF UROLOGY, 1992, Vol.147, p817-821

10 Small Parts

10.1 Small Parts Exam Preparations

Make the following preparations before measuring:

1. Confirm that the current probe is appropriate.
2. Check that the current system date is correct.
3. Click [Info] on the touch screen and register the patient information in the [Patient Info] → [SMP] dialog box.

For more details, see “Exam Preparation → Patient Information” in the Operator's Manual [Basic Volume].

4. Switch to the correct exam mode.

10.2 Basic Small Parts Measurement Procedures

1. Click [Info] on the touch screen and register the patient information in the [Patient Info] → [SMP] dialog box.
2. Press <Measure> to enter the Application Measurements.
3. Select the measurement tool in the menu or on the touch screen to start the measurement.
See the table in “10.3 Small Parts Measurement Tools” below for measurement tools.
See section “10.4 Small Parts Measurement Operations” and steps in “3 General Measurement” for measurement methods.
4. Click [Report] on the touch screen to view the exam report. See “10.5 Small Parts Exam Report” for details.

10.3 Small Parts Measurement Tools

The system supports the following small parts measurements.

NOTE: The measurement tools mentioned below are configured in the system. The application measurement packages provided in this system are generally different combinations of measurement tools. For more information about package preset, see “2.4.2.2 Application Measurement Preset.”

Modes	Types	Tools	Descriptions	Methods or formulae
2D	Measurement	Thyroid L	Thyroid Length	Distance in 2D General Measurements
		Thyroid H	Thyroid Height	
		Thyroid W	Thyroid Width	
		Isthmus H	Isthmus height	
		Testis L	Testicular Length	
		Testis H	Testicular Height	
		Testis W	Testicular Width	
		Epididymis L	Epididymis Length	
		Epididymis W	Epididymis Width	
		Epididymis H	Epididymis Height	
		Scrotal Wall Thickness	/	
		Breast Mass1~10 L	Mass Length	
		Breast Mass1~10 W	Mass Width	
		Breast Mass1~10 H	Mass Height	
		Nip.-Mass 1~10 Dist.	Distance between nipple and mass	
		Skin-Mass 1~10 Dist.	Distance between skin and mass	
		Thyroid Mass 1-3 d1-3	Thyroid mass	
		Thyroid Nodule 1-3 d1-3	/	
		Thyroid Cyst 1-3 d1-3	/	
		Testicular Mass 1-3 d1-3	Testicular mass	
		THY Mass1~3 Strain	Thyroid Mass Strain	Strain in 2D General Measurements
		THY Nodule1~3 Strain	Thyroid Nodule Strain	
		Breast Mass1~10 Strain	/	
		THY Mass1~3 Elas.	Thyroid Mass Elastography	Elastography in 2D General Measurements
		THY Nodule1~3 Elas.	Thyroid Nodule Elastography	
		Breast Mass1~10 Elas.	Breast Mass Elastography	

Modes	Types	Tools	Descriptions	Methods or formulae
	Calculation	Thyroid Vol.	Thyroid Volume	Thyroid Vol. (cm ³) = k × Thyroid L (cm) × Thyroid H (cm) × Thyroid W (cm) Where k= 0.479 or 0.523
		Testicular Vol.	Testicular Volume	See Testicular Vol. in chapter "9.4.2 Calculation Tool Operations"
	Study	Thyroid	/	Same formulae as in the Thyroid Vol. calculation
		Testis	/	See Testis in chapter "9.4.3 Study Tool Operations"
		Epididymis	/	See Epididymis in chapter "9.4.3 Study Tool Operations"
		Breast Mass1~10	/	Volume (3 Dist.) in 2D General Measurements
		Thyroid Mass1~10	/	
		Testicular Mass1~10	/	
		THY Mass1~3 Strain Ratio	Thyroid Mass Strain Ratio	Strain Ratio in 2D General Measurements
		THY Nodule1~3 Strain Ratio	Thyroid Nodule Strain Ratio	
		Breast Mass1~10 Strain Ratio	/	
		THY Mass1~3 Elas. Ratio	Thyroid Mass Elastography Ratio	Elastography Ratio in 2D General Measurements
		THY Nodule1~3 Elas. Ratio	Thyroid Nodule Elastography Ratio	
		Breast Mass1~10 Elas. Ratio	Breast Mass Elastography Ratio	
		Thyroid(Superior)	/	Distance in 2D General Measurements
		Thyroid(Mid)	/	
		Thyroid(Inferior)	/	
		Parathyroid 1-2	/	
Parotid	/			
Lymph Node 1-6	/			

Modes	Types	Tools	Descriptions	Methods or formulae
		Isthmus Finding 1-3	/	
M	/	/	/	/
Doppler	Measurement	STA	Superior Thyroid Artery	D trace in General D measurements
		ITA	Inferior Thyroid Artery	
		Isthmus	/	
		Parathyroid 1-2	/	
		Testicular A	Testicular Aorta	
		Testicular V	Testicular Vein	
		Testis V(Valsalva)	/	
		Epididymis A	Epididymis Aorta	
	Epididymis V	Epididymis Vein		
	Calculation	/	/	/
Study	/	/	/	

10.4 Small Parts Measurement Operations

- Tip:**
1. See table “10.3 Small Parts Measurement Tools” above for measurement tools and methods.
 2. For the definitions of measurement, calculation and study, see “1.3 Measurement, Calculation and Study.”
 3. The order of the measurement items can be preset. See “2.4.2 Application Measurement Preset” for details.
 4. A measurement tool can be activated by clicking the item in the measurement menu or on the touch screen. It is described as “Select/Click ... in the measurement menu” in the following procedures.

10.4.1 Measurement Tool Operations

Take the measurement “Thyroid L” for example. The measurement procedure is as follows:

1. Select [Thyroid L] in the measurement menu or on the touch screen.
2. Use the Distance tool in 2D General Measurements to measure the Thyroid L. The value displays in the results window and exam report.

10.4.2 Calculation Tool Operations

Thyroid Vol.

Function: measures Thyroid L, Thyroid H and Thyroid W respectively, and calculates Thyroid Vol.

Tip: Needs to be measured on the left and right sides respectively.

1. Select [Thyroid Vol.] in the measurement menu or the touch screen.

2. Use the Distance tool in 2D General Measurements to measure the Thyroid L, Thyroid H and Thyroid W.
Two Thyroid Vols are calculated automatically.

10.4.3 Study Tool Operations

Thyroid

Function: measures Thyroid L, Thyroid H and Thyroid W respectively, and calculates Thyroid Vol. See "10.3 Small Parts Measurement Tools" for calculation formulae.

Tip: Needs to be measured on the left and right sides respectively.
--

1. Select [Thyroid] in the measurement menu or the touch screen
2. Use the Distance tool in 2D General Measurements to measure the Thyroid L, Thyroid H and Thyroid W. The Thyroid Vol. is calculated automatically.

Mass

Function: measures the Mass L, Mass W and Mass H to calculate the Mass Volume, as well as measuring the Nip.-Mass Dist. and Skin-Mass Dist. Up to 10 masses can be measured.

Taking Mass1 as an example, the procedure is as follows:

1. Select [Mass1] in the measurement menu or the touch screen.

When measuring breast masses, rotate the knob under [Position] on the touch screen to record the mass position.

Rotate the knob under [Side: X] on the touch screen to record the mass side.

2. Use the Distance tool in the 2D General Measurement to measure Mass1 L, Mass1 W and Mass1 H.
3. Use the Distance tool in the 2D General Measurement to measure the Nip.-Mass Dist. and Skin-Mass Dist.

The measurements and the calculated Mass Volume are recorded in the report.

Testis

The same as "Testis" in "9 Urology."

Epididymis

The same as "Epididymis" in "9 Urology."

10.5 Small Parts Exam Report

During or after a measurement, click [Report] on the touch screen to browse the report.

For details about report browsing, printing and exporting, etc., see "1.7 Report."

10.6 References

Thyroid Vol: Volumetrie der Schilddruesenlappn mittels Realtime-Sonographie; J Brunn, U. Block, G. Ruf, et al.; Dtsch.med. Wschr.106 (1981), 1338-1340.)
(k= 0.479)

Thyroid Vol: Gomez J.M., Gomea N., et al. Determinants of thyroid volume as measured by ultrasonography in healthy adults randomly selected. Clin Endocrinol(Oxf), 2000;53:629-634
(k=0.523)

11 Pediatrics

The HIP (Hip Joint Angle) measurement is used in pediatric Pediatrics. Such measurement provides early diagnosis for infant hip joint dislocation.

11.1 Pediatrics Exam Preparations

Make the following preparations before measuring:

1. Confirm that the current probe is appropriate.
2. Check that the current system date is correct.
3. Register the patient information in the [Patient Info] → [PED] dialog box.

For more details, see “Exam Preparation → Patient Information” in the Operator's Manual [Basic Volume].

4. Switch to the correct exam mode.

11.2 Basic Pediatrics Measurement Procedures

1. Register the patient information in the [Patient Info] → [PED] dialog box.
2. Press <Measure> to enter the Application Measurements.
3. Select the measurement tool in the menu or on the touch screen to start the measurement.
4. See the table in “11.3 Pediatrics Measurement Tools” below for measurement tools.
5. See section “11.4 HIP Measurement Operations” and steps in “3 General Measurement” for measurement methods.
6. Click [Report] on the touch screen to view the exam report. See “11.5 Pediatrics Exam Report” for details.

11.3 Pediatrics Measurement Tools

<p>NOTE: The measurement tools mentioned below are configured in the system. The application measurement packages provided in this system are generally different combinations of measurement tools. For more information about package preset, see “2.4.2.2 Application Measurement Preset.”</p>
--

HIP

The HIP calculation assists in assessing the development of the infant hip. In this calculation, three straight lines are superimposed on the image and aligned with the anatomical features. The two angles are calculated and displayed.

The three lines are:

- The baseline (BL), connecting the osseous acetabular convexity to the point where the joint capsule and the perichondrium unite with the ilium.
- The roof line (RL), connecting the lower edge of the ilium to the osseous acetabular convexity.
- The inclination line (IL), connecting the osseous acetabular convexity to the acetabular labrum.

The angles are:

- α : the angle between BL and RL.
- β : the angle between BL and IL

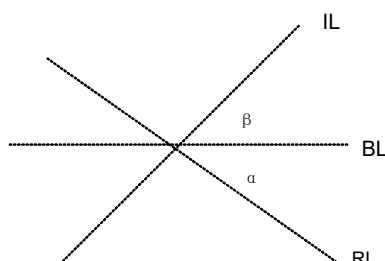

Dislocation type can be determined using the Graf method, as described in the following table.

Type	α	Bony roof	Superior bony rim	β	Cartilaginous roof	Age (Weeks)	
I	Ia	$\geq 60^\circ$	good	angular/slightly rounded ("blunt")	$\leq 55^\circ$	covers the femoral head	any age
	Ib	$\geq 60^\circ$	good	angular/slightly rounded ("blunt")	$> 55^\circ$	covers the femoral head	any age
II	IIa	$[50^\circ, 60^\circ]$	adequate (satisfactory)	rounded	any angle	covers the femoral head	$[0, 6]$
	IIa(+)	$[55^\circ, 60^\circ]$	adequate (satisfactory)	rounded	any angle	covers the femoral head	$(6, 12]$
	IIa(-)	$[50^\circ, 55^\circ]$	deficient	rounded	any angle	covers the femoral head	$(6, 12]$
	IIb	$[50^\circ, 60^\circ]$	deficient	rounded	any angle	covers the femoral head	> 12
	IIc	$[43^\circ, 50^\circ]$	severely deficient	rounded to flattened	$\leq 77^\circ$	covers the femoral head	any age
D	$[43^\circ, 50^\circ]$	severely deficient	rounded to flattened	$> 77^\circ$	pressed shift	any age	
III	IIIa	$\leq 42^\circ$	poor	flattened	no measure	pressed upwards- without structural alteration (devoid of echoes) proximal perichondrium goes up to the contour of the iliac wall	any age

Type	α	Bony roof	Superior bony rim	β	Cartilaginous roof	Age (Weeks)
IIIb	$\leq 42^\circ$	poor	flattened	no measure	pressed upwards-with structural alteration (they are echogenic) proximal perichondrium goes up to the contour of the iliac wall	any age
IV	$\leq 42^\circ$	poor	flattened	no measure	pressed downwards (horizontal or mulded proximal perichondrium	any age

HIP-Graf

The measurement items, results and procedures are the same as "HIP."

d/D

Measures the distance between the baseline and bottom line of the osseous acetabular and the maximum width of the hip to estimate the hip osseous acetabular coverage.

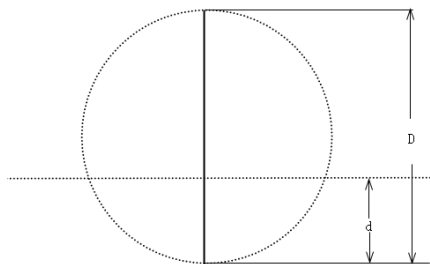

1. Select [d/D] in the measurement menu or the touch screen.
2. Use the Distance tool in the 2D General Measurement to measure the maximum width of the hip (D), and the distance between the osseous acetabular roof and bottom (d). The system calculates the d/D.

11.4 HIP Measurement Operations

- Tip:**
1. For the definitions of measurement, calculation and study, see "1.3 Measurement, Calculation and Study."
 2. A measurement tool can be activated by clicking the item in the measurement menu or on the touch screen. It is described as "Select/Click ... in the measurement menu" in the following procedures.

1. In B mode, select [HIP] from the measurement menu or on the touch screen.

A line appears, and there is a fulcrum on the line.

2. Use the trackball to move the line to the position of the hip joint. Then rotate the <Angle> knob to fix the baseline.
3. Press <Set> to confirm and the second line displays.
4. Use the method for adjusting the first line to anchor the RL and press <Set> to fix the RL.
5. Use the same method to fix the third line IL. The angles of α and β come out.
If the patient's age is entered, the dislocation type is also displayed.
Measure the angles of α and β separately: click [HIP (α)] or [HIP (β)] to measure.

■ Auto HIP Measurement (Smart HIP)

Based on the Graf method, Smart HIP provides both alpha and beta angles. It is a useful tool for assessment of Development Dysplasia of the Hip (DDH) in infants.

HIP measurement supports Smart HIP method if the Smart HIP function is configured.

The procedure is as follows:

■ 2D mode

1. Scan the proper image, and tap [Smart Hip] on the touch screen.
2. Press <Freeze>, and tap the proper guide picture according to the acquired image to rotate or invert the image. Rotate the knob under [Side] to select [Right]/[Left] according to the scan target.

The guide pictures on the touch screen from left to right are the original image, the image rotated 270° and inverted left and right, and the image rotated 90°.

Rotate the knob under [Select Frame] to select the desired frame.

3. Tap [Auto HIP]. The system performs automatic measurement and the measurement results are displayed on the screen.



If necessary, you can move the cursor to the desired line, press <Set> key to activate the line, and move the line or rotate <Angle> to adjust the angle. Press <Set> key to confirm the adjustment, and the measurement results are updated.

Rotate the knob under [Hide Measure] to hide or display the measurement caliper.

4. Tap [Accept Result] to confirm the measurement result.
Or, tap [Cancel Result] to clear the measurement result.

■ 3D/4D mode

1. Acquire the image under static 3D or 4D mode, and tap [Smart Hip] on the touch screen on the image-frozen status. The system performs automatic measurement.

Or, tap  to enter the triple-split window, and tap [Auto measure]. The system performs automatic measurement. Tap  to return to the quarter-split window.

2. Update the measurement result if necessary.

Tap [Left Hip]/[Right Hip] according to the scan target.

Move the cursor to the desired line, press <Set> key to activate the line, and move the line or rotate <Angle> to adjust the angle. Press <Set> key to confirm the adjustment, and the measurement results are updated.

Rotate the knob under [Hide Measure] to hide or display the measurement caliper.

3. If necessary, tap [Detect Plane], and the system adjusts the image to standard plane automatically. Then perform automatic measurement or manual measurement.

4. If necessary, tap [Reset] to restore the orientation of the image to the original status. Then perform automatic measurement or manual measurement.

5. If necessary, tap [Manual Measure] or [d/D], to perform HIP-Graf measurement or d/D measurement manually.
6. Tap [Accept] to confirm the measurement result, and the results are saved in the report.
Or, tap [Wipe] to clear the measurement result.

11.5 Pediatrics Exam Report

During or after a measurement, click [Report] on the touch screen to browse the report.
For details about report browsing, printing and exporting, etc., see “1.7 Report.”

11.6 References

Graf R., “Sonographic diagnosis of hip dysplasia. Principles, sources of error and consequences”
Ultraschall Med. 1987 Feb;8(1):2-8

Schuler P., “Principles of sonographic examination of the hip” Ultraschall Med. 1987 Feb;8(1):9-1

Graf, R. “Fundamentals of Sonographic Diagnosis of Infant Hip Dysplasia.” Journal Pediatric Pediatrics, Vol. 4, No. 6:735-740,1984.

Graf, R. Guide to Sonography of the Infant Hip. Georg Thieme Verlag, Stuttgart and New York, 1987.

Morin, C., Harcke, H., MacEwen, G. “The Infant Hip: Real-Time US Assessment of Acetabular Development.” Radiology, 177:673-677, December 1985.

12 Emergency & Critical

The following optional emergency exam modes are available in the current system:

- EM ABD
- EM FAST
- EM OB
- EM Vascular
- EM Superficial

12.1 Basic Measurement Procedures

1. Click [Info] on the touch screen and register the patient information in the relevant page under the [Patient Info] screen.
2. Scan the desired ultrasound views and save the images.
3. Press <Measure> to enter the Application Measurements.
4. Select the item/tool to start the measurement.
5. Click [Report] on the touch screen to view and export the measurement report.

12.2 EM Measurement Tools

The commonly used measurement tools are contained in the EM package corresponding to each EM exam mode.

- | |
|--|
| <p>NOTE:</p> <ol style="list-style-type: none">1. Measurement tools in each EM package depend on the specific measurement data preset for each ultrasound system.2. For detailed descriptions of the measurement items, see the corresponding application chapter.3. For more information about package preset, see “2.4.2.2 Application Measurement Preset.” |
|--|

12.3 EM Exam Report

During or after a measurement, click [Report] on the touch screen to browse the report.

Each EM exam mode has its corresponding EM report. Similar to other reports, the following functions are available in the EM report:

- Selecting anatomic diagnoses
- Editing report data and adding remarks
- Adding/deleting ultrasound images
- Changing report types
- Printing/previewing reports
- Exporting Reports

For details about report browsing, printing and exporting, etc., see “1.7 Report.”

13 Nerve

13.1 Basic Measurement Procedures

1. Press <Patient>, register patient information in proper page under [Patient Info] screen.
2. Scan the desired ultrasonic views and save image(s).
3. Press <Measure> to enter the Application Measurements.
4. Select the item/tool to start the measurement.
5. Press <Report> to view and output measurement report.

13.2 Nerve Measurement Tools

There are no specific tools for Nerve by default, however, you can preset measurement tools for Nerve using tools from other packages. For details, please refer to "2 Measurement Preset".

- | |
|--|
| <p>NOTE: 1. Measurement tools in each nerve package depend on the specific measurement data preset for each ultrasound system.</p> <p>2. For more information about package preset, see "2 Measurement Preset".</p> |
|--|

13.3 Nerve Exam Report

During or after a measurement, press <Report> on the Control Panel to browse the report. For details about report browsing, printing and exporting etc., see "1.7 Report".

