

**BeneVision**

**Central Monitoring System**

**Operator's Manual**



© Copyright 2017 -2024 Shenzhen Mindray Bio-Medical Electronics Co., Ltd. All rights reserved.

■ Release time: 2024-01

■ Revision: 16.0

---

---

## **WARNING**

---

- **Federal Law (USA) restricts this device to sale by or on the order of a physician or other practitioner licensed by U.S. state law to use or order the use of this device.**
- 
-

# Intellectual Property Statement

SHENZHEN MINDRAY BIO-MEDICAL ELECTRONICS CO., LTD. (hereinafter called Mindray) owns the intellectual property rights to this Mindray product and this manual. This manual may refer to information protected by copyrights or patents and does not convey any license under the patent rights of Mindray, nor the rights of others.

Mindray intends to maintain the contents of this manual as confidential information. Disclosure of the information in this manual in any manner whatsoever without the written permission of Mindray is strictly forbidden.

Release, amendment, reproduction, distribution, rental, adaption and translation of this manual in any manner whatsoever without the written permission of Mindray is strictly forbidden.

 **mindray**, **MINDRAY**, and **MINDRAY** are the registered trademarks or trademarks owned by Mindray in China and other countries. All other trademarks that appear in this manual are used only for editorial purposes without the intention of improperly using them. They are the property of their respective owners.

This posting serves as notice under 35 U.S.C.§287(a) for Mindray patents: <http://www.mindrayna.com/patents>.

## Manufacturer's Responsibility

Contents of this manual are subject to changes without prior notice.

All information contained in this manual is believed to be correct. Mindray shall not be liable for errors contained herein nor for incidental or consequential damages in connection with the furnishing, performance, or use of this manual.

Mindray is responsible for the effects on safety, reliability and performance of this product, only if:

- All installation operations, expansions, changes, modifications and repairs of this product are conducted by Mindray authorized personnel;
- The electrical installation of the relevant room complies with the applicable national and local requirements;
- The product is used in accordance with the instructions for use.

---

---

### WARNING

---

- **This equipment must be operated by skilled/trained clinical professionals.**
  - **It is important for the hospital or organization that employs this equipment to carry out a reasonable service/maintenance plan. Neglect of this may result in machine breakdown or personal injury.**
- 
-

# Company Contact

Manufacturer: Shenzhen Mindray Bio-Medical Electronics Co., Ltd.  
Address: Mindray Building, Keji 12th Road South, High-tech industrial park, Nanshan, Shenzhen 518057, P.R.China  
Website: [www.mindray.com](http://www.mindray.com)  
E-mail Address: [service@mindray.com](mailto:service@mindray.com)  
Tel: +86 755 81888998  
Fax: +86 755 26582680

Distributor: Mindray DS USA, Inc.  
Address: 800 MacArthur Boulevard, Mahwah, New Jersey, 07430 USA  
Tel: 1.800.288.2121, 1.201.995.8000  
Website: [www.mindray.com](http://www.mindray.com)

# Preface

## Manual Purpose

This manual contains the instructions necessary to operate the product safely and in accordance with its function and intended use. Observance of this manual is a prerequisite for proper product performance and correct operation and ensures patient and operator safety.

This manual is based on the maximum configuration and therefore some contents may not apply to your product. If you have any question, please contact Mindray.

This manual is an integral part of the product. It should always be kept close to the equipment so that it can be obtained conveniently when needed.

## Intended Audience

This manual is geared for clinical professionals who are expected to have a working knowledge of medical procedures, practices and terminology as required for monitoring of critically ill patients.

## Illustrations

All illustrations in this manual serve as examples only. They may not necessarily reflect the setup or data displayed on your central monitoring system.

## Conventions

- *Italic text* is used in this manual to quote the referenced manuals, chapters, sections and formulas.
- **Bold text** is used to indicate the screen texts and names of hard keys.
- → is used to indicate operational procedures.

# Contents

<b>1 Safety</b> .....	<b>1 - 1</b>
1.1 Safety Information .....	1 - 1
1.1.1 Warnings .....	1 - 1
1.1.2 Cautions .....	1 - 2
1.1.3 Notes .....	1 - 3
1.2 Equipment Symbols .....	1 - 3
<b>2 System Overview</b> .....	<b>2 - 1</b>
2.1 Intended Use .....	2 - 1
2.2 Contraindications .....	2 - 1
2.3 System Components .....	2 - 2
2.3.1 CentralStation .....	2 - 2
2.3.2 WorkStation .....	2 - 3
2.3.3 ViewStation .....	2 - 3
2.3.4 CMS Viewer .....	2 - 3
2.3.5 Multi Patient Viewer .....	2 - 3
2.3.6 Mobile Viewer .....	2 - 3
2.3.7 Computer Platform .....	2 - 3
2.3.8 License .....	2 - 4
2.3.9 Network Device .....	2 - 4
2.3.10 Remote Display and Data Transmission Device .....	2 - 4
2.3.11 Recorder .....	2 - 4
2.3.12 Printer .....	2 - 4
2.4 Networking Mode .....	2 - 4
2.4.1 Bedside Device Network .....	2 - 5
2.4.2 CMS Network .....	2 - 6
<b>3 Getting Started</b> .....	<b>3 - 1</b>
3.1 Overview .....	3 - 1
3.2 Equipment Preparation Safety Information .....	3 - 1
3.3 Turning On the System .....	3 - 1
3.4 Symbols on the Multibed Screen .....	3 - 2
3.4.1 Patient Category Symbols .....	3 - 2
3.4.2 Alarm Symbols .....	3 - 2
3.4.3 Operation Symbols .....	3 - 3
3.4.4 Battery Status Symbols .....	3 - 3
3.4.5 Other Symbols .....	3 - 3
3.5 Bedside Device Operating Mode .....	3 - 4
3.5.1 Standby Mode .....	3 - 4
3.5.2 Night Mode .....	3 - 5
3.5.3 Privacy Mode .....	3 - 6
3.6 Transforming the WorkStation to CentralStation Temporarily .....	3 - 6
3.7 Accessing M-IoT Device Management System .....	3 - 7
3.8 Viewing System Information .....	3 - 7
3.9 Locking the TouchScreen .....	3 - 7

3.10 Restarting the System .....	3 - 7
3.11 Turning Off the System .....	3 - 7
<b>4 Device Management .....</b>	<b>4 - 1</b>
4.1 Admitting Devices .....	4 - 1
4.1.1 CentralStation Automatically Admitting Devices .....	4 - 1
4.1.2 WorkStation/ViewStation Automatically Admitting Devices .....	4 - 1
4.1.3 Manually Admitting Devices .....	4 - 2
4.2 Testing Devices Connection .....	4 - 3
4.3 Binding or Unbinding the Device and the Patient Sector .....	4 - 3
4.4 Connecting a Patient Monitor with a Telemetry Device .....	4 - 3
4.4.1 Connecting Procedures .....	4 - 3
4.4.2 Disconnecting a Patient Monitor with a Telemetry Device .....	4 - 4
4.5 Checking the Pairing of a Telemetry Device and a Patient Monitor .....	4 - 4
4.6 Checking the Device List .....	4 - 4
4.7 Discharging Devices .....	4 - 4
<b>5 Patient Management .....</b>	<b>5 - 1</b>
5.1 Patient Management Overview .....	5 - 1
5.2 Accessing the Patient Management Screen .....	5 - 1
5.3 Patient Information Management .....	5 - 1
5.3.1 Loading Patient Information by ADT Query .....	5 - 1
5.3.2 Importing Discharged Patient Information .....	5 - 1
5.3.3 Manually Entering Patient Information .....	5 - 2
5.3.4 Changing Patient Information .....	5 - 2
5.3.5 Searching Patient Information .....	5 - 3
5.3.6 Patient Information Synchronization .....	5 - 3
5.4 Discharging A Patient .....	5 - 3
5.5 Transferring Patient Data .....	5 - 3
5.6 Discharged Patients Management .....	5 - 4
5.6.1 Accessing the Discharged Patients Management Screen .....	5 - 4
5.6.2 Viewing Discharged Patient Information .....	5 - 4
5.6.3 Deleting Discharged Patient Information .....	5 - 5
5.6.4 Printing Historical Data of Discharged Patients .....	5 - 5
<b>6 Multibed Screen .....</b>	<b>6 - 1</b>
6.1 Example Multibed Screen .....	6 - 1
6.2 Patient Sector .....	6 - 2
6.2.1 Bed Number and Room Number Area .....	6 - 2
6.2.2 Alarm Information Area .....	6 - 3
6.2.3 Changing Screen Setup of the Patient Sector .....	6 - 3
6.2.4 Changing the Tile Layout of the Patient Sector .....	6 - 3
6.2.5 Patient Sector Status .....	6 - 4
6.2.6 Sorting Patient Sectors .....	6 - 4
6.3 Patient Summary .....	6 - 4
6.3.1 Example Patient Summary Window .....	6 - 4
6.3.2 Filtering Patient Data .....	6 - 5
6.3.3 Changing the Time Length of Trends .....	6 - 5



<b>7 ViewBed Screen</b> .....	<b>7 - 1</b>
7.1 Accessing the ViewBed Screen .....	7 - 1
7.2 Example ViewBed Screen .....	7 - 1
7.3 Quick Keys .....	7 - 2
7.3.1 Available Quick Keys .....	7 - 2
7.3.2 Configuring Quick Keys .....	7 - 3
7.4 General Operations .....	7 - 4
7.4.1 Changing Tile Layout of the ViewBed Screen .....	7 - 4
7.4.2 Displaying the Parameter List .....	7 - 4
7.4.3 SpO2 Statistics .....	7 - 5
7.4.4 Starting/Stopping NIBP Measurement .....	7 - 5
7.4.5 Freezing/Unfreezing Waveforms .....	7 - 6
7.4.6 Loading Configurations .....	7 - 6
7.4.7 Viewing Device Location .....	7 - 6
7.4.8 Initiating a Manual Event .....	7 - 7
7.5 User Screens .....	7 - 7
7.5.1 Minitrends Window .....	7 - 7
7.5.2 Integrated Devices Window .....	7 - 8
7.5.3 ECG Full-Screen .....	7 - 8
7.5.4 ECG 12-lead Screen .....	7 - 8
7.6 Clinical Assistive Applications (CAA) .....	7 - 8
7.6.1 Early Warning Score (EWS) .....	7 - 9
7.6.2 SepsisSight™ .....	7 - 9
7.7 Viewing Other Patients .....	7 - 10
<b>8 Alarms</b> .....	<b>8 - 1</b>
8.1 Alarm Introduction .....	8 - 1
8.2 Understanding the Alarms .....	8 - 1
8.2.1 Alarm Categories .....	8 - 1
8.2.2 Alarm Priorities .....	8 - 1
8.2.3 Alarm Indicators .....	8 - 2
8.2.4 Alarm Status Symbols .....	8 - 2
8.2.5 Highlighted Display of Alarm Messages .....	8 - 3
8.3 Viewing Alarms .....	8 - 3
8.3.1 Viewing All Alarms .....	8 - 3
8.3.2 Viewing Alarms Triggered from A Single Bed .....	8 - 3
8.4 iStatus Window .....	8 - 3
8.5 Clearing Alarms in the Alarm List.....	8 - 4
8.6 Setting Alarm Properties .....	8 - 4
8.6.1 Setting Parameter Alarm Properties .....	8 - 4
8.6.2 Changing Arrhythmia Alarm Settings .....	8 - 5
8.6.3 Changing ST Alarm Settings .....	8 - 5
8.6.4 Setting Alarm Volume .....	8 - 6
8.6.5 Setting the Audible Alarm Tone Pattern .....	8 - 6
8.6.6 Setting Alarm Interval, Alarm Volume Escalation, and Audio Off Priority .....	8 - 6
8.6.7 Setting Alarm Sound for a Single Bed .....	8 - 6
8.6.8 Setting Reminder Tones .....	8 - 6
8.6.9 Setting Special Alarm Sound .....	8 - 6

8.6.10 Modifying Combined Alarm Settings .....	8 - 7
8.6.11 Setting Alarm Latching .....	8 - 7
8.6.12 Setting Alarm Properties for External Devices .....	8 - 7
8.7 Alarm Pause .....	8 - 8
8.7.1 Pausing Alarms .....	8 - 8
8.7.2 System Responses after Pausing Alarms .....	8 - 8
8.8 Alarm Audio Pause .....	8 - 9
8.8.1 Pausing Alarm Sound .....	8 - 9
8.8.2 System Responses after Pausing Alarm Sound .....	8 - 9
8.9 Alarm Reset .....	8 - 9
8.9.1 Resetting Alarms Triggered for Beds .....	8 - 9
8.9.2 Resetting System Alarms .....	8 - 10
8.10 CMS System Silence .....	8 - 10
8.10.1 Silencing CMS .....	8 - 10
8.10.2 System Responses after Silencing CMS .....	8 - 11
8.10.3 Exiting CMS Silenced Status .....	8 - 11
<b>9 Summary .....</b>	<b>9 - 1</b>
9.1 Accessing the Summary Screen .....	9 - 1
9.2 Symbols on Summary Pages .....	9 - 1
9.3 Common Operations on Summary Pages .....	9 - 1
9.3.1 Setting the Summary Statistical Duration .....	9 - 1
9.3.2 Printing the Summary Report .....	9 - 1
9.4 Vital Sign Summary .....	9 - 1
9.4.1 Entering the Vital Sign Summary Page .....	9 - 1
9.4.2 The Display of Vital Sign Summary .....	9 - 2
9.4.3 Setting Trend Parameters for the Vital Sign Summary .....	9 - 2
9.4.4 Setting the Trend Type for the Vital Sign Summary .....	9 - 2
9.4.5 Viewing the Parameter Value at a Specific Time .....	9 - 2
9.4.6 Accessing the Corresponding Review .....	9 - 2
9.5 ECG Summary .....	9 - 3
9.5.1 Entering the ECG Summary Page .....	9 - 3
9.5.2 The Display of ECG Summary .....	9 - 3
9.5.3 Selecting Typical ECG Strips .....	9 - 3
9.5.4 Reviewing the ECG Summary .....	9 - 4
9.5.5 Setting the Night Time for Average HR Statistic .....	9 - 4
<b>10 Review .....</b>	<b>10 - 1</b>
10.1 Overview .....	10 - 1
10.2 Accessing the Review Screen .....	10 - 1
10.2.1 Entering the Review Screen for Online Patients .....	10 - 1
10.2.2 Entering the Review Screen for Discharged Patients .....	10 - 1
10.3 Example Review Page Structure .....	10 - 1
10.4 Symbols on Review Pages .....	10 - 3
10.5 Common Operations on Review Pages .....	10 - 3
10.5.1 Browsing Trend Data .....	10 - 3
10.5.2 Viewing Events .....	10 - 3
10.5.3 Displaying Two Review Pages Simultaneously .....	10 - 4

10.6 Tabular Trends Review Page .....	10 - 4
10.6.1 Entering the Tabular Trends Review Page .....	10 - 4
10.6.2 Configuring Trends .....	10 - 4
10.6.3 Printing a Tabular Trends Report .....	10 - 4
10.6.4 Exporting Trend Data .....	10 - 5
10.7 Graphics Trends Review Page .....	10 - 6
10.7.1 Entering the Graphic Trends Review Page .....	10 - 6
10.7.2 Setting Graphic Trends .....	10 - 6
10.7.3 Printing a Graphic Trends Report .....	10 - 6
10.7.4 Exporting Trend Data .....	10 - 7
10.8 Full Disclosure Review Page .....	10 - 7
10.8.1 Entering the Full Disclosure Review Page .....	10 - 7
10.8.2 Selecting Waveforms .....	10 - 7
10.8.3 Compressed Waveform .....	10 - 7
10.8.4 Detail Waveform Window .....	10 - 8
10.8.5 Printing Compressed Waveforms or Detail Waveforms .....	10 - 11
10.8.6 Recording Detailed Waveforms .....	10 - 12
10.8.7 Exporting Waveform Data .....	10 - 12
10.8.8 Resting 12-Lead ECG Analysis .....	10 - 13
10.9 Events Review Page .....	10 - 14
10.9.1 Entering the Events Review Page .....	10 - 14
10.9.2 Event List .....	10 - 14
10.9.3 Event Detail Window .....	10 - 15
10.9.4 Printing Events .....	10 - 16
10.9.5 Recording Event Detail .....	10 - 17
10.10 12-Lead ECG Review Page .....	10 - 17
10.10.1 Entering the 12-Lead Review Page .....	10 - 17
10.10.2 Median Complex Window (For Glasgow Algorithm Only) .....	10 - 17
10.10.3 Configuring 12-Lead ECG Waveforms .....	10 - 17
10.10.4 Caliper Measurement .....	10 - 17
10.10.5 Resting 12-Lead ECG Reanalysis .....	10 - 18
10.10.6 Printing 12-Lead Analysis Reports .....	10 - 19
10.11 ST Review Page .....	10 - 19
10.11.1 Entering the ST Review Page .....	10 - 19
10.11.2 Setting ST Reference Templates .....	10 - 19
10.11.3 Displaying/Hiding ST Reference Templates .....	10 - 19
10.11.4 Displaying/Hiding Markers .....	10 - 19
10.11.5 Printing ST Segment Waveforms .....	10 - 20
10.12 Arrhythmia Statistics Page .....	10 - 20
10.12.1 Entering the Arrhythmia Statistics Page .....	10 - 20
10.12.2 Viewing Arrhythmia Statistics .....	10 - 20
10.12.3 Setting the Display of Arrhythmia Events .....	10 - 20
10.12.4 Printing Arrhythmia Statistics Results .....	10 - 21
10.13 aEEG Review Page .....	10 - 21
10.13.1 Entering the aEEG Review Page .....	10 - 21
10.13.2 Setting the aEEG Review Display .....	10 - 21
10.13.3 Initiating a Manual Event .....	10 - 21
10.13.4 Printing an aEEG Report .....	10 - 21

<b>11 Calculation</b>	<b>11 - 1</b>
11.1 Calculation Overview	11 - 1
11.2 Calculation Safety Information	11 - 1
11.3 Accessing the Calculation Screen	11 - 1
11.4 Drug Calculations	11 - 2
11.4.1 Performing Drug Calculations	11 - 2
11.4.2 Viewing a Titration Table	11 - 2
11.4.3 Printing a Titration Table	11 - 2
11.4.4 Drug Calculation Formula	11 - 3
11.4.5 Titration Table Calculation Formula	11 - 3
11.5 Hemodynamic Calculations	11 - 3
11.5.1 Performing Hemodynamic Calculations	11 - 3
11.5.2 Viewing Hemodynamic Calculation Results	11 - 4
11.5.3 Printing Hemodynamic Calculation Results	11 - 4
11.5.4 Viewing Hemodynamic Parameter Diagnosis	11 - 4
11.5.5 Input Parameters for Hemodynamic Calculations	11 - 4
11.5.6 Calculated Parameters and Formulas for Hemodynamic Calculations	11 - 4
11.6 Oxygenation Calculations	11 - 5
11.6.1 Performing Oxygenation Calculations	11 - 5
11.6.2 Viewing Oxygenation Calculation Results	11 - 6
11.6.3 Printing Oxygenation Calculation Results	11 - 6
11.6.4 Input Parameters for Oxygenation Calculations	11 - 6
11.6.5 Calculated Parameters and Formulas for Oxygenation Calculations	11 - 6
11.7 Ventilation Calculations	11 - 7
11.7.1 Performing Ventilation Calculations	11 - 7
11.7.2 Viewing Ventilation Calculation Results	11 - 7
11.7.3 Printing Ventilation Calculation Results	11 - 7
11.7.4 Input Parameters for Ventilation Calculations	11 - 7
11.7.5 Calculated Parameters and Formulas for Ventilation Calculations	11 - 8
11.8 Renal Calculations	11 - 8
11.8.1 Performing Renal Calculations	11 - 8
11.8.2 Viewing Renal Calculation Results	11 - 9
11.8.3 Printing Renal Calculation Results	11 - 9
11.8.4 Calculated Parameters and Formulas for Renal Calculations	11 - 9
11.8.5 Calculated Parameters and Formulas for Renal Calculations	11 - 9
<b>12 Paging</b>	<b>12 - 1</b>
12.1 Overview	12 - 1
12.2 Accessing the Paging Window	12 - 1
12.3 Adding a Pager	12 - 1
12.4 Assigning a Bed to a Pager	12 - 2
12.4.1 Assigning an Online Bed to a Pager	12 - 2
12.4.2 Assigning a Manually Input Bed to a Pager	12 - 2
12.5 Removing a Bed Assignment	12 - 2
12.6 Editing a Pager	12 - 2
12.7 Removing a Pager	12 - 2
12.8 Resending a Failed Page	12 - 3

12.9 Generating a Paging Report .....	12 - 3
<b>13 Printing .....</b>	<b>13 - 1</b>
13.1 Supported Printers .....	13 - 1
13.2 Starting Printing .....	13 - 1
13.2.1 Manually Starting Printing .....	13 - 1
13.2.2 Automatically Starting Printing .....	13 - 5
13.3 Stopping Printing .....	13 - 5
13.4 Viewing Printer Statuses .....	13 - 5
13.5 Configuring Reports .....	13 - 6
13.5.1 Accessing the Print Setup Menu .....	13 - 6
13.5.2 Setting Realtime Reports and ECG Reports .....	13 - 6
13.5.3 Setting End Case Reports .....	13 - 7
13.5.4 Setting Scheduled Reports .....	13 - 9
13.6 Printer Out of Paper .....	13 - 9
<b>14 Recording .....</b>	<b>14 - 1</b>
14.1 Supported Recorders .....	14 - 1
14.2 Loading Paper .....	14 - 2
14.3 Setting the Recorder .....	14 - 3
14.4 Starting Recordings .....	14 - 3
14.4.1 Manually Starting Recordings .....	14 - 3
14.4.2 Automatically Starting Recordings .....	14 - 3
14.5 Stopping Recordings .....	14 - 4
14.5.1 Manually Stopping Recordings .....	14 - 4
14.5.2 Automatically Stopping Recordings .....	14 - 4
<b>15 System Setup .....</b>	<b>15 - 1</b>
15.1 System Setup Overview .....	15 - 1
15.2 General Settings .....	15 - 1
15.2.1 Accessing the General Setup Page .....	15 - 1
15.2.2 Adjusting Alarm Volumes .....	15 - 1
15.2.3 Viewing System Help Information .....	15 - 1
15.2.4 Setting the Touchscreen .....	15 - 1
15.2.5 Resetting the Recorder Service .....	15 - 2
15.3 Display Settings .....	15 - 2
15.3.1 Accessing the Display Setup Page .....	15 - 2
15.3.2 Setting Parameter Colors .....	15 - 2
15.3.3 Screen Setup .....	15 - 2
15.3.4 Setting Sectors .....	15 - 4
15.3.5 Setting Patient Window .....	15 - 4
15.3.6 Setting Other Display Items .....	15 - 5
15.4 Alarm Settings .....	15 - 5
15.4.1 Accessing the Alarm Setup Page .....	15 - 5
15.4.2 Configuring Alarm Audio Properties .....	15 - 5
15.4.3 Setting Paging-Related Alarm Properties .....	15 - 6
15.4.4 Configuring Other Alarm-Related Items .....	15 - 6
15.4.5 Exporting and Analyzing the Alarm Log .....	15 - 7

15.5 Patient Management Settings .....	15 - 8
15.5.1 Accessing the Patient Management Page .....	15 - 8
15.5.2 Configuring Patient Fields .....	15 - 8
15.5.3 Setting Patient Finding Criteria .....	15 - 8
15.5.4 HIS Patient Synchronization .....	15 - 8
15.5.5 Setting Discharged Patients .....	15 - 9
15.5.6 Setting Patient Location .....	15 - 9
15.5.7 Setting Patient Group .....	15 - 9
15.5.8 Setting Care Groups .....	15 - 10
15.5.9 Setting Other Patient Information Items .....	15 - 10
15.6 Device Management Settings .....	15 - 11
15.7 Review Settings .....	15 - 11
15.7.1 Accessing the Review Setup Page .....	15 - 11
15.7.2 Setting Trend Groups .....	15 - 11
15.7.3 Setting Full Disclosure .....	15 - 11
15.7.4 Setting Events .....	15 - 12
15.7.5 Setting Arrhythmia Mark Colors .....	15 - 12
15.7.6 Setting Patient Data Export .....	15 - 12
15.8 Telemetry Settings .....	15 - 13
15.8.1 Accessing the Telemetry Setup Page .....	15 - 13
15.8.2 Setting Alarm Properties for Telemetry Devices .....	15 - 13
15.8.3 Setting ECG Related Items for Telemetry Devices .....	15 - 13
15.8.4 Setting Nurse Call Properties .....	15 - 14
15.8.5 Device Setting .....	15 - 14
15.8.6 Frequency Setup .....	15 - 15
15.8.7 Programming Telepack-608 Telepacks .....	15 - 16
15.8.8 Setting Authorization .....	15 - 17
15.8.9 WMTS Device .....	15 - 18
15.9 Network Settings .....	15 - 18
15.9.1 Accessing the Network Setup Page .....	15 - 18
15.9.2 Setting General Communication Conditions .....	15 - 18
15.9.3 Setting the Master Server .....	15 - 19
15.9.4 Configuring eGateway .....	15 - 19
15.9.5 Setting CentralStation Authorization .....	15 - 20
15.9.6 Setting CentralStation Connection .....	15 - 21
15.9.7 Setting Bed Authorization .....	15 - 22
15.9.8 Setting the AP Management Tab .....	15 - 22
15.9.9 MLDAP .....	15 - 22
15.9.10 Configuring Mobile Server .....	15 - 23
15.10 Print Settings .....	15 - 24
15.10.1 Accessing the Print Setup Page .....	15 - 24
15.10.2 Setting a Printer .....	15 - 24
15.10.3 Setting Scheduled Reports .....	15 - 24
15.10.4 Setting End Case Reports .....	15 - 25
15.10.5 Setting Report Layout .....	15 - 25
15.10.6 Setting ECG Reports .....	15 - 25
15.10.7 Setting PDF File Name .....	15 - 25
15.10.8 Setting the Recorder .....	15 - 25
15.10.9 Setting Other Print-Related Items .....	15 - 26
15.11 Configuration Settings .....	15 - 26

15.11.1	Accessing the Configuration Setup Page .....	15 - 26
15.11.2	Setting Telemetry Configurations .....	15 - 26
15.11.3	Setting Department Configurations .....	15 - 26
15.11.4	Setting the Department List .....	15 - 27
15.11.5	Setting the Bed .....	15 - 27
15.11.6	Setting Assignment between Telemetry Devices and Departments .....	15 - 28
15.11.7	Printing, Backing Up, and Restoring All Settings .....	15 - 28
15.11.8	Exporting and Importing Configuration .....	15 - 28
15.12	CAA (Clinical Assistive Applications) Settings .....	15 - 29
15.12.1	Accessing the CAA page .....	15 - 29
15.12.2	Setting EWS Measurement Reminding .....	15 - 29
15.12.3	Setting SepsisSight .....	15 - 29
15.13	Other Settings .....	15 - 29
15.13.1	Accessing the Other Setup Page .....	15 - 29
15.13.2	Setting Units .....	15 - 30
15.13.3	Setting Units for Integrated Devices .....	15 - 30
15.13.4	Configuring Module .....	15 - 30
15.13.5	Setting Time .....	15 - 30
15.13.6	Setting Authorization .....	15 - 31
15.13.7	Setting Language .....	15 - 32
15.13.8	Setting A Device Location .....	15 - 33
15.13.9	Exporting Logs .....	15 - 33
15.13.10	Setting Manual Event Authorization .....	15 - 33
15.13.11	Enabling Accessing M-IoT Device Management System .....	15 - 33
15.14	Configuring CentralStation's System Settings via the WorkStation .....	15 - 34
<b>16</b>	<b>Maintenance .....</b>	<b>16 - 1</b>
16.1	Overview .....	16 - 1
16.2	Maintenance Safety Information .....	16 - 1
16.3	General Inspection .....	16 - 2
16.4	Cleaning .....	16 - 2
<b>A</b>	<b>Technical Specifications .....</b>	<b>A - 1</b>
A.1	Requirements .....	A - 1
A.2	Audio Signals .....	A - 2
A.3	Maximum Number of Monitoring Devices .....	A - 2
A.4	Maximum Number of Patient Sectors on the Multibed Screen .....	A - 3
A.5	Maximum Number of CMS Viewers .....	A - 3
A.6	Wired Network .....	A - 3
A.7	Summary .....	A - 3
A.8	Review .....	A - 3
A.9	Calculation .....	A - 4
A.10	Print .....	A - 4
A.11	Recorder .....	A - 4
A.12	Data Export .....	A - 5
<b>B</b>	<b>CMS Alarm Messages .....</b>	<b>B - 1</b>
B.1	Overview .....	B - 1

B.2 Alarm Messages in the System Alarm Area .....	B - 1
B.3 Alarm Messages in Patient Sectors .....	B - 2
<b>C Default Settings .....</b>	<b>C - 1</b>
C.1 Overview .....	C - 1
C.2 General Tab .....	C - 1
C.3 Display Tab .....	C - 1
C.4 Alarm Tab .....	C - 2
C.5 Patient Management Tab .....	C - 3
C.6 Review .....	C - 5
C.7 Telemetry Tab .....	C - 6
C.8 Network Tab .....	C - 7
C.9 Print Tab .....	C - 8
C.10 CAA .....	C - 10
C.11 Other Tab .....	C - 10
<b>D Units, Symbols and Abbreviations .....</b>	<b>D - 1</b>
D.1 Units .....	D - 1
D.2 Symbols .....	D - 2
D.3 Abbreviations .....	D - 3



# 1 Safety

---

## 1.1 Safety Information

The safety statements presented in this chapter refer to the basic safety information that the operator of the BeneVision Central Monitoring System (hereinafter referred to as the CMS) shall pay attention to and abide by. There are additional safety statements in other chapters or sections, which may be the same as or similar to the following, or specific to the operations

---

### WARNING

---

- **Indicates a potential hazard or unsafe practice that, if not avoided, could result in death or serious injury.**
- 

---

### CAUTION

---

- **Indicates a potential hazard or unsafe practice that, if not avoided, could result in minor personal injury or product/property damage.**
- 

---

### NOTE

---

- **Provides application tips or other useful information to ensure that you get the most from your product.**
- 

### 1.1.1 Warnings

---

---

#### WARNING

---

- **MR-unsafe! Do not expose the device to a magnetic resonance (MR) environment.**
  - ◆ **The device may present a risk of projectile injury due to the presence of ferromagnetic materials that can be attracted by the MR magnet core.**
  - ◆ **Thermal injury and burns may occur due to the metal components of the device that can heat during MR scanning.**
  - ◆ **The device may generate artifacts in the MR image.**
- **The CMS is intended for use only by clinical professionals or under their guidance. It must only be used by persons who have received adequate training in its use. Anyone unauthorized or untrained must not perform any operation on it.**
- **The physiological waveforms, parameters and alarms displayed on the CMS screen are for clinician's reference only and cannot be directly used as the basis for clinical treatment. Before giving invasive treatment to a patient, you must go to the corresponding devices to confirm the results you have obtained from the CMS.**
- **If any value displayed on the CMS screen is abnormal or questionable, first determine the patient's vital signs by alternative means and then verify that the CMS and the devices connected to the CMS are working properly.**
- **The CMS is a clinical information device. Except for using such components as the mouse, touchscreen and keyboard to perform normal operations, do not touch or disassemble any other component, especially the power component; otherwise, it may result in personnel injury.**
- **The computer running the CMS software must comply with local relevant regulations. The CMS is intended to connect with Mindray devices only. Connecting devices made by other manufacturers may cause the values displayed on the CMS to be inaccurate.**
- **The CMS can be constructed using a wireless local area network (WLAN) for connecting bedside devices. When data is transmitted via radio frequency (RF) signals, it may impact the performance of**

other WLANs in the environment or the use of other RF equipment. Therefore, the wireless RF equipment must comply with CE, FCC and other local relevant standards and regulations.

- When the CMS is transmitting data via a WLAN, loss of patient data may occur due to interference from other RF sources.
  - The CMS software copyright is solely owned by Mindray. No organization or individual shall resort to altering, copying, or exchanging it or to any other infringement on it in any form or by any means without due permission.
  - Data communication must be performed within a closed network or within a virtually isolated network provided by a hospital for all network functions. The hospital is responsible for ensuring the security of the virtually isolated network.
  - The physiological waveforms, parameters, alarms and so on displayed on the CMS screen come from connected devices. If network connection fails, data transmitted from the devices to the CMS might be lost or delayed. Thus keep patients under close surveillance.
  - If an external audio device is connected to the CMS, do not turn off the external audio device nor adjust the volume to zero.
  - Do not block the speaker of the CMS.
  - Do not rely exclusively on audible alarm system. Setting alarm volume to a low level may result in a hazard to the patient.
  - PACEMAKER PATIENTS – On ventricular paced patients, episodes of Ventricular Tachycardia may not always be detected. Do not rely entirely upon the system's automated arrhythmia detection algorithm. Keep pacemaker patients under close surveillance.
  - A hazard can exist if different alarm presets are used for the same or similar equipment in any single area.
- 
- 

## 1.1.2 Cautions

---

### CAUTION

---

- The service life of the CMS depends on its hardware. Rough treatment, dropping or collision should be avoided in the operation on the keyboard, mouse and computer; otherwise, the service life of the CMS may be shortened.
- Components of the CMS, such as the keyboard and mouse, may be contaminated by microorganisms during transport, storage and use.
- Before removing components of the CMS from their packaging, the packaging should be inspected for damage. In case of any damage, contact the carrier or Mindray immediately.
- All CMS equipment must utilize the Uninterruptible Power Supply (UPS) to power the CMS. Failure to do so will result in loss of monitoring during extended periods of power failure. When there is a power failure, the system should be shut down by following the specified shutdown procedure before the UPS is turned off. If the system has a sudden power failure, system failure may occur and consequently the system will not work correctly next time or may even have a serious result.
- Do not transport a CMS host or displays while they are running. Doing so may cause damage.
- System time should be set before the CMS is put into use. If the system time is changed when the CMS is in use, it may result in patient data loss.
- The cable connecting the CMS to the switch or exchange will not exceed 100 m; otherwise, it may result in network overload or weak network signals and consequently errors will occur during data transmission or displaying.
- The CMS should be connected to the network utilizing a network designed according to the installation guide.
- Restart the CMS every three months. Long time operation of the system may lead to a failure of the operating system.
- The CMS should be installed only using Mindray provided Microsoft Windows operating system, service packs, and patches. Use of unauthorized software may lead to abnormal system operation or failure.
- Do not install any third party applications not approved by Mindray or utilize the CMS host for any other purpose.

- Using the “Show Desktop” feature in Windows is prohibited. Installing or using any other software not provided by Mindray is prohibited. Software that has not been tested or verified by Mindray may cause the instability of the system. Mindray assumes no responsibility for this.
- When printing data through an external printer, be sure to follow the printer’s instructions. In case any problem occurs during printing, consult the printer’s instructions.
- At the end of its service life, the CMS must be disposed of in compliance with the guidelines regulating the disposal of such products. If you have any questions concerning disposal of the equipment, please contact Mindray.
- For host computers installing MacAfee Application Control software, all the necessary software such as CMS or third-party software should be authorized through MacAfee. Unauthorized software can not run in the host computer.
- Before connecting any storage device to the CMS, ensure that this storage device is free of viruses. After the use of the storage device, verify that there are no viruses in the CMS. Otherwise, the CMS cannot work properly if it is infected with viruses.

### 1.1.3 Notes











#### NOTE











- This manual describes all features and options. Your equipment may not have all of them.
- Keep this manual in the vicinity of the CMS so that it can be obtained conveniently when needed.
- During normal use, the operator is expected to face the front of the equipment.
- All the CMS host, parts, or accessories should be from Mindray or acknowledged by Mindray.

## 1.2 Equipment Symbols

#### NOTE

- Some symbols may not appear on your equipment.
- This manual describes a series of typical computer symbols, which may be slightly different from what are on your computer. The computer symbols usually have their specific meanings. Refer to your computer’s operator’s manual or contact our service personnel if you have any question.

Symbol	Description	Symbol	Description
	Refer to instruction manual/booklet		CAUTION: To reduce the risk of electric shock, do NOT remove cover. Refer servicing to qualified service personnel.
	Alternating current		Power switch
	Keyboard port		Mouse port
	Serial communication (COM) port		Display port
	Printer port		USB port or device

Symbol	Description	Symbol	Description
	Network port		Microphone port
	Sound input port		Sound output port
	Date of manufacture		Manufacturer
	Serial number		Equipotentiality
	MR Unsafe – do not subject to magnetic resonance imaging (MRI)		
	<p>The following definition of the WEEE label applies to EU member states only.</p> <p>This symbol indicates that this product should not be treated as household waste. By ensuring that this product is disposed of correctly, you will help prevent bringing potential negative consequences to the environment and human health. For more detailed information with regard to returning and recycling this product, please consult the distributor from whom you purchased it.</p> <p>* For system products, this label may be attached to the main unit only.</p>		

# 2 System Overview

---

## 2.1 Intended Use

The indications for use of the BeneVision Central Monitoring System include:

- Real time viewing of patient clinical data and alarms
- Storage and historical review of patient clinical data and alarms
- Printing of real time and historical patient data
- Configuration of local settings as well as synchronizing settings across the network to a remote device
- Transfer of patient clinical data and settings between several CentralStations
- Provides a Resting 12 Lead interpretation of previously stored data

The BeneVision Central Monitoring System is a networked patient monitoring system intended for use in a fixed location, installed in professional healthcare facilities to provide clinicians remote patient monitoring. The network connections between the various devices can be any combination of Ethernet (Wired), Wireless WIFI (WLAN), and Wireless WMTS.

The BeneVision Central Monitoring System supports one or more Mindray compatible physiological monitors and will display, store, print, and transfer information received from the compatible monitors; The BeneVision Central Monitoring System supports bi-directional configuration of the compatible monitors.

The telemetry monitoring systems are designed to acquire and monitor physiological data for ambulating patients within a defined coverage area. The BeneVision Central Monitoring System supports Telemetry Systems: TMS-6016, Telepack-608, TMS60, TM80, and TM70.

- The TMS-6016 transmitter is intended for use on Adult and Pediatric patients to monitor ECG and SpO<sub>2</sub> physiological data.
- The Panorama Telepack-608 transmitter is intended for use on Adult patients to monitor ECG and SpO<sub>2</sub> physiological data.
- The TMS60 transmitter is intended for use on Adult and Pediatric patients over three years old to monitor ECG, SpO<sub>2</sub>, NIBP and Resp physiological data. The physiological data can be reviewed locally on the display of the transmitter. The CentralStation will support ECG, Heart Rate, SpO<sub>2</sub>, NIBP, Resp, Pulse Rate, Arrhythmia analysis, QT monitoring, and ST Segment Analysis for the TMS60.
- The TM80/TM70 telemetry monitor is intended for use on Adult and Pediatric patients over three years old to monitor ECG, SpO<sub>2</sub>, NIBP and Resp physiological data. The physiological data can be analyzed, alarmed, stored, reviewed locally on the display of the monitor, and the CentralStation can configure and display the physiological parameters from the TM80/TM70.

The BeneVision Central Monitoring System is intended for use in professional healthcare facilities under the direct supervision of a licensed healthcare practitioner.

---

### WARNING

---

- **The CMS is intended for use by qualified physicians or well-trained clinicians. Anyone unauthorized or untrained must not perform any operation on it.**
  - **The physiological waveforms, parameters and alarms displayed on the screen of the CMS are for reference only and cannot be directly used as the basis for clinical treatment.**
  - **If any value displayed on the CMS screen is abnormal or questionable, first determine the patient's vital signs by alternative means and then verify that the CMS and connected devices are working properly.**
- 

## 2.2 Contraindications

None

## 2.3 System Components

The CMS mainly consists of the following components:

- CentralStation
- ViewStation (optional)
- WorkStation (optional)
- Central Monitoring System Viewer (hereinafter referred to as the CMS Viewer) (optional)
- Multi Patient Viewer (optional)
- Mobile Viewer (optional)
- Computer platform
- License
- Network devices (optional)
- Remote display and data transmission device (optional)
- Recorder (optional)
- Printer (optional)

The following figure shows the system components of the CMS:

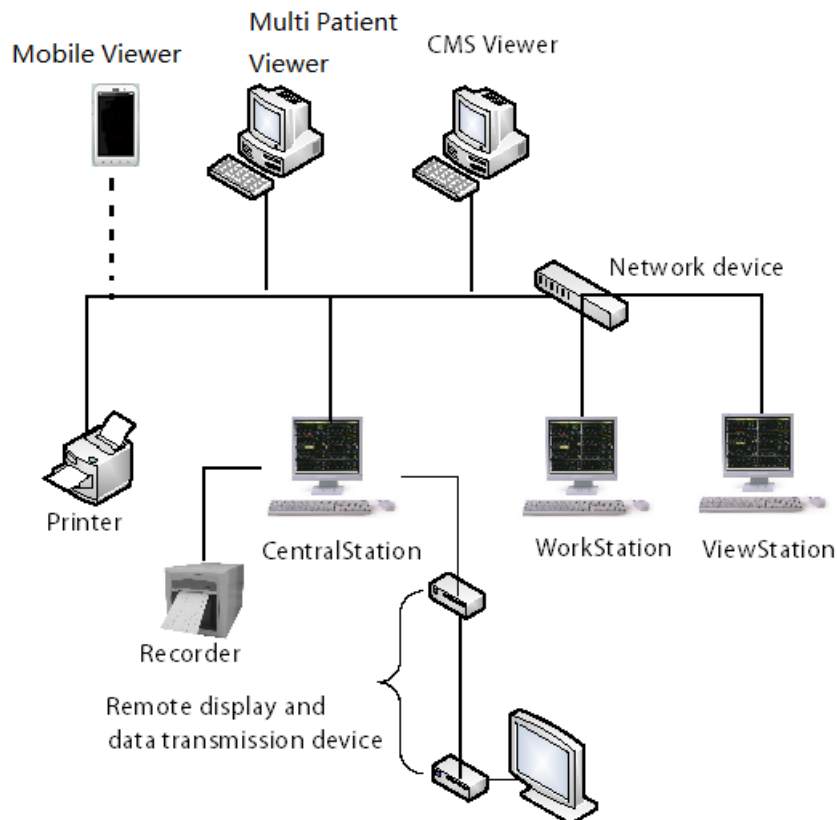

### 2.3.1 CentralStation

The CentralStation can admit Mindray devices via wired or wireless connection. It can display, store, print, and review the patient clinical data derived from compatible devices.

Depending on the running environment setting chosen at installation of the CentralStation, the CentralStation can run as application or as a service. Major differences between these two are described below:

- Running as application: You can view information such as data and alarms of connected monitoring devices on the CentralStation's screen. You can also view or modify settings such as parameter settings and system settings directly via the CentralStation.

- Running as a service: You cannot view information such as data and alarms of connected monitoring devices on the CentralStation's screen. But you can view these pieces of information on the screen of the WorkStation which is connected to the CentralStation. If you wish to change system settings of the CentralStation, you need to perform the changes at the WorkStation. For information regarding how to perform these changes, see *Section 15.14 Configuring CentralStation's System Settings via the WorkStation*.

### 2.3.2 WorkStation

The WorkStation can display and manage patient data with devices assigned from the host CentralStation (the host CentralStation refers to the CentralStation which the WorkStation, the ViewStation, or the CMS Viewer is connected to). All the patient data comes from the CentralStation.

You can enter or modify patient demographic information, configure alarm limits, alarm priorities, and discharge patients at the WorkStation based on the granted permissions.

### 2.3.3 ViewStation

The ViewStation can display patient data with devices assigned from the host CentralStation. All the patient data comes from the CentralStation. You can view patient data at the ViewStation only.

### 2.3.4 CMS Viewer

The CMS Viewer is used to view a single patient at the host CentralStation. It is independent of the CMS and shall be installed separately.

The CMS Viewer is for remote browsing only and cannot be used to set or control the host CentralStation or the devices at the host CentralStation.

For more information on the CMS Viewer, see *BeneVision Central Monitoring System Viewer Operator's Manual*.

### 2.3.5 Multi Patient Viewer

The Multi Patient Viewer is a part of the BeneVision Central Monitoring System (hereinafter referred to as CMS). It is used to view multiple patients connected to the target CentralStation. And it is for remote browsing only and cannot be used to set or control the target CentralStation or the monitoring devices at the target CentralStation.

For more information on the Multi Patient Viewer, see *BeneVision Multi Patient Viewer Operator's Manual*.

### 2.3.6 Mobile Viewer

The Mobile Viewer is a mobile application independent of the Central Monitoring System, supporting Android and iOS systems. Doctors, nurses and other medical personnel can use Mobile Viewer to view the data from bedside devices admitted by the Central Monitoring System.

### 2.3.7 Computer Platform

The CentralStation, the WorkStation, and the ViewStation consist of system software and computers. They have the same computer components: display, host computer, mouse, and keyboard.

#### 2.3.7.1 Display

Each of the CentralStation, the WorkStation, and the ViewStation can be equipped with up to four external displays. For display specifications, see *Appendix A Technical Specifications* in this manual.

If you are using a touchscreen display, you can select any selectable screen object by tapping the object.

#### NOTE

- **Displaying right click menus is not supported by the touchscreen.**
- **Do not use any sharp objects such as pencils to tap the screen.**

### 2.3.7.2 Host Computer

A host computer is used to run the CMS software program. The CentralStation, the WorkStation, and the ViewStation need to be installed on different host computers. For computer specifications, see Appendix *A Technical Specifications* in this manual.

### 2.3.7.3 Mouse

The mouse can be used to select a screen element by moving the cursor on the element and then clicking on it.

#### NOTE

---

- **Clicking refers to positioning the mouse pointer on a selection and pressing the left mouse button once.**
- 

### 2.3.7.4 Keyboard

A keyboard is used to type text into a data entry field.

### 2.3.8 License

A license is a prerequisite for using the CMS. It offers the following capabilities:

- Provide copyright protection for the CMS software.
- Configure functionalities.

#### NOTE

---

- **Do not exchange licenses among different CMS systems.**
- 

#### NOTE

---

- **If your license is lost, please contact Mindray service personnel.**
- 

### 2.3.9 Network Device

A network device such as a switch and access point is used to connect a bedside device to the CMS.

### 2.3.10 Remote Display and Data Transmission Device

The CMS supports connecting a video extender to display near-end videos at a remote site. The recommended remote display and data transmission device is ATEN KVM (Keyboard Video Mouse) products.

### 2.3.11 Recorder

The CMS can be equipped with a thermal recorder. The thermal recorder records patient information, measurement numerics and waveforms. The thermal recorder has a separate power supply. It can be connected to the CMS via a RS232 interface. For more information, see Chapter *14 Recording*.

### 2.3.12 Printer

The CMS can be equipped with a printer to output various reports. The printer has a separate power supply. For more information, see *13 Printing*.

## 2.4 Networking Mode

The CMS network consists of the bedside device network and the CMS network. The CMS supports networking among multiple central monitoring systems so that the patient data displayed on one CMS can be viewed by other networked CMS.

The typical networking diagram of the CMS is as shown below.



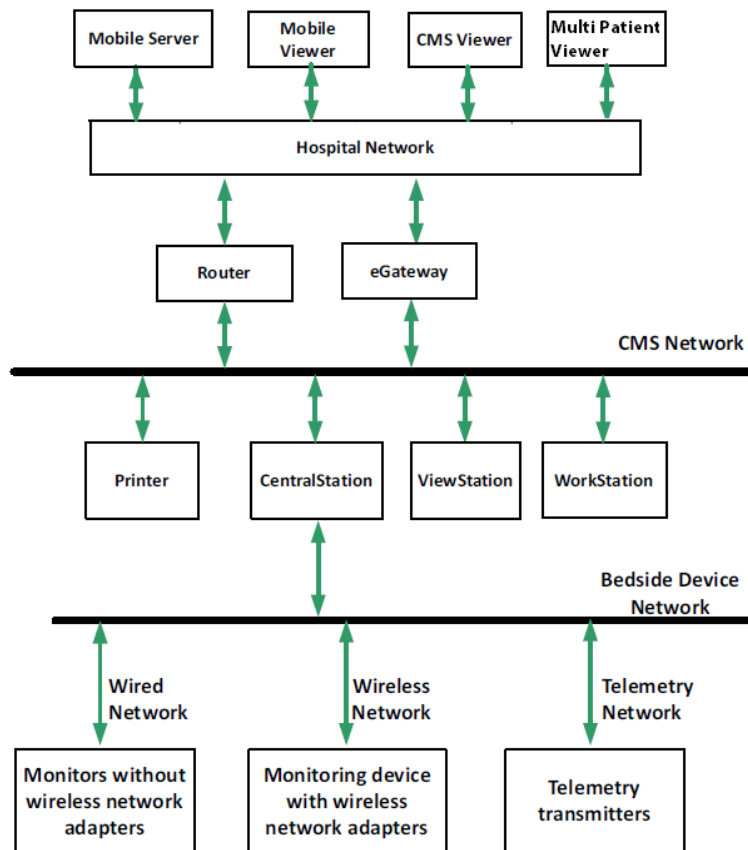

## 2.4.1 Bedside Device Network

Bedside devices connect with the CentralStation through wired network or wireless network.

### 2.4.1.1 Communication Modes

Bedside devices and the CentralStation communicate through Mindray private protocols.

### 2.4.1.2 Supported Devices

The bedside device network supports the following devices:

- Bedside monitors
  - ◆ DPM 3 vital signs monitor, DPM 4/DPM 5/DPM 6/DPM 7 patient monitors
  - ◆ Passport 2/Passport V/Passport 8/Passport 12/Passport 12m/Passport 17mpatient monitors
  - ◆ Spectrum/Spectrum OR patient monitors
  - ◆ Endeavour V12/Endeavour V21 patient monitors
  - ◆ Accutorr 7 patient monitor
  - ◆ BeneVision N series patient monitors
  - ◆ ePM series patient monitors
  - ◆ VS 8/VS 8A/VS 9 vital signs monitors
- Telemetry devices
  - ◆ TMS-6016
  - ◆ Panorama Telepack-608
  - ◆ TMS60
  - ◆ TM80

◆ TM70

## 2.4.2 CMS Network

The CMS network mainly consists of the CentralStation, the WorkStation, the ViewStation, the CMS Viewer, the Multi Patient Viewer and the Mobile Viewer. For details on all components of the CMS network, see 2.3 *System Components*.

# 3 Getting Started

---

## 3.1 Overview

This chapter describes preparation before using the CMS and gives an overview of the CMS.

## 3.2 Equipment Preparation Safety Information

---

### WARNING

---

- The CMS software copyright is solely owned by Mindray. No organization or individual shall resort to altering, copying, or exchanging it or to any other infringement on it in any form or by any means without due permission.
  - Connect only approved devices to the CMS. Devices connected to the equipment must meet the requirements of the applicable IEC standards (e.g. IEC 60950 safety standards for information technology equipment and IEC 60601-1 safety standards for medical electrical equipment). The system configuration must meet the requirements of the IEC 60601-1 medical electrical systems standard. Any personnel who connect devices to the equipment's signal input/output port are responsible for providing evidence that the safety certification of the devices has been performed in accordance to the IEC 60601-1. If you have any questions, please contact Mindray.
  - If it is not evident from the CMS specifications whether a particular combination with other devices is hazardous, for example, due to summation of leakage currents, please consult the manufacturer or an expert in the field. A determination must be made that the proposed combination will not negatively affect the devices themselves or the patient's safety.
- 

### CAUTION

---

- The CMS should be installed by authorized Mindray personnel.
  - Before unpacking, examine the packing case carefully for signs of damage. If any damage is detected, contact the carrier or Mindray.
  - Make sure that the CMS operating environment meets the specific requirements. Otherwise unexpected consequences, e.g. damage to the equipment, could result.
  - Components of the CMS, such as the keyboard and mouse, may be contaminated by microorganisms during transport, storage and use. Before removing them from their packaging, the packaging should be inspected for damage. In case of any damage, contact the carrier or Mindray immediately.
  - When disposing of the packaging material, be sure to observe the applicable waste control regulations and keep it out of children's reach.
  - Observance of this manual is a prerequisite for proper product performance and correct operation and ensures patient and operator safety.
- 

### NOTE

---

- Never place the CMS within a patient environment.
  - Do not block the displays of the CMS.
  - Put the CMS in a location where you can easily view and operate the equipment.
  - Keep this manual in the vicinity of the equipment so that it can be conveniently referenced when needed.
  - Save the packing case and packaging material as they can be used if the CMS must be reshipped.
- 

## 3.3 Turning On the System

Perform safety checks before starting your system. For more information, see Section 16.3 *General Inspection*.

To start the CMS system, follow this procedure:

1. Connect the power cord to an uninterruptible power supply (UPS).
2. Turn on the host to start the operating system and displays. The system will perform a series of self-tests.
  - ◆ If the self-tests pass, the system will beep one time and enter the multibed screen immediately.
  - ◆ If the self-tests fail, an error message is displayed. In this case, consult the manual provided with the computer for assistance or contact Mindray.

---

## CAUTION







---

- **To prevent damaging the system from a sudden power failure, it is recommended that the host of your CMS is equipped with a UPS.**
- 

## 3.4 Symbols on the Multibed Screen

The following table lists the symbols displayed on the multibed screen. The same symbol might display on other screens.

### 3.4.1 Patient Category Symbols







Symbol	Description	Symbol	Description
	Adult, male		Adult, female
	Pediatric, male		Pediatric, female
	Neonate, male		Neonate, female

## NOTE







---

- **Grey patient category symbol indicates that the gender of the patient is not specified.**
- 





### 3.4.2 Alarm Symbols

Symbol	Description	Symbol	Description
	All the alarms are paused.		Alarms for some parameter are turned off or the bedside device is in the alarm off state.
	Audible alarms are paused.		Audible alarms are turned off.
	Alarms are reset.		The system is silenced.

### 3.4.3 Operation Symbols

Symbol	Description	Symbol	Description
	Selecting this symbol releases the system from silenced state.		Selecting this symbol silences the system.
	Selecting this symbol displays clinical response to current EWS score.		System menu area symbol, selecting this symbol opens the system menu.
	Selecting this symbol opens the ViewBed screen.		Selecting this symbol opens the <b>Export Setup</b> menu. For more information on this menu, see <i>6.1 Example Multibed Screen</i> .









### 3.4.4 Battery Status Symbols







Symbol	Description	Symbol	Description
	The battery of the device has sufficient power.		The battery of the device has low charge and needs to be charged or changed.
	The battery of the device has critically low charge and needs to be charged or changed immediately. Otherwise, the device will shut down.		No battery is installed into the device.

#### NOTE

- When a battery symbol listed in the table above is displayed, see appropriate bedside device's operator's manuals for details about the battery time and alarms.

### 3.4.5 Other Symbols

Symbol	Description	Symbol	Description
	A patient's pacing status is set to <b>Yes</b> . The pace pulse markers "I" are shown on the ECG wave when a pacer pulse is detected.		A patient's pacing status is set to <b>No</b> or <b>Unspecified</b> .
	Indicate current EWS score is higher than the previous.		Indicate current EWS score is lower than the previous.
	Indicate current patient sector is idle and can admit a bedside device.		Contain more than one alarm messages.
	Indicate exporting failure.		Indicate that there are a total of five export tasks that are in progress or waiting to be started. The number in the green circle in the upper right corner changes with the number of export tasks. When there are less than five tasks, the number of actual export tasks is displayed. When there are more than five tasks, ellipsis dots are displayed.

Symbol	Description	Symbol	Description
	Indicate that the followed parameter is from an external device connected to the monitor.		This is the nurse call symbol. After the nurse call button is pressed on a bedside device, this symbol will continuously flash in the waveform area and a corresponding prompt tone will sound. This prompt tone will automatically terminate after two beeps. Selecting this symbol clears this symbol and stops the prompt tone. The nurse call will be stored on the event review page.
	This device is in privacy mode.		This device is in night mode.
	Indicate the Wi-Fi signal strength after a bedside device is connected to an AP. More white arcs indicate a stronger Wi-Fi signal strength.		Indicate the received signal strength of telemetry devices. The color of the symbol changes to indicate received signal strength changes. White: indicates the received signal strength is normal. Yellow: indicates the received signal strength is weak. Red: indicates no signal is received.
	Patient list symbol, selecting this symbol opens patient list.		

## 3.5 Bedside Device Operating Mode

When bedside devices support standby mode, night mode, or privacy mode, and remote control for these modes has been set at the CMS, you can control corresponding bedside devices to enter or exit these modes either via the bedside devices or via the CMS.

This section only describes how to put bedside devices into or out of these modes via the CMS. For details on how to set remote control for these modes, see Section 15.13.6 *Setting Authorization*. For details on how to put monitoring devices into or out of these modes via the bedside devices and how bedside devices behave in these modes, see corresponding operator's manuals for the bedside devices.

### 3.5.1 Standby Mode

When bedside devices are connected to the CMS and are in the monitoring mode, if you need to temporarily stop patient monitoring without switching off the devices, you can use standby mode.

#### NOTE

- For TMS-6016 and Panorama Telepack-608, you can put them into or out of standby mode via the CMS only.
- For the TMS60 telemetry monitoring system, you can put them into or out of standby mode via the TD60 telemetry transmitter only.

#### 3.5.1.1 Entering Standby Mode

To enter standby mode, follow this procedure:

1. Enter the standby dialog in either of the following ways:
  - ◆ Select the bed number and room number area in the upper left corner of the desired patient sector on the multibed screen → from the drop-down list select the  symbol.
  - ◆ On the ViewBed screen, select the **Standby** quick key.
2. Set **Location** optionally to define where the patient is when the bedside device is in standby mode.

3. Select **OK**.

## NOTE

---

- **Options for Location are configurable. For more information, see Section 15.5.6 Setting Patient Location.**
- 

### 3.5.1.2 Changing the Patient Location in Standby Mode

If you need to change the patient's location in standby mode, select **Location** from the Standby screen.

### 3.5.1.3 Exiting Standby Mode

To exit standby mode, use one of the following ways:

- Select the bed number and room number area in the upper left corner of the desired patient sector on the multibed screen → from the drop-down list select the  symbol.
- Select **Resume monitor** in the Standby window.

## 3.5.2 Night Mode

The night mode is a special clinical monitoring mode. For how a patient monitor behaves in night mode, see the patient monitor's operator's manual.

When **Night Mode** is set to **Enable One Bed** or **Enable All Beds** in the system menu of the CentralStation or the WorkStation, you can choose to put one patient monitor or all patient monitors into or out of night mode via the CentralStation or the WorkStation. For more information on the system settings, see Section 15.13.6 *Setting Authorization*.

### 3.5.2.1 Entering Night Mode

To enter night mode, follow this procedure:

1. Enter night mode dialog in either of the following ways:
  - ◆ Select the bed number and room number area in the upper left corner of the desired patient sector on the multibed screen → from the drop-down list select **Night Mode**.
  - ◆ On the ViewBed screen, select the **Night Mode** quick key.
  - ◆ On the ViewBed screen, select the **Main Menu** quick key from the quick key area → from the **Display** column select **Night Mode**.
2. Select whether to put current bedside monitor or all the bedside monitors into night mode.
3. Select **OK**. The bedside monitors selected will enter night mode. The  symbol will be displayed in the upper right corner of the patient sectors for the bedside monitors which are in night mode.

### 3.5.2.2 Exiting Night Mode

To exit night mode, follow this procedure:

1. Enter the night mode dialog in either of the following ways:
  - ◆ Select the bed number and room number area in the upper left corner of the desired patient sector on the multibed screen → from the drop-down list select **Night Mode**.
  - ◆ On the ViewBed screen, select the **Exit Night Mode** quick key.
  - ◆ On the ViewBed screen, select the **Main Menu** quick key from the quick key area → from the **Display** column select **Exit Night Mode**.
2. Select whether to put current bedside monitor or all the bedside monitors out of night mode.
3. Select **OK**.

## NOTE

---

- **A bedside monitor must be connected to the CMS to be allowed to enter night mode. When a bedside monitor in night mode is disconnected from the CMS, it will automatically exit night mode.**
- 

### 3.5.3 Privacy Mode

The privacy mode is a special clinical monitoring mode. In privacy mode, the bedside monitor does not display patient information and monitoring data. This provides controlled access to patient data and ensures confidentiality. In privacy mode, the bedside monitor continues monitoring the patient, but patient data is only visible at the CMS.

When **Privacy Mode** is set to **Enable One Bed** or **Enable All Beds** in the system menu of the CentralStation or the WorkStation, you can choose to put one patient monitor or all patient monitors into or out of privacy mode via the CentralStation or the WorkStation. For more information on the system settings, see Section 15.13.6 *Setting Authorization*.

#### 3.5.3.1 Entering Privacy Mode

To enter privacy mode, follow this procedure:

1. Enter privacy mode dialog in either of the following ways:
  - ◆ Select the bed number and room number area in the upper left corner of the desired patient sector on the multibed screen → from the drop-down list select **Privacy Mode**.
  - ◆ On the ViewBed screen, select the **Privacy Mode** quick key.
  - ◆ On the ViewBed screen, select the **Main Menu** quick key from the quick key area → from the **Display** column select **Privacy Mode**.
2. Select whether to put current bedside monitor or all the bedside monitors into privacy mode.
3. Select **OK**. The bedside monitors selected enter privacy mode. The  symbol is displayed in the upper right corner of the patient sectors for these bedside monitors.

---

## WARNING

---

- **In privacy mode, all audible alarms are suppressed and the alarm light is deactivated at the bedside monitor. Alarms are presented only at the CMS.**
- 
- 

#### 3.5.3.2 Exiting Privacy Mode

To exit privacy mode, follow this procedure:

1. Enter the privacy mode dialog in either of the following ways:

## 3.6 Transforming the WorkStation to CentralStation Temporarily

When the CentralStation fails and disconnects from the bedside devices and WorkStation, you can transform the WorkStation into a CentralStation temporarily to keep monitoring the patients. This works with one condition that the WorkStation can still connect to the bedside devices.

To transform the WorkStation into a CentralStation temporarily, select the system menu area in the upper left corner of the screen at the WorkStation → select **Switch to CentralStation Mode** → select the **OK** button. If the previous CentralStation recovers, the WorkStation will switch back to work as a WorkStation.

## NOTE

---

- **The Switch to CentralStation Mode function is available only when the CentralStation fails and disconnects from the WorkStation.**
- **The temporary CentralStation can only admit the following monitors: BeneVision N series and ePM series monitors with version 01.28.00.01 or above; VS series monitors with version 01.11.00.01 or above; TM70 and TM80 telemetry devices with version 04.05.00.10 or above.**



- **The temporary CentralStation is only for emergency and can not fulfill all the functions like a normal CentralStation.**
- 

### 3.7 Accessing M-IoT Device Management System

M-IoT device management system is used to manage devices connected to the Mindray network. To access the M-IoT device management system, follow this procedure:

1. Select the system menu area in the upper left corner of the main screen.
2. From the drop-down list, select **M-IoT Device Management System**.

For details on the M-IoT device management system, see corresponding user manual.

#### NOTE

- **M-IoT Device Management System displays in the system menu only when M-IoT Device Management System option is enabled. For details on how to enable M-IoT Device Management System, see 15.13.11 Enabling Accessing M-IoT Device Management System.**
- 

### 3.8 Viewing System Information

To view system information, follow this procedure:

1. Select the system menu area in the upper left corner of the screen.
2. From the drop-down list, select **System Information**.

### 3.9 Locking the TouchScreen

To temporarily disable the touchscreen, follow this procedure:

Hold and press the system menu area in the upper left corner of the main screen and slide as directed by the arrow.

A padlock symbol  displays on the left side of the system menu area if the touchscreen is disabled.

If the CMS system is configured with multiple touchscreens, locking one touchscreen disables other touchscreens.

The touchscreen is unlocked once the screen lock duration is reached. To set the screen lock duration, refer to 15.2.4.2 *Setting the Screen Lock Duration*. To manually unlock the touchscreen, hold and press the system menu area in the upper left corner of the main screen and slide as directed by the arrow.

### 3.10 Restarting the System

To restart the system, follow this procedure:

1. Select the system menu area in the upper left corner of the main screen.
2. From the drop-down list, select **Restart**. The system checks if any patients are being monitored:
  - ◆ If no patients are being monitored, go to the Step 3.
  - ◆ If patients are still being monitored, the message **N patients are being monitored. Are you sure you want to restart?** (where **N** stands for the number of patients) is displayed. Select **OK**.
3. Enter the password in the **Restart** dialog and select **OK**. The password is the same as that for accessing system setup tabs. Then, the CMS and the operating system will be automatically restarted.

### 3.11 Turning Off the System

It is important to properly turn off the system. To turn off the system, follow this procedure:

1. Select the system menu area in the upper left corner of the main screen.
2. From the drop-down list, select **Shutdown**. The system checks if any patients are being monitored:
  - ◆ If no patients are being monitored, go to the Step 3.

- ◆ If patients are still being monitored, the message **N patients are being monitored. Are you sure you want to shut down?**(where **N** stands for the number of patients) is displayed. Select **OK**.
3. Enter the shutdown password in the **Shutdown** dialog and select **OK**. The password is the same as that for accessing system setup tabs. Then, the CMS and the operating system will automatically shut down.

# 4 Device Management

---

The CMS can admit, discharge or bind devices.

## 4.1 Admitting Devices

Only when the devices are admitted by the CentralStation, can the CMS display the patient's physiological parameters, waveforms, alarm messages and store the corresponding patient data.

If you need to monitor the patient on the WorkStation or ViewStation, you should admit the devices from the CentralStation on the WorkStation or ViewStation.

### NOTE

---

- **The WorkStation and the ViewStation must be connected to the host CentralStation and have bed authorization before they admit a device from the host CentralStation. For information regarding connecting the host CentralStation and granting bed authorization, see Section 15.9.6 Setting CentralStation Connection and 15.9.7 Setting Bed Authorization.**
- 

### 4.1.1 CentralStation Automatically Admitting Devices

If the devices are collectively distributed within certain IP ranges or certain departments, you can set the CentralStation to automatically admit devices. To do so, follow this procedure:

1. Select the system menu area in the upper left corner of the screen → select **System Setup** to access the **System Setup** menu.
2. Select the **Device Management** tab → enter the required password → select the **OK** button to access the device management screen.
3. Select the **Auto Admit Device** tab to access the device admission page.
4. Set the desired condition for auto admission.
  - ◆ To admit bedside devices within an IP address range, enter the IP address into the **From** and **To** text boxes respectively. Then select **Add**. If the devices are distributed in many IP ranges, repeat this step.
  - ◆ To admit bedside devices within a particular department, enter the department name into the **Department** text box. Then select **Add**. The department entered must match the department entered at the bedside devices. If the devices are distributed in many departments, repeat this step.

Once the eligible bedside devices are detected, they will be automatically admitted and assigned to the CentralStation's multibed screen.

If you wish to cancel an auto admission condition, select the desired condition on the device admission screen, and then select **Delete**.

A bedside device automatically admitted is not bound with a patient sector on the multibed screen. After discharging a patient, the patient sector is in idle status. If you need to bind the device and the patient sector, refer to 4.3 *Binding or Unbinding the Device and the Patient Sector*.

### 4.1.2 WorkStation/ViewStation Automatically Admitting Devices

To monitor patients on the WorkStation or ViewStation, you need to admit devices from a CentralStation first.

If the devices are collectively distributed within certain CentralStations or certain departments, you can set the WorkStation or ViewStation to automatically admit devices. To do so, follow this procedure:

1. Select the WorkStation/ViewStation's system menu area in the upper left corner of the screen → select **System Setup** to access the **System Setup** menu.
2. Select the **Device Management** tab → enter the required password → select the **OK** button to access the device management screen.

3. Select the **Auto Admit Bed** tab.
4. Select the **Detail** button at the end of the desired CentralStation.
5. Set the desired conditions for auto assignment.
  - ◆ If you need to assign all the bedside devices from the host CentralStation, select **Auto Admit all beds in this CentralStation**.
  - ◆ If you need to assign some bedside devices from the host CentralStation, do not select **Auto Admit all beds in this CentralStation**. Instead, enter the desired numbers under **Department, Room No** and **Bed No**, and then select the **Add** button on the right of **List of Beds Admitted Automatically**.
6. If you need to admit devices from more CentralStations or more departments, repeat step 4 and step 5.

Once the eligible devices are detected, they will be automatically assigned to idle patient sectors on the multibed screen of the WorkStation or the ViewStation in the order of left to right and from top to bottom.

A bedside device automatically assigned is not bound with a patient sector on the multibed screen. After discharging a patient, the patient sector is in idle status. If you need to bind the device and the patient sector, refer to *4.3 Binding or Unbinding the Device and the Patient Sector*.

## NOTE

- **When you need to assign some bedside devices from the host CentralStation, do not select Auto Admit all beds in this CentralStation, otherwise, all the devices in this CentralStation will be admitted.**

### 4.1.3 Manually Admitting Devices

This chapter applies to CentralStation, Workstation and ViewStation.





#### 4.1.3.1 Entering the Device Assignment Menu

Enter the device assignment menu in either of the following ways:

- Select the system menu area in the upper left corner of the screen → select **System Setup** to access the **System Setup** menu → select the **Device Management** tab → enter the required password → select the **OK** button.
- Select the system menu area in the upper left corner of the main screen → from the drop-down list select the **Device Management** tab → select **Device Assignment** tab.
- On the Multibed screen, select the patient sector with the  symbol.

If you enter the device assignment menu in the first way, the admitted device and the patient sector will be bound, while in the second and third ways, the admitted device and the patient sector will not be bound. For details on binding the device and the patient sector, refer to *4.3 Binding or Unbinding the Device and the Patient Sector*.

After entering the device assignment menu, you may see the following symbols:

-  : select this symbol to see device information such as IP address, admitting status etc.
-  : select this symbol to sort the devices.
-  : select this symbol to refresh the device list.
-  : this symbol indicates that this device cannot be admitted by the current CentralStation as it has been admitted by another CentralStation. Select this symbol to see the device information such as IP address, admitting status etc.

#### 4.1.3.2 Starting Manually Admitting Devices

To start manually admit devices, follow this procedure:

1. Enter device assignment menu. For how to enter device assignment menu, refer to *4.1.3.1 Entering the Device Assignment Menu*.
2. If you have multiple screens, select the desired screen to admit devices. You can select **Identify** to verify the numbering of the screen.
3. Click  button and select the department where the devices are located.

4. If you need to specify a patient sector for the device, select one. Without specifying a patient sector, the devices will be assigned to idle patient sectors on the multibed screen in the order of left to right and from top to bottom.
5. Select the **+** symbol on the right side of the desired device to admit this device.

## 4.2 Testing Devices Connection

If the device is not connected with the CMS properly, you can test to find the reason. To test the connection between the device and the system, follow this procedure:



1. Select the system menu area in the upper left corner of the screen → select **System Setup** to access the **System Setup** menu → select the **Device Management** tab → enter the required password → select the **OK** button.
2. Select the **Device Assignment** tab to access the device assignment screen.
3. On the right side of the screen, select **Network Test**.

## 4.3 Binding or Unbinding the Device and the Patient Sector

If you need to monitor a device for a long period of time, bind the device and the patient sector, then you will be able to monitor this device on this specific patient sector.

If you need to temporarily monitor a device, unbind the device and the patient sector, then the patient sector can admit a new device when a patient is discharged from the device.

To bind or unbind the device and the patient sector, follow this procedure:

1. Select the system menu area in the upper left corner of the screen → select **System Setup** to access the **System Setup** menu → select the **Device Management** tab → enter the required password → select the **OK** button.
2. Select the **Device Assignment** tab to access the device assignment screen.
3. Select the device symbol on the desired patient sector to bind or unbind the device and the patient sector:
  - ◆  : this symbol indicates that the device and the patient are bound. When the patient is discharged, the device is still admitted and taking up this patient sector. After readmitting a patient, you can continue monitoring this device on this patient sector.
  - ◆  : this symbol indicates that the device and the patient sector are not bound. Once the patient is discharged, the device is discharged and the patient sector can admit a new device.



## 4.4 Connecting a Patient Monitor with a Telemetry Device

If both a patient monitor and a telemetry device are available for the same bed and you need to choose the device per patient's condition, you can connect the patient monitor with the telemetry device at the CentralStation or the WorkStation. After these devices are connected successfully, when the patient's condition improves and the patient can perform out-of-bed activities, you can choose the telemetry device to view patient monitoring data. When the patient's condition worsens, you can choose the patient monitor to view patient monitoring data.

When a patient monitor supports connecting a telemetry device or vice versa, the  symbol is displayed in the lower right corner of the patient sector on the device assignment screen.



### 4.4.1 Connecting Procedures

To connect a patient monitor with a telemetry device, follow this procedure:

1. Access the device assignment screen in either of the following ways
  - ◆ Select a patient sector with the **+** symbol on the multibed screen.
  - ◆ Select the system menu area in the upper left corner of the main screen → from the drop-down list select the **Device Management** tab → select **Device Assignment** tab..
2. On the left side of the screen, select the  symbol. The device list is displayed.
3. Select the desired device. If you wish to view more details about this device, select the  symbol.
4. Select **OK** in the popup dialog box.

## 4.4.2 Disconnecting a Patient Monitor with a Telemetry Device

To disconnect a patient monitor with a telemetry device, follow this procedure:

1. Access the device assignment screen in either of the following ways
  - ◆ Select a patient sector with the  symbol on the multibed screen.
  - ◆ Select the system menu area in the upper left corner of the main screen → from the drop-down list select the **Device Management** tab → select **Device Assignment** tab.
2. On the left side of the screen, select the  symbol. The **Remove Device** dialog box is displayed.
3. Select the desired device and select **OK**.

## 4.5 Checking the Pairing of a Telemetry Device and a Patient Monitor

You can connect a TM80 or TM70 telemetry monitor (hereinafter called the telemetry) with the N series monitor (hereinafter called the monitor) to measure the ECG, Resp, SpO<sub>2</sub>, and NIBP of ambulatory adult and pediatric patients. The process of connecting the telemetry and the monitor is called "pairing". For details on how to pair the telemetry and the monitor, refer to the operator manuals of the telemetry and the monitor.

You can check whether the telemetry and the monitor are paired or not on the CentralStation, WorkStation or ViewStation.

Follow this procedure:

1. Access the ViewBed screen in either of the following ways:
  - ◆ Select the parameter area or waveform area in the desired patient sector on the multibed screen.
  - ◆ Select the ViewBed symbol  when it is displayed in the desired patient sector on the multibed screen.
2. Access the Bedside Devices window in either of the following ways:
  - ◆ Select the bedside devices hot key at the bottom of the ViewBed screen.
  - ◆ At the bottom of the ViewBed screen, select **Main Menu** quick key from the quick key area → from the **Bedside Devices** column select **Bedside Devices**.

If the telemetry is displayed in the Bedside Device window, it indicates the telemetry is paired with the monitor; if not, then the telemetry is not paired with the monitor.

## 4.6 Checking the Device List

The device list displays the information of all the devices connected to the system. The device list feature is available at the CentralStation, ViewStation and WorkStation.

To check the device list, follow this procedure:



1. Select the system menu area in the upper left corner of the screen → select **Device Management**.
2. Select the **Device List** tab. The device list window displays device type, device name and device status etc.
3. You can perform the following operations in the device list window:
  - ◆ Enter key words in the search bar to select the desired devices.
  - ◆ Select the refresh symbol  to manually refresh the device list.
  - ◆ Select a field in the first row of the device list. The list will sort by this field. For example, selecting the **Device Type** field makes the device list sorted by the device type.

### NOTE

- You can check the device list only when the system is connected with a master server.

## 4.7 Discharging Devices

To discharge devices, follow this procedure:

1. Select the system menu area in the upper left corner of the screen → select **System Setup** to access the **System Setup** menu → select the **Device Management** tab → enter the required password → select the **OK** button.
2. Select the **Device Assignment** tab to access the device assignment screen.
3. Discharge the device in either of the following ways:
  - ◆ Select the desired screen → select the  button on the patient sector.
  - ◆ Click  button and select the department where the devices are located → select the  button to discharge the device.

**This page intentionally left blank.**



# 5 Patient Management

---

## 5.1 Patient Management Overview

The CentralStation, the WorkStation, and the ViewStation provide different patient management capabilities.

- The CentralStation and the WorkStation provide the following capabilities:
  - ◆ Obtaining patient information
  - ◆ Viewing patient information
  - ◆ Changing patient information
  - ◆ Searching for patients
  - ◆ Discharging patients
  - ◆ Transferring patients
- The ViewStation only provides the capability of viewing patient information.

## 5.2 Accessing the Patient Management Screen

After admitting or assigning devices, you can manage patients on the patient management screen at the CentralStation or the WorkStation.

Enter the patient management screen in either of the following ways:

- Select the patient information area in the desired patient sector on the multibed screen.
- On the ViewBed screen, the review screen, or the calculation screen, select the **Patient Management** tab.



## 5.3 Patient Information Management

You can enter, edit or search patient information on the CMS.

### 5.3.1 Loading Patient Information by ADT Query

When the CentralStation and the WorkStation are connected with a hospital information system, you can utilize the admit-discharge-transfer (ADT) query function to obtain patient information from the hospital information system and import the patient information to the CentralStation or the WorkStation.

To load patient information, follow this procedure:



1. On the patient management screen, select the **Find Patient** button.
2. Select the **ADT** tab.
3. Input query criteria.
4. Select the  button.
5. Select the  button at the end of the desired patient to import the patient information to the CentralStation or the WorkStation.

#### NOTE

- **The ADT tab is available only when the ADT feature is enabled in the system setup. For details on how to enable this feature, see Section 15.9.4.1 *Installing and Setting eGateway*.**
- **Loading patient information from the hospital information system updates only patient information in the device. The patient's data is not changed and the patient is not discharged.**

### 5.3.2 Importing Discharged Patient Information

To import discharged patient information, follow this procedure:

1. On the patient management screen, select the **Find Patient** button.
2. Select the **Discharged Patients** tab. The Discharged Patients will only be displayed within a tab when the ADT feature is enabled in the system setup. If the ADT feature is disabled, there is no tab to select. Proceed to the next step.
3. Input query criteria.
4. Select the  button.
5. Select the  button at the end of the desired patient.
6. When the **Readmit Patient** dialog appears, decide whether to import **History data**.
  - ◆ Select **History data** when you wish to merge the patient demographic information and historical data into current data for this patient.
  - ◆ Do not select **History data** when you wish to merge only the patient demographic information into current data for this patient.
7. Select the **OK** button.

### 5.3.3 Manually Entering Patient Information

To manually enter patient information, follow this procedure:

1. On the patient management screen, enter or select the desired patient information fields. Only fields that may need special remarks are described here.
  - ◆ **Patient Category:** set the patient category corresponding to the patient being monitored.
  - ◆ **Paced:** set the patient's paced status. For paced patients, you must set **Paced** to **Yes**. If it is incorrectly set to **No**, the device could mistake a pace pulse for a QRS and fail to alarm when the ECG signal is too weak. Always keep pacemaker patients under close surveillance.
  - ◆ **Care Group:** after assigning a patient to a care group, the bed number and room number area in the upper left corner of the patient sector on the multibed screen is filled with the selected care group color. This allows a caregiver to quickly identify beds for which they are responsible. For details on how to customize the care group, see Section 15.5.8 *Setting Care Groups*.
  - ◆ **Patient Group:** after assigning a patient to a patient group, the starting portion of the patient information area on the multibed screen is filled with the selected patient group color. This allows you to quickly identify patient types. For details on how to customize the patient group, see Section 15.5.7 *Setting Patient Group*.
  - ◆ **Notes:** you can enter additional information. The text entered is displayed in the notes area in the patient sector on the multibed screen.
2. When done, verify that all the patient information items are correct.
3. Select the **Save** button.

#### NOTE

- 
- **The items displayed on the patient management screen are dependent on the system settings. For details on how to configure these items, see Section 15.5.2 *Configuring Patient Fields*.**
- 

### 5.3.4 Changing Patient Information

When you change the patient information at the CentralStation or the WorkStation, the information is also changed at the devices.

This section only describes how to change patient information at the CentralStation or the WorkStation. For details on how to change information at the devices, see corresponding operator's manuals for these devices.

To change patient information, follow this procedure:

1. On the patient management screen, change the patient information in the appropriate fields as necessary.
2. After finishing changing, verify that all the patient information items are correct.
3. Select the **Save** button.

## 5.3.5 Searching Patient Information

You can search discharged patients in the HIS system or in a CentralStation. After finding the desired patient information, you can perform operations such as importing and reviewing the patient information. The searching patients feature is available at the CentralStation and the WorkStation.

### 5.3.5.1 Searching Patient Information by ADT

To search patient information in the HIS system by ADT, follow steps 1 to 4 in Section 5.3.1 *Loading Patient Information by ADT Query*.

### 5.3.5.2 Searching Discharged Patients

You can search discharged patients on the patient management screen and on the discharged patients management screen. This section only describes how to search discharged patients on the patient management screen. For details on how to search discharged patients on the discharged patients management screen, see Section 5.6.2 *Viewing Discharged Patient Information*.

To search discharged patients, follow steps 1 to 4 in Section 5.3.2 *Importing Discharged Patient Information*.

## 5.3.6 Patient Information Synchronization

When bedside devices are connected to the CentralStation/ WorkStation, any changes to the patient information at either the CentralStation/ WorkStation, or the bedside devices will be synchronized to all displayed locations to ensure that the patient information is consistent.

When devices are disconnected from the CentralStation/ WorkStation and then reconnected, patient information from the devices will be updated to the CentralStation/ WorkStation.

## 5.4 Discharging A Patient

Before monitoring a new patient, discharge the previous patient. This ensures that data from a previous patient is not mixed with the data from the new patient.

This section only describes how to discharge patients at the CentralStation/ WorkStation. Patients can also be discharged from the bedside device. For details on how to discharge patients at the bedside devices, see corresponding operator's manuals for these devices.

To discharge a patient, follow this procedure:

1. Access the **Discharge Patient** dialog in either of the following ways:
  - ◆ On the patient management screen, select the **Discharge Patient** button.
  - ◆ Select the bed number and room number area in the upper left corner of the desired patient sector on the multibed screen and then select **Discharge Patient** from the drop-down list.
2. If you need to print an end case report, select **Print End Case Report**.
3. Select whether to let this device enter standby mode after the patient is discharged.
4. Select the **OK** button.

## 5.5 Transferring Patient Data

Only when the transferring patient function is allowed in the system setup menu of the CentralStation/ WorkStation, you can transfer a patient from one bed (source bed) to another bed (destination bed) without losing patient data. For information on the system setup, see Section 15.13.6 *Setting Authorization*.

This section only describes how to transfer patients from the CentralStation/WorkStation. For details on how to transfer patient data at the bedside devices, see corresponding operator's manuals for these devices.

To transfer patient data, follow this procedure:

1. On the patient management screen, select the **Transfer Patient** button to enter the **Transfer Patient** window
2. Select the destination unit under **Select the destination CMS:**
  - ◆ **Local:** transfers the patient data to the destination bed in the current CentralStation/WorkStation.

- ◆ **Other:** transfers the patient data to the destination bed in the target CentralStation. After selecting this option, select the target CentralStation name from the list box on the right of **Other**.
3. In the **Select the destination bed:** section, select the desired destination bed from the bed list.
  4. Select the **OK** button.
  5. In the **Transfer Patient** dialog box, select the **OK** button.
  6. In the dialog box that prompts successful patient transfer, select the **OK** button.

Usually, data transfer takes about several minutes. The larger the amount of patient data, the longer time required by data transfer. Upon successful transfer, the source bed's patient sector displays **Discharged**. The **Transferring Data... xx** (where xx stands for the data transfer completion percentage) prompt message is displayed in the alarm information area of the destination patient sector, indicating merging patient data from the source bed to the destination bed is in progress. If the data transfer fails, the **Failed to transfer the patient** prompt message is displayed.

## NOTE

- **When the system time at the source CentralStation/WorkStation and target CentralStation is not consistent, transferring a patient may cause patient data loss.**
- **Ensure that the same patient is monitored by both the source and destination beds. Otherwise, discharge the patient in the destination patient sector first.**
- **When a patient is transferred from one bed to another bed, the source CentralStation/WorkStation will interrupt patient monitoring temporarily.**
- **If there is a version difference between two CentralStations, patient transfer may not be supported.**

## 5.6 Discharged Patients Management

On the discharged patients management screen, you can perform operations such as viewing the demographic information and historical data for discharged patients.

## NOTE

- **When "Prompt on patient auto deleted" is enabled in the system setup menu, if the storage space is nearly full, the alarm "The patient data storage space is nearly full. Please delete some discharged patients." is displayed in the system alarm area at the top of the screen. In this case, delete some discharged patients. Otherwise, the oldest discharged patient and corresponding historical data will be deleted automatically.**

### 5.6.1 Accessing the Discharged Patients Management Screen

To access the discharged patients management screen, follow this procedure:

1. Select the system menu area in the upper left corner of the screen.
2. From the drop-down list, select **Discharged Patients**. If managing discharged patients is password protected, enter the password. For details, refer to *15.13.6.5 Setting Clinic Permissions*.

### 5.6.2 Viewing Discharged Patient Information

To view discharged patient information, follow this procedure:

1. Select the target CentralStation from the  button in the upper left corner of the discharged patients management screen.
  - ◆ **Local Central Station:** view discharged patients in current station.
  - ◆ Name of other central stations: view discharged patients in other central stations.
2. Input query criteria. If you need to specify more criteria, select the **Filter** button and input more criteria.
3. Select the **Search** button.
4. Select the **Detail** button in the desired patient information. After selecting this button, you can view the patient information and historical data in the **Patient Management** tab and **Review** tab respectively. For details on patient information review, see *10 Review*.

### 5.6.3 Deleting Discharged Patient Information

To view delete patient information, follow this procedure:

1. Select the target CentralStation from the  button in the upper left corner of the patient management screen.
  - ◆ **Local Central Station:** view discharged patients in current station.
  - ◆ Name of other central stations: view discharged patients in other central stations.
2. Select the desired patient information. If you wish to select all the patient information, select the **Select All** button.
3. Select the **Delete** button.
4. In the dialog box that prompts whether to delete, select the **OK** button.

#### NOTE

---

- **Only CentralStation and WorkStation supports deleting discharged patient information.**
  - **Discharged patient information can be deleted only when Delete Discharged Patients is set to No Password or Local Password in the system setup. For more information, see Section 15.13.6.4 Setting the Permission to Delete Discharged Patient Information.**
- 

### 5.6.4 Printing Historical Data of Discharged Patients

After entering the review screen of discharged patients, you can print historical data of discharged patients.

For details on how to enter the review screen of discharged patients, see Section 10.2.2 *Entering the Review Screen for Discharged Patients*.

For details on how to print historical data of discharged patients, see Chapter 10 *Review*.

**This page intentionally left blank.**

# 6 Multibed Screen

Once started, the CMS displays the multibed screen where multiple patients are monitored collectively.

## 6.1 Example Multibed Screen

The following figure shows the regular multibed screen:

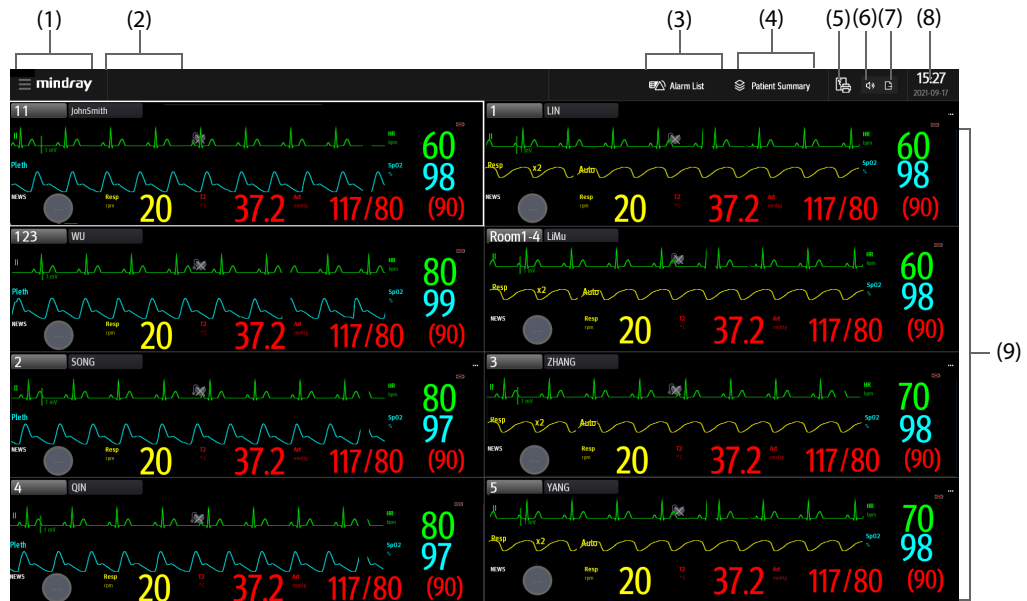

- (1) System menu area: selecting this area opens the drop-down list where you can select different functions.
- (2) Hospital information area/system alarm area: when system level alarms are not triggered, this area displays the hospital name and department where the CMS is located. If you need to change the hospital name or department, see Section 15.13.8 *Setting A Device Location*.  
When system level alarms are triggered, this area displays the highest priority alarm message. Selecting this area opens the list of currently triggered system alarm messages. You can also review the system alarm messages in the alarm list area. For information on system alarm messages, see Section B.2 *Alarm Messages in the System Alarm Area*.
- (3) Alarm list area: selecting this area opens the alarm list that includes physiological and technical alarms within one hour for all the beds being monitored by the CMS.
- (4) Patient Summary: selecting this area opens the **Patient Summary** window where you can view and select patients that requires special attention. For more information on this window, see Section 6.3 *Patient Summary*.
- (5) Print button: selecting this button displays print and record related menus. For more information on these menus, see Chapter 13 *Printing*.
- (6) System silence symbol: selecting this symbol silences the system. When the system is silenced, the  symbol is displayed at the top of the screen.
- (7) Trend data or waveform data export queue symbol: selecting this symbol opens the **Export Setup** menu. In this menu, you can view export tasks in the **Name** column and view export progress and results in the **Status** column. Upon successful export, the task disappears from the task list.  
Selecting **Retry Failed Export** at the bottom of the menu re-exports failed items. Selecting **Remove Failed Export** removes all the export failure items from the task list.  
Note: the export symbol is displayed only when **Save As** is enabled in the system menu. For more information on enabling **Save As**, see 15.7.6 *Setting Patient Data Export*.
- (8) System time area.
- (9) Patient sector: displays real-time monitoring data. One patient sector displays data from one patient only. For more information, see 6.2.5 *Patient Sector Status*.

## 6.2 Patient Sector

When a patient is being monitored, the patient sector displays real-time patient data from the bedside device, as shown below.

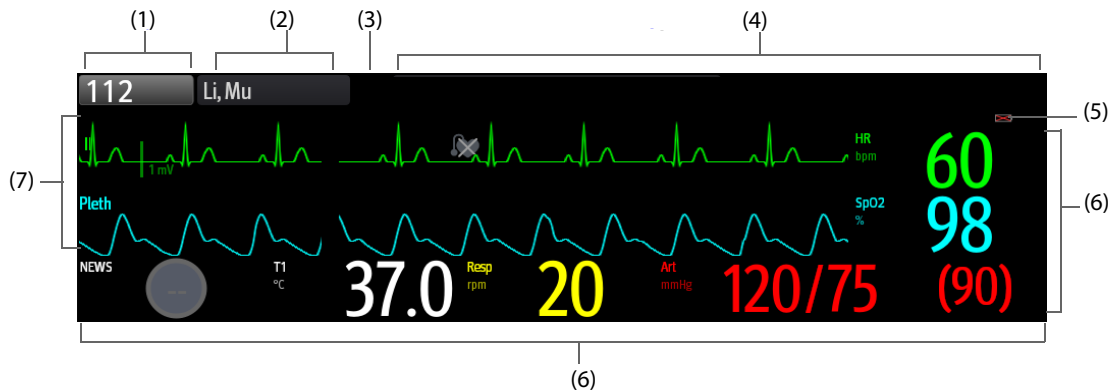

- (1) Bed number and room number area: displays the bed number and room number. The background color of the area changes according to the care group the bed is assigned to. Default dark gray indicates the bed is not assigned to any care group. For more information about this area, see Section 6.2.1 *Bed Number and Room Number Area*.
- (2) Patient information area: it can be set to display patient name or patient ID or visit number. The triangle symbol on the upper-right corner indicates the patient group the bed is assigned to. No triangle symbol indicates the bed is not assigned to any patient group.
- (3) Alarm status symbol: indicates current alarm status. For more information, see 3.4 *Symbols on the Multibed Screen*.
- (4) Alarm information area: displays the highest priority alarms. The ellipsis symbol “...” indicates that there are more than one alarm message. For more information, see Section 6.2.2 *Alarm Information Area*.
- (5) Status information area: displays information such as notes, device signal, device name, device location, operating mode, and battery power. For description of symbols, see Section 3.4 *Symbols on the Multibed Screen*.
- (6) Parameter area: displays parameters of the monitoring devices . Selecting this area enters the ViewBed screen. Blue background indicates unhandled alarms or reminds EWS measuring.
- (7) Waveform area: displays waveforms transmitted from a bedside device. When one or all lethal arrhythmia alarms are set to off, a corresponding message is displayed under the first ECG waveform. Selecting this area enters the ViewBed screen. Blue background indicates unhandled alarms or reminds EWS measuring.

### NOTE



- **Contents displayed in a patient sector are subject to the number of patient sectors. The less the number of patient sectors, the more contents displayed in a patient sector. For details on how to set the number of patient sectors, see Section 15.3.3.4 *Setting the Number of Patient Sectors*.**

### 6.2.1 Bed Number and Room Number Area

Selecting this area opens the drop-down list where you can perform a series of operations. Only items that may need special remarks are described here.

Menu Item	Description
Use Telemetry	<p>When a patient monitor has been connected with a telemetry device at the CentralStation or WorkStation, the option <b>Use Telemetry</b> or <b>Use Host Monitor</b> is displayed.</p> <p>If you wish to view patient data monitored by a telemetry device or a patient monitor, select <b>Use Telemetry</b> or <b>Use Host Monitor</b> respectively. Then select <b>OK</b> in the <b>Select Device</b> dialog box.</p> <p>For more information on connecting a patient monitor with a telemetry device, see Section 4.4 <i>Connecting a Patient Monitor with a Telemetry Device</i>.</p>
Use Host Monitor	



Menu Item	Description
Monitor Mode	When a telemetry device has been connected with the CentralStation or WorkStation through wireless network or pairing with a patient monitor, the option <b>Monitor Mode</b> or <b>Telemetry Mode</b> is displayed.  When a patient moves out of the department area, you need to pay close attention to the patient's status on the patient's side. In this case, tap <b>Monitor Mode</b> .  If the patient returns to the department area, tap <b>Telemetry Mode</b> . Switching mode on the CentralStation would be synchronized to the telemetry device.
Telemetry Mode	
Move Position to	Move a patient sector from the source patient sector to the target patient sector on the multibed screen. The source patient sector and the target patient sector swap positions. For locked patient sectors, whether this option is displayed is dependent on the system setup. For more details about system setup, see Section 15.3.4 <i>Setting Sectors</i> .
	Reset alarms. For more information, see Section 8.9 <i>Alarm Reset</i> .
	Pause alarms. For more information, see Section 8.7.1 <i>Pausing Alarms</i> .
	Standby mode. For more information, see Section 3.5.1 <i>Standby Mode</i> .
Clear Overview Bed	Clear the patient sector. This function is used for clearing a patient sector where a bedside device from a remote CentralStation is displayed.

## 6.2.2 Alarm Information Area

You can view all the alarm messages for a bed by selecting the alarm information area.

This area displays alarms and prompts from a bedside device or from the CMS.

For details on the alarm information, see 8 *Alarms*.

## 6.2.3 Changing Screen Setup of the Patient Sector

To change screen Setup of the patient sector, follow this procedure:

1. Select the bed number and room number area in the upper left corner of the desired patient sector on the multibed screen.
2. From the drop-down list, select **Screen Setup**.
3. Set the desired screen. **Normal Screen** is most frequently used for patient monitoring. **Big Numerics** displays parameter numerics in big font size.

### NOTE

- **Changing the screen settings affects the patient sector only and does not affect the screen settings for the ViewBed screen.**
- **Changes to the screen settings are only a temporary change. Once a patient is discharged from this patient sector, the screen settings configured will be cleared and the default department configurations will be automatically loaded to the patient sector.**

## 6.2.4 Changing the Tile Layout of the Patient Sector

To change tile layout of the patient sector, follow this procedure:

1. Select the bed number and room number area in the upper left corner of the desired patient sector on the multibed screen.
2. From the drop-down list, select **Screen Setup**.
3. Select the **Tile Layout** tab.
4. Select a parameter area or waveform area, and then from the drop-down list select an element you want to display in this area. The parameters and waveforms selected are displayed in the patient sector.

## NOTE

---

- **The list of parameters/waveforms under the drop-down list in the Tile Layout tab is the super set, not depending on a bedside device. If a parameter/waveform is not supported by the bedside device, it is not displayed in the patient sector.**
  - **Changing the screen settings affects the patient sector only and does not affect the screen settings for the ViewBed screen.**
  - **Changes to the screen settings are only a temporary change. Once a patient is discharged from this patient sector, the screen settings configured will be cleared and the default department configurations will be automatically loaded to the patient sector.**
- 

### 6.2.5 Patient Sector Status

Except displaying transmitted data from the bedside devices normally, the patient sector may stay in one of the following operating states:

- **Offline:** indicates that this patient sector has a patient admitted but its corresponding bedside device may be turned off or disconnected from the CentralStation.
- **Standby:** indicates that the bedside device is in standby mode.
- **Discharged:** indicates that the patient has been discharged from the bedside device or from the CMS.
- **Idle:** indicates that no bedside device has been associated with this patient sector. The patient sector is available for admitting a new bedside device. For details on how to admit bedside devices, see Chapter 4 *Device Management*.

### 6.2.6 Sorting Patient Sectors

Patient sectors can be either manually or automatically sorted according to the criteria configured in the **System Setup** menu.

To manually sort patient sectors, follow this procedures:

1. Select the system menu area in the upper left corner of the main screen.
2. From the drop-down list, select **Sector Sorting**.
3. In the **Sector Sorting** dialog, select **OK**.

For information regarding sorting criteria and automatic sorting, see Section 15.3.4 *Setting Sectors*.

## NOTE

---

- **The Sector Sorting option is available only when Sort Type is set to Manual in the System Setup Menu.**

## 6.3 Patient Summary

In the **Patient Summary** window, you can view the trend data and alarm statistics of selected patients.

Select  **Patient Summary** at the top of the screen to access the **Patient Summary** window.

## NOTE

---

- **When the CMS is equipped with one 19-inch display only, the patient summary function is not supported.**
- 

### 6.3.1 Example Patient Summary Window

The **Patient Summary** window displays overview information of four patients. You can view the information of more patients by moving the cursor or the touchscreen.

This figure takes overview information of a single patient for example.

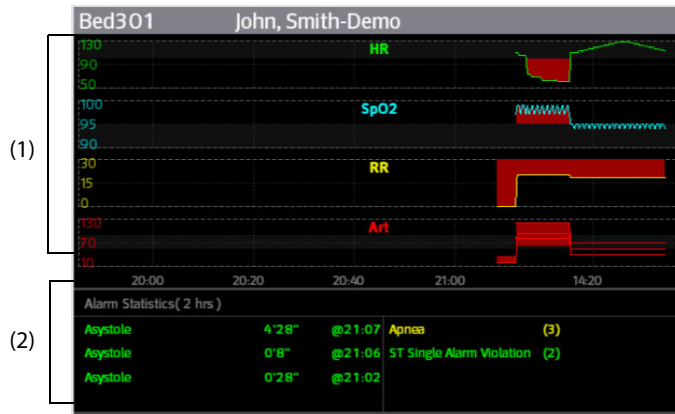

(1)	Trend data area: displays the trend data of HR, SpO <sub>2</sub> /SpO <sub>2</sub> b, RR, and NIBP/IBP within the selected <b>Zoom</b> option. When a patient monitor supports Early Warning Scores (EWS), the trend data of EWS scores is also displayed. Selecting the trend data area enters the graphic trends review page. For more information about this review page, see Section 10.7 <i>Graphics Trends Review Page</i> .
(2)	Alarm statistics area: displays physiological alarm information such as alarm trigger time, times of alarms, or alarm duration within the selected <b>Zoom</b> option.

### 6.3.2 Filtering Patient Data

You can filter the desired patient data by bed number, patient group, or care group.

To filter patient data, follow this procedure:

1. In the **Patient Summary** window, select the desired filter criterion: **Bed No**, **Patient Group**, or **Care Group**. The background color of the selected criterion changes green.
2. In the **Filter** window that pops up, select the desired beds. If you wish to view data of all beds, select **Select All**.
3. Select the  button in the upper right corner of the **Filter** window.

### 6.3.3 Changing the Time Length of Trends

To change the time length of trend data displayed in the **Patient Summary** window, follow this procedure:

1. Select **Zoom** in the upper right corner of the **Patient Summary** window.
2. Select the desired option. The default is **8 hrs**.

**This page intentionally left blank.**

# 7 ViewBed Screen

You can have a more detailed view of a single patient's information, waveforms, and parameter numerics on the ViewBed screen.

## 7.1 Accessing the ViewBed Screen

Access the ViewBed screen in either of the following ways:

- Select the parameter area or waveform area in the desired patient sector on the multibed screen.
- Select the ViewBed symbol  when it is displayed in the desired patient sector on the multibed screen.

### NOTE

- When the CMS is equipped with one display only, the ViewBed screen is displayed in the lower half of the screen or on the right of the screen depending on the display size.

### NOTE

- When the CMS is equipped with more than one display, the ViewBed screen can be displayed on a dedicated secondary display. For details on how to set the secondary display, see Section 15.3.3.5 *Setting the Number of Primary Screens*.

## 7.2 Example ViewBed Screen

The ViewBed screen displays monitoring information from the monitoring device.

The ViewBed screen is as shown below.

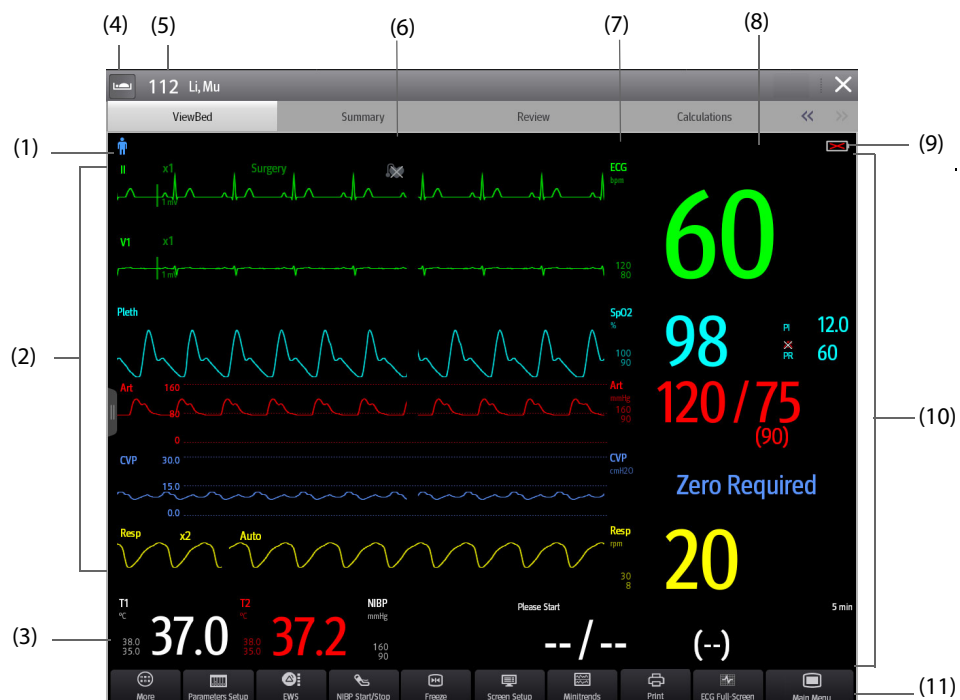

- (1) Patient information area: displays patient category, notes etc. For more information on patient category, see 3.4 *Symbols on the Multibed Screen*.

- (2) Waveform area: displays parameter waveforms. Selecting a waveform enters corresponding parameter menu.
- (3) Parameter numerics/waveform area: displays parameter values and waveforms.
- (4) Patient list symbol: selecting this symbol opens the patient list. For more information on this symbol, see 7.7 *Viewing Other Patients*.
- (5) Patient location information area: displays the bed number, room number and patient name.
- (6) Technical alarm information area: displays the highest priority technical alarm. Selecting this area displays more technical alarm information.
- (7) Physiological alarm information area: displays the highest priority physiological alarm. Selecting this area displays more physiological alarm information.
- (8) Alarm status area: indicates current alarm status. For more information, see Section 3.4 *Symbols on the Multibed Screen*.
- (9) Device status area: displays the battery capacity, network signal strength and privacy mode.
- (10) Parameter area: displays items such as parameter values, alarm limits, alarm status, and parameter list.
  - Selecting a parameter numeric block enters corresponding parameter menu. For more information on the parameters, see the operator's manual of the corresponding device.
  - Selecting the parameter list enters tabular trends review page. For information regarding the parameter list, refer to Section 7.4.2 *Displaying the Parameter List*.
  - When a parameter alarm is turned off, the  symbol is displayed in corresponding parameter area.
  - If the function of outline font for suspected values is enabled in the **System Setup** menu, when unreliable measurement values of HR, SpO<sub>2</sub>, or BIS are detected, these numerics are displayed in outline font.
- (11) Quick key area: displays quick keys to access commonly used functions (keys are configurable).

## NOTE



- **The display layout of the CMS may not match that of a bedside device. But the parameters/ waveforms displayed on the CMS are consistent with that on the bedside device.**
- **If you change the display layout of parameters/waveforms on the bedside device, the display layout of parameters/waveforms on the CMS will not change automatically and vice versa.**
- **When a module of a bedside device is turned off, the waveform and numeric data for this module will be no longer displayed at the CMS.**
- **The ViewBed screen is similar to the main screen of the monitoring device. For more details on the ViewBed screen, see the operator's manual of the corresponding monitoring device.**
- **When a parameter is no longer being monitored, the waveform and numeric data for this parameter will be no longer displayed at the CMS.**

## 7.3 Quick Keys

The ViewBed screen provides quick keys for you to quickly access some functions. The **More** key is permanently located at the left bottom. Selecting the **More** quick key shows more quick keys. The quick keys displayed on the screen are configurable. When a function is not supported by a bedside device, its quick key is inactive.

### 7.3.1 Available Quick Keys

The following table shows available quick keys.

Symbol	Label	Function	Symbol	Label	Function
	More	Show more quick keys		Screen Setup	Enter the <b>Screen Setup</b> menu

Symbol	Label	Function	Symbol	Label	Function
	Minitrends	Enter the Minitrends window		Alarm Setup	Enter the alarm setup menu
	Alarm Pause	Pause the ongoing alarms		Audio Pause	Pause alarm tone
	NIBP Start/Stop	Start an NIBP measurement or stop the ongoing NIBP measurement		Standby	Enter standby mode
	Alarm Reset	Reset the alarm system		Load Config	Enter the <b>Load Config</b> menu
	ECG Full-Screen	Enter the ECG full screen		Freeze	Freeze waveforms
	Print	Start printing a real-time report		Print Setup	Enter the <b>Print Setup</b> menu
	Privacy Mode	Enter privacy mode		Night Mode	Enter night mode
	Record Setup	Enter the <b>Record Setup</b> menu.		Record	Start/Stop a recording.
	Discharge Patient	Enter the <b>Discharge Patient</b> dialog box.		Manual Event	Manually trigger and save an event
	EWS	Enter the <b>EWS</b> window		Main Screen	Return to the multibed screen
	Telemetry Mode	Enter Telemetry Mode		Monitor Mode	Enter Monitor Mode
	Send Message	Send a message to the TM80/TM70		Bedside Devices	Enter bedside devices pairing window
	aEEG	Enter the aEEG screen.		Main Menu	Enter the main menu
	Parameters Setup	Enter the <b>Parameters Setup</b> menu		SepsisSight	Enter the <b>SepsisSight</b> menu

### 7.3.2 Configuring Quick Keys



To configure the desired quick keys displayed on the Viewbed screen, follow this procedure:

1. Access the quick keys setup menu in either of the following ways:
  - ◆ On the ViewBed screen select the **Screen Setup** quick key from the quick key area →select the **Quick Keys** tab.
  - ◆ Select the bed number and room number area in the upper left corner of the desired patient sector on the multibed screen → from the drop-down list select **Screen Setup** → select the **Quick Keys** tab.
  - ◆ On the ViewBed screen, select the **Main Menu** quick key from the quick key area → from the **Display** column select **Quick Keys**.
2. Select the **Current** tab to configure the desired quick keys.
  - ◆ Add a quick key: on the top of **Quick Keys** tab, first select a key which you want to configure for a specific quick key function, next select the quick key function from the list of functions. For example, if you want to show the **Screen Setup** quick key in the first key, select the first key, and then select **Screen Setup** from the function list.
  - ◆ Clear a quick key: select the quick key to be cleared from the quick key and then select **(Blank)** from the function list.
3. Select the **More** tab to configure the quick keys to be displayed when the **More** quick key is selected.

## 7.4 General Operations

### 7.4.1 Changing Tile Layout of the ViewBed Screen

To change tile layout of the ViewBed screen, follow this procedure:

1. Access the tile layout menu in either of the following ways:
  - ◆ On the ViewBed screen, select the **Screen Setup** quick key from the quick key area → select **Tile Layout**.
  - ◆ Select the bed number and room number area in the upper left corner of the desired patient sector on the multibed screen → from the drop-down list select **Screen Setup**→ select the **ViewBed** tab → select **Tile Layout**.
  - ◆ On the ViewBed screen, select the **Main Menu** quick key from the quick key area → from the **Display** column select **Tile Layout**.
2. Select a parameter area or waveform area, and then from the drop-down list select an element you want to display in this area. The selected parameters and waveforms are displayed on the ViewBed screen. The  symbol indicates that this area can be set to display waveforms. Selecting this area changes this symbol to , indicating that this area can be set to display parameters.

#### NOTE

- **The list of parameters/waveforms under the drop-down list in the Tile Layout tab is the super set, not depending on a bedside device. If a parameter/waveform is not supported by the bedside device, it is not displayed on the ViewBed screen.**
- **Changing the ViewBed screen settings affects the ViewBed screen only and does not affect the screen settings for the patient sector.**
- **Changes to the screen settings are only a temporary change. Once a patient is discharged, the screen settings configured will be cleared and the default department configurations will be automatically loaded to the ViewBed screen.**

### 7.4.2 Displaying the Parameter List

You can display trends of HR, SpO<sub>2</sub>, RR, and NIBP/IBP in the parameter numerics area on the ViewBed screen.

To display the parameter list, follow this procedure:

1. Access the tile layout menu in either of the following ways:
  - ◆ On the ViewBed screen, select the **Screen Setup** quick key from the quick key area→ select **Tile Layout**.



- ◆ Select the bed number and room number area in the upper left corner of the desired patient sector on the multibed screen → from the drop-down list select **Screen Setup** → select the **ViewBed** tab → select **Tile Layout**.
  - ◆ On the ViewBed screen, select the **Main Menu** quick key from the quick key area → from the **Display** column select **Tile Layout**.
2. Select a parameter area where you wish to display the parameter list.
  3. From the drop-down list, select **Parameter List**.

### 7.4.3 SpO<sub>2</sub> Statistics

Statistic data of each SpO<sub>2</sub> section within a specific time can be displayed in the SpO<sub>2</sub> statistics area on the ViewBed screen. The target SpO<sub>2</sub> section is displayed in green.

#### 7.4.3.1 Displaying the SpO<sub>2</sub> Statistics Area

To display the SpO<sub>2</sub> statistics area, follow this procedure:

1. Access the tile layout menu in either of the following ways:
  - ◆ On the ViewBed screen, select the **Screen Setup** quick key from the quick key area → select **Tile Layout**.
  - ◆ Select the bed number and room number area in the upper left corner of the desired patient sector on the multibed screen → from the drop-down list select **Screen Setup** → select the **ViewBed** tab → select **Tile Layout**.
  - ◆ On the ViewBed screen, select the **Main Menu** quick key from the quick key area → from the **Display** column select **Tile Layout**.
2. Select a parameter area where you wish to display the SpO<sub>2</sub> statistics area.
3. From the drop-down list, select **SpO<sub>2</sub>**.
4. From the drop-down list, select **SpO<sub>2</sub> Statistics**.

#### 7.4.3.2 Configuring SpO<sub>2</sub> Statistics

To configure SpO<sub>2</sub> statistics, follow this procedure:

1. In the upper right corner of the SpO<sub>2</sub> statistics area, select the time area, i.e. **1 h**.
2. Select the desired option.
3. Access the **SpO<sub>2</sub> Statistics** menu in either of the following ways:
  - ◆ Select the SpO<sub>2</sub> statistics area.
  - ◆ On the ViewBed screen, select the SpO<sub>2</sub> parameter or waveform area → select the **SpO<sub>2</sub> Statistics** tab.
4. In the **From** and **To** columns, select the starting and ending SpO<sub>2</sub> values for each section.
5. In the **Target** column, select the target section.
6. If you wish to use the default values, select **Defaults**.

#### NOTE

- **The values for sections should be continuous. When the section value reaches 100, you cannot configure remaining sections.**

### 7.4.4 Starting/Stopping NIBP Measurement

When the remote control functionality for NIBP measurement is enabled at the CentralStation or the WorkStation, some bedside monitors allow you to remotely to start an NIBP measurement or stop the ongoing measurement. For details on how to select this remote control functionality, see Section 15.13.6 *Setting Authorization*.

Start an NIBP measurement in either of the following ways:

- On the ViewBed screen, select the **NIBP Start/Stop** quick key.

- Select the bed number and room number area in the upper left corner of the desired patient sector on the multibed screen → from the drop-down list select **NIBP Start/Stop**.

In the measurement process, if you wish to stop the proceeding measurement, select **NIBP Start/Stop**.

---

---

## WARNING

---

---

- **Before starting an NIBP measurement, make sure that the patient category on the bedside monitor is correct and the NIBP cuff size is appropriate for this patient.**
- 
- 

### 7.4.5 Freezing/Unfreezing Waveforms

During patient monitoring, you can freeze waveforms on the ViewBed screen to allow a closer review of the waveform data.

#### 7.4.5.1 Freezing Waveforms

To freeze waveforms, follow this procedure:

1. On the ViewBed screen, select the **Freeze** quick key.
2. In the **Freeze** window, select the left or right arrow to move the waveforms backward or forward one second, to display the desired time.

Freezing waveforms does not affect:

- Waveforms displayed in the minitrends window, EWS window and parameter numerics on the ViewBed screen.
- Waveforms displayed on the multibed screen
- Alarm enunciation

#### 7.4.5.2 Unfreezing Waveforms

To unfreeze waveforms, select the  button in the upper right corner of the **Freeze** window.

#### 7.4.5.3 Printing Frozen Waveforms

Selecting the  button in the upper left corner of the **Freeze** window prints frozen waveforms.

### 7.4.6 Loading Configurations

You can load user defaults or factory defaults for the selected telemetry devices.

To load configurations, follow this procedure:

1. Enter the load configuration menu in either of the following ways:
  - ◆ Select the **Load Config** quick key at the bottom of the ViewBed screen to enter the **Load Config** menu. If this quick key is not available, configure it by following steps in [7.3.2 Configuring Quick Keys](#).
  - ◆ Select the **Main Menu** quick key at the bottom of the ViewBed screen → from the **Configuration** column select **Load Config**.
2. In the **Local** tab, select the desired option.
  - ◆ **User Default:** loads the saved user configuration. For details about the configuration items, see [Section 15.11.2 Setting Telemetry Configurations](#).
  - ◆ **Factory Default:** loads factory default configuration.
3. Select the **Load** button.

### 7.4.7 Viewing Device Location

If the AP information has been imported into the CentralStation, you can view device location information for the WiFi devices. For details on how to import AP information, see [Section 15.9.8 Setting the AP Management Tab](#).

To view device location, follow this procedure:

1. Select the  symbol on the ViewBed screen or the patient sector. The **Device Location** menu is displayed.
2. View the AP switch time in the Time column and the current location of devices in the **Location** column.
3. If you wish to locate a telemetry device, select the **Find Device** button. The telemetry device will generate a continuous audible tone until it is acknowledged at the telemetry device.

## 7.4.8 Initiating a Manual Event

You can save a manual event at the CentralStation or WorkStation. To do so, follow this procedure:

1. Select the **Manual Event** quick key to enter the **Manual Event** menu.
2. Select a name for this event, for example **Intubated**, or input a name.
3. Select **OK**. The CMS saves the manual event automatically.

To edit the name of preset event names, select  to enter the **Manual Event Setup** menu.

You can review the manual events. For more information, see *10.9 Events Review Page*.

### NOTE

- **If no manual event menu, make sure that the manual event edit option is enabled. For more information, see 15.13.10 Setting Manual Event Authorization.**

## 7.5 User Screens

To facilitate patient monitoring in different departments and clinical applications, different user screens are provided on the Viewbed screen as follows :

- Normal Screen
- Minitrends
- Integrated Devices
- ECG Full-Screen
- 12-Lead

### NOTE

- **A user screen is provided only when the corresponding monitoring device support this screen.**

### 7.5.1 Minitrends Window

You can split the normal screen so that the left hand side of the screen shows the minitrends window. The Minitrends screen shows the recent graphic trends of parameters.

Choose one of the following methods to enter the Minitrends window:

- On the ViewBed screen, select the **Minitrends** quick key.
- On the ViewBed screen, select the **Screen Setup** quick key →select **Choose Screen** →select **Minitrends**.
- On the ViewBed screen, select the **Main Menu** quick key from the quick key area → from the **Display** column select **Minitrends**.
- Select the  button at the leftmost screen if normal screen is displayed currently.
- Swipe right on the touchscreen with one finger if normal screen is displayed currently.
- For a non-touchscreen, place the mouse at anywhere on the normal screen, and drag the mouse to right while holding the mouse right or left button.

### NOTE

- **For details on the Minitrends window, see the operator's manual of the corresponding devices.**

## 7.5.2 Integrated Devices Window

You can view the information of the external devices that are integrated with the monitor in the integrated devices window.

Choose one of the following methods to enter the Integrated Devices window:

- On the ViewBed screen, select the **Screen Setup** quick key →select **Choose Screen** →select **Integrated Devices**.
- On the ViewBed screen, select the **Main Menu** quick key from the quick key area → from the **Display** column select **Choose Screen** →select **Integrated Devices**.

### NOTE

---

- **For details on the integrated devices window, see the operator's manual of the corresponding devices.**
- 

## 7.5.3 ECG Full-Screen

You can choose ECG Full-Screen when performing 5-lead, 6-lead or 12-lead monitoring. Only ECG waveforms are displayed in the waveform area of the ECG Full-Screen.

Choose one of the following methods to enter the ECG Full-Screen:

- On the ViewBed screen, select the **ECG Full-Screen** quick key.
- On the ViewBed screen, select the **Screen Setup** quick key →select **Choose Screen** →select **ECG Full-Screen**.
- On the ViewBed screen, select the **Main Menu** quick key from the quick key area → from the **Display** column select **Choose Screen** →select **ECG Full-Screen**.

### NOTE

---

- **For details on the ECG full-screen, see the operator's manual of the corresponding devices.**
- 

## 7.5.4 ECG 12-lead Screen

You can choose ECG 12-lead screen when performing 12-lead monitoring. Only 12-lead ECG waveforms are displayed in the waveform area of the ECG 12-lead screen.

Choose one of the following methods to enter the ECG 12-lead screen:

- On the ViewBed screen, select the **12-Lead** quick key.
- On the ViewBed screen, select the **Screen Setup** quick key →select **Choose Screen** →select **12-Lead**.

### NOTE

---

- **For details on the ECG 12-lead screen, see the operator's manual of the corresponding devices.**
- 

## 7.6 Clinical Assistive Applications (CAA)

The Clinical Assistive Applications (CAA) function integrates some commonly used clinical guidelines and tools into the monitor. It puts the currently monitoring parameter measurements together and provides comprehensive analysis results.

CAA is not intended to replace the competent judgment of a clinician. It must be used in conjunction with observation of clinical signs and symptoms.

The following CAA is provided:

- EWS(Early Warning Score)
- SepsisSight

## NOTE

---

- **The system supports the CAA only when the corresponding monitoring device support the CAA.**
- 

### 7.6.1 Early Warning Score (EWS)

The Early Warning Scores (EWS) can help you recognize the early sign of deterioration in patients based on vital signs and clinical observations.

#### 7.6.1.1 Displaying the EWS Parameter Area

To display the EWS parameter area, follow this procedure:

1. Access the tile layout menu in either of the following ways:
  - ◆ On the ViewBed screen, select the **Screen Setup** quick key from the quick key area → select **Tile Layout**.
  - ◆ Select the bed number and room number area in the upper left corner of the desired patient sector on the multibed screen → from the drop-down list select **Screen Setup** → select the **ViewBed** tab → select **Tile Layout**.
  - ◆ On the ViewBed screen, select the **Main Menu** quick key from the quick key area → from the **Display** column select **Tile Layout**.
2. Select a parameter area where you wish to display EWS scores.
3. From the drop-down list, select **EWS**.

## NOTE

---

- **For details on the EWS, see the operator's manual of the CMS.**
  - **The EWS parameter area can be also displayed in a patient sector on the multibed screen. For how to display EWS parameter area, see Section 7.4.1 Changing Tile Layout of the ViewBed Screen.**
- 

#### 7.6.1.2 Entering the EWS Window

Choose one of the following methods to enter the EWS window:

- On the ViewBed screen, select the EWS parameter area.
- On the ViewBed screen, select the **EWS** quick key.
- On the ViewBed screen, select the **Screen Setup** quick key → select **Choose Screen** → select **EWS**.
- On the ViewBed screen, select the **Main Menu** quick key from the quick key area → from the **CAA** column select **EWS**.

### 7.6.2 SepsisSight™

The SepsisSight™ function is based on Third International Consensus Definitions for Sepsis and Septic Shock (Sepsis-3) and Surviving Sepsis Campaign: International Guidelines for Management of Sepsis and Septic Shock: 2016 (SSC Guidelines 2012 and 2016)..

SepsisSight™ is intended for adult patients suffering from sepsis or suspicious of sepsis.

Choose one of the following methods to enter the SepsisSight menu:

- On the ViewBed screen, select the **SepsisSight** quick key.
- On the ViewBed screen, select the **Main Menu** quick key from the quick key area → from the **CAA** column select **SepsisSight**.

You can set the goal for first resuscitation and bundles treatments for the patient in the **SepsisSight** menu. For details, see 15.12.3 Setting SepsisSight.

## NOTE

---

- **SepsisSight is not a tool for Sepsis diagnosis and treatment. It cannot replace the physician's judgment.**
  - **For details on the SepsisSight screen, see the operator's manual of the corresponding devices.**
- 

## 7.7 Viewing Other Patients

You can switch to view other patients in the same department or in a different department on the ViewBed screen. Follow this procedure to do so:

1. Access the ViewBed screen in either of the following ways:
  - Select the parameter area or waveform area in the desired patient sector on the multibed screen.
  - Select the ViewBed symbol  when it is displayed in the desired patient sector on the multibed screen.
2. Select the patient list icon.
3. Select  and select the department of the desired patient.
4. Select the desired patient.

# 8 Alarms

---

## 8.1 Alarm Introduction

This chapter describes alarm functions and alarm settings.

## 8.2 Understanding the Alarms

Alarms triggered by a vital sign that appears abnormally or due to technical problems identified by the bedside devices are sent to the CMS. The CMS provides visual and audible alarm indications.

Most of the alarms come from bedside devices. For alarms detected by the CMS, see *Appendix B CMS Alarm Messages*.

### 8.2.1 Alarm Categories

The CMS' alarms can be classified into two categories: physiological alarms and technical alarms.

- Physiological alarms, also called patient status alarms, are triggered by a monitored parameter value that violates set alarm limits or an abnormal patient condition. Physiological alarm messages are displayed in the physiological alarm area.
- Technical alarms, also called system status alarms, are triggered by a device malfunction or a patient data distortion due to improper operation or mechanical problems. Technical alarm messages are displayed in the technical alarm area.

Apart from the physiological and technical alarm messages, the CMS will show some messages telling the system status.

### 8.2.2 Alarm Priorities

By severity, the alarms are classified into the following priority levels:

- High priority alarms: indicate a life threatening situation or a severe device malfunction. High priority alarms require an immediate response.
- Medium priority alarms: indicate abnormal vital signs or a device malfunction. Medium priority alarms require a prompt response.
- Low priority alarms: indicate a discomfort condition, a device malfunction, or an improper operation. Low priority alarms require you to be aware of this condition.
- Prompts: provide additional information on the patient or the system status.

## 8.2.3 Alarm Indicators

When an alarm occurs, the CMS gives different visual or audible alarm indications as shown below.





Alarm Indicator		High Priority Alarm	Medium Priority Alarm	Low Priority Alarm	Prompt
Audible tone pattern	Special alarm sound	Repeat pattern of high-pitched single beep	None	None	None
	ISO	Repeat pattern of triple + double + triple + double beeps	Repeat pattern of triple beeps	Repeat pattern of single beep	None
	ISO2	Repeat pattern of triple + double + triple + double beeps	Repeat pattern of triple beeps	Repeat pattern of single beep	None
Alarm message		White text inside a red box	Black text inside a yellow box	Black text inside a cyan box	White text
Alarm priority indicator		!!!	!!	!	None
Parameter value		Black text inside a flashing red box	Black text inside a flashing yellow box	Black text inside a flashing cyan box	None

### NOTE

- **Alarm time is displayed for latched physiological alarms only.**
- **The audible and visual alarms given by the CMS comply with the IEC 60601-1-8 standard. The hospital or institution employing the use of the CMS should give adequate training to the operators.**
- **When multiple alarms of different priority levels occur simultaneously, the CMS selects the alarms of the highest priorities and provides alarm tones accordingly.**
- **When multiple alarms of the same priority levels occur simultaneously and are displayed in the same area, all the alarm messages will be scrolled in the display area.**
- **After the CMS alarm system is reset, if an alarm still exists and a new lower-priority alarm occurs, the CMS has lower-priority alarm tone and higher-priority alarm message.**
- **Some physiological alarms, such as asystole, are exclusive. They have identical alarm tones with normal high level physiological alarms, but their alarm messages are displayed exclusively. That is to say, when an exclusive physiological alarm and a normal high level physiological alarm are triggered simultaneously, only the alarm message of the exclusive physiological alarm is displayed.**
- **The pattern of the alarm tone is different from those of the alarm volume adjustment tone, event tone, self-test tone and nurse call tone so that the alarm tone can be distinguished from other tones.**

## 8.2.4 Alarm Status Symbols

Apart from the alarm indicators as described in 8.2.3 *Alarm Indicators*, the following symbols are displayed on the screen to indicate current alarm status of bedside devices:

- : the alarm pause symbol, indicating that all the alarms are paused.
- : the alarm off symbol, indicating that individual measurement alarms are turned off or the system is in the alarm off status.
- : the audio pause symbol, indicating that audible alarm are paused.
- : the audio off symbol, indicating that audible alarm are turned off.
- : the alarm reset symbol, indicating that the alarm system is reset.



## 8.2.5 Highlighted Display of Alarm Messages

When some alarms are triggered, alarm messages are highlighted to indicate that the patient may be in a critical condition.

On the ViewBed screen, when an alarm is highlighted, the alarm message covers both the original physiological alarm area and the technical alarm area with enlarged word size. Messages of technical alarms and other physiological alarms are displayed at the left of the highlighted alarm.

On the patient sector, when an alarm is highlighted, when an alarm is highlighted, the alarm message covers both the original physiological alarm area and the technical alarm area with enlarged word size. The background red box expands to the bed number and room number area.

Alarm messages of the following alarms can be highlighted:

- Lethal arrhythmia alarms, including Asystole, V-Fib/V-Tach, V-Tach, Vent Brady, Extreme Tachy, and Extreme Brady.
- SpO2 Desat
- Apnea
- HR>XX with arterial pressure-S<XX and RR>XX over YY min, in which "XX" represents parameter value and "YY" represents alarm duration.

## 8.3 Viewing Alarms

You can view physiological and technical alarms from all beds or a single bed and CMS's technical alarms.

### 8.3.1 Viewing All Alarms

You can view alarms from all the monitoring beds and from the CMS itself during a recent time period.

To do so, follow this procedure:

1. Select the  alarm list area at the top of the main screen.
2. Select the time period in the upper right corner of the **Alarm List** screen.
3. Select the **Physiological Alarms** or **Technical Alarms** tab to view physiological alarms or technical alarms.
4. Select the **Detail** button on the right side of the desired physiological alarms to access the event review page and view the alarm details.

### 8.3.2 Viewing Alarms Triggered from A Single Bed

To view alarms from a single bed, follow this procedure:

1. Open the alarm list window for a bedside device in either of the following ways:
  - ◆ Select the alarm information area in the patient sector of this bedside device on the multibed screen.
  - ◆ Select the physiological or technical alarm information area on the ViewBed screen of this bedside device.
2. Select the desired alarm message to access the event review page and view the alarm details.

## 8.4 iStatus Window

The *iStatus* window ( *iStatus*) displays the current physiological alarms, alarmed systems or organs, and parameter trends over the last one hour.

When corresponding alarms are triggered, the *iStatus* window pops up synchronously on the monitor and on the ViewBed screen of the CMS.



For details on the *iStatus* window, see the operator's manual of the corresponding devices.

### NOTE

- 
- **Only displays of 1920X 1080 or above resolution support the Patient Status function.**
-

## 8.5 Clearing Alarms in the Alarm List

To clear physiological or technical alarms in the alarm list, follow this procedure:

1. Select the  alarm list area at the top of the main screen.
2. Select the  symbol in the upper right corner of the **Alarm List** screen. This clears all the physiological and technical alarms.

### NOTE

- Selecting the  symbol only clears all the physiological and technical alarms in the alarm list window, but does not clear these alarms stored in the central monitoring system.

## 8.6 Setting Alarm Properties

### 8.6.1 Setting Parameter Alarm Properties

You can set alarm properties for parameters collectively or individually.

#### 8.6.1.1 Setting Parameter Alarm Properties Collectively

To set alarm properties for all the parameters collectively, follow this procedure:

1. Enter the alarm limits menu in either of the following ways:
  - ◆ Select the bed number and room number area in the upper left corner of the desired patient sector on the multibed screen → from the drop-down list select **Alarm Setup** → select the **Limits** tab.
  - ◆ Select the **Alarm Setup** quick key at the bottom of the ViewBed screen → select the **Limits** tab.
  - ◆ On the ViewBed screen, select the **Main Menu** quick key from the quick key area → from the **Alarm** column select **Limits**.
2. Select the **Limits** tab. Switch on or off alarms and set alarm limits, alarm priority, and alarm outputs.
  - ◆ If **Alarm Outputs** is set to **Off**: when an alarm is triggered, alarm information for this parameter will not be printed.
  - ◆ If **Alarm Outputs** is set to **Paging** (optional): when the parameter alarm is switched on, once an alarm is triggered, alarm information for this parameter will be sent to a configured paging device.
  - ◆ If **Alarm Outputs** is set to **Print**: when the parameter alarm is switched on, once an alarm is triggered, alarm information for this parameter will be sent to the configured printer and printed automatically. For details on how to configure the waveform printing duration, see Section 15.4.4 *Configuring Other Alarm-Related Items*.
  - ◆ When **Alarm Outputs** is set to **All**: when the parameter alarm is switched on, once an alarm is triggered, alarm information for this parameter will be sent to the configured paging device and printer and printed automatically. For details on how to configure the waveform printing duration, see Section 15.4.4 *Configuring Other Alarm-Related Items*.

### CAUTION

- When changing the alarm limits of a bedside device via the CentralStation or the WorkStation, make sure that the alarm limits settings are appropriate for your patient. Setting alarm limits to extreme values may cause the alarm system to become ineffective.

### NOTE

- When **Alarm Setup** is selected on the authorization setup page, alarm settings can be changed either via the CentralStation/WorkStation or the bedside device. Alarm changes made will be synchronized to all locations to ensure consistency. For detailed information on the authorization setup page, see Section 15.13.6 *Setting Authorization*.
- Alarm settings can only be viewed at the ViewStation. But they cannot be modified.

- **When Alarm Setup is not selected on the authorization setup page, alarm settings cannot be changed via the CentralStation/WorkStation. Besides, the  symbol is displayed beside a parameter's alarm on/off option on the ViewBed screen.**
- 

### 8.6.1.2 Setting Parameter Alarm Properties Individually

To set alarm properties for a parameter, follow this procedure:

1. Access the ViewBed screen in either of the following ways:
  - ◆ Select the parameter area or waveform area in the desired patient sector on the multibed screen to access the ViewBed screen.
  - ◆ Select the ViewBed symbol  when it is displayed in the desired patient sector on the multibed screen.
2. Select the parameter area or waveform area of the desired parameter.
3. Select the **Alarm** tab and perform settings.

## 8.6.2 Changing Arrhythmia Alarm Settings

To change arrhythmia alarm settings, follow this procedure:

1. Enter the arrhythmia alarm setup menu in one of the following ways:
  - ◆ Select the bed number and room number area in the upper left corner of the desired patient sector on the multibed screen → from the drop-down list select **Alarm Setup** → select the **Arrhythmia** tab.
  - ◆ Select the **Alarm Setup** quick key at the bottom of the ViewBed screen → select the **Arrhythmia** tab.
  - ◆ Select the ECG parameter area or waveform area on the ViewBed screen to enter the ECG setup menu → select the **Arrhythmia** tab.
  - ◆ On the ViewBed screen, select the **Main Menu** quick key from the quick key area → from the **Alarm** column select **Arrhythmia**.
2. Change alarm settings
  - ◆ Enable or disable arrhythmia alarms: you can enable arrhythmia alarms separately or collectively. If you need to enable these alarms collectively, select **All On**. If you need to disable all the arrhythmia alarms, select **All Off**. If you need to enable only the lethal arrhythmia alarms, select **Lethals Only**.
  - ◆ Set alarm priorities.
  - ◆ Set **Alarm Outputs**. For details on the options, see Section 8.6.1.1 *Setting Parameter Alarm Properties Collectively*.
3. Select the **Threshold** tab and adjust as needed.

### NOTE

- **If a bedside monitor is connected and the Lethal Arrhy Off option in the monitor's user maintenance menu is set to Disable, the All Off button in the arrhythmia alarm setup menu in the CMS is inactive.**
  - **If a telemetry device is connected and the Lethal Arrhy Alarms Off button on the telemetry setup page is disabled, the All Off button in the arrhythmia alarm setup menu in the CMS is inactive.**
  - **For information on the arrhythmia alarm settings and threshold settings, see operator's manuals for bedside devices.**
- 

## 8.6.3 Changing ST Alarm Settings

To change ST alarm settings, follow this procedure:

1. Enter the ST alarm setup menu in one of the following ways:
  - ◆ Select the bed number and room number area in the upper left corner of the desired patient sector on the multibed screen → from the drop-down list select **Alarm Setup** → select the **ST** tab.
  - ◆ Select the **Alarm Setup** quick key at the bottom of the ViewBed screen → select the **ST** tab.
  - ◆ Select the ECG parameter area or waveform area to enter the ECG setup menu → select the **ST** tab.
  - ◆ On the ViewBed screen, select the **Main Menu** quick key from the quick key area → from the **Alarm** column select **ST**.

2. Change alarm settings.

## 8.6.4 Setting Alarm Volume

To set the alarm volume, follow this procedure:

1. Select the system menu area in the upper left corner of the screen→ from the drop-down list select **System Setup** to access the **System Setup** menu.
2. Select the **General** tab to access the general setup page.
3. Select the **Volume** tab.
4. Set **Alarm Volume**. The optional alarm volume is between X to 10, in which X is the minimum volume, depending on the setting of minimum alarm volume, and 10 is the maximum volume. For more information, see Section 8.6.6 *Setting Alarm Interval, Alarm Volume Escalation, and Audio Off Priority*.
5. Set **High Alarm Volume**. The volume of the high priority alarm is higher than any other alarm volume. The volume of the high priority alarm is 10 even if it is set above 10.
6. Set **Reminder Volume**.

### NOTE

- **Do not rely exclusively on the audible alarm system. Setting the alarm volume to a low level may result in a hazard to the patient.**

## 8.6.5 Setting the Audible Alarm Tone Pattern

You can select audible alarm tone pattern for the CMS in the System Setup menu. For details, see 15.4.2 *Configuring Alarm Audio Properties*.

## 8.6.6 Setting Alarm Interval, Alarm Volume Escalation, and Audio Off Priority

The CMS provides the function of automatically escalating the alarm tone volume. When this function is enabled, if an alarm is not reset within the designated delay time after the alarm occurs, the volume of the alarm tone increases automatically.

You can set the alarm volume escalation, alarm interval, and audio off priority. For more information, see Section 15.4.2 *Configuring Alarm Audio Properties*.

## 8.6.7 Setting Alarm Sound for a Single Bed

When **Single Bed Alarm Audio Off** is set to **Enable** in the system setup menu, you can turn on or off alarm sound for a single bed. For information on system settings, see Section 15.4.2 *Configuring Alarm Audio Properties*.

## 8.6.8 Setting Reminder Tones

The reminder tone is enabled by default. When the CMS is in silenced or audio off mode and if active alarms still exist in the system, the CMS issues a reminder tone at the designated reminder interval. For details on how to set alarm reminder, see Section 15.4.2 *Configuring Alarm Audio Properties*.

## 8.6.9 Setting Special Alarm Sound

You can configure the CMS to give special alarm sound to indicate that the patient may be in a critical condition when any of the following alarms are triggered:

- Lethal arrhythmias, including Asystole, V-Fib/V-Tach, V-Tach, Vent Brady, Extreme Tachy, and Extreme Brady
- SpO2 Desat
- Apnea

For details on how to set special alarm sound, see Section 15.4.2 *Configuring Alarm Audio Properties*.

## 8.6.10 Modifying Combined Alarm Settings

When a monitor supports combined alarm function, you can modify its combined alarms settings on the CentralStation or WorkStation. The changes on the CentralStation or WorkStation will synchronize to the monitor. The following combined alarm settings are supported:

- parameter alarm threshold
- alarm on/off
- alarm priority
- alarm output on/off

To modify the combined alarm settings, follow this procedure:

1. Enter the alarm setup menu in either of the following ways:
  - ◆ Select the bed number and room number area in the upper left corner of the desired patient sector on the multibed screen → from the drop-down list select **Alarm Setup**.
  - ◆ Select the **Alarm Setup** quick key at the bottom of the ViewBed screen. If this quick key is not available, configure it by following steps in 7.3.2 *Configuring Quick Keys*.
2. Select **Combined Alarm** tab.
3. Modify the desired settings.

## 8.6.11 Setting Alarm Latching

The latching setting for physiological alarms defines how alarm indicators behave if you do not reset the alarms. For details on how to reset alarms, see Section 8.9.1 *Resetting Alarms Triggered for Beds*.

- If you do not “latch” physiological alarms, their alarm indications disappear when the alarm condition ends.
- If you “latch” physiological alarms, all visual and audible alarm indications remains until you reset the alarms. For latched alarms the time when the alarm is last triggered is displayed behind the alarm message.

You can only set the physiological alarm latching conditions for telemetry devices at the CentralStation. For details, see Section 15.8.2 *Setting Alarm Properties for Telemetry Devices*.

### NOTE

- **When the alarm system is reset, latched physiological alarms are cleared. For details on how to reset alarms, see Section 8.9 Alarm Reset.**

## 8.6.12 Setting Alarm Properties for External Devices

You can set the alarm properties for external devices that are integrated with the monitor at the CentralStation/ WorkStation. These settings take effect for the CentralStation/WorkStation only. They do not affect settings in the remote patient monitor.

To set alarm properties, follow this procedure:

1. Access the integrated device screen in either of the following ways:
  - ◆ On the ViewBed screen, select the **Screen Setup** quick key from the quick key area →select **Integrated Devices**.
  - ◆ On the multibed screen, select the bed number and room number area in the upper left corner of the desired patient sector →from the drop-down list select **Screen Setup** → select the **ViewBed** tab→select **Integrated Devices**.
2. Select the **Setup** button. The **Setup** menu is displayed.
3. Set alarm properties.
  - ◆ Set whether to store and display alarms and whether to issue alarm sounds in the **Storage, Display, and Audio** columns.
  - ◆ If you wish to add a new alarm, enter its alarm ID on the text box besides the **Add** button. Then select the **Add** button. For the list of alarm IDs, see *BeneLink Module Operator's Manual*.
  - ◆ If you wish to add a new alarm, enter its alarm ID on the text box besides the **Add** button. Then select the **Add** button. For the list of alarm IDs, see *BeneLink Module Operator's Manual*.

- ◆ If you wish to delete an alarm, select the  symbol. Then select the **Delete** button. The default alarms cannot be deleted.

## NOTE

---

- **Settings in the Display and Audio columns at the CentralStation take effect for the CentralStation only and does not affect settings at the WorkStation, and vice versa.**
  - **If alarms in the Display or Audio column is disabled, when these alarms occur, corresponding alarm messages or alarm sound will not be displayed or enunciated at the CentralStation or the WorkStation. In this case, pay close attention to alarms issued at the bedside devices.**
- 

## 8.7 Alarm Pause

You can pause alarms from bedside devices remotely via the CentralStation or the WorkStation under the following conditions:

- The bedside devices support alarm pause via the devices themselves and via the CentralStation or the WorkStation.
- The **Alarm Paused & Alarm Reset** function is enabled at the CentralStation or the WorkStation. For details on how to enable this function, see Section 15.13.6 *Setting Authorization*.

You can also pause alarms from telemetry devices at the CentralStation or the WorkStation.

### 8.7.1 Pausing Alarms

You have two ways to pause alarms.

#### 8.7.1.1 Pausing Alarms in the Patient Sector

To pause alarms, follow this procedure:

1. Select the bed number and room number area in the upper left corner of the desired patient sector on the multibed screen.
2. From the drop-down list, select the  symbol.

#### 8.7.1.2 Pausing Alarms on the ViewBed Screen

To pause alarms, follow this procedure:

1. Access the ViewBed screen in either of the following ways:
  - ◆ Select the parameter area or waveform area in the desired patient sector on the multibed screen to access the ViewBed screen.
  - ◆ Select the ViewBed symbol  when it is displayed in the desired patient sector on the multibed screen.
2. Select the **Alarm Pause** quick key at the bottom of the screen. If this quick key is not available, configure it by following steps in 7.3.2 *Configuring Quick Keys*.

The alarm pause time for bedside devices needs to be configured on the devices. The default alarm pause time for telemetry devices is two minutes. The alarm pause time for telemetry devices is configurable. For details, see Section 15.8.2 *Setting Alarm Properties for Telemetry Devices*.

When the alarm pause time expires, the alarm paused status is automatically deactivated. You can also cancel the alarm paused status by selecting the **Alarm Pause** quick key.

### 8.7.2 System Responses after Pausing Alarms

When alarms are paused, the CentralStation or the WorkStation responds as follows:

- No physiological alarm issued by bedside devices will be presented.
- For technical alarms issued by bedside devices, alarm sounds are paused, but alarm messages remain presented.

- The  symbol, **Alarm Pause** text, and alarm pause countdown time are displayed in the patient sector and ViewBed screen. The background color of the **Alarm Pause** quick key remains red within the alarm pause time.

## 8.8 Alarm Audio Pause

You can pause the alarm sound issued by the monitoring devices remotely via the CentralStation or the WorkStation under the following conditions:

- The alarm pause function is defined as the alarm audio pause at the monitoring devices side. For details on how to define the alarm audio pause function, see the operator's manual for the monitoring devices.
- The **Alarm Pause&Audio Pause&Alarm Reset** function is enabled at the CentralStation or the WorkStation. For details on how to enable this function, see .

### 8.8.1 Pausing Alarm Sound

To pause the alarm sound, follow this procedure:

1. Access the ViewBed screen in either of the following ways:
  - ◆ Select the parameter area or waveform area in the desired patient sector on the multibed screen to access the ViewBed screen.
  - ◆ Select the ViewBed symbol  when it is displayed in the desired patient sector on the multibed screen.
2. Select the **Audio Pause** quick key at the bottom of the screen.

The audio pause time of ePM series and BeneVision N series patient monitors needs to be configured on the monitors. When the audio pause time expires, the audio paused status is automatically deactivated. You can also cancel the audio paused status by pressing the **Audio Pause** quick key.

### 8.8.2 System Responses after Pausing Alarm Sound

When alarm sound is paused, the CentralStation or the WorkStation responds as follows:

- The sound of all physiological alarms and technical alarms for the bedside device are switched off but alarm messages are still displayed on the screen.
- The  symbol is displayed in the patient sector and on the ViewBed screen. The background color of the **Audio Pause** quick key remains red within the audio pause time.

## 8.9 Alarm Reset

You can reset alarms from bedside devices remotely via the CentralStation or the WorkStation under the following conditions:

- The bedside devices support alarm reset via the devices themselves and via the CentralStation or the WorkStation.
- The **Alarm Pause&Audio Pause&Alarm Reset** function is enabled at the CentralStation or the WorkStation. For details on how to enable this function, see *15.13.6 Setting Authorization*.

You can reset alarms from telemetry devices at the CentralStation or the WorkStation. You can also reset system alarms in the system alarm area at the top of the screen.



### 8.9.1 Resetting Alarms Triggered for Beds

You have two ways to reset alarms triggered for beds.

#### 8.9.1.1 Resetting Alarms in the Patient Sector

Choose one of the following ways to reset alarms in the patient sector:

- Select the alarm information area in the desired patient sector on the multibed screen → select **Alarm Reset**.
- Select the Alarm Reset button in the desired patient sector on the multibed screen.

- Select the bed number and room number area  in the upper left corner of the desired patient sector on the multibed screen → from the drop-down list select the  symbol.

### 8.9.1.2 Resetting Alarms on the ViewBed Screen

To reset alarms on the ViewBed screen, follow this procedure:

1. Access the ViewBed screen in either of the following ways:
  - ◆ Select the parameter area or waveform area in the desired patient sector on the multibed screen to access the ViewBed screen.
  - ◆ Select the ViewBed symbol  when it is displayed in the desired patient sector on the multibed screen.
2. Select the **Alarm Reset** quick key at the bottom of the screen. If this quick key is not available, configure it by following steps in *7.3.2 Configuring Quick Keys*.

### 8.9.1.3 System Responses after Resetting Alarms

When physiological alarms are reset, the following alarm indications are given:

- The alarm sound is silenced.
- The  symbol appears before the alarm message.
- The color of the parameter numeric background corresponds with the alarm priority, but the parameter numeric does not flash.

When technical alarms are reset, the following alarm indications are given:

- Some technical alarms are cleared and no alarm indications are given.
- Some technical alarms are changed to the prompt messages.
- For some technical alarms, the alarm is silenced and a  symbol appears before the alarm message.

For details on technical alarms, see appropriate operator's manuals for bedside devices.

#### NOTE

- **If a new alarm is triggered after the alarm system is reset, the alarm reset symbol will disappear and visual and audible alarm indications will be reactivated.**

## 8.9.2 Resetting System Alarms

To reset system alarms, follow this procedure:

1. Select the system alarm area at the top of the screen. For information on the system alarm area, see Section *6.1 Example Multibed Screen*.
2. Select **Alarm Reset**.

When system alarms are reset, the following alarm indications are given:

- Some technical alarms are cleared and no alarm indications are given.
- Some technical alarms are changed to the prompt messages.
- For some technical alarms, the alarm is silenced and a  symbol appears before the alarm message.

## 8.10 CMS System Silence

The CMS system sounds include alarm tone, nurse call tone, event sound tone, and other tones. Silencing the CMS only silences the CMS system sounds. It does not affect the alarm sounds at bedside devices. The CMS system silence feature is disabled by default.

### 8.10.1 Silencing CMS

Silence the CMS in either of the following ways:



- If the silence hot key is defined in the system setup screen, pressing this hot key silences the system sounds. For details on how to define the silence hot key, see Section 15.4.4 *Configuring Other Alarm-Related Items*.
- Select the  symbol at the top of the screen.

### 8.10.2 System Responses after Silencing CMS

When the system sounds are silenced, the following indications are given:

- The  symbol is displayed at the top of the main screen.
- Audible alarm indications are not given, but other alarm indications, such as alarm messages, remain being presented.

### 8.10.3 Exiting CMS Silenced Status

When a new alarm occurs, the system silenced status will be automatically released. You can also press the silence hot key again or select the  symbol to exit the system silenced status.

**This page intentionally left blank.**

# 9 Summary

---

You can view summary data for online patients on the summary screen. The summary screen provides several tabs to display summary data from different aspects.

## NOTE



- **The summary function is intended for online patients. It is not intended for discharged patients.**
- **Data displayed on the summary screen is not recalculated.**
- **A license is required for ECG summary.**
- **To avoid confusion, waveforms of alarm events without typical alarm characteristics are excluded in the typical ECG strips.**
- **To avoid confusion, the following parameter values are excluded in the graphic trends: 1) invalid parameter values 2) parameter values that are calculated on the basis of physiological signal segments with obvious noise.**

## 9.1 Accessing the Summary Screen

To enter the summary screen, select the **Summary** tab beside the ViewBed screen and the review screen.

## 9.2 Symbols on Summary Pages

The following table lists the symbols on summary pages.

Symbol	Description
	Setup button: select it to set up parameters.
	Print button: select it to output patient information and data through the printer.

## 9.3 Common Operations on Summary Pages

This section describes common operations on summary pages.

### 9.3.1 Setting the Summary Statistical Duration

On the summary page, select **Zoom** to set summary statistical duration and the corresponding statistical duration displays.

### 9.3.2 Printing the Summary Report

On the summary pages, select the print button to print corresponding summary reports.

## 9.4 Vital Sign Summary

The vital sign summary provides the parameter trend of the patient's vital sign and the alarm events statistics.

### 9.4.1 Entering the Vital Sign Summary Page

To enter the vital sign summary page, select the ▼ button in the upper left corner of the summary screen → from the drop-down list, select **Vital Sign Summary**.

## 9.4.2 The Display of Vital Sign Summary

The following figure is an example of the Vital Sign Summary page:



- (1) Graphic trends: show the trends of mean parameter value or maximum/minimum parameter value. Up arrow and down arrow indicate the maximum and minimum parameter value in the statistical duration respectively.
- (2) GCS score indicator area: indicates the time, total score and subscores of all the GCS. No indicator displays if no GCS score is performed in the statistical duration.
- (3)
  - For adults and pediatrics, this area shows alarm statistics.
  - For neonates, this area shows alarm statistics, SpO<sub>2</sub> statistics.

An up arrow indicates a increase in the current statistical duration compared to the previous one, while a down arrow indicates a decrease.

## 9.4.3 Setting Trend Parameters for the Vital Sign Summary

Select the setup button to set trend parameters to be displayed in the summary. One trend parameter one row. When parameters are overlapped, all the overlapped parameters are displayed in one row. A maximum of ten rows of parameters are displayed on the graphic trend area.

## 9.4.4 Setting the Trend Type for the Vital Sign Summary

Select **Trends** to set whether the trend of maximum/minimum values or the trend of mean values is displayed.

## 9.4.5 Viewing the Parameter Value at a Specific Time

In the graphic trends area, selecting any spot displays a cursor on the page and you can view the corresponding time and the parameter values of this specific time.

## 9.4.6 Accessing the Corresponding Review

You can access the corresponding review from the vital sign summary page:

- Selecting the area of the alarm statistics can access the events review.
- Selecting **Full Disclosure** can access the full disclosure review.

## 9.5 ECG Summary

The ECG Summary provides ECG statistics of the patient. It also displays the patient's typical ECG strips.

### NOTE

- **Pacer statistics is intended for paced patients. Pacer statistics is available only when the Paced setting is Yes.**
- **ST statistics is available only when ST analysis is switched on.**
- **QT statistics is available only when QT analysis is switched on.**

### 9.5.1 Entering the ECG Summary Page

To enter the ECG summary page, select the  button in the upper left corner of the summary screen → from the drop-down list, select **ECG Summary**.

### 9.5.2 The Display of ECG Summary

The following figure is an example of the ECG Summary page:

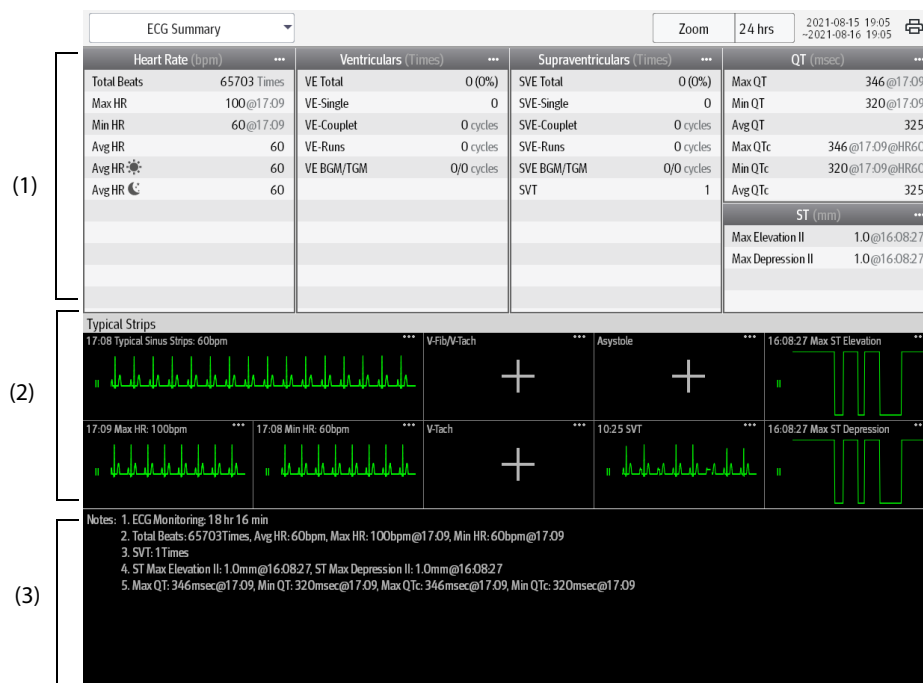

- (1) ECG statistics, including the following items:
  - Statistics of heart rates
  - Statistics of ventricular beats and ventricular arrhythmia events
  - Statistics of supraventricular beats and supraventricular arrhythmia events
  - Statistics of QT/QTc measurements
  - Statistics of maximum ST elevations and depressions
  - Statistics of pace
- (2) Typical ECG strips
- (3) Notes: include additional information on the ECG summary

### 9.5.3 Selecting Typical ECG Strips

Taking V-Tach as an example, to select typical V-Tach waveform, select the currently displayed V-Tach waveform, from the popup list select the desired waveform as typical V-Tach waveform.

If no V-Tach occurs to the patient in the statistical duration, an add symbol  is displayed in the V-Tach area. You can select the add symbol to display a typical ECG waveform of other arrhythmia event in this area.

#### **9.5.4 Reviewing the ECG Summary**

Selecting any of the statistic area can access corresponding trends and events review. For more information, see *10 Review*.

#### **9.5.5 Setting the Night Time for Average HR Statistic**

You can set the night time for average heart rate statistics, and the rest of the 24 hours is the daytime for average heart rate statistics. For more information on how to set the night time, see *15.13.5.2 Defining the Night Time*.

# 10 Review

---

## 10.1 Overview

You can review historical data for online patients and discharged patients on the review screen. The review screen provides several tabs to display historical data from different aspects. The review tabs for the online patients and discharged patients are the same.

### NOTE

- **Review tabs are dependent on the patient category and patient sector settings. For details on how to select the review tabs in the patient sector, see Section 15.3.5 Setting Patient Window.**
- 

## 10.2 Accessing the Review Screen

Methods for accessing the review screen for online patients and discharged patients are different.

### 10.2.1 Entering the Review Screen for Online Patients

To enter the review screen for online patients, select the **Review** tab beside the ViewBed screen, the patient management screen, or the calculation screen.

### 10.2.2 Entering the Review Screen for Discharged Patients





To enter the review screen for discharged patients, follow this procedure:

1. Select the system menu area in the upper left corner of the screen.
2. From the drop-down list, select **Discharged Patients**.
3. From the discharged patients list, select the **Detail** button at the end of the discharged patient.
4. Select the **Review** tab.

## 10.3 Example Review Page Structure

Select the ▼ button in the upper left corner of the review screen to enter appropriate review pages. The graphic trends review page is an example to introduce the items that may also be displayed on other review pages. The following shows an example of the graphic trends page:











(1)	Current review tab
(2)	Event type indicator: different color blocks match different types of events: <ul style="list-style-type: none"> <li>■ Red: high priority alarm event</li> <li>■ Yellow: medium priority alarm event</li> <li>■ Cyan: low priority alarm event</li> <li>■ Green: manual event</li> <li>■ White: operation-related event</li> </ul>
(3)	Waveform area: displays trend curves. The color of trend curves is consistent with the color of parameter labels.
(4)	Event area/current cursor time area: after you select an event from the event list, this event is displayed in this area. Selecting this area goes to the <b>Events</b> review page. If an event is not selected, this area displays current cursor time.
(5)	Scroll bar: indicates the position of currently displayed trend data in all the trend data.
(6)	Cursor: shows your current position in the trend page. When the cursor is moved across the timeline, the values measured at the cursor time are shown in the right column.
(7)	Parameter area: displays numeric values where the cursor stops. The color of numeric values is consistent with the color of parameter labels. The background color of numeric values matches the alarm priority.
(8)	Timeline: indicates the entire time length. <ul style="list-style-type: none"> <li>■ : indicates the time length of reviewable trend data.  can be moved within this time length.</li> <li>■ : indicates no patient monitoring.  cannot be moved within this time length.</li> <li>■ Different color blocks at the timeline indicate events of different types. See the color definition for the event type indicator.</li> </ul>



## 10.4 Symbols on Review Pages

The following table lists the symbols on review pages.

Symbol	Description
	Slider: indicates the position of current window time in the entire time length. Dragging the slider left or right enables you to locate the trend data at a specific time and also refreshes trend data in current window accordingly.
	Go to the previous or next event.
	Event list: displays events in a chronological order. The most recent event is displayed at the top. The number of exclamation marks before an event matches different alarm priorities.
	Patients' trend data or waveform data export setup symbol: it is displayed on the tabular trends review page, graphic trends review page, and full disclosure review page. Note: the export setup symbol is displayed only when <b>Save As</b> is enabled in the system menu. For more information on enabling <b>Save As</b> , see Section 15.7.6 <i>Setting Patient Data Export</i> .
	This symbol is displayed in the upper right corner of a review page for a landscape display greater than 19-inch. Selecting this symbol displays two review pages simultaneously.
	Print button: select it to output patient information and data through the printer.
	Record button: select it to output patient information and data through the recorder.
	Indicates that parameter numerics are unreliable.
+	Indicates that the followed parameter is from an external device connected to the monitoring device.

## 10.5 Common Operations on Review Pages

This section describes common operations on review pages.

### 10.5.1 Browsing Trend Data

Browse trend data in one of the following ways:





- Move .
- Move the cursor.
- Move the scroll bar.

### 10.5.2 Viewing Events

You can view the following types of events:

- Manually triggered events
- Parameter-related operation events and alarm-related events, such as starting C.O. measurement
- Operation events not related to parameters

To view these events, follow this procedure:

1. Select the  button in the upper left corner of the review screen.
2. From the drop-down list, select the desired review page.
3. View events in either of the following ways:
  - ◆ Select  and select the desired event.
  - ◆ Select  or  to locate the previous or next event.



Events are displayed in a chronological order. The most recent event is displayed at the top. The number of exclamation marks before an event matches the following alarm priority:

- !!!: high priority alarm
- !: medium priority alarm
- : low priority alarm

### 10.5.3 Displaying Two Review Pages Simultaneously

When the display size of the CMS is greater than 19-inch, you can display two review pages simultaneously.

To do so, follow this procedure:

1. Select the  button in the upper left corner of the review screen.
2. From the drop-down list, select the desired review page.
3. Select the  symbol located at the top right of the screen. A new review page will be displayed below the desired review page.

You can browse trend data, view events, select other review tabs on the two review pages. If you refresh the trend data by moving the cursor or  on one review page, the trend data on the other review page will be updated accordingly.

#### NOTE

---

- For 19-inch single display, two review pages can not be displayed simultaneously.
- 

## 10.6 Tabular Trends Review Page

The tabular trends review page displays trend data in a tabular form.

### 10.6.1 Entering the Tabular Trends Review Page

Enter the tabular trends review page in either of the following ways:

- Select the  button in the upper left corner of the review screen → from the drop-down list, select **Tabular Trends**.
- Select the parameter list area on the ViewBed screen.

### 10.6.2 Configuring Trends

To configure tabular trends, follow this procedure:

1. Enter the tabular trends review page.
2. Set **Trend Group** and select the desired option. For information on trend group settings, see Section 15.7.2.2 *Selecting Trend Groups to Be Displayed*.
3. Set **Interval**. Select parameters, such as NIBP, Temp, to view the tabular trends when parameter measurements are acquired. Select **Manually Saved** to view the tabular trends when spot check data is acquired.

#### NOTE

---

- The options for **Interval** are dependent on the functions of a bedside monitor.
  - The parameters displayed for **Trend Group** are dependent on the parameters configured at a bedside monitor.
- 

### 10.6.3 Printing a Tabular Trends Report

To print a tabular trends report, follow this procedure:

1. Enter the tabular trends review page.
2. Select the  button in the upper right corner of this page. The **Print Setup** menu is displayed.

- Set the desired options. Only items that may need special remarks are described here.

Menu Item	Description	Options
Period	Select the period during which a tabular trends report will be printed.	30 min, 1 hr, 2 hrs, 4 hrs, 8 hrs, 12 hrs, 24 hrs, 48 hrs, 72 hrs, 96 hrs, Auto, All <b>Auto:</b> prints one page of a tabular trends before the current time. <b>All:</b> prints all stored tabular trends at the selected Interval. Note: <b>Auto</b> only limits the number of rows or columns for time on a report. The report may have multiple pages to accommodate the number of parameters. To limit the parameters, change the trend group on the review page.
Interval	Select the resolution of the tabular trends printed on a report.	5 sec, 30 sec, 1 min, 5 min, 10 min, 15 min, 30 min, 1 hr, 2 hrs, 3 hrs, NIBP, EWS, GCS, TempIF, C.O., Manually Saved, Auto Parameters, such as <b>NIBP, Temp:</b> prints a tabular trends report when parameter measurements are acquired. <b>Manually Saved:</b> prints a tabular trends report when spot check data is acquired. <b>Auto:</b> prints a tabular trends report at the interval set in the <b>Interval</b> option in the upper right corner of the <b>Tabular Trends</b> review page.
Report Format	Select the printing principle.	<b>Parameter Oriented:</b> prints a report with parameters listed by row and time listed by column. <b>Time Oriented:</b> prints a report with time listed by row and parameter listed by column.

- Select the desired options.
  - ◆ **Print Preview:** previews the printout. Upon completion of preview, if you wish to start printing, select **Print**.
  - ◆ **Print (All):** prints a tabular trends report per **Trend Group** and **Interval** settings on the tabular trends review page.
  - ◆ **Print:** prints a tabular trends report per settings in the **Print Setup** menu

#### 10.6.4 Exporting Trend Data

When the CMS is connected to a storage device and exporting patients' data is allowed in the system setup menu, you can export patients' trend data from the tabular trends review page or the graphic trends review page. Patients' trend data exported from these two review pages is the same. Exported trend data is saved in csv format.

For more information on allowing exporting patients' data, see Section 15.7.6 *Setting Patient Data Export*. For more information on exporting patients' trend data from the graphic review page, see Section 10.7.4 *Exporting Trend Data*.

To export patients' trend data, follow this procedure:

- Enter the tabular trends review page.
- Select the  button in the upper right corner of this page. The **Export Setup** menu is displayed.
- Set the desired options.

Menu Item	Description	Options
Date	Set the specific date on which you wish to export trend data.	Default to the date for the data where the cursor stops.

Menu Item	Description	Options
Time	Set the export end time.	Default to the date for the time where the cursor stops.
Period	Select the period during which trend data is exported.	30 min, 1 hr, 2 hrs, 4 hrs, 8 hrs, 12 hrs, 24 hrs, 48 hrs, 72 hrs, 96 hrs, All Default to 1 hr.
Interval	Select the resolution of trend data.	1 sec, 5 sec, 30 sec, 1 min, 5 min, 10 min, 15 min, 30 min, 1 hr, 2 hrs, 3 hrs, NIBP, EWS, GCS, TempIF, C.O., Manually Saved Parameters, such as <b>NIBP,Temp</b> : export trend data when parameter measurements are acquired. <b>Manually Saved</b> : export trend data when spot check data is acquired. <b>Interval</b> is defaulted to <b>Interval</b> displayed on the tabular trends review page. Note: The options for Interval are dependent on the functions of a bedside monitor.
Save Path	Select the path to save the trend data.	/

4. Select **Export**.

You can view export progress and results in the **Export Queue** menu. For more information on this menu, see Section 6.1 *Example Multibed Screen*. The exported trend data is saved in the sub-folder named as ParameterData under the patient's folder which is located in the selected **Save Path**.

## 10.7 Graphics Trends Review Page

The graphic trends review page displays trend data in a graphic form.

### 10.7.1 Entering the Graphic Trends Review Page

To enter the graphic trends review page, follow this procedure:

1. Select the ▼ button in the upper left corner of the review screen.
2. From the drop-down list, select **Graphic Trends**.

### 10.7.2 Setting Graphic Trends

To set graphic trends, follow this procedure:

1. Enter the graphic trends review page.
2. Set **Trend Group** and select the desired option. For information on trend group settings, see 15.7.2.2 *Selecting Trend Groups to Be Displayed*.
3. Set **Zoom**. Select the desired length of trend data to view the most recent 240-hour data.
4. Select the desired number of **Trends**.

### 10.7.3 Printing a Graphic Trends Report

To print a graphic trends report, follow this procedure:

1. Enter the graphic trends review page.
2. Select the  button in the upper right corner of this page. The **Print Setup** menu is displayed.
3. Set the desired options.
4. If you wish to preview the printout, select **Print Preview**.
5. Select **Print**.

## 10.7.4 Exporting Trend Data

When the CMS is connected to a storage device and exporting patients' data is allowed in the system setup menu, you can export patients' trend data from the graphic trends review page or the tabular trends review page. Patients' trend data exported from these two review pages is the same. Exported trend data is saved in csv format.

After entering the graphic trends review page, export patients' trend data by following steps in Section 10.6.4 *Exporting Trend Data*.

## 10.8 Full Disclosure Review Page

On the full disclosure review page, you can view the compressed waveforms and detail waveforms for each patient.

### 10.8.1 Entering the Full Disclosure Review Page

To enter the full disclosure review page, follow this procedure:

1. Select the ▼ button in the upper left corner of the review screen.
2. From the drop-down list, select **Full Disclosure**.

### 10.8.2 Selecting Waveforms

If you wish to review waveforms other than the default waveform on the full disclosure review page, you need to select the desired waveforms.

To do so, follow this procedure:

1. Enter the full disclosure review page.
2. Select **Setup**. The **Select Waveform** menu is displayed.
3. Select the **Storage** tab.
4. Configure the desired waveforms.
5. Select the **Display(Maximum: 3)** tab.
6. Enable the desired waveforms to be displayed on the review page.

In case of alarms, the background of compressed waveform block at the alarm time is marked with a special color:

- Red: high alarm priority
- Yellow: medium alarm priority
- Cyan: low alarm priority

### 10.8.3 Compressed Waveform

The full disclosure review page displays the compressed waveform.

#### 10.8.3.1 Setting the Scale of Compressed Waveform

To set the size of the compressed waveform, follow this procedure:

1. Enter the full disclosure review page.
2. Set the waveform scale in either of the following ways:
  - ◆ Select the **Scale** button and then select the desired option.
  - ◆ Select the waveform label on the left side of the review page to enter the **Scale** menu. Then select the desired option.

#### 10.8.3.2 Setting the Duration of Compressed Waveform

To set the length of the compressed waveform, follow this procedure:

1. Enter the full disclosure review page.

2. Select **Duration**.
3. Configure the desired **Duration** time.

### 10.8.3.3 Marking Arrhythmia

In the compressed waveform area, the background of compressed waveform segments at the arrhythmia alarm trigger time is marked with a specific color automatically to indicate the arrhythmia category. For details on how to set the arrhythmia mark color, see Section 15.7.5 *Setting Arrhythmia Mark Colors*.

### 10.8.3.4 Selecting Compressed Waveform Segments

You can select one or more compressed waveform segments and print these segments. For details on how to print these segments, see Section 10.8.5 *Printing Compressed Waveforms or Detail Waveforms*.

To select compressed waveform segments, follow this procedure:

1. Enter the full disclosure review page.
2. Select compressed waveform segments in either of the following ways:
  - ◆ Using a mouse: In the compressed waveform area, hold down the right mouse button and drag the mouse to select the desired waveform segment. If you wish to select multiple waveform segments, release the right mouse button and then select the desired waveform segments. You can move the screen up and down to select more waveform segments.
  - ◆ Using a touch screen: Press the **Select** button and then touch the waveform. Hold and drag your finger to select the desired waveform segment. If you wish to move the screen up and down, you need to re-select the **Select** button to exit the selected status.

If you wish to cancel current selection, select the  button in the upper right corner of the waveform segment selection window.

## 10.8.4 Detail Waveform Window

In the detail waveform window, you can view the full size waveforms and parameter numerics.

Access the detail waveform window in either of the following ways:

- Select the **Detail** button in the compressed waveform window.
- Double click the desired compressed waveform.

In the detail waveform window:

- Timeline and waveforms are displayed in the upper part of the window.
- Numeric values are displayed in the lower part of the window. The background color of parameters indicate whether an alarm is triggered.
  - ◆ No color: no alarm is triggered.
  - ◆ Red: a high priority alarm is triggered.
  - ◆ Yellow: a medium priority alarm is triggered.
  - ◆ Cyan: a low priority alarm is triggered.

If you wish to close the detail waveform window, select the  button in the upper right corner of the detail waveform window.

### 10.8.4.1 Setting ECG Gain

To set the ECG gain, follow this procedure:

1. Enter the detail waveform window.
2. Select the **ECG Gain** button.
3. Configure the desired ECG gain.

### 10.8.4.2 Setting Waveform Sweep Speed

To set the waveform sweep speed, follow this procedure:

1. Enter the detail waveform window.
2. Select the **Speed** button.
3. Configure the desired speed. The speed is applicable to all the ECG waveforms.

### 10.8.4.3 Caliper Measurement Overview

When full disclosure data is collected and stored in the CMS, horizontal calipers can be used to measure the PR, QRS, QT, and R-R waveform intervals, and vertical calipers can be used to measure the ST waveform amplitude in the detail waveform window.

Horizontal caliper and vertical caliper are shown as follows:

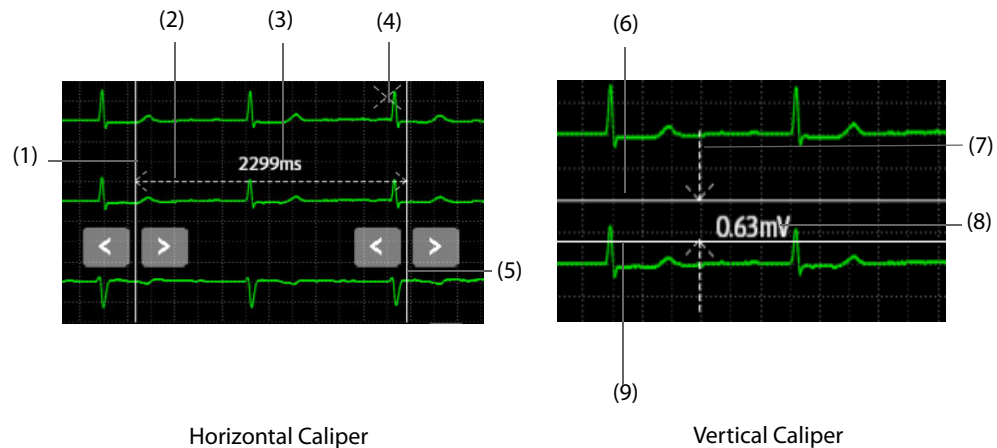

(1)	Left caliper arm
(2), (7)	Measurement line
(4)	Close button: closes the caliper window without saving the measured value.
(5)	Right caliper arm
(3), (8)	Realtime measurement
(6)	Upper caliper arm
(9)	Lower caliper arm

#### Performing Measurements Using a Horizontal Caliper

Choose either of the following ways to perform measurements using a horizontal caliper:

Option 1:

1. Enter the detail waveform window.
2. Select **Caliper**. The **Caliper** menu is displayed.
3. Display a horizontal caliper in either of the following ways.
  - ◆ Using a mouse: left or right click the mouse at a place in the desired waveform area and then drag the cursor horizontally until your desired location is reached.
  - ◆ Using a touch screen: select a place in the desired waveform area and then drag your finger on the screen surface horizontally without losing the contact until the desired location is reached. If you need to adjust the caliper, slightly touch the left or right caliper arm and select the appropriate touchscreen control.
4. After finishing measurements, select **PR**, **QRS**, **RR**, and **QT** from the **Caliper** menu to obtain the measured values. The QTc value is calculated after RR and QT value have been acquired.
5. Select the desired option to **Save** or **Reset** measured values.
  - ◆ **Save**: saves the caliper measurement values as a manual event in the event review page. In the **Please input new name**:field, enter the desired name of the event. The default name is **Saved ECG**

**Measurements.** In the **Please input comments:** field, enter the desired comments and then select **OK**. Up to 32 characters can be entered for the name and the comments. The measured values are displayed above the first ECG waveform in the event detail window.

- ◆ **Reset:** clears the measured values.

Option 2:

1. Enter the detail waveform window.
2. Right click the mouse at a place in the desired waveform area and then drag the cursor horizontally until your desired location is reached. Measured values are displayed in real-time.

## NOTE

- **Measured values obtained by Option 2 cannot be saved.**







## Performing Measurements Using a Vertical Caliper

To perform measurements using a vertical caliper, follow this procedure:

1. Enter the detail waveform window.
2. Select **Caliper**. The **Caliper** menu is displayed.
3. Select **ST**.
4. Display a vertical caliper in either of the following ways.
  - ◆ Using a mouse: left click the mouse at a place in the desired waveform area and then drag the cursor vertically until your desired location is reached.
  - ◆ Using a touch screen: select a place in the desired waveform area and then drag your finger on the screen surface vertically without losing the contact until the desired location is reached. If you need to adjust the caliper, slightly touch the left or right caliper arm and select the appropriate touchscreen control.
5. After finishing measurements, select **ST** from the **Caliper** menu to obtain the measured value.
6. Select the desired option to **Save** or **Reset** measured values.
  - ◆ **Save:** saves the caliper measurement values as a manual event in the event review page. In the **Please input new name:** field, enter the desired name of the event. The default name is **Saved ECG Measurements**. In the **Please input comments:** field, enter the desired comments and then select **OK**. Up to 32 characters can be entered for the name and the comments. The measured values are displayed above the first ECG waveform in the event detail window.
  - ◆ **Reset:** clears the measured values.

## Moving the Caliper

After displaying a caliper, you can also move calipers as shown below to measure the time difference between any two points:

- When the cursor is in the shape of  , you can move the caliper horizontally.
- When the cursor is in the shape of  , you can move the caliper vertically.
- When the cursor is in the shape of  inside the caliper, you can move the entire caliper window.
- Select the  button or the  button in the horizontal caliper measurement area.
- Select the  button or the  button in the vertical caliper measurement area.

## Canceling Caliper Measurements

During caliper measurement, you can cancel a caliper measurement in either of the following ways:

- Select the **Caliper** button.
- Select anywhere in the waveform area.
- Select the  button in the caliper window.

### 10.8.4.4 Setting Beat Annotation

When a bedside monitor and a telemetry device support the beat annotation functionality, you can enable or disable **Beat Anno:** to display or hide white beat labels above the first ECG waveform in the detail waveform



window. The white beat labels indicate how the monitor or the telemetry device is classifying beats and may explain suspected, missed, or false arrhythmia calls.

- N = Normal
- V = Ventricular Ectopic
- S = Supraventricular Premature
- P = Paced
- L = Learning
- ? = Insufficient information to classify beats
- I = Inoperative (for example, Lead Off)
- M = Missed beat

When beat labels are displayed above the ECG waveform, they can be printed. If you enable or disable **Beat Anno**: in the detail waveform window, these beat labels will also be displayed or hidden in the event detail window, and vice versa.

---

## CAUTION

- **Ensure that you have selected the optimal leads with the best waveform amplitude and the highest signal-to-noise ratio. Selecting the optimal leads is important for beat detection, beat classification, and V-Fib detection.**
- 

### 10.8.4.5 Other Operations in the Detail Waveform Window

In the detail waveform window, you can save events and export waveforms to third party systems.

To do so, follow this procedure:

1. Enter the detail waveform window.
2. Select the  button in the upper right corner of the window.
3. Select the desired option.
  - ◆ **Save As Event**: displays the **Saved Event** dialog box. The event can be saved with the desired **Name** and **Comments**. The default name for the event is **Saved Event**. The saved event is marked as a manual event on the event review page.
  - ◆ **Export to EMR**: export 20 seconds of waveform data after the start time of current waveform to third party systems.

## NOTE

- **The Export to EMR option is available only when the CMS is configured with eGateway and the exporting to EMR feature is enabled on the system setup screen. For details on how to enable this feature, see Section 15.9.4.3 Testing ADT Server Connection.**
- 

### 10.8.5 Printing Compressed Waveforms or Detail Waveforms

To print the compressed waveform or detailed waveform, follow this procedure:

1. Enter the full disclosure review page.
2. Select the  button in the upper right corner of this page. The **Print Setup** menu is displayed.
3. Select the desired options. Only items that may need special remarks are described here.
  - ◆ **Print Waveform Overview**: prints the compressed waveform displayed on the full disclosure review page.
  - ◆ **Print Overview of Selected Waveforms**: prints the selected compressed waveform segments. For details on how to select compressed waveform segments, see Section 10.8.3.4 *Selecting Compressed Waveform Segments*.
  - ◆ **Print Details of Selected Waveforms**: prints the detail waveform for the selected compressed waveform segments according to the time period where selected waveform segments are located.
  - ◆ **Print Displayed Detailed Waveforms**: prints the detail waveform for the entire compressed waveform.



- ◆ **Print Selected Detailed Waveforms:** prints the detail waveform for the selected waveform segments according to waveforms. If you select this option, you can further select **Select Waveform** to customize the number and sequence of waveforms which are output on a printout. After performing the desired settings, select the  button in the upper right corner of the **Select Waveform** menu.
4. If you wish to preview the printout, select **Print Preview**.
  5. Select **Print**.

## NOTE

- **Print Displayed Waveform Detail and Print Selected Waveform Detail are selectable in the detail waveform window only. For information regarding accessing the detail waveform window, see Section 10.8.4 Detail Waveform Window.**

## 10.8.6 Recording Detailed Waveforms

To record detailed waveforms, follow this procedure:

1. Enter the full disclosure review page.
2. Enter the detail waveform window. For information regarding accessing to this window, see Section 10.8.4 *Detail Waveform Window*.
3. Select the  button in the upper right corner of this page. The Record Setup menu is displayed.
4. Select the desired options.
  - ◆ **Record Displayed Detailed Waveforms:** records the detail waveform for the entire compressed waveform.
  - ◆ **Record Selected Detailed Waveforms:** records the detail waveform for the selected waveform segments according to waveforms. If you select this option, you can further select **Select Waveform** to customize the number and sequence of waveforms which are output on a printout. After performing the desired settings, select the  button in the upper right corner of the **Select Waveform** menu.
5. Select **Record**.

## 10.8.7 Exporting Waveform Data

When the CMS is connected to a storage device and exporting patients' data is allowed in the system setup menu, you can export patients' waveform data from the full disclosure review page. For more information on allowing exporting patients' data, see Section 15.7.6 *Setting Patient Data Export*.

To export patients' waveform data, follow this procedure:

1. Enter the full disclosure review page.
2. Select the  button in the upper right corner of this page. The **Export Setup** menu is displayed.
3. Set the desired options.

Menu Item	Description	Options
Date	Set the specific date on which you wish to export waveform data.	Default to the date for the data where the cursor stops.
Time	Set the export end time.	Default to the date for the time where the cursor stops.
Period	Select the period during which waveform data is exported.	30 min, 1 hr, 2 hrs, 4 hrs, 8 hrs, 12 hrs, 24 hrs, 48 hrs, 72 hrs, 96 hrs, All Default to 1 hr.
Select Waveform	Select the desired waveforms to be exported.	Enabling a waveform means this waveform will be exported.
Save Path	Select the path where exported waveform data is saved..	/

Menu Item	Description	Options
File Format	Select the desired format in which exported waveform data is saved.	csv, xml. csv is the default.

4. Select **Export**.

You can view export progress and results in the **Export Queue** menu. For more information on this menu, see Section 6.1 *Example Multibed Screen*. The exported trend data is saved in the sub-folder named as WaveformData under the patient's folder which is located in the selected **Save Path**.

## 10.8.8 Resting 12-Lead ECG Analysis

When it is impossible or inconvenient to do a real-time resting 12-lead ECG analysis on the bedside monitor, the CMS can be used to analyze the historical 12-lead ECG waveforms sent by the bedside monitor on the full disclosure review page. The CMS supports only Glasgow 12-lead ECG analysis algorithm. For more information on the Glasgow algorithm, refer to *12-Lead ECG Interpretive Program Physician's Guide (PN: 046-004817-00)*.

### NOTE

- **Compatible monitors supporting this function include BeneVision N series ePM series monitors.**
- **It's required that the waveforms selected to analyze are obtained using standard 12-lead electrode placement while the patient remains still and relaxed. Otherwise, the analysis result might not be correct.**
- **Resting 12-lead ECG analysis is intended for online patients. It is not intended for discharged patients.**
- **A license is required for resting 12-lead ECG analysis.**
- **The offline waveform data sent after a reconnection is not intended for 12-lead ECG analysis.**

### WARNING

- **The result of the resting 12-lead ECG analysis should be confirmed by the physician.**

### 10.8.8.1 Editing Patient Information

Some patient information may directly affect ECG analysis. Complete and correct patient information is helpful for accurate diagnosis and treatment of the patient. Enter patient information before taking an ECG measurement.

To enter patient information, follow this procedure:

1. Enter the full disclosure review page.
2. Select desired compressed waveform.
3. Double click the selected compressed waveform or select the **Detail** button to access the detail waveform window.
4. Select **Setup** to enter the **12-Lead Setup** menu.
5. On the **Patient Demographics** page, input or edit patient information.
6. Select **Save**.

### NOTE

- **Modifying patient information in the 12-lead setup menu will synchronize to the monitor.**

### 10.8.8.2 Setting Other Information for Resting 12-Lead ECG Analysis

1. To set other information for resetting 12-lead analysis, follow this procedure:
2. Enter the full disclosure review page.
3. Select desired compressed waveform.

4. Double click the selected compressed waveform or select the **Detail** button to access the detail waveform window.
5. Select **Setup** to enter the **12-Lead Setup** menu.
6. On the **12-Lead Setup** menu, Select **Setup** tab.
7. Set **High Freq Cut-off**: the high frequency filter attenuates muscle artifact by restricting the included frequencies. The setting of the high frequency filter is 35 Hz by default. The high frequency filter is a low-pass filter. That is to say signal that exceeds the set frequency is filtered out. For example, if you set **High Freq Cut-off** to **35 Hz**, only signal at 35 Hz or less displays. Signal exceeding 35 Hz is attenuated.
8. Set **Baseline Drift Removal**: the baseline drift removal (BDR) suppresses most baseline drift interference and also is able to preserve the fidelity of the ST-segment level. BDR is switched on by default. If BDR is switched off, the 0.05 Hz high pass filter is used.
9. Set **Tachy** and **Brady**.

### 10.8.8.3 Initiating Resting 12-Lead ECG Analysis

To initiate 12-Lead ECG analysis, follow this procedure:

1. Enter the full disclosure review page.
2. Select desired compressed waveform.
3. Double click the selected compressed waveform or select the **Detail** button to access the detail waveform window.
4. In the detail waveform window, move the cursor to the desired time.
5. In the detail waveform window, select **Analyze**. The system selects 10 seconds of waveforms following the cursor to start analyzing automatically.

At the completion of the resting 12-lead ECG analysis, the report preview displays on the page.

#### NOTE

- **Ensure that the waveform following the cursor is not less than 10 seconds; otherwise the analysis will not start.**

### 10.8.8.4 Saving the 12-Lead Interpretation Report

At the completion of the 12-lead ECG interpretation, Select **Save** to save the report.

### 10.8.8.5 Printing the 12-Lead Interpretation Report

At the completion of the 12-lead ECG interpretation, Select **Print** to output the report.

## 10.9 Events Review Page

On the events review page, you can view physiological alarm events, manual events, and operational events.

### 10.9.1 Entering the Events Review Page

To enter the events review page, follow this procedure:

1. Select the ▼ button in the upper left corner of the review screen.
2. From the drop-down list, select **Events**.

### 10.9.2 Event List

In the event list:

- Events are displayed in descending chronological order. The most recent event is displayed at the top. The number of exclamation marks before an event matches different alarm priorities.
  - ◆ !!!: high priority alarm
  - ◆ !!: medium priority alarm

- ◆ !: low priority alarm
- Event lock status, trigger time, alarm priority, and event remarks if available are displayed for each event.
- Different color blocks are displayed on the left of each event to indicate different event types.
  - ◆ Red: high priority alarm event
  - ◆ Yellow: medium priority alarm event
  - ◆ Cyan: low priority alarm event
  - ◆ Green: manual event
  - ◆ White: operation-related event

### 10.9.2.1 Setting Filters

You can filter events by time, alarm priority, alarm category, and parameter group.

To filter events, follow this procedure:

1. Enter the event review page.
2. Select **Filter**. From the drop-down list, select the desired item.



You can customize two criteria. To do so, follow this procedure:

1. From the **Filter** drop-down list, select **Custom 1** or **Custom 2** to enter the **Filter Setup** menu.
2. Select the **Name** field to edit the name of the custom criterion.
3. Select desired items.

If you want to review events happened around certain time, select the  button → set the time → select **OK**. Then the cursor jumps to the event happened closest to the defined time.

### 10.9.2.2 Other Operations in the Event List

To perform other event-related operations, follow this procedure:

1. Enter the event review page.
2. Select the desired event from the event list.
3. Select the  button.
4. Select the desired option. Only items that may need special remarks are described here. The functions of locking and unlocking events is available in the CentralStation only.
  - ◆ **Lock**: lock the event manually. When the event is locked, the  symbol is displayed. The locked event needs to be unlocked before being deleted. Events can also be locked automatically. For details, see Section 15.7.4 *Setting Events*.
  - ◆ **Rename**: you can rename a manual event or an arrhythmia alarm event.
  - ◆ **Note**: you can enter comments for the event. When comments are available, the  symbol is displayed. You can also modify or delete comments in the event detail window. Up to 32 characters can be entered.
  - ◆ **Show Disabled Arrhythmia Alarms**: this option is unselected by default. Select this option and arrhythmia events that have alarms turned off display in the event list.

#### NOTE

- **If events are all locked, the CentralStation will automatically delete the oldest locked event with each addition of a new event when system storage reaches capacity.**

### 10.9.3 Event Detail Window

Enter the event detail window in either of the following ways:

- Double click or tap the desired event from the event list.
- Select the **Detail** button on the event review page.

The event detail window displays the event name, the event triggered time and the details of the event.

If you wish to close the event detail window, select the  button.

### 10.9.3.1 Configuring ECG Gain

To configure the ECG gain, follow this procedure:

1. Enter the event detail window.
2. Select **ECG Gain**.
3. Select the desired gain.

### 10.9.3.2 Configuring Waveform Sweep Speed

To configure the waveform sweep speed, follow this procedure:

1. Enter the event detail window.
2. Select the **Speed** button.
3. Configured the desired speed. The speed is applicable to all the ECG waveforms.

### 10.9.3.3 Caliper Measurement

For details on how to perform caliper measurement, see Section *10.8.4.3 Caliper Measurement Overview*.

### 10.9.3.4 Setting Beat Annotation

For details on how to set beat annotation, see Section *10.8.4.4 Setting Beat Annotation*.

### 10.9.3.5 Other Operations in the Event Detail Window

In the event detail window, you can perform operations such as renaming events.

To do so, follow this procedure:

1. Enter the event detail window.
2. Select the  button in the right corner of the window.
3. Select the desired option. Among these options, selecting **Export to EMR** exports the event related data to third party systems.

#### NOTE

- 
- **The Export to EMR option is available only when the CMS is configured with eGateway and the exporting to EMR feature is enabled on the system setup screen. For details on how to enable this feature, see Section 15.9.4.3 Testing ADT Server Connection.**
- 

## 10.9.4 Printing Events

To print the desired event list or event details, follow this procedure:

1. Enter the event review page.
2. Select the desired events from the event list.
3. Select the  button in the upper right corner of this page. The **Print Setup** menu is displayed.
4. Select the desired options.
  - ◆ **Print All Event List:** print the entire event list.
  - ◆ **Print List of Selected Events:** print the selected events list.
  - ◆ **Print Overview of Selected Events:** when multiple events are selected from the event list, selecting this option prints these events on the same page and outputs an event overview report.
  - ◆ **Print Detail of Selected Events:** print the details of selected events.
  - ◆ **Print Displayed Event Detail:** print the details of the selected event. If you wish to select this option, you need to open the event detail window first. If waveform data is available for the selected event, 16 seconds of waveforms before and after the alarm trigger time are printed by default. The actual

waveform data printed depends on the option selected for **Printing Duration On Alarm**. For details on how to set **Printing Duration On Alarm**, see Section 15.10.9 *Setting Other Print-Related Items*.

5. If you wish to preview the printout, select **Print Preview**.
6. Select **Print**.

## NOTE

- **Print preview is not applicable for Print Detail of Selected Events.**

## 10.9.5 Recording Event Detail

To record the event detail, follow this procedure:

1. Enter the event detail page.
2. Select the  button in the upper right corner of this page.

## 10.10 12-Lead ECG Review Page

You can review 12-lead analysis reports on the 12-lead ECG review page, including parameter measurements, diagnosis results and ECG waveforms. You can also reanalyze the report.

### 10.10.1 Entering the 12-Lead Review Page

To enter the 12-lead ECG review page, follow this procedure:

1. Select the  button in the upper left corner of the review screen.
2. From the drop-down list, select **12-Lead ECG**.

### 10.10.2 Median Complex Window (For Glasgow Algorithm Only)

On the 12-lead ECG review page, selecting **Median Complex** enters the median complex window of current report.

In the median complex window, the median complex template marks the start and end position of P-wave and QRS-wave and the end position of T-wave.

Selecting **Waveform** returns to the 12-lead ECG waveform review page.

### 10.10.3 Configuring 12-Lead ECG Waveforms

To configure 12-lead ECG waveforms on the review page, follow this procedure:

1. Enter the 12-lead ECG review page.
2. Configure **Speed** and **Gain**.
3. Configure **Layout**.
  - ◆ **12x1**: displays 12-lead ECG waveforms on one page in one column.
  - ◆ **6x2**: displays 12-lead ECG waveforms on one page in two columns, with 6 lines in each column.
  - ◆ **6x2+1**: displays 12-lead ECG waveforms on one page in two columns, with 6 lines in each column, and one rhythm lead waveform at the bottom.
  - ◆ **3x4+1**: displays 12-lead ECG waveforms on one page in 4 columns, with 3 lines in each column, and one rhythm lead waveform at the bottom.
  - ◆ **3x4+3**: displays 12-lead ECG waveforms on one page in 4 columns, with 3 lines in each column, and three rhythm lead waveforms at the bottom.

### 10.10.4 Caliper Measurement

Horizontal calipers can be used to measure the PR, QRS, QT, and R-R waveform intervals, and vertical calipers can be used to measure the ST waveform amplitude in the median complex window.

To perform measurements using a horizontal or vertical caliper, follow this procedure:

1. Enter the 12-lead ECG review page.
2. Select the **Caliper** button.
3. From the drop-down list, select the desired option:
  - ◆ **Caliper**: perform measurement using a horizontal caliper.
  - ◆ **ST Caliper**: perform measurement using a vertical caliper.
4. Display a caliper.
5. Obtain measured values.

For details on how to display a horizontal or vertical caliper, how to obtain measured values, and how to move a caliper, see Section 10.8.4.3 *Caliper Measurement Overview*.

#### NOTE

---

- **The measured caliper values on the 12-lead analysis review page are not saved on the event review page.**
- 

### 10.10.5 Resting 12-Lead ECG Reanalysis

When the results of a resting 12-lead ECG analysis performed on the bedside monitor are in question due to incomplete or inaccurate patient demographics or configuration etc., the CMS can be used to reanalyze the original report waveform data sent by the bedside monitor. On the 12-lead ECG review page, fill in correct patient information and perform the reanalysis. For more information on the Glasgow algorithm, refer to *12-Lead ECG Interpretive Program Physician's Guide (PN: 046-004817-00)*.

#### NOTE

---

- **Compatible monitors supporting this function include BeneVision N series and ePM series monitors.**
  - **Resting 12-lead ECG reanalysis is intended for online patients. It is not intended for discharged patients.**
  - **A license is required for resting 12-lead ECG reanalysis.**
  - **The offline waveform data sent after a reconnection is not intended for 12-lead ECG reanalysis.**
- 
- 

#### WARNING

---

- **The result of the resting 12-lead ECG reanalysis should be confirmed by the physician.**
- 
- 

#### 10.10.5.1 Editing Patient Information

Some patient information may directly affect ECG analysis. Complete and correct patient information is helpful for accurate diagnosis and treatment of the patient. Enter patient information before taking an ECG measurement.

Select the patient information area or follow the procedure below to enter patient information:

1. Enter the 12-lead ECG review page.
2. Select **Setup** to enter the **12-Lead Setup** menu.
3. On the **Patient Demographics** page, input or edit patient information.
4. Select **Save**.

#### NOTE

---

- **Modifying patient information in the 12-lead setup menu will synchronize to the monitor.**
- 

#### 10.10.5.2 Setting Other Information for Resting 12-Lead ECG Reanalysis

To set other information for resetting 12-lead reanalysis, follow this procedure:

1. Enter the 12-lead ECG review page.
2. Select **Setup** to enter the **12-Lead Setup** menu.



3. On the **12-Lead Setup** menu, Select **Setup** tab. For more information on the setup options, see *10.8.8.2 Setting Other Information for Resting 12-Lead ECG Analysis*.

### 10.10.5.3 Initiating Resting 12-Lead ECG Renalysis

To initiate 12-Lead ECG reanalysis, follow this procedure:

1. Enter the 12-lead ECG review page.
2. Select  symbol to set desired report.
3. Select **ReAnalyze**.

At the completion of the reanalysis, the result displays on the page.

### 10.10.6 Printing 12-Lead Analysis Reports

To print a 12-lead ECG analysis report, follow this procedure:

1. Enter the 12-lead ECG review page.
2. Select the  button in the upper right corner of this page. The **Print Setup** menu is displayed.
3. Set the desired options.
4. Select **Print**.

## 10.11 ST Review Page

You can review ST segments and values on the ST review page.

### 10.11.1 Entering the ST Review Page

To enter the ST review page, follow this procedure:

1. Select the  button in the upper left corner of the review screen.
2. From the drop-down list, select **ST**.

### 10.11.2 Setting ST Reference Templates

You can set the desired ST template as a reference template.

To do so, follow this procedure:

1. Enter the ST review page.
2. Select the desired ST template.
3. Select **Set Reference**.

### 10.11.3 Displaying/Hiding ST Reference Templates

On the ST review page, select **Display Reference** or **Hide Reference**.

- **Display Reference:** the ST template storage time is displayed on the right of current segment and ST values are also displayed on the reference template.
- **Hide Reference:** hide the ST reference template.

### 10.11.4 Displaying/Hiding Markers

On the ST review page, select **Display Marker** or **Hide Marker**.

- **Display Marker:** a white vertical bar appears above each waveform, marking the positions of ISO, J point, and ST point.
- **Hide Marker:** the positions of ISO, J point, and ST point are not displayed.

### 10.11.5 Printing ST Segment Waveforms

To print ST segment waveforms, follow this procedure:

1. Enter the ST review page.
2. Select the  button in the upper right corner of this page. The **Print Setup** menu is displayed.
3. Set the desired options.
4. Select **Print**.

## 10.12 Arrhythmia Statistics Page

On the arrhythmia statistics page, you can view the statistics about the HR value and the number of each arrhythmia category within a specific time period. Arrhythmia statistics can be displayed in a tabular or graphic format.

### 10.12.1 Entering the Arrhythmia Statistics Page

To enter the arrhythmia statistics page, follow this procedure:

1. Select the  button in the upper left corner of the review screen.
2. From the drop-down list, select **Arrhy Statistics**.

### 10.12.2 Viewing Arrhythmia Statistics

To view arrhythmia statistics, follow this procedure:

1. Enter the arrhythmia statistics page.
2. If you wish to view arrhythmia statistics in a tabular format, select **Tabular** in the upper right corner of this page.
3. Select **Zoom** to view arrhythmia events within a specific time period. The default for **Zoom** is **24 hrs**.
4. If you wish to view arrhythmia statistics in a graphic format, select **Graphic**.

On the graphic arrhythmia statistics page:

- The left side displays the name, times of occurrence, and duration of arrhythmias. The right side displays the arrhythmia occurrence time and colored block which matches different alarm priorities.
  - ◆ Red: high alarm priority
  - ◆ Yellow: medium alarm priority
  - ◆ Cyan: low alarm priority
- Selecting the desired arrhythmia on the left displays the waveform area on the right side. After selecting the waveform area, you can view more details about this arrhythmia.

### 10.12.3 Setting the Display of Arrhythmia Events

#### 10.12.3.1 Displaying Disabled Arrhythmia Alarms

To display arrhythmia events that have alarms turned off in the review, follow this procedure:

1. Enter the arrhythmia statistics page.
2. select **Graphic**.
3. select the  button.
4. Select **Show Disabled Arrhythmia Alarms**: this option is disabled by default. Enabling it, arrhythmia events that have alarms turned off displays are displayed in the review.

#### 10.12.3.2 Displaying High Quality Arrhythmia Alarms Only

To exclude arrhythmia events with obvious noise or arrhythmia events without typical alarm characteristics in the review, follow this procedure:

1. Enter the arrhythmia statistics page.

2. select **Graphic**.
3. select the  button.
4. Select **High Quality Arrhythmia Alarms Only**: this option is disabled by default. Enabling it, events with obvious noise or events without typical alarm characteristics are excluded in the review.

## 10.12.4 Printing Arrhythmia Statistics Results

To print arrhythmia statistics results, follow this procedure:

1. Enter the arrhythmia statistics page.
2. Select the  button in the upper right corner of this page. The **Print Setup** menu is displayed.
3. Set the desired options.
4. Select **Print**.

## 10.13 aEEG Review Page

aEEG review page displays historical aEEG monitoring data.

### 10.13.1 Entering the aEEG Review Page

Enter the aEEG review page in either of the following ways:

- Select the  button in the upper left corner of the review screen → from the drop-down list, select **aEEG Review**.
- Select the **aEEG** quick key on the ViewBed screen → select the aEEG window area → in the aEEG setup menu, select **aEEG Review**.
- Select the **Screen Setup** quick key on the ViewBed screen → select the **Choose Screen** tab → select **aEEG** → select the aEEG window area → in the aEEG setup menu, select **aEEG Review**.
- Select the **Main Menu** quick key on the ViewBed screen → from the **Display** column select **Choose Screen** → select **aEEG** → select the aEEG window area → in the aEEG setup menu, select **aEEG Review**.

### 10.13.2 Setting the aEEG Review Display

You can set different aEEG review displays:

- **aEEG with EEG**: default option, displays up to four aEEG waveforms and up to four EEG waveforms in the first half and second half of the page respectively. And you can set the scale and speed for the aEEG and EEG waveforms.
- **aEEG with DSA**: displays up to four aEEG waveforms and DSA trends of up to four EEG channels in the first half and second half of the page respectively. And you can set the scale and speed for the aEEG waveforms, and power scale for the DSA trend.
- **aEEG with Trend**: displays up to four aEEG waveforms and HR/SpO2 trends in the first half and second half of the page respectively. And you can set the scale and speed for the aEEG waveforms.

### 10.13.3 Initiating a Manual Event

To initiate a manual event for the aEEG review, follow this procedure:

1. Enter the aEEG review page.
2. Select **Mark** or select  → **Mark**.
3. Select a name for this event, for example **Intubated**, or input a name.
4. Select **OK**. The CMS saves the manual event.

To edit and select the name of preset event names, select  to enter the **Manual Event Setup** menu.

### 10.13.4 Printing an aEEG Report

To print an aEEG report, follow this procedure:

1. Enter the aEEG review page.

2. Select the  button in the upper right corner of this page. The **Print Setup** menu is displayed.
3. Set the desired options.
4. Select **Print**.

# 11 Calculation

---

## 11.1 Calculation Overview

The CMS provides calculation functions. The calculated values, which are not directly measured, are computed based on the values you provide. Any operation on a calculation page does not affect the patient monitored by the CMS.

The CMS can perform the following calculations:

- Drug calculations
- Hemodynamic calculations
- Oxygenation calculations
- Ventilation calculations
- Renal calculations

### NOTE

- **The calculation functions that can be performed on the CMS are dependent on the system setup. For details on how to configure the calculation functions, see Section 15.3.5 Setting Patient Window.**
- 

## 11.2 Calculation Safety Information

---

### WARNING

- **Decisions on the choice and dosage of drugs administered to patients must always be made by the physician in charge. The drug calculations are based on the values input, it does not check the plausibility of the calculation performed.**
  - **Be sure to enter correct values and verify the correctness of the calculation results displayed on the screen before using them. We assume no responsibility for any consequences caused by wrong entries and improper operations.**
  - **The calculations in the titration table are subject to the drug calculations. Therefore, always ensure the correctness of the drug calculations and confirm the reference, dose interval and dose type.**
- 

## 11.3 Accessing the Calculation Screen

Access the calculation screen in either of the following ways:

- Select the waveform or parameter area in the desired patient sector on the multibed screen to enter the ViewBed screen → select the **Calculations** tab.
- Select the patient information area of the desired patient sector on the multibed screen to enter the patient management screen → select the **Calculations** tab.

## 11.4 Drug Calculations

On the drug calculation page, you can perform drug calculation, view calculation result, and print the titration table.

### 11.4.1 Performing Drug Calculations

To perform drug calculations, follow this procedure.

1. Select the ▼ button in the upper left corner of the calculation screen.
2. From the drop-down list, select **Drug** to access the drug calculation page.
3. Select the **Calculator** tab.
4. Set **Drug Name** and **Patient Category**. The dose calculation program has a library of commonly used drugs, of which Drug A through Drug E are user defined.
5. If the drug dose is weight dependent, enable **Weight Based** and input the patient's weight.
6. Enter the known values, for example Drug Amount and **Solution Volume**.
7. Select **Calculate**. The calculated values are indicated by red arrows.

#### NOTE

---

- **If available, the patient category and weight from the patient management screen are automatically entered when you first access the drug calculation page. You can change the patient category and weight. This will not change the patient category and weight stored on the patient management screen.**
- 

### 11.4.2 Viewing a Titration Table

The titration table shows information on the currently used drugs. You can view the drug dose that will be applied to the patient at different infusion rates.

To access the titration table, follow this procedure.

1. Select the ▼ button in the upper left corner of the calculation screen.
2. From the drop-down list, select **Drug** to access the drug calculation page.
3. Select the **Titration Table** tab.
4. Select **Dose Type** to set the type of dose unit in the titration table.
5. Select **Interval** to set the interval between two adjacent titration table items.
6. If you need to sort the titration table, select the desired items at the top of the screen:
  - ◆ **Dose:** lists the drug doses in ascending order.
  - ◆ **Infusion Rate:** lists the infusion rates in ascending order.
  - ◆ **Exact Rate:** the resolution of the infusion rate can reach 0.01 so that you can display the infusion rate more accurately.

### 11.4.3 Printing a Titration Table

Select the  button in the upper right corner of the titration table to print the calculation result.

## 11.4.4 Drug Calculation Formula

Description	Unit	Formula
Drug Amount	g series: mcg, mg, g unit series: Unit, KU, MU mEq series: mEq	Drug Amount = Dose × Infusion Time
Drug Amount (weight based)	g series: mcg, mg, g unit series: unit, kU, mU mEq series: mEq	Drug Amount (weight based) = Dose × Infusion Time × Weight
Solution Volume	ml	Volume = Infusion Rate × Infusion Time
Dose	Dose/hr Dose/min	Dose = Infusion Rate × Concentration
Dose (weight based)	Dose/kg/hr Dose/kg/min	Dose (weight based) = Infusion Rate × Concentration / Weight
Concentration	mcg/ml, mg/ml, g/ml, Unit/ml, KU/ml, MU/ml, mEq/ml	Concentration = Drug Amount / Solution Volume
Infusion Time	hr	Infusion Time = Drug Amount / Dose
Infusion Time (weight based)	hr	Infusion Time (weight based) = Drug Amount / (Dose × Weight)
Infusion Rate	ml/hr	Infusion Rate = Dose / Concentration
Infusion Rate (weight based)	g·ml/hr	Infusion Rate = Dose × Weight / Concentration

## 11.4.5 Titration Table Calculation Formula

Description	Unit	Formula
Infusion Rate	ml/hr	Infusion Rate = Dose / Concentration
Infusion Rate (weight based)	ml/hr	Infusion Rate = Weight × Dose / Concentration
Dose	Dose/hr Dose/min	Dose = Infusion Rate × Concentration
Dose (weight based)	Dose/kg/hr Dose/kg/min	Dose (weight based) = INF Rate × Concentration / Weight

## 11.5 Hemodynamic Calculations

On the hemodynamic calculation page, you can perform hemodynamic calculation, view and print the calculation result.

### 11.5.1 Performing Hemodynamic Calculations

To perform hemodynamic calculation, follow this procedure.

1. Select the ▼ button in the upper left corner of the calculation screen.
2. From the drop-down list, select **Hemodynamics** to access the hemodynamic calculation page.
3. Enter values. For a patient who is being monitored, the currently measured values are automatically populated.
4. Select **Calculate**.

The calculated value greater than the normal upper limit is indicated by an up arrow “↑”. The calculated value lower than the normal lower limit is indicated by a down arrow “↓”.

On the hemodynamic calculation page, you can also perform the following operations:

- Select **Range** to show the normal range of each parameter.
- Select **Range**, and then the **Range** button changes to **Unit**. Select **Unit** to show the unit of each parameter.

## 11.5.2 Viewing Hemodynamic Calculation Results

Upon completion of hemodynamic calculation, the most recent 100 calculation results are stored in the CMS automatically. The calculation time is displayed on the left of the hemodynamic calculation page. You can select the desired calculation time to view corresponding calculation result.

## 11.5.3 Printing Hemodynamic Calculation Results

Select the  button in the upper right corner of the hemodynamic calculation page to print the calculation result.

## 11.5.4 Viewing Hemodynamic Parameter Diagnosis

To view diagnosis of all the hemodynamic parameters, select a certain hemodynamic calculation result and select **Hemo**.

The symbols beside the hemodynamic parameters have the following meanings:

- \*: indicates an intermittent parameter.
- \*\*: indicates an oxygenation parameter.
- ↑ or ↓: indicates that a parameter value exceeds its upper or lower limit.

## 11.5.5 Input Parameters for Hemodynamic Calculations

Input Parameter	Label	Unit
cardiac output	C.O.	L/min
heart rate	HR	bpm
pulmonary artery wedge pressure	PAWP	mmHg
artery mean pressure	PMAP	mmHg
pulmonary artery mean pressure	PA Mean	mmHg
central venous pressure	CVP	mmHg
end-diastolic volume	EDV	ml
height	Height	cm
weight	Weight	kg

## 11.5.6 Calculated Parameters and Formulas for Hemodynamic Calculations

Calculated Parameters	Label	Unit	Formula
cardiac index	C.I.	L/min/m <sup>2</sup>	C.I. (L/min/m <sup>2</sup> ) = C.O. (L/min)/BSA (m <sup>2</sup> )
body surface area	BSA	m <sup>2</sup>	BSA (m <sup>2</sup> ) = Wt <sup>0.425</sup> (kg) × Ht <sup>0.725</sup> (cm) × 0.007184
stroke volume	SV	ml	SV (ml) = 1000 × C.O. (L/min)/HR (bpm)
stroke index	SVI	ml/m <sup>2</sup>	SVI (ml/m <sup>2</sup> ) = SV (ml)/BSA (m <sup>2</sup> )
systemic vascular resistance	SVR	DS/cm <sup>5</sup>	SVR (DS/cm <sup>5</sup> ) = 79.96 × [PAMAP (mmHg) - CVP (mmHg)]/C.O. (L/min)



Calculated Parameters	Label	Unit	Formula
systemic vascular resistance index	SVRI	$DS \cdot m^2/cm^5$	$SVRI (DS \cdot m^2/cm^5) = SVR (DS/cm^5) \times BSA (m^2)$
pulmonary vascular resistance	PVR	$DS/cm^5$	$PVR (DS/cm^5) = 79.96 \times [PAMAP (mmHg) - PAWP (mmHg)]/C.O. (L/min)$
pulmonary vascular resistance index	PVRI	$DS \cdot m^2/cm^5$	$PVRI (DS \cdot m^2/cm^5) = PVR (DS/cm^5) \times BSA (m^2)$
left cardiac work	LCW	$kg \cdot m$	$LCW (kg \cdot m) = 0.0136 \times PAMAP (mmHg) \times C.O. (L/min)$
left cardiac work index	LCWI	$kg \cdot m/m^2$	$LCWI (kg \cdot m/m^2) = LCW (kg \cdot m)/BSA (m^2)$
left ventricular stroke work	LVSW	$g \cdot m$	$LVSW (g \cdot m) = 0.0136 \times PAMAP (mmHg) \times SV (ml)$
left ventricular stroke work index	LVSWI	$g \cdot m/m^2$	$LVSWI (g \cdot m/m^2) = LVSW (g \cdot m)/BSA (m^2)$
right cardiac work	RCW	$kg \cdot m$	$RCW (kg \cdot m) = 0.0136 \times PAMAP (mmHg) \times C.O. (L/min)$
right cardiac work index	RCWI	$kg \cdot m/m^2$	$RCWI (kg \cdot m/m^2) = RCW (kg \cdot m)/BSA (m^2)$
right ventricular stroke work	RVSW	$g \cdot m$	$RVSW (g \cdot m) = 0.0136 \times PAMAP (mmHg) \times SV (ml)$
right ventricular stroke work index	RVSWI	$g \cdot m/m^2$	$RVSWI (g \cdot m/m^2) = RVSW (g \cdot m)/BSA (m^2)$
ejection fraction	EF	%	$EF (\%) = 100 \times SV (ml)/EDV (ml)$
End-diastolic volume index	EDVI	$ml/m^2$	$EDVI (ml/m^2) = EDV (ml)/BSA (m^2)$
End-systolic Volume	ESV	ml	$ESV (ml) = EDV (ml) - SV (ml)$
End-systolic Volume index	ESVI	$ml/m^2$	$ESVI (ml/m^2) = ESV (ml)/BSA (m^2)$

## 11.6 Oxygenation Calculations

On the oxygenation calculation page, you can perform oxygenation calculation, view and print the calculation result.

### 11.6.1 Performing Oxygenation Calculations

To perform oxygenation calculations, follow this procedure.

1. Select the  button in the upper left corner of the calculation screen.
2. From the drop-down list, select **Oxygenation** to access the oxygenation calculation page.
3. Enter values. For a patient who is being monitored, the currently measured values are automatically populated.
4. Select **Calculate**.

The calculated value greater than the normal upper limit is indicated by an up arrow "↑". The calculated value lower than the normal lower limit is indicated by a down arrow "↓".

On the oxygenation calculation page, you can also perform the following operations:

- Select **OxyCont Unit**, **Hb Unit**, and **Pressure Unit**. Then corresponding parameter values will be automatically converted and updated accordingly.
- Select **Range** to show the normal range of each parameter.
- Select **Range**, and then the **Range** button changes to **Unit**. Select **Unit** to show the unit of each parameter.

## 11.6.2 Viewing Oxygenation Calculation Results

Upon completion of oxygenation calculation, the most recent 100 calculation results are stored in the CMS automatically. The calculation time is displayed on the left of the oxygenation calculation page. You can select the desired calculation time to view corresponding calculation result.

## 11.6.3 Printing Oxygenation Calculation Results

Select the  button in the upper right corner of the oxygenation calculation page to print the calculation result.

## 11.6.4 Input Parameters for Oxygenation Calculations

Input Parameter	Label	Unit
cardiac output	C.O.	L/min
percentage fraction of inspired oxygen	FiO <sub>2</sub>	%
partial pressure of oxygen in the arteries	PaO <sub>2</sub>	mmHg, kPa
partial pressure of carbon dioxide in the arteries	PaCO <sub>2</sub>	mmHg, kPa
arterial oxygen saturation	SaO <sub>2</sub>	%
partial pressure of oxygen in venous blood	PvO <sub>2</sub>	mmHg, kPa
venous oxygen saturation	SvO <sub>2</sub>	%
hemoglobin	Hb	g/L, g/dl, mmol/L
respiratory quotient	RQ	None
atmospheric pressure	ATMP	mmHg, kPa
height	Height	cm, inch
weight	Weight	kg, lb

## 11.6.5 Calculated Parameters and Formulas for Oxygenation Calculations

Calculated Parameters	Label	Unit	Formula
body surface area	BSA	m <sup>2</sup>	$BSA (m^2) = Wt^{0.425} (kg) \times Ht^{0.725} (cm) \times 0.007184$
oxygen consumption	VO <sub>2</sub>	ml/min	$VO_2 (ml/min) = C(a-v)O_2 (ml/L) \times C.O. (L/min)$
arterial oxygen content	CaO <sub>2</sub>	ml/L, ml/dL	$CaO_2 (ml/L) = 10 \times (0.0134 \times Hb (g/dl) \times SaO_2 (\%) + 0.031 \times PaO_2 (mmHg))$
venous oxygen content	CvO <sub>2</sub>	ml/L, ml/dL	$CvO_2 (ml/L) = 10 \times (0.0134 \times Hb (g/dl) \times SvO_2 (\%) + 0.031 \times PvO_2 (mmHg))$
arteriovenous oxygen content difference	C(a-v)O <sub>2</sub>	ml/L, ml/dl	$C(a-v)O_2 (ml/L) = CaO_2 (ml/L) - CvO_2 (ml/L)$
oxygen extraction ratio	O <sub>2</sub> ER	%	$O_2ER (\%) = 100 \times C(a-v)O_2 (ml/L) / CaO_2 (ml/L)$
oxygen transport	DO <sub>2</sub>	ml/min	$DO_2 (ml/min) = C.O. (L/min) \times CaO_2 (ml/L)$
partial pressure of oxygen in the alveoli	PAO <sub>2</sub>	mmHg, kPa	$PAO_2 (mmHg) = [ATMP (mmHg) - 47 mmHg] \times FiO_2 (\%) / 100 - PaCO_2 (mmHg) \times [FiO_2 (\%) / 100 + (1 - FiO_2 (\%) / 100) / RQ]$
alveolar-arterial oxygen difference	AaDO <sub>2</sub>	mmHg, kPa	$AaDO_2 (mmHg) = PAO_2 (mmHg) - PaO_2 (mmHg)$

Calculated Parameters	Label	Unit	Formula
capillary oxygen content	CcO <sub>2</sub>	ml/L, ml/dl	CcO <sub>2</sub> (ml/L) = Hb (g/L) × 1.34 + 0.031 × PAO <sub>2</sub> (mmHg)
venous admixture	QS/QT	%	QS/QT (%) = 100 × [1.34 × Hb (g/L) × (1 - SaO <sub>2</sub> (%)/100) + 0.031 × (PAO <sub>2</sub> (mmHg) - PaO <sub>2</sub> (mmHg))] / [1.34 × Hb (g/L) × (1 - SvO <sub>2</sub> (%)/100) + 0.031 × (PAO <sub>2</sub> (mmHg) - PvO <sub>2</sub> (mmHg))]
oxygen transport index	DO <sub>2</sub> I	ml/min/m <sup>2</sup>	DO <sub>2</sub> I (ml/min/m <sup>2</sup> ) = CaO <sub>2</sub> (ml/L) × (C.O. (L/min)/BSA (m <sup>2</sup> ))
oxygen consumption	VO <sub>2</sub> I	ml/min/m <sup>2</sup>	VO <sub>2</sub> I (ml/min/m <sup>2</sup> ) = C (a-v) O <sub>2</sub> (ml/L) × (C.O. (L/min)/BSA (m <sup>2</sup> ))

## 11.7 Ventilation Calculations

On the ventilation calculation page, you can perform ventilation calculation, view and print the calculation result.

### 11.7.1 Performing Ventilation Calculations

To perform ventilation calculations, follow this procedure.

1. Select the ▼ button in the upper left corner of the calculation screen.
2. From the drop-down list, select **Ventilation** to access the ventilation calculation page.
3. Enter values. For a patient who is being monitored, the currently measured values are automatically populated.
4. Select **Calculate**.

The calculated value greater than the normal upper limit is indicated by an up arrow “↑”. The calculated value lower than the normal lower limit is indicated by a down arrow “↓”.

On the ventilation calculation page, you can also perform the following operations:

- Select **Pressure Unit**. Then corresponding parameter values will be automatically converted and updated accordingly.
- Select **Range** to show the normal range of each parameter.
- Select **Range**, and then the **Range** button changes to **Unit**. Select **Unit** to show the unit of each parameter.

### 11.7.2 Viewing Ventilation Calculation Results

Upon completion of ventilation calculation, the most recent 100 calculation results are stored in the CMS automatically. The calculation time is displayed on the left of the ventilation calculation page. You can select the desired calculation time to view corresponding calculation result.

### 11.7.3 Printing Ventilation Calculation Results

Select the  button in the upper right corner of the ventilation calculation page to print the calculation result.

### 11.7.4 Input Parameters for Ventilation Calculations

Input Parameter	Label	Unit
percentage fraction of inspired oxygen	FiO <sub>2</sub>	%
respiration rate	RR	rpm
partial pressure of mixed expiratory CO <sub>2</sub>	PeCO <sub>2</sub>	mmHg, kPa

Input Parameter	Label	Unit
partial pressure of carbon dioxide in the arteries	PaCO <sub>2</sub>	mmHg, kPa
partial pressure of oxygen in the arteries	PaO <sub>2</sub>	mmHg, kPa
tidal volume	TV	ml
respiratory quotient	RQ	None
atmospheric pressure	ATMP	mmHg, kPa

## 11.7.5 Calculated Parameters and Formulas for Ventilation Calculations

Calculated Parameters	Label	Unit	Formula
partial pressure of oxygen in the alveoli	PAO <sub>2</sub>	mmHg, kPa	$PAO_2 \text{ (mmHg)} = [ATMP \text{ (mmHg)} - 47 \text{ mmHg}] \times FiO_2 \text{ (\%)/100} - PaCO_2 \text{ (mmHg)} \times [FiO_2 \text{ (\%)/100} + (1 - FiO_2 \text{ (\%)/100})/RQ]$
alveolar-arterial oxygen difference	AaDO <sub>2</sub>	mmHg, kPa	$AaDO_2 \text{ (mmHg)} = PAO_2 \text{ (mmHg)} - PaO_2 \text{ (mmHg)}$
oxygenation ratio	Pa/FiO <sub>2</sub>	mmHg, kPa	$Pa/FiO_2 \text{ (mmHg)} = 100 \times PaO_2 \text{ (mmHg)}/FiO_2 \text{ (\%)}$
arterial to alveolar oxygen ratio	a/AO <sub>2</sub>	%	$a/AO_2 \text{ (\%)} = 100 \times PaO_2 \text{ (mmHg)}/PAO_2 \text{ (mmHg)}$
minute volume	MV	L/min	$MV \text{ (L/min)} = [TV \text{ (ml)} \times RR \text{ (rpm)}]/1000$
volume of physiological dead space	Vd	ml	$Vd \text{ (ml)} = TV \text{ (ml)} \times [1 - PeCO_2 \text{ (mmHg)}/PaCO_2 \text{ (mmHg)}]$
physiologic dead space in percent of tidal volume	Vd/Vt	%	$Vd/Vt \text{ (\%)} = 100 \times Vd \text{ (ml)}/TV \text{ (ml)}$
alveolar volume	VA	L/min	$VA \text{ (L/min)} = [TV \text{ (ml)} - Vd \text{ (ml)}] \times RR \text{ (rpm)}/1000$

## 11.8 Renal Calculations

On the renal calculation page, you can perform renal calculation, view and print the calculation result.

### 11.8.1 Performing Renal Calculations

To perform renal calculations, follow this procedure.

1. Select the ▼ button in the upper left corner of the calculation screen.
2. From the drop-down list, select **Renal** to access the renal calculation page.
3. Enter values.
4. Select **Calculate**.

The calculated value greater than the normal upper limit is indicated by an up arrow “↑”. The calculated value lower than the normal lower limit is indicated by a down arrow “↓”.

On the renal calculation page, you can also perform the following operations:

- Select **Range** to show the normal range of each parameter.
- Select **Range**, and then the **Range** button changes to **Unit**. Select **Unit** to show the unit of each parameter.

## 11.8.2 Viewing Renal Calculation Results

Upon completion of renal calculation, the most recent 100 calculation results are stored in the CMS automatically. The calculation time is displayed on the left of the renal calculation page. You can select the desired calculation time to view corresponding calculation result.

## 11.8.3 Printing Renal Calculation Results

Select the  button in the upper right corner of the renal calculation page to print the calculation result.

## 11.8.4 Calculated Parameters and Formulas for Renal Calculations

Input Parameter	Label	Unit
urine potassium	URK	mmol/L
urinary sodium	URNa	mmol/L
urine	Urine	ml/24 hrs
plasma osmolality	Posm	mOsm/kgH <sub>2</sub> O
urine osmolality	Uosm	mOsm/kgH <sub>2</sub> O
serum sodium	SerNa	mmol/L
creatinine	Cr	μmol/L
urine creatinine	UCr	μmol/L
blood urea nitrogen	BUN	mmol/L
height	Height	cm
weight	Weight	kg

## 11.8.5 Calculated Parameters and Formulas for Renal Calculations

Calculated Parameters	Label	Unit	Formula
urine sodium excretion	URNaEx	mmol/24 hrs	$URNaEx \text{ (mmol/24 hrs)} = \text{Urine (ml/24 hrs)} \times URNa \text{ (mmol/L)} / 1000$
urine potassium excretion	URKEx	mmol/24 hrs	$URKEx \text{ (mmol/24 hrs)} = \text{Urine (ml/24 hrs)} \times URK \text{ (mmol/L)} / 1000$
sodium potassium ratio	Na/K	%	$Na/K \text{ (\%)} = 100 \times URNa \text{ (mmol/L)} / URK \text{ (mmol/L)}$
clearance of sodium	CNa	ml/24 hrs	$CNa \text{ (ml/24 hrs)} = URNa \text{ (mmol/L)} \times \text{Urine (ml/24 hrs)} / SerNa \text{ (mmol/L)}$
creatinine clearance rate	Clcr	ml/min	$Clcr \text{ (ml/min)} = UCr \text{ (}\mu\text{mol/L)} \times \text{Urine (ml/24 hrs)} / [Cr \text{ (}\mu\text{mol/L)} \times (BSA \text{ (m}^2\text{)} / 1.73) \times 1440]$
fractional excretion of sodium	FENa	%	$FENa \text{ (\%)} = 100 \times URNa \text{ (mmol/L)} \times Cr \text{ (}\mu\text{mol/L)} / [SerNa \text{ (mmol/L)} \times UCr \text{ (}\mu\text{mol/L)}]$
osmolar clearance	Cosm	ml/min	$Cosm \text{ (ml/min)} = Uosm \text{ (mOsm/kgH}_2\text{O)} \times \text{Urine (ml/24 hrs)} / (Posm \text{ (mOsm/kgH}_2\text{O)} \times 1440)$
free water clearance	CH <sub>2</sub> O	ml/hr	$CH_2O \text{ (ml/hr)} = \text{Urine (ml/24 hrs)} \times [1 - Uosm \text{ (mOsm/kgH}_2\text{O)} / Posm \text{ (mOsm/kgH}_2\text{O)}] / 24$
urine to plasma osmolality ratio	U/P osm	None	$U/P \text{ osm} = Uosm \text{ (mOsm/kgH}_2\text{O)} / Posm \text{ (mOsm/kgH}_2\text{O)}$

Calculated Parameters	Label	Unit	Formula
blood urea nitrogen creatinine ratio	BUN/Cr*	Mmol/L	$BUN/Cr = 1000 \times BUN \text{ (mmol/L)}/Cr \text{ (}\mu\text{mol/L)}$
urine-serum creatinine ratio	U/Cr	None	$U/Cr \text{ (mmol/L)} = Ucr \text{ (}\mu\text{mol/L)}/Cr \text{ (}\mu\text{mol/L)}$

\*: BUN/Cr is a ratio at mol unit system.

# 12 Paging

---

## 12.1 Overview

The CMS provides a paging interface to integrate a third-party paging system. The paging system acquires patient alarms data from a bedside monitor or a telemetry device and relays it to a paging device such as a pager. The paging feature is optional.

---

### WARNING

- **The third-party paging system may not provide visual or auditory alarm indicators, and a delay within the third-party paging system may occur. Therefore, do not rely exclusively on the paging system. Always pay close attention to the CMS or monitoring devices.**
- 

## 12.2 Accessing the Paging Window

To access the Paging window, follow this procedure:

1. Select the system menu area in the upper left corner of the main screen.
2. From the drop-down list, select the **Paging** option.
3. Enter the password if required and select the **OK** button.

---

### NOTE

- **Access to the Paging window can be password protected. The password is the same as that for accessing other system setup tabs that require a password. For details on how to enable paging password protection, see Section 15.13.6 Setting Authorization.**
- 

## 12.3 Adding a Pager

To add a pager, follow this procedure:

1. In the Paging window, select the **Pager Assignment** tab.
2. Select the **Add a New Pager** button. The **Add a New Pager** dialog box is displayed.
3. In the **Pager Number** text box, enter the desired number. Up to 16 characters can be entered.
4. In the **Pager Assignment** text box, enter the name of the person who will be responsible for the pager or some other identifying information.
5. Select the **OK** button.

---

### NOTE

- **Pager numbers must be unique. If an existing pager number is entered, the message "Pager Number already exists! Please enter a new number." is displayed.**
-

## 12.4 Assigning a Bed to a Pager

An online bed can be assigned to a pager. An online bed refers to a bed that has been already admitted to the CMS. A pager can be manually assigned to a desired bed number. One bed can be assigned to multiple pagers.

### 12.4.1 Assigning an Online Bed to a Pager

To assign an online bed to a pager, follow this procedure:

1. In the Paging window, select the **Pager Assignment** tab.
2. From the **Pager List**, select the  button on the right of the desired pager.
3. Select the **Assign Online Bed** button.
4. From the bed list, select the desired bed.
5. Select the **OK** button. The assigned bed is displayed under the pager.

### 12.4.2 Assigning a Manually Input Bed to a Pager

You can manually enter the desired bed number and assign it to a pager. To do so, follow this procedure:

1. In the Paging window, select the **Pager Assignment** tab.
2. From the **Pager List**, select the  button on the right of the desired pager.
3. Select the **Add Bed Manually** button.
4. In the **Bed No** text box, enter the desired bed number.
5. Select the **OK** button. The assigned bed is displayed under the pager.

## 12.5 Removing a Bed Assignment

To remove an existing bed assignment from a pager, follow this procedure:

1. In the Paging window, select the **Pager Assignment** tab.
2. From the **Pager List**, select a pager. The list of beds is displayed under the pager.
3. Select the bed you wish to remove assignment.
4. Select the  button on the right of the bed.

## 12.6 Editing a Pager

To edit an existing pager number or pager assignment, follow this procedure:

1. In the Paging window, select the **Pager Assignment** tab.
2. From the **Pager List**, select the  button on the right of the desired pager.
3. Select the **Modify** button. The **Modify** dialog box is displayed.
4. Edit the pager information. The **Pager Number** and **Pager Assignment** are required fields.
5. Select the **OK** button.

## 12.7 Removing a Pager

To remove a pager, follow this procedure:

1. In the Paging window, select the **Pager Assignment** tab.
2. From the **Pager List**, select the  button on the right of the desired pager.
3. Select the **Delete** button. The **Are you sure you want to delete this pager and all its assignments?** question dialog box is displayed.
4. Select the **OK** button.



## 12.8 Resending a Failed Page

If an attempt was made to send a page and was unsuccessful, the page will be added to the **Failed Pages** window. The **Failed Pages** window contains a list box that contains failed pages. The list box orders the failed pages chronologically in descending order.

### NOTE

---

- **If the system is reset, all failed pages listed in the Failed Pages window will be removed.**
- 

To resend a failed page, follow this procedure:

1. In the Paging window, select the **Failed Pages** tab.
2. Select a failed page from the list box. If you want to select all the failed pages, select the **Select All** button.
3. Select the **Resend** button. The failed page is resent and the row is removed from the list box if the page was successfully resent. If the page was not successfully resent, a new row will be added to the top of the Failed Pages window list box with an updated date and time stamp.

## 12.9 Generating a Paging Report

To generate a paging report, follow this procedure:

1. In the Paging window, select the **Pager Assignment** tab.
2. Select the  button in the upper right corner of the window.

**This page intentionally left blank.**

# 13 Printing

---

## 13.1 Supported Printers

The CMS can be connected to a printer to output reports on A4 or Letter paper. The printer has a separate power supply. The CMS supports the following printers:

- HP LaserJet 401n
- HP LaserJet M602
- HP LaserJet M605n
- HP LaserJet M608
- PDF printer

### NOTE

- **For more details about the printer, see the document accompanying the printer. With product upgrades, the CMS may support more printers and no prior notice will be given. If you have any doubt about the printer you have purchased, contact Mindray.**
  - **PDF reports can be output by PDFCreator only.**
- 

## 13.2 Starting Printing

You can start a printing task manually or set the printer to start a printing task automatically.

### 13.2.1 Manually Starting Printing

You can manually start printing reports such as summary information, trends data, and calculation results.

#### 13.2.1.1 Printing Summary Reports

When bedside devices are being monitored by the CMS, you can print their summary reports which includes information such as patient information, realtime data, and alarm data.

To print a summary report, follow this procedure.

1. Select the  button in the upper right corner of the main screen.
2. Select **Print Summary**.

#### 13.2.1.2 Printing All Realtime Reports

You can print realtime reports for all the online beds. Reports for beds in standby mode or beds where patients have been discharged cannot be printed.

To print reports for all patients, follow this procedure.

1. Select the  button in the upper right corner of the main screen.
2. Select **Print All Realtime Reports**. The **Print All Realtime Reports** dialog box is displayed.
3. Select **OK**.

#### 13.2.1.3 Printing Review Data

For details on how to print tabular trends, graphic trends, waveform review, waveform segment, event review, 12-lead analysis review, ST segment, and arrhythmia statistics result, see Chapter 10 *Review*.

### 13.2.1.4 Printing Calculation Results

For details on how to print a titration table, hemodynamic calculation result, oxygenation calculation result, ventilation calculation result, and renal calculation result, see Chapter 11 *Calculation*.

### 13.2.1.5 Printing Realtime Waveforms

To print realtime waveforms for a single bedside device, choose one of the following ways:

- Select the bed number and room number area in the upper left corner of the desired patient sector on the multibed screen and then select the **Print** button from the drop-down list.
- On the ViewBed screen, select the **Print** quick key.
- Select the **Print** button in the **Realtime Report** menu on the ViewBed screen. For details on how to access the **Realtime Report** menu, see Section 13.5.2.1 *Setting Realtime Reports in the Report Setup Tab*.
- Select the **Main Menu** quick key from the quick key area on the ViewBed screen → from the **Report** column select **Print**.

### 13.2.1.6 Printing ECG Reports

When ECG monitoring with lead sets other than 3-lead is being performed, you can print corresponding ECG reports by following the procedure below.

1. Access the ViewBed screen in either of the following ways:
  - ◆ Select the parameter area or waveform area in the desired patient sector on the multibed screen to access the ViewBed screen.
  - ◆ Select the ViewBed symbol  when it is displayed in the desired patient sector on the multibed screen.
2. Access the ECG full screen in one of the following ways:
  - ◆ On the ViewBed screen, select the **ECG Full-Screen** quick key.
  - ◆ On the ViewBed screen, select the **Screen Setup** quick key → select the **ViewBed** tab → select the **Choose Screen** tab → select **ECG Full-Screen**. If you are performing 12-lead ECG monitoring, select the **Choose Screen** tab → select **ECG 12-Lead**.
  - ◆ Select the ECG parameter area or waveform area to access the ECG menu → select the **Full-Screen** button in the lower left corner of the menu. If you are performing 12-lead ECG monitoring, select the 12-Lead.
  - ◆ Select the **Main Menu** quick key from the quick key area on the ViewBed screen → from the **Display** column select **ECG 12-Lead**.
3. Select the print button in either of the following ways:
  - ◆ On the ViewBed screen, select the **Print** quick key.
  - ◆ Select **Print** in the lower right corner of the **ECG Report** menu. For details on how to access this menu, see Section 13.5.2.2 *Setting ECG Reports in the Report Setup Tab*.
  - ◆ Select the **Main Menu** quick key from the quick key area on the ViewBed screen → from the **Report** column select **Print**.
4. Select the bed number and room number area in the upper left corner of the desired patient sector on the multibed screen and then select the **Print** button from the drop-down list.



#### NOTE

- For details on how to set the ECG reports, see Section 13.5.2.2 *Setting ECG Reports in the Report Setup Tab*.

### 13.2.1.7 Printing EEG Reports (BIS Module)



To print EEG reports, follow this procedure:

1. Access the ViewBed screen in either of the following ways:
  - ◆ Select the parameter area or waveform area in the desired patient sector on the multibed screen to access the ViewBed screen.

- ◆ Select the ViewBed symbol  when it is displayed in the desired patient sector on the multibed screen.
2. Access the BIS menu in either of the following ways:
    - ◆ Select a BIS waveform or parameter area.
    - ◆ Select the **Parameters Setup** quick key → select **BIS**.
  3. Select the **BIS Expand** button at the bottom of the menu.
  4. Select the **EEG** tab.
  5. After selecting desired settings, select the  button in the upper left corner. The **Print Setup** menu is displayed.
  6. After selecting desired settings, select **Print**.



### 13.2.1.8 Printing CCO-Related Hemodynamic Parameters

To print CCO-related hemodynamic parameters, follow this procedure:

1. Access the ViewBed screen in either of the following ways:
  - ◆ Select the parameter area or waveform area in the desired patient sector on the multibed screen to access the ViewBed screen.
  - ◆ Select the ViewBed symbol  when it is displayed in the desired patient sector on the multibed screen.
2. Access the CCO menu in either of the following ways:
  - ◆ Select the CCO parameter area.
  - ◆ Select the **Parameters Setup** quick key at the bottom of the screen → select **CCO**.
3. Select the **HemoSight** button at the bottom of the menu.
4. Select the **Diagnosis** tab.
5. Select the  button in the upper left corner. The **Print Setup** menu is displayed.
6. After selecting desired settings, select **Print**.

### 13.2.1.9 Printing ICG-Related Hemodynamic Parameters

To print ICG-related hemodynamic parameters, follow this procedure:

1. Access the ViewBed screen in either of the following ways:
  - ◆ Select the parameter area or waveform area in the desired patient sector on the multibed screen to access the ViewBed screen.
  - ◆ Select the ViewBed symbol  when it is displayed in the desired patient sector on the multibed screen.
2. Access the ICG menu in either of the following ways:
  - ◆ Select the ICG waveform or parameter area.
  - ◆ Select the **Parameters Setup** quick key at the bottom of the screen → select **ICG**.
3. After selecting desired settings, select the **Hemodynamic Parameters** button at the bottom of the menu.
4. Select the  button in the upper left corner. The **Print Setup** menu is displayed.
5. After selecting desired settings, select **Print**.

### 13.2.1.10 Printing SvO<sub>2</sub>/ScvO<sub>2</sub>-Related Hemodynamic Parameters

To print SvO<sub>2</sub>/ScvO<sub>2</sub>-related hemodynamic parameters, follow this procedure:

1. Access the ViewBed screen in either of the following ways:
  - ◆ Select the parameter area or waveform area in the desired patient sector on the multibed screen to access the ViewBed screen.
  - ◆ Select the ViewBed symbol  when it is displayed in the desired patient sector on the multibed screen.
2. Access the SvO<sub>2</sub> or ScvO<sub>2</sub> menu in either of the following ways:



- ◆ Select the SvO<sub>2</sub> or ScvO<sub>2</sub> parameter area.
  - ◆ Select the **Parameters Setup** quick key at the bottom of the screen → select **ScvO2/SvO2**.
3. Select the **HemoSight** button at the bottom of the menu.
  4. Select the **Diagnosis** tab.
  5. Select the  button in the upper left corner. The **Print Setup** menu is displayed.
  6. After selecting desired settings, select **Print**.

### 13.2.1.11 Printing QT Reports

You can print QT reports at the CMS under the following conditions:



- When a bedside monitor supports printing QT reports via the CMS and is performing QT analysis.
- When a telemetry device is performing QT analysis at the CMS.

To print a QT report, follow this procedure:

1. Access the ViewBed screen in either of the following ways:
  - ◆ Select the parameter area or waveform area in the desired patient sector on the multibed screen to access the ViewBed screen.
  - ◆ Select the ViewBed symbol  when it is displayed in the desired patient sector on the multibed screen.
2. Access **QT View** in one of the following ways:
  - ◆ Select the QT parameter area to access the QT menu → select the **QT View** button at the bottom of the menu.
  - ◆ Select the ECG waveform or parameter area to access the **ECG** menu → select the **QT** tab → select the **QT View** button at the bottom of the menu.
  - ◆ Select the **Parameters Setup** quick key at the bottom of the screen → select **ECG** → select the **QT** tab → select the **QT View** button at the bottom of the menu.
3. Select the  button in the upper left corner. The **Print Setup** menu is displayed.
4. After selecting desired settings, select **Print**.

### 13.2.1.12 Printing ST View

The ST View shows a complete QRS segment for each ST lead. To print ST View, follow this procedure:



1. Access the ViewBed screen in either of the following ways:
  - ◆ Select the parameter area or waveform area in the desired patient sector on the multibed screen to access the ViewBed screen.
  - ◆ Select the ViewBed symbol  when it is displayed in the desired patient sector on the multibed screen.
2. Access **ST View** in one of the following ways:
  - ◆ Select ST segment waveform area.
  - ◆ Select the ST parameter area to access the **ST** menu → select the **ST View** button at the bottom of the menu.
  - ◆ Select the ECG waveform or parameter area to access the **ECG** menu → select the **ST** tab → select the **ST View** button at the bottom of the menu.
3. Select the  button in the upper left corner. The **Print Setup** menu is displayed.
4. After selecting desired settings, select **Print**.

### 13.2.1.13 Printing Frozen Waveforms

For details on how to print frozen waveforms, see Section 7.4.5.3 *Printing Frozen Waveforms*.

### 13.2.1.14 Printing Alarm Setup

To print alarm setup, follow this procedure:

1. Access the ViewBed screen in either of the following ways:
  - ◆ Select the parameter area or waveform area in the desired patient sector on the multibed screen to access the ViewBed screen.
  - ◆ Select the ViewBed symbol  when it is displayed in the desired patient sector on the multibed screen.
2. Select the **Alarm Setup** quick key at the bottom of the screen.
3. After selecting the desired settings, select the  button in the upper left corner. The **Print Setup** menu is displayed.
4. After selecting desired settings, select **Print**.

### 13.2.1.15 Printing Paging Assignment Reports

For details on how to print a paging assignment report, see Section 12.9 *Generating a Paging Report*.

## 13.2.2 Automatically Starting Printing

You can set a printer to start printing reports automatically.

### 13.2.2.1 Setting Scheduled Printing

You can set scheduled printing of reports. For details, see Section 13.5.3 *Setting End Case Reports* and 15.10.3 *Setting Scheduled Reports*.

### 13.2.2.2 Enabling Print on Alarm

When a parameter alarm switch is set to on and an alarm is triggered for this parameter, you can set a printer to start alarm printing automatically.

To enable automatic printing via the printer when an alarm is triggered, make sure that **Print on Alarm** is set to **Printer**. For detail, refer to 15.10.9 *Setting Other Print-Related Items*.

To enable the printer to automatically start printing on alarm, follow this procedure:

1. Access alarm setup related tabs in one of the following ways:
  - ◆ Select the **Alarm Setup** quick key at the bottom of the screen.
  - ◆ Select the parameter or waveform area of the desired parameter → select an alarm related tab.
  - ◆ Select the **Parameters Setup** quick key at the bottom of the screen → select the desired parameter → select an alarm related tab.
2. Set Alarm Outputs for a parameter to **Print** or **All**.
  - ◆ **Print**: prints the configured length of waveform data for the parameter automatically. For information on how to configure the waveform printing length, see Section 15.4.4 *Configuring Other Alarm-Related Items*.
  - ◆ **All**: prints the configured length of waveform data for the parameter automatically and sends the alarm message to corresponding paging device.

## 13.3 Stopping Printing

To stop a printing task, follow this procedure:

1. Select the  button in the upper right corner of the CMS main screen.
2. Select **Print Queue**.
3. Select one printing task and then select **Delete** to stop this printing task; select all the printing tasks and then select **Delete All** to stop all the printing tasks.

## 13.4 Viewing Printer Statuses

You can view the status of the most recent printing tasks in the **Print Queue** window. To view the status of printing tasks, follow this procedure:

1. Select the  button in the upper right corner of the CMS main screen.
2. Select **Print Queue**.

## 13.5 Configuring Reports

You can configure report related contents such as patient information items on a report. For details, see Section 15.10 *Print Settings*. This section only describes how to set realtime reports, ECG report, and end case reports for a single bedside device in the **Print Setup** menu.

### 13.5.1 Accessing the Print Setup Menu

To access the **Print Setup** menu, follow this procedure:

1. Access the ViewBed screen in either of the following ways:
  - ◆ Select the parameter area or waveform area in the desired patient sector on the multibed screen to access the ViewBed screen.
  - ◆ Select the ViewBed symbol  when it is displayed in the desired patient sector on the multibed screen.
2. Access **Print Setup** menu in either of the following ways:
  - ◆ Select the **Print Setup** quick key at the bottom of the screen to enter the **Print Setup** menu. If this quick key is not available, configure it by following steps in 7.3.2 *Configuring Quick Keys*.
  - ◆ Select the **Main Menu** quick key at the bottom of the screen → from the **Report** column select **Print Setup**.

### 13.5.2 Setting Realtime Reports and ECG Reports

In the **Report Setup** tab, you can set realtime reports and ECG reports.

#### 13.5.2.1 Setting Realtime Reports in the Report Setup Tab

To set realtime reports, follow this procedure:

1. In the **Print Setup** menu, select the **Report Setup** tab.
2. Select the **Realtime Report** tab.
3. Set **Speed**.
4. Select waveforms to be printed.
  - ◆ **Current Waveforms**: print the realtime report for current waveforms.
  - ◆ **Selected Waveforms**: print the realtime report for the selected waveforms. If you wish to select this option, you need to further select **Select Waveform** and select the desired waveforms in the **Select Waveform** menu.

#### 13.5.2.2 Setting ECG Reports in the Report Setup Tab

When ECG monitoring with lead sets other than 3-lead is being performed, you can set ECG reports.

To do so, follow this procedure:

1. In the **Print Setup** menu, select the **Report Setup** tab.
2. Select the **ECG Report** tab.
3. Set the desired options. Only items that may need special remarks are described here.



Menu item	Description	Options	Default
Auto Interval	Defines the spacing between the ECG waveforms on a printout	<b>On:</b> automatically adjusts the space between waveforms to avoid overlapping. <b>Off:</b> each waveform area has the same size on a printout.	Off
Note: This setting is only relevant when <b>12x1</b> is selected for <b>12-Lead Format</b> .			
12-Lead Format	Select the format of 12-lead ECG waveforms on a printout.	<b>12x1:</b> displays 12-lead ECG waveforms on one page in one column. <b>6x2:</b> displays 12-lead ECG waveforms on one page in two columns, with 6 lines in each column. <b>6x2+1:</b> displays 12-lead ECG waveforms on one page in two columns, with 6 lines in each column, and one rhythm lead waveform at the bottom. <b>3x4+1:</b> displays 12-lead ECG waveforms on one page in 4 columns, with 3 lines in each column, and one rhythm lead waveform at the bottom. <b>3x4+3:</b> displays 12-lead ECG waveforms on one page in 4 columns, with 3 lines in each column, and three rhythm lead waveforms at the bottom.	3x4+1
Rhythm Lead 1 Rhythm Lead 2 Rhythm Lead 3	Select the lead that will be used as Rhythm Lead 1, 2, or 3.	I, II, III, aVR, aVL, aVF, V1, V2, V3, V4, V5, V6	Rhythm Lead 1: II Rhythm Lead 2: V2 Rhythm Lead 3: V5,
Note: This setting is only relevant when <b>6x2+1, 3x4+1, or 3x4+3</b> is selected for <b>12-Lead Format</b> .			
Format Sequence	Select the recording method of ECG report generated by auto measurement	<b>Sequential:</b> 12-lead ECG data are recorded sequentially and displayed in 3 lines and 4 columns with 2.5 seconds of ECG data for each column. <b>Simultaneous:</b> Record simultaneous 12-lead ECG data.	Sequential

### 13.5.3 Setting End Case Reports

When you discharge a patient, if you select **Print End Case Report**, the selected end case reports in the **System Setup** menu will be printed automatically. But the report contents for each bed are configured in the **End Case Report** tab.

For more information regarding the system setup menu, see Section 15.10.4 *Setting End Case Reports*.

#### 13.5.3.1 Setting Tabular Trends Reports in the End Case Report Tab

To set tabular trends reports as end case reports, follow this procedure:

1. In the **Print Setup** menu, select the **End Case Report** tab.
2. Select the **Tabular Trends Report** tab.
3. Set the desired options. Only items that may need special remarks are described here.

Menu Item	Description	Options	Default
Interval	Select the resolution of the tabular trends printed on a report.	1 min, 5 min, 10 min, 15 min, 30 min, 1 hr, 2 hrs, 3 hrs, NIBP, TempIF, C.O. Parameters, such as <b>NIBP,Temp</b> : prints a tabular trends report when parameter measurements are acquired.	30 min
Report Format	Select the printing principle.	<b>Parameter Oriented</b> : prints a report with parameters listed by row and time listed by column. <b>Time Oriented</b> : prints a report with time listed by row and parameter listed by column.	Parameter Oriented
Trend Group	Select the trend option whose data you wish to be displayed on a printout.	All, Standard, Hemo, Cardiac, Pulmonary, RM, Neuro, Gases, Custom 1, Custom 2	Standard

### 13.5.3.2 Setting Graphic Trends Reports in the End Case Report Tab

To set graphic trends reports as end case reports, follow this procedure:

1. In the **Print Setup** menu, select the **End Case Report** tab.
2. Select the **Graphic Trends Report** tab.
3. Set **Trend Group**.

### 13.5.3.3 Setting Event Reports in the End Case Report Tab

To set event reports as end case reports, follow this procedure:

1. In the **Print Setup** menu, select the **End Case Report** tab.
2. Select the **Event Report** tab.
3. Select the desired event type.

### 13.5.3.4 Setting 12-Lead Interpretation Reports in the End Case Report Tab

To set 12-lead interpretation report as end case reports, follow this procedure:

1. In the **Print Setup** menu, select the **End Case Report** tab.
2. Select the **12-Lead Interpretation** tab.
3. Set the desired options. For details on how to set the options, see Step 3 of Section 13.5.2.2 *Setting ECG Reports in the Report Setup Tab*.

### 13.5.3.5 Setting Realtime Reports in the End Case Report Tab

To set realtime reports as end case reports, follow this procedure:

1. In the **Print Setup** menu, select the **End Case Report** tab.
2. Select the **Realtime Report** tab.
3. Set the desired options. For details on how to set the options, see Step 3 and Step 4 of Section 13.5.2.1 *Setting Realtime Reports in the Report Setup Tab*.

### 13.5.3.6 Setting ECG Reports in the End Case Report Tab

To set ECG reports as end case reports, follow this procedure:

1. In the **Print Setup** menu, select the **End Case Report** tab.
2. Select the **ECG Report** tab.
3. Set the desired options. For details on how to set the options, see Step 3 of Section 13.5.2.2 *Setting ECG Reports in the Report Setup Tab*.

## 13.5.4 Setting Scheduled Reports

You set scheduled printing of reports in the **Print Setup** menu only when **Scheduled Report Switch** is enabled in the **System Setup** menu.

In the **Scheduled Report** tab, you can configure report contents for each bed.

To set scheduled printing of reports, follow this procedure:

1. In the **Print Setup** menu, select the **Scheduled Report** tab.
2. Select the desired report tab.
3. Configure the report options.
  - ◆ For description of options in the **Tabular Trends Report** tab, see Section 13.5.3.1 *Setting Tabular Trends Reports in the End Case Report Tab*.
  - ◆ For description of options in the **Graphic Trends Report** tab, see Section 13.5.3.2 *Setting Graphic Trends Reports in the End Case Report Tab*.
  - ◆ In the **Event Report** tab, select the desired event type.
  - ◆ For description of options in the **12-Lead Interpretation** tab, see Section 13.5.2.2 *Setting ECG Reports in the Report Setup Tab*.
  - ◆ For description of options in the **Realtime Report** tab, see Section 13.5.2.1 *Setting Realtime Reports in the Report Setup Tab*.

### NOTE

---

- **Up to 11 pages of event reports can be printed.**
- 

## 13.6 Printer Out of Paper

When the printer runs out of paper, the print request will not be acknowledged. If there are too many print jobs that are not acknowledged a printer error may occur. In this case, install paper and then re-send the print request. Restart the printer if necessary.

To avoid a printer error condition, ensure that there is enough paper in the printer before sending a print request.

**This page intentionally left blank.**

# 14 Recording

## 14.1 Supported Recorders

The CMS can be equipped with to a thermal recorder. Supported recorders are TR6. The thermal recorder records patient information, measurement numerics and waveforms. The thermal recorder has a separate power supply. It can be connected to the CMS via a RS232 serial port.

### WARNING

- **Verify that the recorder can function properly before actually using it. Contact professional personnel for any problem.**

The TR6 recorder is as follows:

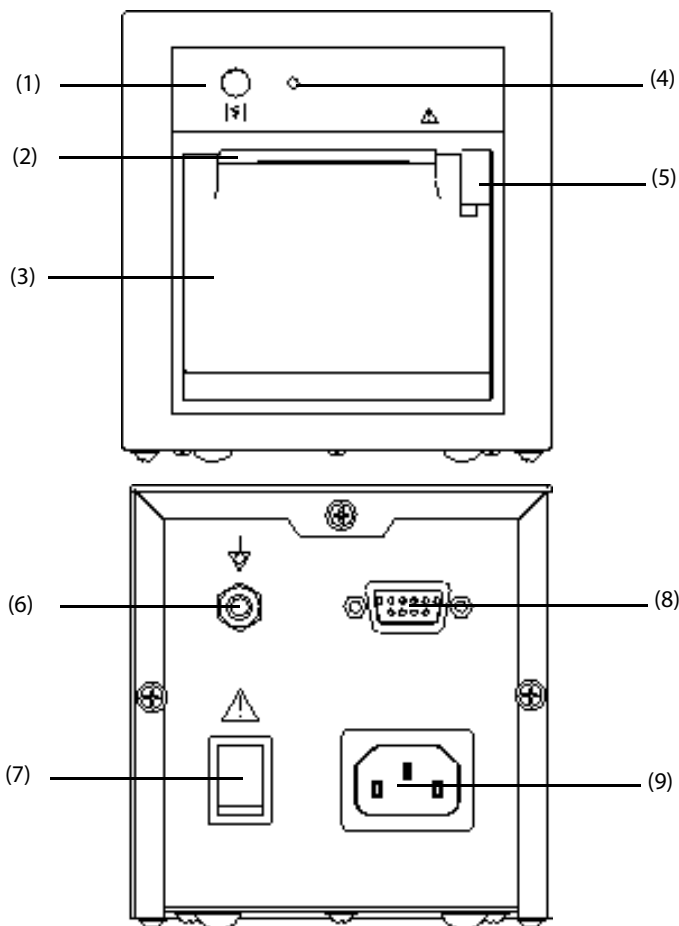

- (1)  hardkey
- (2) Paper outlet
- (3) Recorder door
- (4) Power indicator
  - On: when the recorder works correctly.
  - Off: when the recorder is powered off.
  - Flashes: if an error occurred to the recorder.
- (5) Latch: pull it outwards to open the recorder door.

- |                                      |                  |
|--------------------------------------|------------------|
| (6) Equipotential Grounding Terminal | (7) Power switch |
| (8) RS232 serial port                | (9) Power input  |

## NOTE

- When connected to the CMS, pressing the  hardkey on the front panel of the TR6 recorder cannot start a recording, but can manually stop a recording.

## 14.2 Loading Paper

### WARNING

- Use the standard (50mm) thermal recorder paper for the recording. Otherwise, the recording may be in poor quality, unusable, or the thermal printer head may become damaged.
- Be careful to avoid damaging the thermal printer head when loading the paper. Never pull the paper bail at the upper left corner of the recorder except if you plan to replace the recorder paper or resolve an issue.

To load paper for the TR6 recorder, follow this procedure:

- Use the latch at the upper right of the recorder door to pull the door open.

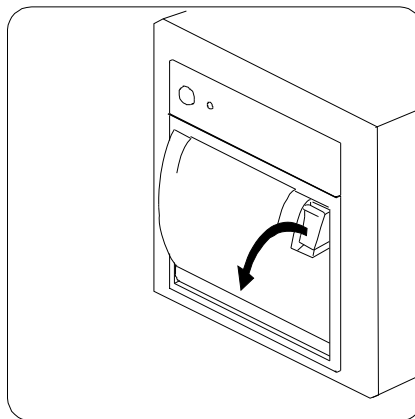

- Insert a new roll into the compartment as shown below. Feed the paper through and pull some paper out from the top of the roller.

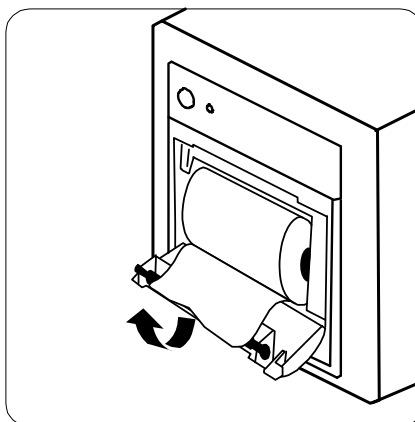

- Close the recorder door.
- Check if paper is loaded correctly and the paper end is feeding from the top.

## 14.3 Setting the Recorder

To set the recorder, follow this procedure:

1. Enter the record setup menu in either of the following ways:
  - ◆ Select the **Record Setup** quick key at the bottom of the ViewBed screen to enter the **Record Setup** menu. Select the **Main Menu** quick key at the bottom of the ViewBed screen → from the **Report** column select **Record Setup**.
2. Select the desired waveform for **Waveform 1**, **Waveform 2** and **Waveform 3** in turn. The recorder can record up to 3 waveforms at a time.

For more information on setting the recorder, see Section 15.10.8 *Setting the Recorder* and Section 15.10.9 *Setting Other Print-Related Items*.

## 14.4 Starting Recordings

You can start a recording task manually or set the recorder to start a recording task automatically.

### 14.4.1 Manually Starting Recordings

You can manually start a recording task, such as the recording for realtime waveforms, event and waveform reviews by selecting the  button.

#### 14.4.1.1 Recording Realtime Waveforms

To manually start recording realtime waveforms for a single bedside device, follow this procedure:

1. Access the ViewBed screen in either of the following ways:
  - ◆ Select the parameter area or waveform area in the desired patient sector on the multibed screen to access the ViewBed screen.
  - ◆ Select the ViewBed symbol  when it is displayed in the desired patient sector on the multibed screen.
2. Select the desired quick key at the bottom of the ViewBed screen to start a recording task.
  - ◆ Select the **Record** quick key.
  - ◆ Select the **Record Setup** quick key → select **Record**.
  - ◆ Select the **Main Menu** quick key → from the **Report** column select **Record**.

#### 14.4.1.2 Recording Event and Waveform Reviews

You can manually start the recording task on the full disclosure review screen and the events review screen. For details, see Section 10.8.6 *Recording Detailed Waveforms* and Section 10.9.5 *Recording Event Detail*.

#### 14.4.1.3 Recording All Realtime Reports

You can record realtime reports for all the online beds. Reports for beds in standby mode or beds where patients have been discharged cannot be printed.

To record reports for all patients, follow this procedure.

1. Select the  button in the upper right corner of the main screen.
2. Select **Record All Realtime Reports**. The **Record All Realtime Reports** dialog box is displayed.
3. Select **OK**.

## 14.4.2 Automatically Starting Recordings

You can set the recorder to start the recording task automatically.

### 14.4.2.1 Enabling Scheduled Recording

To enable scheduled recordings, follow this procedure:

1. Enter the record setup menu in either of the following ways:
  - ◆ Select the **Record Setup** quick key at the bottom of the ViewBed screen to enter the **Record Setup** menu.
  - ◆ Select the **Main Menu** quick key at the bottom of the ViewBed screen → from the **Report** column select **Record Setup**.
2. Set **Interval**. The recorder can automatically starts the recording task at the configured interval.

### 14.4.2.2 Setting Recording on Alarm

When a parameter alarm switch is set to on and an alarm is triggered for this parameter, you can set the recorder to start alarm recording automatically.

**Print on Alarm** is set to **Printer** by default. To enable automatic recording via the recorder when an alarm is triggered, make sure that **Print on Alarm** is set to **Recorder**. For detail, refer to *15.10.9 Setting Other Print-Related Items*.

To set the recorder to automatically start recording on alarm, follow this procedure:



1. Access alarm setup related tabs in one of the following ways:
  - ◆ Select the **Alarm Setup** quick key at the bottom of the screen.
  - ◆ Select the parameter or waveform area of the desired parameter → select an alarm related tab.
  - ◆ Select the **Parameters Setup** quick key at the bottom of the screen → select the desired parameter → select an alarm related tab.
2. Set **Alarm Outputs** for a parameter to **Print** or **All**.
  - ◆ **Print**: records the configured length of waveform data for the parameter automatically. For information on how to configure the waveform printing length, see Section *15.4.4 Configuring Other Alarm-Related Items*.
  - ◆ **All**: records the configured length of waveform data for the parameter automatically and sends the alarm message to corresponding paging device.

## 14.5 Stopping Recordings

Recordings can be stopped manually or automatically.

### 14.5.1 Manually Stopping Recordings

To manually stop a recording, choose one of the following ways:

- Select the  button in the upper right corner of the main screen → select **Clear All Record Tasks**
- Access the **Record Setup** menu → select **Clear All Record Tasks**.
- Select the **Main Menu** quick key at the bottom of the ViewBed screen → from the **Report** column select **Record Setup** → select **Clear All Record Tasks**.
- Access the **System Setup** menu → select the **General** setup page → select the **Recorder** tab → select **Reset RecordService**.
- Access the **System Setup** menu → select the **Print** setup page → select the **Recorder** tab → select **Reset RecordService**.
- Press the  hardkey on the front panel of the recorder.

### 14.5.2 Automatically Stopping Recordings

Recordings stop automatically when:

- A recording is completed.
- The recorder runs out of paper.
- The recorder has an alarm condition.



# 15 System Setup

---

## 15.1 System Setup Overview

The CMS comes with factory defaults. You can make changes to the configuration items to accommodate the needs of your unit. Changes made to the CentralStation, the WorkStation, and the ViewStation are independent of each other. The configuration items apply to the CentralStation, the WorkStation and the ViewStation if no special explanations.

---

### WARNING

---

- **Changing configuration items may alter the way the CMS performs when monitoring patients. Do not change anything unless you are aware of the possible consequences, especially if you are monitoring a patient while in clinical settings.**
- 

### NOTE

---

- **Many settings in the CentralStation, the WorkStation, and the ViewStation are password protected. It is recommended to change the default passwords and keep the passwords safe. Passwords should only be changed by authorized personnel. Contact your department manager or biomedical engineering department for the passwords used at your facility.**
- 

## 15.2 General Settings

### 15.2.1 Accessing the General Setup Page

To access the general setup page, follow this procedure:

1. Select the system menu area in the upper left corner of the screen → select **System Setup** to access the **System Setup** menu.
2. Select the **General** tab.

### 15.2.2 Adjusting Alarm Volumes

In the **Volume** tab, you can set the alarm volume, high alarm volume, and reminder volume. For details on how to set the volumes, see Section 8.6.4 *Setting Alarm Volume*.

### 15.2.3 Viewing System Help Information

In the **Help** tab, you can view the system help information such as the system software version, system configuration information, and system status by selecting the **Help** button.

### 15.2.4 Setting the Touchscreen

#### 15.2.4.1 Calibrating the Screen

To calibrate the touchscreen, follow this procedure:

1. On the general setup page, select the **Touch Screen** tab.
2. Set the desired option.
  - ◆ For Elo touchscreen, select **Cal Touchscreen**.
  - ◆ For other types of touchscreens, select **Tablet PC Settings** and select the **Calibrate** button in the popup window.
3. Touch and hold the  symbol areas where indicated.

If the CMS system is configured for multiple touchscreens, perform the steps above for the rest of the touchscreens.

#### 15.2.4.2 Setting the Screen Lock Duration

To set the screen lock duration, follow this procedure:

1. On the general setup page, select the **Touch Screen** tab.
2. Set the desired **Screen Lock Duration**. For details on how to lock the screen, refer to 3.9 *Locking the TouchScreen*.

#### 15.2.5 Resetting the Recorder Service

In the **Recorder** tab, you can select **Reset RecordService** to stop all the current recordings and reset the recording task.

### 15.3 Display Settings

#### 15.3.1 Accessing the Display Setup Page

To access the display setup page, follow this procedure:

1. Select the system menu area in the upper left corner of the screen → select **System Setup** to access the **System Setup** menu.
2. Select the **Display** tab → enter the required password → select the **OK** button.

#### 15.3.2 Setting Parameter Colors

Parameter-related information such as realtime waveforms and parameter numerics are displayed in the same color on the CMS screen.

To set the desired parameter colors, follow this procedure:

1. On the display setup page, select the **Parameter Color** tab.
2. Select the color box on the right side of the desired parameter.
3. From the drop-down list, select the desired color.

#### 15.3.3 Screen Setup

##### 15.3.3.1 Setting Screen Size

To set the screen size, follow this procedure:

1. On the display setup page, select the **Screen** tab.
2. Select **Screen Size** and then select the desired option. If your screen size is not available, select **Others** and select the **+** or **-** button on the rulers to adjust the screen size.
3. Select **OK**.

#### NOTE

- 
- **Restart the system after making a change in the screen size.**
  - **The CentralStation, WorkStation, or ViewStation each can connect up to four displays and will check the number of displays every time it starts. When more than one display is used simultaneously, they should be the same resolution. The displays support two resolutions: 1280 x 1024 pixels and 1920 x 1080 pixels.**
-

### 15.3.3.2 Setting Display Layout

When the CentralStation, the WorkStation, or the ViewStation is equipped with four displays, you can select **Display Layout** and change the cursor moving mode. The display layout selected should be consistent with the appearance of your displays.

To select the display layout, follow this procedure:

1. On the display setup page, select the **Screen** tab.
2. Set **Display Layout**.
  - ◆ **1 x 4**: select this option when four displays are arranged in a line. You can move the cursor from the current display to its neighboring displays, as shown in Figure 11-1.

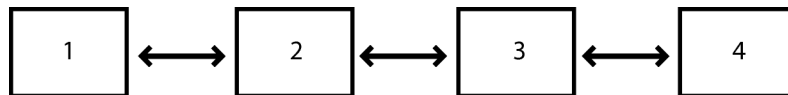

- ◆ **2 x 2**: select this option when two displays are stacked on the other two displays. You can move the cursor from current display to its neighboring displays, as shown in Figure 11-2.

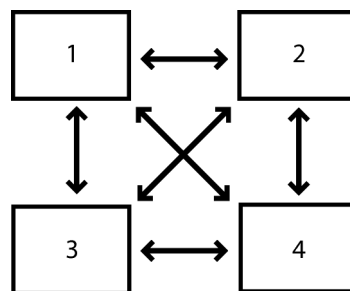

### 15.3.3.3 Enabling Auto Close ViewBed Screen

To enable closing the Viewbed screen automatically and set the desired closing time, follow this procedure:

1. On the display setup page, select the **Screen** tab.
2. Set **Auto Close ViewBed Screen**:
  - ◆ Select **Never**: disable closing the Viewbed screen automatically.
  - ◆ Select a specific time: if you do not perform any operation after accessing the ViewBed screen within the configured time, the CMS automatically closes the ViewBed screen and accesses the multibed screen.

### 15.3.3.4 Setting the Number of Patient Sectors

You can set the desired number of patient sectors on the multibed screen.

To do so, follow this procedure:

1. On the display setup page, select the **Screen** tab.
2. Set **Patient Sector Number**. When you select **customize**, you need to select the desired number of columns and rows. Setting **Patient Sector Number** as **1**, the CMS has only the Viewbed with no multibed, and you can pay close attention to the patient's condition. You can switch to view other patients on the Viewbed, for more information, see 7.7 *Viewing Other Patients*.

### 15.3.3.5 Setting the Number of Primary Screens

The **Primary Screen Number** option is displayed only when more than one display is available. You can select the desired number of displays where the multibed screen is shown.

To set the number of primary screens, follow this procedure:

1. On the display setup page, select the **Screen** tab.
2. Set **Primary Screen Number**. Select the desired number of displays. For example, if you select 3, the multibed screen will be shown on three displays.

### 15.3.3.6 Setting the Position of ViewBed Screen

The **Viewbed Screen Position** option is displayed only when more than one display is available. You can select the desired display where the ViewBed screen is shown.

To set the position of ViewBed screen, follow this procedure:

1. On the display setup page, select the **Screen** tab.
2. Set **Viewbed Screen Position**. Select the desired display number. For example, if you select 2, then the ViewBed screen will be shown on the second display.

### 15.3.3.7 Sharing Viewbed Screen with Other WorkStations

You can display the Viewbed screen of other WorkStations on the current WorkStation. To do so, follow this procedure:

1. On the display setup page, select the **Screen** tab.
2. Enable **Share ViewBed Screen with Other WorkStations**.
3. Select  on the WorkStation list.
4. Select desired WorkStations in the popup dialog. You can select at most four WorkStations.

#### NOTE

- **After enabling Share ViewBed Screen with Other WorkStations on current WorkStation, the Viewbed screen will not display on the selected WorkStations.**

### 15.3.4 Setting Sectors

To set sectors, follow this procedure:

1. On the display setup page, select the **Sector** tab.
2. Set **Sort Type**.
  - ◆ **Manual**: allows manual sorting of sectors according to sorting criteria. When this option is selected, **Sector Sorting** is displayed in the drop-down list of system menu. Select **Sector Sorting**, the CMS sorts the sectors.
  - ◆ **Auto**: sectors are automatically sorted according to sorting criteria.
3. Set sorting criteria: **Sort By** and **Sort Orientation**.
4. Set **Spot Check Beds Sort Type**.
5. Enable or disable **Support Switching Locked Sector**. This option is disabled by default. When it is enabled, the option **Move Position to** is displayed in the drop-down list after selecting the bed number and room number area of locked sectors.
6. Enable or disable **Clear Unlocked Overview Sector After Discharging The Patient**. This option is disabled by default. When it is enabled, if a patient is discharged, the overview bed will be automatically cleared at the current CentralStation, the WorkStation, or the ViewStation.
7. Set **Hide Unused Sectors**:
  - ◆ **Off**: No sector is hidden.
  - ◆ **Entire Row**: The entire row of unused sectors are hidden.
  - ◆ **By Single Sector**: All the unused sectors are hidden.

#### NOTE

- **The Clear Unlocked Overview Sector After Discharging The Patient option takes effect only when the patient sector where the overview bed is located is not locked at the current CentralStation, the WorkStation, or the ViewStation.**

### 15.3.5 Setting Patient Window

You can select the desired items displayed on the review and calculation screens in the patient window. To do so, follow this procedure:

1. On the display setup page, select the **Patient Window** tab.
2. Select the desired items.

### 15.3.6 Setting Other Display Items

Follow this procedure to set other display items:

1. On the display setup page, select the **Other** tab.
2. Set **ECG Lead Sequence**. After changing the ECG lead sequence, the waveform sequence will be updated in the ECG waveform area, ST parameter area, ST View on the ViewBed screen, ECG waveforms on review pages, and printouts.
  - ◆ **Normal:** I, II, III, aVR, aVL, aVF, V1, V2, V3, V4, V5, V6
  - ◆ **Cabrera:** aVL, I, -aVR, II, aVF, III, V1, V2, V3, V4, V5, V6
3. Enable or disable **Soft Keyboard**. When this option is enabled, a soft keyboard displays when a field that requires manual input is selected.

## 15.4 Alarm Settings

### 15.4.1 Accessing the Alarm Setup Page

To access the alarm setup page, follow this procedure:

1. Select the system menu area in the upper left corner of the screen → select **System Setup** to access the **System Setup** menu.
2. Select the **Alarm** tab → enter the required password → select the **OK** button.

### 15.4.2 Configuring Alarm Audio Properties

To configure alarm audio properties, follow this procedure:

1. On the alarm setup page, select the **Audio** tab.
2. Set the desired options. Only items that may need special remarks are described here.
  - ◆ **Minimum Alarm Volume:** ranges from 1 to 10.
  - ◆ **Alarm Sound:** select desired alarm sound. When the alarm sound is set to ISO, ISO2, you can set alarm intervals of different priorities. ISO2 supports special alarm sound. For details on the alarm tone pattern, see *8.2 Understanding the Alarms*.
  - ◆ **Auto Increase Volume: 2 Steps and 1 Step** mean that if an alarm is not reset within the designated delay time after the alarm occurs, the alarm volume automatically increases by two levels or by one level. **Off** means that if an alarm is not reset within the designated delay time after the alarm occurs, the alarm volume does not change.
  - ◆ **Increase Volume Delay:** set the delay time of alarm volume escalation.
  - ◆ **Alarm Reset Reminder:** when this option is enabled, if the alarm volume is set to 0, or the alarm is reset or turned off, the system will issue reminder tones at a designated reminder interval.
  - ◆ **Alarm Off Reminder:** when this option is enabled and alarms for a bedside device are turned off, a reminder tone is issued at the designated reminder interval.
  - ◆ **Reminder Interval:** when **Alarm Reset Reminder** and/or **Alarm Off Reminder** is enabled, you can set the reminder interval.
  - ◆ **Single Bed Alarm Audio Off:** when it is set to **Disable**, you cannot turn off alarm sound of the single bed. When it is set to **Enable**, you can turn off alarm sound for one bed on the alarm setup menu of the bed.
  - ◆ **Resume Alarm Audio When Patient is Admitted:** this option applies to the single bed where the alarm sound if turned off. If this option is enabled, the bed resumes alarm sound when admitting a new patient; if disabled, the alarm sound of the bed remains off when admitting a new patient. This option is applicable for bedside devices admitted via the **Device Assignment** tab in the **System Setup** menu.

- ◆ **Alarm Type with Audio On:** select the type of alarms which will make sound when the corresponding alarm occurs. By default, the CMS provides alarm audio of all types. The selected alarm types are prompted on the system alarm area of the CMS.
- ◆ **Special Advanced Alarm Sound:** select desired alarms. When the alarm sound is set to ISO2, the system gives special alarm sound to indicate that the patient may be in a critical condition when a selected alarm is triggered. For details on special alarm sound pattern, see *8.2.3 Alarm Indicators*.

## NOTE

---

- **The alarm volume escalation function is not applied to the latched alarms.**
  - **The Single Bed Alarm Audio Off functionality is applicable for the CMS only and does not affect alarm sound at the bedside devices. When alarm sound is set to off at the CMS, ensure that medical staff is available around bedside devices and pays close attention to alarm sound enunciated from the bedside devices.**
  - **If your displays include display and power buttons, lock these buttons in case of maloperation which might silence the CMS.**
    - ◆ For Elo displays: press and hold the Up arrow & Menu buttons simultaneously for 10 seconds to lock the display button; press and hold the Up arrow & power buttons simultaneously for 10 seconds to lock the power button.
    - ◆ For HP displays: press and hold the Menu button for 10 seconds to lock the display buttons; press and hold the power button for 10 seconds to lock the power button.
  - **When Alarm Type with Audio On is not set to All, pay close attention to alarm sound enunciated from remote devices.**
- 

### 15.4.3 Setting Paging-Related Alarm Properties

When the CentralStation connects a third-party paging system, you can set paging-related properties.

To set paging properties, follow this procedure.

1. On the alarm setup page, select the **Paging** tab.
2. Set the desired options.
  - ◆ **Paging Delay:** set the paging delay time.
  - ◆ **Paging Demographics:** set the demographic data type sent to a pager.
  - ◆ **Paging Service:** set whether to enable the paging service.
  - ◆ **Support Lead Off Technical Alarm:** set whether to send the lead off technical alarm to a pager.
  - ◆ **Support Communication Message:** set whether to send **Offline** and **No RF Signal** technical alarms to a pager.
  - ◆ **Support Battery Message:** set whether to send battery status related messages to a pager.
  - ◆ **Support Nurse Call:** set whether to send nurse call triggered from a telemetry device to a pager.
  - ◆ **Paging Password Protection:** select whether a password is required to access the Paging window. If you select **No Password**, no password is required to access the Paging window. If you select **Local Password**, you need to enter a password to access the Paging window. The default password is paging.

You can select **Modify Password** to change the password to access the Paging window.

### 15.4.4 Configuring Other Alarm-Related Items

To configure other alarm-related items, follow this procedure:

1. On the alarm setup page, select the **Other** tab.
2. Set the desired options:
  - ◆ **Global Silence Hotkey:** set the hotkey that can be used to silence the system.
  - ◆ **Global Silence:** it is defaulted to **Disable**. When disabled, the global silence feature is not available. When it is set to **Enable**, pressing the silence quick key or selecting the  symbol silences the system.

- ◆ **Offline Alarm Priority:** set the alarm priority when a bedside device, the WorkStation, the ViewStation, or eGateway is disconnected.
- ◆ **Flashing Alarm Bar:** when this option is enabled, the background color of high priority and medium priority alarm messages on the mulitbed and ViewBed screen flashes.
- ◆ **No offline alarm if patient discharged:** when this option is enabled, after the patient is discharged the offline alarm will not be triggered if the monitor is disconnected.
- ◆ **eGateway Communication Lost:** when this option is enabled and eGateway is disconnected from the CentralStation, the eGateway Communication Lost alarm message will be displayed in the system alarm area at the top of the screen. This function is available for the CentralStation only.
- ◆ **Patient ID/Visit Number Conflicts:** when this option is enabled and different beds have the same patient ID or visit number, the alarm information area of the patient sector displays related alarm. This is available only at the CentralStation.

## 15.4.5 Exporting and Analyzing the Alarm Log

### 15.4.5.1 Exporting the Alarm Log

To export the alarm log, follow this procedure:

1. On the alarm setup page, select the **Log** tab.
2. Set **Device Name**. Select the source of alarm log.
3. Select **Export** and then set the location where the log file is saved.
4. Select **OK**.

### 15.4.5.2 Exporting the Alarm Log at a Designated Interval

To export the alarm log at a designated interval at the CentralStation, follow this procedure:

1. On the alarm setup page, select the **Log** tab.
2. Set **Device Name**. Select the source of alarm log.
3. Set **Interval**. The system export the alarm log to the designated file path at the designated interval from now on.
4. Set **File Path** as the storage path for the alarm log.
5. Set **User Name** and **Password** if the storage path has set a user name and password.
6. Select **OK**.

#### NOTE

- **If the storage path is a shared folder, set user name and password for the folder for the sake of security.**
- **When you remotely control CentralStation through WorkStation to set this feature, you need to include host computer name in the user name. For example, the user name for the storage path is *test* and the host computer name of the CentralStation is *MRPC1*, then the User Name should be *MRPC1\test*.**

### 15.4.5.3 Analyzing the Alarm Log

You can use the Mindray Alarm Statistics Tool to analyze the alarm log and create a report. To do so, follow this procedure:

1. Open the Mindray Alarm Statistics Tool.
2. Select the folder symbol under **Source File Path** to find where the log file is saved.
3. Select the folder symbol under **Report File Path** to specify where the report is saved.
4. Set other items as desired.
5. Select **Analyze** to create a report.

## NOTE

---

- You can only export alarm logs for patients that triggered alarms.
  - The statistics reports are Microsoft Excel files. Make sure that you have installed Microsoft excel before using the Mindray Alarm Statistics Tool.
- 

## 15.5 Patient Management Settings

### 15.5.1 Accessing the Patient Management Page

To access the patient management setup page, follow this procedure:

1. Select the system menu area in the upper left corner of the screen → select **System Setup** to access the **System Setup** menu.
2. Select the **Patient Management** tab → enter the required password → select the **OK** button.

### 15.5.2 Configuring Patient Fields

In the **Field** tab, you can set which patient fields can be displayed on the patient management screen.

To configure patient fields, follow this procedure:

1. On the patient management setup page, select the **Field** tab.
2. Select the desired items.
3. If necessary, select the customized fields and input names for these fields.

### 15.5.3 Setting Patient Finding Criteria

In the **Find Patient** tab, you can select the criteria for finding patient.

To set the finding patient criteria, follow this procedure:

1. On the patient management setup page, select the **Find Patient** tab.
2. Select desired **Find Patient** option. Only CentralStation and WorkStation supports this setting.
3. Select the desired **ADT Query** criteria.

### 15.5.4 HIS Patient Synchronization

When the CentralStation is connected with a hospital information system (hereinafter referred to as the HIS), enabling the HIS patient synchronization feature can synchronously admit and discharge the patients on the bedside device. The HIS sync patient feature is disabled by default.

To enable HIS patient synchronization, follow this procedure:

1. Select the system menu area in the upper left corner of the main screen → from the drop-down list select **Patient Management**.
2. Select **HIS Sync Patient** on the patient management screen.
3. Switch on **HIS Admit/Discharge Patient**.

## NOTE

---

- To implement HIS patient synchronization, eGateway is required to use with the CMS and the HIS. For details, refer to *eGateway Integration Manager Installation Guide*.
- 

#### 15.5.4.1 Synchronously Admitting the Patient from HIS

If **HIS Admit/Discharge Patient** is switched on, set **HIS Admit Patient** to select the way patient admitted on the bedside device from HIS.

- **Prompt:** This option is applied to the N series and ePM series monitors. When HIS admits a new patient, a dialog box pops out. Select **Yes** to synchronously admit the patient from HIS to monitors. Select **No** to ignore the prompt and not admit the patient from HIS.



- **Omit:** If the bedside device has already admitted a patient, it doesn't synchronously admit the patient from HIS. If the bedside device has not admitted a patient, it synchronously admit the patient from HIS.
- **Auto Perform:** The bedside device always synchronously admits the patient from HIS.

#### 15.5.4.2 Synchronously Discharging the Patient from HIS

If **HIS Admit/Discharge Patient** is switched on, set **HIS Discharge Patient** to select the way patient discharged on the bedside device from HIS.

- **Prompt:** This option is applied to the N series and ePM series monitors. When HIS discharges a patient, a dialog box pops out. Select **Yes** to synchronously discharge the patient from HIS to monitors. Select **No** to ignore the prompt and not discharge the patient from HIS.
- **Omit:** The bedside device doesn't synchronously discharge the patient from HIS.
- **Auto Perform:** The bedside device always synchronously discharges the patient from HIS.

### 15.5.5 Setting Discharged Patients

To set the **Discharged Patients** tab, follow this procedure:

1. On the patient management setup page, select the **Discharge** tab.
2. Set the time for **Auto Discharge if Network Disconnected**. Patients are discharged if offline time exceeds the set time.
3. Set the time for **Auto Discharge Spot Check Patient**. Spot check patients are discharged if no new spot check data is sent to the CMS during the set time.
4. Enable or disable **Prompt on patient auto deleted**. When it is enabled and discharged patients are to be deleted automatically, a prompt message will be displayed.
5. Set the alarm priority for **Prompt Alarm When Storage Is Nearly Full**.
6. Enable or disable **Include Patient Demographics When Exporting Patient Data**. For details on how to export patient data, refer to *15.7.6 Setting Patient Data Export*.
7. Select **Auto Delete Patient Data if Discharged** to set when patient data is deleted:
  - ◆ **Right Now:** patient data is deleted once the patient is discharged.
  - ◆ **Auto:** patient data is deleted when the storage of the CMS is nearly full.
8. Select **Clear All Patient Data**. Then from the dialog that pops up, confirm whether to clear all patient data.

#### NOTE

- **The discharged patients tab is available at the CentralStation only.**

### 15.5.6 Setting Patient Location

In the **Location** tab, you can set the patient location options displayed on the patient sector and ViewBed screen after a bedside device enters standby mode. This tab is available at the CentralStation Only.

To set a patient location, follow this procedure:

1. On the patient management setup page, select the **Location** tab.
2. Select the desired locations.

### 15.5.7 Setting Patient Group

This tab is available at the CentralStation Only.

To set the patient group, follow this procedure:

1. On the patient management setup page, select the **Patient Group** tab.
2. Select the patient group with desired background color. Only the selected groups are applicable.
3. Select the  button and then enter the desired patient group name.

After setting the patient group, you can group the patients on the patient management screen.

## 15.5.8 Setting Care Groups

This tab is available at the CentralStation and WorkStation.

### 15.5.8.1 Manually Setting Care Groups

To manually set a care group, follow this procedure:

1. On the patient management setup page, select the **Care Group** tab.
2. Set **Care Group Setup Mode** to **Manual**.
3. Select the care group with the desired background color.
4. Select the  button and then enter the desired care group name.





Upon completion of settings, the care groups will be displayed under the **Care Group** field on the patient management screen and you can select the desired care group for a bed.

### 15.5.8.2 Automatically Assigning Care Groups

You can assign care groups to the desired beds. When a patient is newly admitted by a bed, the care group for this bed will be automatically assigned.

You can also add a shift time. When it is time for the shift, care groups will be automatically assigned to beds.

To automatically assign care groups, follow this procedure:

1. On the patient management setup page, select the **Care Group** tab.
2. Set **Care Group Setup Mode** to **Auto**.
3. Select the  button in the upper right corner of the current page. The **Add Shift** window is displayed.
4. Configure items and then select **OK**.
5. Add a bed:
  - ◆ If no beds are available, select the  button in the middle of the current page and then add a bed.
  - ◆ If beds are available, the  button is not displayed. Access the bed list page to add a bed. For information regarding the bed list page, see Section 15.11.5 *Setting the Bed*.
6. Select the  button in the lower right corner of the current page. The **Add Care Group** window is displayed.
7. Configure items and then select **OK**.
8. Select care groups at the bottom of the current page.
9. Select the beds where care groups are assigned to. The background color of the selected beds is consistent with that of care groups.

#### NOTE

- Select the  button on the right of the desired shift or care group to edit or delete a shift or care group.
- When **Care Group Setup Mode** is set to **Auto**, the **Care Group** option on the patient management screen is grayed out.

### 15.5.9 Setting Other Patient Information Items

To set the items, follow this procedure:

1. On the patient management setup page, select the **Other** tab.
2. Set **Display Information in Patient Sector**. The selected items will display in the patient information area of the patient sector; **None** indicates nothing displayed in the patient information area of the patient sector.
3. Set the desired **Patient Name Display Hotkey**. This option applies only when the **Display Information in Patient Sector** is set as **None**. In this case, press the set hotkey, patient name is displayed in the patient information area of the patient sector; press the set hotkey again, nothing displays in the patient information area of the patient sector.

4. Enable or disable **Reset Care Group in the Locked Sector When Admitting a New Patient**. When it is enabled, if **Care Group Setup Mode** is set to **Manual** and a patient is admitted by a locked patient sector, you can manually select a care group for this bed.

## 15.6 Device Management Settings

To access the device management screen, follow this procedure:

1. Select the system menu area in the upper left corner of the screen → select **System Setup** to access the **System Setup** menu.
2. Select the **Device Management** tab → enter the required password → select the **OK** button.

## 15.7 Review Settings

### 15.7.1 Accessing the Review Setup Page

To access the review setup page, follow this procedure:

1. Select the system menu area in the upper left corner of the screen → select **System Setup** to access the **System Setup** menu.
2. Select the **Review** tab → enter the required password → select the **OK** button.

### 15.7.2 Setting Trend Groups

In the **Trends** tab, you can set a trend group. A trend group defines the trend displayed on the trend review page and printed in trend reports and recordings.

#### NOTE

- 
- **In the Group Setup menu, HR is always displayed in the first row. It cannot be deleted or moved.**
- 

#### 15.7.2.1 Setting Trend Parameters

To add, delete, overlap, unoverlap, or move a parameter, follow this procedure:

1. On the review setup page, select the **Trends** tab.
2. Select the **Group Setup** button to enter the **Group Setup** screen.
3. Select the desired tab and then the desired parameter.
4. Select the desired buttons. Only buttons that may need special remarks are described here.
  - ◆ **Overlap:** selecting two parameters in the right column and then selecting the **Overlap** button overlaps these parameters. When parameters are overlapped, the  symbol displays on the right side of overlapped parameters. The numeric values and trend curves of two parameters are displayed in one row on the screen.
  - ◆ **Unoverlap:** after two parameters are overlapped, selecting the **Unoverlap** button cancels the overlapping relation.

#### 15.7.2.2 Selecting Trend Groups to Be Displayed

You can set what trend groups to be displayed in the Trend Group option in the tabular trends and graphic trends reviews. To do so, follow this procedure:

1. On the review setup page, select the **Trends** tab.
2. Select desired options in the **Display Default Trend Group** area.

### 15.7.3 Setting Full Disclosure

In the **Full Disclosure** tab, you can set the waveform saving accuracy. This tab is available at the CentralStation only. If the hard-disk partition is less than 450 G, full disclosure waveforms are saved in low resolution by default.

If the hard-disk partition is greater than or equal to 450 G, full disclosure waveforms are saved in medium resolution by default.

To change the waveform saving accuracy, follow this procedure:

1. On the review setup page, select the **Full Disclosure** tab.
2. Select the desired resolution for **Save Waveform**.

## 15.7.4 Setting Events

In the **Event** tab, you can set the conditions for locking and renaming events. This tab is available at the CentralStation and WorkStation. But you can only enable or disable **Rename Event** at the WorkStation.

To set events, follow this procedure:

1. On the review setup page, select the **Event** tab.
2. In the **Lock** column, select the alarm priority of the events that need to be locked. When alarms of the selected priority are triggered, corresponding events will be locked in the event review page automatically.
3. Enable or disable **Rename Event**. When this option is enabled, you can rename events in the event review page.

## 15.7.5 Setting Arrhythmia Mark Colors

In the **Arrhy Mark** tab, you can set colors for arrhythmia marks that display in the compressed waveform. This tab is available at the CentralStation, the WorkStation, and the ViewStation.

To do so, follow this procedure:

1. On the review setup page, select the **Arrhy Mark** tab.
2. Select the desired arrhythmia category.
3. Select the color box on the right side of the arrhythmia category.
4. From the drop-down list, select the desired color.

## 15.7.6 Setting Patient Data Export

In the **Export** tab, you can set whether to allow exporting patients' trend data and waveform data on the review page or you can directly export patient data. The previous set is available at the CentralStation, the WorkStation, and the ViewStation, while the latter set is available only at the CentralStation.

### 15.7.6.1 Setting Authorization for Exporting Review Data

To set whether to allow exporting patients' trend data and waveform data, follow this procedure:

1. On the review setup page, select the **Export** tab.
2. Enable **Save As**.

Once **Save As** is enabled, you can enter review page to export patients' trend data and waveform data. For details on how to do so, see Sections *10.6.4 Exporting Trend Data*, *10.7.4 Exporting Trend Data*, and *10.9 Events Review Page*. The exported data is saved in csv or xml format.

### 15.7.6.2 Exporting Patient Data

To export patient data on the review setup page, follow this procedure:

1. On the review setup page, select the **Export** tab.
2. Click **Export Patient Data**.
3. Select the desired patients, data type and save path.
4. Click **Export**. The exported data is saved in a Mindray private data format, which can be viewed at the CMS Viewer. For how to view the exported data at the CMS Viewer, see *BeneVision Central Monitoring System Viewer Operator's Manual*.

## 15.8 Telemetry Settings

In the **Telemetry** tab, you can set items for telemetry devices. This tab is available at the CentralStation only.

### 15.8.1 Accessing the Telemetry Setup Page

To access the telemetry setup page, follow this procedure:

1. Select the system menu area in the upper left corner of the screen → select **System Setup** to access the **System Setup** menu.
2. Select the **Telemetry** tab → enter the required password → select the **OK** button.

### 15.8.2 Setting Alarm Properties for Telemetry Devices

To set the alarm properties for telemetry devices, follow this procedure:

1. On the telemetry setup page, select the **Alarm** tab.
2. Set **Alarm Delay**. If an alarm condition is resolved within the delay time, the CentralStation does not present the alarm. The alarm delay setting affects some physiological alarms.
3. Set **ST Alarm Delay**.
4. Set the alarm priority for **ECG Lead Off**, **SpO2 Sensor Off**, and **No RF Signal**.
5. Set time for **Alarm Reset** and **Alarm Pause**. If the alarm source still exists within the designated time, the system resumes the alarm.
6. Select the desired alarm priorities under **Latching** on the right side of the screen to latch physiological alarms. You can separately latch visual indications or simultaneously latch the visual and audible indications.
  - ◆ **Lethal, High, Med, and Low**: indicate alarm priorities.
  - ◆ **Visible**: latches visual indications only. When an alarm condition is resolved, visual indications, including alarm message and its background color remain. The time when the alarm is last triggered is displayed behind the alarm message.
  - ◆ **Audible**: when this option is selected, **Visible** will be selected automatically. All the visual and audible alarm indications remain until you reset the alarms. Besides, the time when the alarm is last triggered is displayed behind the alarm message.
  - ◆ Enable or disable **V-Tach Latching Lock**. This option is enabled by default. When it is disabled, you can set **V-Tach Latching** in the **Setup** tab of a telemetry device's **Alarm Setup** menu on the ViewBed screen. If you wish to change **V-Tach Latching Lock**, select **Visible** or **Audible** for **Lethal** in the **Latching** section first.

#### NOTE

- 
- **Changing alarm priorities may affect the latching status of corresponding alarms. Determine if you need to reset the alarm latching status after changing alarm priorities.**
  - **When the alarm system is reset, latched physiological alarms are cleared.**
  - **Selecting alarms of lower priority simultaneously latches higher priority alarms.**
- 

### 15.8.3 Setting ECG Related Items for Telemetry Devices

To set ECG related items for the telemetry devices, follow this procedure:

1. On the telemetry setup page, select the **ECG** tab.
2. Set **Notch Frequency** to **50 Hz** or **60 Hz** according to the power line frequency.
3. Enable or disable **Analysis Leads**. After this option is enabled, when ECG monitoring with lead sets other than 3-lead is being performed, the **Analysis Leads** option is displayed in the ECG menu. You can select the desired lead as the analysis lead. Then, the CentralStation uses the analysis lead to detect beats, compute heart rate and arrhythmia alarms and so on.

## 15.8.4 Setting Nurse Call Properties

To set nurse call functions, follow this procedure:

1. On the telemetry setup page, select the **Nurse Call** tab.
2. Set **Nurse Call**.
  - ◆ **Enable**: enables the nurse call function and displays the **Nurse Call** field on the patient management screen.
  - ◆ **Disable**: disables the nurse call function.
3. Set **Nurse Call Audio Mode**.

---

### WARNING

---

- **Do not rely exclusively on the nurse call system for alarm notification. Remember that the most reliable alarm notification combines audible and visual alarm indications with the patient's clinical condition.**
- 

## 15.8.5 Device Setting

### 15.8.5.1 Configuring Auto Enter Monitor Mode

Auto Enter Monitor Mode allows the telemetry monitor to switch from telemetry mode to monitor mode when **No Central Monitoring** or **Lethal Arrhy. Alarm** occurs. In this case, the display turns from off to on and medical staff should pay more attention to the patient's status. If the above alarm disappears, the telemetry monitor switches back to telemetry mode and the display turns off when the configured **Display Auto Off** time has elapsed.

By default, **Auto Enter Monitor Mode** is set as **No Central Monitoring**.

To configure **Auto Enter Monitor Mode**, follow this procedure:

1. On the telemetry setup page, select the **Device Setting** tab.
2. Set **Auto Enter Monitor Mode**:
  - ◆ Choose **No Central Monitoring**: When disconnected from the CMS, the telemetry monitor switches from telemetry mode to monitor mode and displays no central monitoring alarm.
  - ◆ Choose **Lethal Arrhy. Alarm**: When lethal arrhythmia alarm occurs, the telemetry monitor switches from telemetry mode to monitor mode and displays lethal arrhythmia alarm.
  - ◆ Choose both **No Central Monitoring** and **Lethal Arrhy. Alarm**: When disconnected from the CMS or lethal arrhythmia occurs, telemetry monitor turns from telemetry mode to monitor mode and displays corresponding alarm.

---

### NOTE

---

- **When the telemetry monitor is connected to the CMS, Auto Enter Monitor Mode can only be configured on the CMS. The configuration is synchronized to the telemetry monitor.**
  - **The telemetry monitor switches back to telemetry mode only when all the abnormal conditions that trigger auto enter monitor mode disappear.**
  - **If you already choose monitor mode via the telemetry monitor or CMS, the auto enter monitor mode would be ineffective.**
  - **If the telemetry monitor is paired with a N series monitor and the N series monitor is in standby, the telemetry in monitor mode, then the auto enter monitor mode would be ineffective.**
- 

### 15.8.5.2 Configuring Display Auto Off

If the touch screen of the telemetry monitor is not touched for the configured display auto off time, then the screen will turn off after the configured display auto off time has elapsed.

To configure **Display Auto Off**, follow this procedure:

1. On the telemetry setup page, select the **Device Setting** tab.
2. Set **Display Auto Off**.

## NOTE

- When the telemetry monitor is connected to the CMS, **Display Auto Off** can only be configured on the CMS. The configuration is synchronized to the telemetry monitor.

### 15.8.5.3 Configuring Upgrade Server IP

Upgrade server IP is the master server IP which is needed only when the telemetry monitor wants upgrading through master server. This function requires configurations on the telemetry monitor and the master server as well, refer to the telemetry monitor service manual and the BeneVision Central Monitoring System service manual for more details.

To configure **Upgrade Server Ip**, follow this procedure:

1. On the telemetry setup page, select the **Device Setting** tab.
2. Set **Upgrade Server Ip**.

### 15.8.6 Frequency Setup

In the **Frequency Setup** tab, you can program the TMS-6016 and the TMS60 telemetry transmitters.

To program the TMS-6016 and the TMS60 telemetry transmitters, follow this procedure:

1. Connect one end of the dedicated programming cable to the serial port 1 (COM1) () on the CMS, and the other end to the SpO<sub>2</sub> connector on the transmitter.
2. Select the **Frequency Setup** button. The window of Telemetry Configuration Tool displays.

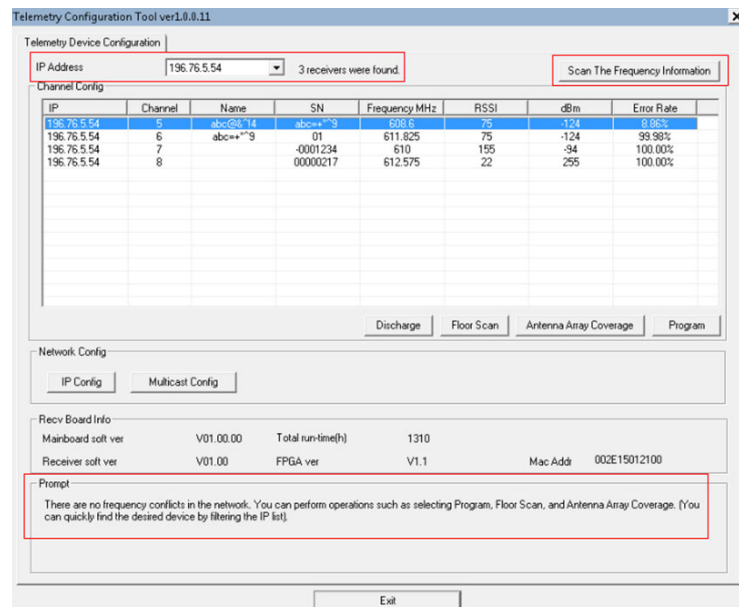

In this window, you can:

- ◆ Select **Scan The Frequency Information** to check the information of all the receivers connected to the CMS.
  - ◆ Select **IP Address** of the receiver you want to check, such as 192.76.5.1.35 to check the channel information corresponding to the selected receiver. If there are any frequency conflicts, the number of these frequency points will be shown. If not, the prompt “There are no frequency conflicts in the network” is displayed at the bottom of the window.
3. Select a channel and then select the **Program** button. When the dialog box prompting “Please ensure this channel is not used to monitor patients” displays, select the **OK** button.
  4. In the **Frequency** field, select the desired frequency such as 608.7MHz.

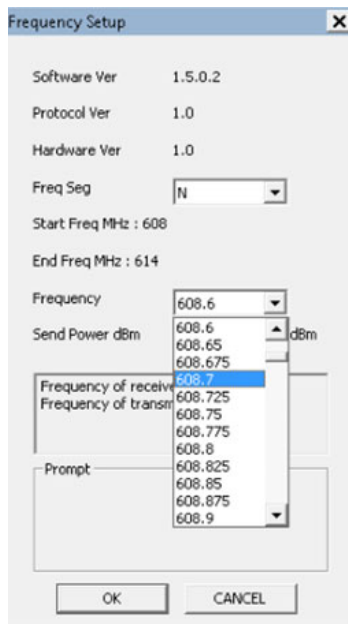

5. Select the **OK** button to finish programming.

After the programming succeeds, the prompt message “Frequency setup completed successfully” displays and the frequency of the channel has been changed successfully.

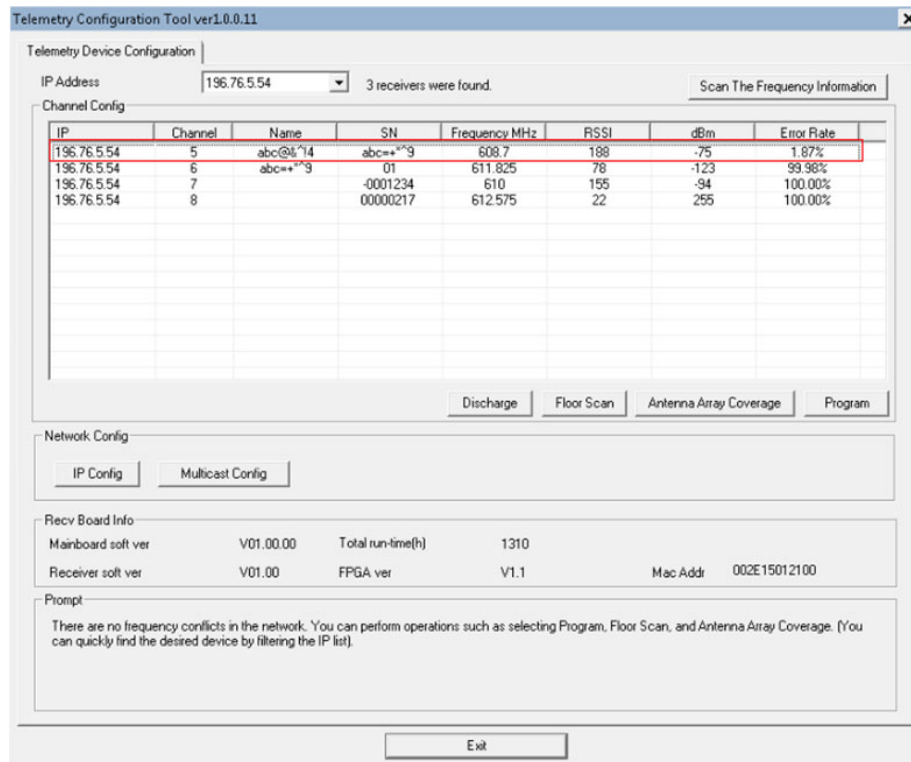

## 15.8.7 Programming Telepack-608 Telepacks

In the **Program** tab, you can program a Telepack-608 telepack to the CMS.

To program the Telepack-608 telepack, follow this procedure:

1. Connect one end of the dedicated programming cable to the serial port 1 (COM1) on the CMS, and the other end to the connector on the elepack.
2. Free a channel in either of the following ways,
  - ◆ Select the **Free Connected Channel** button to free the channel of the connected telepacks.



- ◆ Select the **Free Channel** button. The **Free Channel** window displays. You can select the channel you want to free. After selecting the desired channel, select the **Free Channel** button.
3. Select the **Program** button. When the window asking “Are you sure you want to program the wireless device?” displays, select **OK**. Then the frequency will be set automatically. After successfully programming the telepacks, the prompt message “Program Successfully” displays.

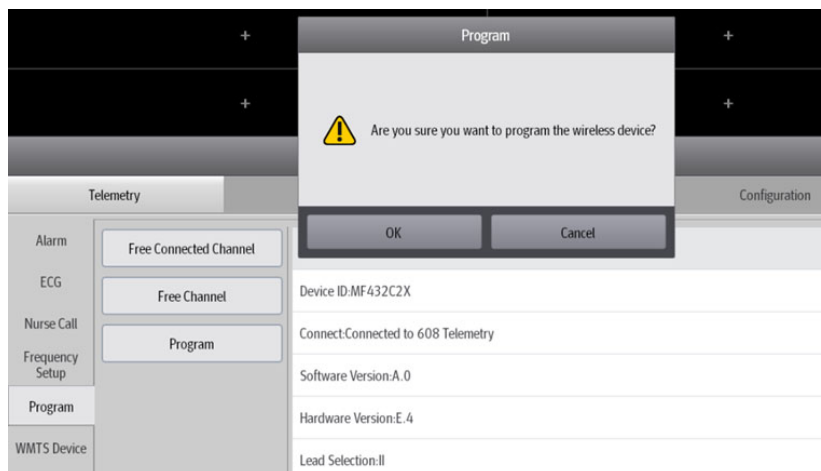

## 15.8.8 Setting Authorization

In the **Authorization Setup** tab, you can set permissions to allow settings on the telemetry monitors.

### 15.8.8.1 Setting the Password Timeout Period

If you use the password saved in the MLDAP server to change alarm settings and arrhythmia settings, pause alarms, and reset alarms for the telemetry monitors, you can set the password timeout period. If the timeout period is reached, you need to re-enter the password.

To do so, set **Automatic Logout Time** in the **Authorization Setup** tab.

### 15.8.8.2 Setting Other Permissions

You can set whether to allow the following settings on the telemetry monitor. By default, these settings are allowed and not password protected:

- Change alarm setup and arrhythmia setup
- Pause and reset alarm
- Enable ST and QT analysis
- Manually start ECG Relearn
- Modify patient demographics
- Discharge patient and enter standby

Select the desired permissions in the **Authorization Setup** tab:

- ◆ **No Password:** the setting is allowed and not password protected on the telemetry monitor.
- ◆ **Read Only:** the setting can only be viewed on the telemetry monitor.
- ◆ **User Password:** the user name and password saved in the MLDAP server are required for the setting on the telemetry monitor. If the telemetry monitor is disconnected with the CMS, the maintenance password of the telemetry monitor will be required.

## NOTE

- **User Password permission is only available for changing alarm setup and arrhythmia setup, pausing and resetting alarms.**

## 15.8.9 WMTS Device

In the **WMTS Device** tab, you can view the status of packets sent from the TMS-6016 Telemetry Monitoring System, the TMS60 Telemetry Monitoring System, or the Telepack-608 to the CentralStation. Operations in this tab should be performed by authorized service personnel.

## 15.9 Network Settings

In the **Network** tab, you can set communication conditions between a CMS and other central monitoring systems, between a CMS and bedside devices, between a CMS and eGateway, between CMS and the MLDAP server.

### 15.9.1 Accessing the Network Setup Page

To access the network setup page, follow this procedure:

1. Select the system menu area in the upper left corner of the screen → select **System Setup** to access the **System Setup** menu.
2. Select the **Network** tab → enter the required password → select the **OK** button.

### 15.9.2 Setting General Communication Conditions

In the **General** tab, you can set central monitoring network, bedside monitoring network, remote view, multicast parameters, and encryption connection type. This tab is available at the CentralStation, the WorkStation, and the ViewStation. But you can only set the central monitoring network and the encryption connection type at the WorkStation and ViewStation.

To configure the settings, follow this procedure:

1. On the network setup page, select the **General** tab.
2. In the **Central Monitoring Network Setup** section, set **Local IP address**. From the drop-down list, select current CMS IP address. This IP address is used for communication between the CentralStation and external systems such as eGateway and remote CentralStations.
3. In the **Bedside Monitoring Network Setup** section, set **Local IP address**. From the drop-down list, select the IP address of the CentralStation network adapter which is used for internal communication between the CentralStation and bedside devices.
4. In the **Remote View** section, set the desired options:
  - ◆ **Support Monitor Remote View**: after bedside monitors and telemetry devices are admitted by the CentralStation, if the bedside monitors support the remote view functionality, you can view other bedside monitors or telemetry devices in the bedside monitors' remote view window.
  - ◆ **CMS Sending Broadcast Data**: this function is used when you view telemetry data on the bedside monitor screen. For the bedside monitor which only supports broadcast mode, you must select the check box before **CMS Sending Broadcast Data**.
5. In the **Multicast Setup** section, set **Multicast Address** and **Multicast TTL** values. These values are used for communication between a CentralStation and bedside devices, between different Centralstations, and between a CentralStation and WorkStation, ViewStation, or CMS Viewer.
6. In the **Information Security** section, set **Encryption Connection Type** when connecting devices:
  - ◆ **Only Private Encryption**: Mindray private encryption is used to encrypt the transmitted data. You cannot connect devices supporting SSL (secure sockets layer) encryption.
  - ◆ **SSL Encryption Priority**: for devices supporting SSL encryption, SSL encryption is used when connecting the devices. For devices not supporting SSL encryption, private encryption is used when connecting the devices.
7. In the **Information Security** section, enable or disable **Broadcast Patient Demographics**.
  - ◆ **Enabled**: After bedside devices are connected to the CentralStation, they can send device information and patient data such as patient name to the CentralStation.
  - ◆ **Disabled**: After bedside devices are connected to the CentralStation, they can send device information to the CentralStation only.

## NOTE

---

- **The Multicast Address needs to be in the [224.0.2.0 - 238.255.255.255] segment.**
  - **Restart the system after making a change in the General tab.**
- 

### 15.9.3 Setting the Master Server

In the **Master Server** tab, you can set the master server address and log on to the master server.

To set the master server, follow this procedure:

1. On the network setup page, select the **Master Server** tab.
2. Set the options.
  - ◆ **Master Server Address:** enter the IP address or name of the master server. There can only be one master in the network.
  - ◆ **Master Server IP Address:** it is automatically acquired after **Master Server Address** is entered.

Upon completion of connection, the status of connection between the CentralStation and the master server is displayed on the right side of **Connection Status**.
3. Select **Setup**. The **Master Server Setup** dialog box is displayed.
4. Enter **User Name** and **Password**.
5. Select **Login** to log onto the master server setup screen.

On the master server setup screen, you can search bedside devices, manage configurations collectively, etc.

For information on the master server screen, see *BeneVision/HYPERVISOR X Central Monitoring System Service Manual*.

To test whether the CMS is properly connected with the Master Server, follow this procedure:

1. On the network setup page, select the **Master Server** tab.
2. Select **Network Test**.

### 15.9.4 Configuring eGateway

In the **eGateway** tab, you can configure the settings when the CentralStation communicates with an eGateway.

When your license supports installing eGateway via the CentralStation, you can install and log onto the eGateway via the CentralStation.

#### 15.9.4.1 Installing and Setting eGateway

To install eGateway, follow this procedure:

1. On the network setup page, select the **eGateway** tab.
2. Select **Install eGateway**.
3. Proceed according to instructions in the installation wizard.

To set eGateway, follow this procedure:

1. On the network setup page, select the **eGateway** tab.
2. Select **eGateway Setup**.
3. Set the desired items.

For information on detailed installation procedures and instructions for use, see *eGateway Integration Manager Installation Guide*.

## NOTE

---

- **Upon completion of eGateway installation, the CMS will shut down and the operating system will be restarted.**
-

#### 15.9.4.2 Setting ADT Query

When a CMS is connected with the HIS, you can use the admit-discharge-transfer (ADT) server to obtain patient information from the HIS and export the patient formation to the CMS.

To set ADT query, follow this procedure:

1. On the network setup page, select the **eGateway** tab.
2. In the **ADT Query Setup** section, enable **ADT Query**.
3. In the **Server Address** text box, enter the IP address or name of the ADT server. **IP Address** is automatically acquired from **Server Address**.
4. Set **Port**. The port should be consistent with that for the eGateway.

After setting ADT query, the **ADT** tab is displayed in the **Find Patient** Window.

#### 15.9.4.3 Testing ADT Server Connection

To test whether the CMS is properly connected with the ADT server, follow this procedure:

1. On the network setup page, select the **eGateway** tab.
2. In the **ADT Query Setup** section, select **Network Test**.

#### 15.9.4.4 Setting Data Export

The functions of exporting waveform data and 12-lead ECG data are available at the CentralStation only. The function of exporting PDF report is available at the CentralStation, the WorkStation, and the ViewStation. To set data export, follow this procedure:

1. On the network setup page, select the **eGateway** tab.
2. In the **Data Export Setup** section, enable or disable **Export Waveform Data**.
  - ◆ Enabled: the **Export to EMR** button is displayed on the detail waveform review window and event review page. You can export waveform segments and events to third party systems.
  - ◆ Disabled: you cannot export waveform segments or events to third party systems.
3. Enable or disable **Export 12-lead ECG Data**.
  - ◆ Enabled: the CentralStation can receive the 12-lead ECG analysis result from the bedside automatically generate a 12-lead ECG report, and then send the report to third party systems.
  - ◆ Disabled: 12-lead ECG report will not be generated.
4. Enable or disable **Export PDF Report**. When it is enabled, When the CMS or the monitor prints a PDF report containing patient information, the report will be sent to the eGateway which will notifies the EMR.
5. In the **Server Address** text box, enter the IP address or name of the eGateway. **IP Address** is automatically acquired from **Server Address**.
6. Set **Port**. The port must be consistent with that for the eGateway. Upon completion of settings, connection status between the current station and eGateway is displayed on the right of **Connection Status**.

#### 15.9.4.5 Testing eGateway Connection

To test whether the CMS is properly connected with eGateway, follow this procedure:

1. On the network setup page, select the **eGateway** tab.
2. Select **Network Test** in the **Data Export Setup** section.

#### 15.9.5 Setting CentralStation Authorization

In the **Central Station Authorization** tab, you can set access types of the remote CentralStation, WorkStation, the ViewStation, and the CMS Viewer to control current CentralStation. This tab is available at the CentralStation only.

To set CentralStation authorization, follow this procedure:

1. On the network setup page, select the **Central Station Authorization** tab.
2. Set **Access Control**.

- ◆ **Full Control:** the WorkStation has full control over this CentralStation.
  - ◆ **Read Only:** the WorkStation, the ViewStation, and the CMS Viewer can view this CentralStation only.
  - ◆ **Off:** the remote CentralStation, WorkStation, the ViewStation, and the CMS Viewer cannot access this CentralStation.
  - ◆ **User Password:** a user name and password are required to visit this CentralStation.
3. When the **Access Control** is set as **Full Control** or **Read Only**, you can set a password to access this CentralStation for a Remote CentralStation, WorkStation, ViewStation and CMS Viewer. Select **A password is required to access this Central Station**, enter and then confirm the password in the **Reset Password** section and then select **Save**.

## NOTE

- **It is recommended that the password be changed by authorized personnel.**

## 15.9.6 Setting CentralStation Connection

In the **Central Station Connection** tab, you can add or delete the CentralStation for WorkStation/ViewStation or connect your current station (the CentralStation, the WorkStation, or the ViewStation) to the desired CentralStation. Once connected, your current station can admit devices and monitor patients from the desired CentralStation, and control the desired CentralStation if authorized.

### 15.9.6.1 Adding the CentralStation

To add the CentralStation for the WorkStation/ViewStation, follow this procedure:

1. On the network setup page, select the **Central Station Connection** tab.
2. Add the CentralStation in either of the following way. A maximum of 50 CentralStation can be added.
  - ◆ To add the CentralStation one by one, select **Add** → Input IP address of the CentralStation → select **OK**.
  - ◆ To add a list of CentralStation at a time, select **Import** → select the text file containing all the IP addresses of the desired CentralStation → select **OK**. The text file should be created before importing and only one IP address for one line in the file.

### 15.9.6.2 Deleting the CentralStation

To delete the CentralStation for the WorkStation/ViewStation, follow this procedure:

1. On the network setup page, select the **Central Station Connection** tab.
2. Delete the CentralStation in either of the following way.
  - ◆ To delete the CentralStation one by one, select the symbol  beside the desired CentralStation.
  - ◆ To delete all the CentralStation, select **Delete All**.

### 15.9.6.3 Connecting or Disconnecting the CentralStation

To connect the desired CentralStation, follow this procedure:

1. On the network setup page, select the **Central Station Connection** tab.
2. Select the desired CentralStation from the list of CentralStations.
3. Select the **Connect** button. If password protection is enabled for the chosen CentralStation, you need to enter a password.

If you need to disconnect from a CentralStation, select the desired station, and select the **Disconnect** button.

### 15.9.6.4 Testing Devices Connection

To test whether the CMS is properly connected with the desired CentralStation, follow this procedure:

1. On the network setup page, select the **Central Station Connection** tab.
2. Select **Network Test**.

## 15.9.7 Setting Bed Authorization

In the **Bed Authorization** tab, you can set to allow which beds at current CentralStation to be viewed by external systems, such as the WorkStation. This tab is available at the CentralStation only.

To set bed authorization, follow this procedure:

1. On the network setup page, select the **Bed Authorization** tab.
2. Select the desired beds. Only the selected beds can be viewed by external systems.
3. If you need to allow the beds that are newly admitted by the CentralStation to be viewed by external systems by default, select **Default authorization to be enabled for all beds..**

## 15.9.8 Setting the AP Management Tab

In the **AP Management** tab, you can import the desired AP information into the CentralStation and configure patient movement area. This tab is available at the CentralStation only.

### 15.9.8.1 Importing AP Information

In the **AP List** section, you can import a text file containing AP information. The text file must be in this format: AP Name, Mac address, Location, Detail. AP Name, Mac address, Location, and Detail are customizable.

To import AP information, follow this procedure:

1. On the network setup page, select the **AP Management** tab.
2. Select **Import AP Information**.
3. Select the desired file.
4. Select **OK**.

### 15.9.8.2 Configuring Device Movement Area

You can set whether to trigger an alarm when a telemetry monitor enters or moves out of specified area in the selected department.

To do so, follow this procedure:

1. On the network setup page, select the **AP Management** tab.
2. Set **Setup Mode**.
3. Set **Department**.
4. If you wish to specify a location, enter the desired location in the **Please input location information** box. If you wish to select all the locations, select **Select All**.
5. Enable or disable **Trigger an alarm when devices enter the restricted area** or **Trigger an alarm when devices move out of the allowed area**. This option is dependent on **Setup Mode**. Once the option is enabled, the corresponding alarms are triggered on the telemetry devices and you need to select **OK** on the telemetry devices to turn off the alarm.
6. Set **Alarm Priority**.

#### NOTE

- 
- **Location refers to the one listed in the Location column of AP List.**
- 

## 15.9.9 MLDAP

MLDAP refers to Mindray LDAP (Lightweight Directory Access Protocol). It is an independent process which can be installed on eGateway or other application server (Windows). MLDAP provides user identity and authentication.

The MLDAP server is connected with the hospital LDAP server. All bedside devices are connected to the MLDAP server to implement identity and authentication for the following operations.

This tab is available at the CentralStation, the WorkStation, and the ViewStation.

### 15.9.9.1 Setting MLDAP

To access the MLDAP server, follow this procedure:

1. On the network setup page, select the **MLDAP** tab.
2. In the **Server Address** text box, enter the IP address or name of the MLDAP server. **IP Address** is automatically acquired from **Server Address**.
3. Set the port of the MLDAP server.

### 15.9.9.2 Testing MLDAP Server Connection

To test whether the CMS is properly connected with the MLDAP server, follow this procedure:

1. On the network setup page, select the **MLDAP** tab.
2. Select **Network Test**.

## 15.9.10 Configuring Mobile Server

Mobile Server provides monitoring data to the Mobile Viewer and acts as an interface to the CMS. In the **MobileServer** tab, you can install and set Mobile Server. This tab is available at the CentralStation Only.

Mindray provides CMS software license with either one of the following permissions:

- Installing and setting Mobile Server on the CentralStation
- Installing and setting Mobile Server independently, not on the CentralStation
- Setting public network connections for Mobile Server on the CentralStation.

This chapter describes only the first and third scenarios. For details on how to install and set the Mobile Server independently, see *Mobile Server Installation and Use Guide*.

### 15.9.10.1 Installing and Setting Mobile Server

If the CMS software allows you to install Mobile Server on the CentralStation, you would need to install it on the same host computer with the CentralStation. Mobile Server initiates the network connection to the CentralStation in this circumstance. To install Mobile Server, follow this procedure:

1. On the network setup page, select the **MobileServer** tab.
2. Select **Install Mobile Server**.
3. Select the installation language and then select **OK**.
4. Proceed according to instructions in the installation wizard. For information on detailed installation procedures, see *Mobile Server Installation and Use Guide*.

After you install the Mobile Server, follow this procedure to set it:

1. On the network setup page, select the **MobileServer** tab.
2. Select **Mobile Server Setup**.
3. Set the desired items. For information on detailed configuration items, see *Mobile Server Installation and Use Guide*.

### 15.9.10.2 Setting Public Network Deployment and Testing Mobile Server Connection

If the CMS software allows you to set public network deployment on the CentralStation, you would need to install it on a different host computer from the CentralStation. For information on detailed installation procedures, see *Mobile Server Installation and Use Guide*. The CentralStation initiates the network connection to the Mobile Server in this circumstance.

Before proceeding the public network deployment, you would need to turn on public network deployment switch on the Mobile Server first. For detailed information, see *Mobile Server Installation and Use Guide*.

To set public network deployment, follow this procedure:

1. On the network setup page, select the **MobileServer** tab.
2. Turn on **Public Network Deployment**.

3. In the **Mobile Server Address** text box, enter the IP address or name of the mobile server. **Mobile Server IP Address** is automatically acquired from **Mobile Server Address**.

Upon completion of connection, the status of connection between the CentralStation and the mobile server is displayed on the right side of **Connection Status**.

To test whether the CMS is properly connected with the Mobile Server, follow this procedure:

1. On the network setup page, select the **MobileServer** tab.
2. Select **Network Test**.

## 15.10 Print Settings

In the **Print** tab, you can set items related to a printer or reports.

### 15.10.1 Accessing the Print Setup Page

To access the print setup page, follow this procedure:

1. Select the system menu area in the upper left corner of the screen → select **System Setup** to access the **System Setup** menu.
2. Select the **Print** tab → enter the required password → select the **OK** button.

### 15.10.2 Setting a Printer

In the **Printer** tab, you can set printer-related items.

To set a printer, follow this procedure:

1. On the print setup page, select the **Printer** tab.
2. Set **Printer**.
3. Set desired print-related properties.

#### NOTE

- 
- **Only the following reports support color printing currently: vital sign summary report, ECG summary report.**
  - **PDF reports can be output by PDFCreator only.**
- 

### 15.10.3 Setting Scheduled Reports

In the **Scheduled Report** tab, you can set whether to enable scheduled printing of reports.

To enable scheduled printing for all the beds on the multibed screen, follow this procedure:

1. On the print setup page, select the **Scheduled Report** tab.
2. Enable **Scheduled Report Switch**.
3. Set **Time**. Select the time to start printing automatically.
4. Under **Scheduled Report Interval**, select the desired printing interval.
  - ◆ For tabular trends reports, graphic trends reports, event reports, and 12-lead interpretation reports, data within the selected scheduled report interval before the printing start time will be printed. For example, when **Scheduled Report Interval** is set to **2 hrs**, 2-hour data before the printing start time will be printed.
  - ◆ For arrhythmia statistics reports, when **Scheduled Report Interval** is set to **24 hrs** or **12 hrs**, data within the recent 24 hours or 12 hours before the printing start time will be printed. When it is set to **8 hrs**, **4 hrs**, **2 hrs**, or **1 hr**, data within the recent 8 hours before the printing start time will be printed.
  - ◆ For alarm limits reports: alarm limits at the printing start time will be printed.
  - ◆ For realtime reports: realtime data at the printing start time. will be printed.
5. Select the desired report type. Only the selected reports can be printed at the scheduled report interval.



6. Select **Print Now** if you wish to start printing immediately regardless of the configured printing start time.

## NOTE

---

- **Contents in the reports can be customized for each bed. For more information, see Section 13.5.4 Setting Scheduled Reports.**
- 

### 15.10.4 Setting End Case Reports

To set end case reports for all the beds on the multibed screen, follow this procedure:

1. On the print setup page, select the **End Case Report** tab.
2. Set **Period**. This option is applicable for tabular trends report, graphic trends report, event report, 12-lead interpretation report, and arrhythmia statistics report.
3. Select the desired report types.

## NOTE

---

- **Contents in the reports can be customized for each bed. For more information, see Section 13.5.4 Setting Scheduled Reports.**
- 

### 15.10.5 Setting Report Layout

In the **Report Layout** tab, you can set the patient information displayed on the reports.

To set the report layout, follow this procedure:

1. On the print setup page, select the **Report Layout** tab.
2. Select the desired items under **Report Name**. **N/A** indicates that this item is not displayed on a report.

## NOTE

---

- **Above settings does not apply to ECG reports. For details on how to set ECG reports layout, refer to 15.10.6 Setting ECG Reports.**
- 

### 15.10.6 Setting ECG Reports

In the **ECG Report** tab, you can set the patient information displayed on ECG reports.

To set ECG reports, follow this procedure:

1. On the print setup page, select the **ECG Report** tab.
2. Select the desired items.

### 15.10.7 Setting PDF File Name

To set PDF file name, follow this procedure:

1. On the print setup page, select the **PDF File Name** tab.
2. Select the desired items under **PDF File Name**.
3. In the **File Path** text box, enter the directory where PDF files are saved.
4. In the **User Name** text box and the **Password** text box, enter the user name and password to access the directory where PDF files are saved.
5. Select **Confirm**.

## NOTE

---

- **The directory must be consistent with the file saving directory configured in the PDFCreator.**
- 

### 15.10.8 Setting the Recorder

To set the recorder, follow this procedure:

1. On the print setup page, select the **Recorder** tab.
2. Enable or disable **Recorder Switch**. When it is enabled, you can output reports via a recorder.
3. Set **Recorder COM Port** and then select the desired port for the recorder.
4. If you wish to stop all the current recordings and reset the recording task, select **Reset RecordService**.

### 15.10.9 Setting Other Print-Related Items

To set other print-related items, follow this procedure:

1. On the print setup page, select the **Other** tab.
2. Set the desired option.
  - ◆ **Print on Alarm**: select the output device when an alarm is triggered. When an alarm is triggered for a parameter and **Alarm Outputs** is enabled, the CMS can start a printing or recording task automatically.
  - ◆ **Printing Duration On Alarm**: sets the desired length of waveforms that will be printed or recorded automatically when **Alarm Outputs** for a parameter is enabled and an alarm is triggered. 10 sec, 20 sec, and 30 sec means printing the waveforms 5 seconds, 10 seconds, and 15 seconds before and after the alarm triggered time respectively.
  - ◆ **Monitor Remote Print**: if you enable this option, the CMS automatically starts a printing task after the printing task is started at the patient monitor.
  - ◆ **Second Mark (Printer)**: if you enable this option, second marks will be displayed on the report printout.
  - ◆ **Recording Duration**: sets the recording duration of the recorder.
  - ◆ **Recorder Paper Speed**: sets the paper speed of the recorder.

## 15.11 Configuration Settings

### 15.11.1 Accessing the Configuration Setup Page

To access the configuration setup page, follow this procedure:

1. Select the system menu area in the upper left corner of the screen → select **System Setup** to access the **System Setup** menu.
2. Select the **Configuration** tab → enter the required password → select the **OK** button.

### 15.11.2 Setting Telemetry Configurations

In the **Telemetry Configuration** tab, you can save the measurement settings and alarm settings of the selected bed as configuration items. These configuration items can be loaded to other telemetry devices. For details on how to load these configuration items, see Section 7.4.6 *Loading Configurations*. This tab is available at the CentralStation only.

To save telemetry configuration items, follow this procedure:

1. On the configuration setup page, select the **Telemetry Configuration** tab.
2. Select the desired bed for **Select Bed**.
3. Select the **Save Telemetry Configuration** button. The **Save Telemetry Configuration** dialog box is displayed.
4. Select the department which the saved bed configuration is applicable to.
5. Select **OK**.

### 15.11.3 Setting Department Configurations

In the **Department Configuration** tab, you can use the display, print, and history settings of the selected bed as configuration items. These configuration items can be loaded for bedside monitors automatically when the monitors are newly admitted by the CentralStation. This tab is available at the CentralStation, the WorkStation, and the ViewStation.

To set department configurations, follow this procedure:

1. On the configuration setup page, select the **Department Configuration** tab.
2. Select the desired bed for **Select Bed**.
3. Select the **Save Department Configuration** button. The **Save Department Configuration** dialog box is displayed.
4. Select whether to save the configuration as the department's default configuration.
5. If you need to load the department configurations for all beds, select **Load Department Configuration for All Beds**.

## 15.11.4 Setting the Department List

This tab is available at the CentralStation Only.

### 15.11.4.1 Adding a Department

To add a department, follow this procedure:

1. On the configuration setup page, select the **Department List** tab.
2. In the **Department** text box, enter the desired department name.
3. Select **Add**.

### 15.11.4.2 Deleting a Department

To delete a department, follow this procedure:

1. On the configuration setup page, select the **Department List** tab.
2. From the department list, select  on the right of the department to be deleted.
3. In the **Department List** dialog box, decide whether to delete the department. If yes, select **OK**. The default department cannot be deleted.

## 15.11.5 Setting the Bed

You can view the bed list in the care group and device assignment pages. You can select **Bed List** to add or delete the bed at the CentralStation and WorkStation.

For details on care group and device assignment, refer to *15.5.8.2 Automatically Assigning Care Groups* and *4.1.1 CentralStation Automatically Admitting Devices*.

### 15.11.5.1 Adding a Bed

To add a bed, follow this procedure:

1. On the device management screen, select the **Bed List** tab.
2. Enter desired **Department** and **Room No**.
3. Enter the prefix, initial number, and suffix of bed numbers. **Initial Number** and **Number of Beds** are required.
4. Under **Number of Beds**, enter the desired number of beds that can be displayed in the bed list. The maximum number of beds is 128.
5. Select **Add**.

### 15.11.5.2 Deleting a Bed

To delete a bed, follow this procedure:

1. On the device management screen, select the **Bed List** tab.
2. From the bed list, select the beds that need to be deleted. If you wish to delete all the beds, select **Select All**.
3. Select **Delete**.
4. In the **Delete Bed** dialog box, select **OK**.

### 15.11.5.3 Pre-Assigning a Bed

To pre-assign a bed, follow this procedure:

1. Select **Device Management** in the **System Setup** menu.
2. Pre-assign a bed in the **Device Assignment** screen, For details, refer to *4.1.3 Manually Admitting Devices*.

If the device and the bed have the same bed number or patient ID, the CMS will assign it to the pre-assigned bed when a device is admitted.

### 15.11.6 Setting Assignment between Telemetry Devices and Departments

In the **Assign Telemetry** tab, you can assign telemetry devices to departments and delete telemetry devices assigned. This tab is available at the CentralStation Only.

You have two ways to assign telemetry devices to departments:

- Select a telemetry device and department from the device list.
- Enter a telemetry device's name

#### 15.11.6.1 Assigning Telemetry Devices to Departments from Department List

To assign telemetry devices to departments, follow this procedure:

1. On the configuration setup page, select the **Assign Telemetry** tab.
2. Select **Add From Device List**.
3. From the device list, select the desired department and device.
4. Select **OK**.

#### 15.11.6.2 Assigning Telemetry Devices to Departments by Entering Telemetry Device's Name

To assign telemetry devices to departments, follow this procedure:

1. On the configuration setup page, select the **Assign Telemetry** tab.
2. Select **Department**.
3. In the **Device Name** text box, enter the desired telemetry device.
4. Select **Add**.

### 15.11.7 Printing, Backing Up, and Restoring All Settings

To print, back up, and restore all settings, follow this procedure:

1. On the configuration setup page, select the **Archive/Back Up** tab.
2. Select the desired item.
  - ◆ **Print All Settings:** prints all settings such as telemetry configurations and department configurations.
  - ◆ **Back Up All Settings:** after selecting this option, you need to select the directory where settings are saved and then select **OK**.
  - ◆ **Restore All Settings:** after selecting this option, you need to select the directory where back-up settings are located and then select **OK**.

### 15.11.8 Exporting and Importing Configuration

To export all the settings from current CMS for another CMS or the other way around, follow this procedure:

1. On the configuration setup page, select the **Archive/Back Up** tab.
2. Select the desired item.
  - ◆ **Export All Settings:** after selecting this option, you need to select the directory where settings are exported and then select **OK**.

- ◆ **Import All Settings:** after selecting this option, you need to select the directory where settings are imported and then select **OK**. **Are you sure you want to import the settings?** would prompt and click **OK** again.

## 15.12 CAA (Clinical Assistive Applications) Settings

For VS series monitors working in spot check mode, you can set to remind EWS measuring in this tab. The CAA tab is available at the CentralStation and WorkStation.

### 15.12.1 Accessing the CAA page

1. Select the system menu area  in the upper left corner of the screen → select **System Setup** to access the **System Setup** menu.
2. Select the **CAA** tab → enter the required password → select the **OK** button.

### 15.12.2 Setting EWS Measurement Reminding

For VS series monitors working in spot check mode, you can set to remind EWS measuring. To do so, follow this procedure:

1. On the CAA page, select the **EWS** tab.
2. Enable **Remind Measurement**.
3. Set desired time for **Remind Measurement Countdown**.
4. Set desired **Score** and corresponding measurement **Interval**. The patient sector prompts measurement countdown reminding before the interval is reached. If EWS measurement is not taken when the interval is reached, the sector is highlighted with a blue background.
5. To add or delete interval items, select **Add** or **Delete**.

#### NOTE

---

- **Only CentralStation provides Remind Measurement Countdown and Interval settings.**
- 

### 15.12.3 Setting SepsisSight

You can set the goals for first resuscitation and bundles treatments for the patient in the **SepsisSight** menu. To do so, follow this procedure:

1. On the CAA page, select the **SepsisSight** tab.
2. Select desired period for **The first of resuscitation**. And select and edit the goals for the first resuscitation.
3. Set **Bundles**: select and edit treatments to be completed in 1 hour, 3 hour, and 6 hours.
4. If you need to restore all the settings in the **SepsisSight** menu to factory defaults, select **Defaults**.

#### NOTE

---

- **Only CentralStation provides SepsisSight Menu.**
- 

## 15.13 Other Settings

### 15.13.1 Accessing the Other Setup Page

To access the other setup page, follow this procedure:

1. Select the system menu area in the upper left corner of the screen → select **System Setup** to access the **System Setup** menu.
2. Select the **Other** tab → enter the required password → select the **OK** button.

### 15.13.2 Setting Units

To set units, follow this procedure:

1. On the other setup page, select the **Unit** tab.
2. Set the desired units.

### 15.13.3 Setting Units for Integrated Devices

You can set the units for integrated devices that are integrated with the monitor at the CentralStation.

To set units, follow this procedure:

1. On the other setup page, select the **Integrated Devices Unit** tab.
2. Set the desired units.

### 15.13.4 Configuring Module

To set the module, follow this procedure:

1. On the other setup page, select the **Module** tab.
2. Set **Barometric Pressure**.
3. Set **QTc Formula**. The CentralStation uses the Hodges correction formula by default to correct the QT interval for heart rate.

◆ Hodges:  $QTc = QT + 1.75 \times (\text{HeartRate} - 60)$

◆ Bazett:  $QTc = QT \times \left(\frac{\text{HeartRate}}{60}\right)^{\frac{1}{2}}$

◆ Fridericia:  $QTc = QT \times \left(\frac{\text{HeartRate}}{60}\right)^{\frac{1}{3}}$

◆ Framingham:  $QTc = QT + 154 \times \left(1 - \frac{60}{\text{HeartRate}}\right)$

4. Set **ECG Standard**.

### 15.13.5 Setting Time

---

---

#### WARNING

- **When the CMS software is running, do not change the operating system time. If the operating system time must be changed, do not change the operating system time directly. Instead, change the CMS system time according to instructions in this section.**
- 
- 

#### NOTE

- **After the CentralStation time is changed, the networked monitor system time will be synchronized to match the CentralStation system time.**
  - **When a monitor is connected to the CentralStation, the monitor system time will be synchronized to match the CentralStation system time.**
  - **The CentralStation will synchronize the time of the networked monitors at start of every hour.**
- 
- 

#### 15.13.5.1 Changing Time

To change time manually or automatically at the CMS, follow this procedure:

1. On the other setup page, select the **Time** tab.
2. Set **Time Synchronization**.
  - ◆ **Master Server:** synchronizes time with the master server.

- ◆ **NTP Server:** synchronizes time with the NTP server. You need to set **Time Server Address** and **Interval**. **Connection Status** displays the status of connection between the CMS and the NTP server.
- ◆ **Manual:** sets the time manually. You need to set **Date**, **Time**, **Date Format**, and **24-Hour Time**. in the **Set System Time** section. When **24-Hour Time** is enabled, the 24-hour clock system is used. When **24-Hour Time** is disabled, the 12-hour clock system is used.

To test whether the CMS is properly connected with the NTP Server, follow this procedure:

1. On the other setup page, select the **Time** tab.
2. Select **Network Test**.

### 15.13.5.2 Defining the Night Time

You can define the night time for the system entering and exiting night mode or for the heart rate statistics of ECG summary at the CentralStation. To do so, follow this procedure:

1. On the other setup page, select the **Time** tab.
2. On the nighttime area, select **From** and **To** to define the beginning and end of the night time.

## 15.13.6 Setting Authorization

### 15.13.6.1 Setting the Password Timeout Period

If you use the password saved in the MLDAP server to access the **System Setup** menu, alarm settings and arrhythmia settings, you can set the password timeout period. If the timeout period is reached, you need to re-enter the password. To do so, follow this procedure:

1. On the other setup page, select the **Authorization Setup** tab.
2. Set **Retention Time**.

### 15.13.6.2 Selecting Password for User Authentication

You can select what password is used when accessing the **System Setup** menu. To do so, follow this procedure:

1. On the other setup page, select the **Authorization Setup** tab.
2. Set **User Maintenance**.
  - ◆ **Local Password:** the password to access the **System Setup** menu at the CMS is required.
  - ◆ **User Password:** the user name and password saved in the MLDAP server are required.

### 15.13.6.3 Changing the Local Password for Accessing System Setup

To change the password required to access the system setup tabs other than the **Factory Maintenance** tab, follow this procedure:

1. On the other setup page, select the **Authorization Setup** tab.
2. Select **Modify Local Password** and respectively enter the old password and new password.
3. Select the **Save** button.

#### NOTE

- 
- **It is recommended that the password be set by authorized personnel.**
- 

### 15.13.6.4 Setting the Permission to Delete Discharged Patient Information

You can set the permission to delete discharged patient information via the CentralStation or the WorkStation.

To set the permission, follow this procedure:

1. On the other setup page, select the **Authorization Setup** tab.
2. Select **Delete Discharged Patients**.
3. Select the desired option:

- ◆ **Read Only:** you can view discharged patient information. The Delete button on the discharged patients management screen becomes inactive.
- ◆ **No Password:** you can delete discharged patient information without entering a password.
- ◆ **Local Password:** you need to enter the correct local password before deleting discharged patient information. If you wish to change the local password,select **Modify Local Password**.

### 15.13.6.5 Setting Clinic Permissions

You can set permissions for CMS to control monitors and telemetry devices in the clinic settings area.

To do so, follow this procedure:

1. On the other setup page, select the **Authorization Setup** tab.
2. In the **Clinical Setting** section, select the desired item.
3. Select the desired permission:
  - ◆ **No Password:** at the CentralStation/WorkStation, you can remotely control monitors or telemetry devices without entering a password.
  - ◆ **Read Only:** at the CentralStation/WorkStation, you can only view settings of the monitors or telemetry devices.
  - ◆ **Local Password:** at the CentralStation/WorkStation, you need to enter the correct local password before performing alarm-related settings for the monitors and telemetry devices. If you wish to change the local password,select **Modify Local Password**.
  - ◆ **User Password:** at the CentralStation/WorkStation, you need to enter user name and password saved in the MLDAP server before performing alarm-related settings for the monitors and telemetry devices.

### 15.13.6.6 Setting Other Permissions

This tab is available only at the CentralStation and the WorkStation.

To set other permissions for the CMS to control monitors and telemetry devices, follow this procedure:

1. On the other setup page, select the **Authorization Setup** tab.
2. Set the desired options:
  - ◆ **Read Only:** on the CMS, you can only view information from the monitors or telemetry devices. When **Transfer Patient** is set to **Read Only**, the **Transfer Patient** button on the patient management screen is grayed out. You cannot transfer patient data.
  - ◆ **No Password:** on the CMS, you can control monitors or telemetry devices remotely. No password is required. When **Transfer Patient** is set to **No Password**, the **Transfer Patient** button on the patient management screen is active. You can transfer patient data.
  - ◆ **Enable One Bed:** puts one patient monitor into or out of night mode or privacy mode.
  - ◆ **Enable All Beds:** puts one patient monitor or all patient monitors into or out of night mode or privacy mode.

### 15.13.7 Setting Language

When the CMS starts, it is displayed in the language selected at the time of installation.

To change a language, follow this procedure:

1. On the other setup page, select the **Language** tab.
2. Select the desired language. It is recommended to select the language supported by the operating system.
3. Restart the system.

#### NOTE

- **If the language you selected is inconsistent with that of the operating system, unrecognizable characters may appear on the CMS. If this occurs, change the operating system language and region settings by following the operating system operator's manual.**



### 15.13.8 Setting A Device Location

To set the device information, follow this procedure:

1. On the other setup page, select the **Device Location** tab.
2. Set **Facility Name** and **Facility Icon**. The facility name should be no more than 128 characters.
3. Set **Department**. Department is where the CMS is located. The department name should be no more than 8 characters.
4. Set **Device Name**. The device name should be no more than 32 characters.
5. Set **Main Screen Display**.
6. Enable or disable **Synchronize Location To Telemetry/Monitor**. When it is enabled, after a patient is discharged from a telemetry device or patient monitor, if the hospital and department information of this telemetry device or patient monitor is blank, the CMS will send these pieces of information of its own to the telemetry device or patient monitor.

### 15.13.9 Exporting Logs

In the **Log** tab, you can export the following items:

- Logs and parameter data collected by the current system or the remote CentralStation
- Logs and patient data in the patient monitors connected to the current system or the remote CentralStation

To export logs, follow this procedure:

1. On the other setup page, select the **Log** tab.
2. On the right of **Device Name**, select the source where data is to be exported.
  - ◆ **Local**: exports data in this system.
  - ◆ Department where a remote CentralStation is located: exports data from a remote CentralStation.
3. Select **Export**. The **Log Export Tool** page is displayed.
4. Select **Setup**. After finishing configurations, select **OK**.
5. Select the desired device from the device list on the **Log Export Tool** page. If the desired device is not in the device list, select **Add Device Manually**. Then add the device info.
6. Select the desired export items: **Export Log** or **Export Clinical Data**
7. Upon completion of export, select **Quit**.

### 15.13.10 Setting Manual Event Authorization

You can enable or disable Manual Event Edit option to allow or forbid selecting and editing manual events. This is available at the CentralStation and the WorkStation.

To do so, follow this procedure:

1. On the other setup page, select the **Manual Event** tab.
2. Set **Manual Event Edit** option:
  - ◆ Enabling this option allows selecting and editing manual events.
  - ◆ Disabling this option forbids selecting and editing manual events. The system automatically saves the manual event.

### 15.13.11 Enabling Accessing M-IoT Device Management System

To access M-IoT Device Management System from system menu of CentralStation/WorkStation/ViewStation, follow the procedure below. For details, see *3.11 Accessing M-IoT Device Management System*.

1. On the other setup page, select the **M-IoT** tab.
2. Enable **M-IoT Device Management System**.

## 15.14 Configuring CentralStation's System Settings via the WorkStation

When the CentralStation runs as a service, you can change its system settings via the WorkStation connected to the CentralStation.

To change systems, follow this procedure:

1. Select the system menu area in the upper left corner of the WorkStation's screen → select **System Setup** to access the **System Setup** menu.
2. Select the **Network** tab → enter the required password → select the **OK** button.
3. Select the **Central Station Connection** tab.
4. Select the desired CentralStation from the list of CentralStations.
5. Select the **Setup** button.
6. Enter the password to access the CentralStation.
7. Set desired items by referring to the descriptions in this chapter.

# 16 Maintenance

---

## 16.1 Overview

Regular maintenance is essential to ensure that the CMS functions properly.

## 16.2 Maintenance Safety Information

---

### **WARNING**

---

- **Failure on the part of the responsible individual hospital or institution using the CMS to implement a recommended maintenance schedule may cause undue equipment failure and possible health hazards.**
  - **The safety checks or maintenance involving any disassembly of the CMS should be performed by professional service personnel. Otherwise, undue equipment failure and possible health hazards could result.**
  - **The service personnel must be properly qualified and thoroughly familiar with the operation of the CMS.**
  - **Turn off the CMS if no patients are to be centrally monitored.**
  - **Restart the CMS every three months. Long time operation of the system may lead to a failure of the operating system.**
  - **When the CMS is restarting, patient data will not be stored. To prevent any data loss, only restart your system when patients are not monitored.**
  - **Disinfection or sterilization may cause damage to the equipment. Therefore, when preparing to disinfect or sterilize the equipment, consult your hospital's Infection Control Officer or Epidemiologist.**
  - **Check the equipment after disinfection. If there is any sign of damage, remove it from use.**
- 

### **CAUTION**

---

- **If needed, contact Mindray for information concerning the repair of the CMS.**
  - **All servicing and future upgrades must be carried out by the service personnel trained and authorized by Mindray.**
  - **Make sure that the CMS operating environment meets the specific requirements. Otherwise, unexpected consequences, e.g. damage to the equipment, could result.**
  - **When disposing of the packaging material, be sure to observe the applicable waste control regulations and keep it out of children's reach.**
  - **At the end of its service life, the CMS must be disposed of in compliance with the guidelines regulating the disposal of such products. If you have any questions concerning disposal of the equipment, please contact Mindray.**
-

## 16.3 General Inspection

Whenever your system is first installed, repaired, upgraded or has been used for 6 to 12 months, a thorough inspection should be performed by qualified service personnel to ensure its reliability.

Follow these guidelines:

- Inspect the equipment and its accessories for mechanical damage.
- Make sure that the environment and power supply meet the specific requirements.
- Inspect all power cords and signal lines for fraying or other damages, and ensure that they are properly connected and insulated.
- Ensure that the sound system functions normally.
- Ensure that each function of the system is in good condition.

In case of any damage or abnormality, do not use the CMS. Contact your hospital biomedical engineers or Mindray service personnel immediately.

## 16.4 Cleaning

Your equipment should be cleaned on a regular basis. If you are in an area that is heavily polluted or dusty, the equipment should be cleaned more frequently.

The equipment to be cleaned includes the host, displays, printer, keyboard, and mouse.

---

### CAUTION

---

- **Shut down the system and disconnect all power cords from the outlet before cleaning the equipment.**
  - **Take extra care when cleaning the screen because it is more sensitive to rough cleaning method than the housing.**
  - **When cleaning the mouse, keyboard, or other peripheral devices, disconnect them from the CMS.**
  - **Never immerse any part of the CMS in liquids or allow liquid to enter the interior.**
  - **Do not pour or spray any liquid directly on the equipment or accessories or permit fluid to seep into the casing, connectors, switches, or any ventilation openings. If you spill liquid on the equipment or accessories, disconnect the power supply, dry the equipment, and contact your service personnel.**
  - **Check the equipment after cleaning. If there is any sign of damage, remove it from use.**
- 

For the best performance, it is recommended that the CMS touch screen be kept clean. Observe the following precautions when cleaning the touch screen:

- Always remember to use a cloth or towel to apply glass cleaner to the touch screen.
  - Any standard glass cleaner can be used to clean the touch screen. DO NOT use abrasive cleaning materials to clean a touch screen. DO NOT use alcohol or solvents containing chlorinated hydrocarbons.
  - Remove fingerprints and stains by using a liquid lens cleaner and a soft cloth.
  - Use a fine soft-hair brush to carefully brush away dust and dirt particles.
- 

### CAUTION

---

- **To avoid potential system issues, deactivate the touch screen before cleaning.**
  - **DO NOT spray glass cleaner directly on a display as it could possibly leak inside a non-sealed unit and cause damage.**
  - **Follow your hospital protocol for handling of blood and body fluids.**
-

# A Technical Specifications

## A.1 Requirements

The computer of the CMS should be highly reliable and stable. The recommended configurations are as follows:

Components	Requirements
System	Meet the IEC60950 requirements defined for ITE equipment, and comply with CE low voltage directives (LVD) and EMC directives.
Host and virtual machine for CentralStation	<ul style="list-style-type: none"> <li>■ Running as an application on a host:               <ul style="list-style-type: none"> <li>◆ CPU: 4 cores and 2.9 GHz minimum</li> <li>◆ Memory: 4GB minimum</li> <li>◆ Hard disk: 500 GB minimum, supporting data redundancy by dual hard disks</li> <li>◆ Network adapter: 100M (minimum) self-adapting, Ethernet 802.3</li> <li>◆ USB ports: two or more</li> <li>◆ Serial ports: one or more</li> </ul> </li> <li>■ Running as a service on a host:               <ul style="list-style-type: none"> <li>◆ CPU: 4 cores and 2.4 GHz minimum</li> <li>◆ Memory: 12GB minimum</li> <li>◆ Hard disk: 1TB minimum, supporting data redundancy by dual hard disks</li> <li>◆ Network adapter: 1000M (minimum) dual card, self-adapting, Ethernet 802.3</li> <li>◆ USB ports: two or more</li> <li>◆ Serial ports: one or more</li> </ul> </li> <li>■ Running as a service on a virtual machine:               <ul style="list-style-type: none"> <li>◆ recommended virtual machines: VMWare ESXi 6.0 and above; Hyper-V on Windows® Server 2012 R2 or Windows® Server 2016</li> <li>◆ CPU: 4 cores and 2.4 GHz minimum</li> <li>◆ Memory: 12GB minimum</li> <li>◆ Hard disk: 1TB minimum, supporting data redundancy by dual hard disks</li> <li>◆ Network adapter: 1000MB (minimum) dual card, self-adapting, Ethernet 802.3</li> </ul> </li> </ul>
Host machine for WorkStation and ViewStation	<p>WorkStation and ViewStation</p> <ul style="list-style-type: none"> <li>◆ CPU: dual cores and 2.0 GHz minimum</li> <li>◆ Memory: 2GB minimum</li> <li>◆ Hard disk: 100 GB minimum, supporting data redundancy by dual hard disks</li> <li>◆ Network adapter: 100M (minimum) self-adapting, Ethernet 802.3</li> <li>◆ USB ports: two or more</li> <li>◆ Serial ports: one or more</li> </ul>
Display	<ul style="list-style-type: none"> <li>■ four ordinary displays with 1280×1024 resolution</li> <li>■ four widescreen displays with 1920×1080 resolution</li> <li>■ Support single 4K widescreen with 3840×2160 resolution (recommended displays: 55 inches or above with aspect ratio of 16:9)</li> <li>■ Support touchscreen</li> </ul>

Components	Requirements
Operating System	CentralStation: <ul style="list-style-type: none"> <li>■ Running as an application:               <ul style="list-style-type: none"> <li>◆ Support Windows® 7 Professional SP1</li> <li>◆ Support Windows® 10</li> </ul> </li> <li>■ Running as a service:               <ul style="list-style-type: none"> <li>◆ Support Windows® Server 2016</li> <li>◆ Support Windows® Server 2019</li> </ul> </li> </ul>
	WorkStation and ViewStation: <ul style="list-style-type: none"> <li>■ Support Windows® 7 Professional SP1</li> <li>■ Support Windows® 10</li> </ul>
Antivirus	Support McAfee Application Control
Graphic card	Support dual or multiple displays
Recorder	Thermal array, serial port
Printer	Support A4 and Letter paper sizes
Speaker	<ul style="list-style-type: none"> <li>■ Built in the computer or the display</li> <li>■ Give alarm tones (45 to 85 dB) and alarm tones comply with IEC 60601-1-8.</li> </ul>

## NOTE

- **The configurations above are for reference only.**
- **When the CentralStation running as a service, Mobile Server and eGateway are installed on the same host, the host needs to meet these requirements: CPU: 8 cores minimum, 2.0GHz minimum; memory: 16GB minimum; network adapter: 1000M minimum.**
- **When the CentralStation running as an application, Mobile Server and eGateway are installed on the same host, the host needs to meet these requirements: CPU: Intel Core i5 microprocessor or above or its equivalent; memory: 16GB minimum; network adapter: 1000M minimum.**

## A.2 Audio Signals

<b>Alarm tone*</b>	600 Hz, ISO pattern; 600 Hz, ISO2 pattern
<b>Self-test tone</b>	a short beep
<b>Alarm volume adjustment tone</b>	a short beep
<b>Event tone</b>	A long beep
<b>Nurse call tone</b>	Three beeps
*: For details on the alarm tone pattern, see 8.2.3 Alarm Indicators.	

## A.3 Maximum Number of Monitoring Devices

Item	Maximum Number of Monitoring Devices That Can Be Connected
CentralStation	Running as an application: 64 Running as a service: 128
WorkStation	64
ViewStation	64

Item	Maximum Number of Monitoring Devices That Can Be Connected
<b>Note:</b>	The maximum number of WorkStations, ViewStations and CentralStations one CentralStation can connect to is 32.

## A.4 Maximum Number of Patient Sectors on the Multibed Screen

Display resolution	Maximum Number of Patient Sectors on the Multibed Screen
1280×1024	One display:16 Two displays: 32 Three or four displays: 64
1920×1080	One display: 32 Two or more displays: 64
3840×2160	One display: 64

## A.5 Maximum Number of CMS Viewers

CentralStation Running Mode	Maximum Number of CMS Viewers One CentralStation Can Connect to
As a service	128
As an application	32

## A.6 Wired Network

<b>Network structure</b>	Ethernet 802.3
<b>Transmission rate</b>	100 Mbps or above
<b>Max alarm time delay</b>	≤ 3s

## A.7 Summary

The CMS supports the following summaries:

- Vital sign summary
- ECG summary

## A.8 Review

<b>Dynamic short trend</b>	Most recent 8 hours of minitrends for all parameters
<b>Trend review</b>	Most recent 240 hours of tabular trends and graphic trends for all parameters
<b>Full disclosure</b>	Most recent 240 hours of full-disclosure waveforms and compressed waveforms
<b>C.O. review</b>	Most recent 720 C.O. measurements
<b>NIBP review</b>	Most recent 3000 NIBP measurements

<b>Event review</b>	Most recent 3000 events, including the parameter name and 16-second waveform before and after an alarm is triggered
<b>Historic review</b>	More than 200 discharged patients' data
<b>12-lead Review</b>	Most recent 720 12-lead analysis results, 12 analysis waveforms for each analysis result
<b>ST review</b>	Most recent 240 hours of ST segments

## A.9 Calculation

The CMS supports the following calculations:

- Drug calculation
- Hemodynamic calculation
- Oxygenation calculation
- Ventilation calculation
- Renal calculation

## A.10 Print

<b>Paper size</b>	A4 or Letter
<b>Outputs</b>	Titration table report, hemodynamic calculation report, oxygenation calculation report, ventilation calculation report, renal calculation report, graphic trends report, tabular trends report, full disclosure overview report, full disclosure detail report, waveform segment report, event report, event list report, 12-lead interpretation report, multi-lead ECG report, ST report, QT report, Arrh statistics report, aEEG review report, realtime report, print on alarm report, EEG report, CSA report, hemoSight parameters report, SepsisSight report, alarm limits report, summary report, freeze report, typical strips, system settings report, paging report, vital sign summary, ECG summary

## A.11 Recorder

<b>Type</b>	Thermal recorder
<b>Port</b>	RS232 serial port
<b>Paper width</b>	50 mm
<b>Paper speed</b>	25 mm/s, 50 mm/s
<b>Horizontal resolution</b>	16 dots/mm (25 mm/s paper speed)
<b>Vertical resolution</b>	8 dots/mm
<b>Number of waveform channels</b>	Maximum 3
<b>Outputs</b>	Realtime segment waveform recording, realtime continuous waveform recording, auto realtime record, full disclosure detail record, event record, record on alarm report



## A.12 Data Export

<b>Data format</b>	Standard xml file <sup>1</sup>
<b>ECG waveform sampling characteristics</b>	
<b>Frequency</b>	Export in full disclosure and event review: 80 Hz
	Export in 12 lead analysis review: 500 Hz
<b>Amplitude resolution</b>	19.5313 uV/LSB
<b>Significant bits</b>	12 lead analysis review: 16 bits
	Full disclosure and event review:8 bits

Note:

<sup>1</sup>: For more information, please contact Mindray.

**This page intentionally left blank.**

# B CMS Alarm Messages

## B.1 Overview

This chapter only lists technical alarms coming from the CentralStation, the WorkStation, or the ViewStation.

For physiological and technical alarm messages from bedside devices, see appropriate operator's manuals for these devices.

## B.2 Alarm Messages in the System Alarm Area

The following table lists alarm messages in the system alarm area at the top of the screen.

Alarm Message	Default Priority	Cause and Solution
Network is disconnected. Please check.	High	Check the network.
Storage Error	High	Contact your service personnel.
Sound Card Error	High	Replace the computer with a known good one.
The patient data storage space is nearly full. Please delete some discharged patients.	Medium	This alarm is available at the CentralStation only. The discharged patient storage space is nearly full. Please delete some discharged patients. Note: The alarm priority is configurable. For information on changing the alarm priority, see Section 15.5.5 <i>Setting Discharged Patients</i> .
Station (Department), Network Disconnected	Low	Check the connection between the WorkStation and the CentralStation or between the ViewStation and the CentralStation. Note: The "(Department)" in the alarm message refers to the department where the WorkStation or the ViewStation is located. The alarm priority is configurable in the <b>System Setup</b> Menu. For details, see Section 15.4.4 <i>Configuring Other Alarm-Related Items</i> .
eGateway Communication Lost	Low	Check the connection between the eGateway and the CentralStation. Note: The alarm priority is configurable in the <b>System Setup</b> Menu. For details, see Section 15.4.4 <i>Configuring Other Alarm-Related Items</i> .
Disk array error. Please check.	Low	Contact your service personnel and replace the faulty one with a known good one.
Time Server Unavailable.	Low	Check the time synchronization settings and check that the external time server works properly.
Page Communication Lost	Low	Check the paging network.
No bed is online. Please check network connection.	Prompt	This alarm is available at the CentralStation only. Check whether the bedside device is connected to the network.
The patient data storage space is full. The earliest data will be deleted.	Prompt	The discharged patient storage space is full. The earliest discharged patients will be deleted automatically.
Bed No. conflicts. Please check..	Prompt	Check the bed numbers of all the bedside devices. If the same bed number is found, change it to a different bed number.
Recorder Head Hot: Please Wait	Prompt	Wait till the thermal printer head cools down and this prompt disappears. Then the recorder can work properly.
Recorder Unavailable	Prompt	Power off the recorder and restart the recorder. Then select <b>Reset RecordService</b> on the CMS. For details, see Section 15.10.8 <i>Setting the Recorder</i> .
Recorder Initializing	Prompt	

Alarm Message	Default Priority	Cause and Solution
Recorder Comm Error	Prompt	Check the connection cable of the recorder serial port.
Recorder Out Of Paper	Prompt	Load the paper.

### B.3 Alarm Messages in Patient Sectors

The following table lists alarm messages in the patient sectors on the multibed screen.

Alarm Message	Default Priority	Cause and Solution
Patient ID conflicts with XX	Middle	Patient ID conflicts. Check the Patient ID.
Visit number conflicts with XX	Middle	Visit number conflicts. Check the visit number.
Offline	Low	The bedside device is disconnected from the CentralStation network. Please check.
No RF Signal	Low	The telemetry device is disconnected from the CentralStation network. Please check.

# C Default Settings

## C.1 Overview

This chapter only describes default settings in the **System Setup** menu at the CentralStation, the WorkStation, and the ViewStation. For the default settings of bedside devices monitored at the CMS, see appropriate operator's manuals for these devices. For details on how to access the **System Setup** menu, see Chapter 15 *System Setup*.

"All" in the "Available At" column of the following tables indicates that this function is available at the CentralStation, the WorkStation, and the ViewStation.

"/" in the following tables indicates that this item is not configurable.

## C.2 General Tab

Subtab	Item	Default	Available At
Volume	Alarm Volume	2	All
	High Alarm Volume	Alarm Volume+2	
	Reminder Volume	5	
Touch Screen	Screen Lock Duration	1 min	All

## C.3 Display Tab

Subtab	Item	Default	Available At
Screen	Auto Close ViewBed Screen	Never	All
	Share ViewBed Screen with Other WorkStations	Disabled	WorkStation
	Patient Sector Number	16	All
	Column	2	
	Row	8	
Sector	Sort Type	Manual	All
	Sort By	Bed No	
	Sort Orientation	Landscape	
	Spot Check Beds Sort Type	with Continuous Monitoring Beds	
	Support Switching Locked Sector	Off	
	Clear Unlocked Overview Sector After Discharging The Patient		
	Hide Unused Sectors	Off	
Patient Window	12-Lead ECG	Selected	All
	ST		
	Arrhy Statistics		

Subtab	Item	Default	Available At
	Drug Calculation		
	Hemo Calculation		
	Oxygenation Calculation		
	Ventilation Calculation		
	aEEG		
	Renal Calculation		
Other	ECG Lead Sequence	Normal	All
	Soft Keyboard	Off	

## C.4 Alarm Tab

Subtab	Item	Default	Available At	
Audio	Minimum Alarm Volume	1	All	
	Alarm Sound	ISO2		
	High Alarm Interval	10 sec		
	Med Alarm Interval	20 sec		
	Low Alarm Interval	20 sec		
	Auto Increase Volume	2 Steps		
	Increase Volume Delay	20 sec		
	Alarm Reset Reminder	Off		
	Alarm Off Reminder	Off		
	Reminder Interval	1 min		
	Single Bed Alarm Audio Off	Disable		
	Resume Alarm Audio When Patient is Admitted	Off		
	Alarm Type with Audio On	All		
	Special Advanced Alarm Sound	Asystole		Selected
		V-Fib/V-Tach		
V-Tach				
Vent Brady				
Extreme Tachy				
Extreme Brady				
SpO2 Desat				
Apnea				

Subtab	Item	Default	Available At
Paging	Paging Delay	5s	CentralStation
	Paging Demographics	Bed No	
	Paging Service	On	
	Support Lead Off Technical Alarm	Disable	
	Support Communication Message		
	Support Battery Message		
	Support Nurse Call		
	Paging Password Protection	No Password	
Other	Global Silence Hotkey	None	All
	Global Silence	Disable	
	Offline Alarm Priority	Low	
	Flashing Alarm Bar	On	
	No offline alarm if patient discharged	On	
	eGateway Communication Lost	Off	CentralStation
	Patient ID/Visit Number Conflicts	Off	CentralStation
Log	Device Name	Local	All

## C.5 Patient Management Tab

Subtab	Item	Default	Available At
Field	Visit Number	Unselected	All
	Room No		
	Middle Name		
	Race		
	Age		
	Facility		
	Department		
	Patient Group		
	Custom Field 1 to Custom Field 4		
	Admit Date		
	Patient ID	Selected	
Find Patient	Find Patient	All Patients	CentralStation, WorkStation

Subtab	Item	Default	Available At
Find Patient	Facility	Unselected	All
	Department		
	Room No		
	Bed No		
	Visit Number		
	Patient ID		
	Patient Name	Selected	
HIS Sync Patient	HIS Admit/Discharge Patient	Disabled	CentralStation
	HIS Admit Patient	Omit	
	HIS Discharge Patient	Omit	
Discharge	Auto delete discharged patients when storage space is full	On	CentralStation
	Prompt on patient auto deleted		
	Auto Discharge if Network Disconnected	Never	
	Include Patient Demographics When Exporting Patient Data	Disabled	
	Auto Delete Patient Data if Discharged	Auto	
	Alarm on storage is nearly full	On	
Location	Location 1	Cathlab	CentralStation
	Location 2	X-Ray	
	Location 3	MRI	
	Location 4	CT Scan	
	Location 5	Ultrasound	
	Location 6	Hemodislysis	
	Location 7	OR	
	Location 8	Therapy	
Patient Group	Group 1 to 16	Selected	CentralStation
Care Group	Care Group Setup Mode	Manual	CentralStation
	Group 1 to 16	Selected	
Other	Display Information in Patient Sector	Patient Name	All
	Patient Name Display Hotkey	F9	
	Reset Care Group in the Locked Sector When Admitting a New Patient	Off	CentralStation



## C.6 Review

Subtab	Item	Default	Available At
Display Default Trend Group	All	Selected	All
	Standard		
	Hemo		
	Cardiac		
	Pulmonary		
	RM		
	RM-Pressure	Unselected	
	RM-Volume		
	RM-Time		
	Neuro	Selected	
	Gases		
	Pump		
	Custom 1		
	Custom 2		
Full Disclosure	Save Waveform	Low Resolution (when the hard-disk partition is less than 450G) Medium Resolution (when the hard-disk partition is greater than or equal to 450G)	CentralStation
Event	Lethal	Selected	CentralStation
	Rename Event	On	CentralStation, WorkStation

Subtab	Item	Default	Available At
Arrhy Mark	Asystole	Selected	All
	V-Fib		
	V-Fib/V-Tach		
	V-Tach		
	Vent Brady		
	Extreme Tachy		
	Extreme Brady		
	PVCs/min High		
	Vent Rhythm		
	R on T		
	Multiform PVC		
	Pauses/min High		
	Run PVCs		
	Couplet		
	PVC		
	Bigeminy		
	Trigeminy		
	Tachy		
	Brady		
	Pacer Not Capture		
	Pacer Not Pacing		
Missed beats			
Nonsus V-Tach			
Pause			
A-Fib			
Irr Rhythm			
Supraventricular tachycardia			
SVCs/min High			
Export	Save As	Off	All

## C.7 Telemetry Tab

Subtab	Item	Default	Available At
Alarm	Alarm Delay	6 sec	CentralStation
	ST Alarm Delay	30 sec	
	ECG Lead Off	Low	
	SpO2 Sensor Off	Low	
	No RF Signal	Med	

Subtab	Item	Default	Available At
	Alarm Reset	Permanent	
	Alarm Pause	2 min	
	Lethal Arrhy Alarms Off	Disable	
	V-Tach Latching Lock	Enable	
	Arrhy Shield Time	2 min	
	Latching-Lethal	Visible & Audible	
ECG	Notch Frequency	60 Hz	CentralStation
	Analysis Leads	Off	
Nurse Call	Nurse Call	Enable	CentralStation
	Nurse Call Audio Mode	Standard	
Device SettingDevice Setting	Auto Enter Monitor Mode	No Central Monitoring	CentralStation
	Display Auto Off	1 min1 min	
	Upgrade Server Ip	0.0.0.0	
Authorization Setup	Automatic Logout Time	20 sec	CentralStation
	Alarm Setup	No Password	
	Arrhythmia		
	Alarm Paused & Alarm Reset		
	ST Analysis		
	QT Analysis		
	ECG Relearn		
	Modify Patient Demographics		
	Discharge Patient		
	Standby		

## C.8 Network Tab

Subtab	Item	Default	Available At
General	Support Monitor Remote View	Off	CentralStation
	Local IP address	Null	WorkStation, ViewStation
	CMS Sending Broadcast Data	Off	CentralStation
	Encryption Connection Type	Only Private Encryption	
	Broadcast Patient Demographics	Off	

Subtab	Item	Default	Available At
eGateway	ADT Query	Off	All
	Export Waveform Data		CentralStation
	Export 12-lead ECG Data		
	Export PDF Report		CentralStation, WorkStation
Central Station Authorization	Access Control	Full Control	CentralStation
	A password is required to access this Central Station	Unselected	
Bed Authorization	Default authorization to be enabled for all beds.	Selected	CentralStation
AP Management	Setup Mode	Allowed Area	CentralStation
	Department	General	
	Trigger an alarm when devices move out of the allowed area	Off	
	Alarm Priority	Low	

## C.9 Print Tab

Subtab	Item	Default	Available At
Printer	Paper Size	Letter	All
	For General Report, End Case Report, Print on Alarm Report, and Scheduled Report:		
	Printer	Blank	
	Printer Resolution	300 dpi	
	PDF Resolution	600 dpi	
	Print Action	Paper	
	Color Mode	Color	
Scheduled Report	Scheduled Report Switch	Off	All
	Time	08:00	
	Scheduled Report Interval	8 hrs	
	Tabular Trends Report	Selected	
End Case Report	Period	4 hrs	All
	Tabular Trends Report	Selected	
Report Layout	Patient Name	Displayed	All
	Patient Category		
	DOB		
	Gender		
	Patient ID		
	Bed No		
	Height/Weight		
	Paced		

Subtab	Item	Default	Available At
	Department		
ECG Report	Patient ID	Selected	All
	Patient Name		
	Age		
	Gender		
	DOB	Unselected	All
	Race		
	Medication		
	Class		
	Physician		
	Technician		
	Department		
	Room No		
	Bed No		
	12-Lead Order		
PDF File Name	Patient ID	Displayed	All
	Title		
	Printing Time		
Recorder	Recorder Switch	Disabled	All
	Recorder COM Port	COM2	
Other	Printing Duration On Alarm	20 sec	All
	Print on Alarm	Printer	
	Monitor Remote Print	Enabled	
	Second Mark (Printer)	Enabled	
	Recording Duration	8 sec	
	Recorder Paper Speed	25 mm/sec	

## C.10 CAA

Subtab	Item	Default	Available At
EWS	Down		All
	Remind Measurement	Disabled	
	Remind Measurement Countdown	10min	CentralStation
	Interval		
	Score	Interval	
	0-0	4h	
	1-6	2h	
	7-7	1h	
	8-20	30min	
SepsisSight	The first of resuscitation	1h	CentralStation
	CVP 8-12 mmHg	Selected	
	MAP $\geq$ 65mmHg		
	Urine output $\geq$ 0.5ml/kg/hr		
	ScvO <sub>2</sub> $\geq$ 70% or SvO <sub>2</sub> $\geq$ 65%		
	Lactate levels targeting resuscitation to normalize lactate		
	Bundles	1h	CentralStation
	Measure lactate level	Selected	
	Obtain blood cultures before administering antibiotics.	Selected	
	Administer broad-spectrum antibiotics.	Selected	
	Begin rapid administration of 30 mL/kg crystalloid for hypotension or lactate $\geq$ 4mmol/L.	Selected	
	Apply vasopressors if hypotensive during or after fluid resuscitation to maintain a mean arterial pressure $\geq$ 65mmHg.	Unselected	
	Hypotension persisting after initial fluid challenge or blood lactate concentration $\geq$ 4 mmol/L(36mg/dL),should monitoring CVP and ScvO <sub>2</sub> .	Unselected	
	Remeasure lactate if initial lactate elevated(>2mmol/L)	Selected	

## C.11 Other Tab

Subtab	Item	Default	Available At
Unit	Height Unit	cm	All
	Weight Unit	kg	

Subtab	Item	Default		Available At	
	ST Unit	mV			
	Hb Unit	g/dl			
	CVP Unit	cmH2O			
	ICP Unit	mmHg			
	CO2 Unit				
	O2 Unit	%			
	Temp Unit	°C			
	Pressure Unit	mmHg			
	SVR Unit	DS/cm <sup>5</sup>			
	Caliper Unit	msec			
Integrated Devices Unit	Pressure Unit	cmH2O		CentralStation	
	CO2 Unit	mmHg			
	tcpCO2/tcpO2 Unit				
Module	Barometric Pressure	760mmHg		CentralStation	
	QTc Formula	Hodges		All	
	ECG Standard	AHA			
Time	Time Synchronization	Master Server		CentralStation	
	Interval	1h			
	Date Format	yyyy-mm-dd		All	
	24-Hour Time	On			
	Nighttime	From	22:00		
		To	06:00		
Authorization Setup	Automatic Logout Time	20 sec		All	
	User Maintenance	Local Password			
	Delete Discharged Patients	No Password		CentralStation, WorkStation	
Authorization Setup		For Telemetry	For Monitor		
	Alarm Setup	No Password	No Password	CentralStation	
		Read Only	Read Only	WorkStation	
	Arrhythmia	No Password	No Password	CentralStation	
		Read Only	Read Only	WorkStation	
	Alarm Pause&Audio Pause&Alarm Reset	No Password	No Password	CentralStation	
		Read Only	Read Only	WorkStation	
	View Discharged Patients	/	No Password	CentralStation	
	Privacy Mode	/	Enable All Beds	CentralStation	
		/	Read Only	WorkStation	
	Night Mode	/	Enable All Beds	CentralStation	

Subtab	Item	Default		Available At
		/	Read Only	WorkStation
	Modify Patient Demographics	No Password	No Password	CentralStation, WorkStation
	Transfer Patient	No Password	No Password	
	Discharge Patient	No Password	No Password	
	Standby	No Password	No Password	
	NIBP Start/Stop	No Password	No Password	
		Read Only	Read Only	WorkStation
	NIBP Interval	/	No Password	CentralStation,
		/	Read Only	WorkStation
	NIBP Clock Measure	/	No Password	CentralStation,
		Read Only	Read Only	WorkStation
	ST Analysis	No Password	No Password	CentralStation,
		Read Only	Read Only	WorkStation
	QT Analysis	No Password	No Password	CentralStation,
		Read Only	Read Only	WorkStation
	QRS Threshold	No Password	/	CentralStation
		Read Only	/	WorkStation
	Pacemaker Rate	No Password	No Password	CentralStation
		Read Only	Read Only	WorkStation
	Pacer Reject	No Password	No Password	CentralStation
		Read Only	Read Only	WorkStation
	ECG Relearn	No Password	No Password	CentralStation
		Read Only	Read Only	WorkStation
	Send Data to EMR/Export EMR	No Password	No Password	CentralStation
		No Password	No Password	WorkStation
	Care Group Assignment	No Password	No Password	CentralStation
		No Password	No Password	WorkStation
	Device Location	No Password	No Password	CentralStation, WorkStation
Language	Language	English		All
Device Location	Main Screen Display	Facility Name+Department		All
	Synchronize Location To Telemetry/Monitor	Off		CentralStation, WorkStation
Manual Event	Manual Event Edit	Enabled		CentralStation, WorkStation
M-IoT	M-IoT Device Management System	Off		All



# D Units, Symbols and Abbreviations

---

## D.1 Units

Abbreviation	Full Form
μA	microampere
μV	microvolt
μS	Microsecond
A	ampere
Ah	ampere hour
bpm	beat per minute
bps	bit per second
°C	centigrade
cc	cubic centimeter
cm	centimeter
cmH <sub>2</sub> O	cmH <sub>2</sub> O
dB	decibel
DS	dyne second
°F	fahrenheit
g	gram
GB	giga bytes
GHz	gigahertz
GTT	gutta
h	hour
hPa	hPa
Hz	hertz
"	inch
k	kilo
kg	kilogram
kPa	kilopascal
L	litre
lb	pound
m	meter
mAh	milliampere hour
mbar	mbar
M	mega
MB	mega byte
MHz	mega hertz

Abbreviation	Full Form
mcg	microgram
mEq	milli-equivalents
mg	milligram
min	minute
ml	milliliter
mm	millimeter
mmHg	millimeters of mercury
ms	millisecond
mV	millivolt
mW	milliwatt
MΩ	megaohm
nm	nanometer
rpm	breaths per minute
s	second
V	volt
VA	volt ampere
Ω	ohm
W	watt

## D.2 Symbols

Symbol	Explanation
-	minus
-	negative
%	percent
/	per; divide; or
~	to
+	plus
=	equal to
<	less than
>	greater than
≤	less than or equal to
≥	greater than or equal to
±	plus or minus
×	multiply
©	copyright

## D.3 Abbreviations

Abbreviation	In Full
AC	alternating current
ADT	Admission\Discharge\Transfer
Adu	adult
aEEG	Amplitude-integrated Electroencephalogram
AG	anaesthesia gas
AgAwRR	Anaesthesia Gas Air-way Respiration Rate
AHA	American Heart Association
Ao	aortic pressure
AP MAP	Mean Artery Pressure
Art	arterial
ATMP	barometric pressure
AUC	area under the curve
AUX	Auxiliary
aVF	left foot augmented lead
aVL	left arm augmented lead
aVR	right arm augmented lead
awRR	airway respiratory rate
BAP	brachial arterial pressure
BC	burst count
BL	baseline
BIS	bispectral index
BSA	body surface area
BT	blood temperature
BTPS	body temperature and pressure, saturated
CaO <sub>2</sub>	arterial oxygen content
CCI	continuous cardiac index
CCO	continuous cardiac output
CCU	cardiac (coronary) care unit
Cdyn	Dynamic compliance
CE	Conformité Européenne
CFI	cardiac function index
C.I.	cardiac index
CIS	clinical information system
CISPR	International Special Committee on Radio Interference
CMOS	complementary metal oxide semiconductor
CMS	central monitoring system
C.O.	cardiac output
CO <sub>2</sub>	carbon dioxide

<b>Abbreviation</b>	<b>In Full</b>
COHb	carboxyhemoglobin
Compl	compliance
CPI	cardiac power index
CPO	cardiac power output
CPU	central processing unit
CRT	cathode ray tube
CSA	Compressed Spectral Array
Cstat	Static compliance
CVP	central venous pressure
DBS	double burst stimulation
DC	direct current
Des	desflurane
Dia	diastolic
DO <sub>2</sub>	oxygen delivery
DO <sub>2</sub> l	oxygen delivery index
dpi	dot per inch
dPmx	left ventricular contractility
DSA	Density Spectral Array
DVI	digital video interface
ECG	electrocardiograph
EDV	end-diastolic volume
EEC	European Economic Community
EEG	electroencephalogram
EMC	electromagnetic compatibility
EMG	electromyograph
EMI	electromagnetic interference
Enf	enflurane
ESU	electrosurgical unit
Et	end-tidal
EtAA	end-tidal anesthetic agent
EtDes	end-tidal anesthetic agent
EtEnf	
EtHal	
EtIso	
EtSev	
EtCO <sub>2</sub>	end-tidal carbon dioxide
EtN <sub>2</sub> O	end-tidal nitrous oxide
ETO	ethylene oxide
EtO <sub>2</sub>	end-tidal oxygen

Abbreviation	In Full
EVLW	extravascular lung water
ELWI	extravascular lung water index
FAP	femoral arterial pressure
FCC	Federal Communication Commission
FDA	Food and Drug Administration
Fi	fraction of inspired
FiAA	inspired anesthetic agent
FiDes	inspired anesthetic agent
FiEnf	
FiHal	
Filso	
FiSev	
FiCO <sub>2</sub>	fraction of inspired carbon oxygen
FiN <sub>2</sub> O	fraction of inspired nitrous oxide
FiO <sub>2</sub>	fraction of inspired oxygen
Flow	flow
fmand	Mandatory breathing frequency
FPGA	field programmable gate array
FRC	fractional residual capacity
FreqMIN	Minimum breath frequency
fSIMV	Frequency of SIMV
fsigh	sigh rate
fspn	Spontaneous breathing frequency
ftot	Total breath rate
F-Trigger	Inspiratory trigger level (flow trigger)
FV	flow-volume
GEDV	global end diastolic volume
GEDI	global end diastolic volume index
GEF	global ejection fraction
Hal	halothane
Hb	hemoglobin
Hct	haematocrit
HIS	hospital information system
HR	heart rate
IBP	invasive brood pressure
IBW	ideal body weight
ICG	impedance cardiography
ICP	intracranial pressure
ICT/B	intracranial catheter tip pressure transducer

<b>Abbreviation</b>	<b>In Full</b>
ICU	intensive care unit
ID	identification
I:E	inspiratory time: expiratory time ratio
IEC	International Electrotechnical Commission
IEEE	Institute of Electrical and Electronic Engineers
Ins, INS	inspired minimum
InsCO <sub>2</sub>	inspired minimum carbon dioxide
Insp.Flow	inspiration flow
Insp. MAC	inspired minimum alveolar concentration
int.PEEP	Intermittent PEEP
IP	internet protocol
Iso	isoflurane
ITBI	intrathoracic blood volume index
ITBV	intrathoracic blood volume
LA	left arm
LAP	left atrial pressure
LCD	liquid crystal display
LCW	left cardiac work
LCWI	left cardiac work index
LED	light emitting diode
LF	low frequency
LL	left leg
LVET	left ventricular ejection time
LVSW	left ventricular stroke work
LVSWI	left ventricular stroke work index
MAC	minimum alveolar concentration
MAP	mean arterial pressure
MetHb	methemoglobin
MRI	magnetic resonance imaging
MV	minute volume
MVe	expiratory minute volume
MVi	inspiratory minute volume
N/A	not applied
N <sub>2</sub>	nitrogen
N <sub>2</sub> O	nitrous oxide
Neo	neonate
NIBP	noninvasive blood pressure
NIF	negative inspiratory force

Abbreviation	In Full
O <sub>2</sub>	oxygen
O <sub>2</sub> %	oxygen concentration
OR	operating room
oxyCRG	oxygen cardio-respirogram
PA	pulmonary artery
pArt	artery pressure
pArt-D	diastolic artery pressure
pArt-M	mean artery pressure
pArt-S	systolic artery pressure
Paw	airway pressure
PAWP	pulmonary artery wedge pressure
pCVP	central venous pressure
Ped	pediatric
PEEP	positive end expiratory pressure
PEF	peak expiratory flow
PEP	pre-ejection period
PIF	peak inspiratory flow
PIP	peak inspiratory pressure
Pleth	plethysmogram
Pmean	mean pressure
pNN50	NN50 count divided by the total number of all NN intervals
PO <sub>2</sub>	oxygen supply pressure
Pplat	plateau pressure
PPV	pulse pressure variation
PR	pulse rate
PVC	premature ventricular contraction
PVPI	pulmonary vascular permeability index
PVR	pulmonary vascular resistance
PVRI	pulmonary vascular resistance index
RA	right arm
RAP	right atrial pressure
Raw	airway resistance
Rec	record, recording
Resp	respiration
RL	right leg
RM	respiratory mechanics
rMSSD	the square root of the mean of the sum of the squares of differences between adjacent NN intervals
RQ	respiratory quotient

<b>Abbreviation</b>	<b>In Full</b>
RR	respiration rate
RSBI	rapid shallow breathing index
rSO <sub>2</sub>	regional oxygen saturation
SaO <sub>2</sub>	arterial oxygen saturation
ScvO <sub>2</sub>	central venous oxygen saturation
SDNN	standard deviation of all NN intervals
SEF	spectral edge frequency
Sev	sevoflurane
SI	stroke index
SMR	satellite module rack
SpO <sub>2</sub>	arterial oxygen saturation from pulse oximetry
SQI	signal quality index
SR	suppression ratio
SSI	signal strength index
STR	systolic time ratio
SV	stroke volume
SVI	stroke volume index
SVR	systemic vascular resistance
SVRI	systemic vascular resistance index
SVV	stroke volume variation
SvO <sub>2</sub>	venous oxygen saturation
Sync	synchronization
Sys	systolic pressure
TB	Blood Temperature
tcpCO <sub>2</sub>	transcutaneous carbon dioxide partial pressures
tcpO <sub>2</sub>	transcutaneous oxygen partial pressures
TD	temperature difference
Temp	temperature
TFC	thoracic fluid content
TFI	thoracic fluid index
TFT	thin-film technology
TI	injectate temperature
TP	total power
TRC	tube resistance compensation
TVe	expiratory tidal volume
TVi	inspiratory tidal volume
TV	tidal volume
UAP	umbilical arterial pressure
UPS	uninterruptible power supply



<b>Abbreviation</b>	<b>In Full</b>
USB	universal serial bus
UVP	umbilical venous pressure
VAC	volts alternating current
VEPT	volume of electrically participating tissue
VI	velocity index
VAC	volts alternating current
VCO <sub>2</sub>	CO <sub>2</sub> production
VO <sub>2</sub>	oxygen consumption
VO <sub>2</sub> I	oxygen consumption index
VO <sub>2</sub> /kg	oxygen consumption per body weight
VO <sub>2</sub> /m <sup>2</sup>	oxygen consumption per body surface area
VT	Tidal volume
VTapnea	apnea tidal volume
VTe/TVe	Expiratory tidal volume
VTe spn	Spontaneous breathed minute volume
VTi/TVi	inspiratory tidal volume
VTsigh	Sigh tidal volume
WOB	work of breathing
WOBimp	Imposed work of breathing

**This page intentionally left blank.**



