

**SV300**

**Ventilator**

**Operator's Manual**





© 2014-2019 Shenzhen Mindray Bio-Medical Electronics Co., Ltd. All rights Reserved.

For this Operator's Manual, the issue date is November, 2019.

---

# Intellectual Property Statement

SHENZHEN MINDRAY BIO-MEDICAL ELECTRONICS CO., LTD. (hereinafter called Mindray) owns the intellectual property rights to this Mindray product and this manual. This manual may refer to information protected by copyright or patents and does not convey any license under the patent rights or copyright of Mindray, or of others.

Mindray intends to maintain the contents of this manual as confidential information. Disclosure of the information in this manual in any manner whatsoever without the written permission of Mindray is strictly forbidden. Release, amendment, reproduction, distribution, rental, adaptation, translation or any other derivative work of this manual in any manner whatsoever without the written permission of Mindray is strictly forbidden.

**mindray**,  and **MINDRAY** are the trademarks, registered or otherwise, of Mindray in China and other countries. All other trademarks that appear in this manual are used only for informational or editorial purposes. They are the property of their respective owners.

---

# Responsibility on the Manufacturer Party

Contents of this manual are subject to change without prior notice.

All information contained in this manual is believed to be correct. Mindray shall not be liable for errors contained herein or for incidental or consequential damages in connection with the furnishing, performance, or use of this manual.

Mindray is responsible for the effects on safety, reliability and performance of this product, only if:

- all installation operations, expansions, changes, modifications and repairs of this product are conducted by Mindray authorized personnel;
- the electrical installation of the relevant room complies with the applicable national and local requirements; and
- the product is used in accordance with the instructions for use.



## **WARNING**

- **It is important for the hospital or organization that employs this equipment to carry out a reasonable service/maintenance plan. Neglect of this may result in machine breakdown or personal injury.**
- 

## **NOTE**

- **This equipment must be operated by skilled/trained clinical professionals.**
-

---

# Warranty

THIS WARRANTY IS EXCLUSIVE AND IS IN LIEU OF ALL OTHER WARRANTIES, EXPRESSED OR IMPLIED, INCLUDING WARRANTIES OF MERCHANTABILITY OR FITNESS FOR ANY PARTICULAR PURPOSE.

## Exemptions

Mindray's obligation or liability under this warranty does not include any transportation or other charges or liability for direct, indirect or consequential damages or delay resulting from the improper use or application of the product or the use of parts or accessories not approved by Mindray or repairs by people other than Mindray authorized personnel.

This warranty shall not extend to:

- Malfunction or damage caused by improper use or man-made failure.
- Malfunction or damage caused by unstable or out-of-range power input.
- Malfunction or damage caused by force majeure such as fire and earthquake.
- Malfunction or damage caused by improper operation or repair by unqualified or unauthorized service people.
- Malfunction of the instrument or part whose serial number is not legible enough.
- Others not caused by instrument or part itself.

---

# Customer Service Department

Manufacturer: Shenzhen Mindray Bio-Medical Electronics Co., Ltd.  
Address: Mindray Building, Keji 12th Road South, High-tech industrial park, Nanshan, Shenzhen 518057, P.R. China  
Website: [www.mindray.com](http://www.mindray.com)  
E-mail Address: [service@mindray.com](mailto:service@mindray.com)  
Tel: +86 755 81888998  
Fax: +86 755 26582680

EC-Representative: Shanghai International Holding Corp. GmbH (Europe)  
Address: Eiffestraße 80, 20537 Hamburg, GERMANY  
Tel: 0049-40-2513175  
Fax: 0049-40-255726

---

# Preface

## Manual Purpose

This manual contains the instructions necessary to operate the product safely and in accordance with its function and intended use. Observance of this manual is a prerequisite for proper product performance and correct operation and ensures patient and operator safety.

This manual is based on the maximum configuration and therefore some contents may not apply to your product. If you have any question, please contact us.

This manual is an integral part of the product. It should always be kept close to the equipment so that it can be obtained conveniently when needed.

## Intended Audience

This manual is geared for clinical professionals who are expected to have a working knowledge of medical procedures, practices and terminology as required for monitoring of critically ill patients.

## Illustrations

All illustrations in this manual serve as examples only. They may not necessarily reflect the setup or data displayed on your ventilator.

## Conventions

- *Italic* text is used in this manual to quote the referenced chapters or sections.
- [ ] is used to enclose screen texts.
- → is used to indicate operational procedures.

## Password

A password is required to access different menus within the ventilator.

- User maintenance: 1234



# Table of Contents

<b>1 Safety</b> .....	<b>1-1</b>
1.1 Safety Information .....	1-1
1.1.1 Dangers .....	1-2
1.1.2 Warnings.....	1-2
1.1.3 Cautions .....	1-5
1.1.4 Notes .....	1-7
1.2 Equipment Symbols .....	1-7
<b>2 The Basics</b> .....	<b>2-1</b>
2.1 System Description .....	2-1
2.1.1 Intended Use.....	2-1
2.1.2 Contraindications .....	2-1
2.1.3 Components .....	2-1
2.2 Equipment Appearance .....	2-2
2.2.1 Front View.....	2-2
2.2.2 Rear View.....	2-4
<b>3 Installations and Connections</b> .....	<b>3-1</b>
3.1 Install the Main Unit .....	3-1
3.2 Connect to the Power Supply .....	3-2
3.2.1 Connect to AC Power.....	3-2
3.2.2 Connect to DC Power.....	3-3
3.3 Connect to the Gas Supply .....	3-4
3.4 Install the Support Arm .....	3-6
3.5 Install the Patient Tubing .....	3-8
3.6 Install the Humidifier .....	3-10
3.6.1 Install the Humidifier onto the Ventilator.....	3-10
3.6.2 Install the Humidifier onto the Pendant .....	3-12
3.7 Install the Nebulizer .....	3-13
3.8 Install the O <sub>2</sub> Sensor.....	3-15
3.9 Install the Gas Cylinder.....	3-16
<b>4 User Interface</b> .....	<b>4-1</b>
4.1 Display Controls .....	4-1
4.2 Waveforms Screen.....	4-5
4.3 Spirometry Screen.....	4-6
4.4 Measured Values Screen.....	4-9
4.5 History Data .....	4-10
4.5.1 Tabular Trend .....	4-10
4.5.2 Graphic Trend.....	4-12
4.5.3 Setting Trends.....	4-14

---

4.5.4 Event Logbook .....	4-16
4.6 Freeze .....	4-17
4.6.1 Enter freeze status .....	4-17
4.6.2 View frozen waveforms .....	4-18
4.6.3 View frozen loop .....	4-18
4.6.4 Exit freeze status .....	4-19
4.7 Lock Screen.....	4-19
<b>5 System Settings.....</b>	<b>5-1</b>
5.1 Display Settings .....	5-1
5.1.1 Waveforms .....	5-1
5.1.2 Measured Values .....	5-2
5.1.3 Colors .....	5-3
5.1.4 Defaults .....	5-3
5.2 Set Date and Time .....	5-4
5.3 Adjust Screen Brightness .....	5-4
5.4 Adjust Key Volume .....	5-4
5.5 Set Tinsp/I:E.....	5-4
5.6 Set IBW/Height.....	5-4
5.7 Set TV/IBW .....	5-5
5.8 Set DuoLevel Timing .....	5-5
5.9 Set IV Apnea Mode.....	5-5
5.10 Set O <sub>2</sub> Sensor Monitoring .....	5-5
5.11 Set Language.....	5-6
5.12 Set Unit .....	5-6
5.12.1 Set Weight Unit .....	5-6
5.12.2 Set Paw Unit.....	5-6
5.12.3 Set CO <sub>2</sub> Unit.....	5-6
5.13 Set O <sub>2</sub> Supply Type .....	5-6
5.14 Manage Default Settings .....	5-7
5.14.1 Save and Load Current Settings .....	5-7
5.14.2 Restore Factory Default Settings.....	5-7
5.14.3 Restore Recent Settings Automatically .....	5-8
5.15 Transfer Settings .....	5-8
5.16 View System Information.....	5-9
5.16.1 Version Information.....	5-9
5.16.2 Configuration Information .....	5-9
5.16.3 Maintenance Information .....	5-9
5.17 Export.....	5-9
5.17.1 Export Screen .....	5-9
5.17.2 Export Data .....	5-10
<b>6 Ventilation.....</b>	<b>6-1</b>
6.1 Turn on the System .....	6-1

---

---

6.2 System Check.....	6-1
6.3 Select Patient.....	6-3
6.3.1 Set Patient Information on the Ventilator .....	6-3
6.3.2 Getting Patient Information from the ADT Server.....	6-4
6.4 Ventilation Type .....	6-4
6.4.1 Invasive Ventilation.....	6-5
6.4.2 Non-invasive Ventilation (NIV).....	6-5
6.4.3 Set Ventilation Type .....	6-5
6.5 Ventilation Mode.....	6-6
6.5.1 Ventilation Mode and Parameter Setup .....	6-6
6.5.2 Apnea Ventilation .....	6-8
6.5.3 V-A/C .....	6-9
6.5.4 P-A/C .....	6-10
6.5.5 V-SIMV .....	6-12
6.5.6 P-SIMV .....	6-13
6.5.7 CPAP/PSV.....	6-15
6.5.8 PRVC.....	6-17
6.5.9 PRVC-SIMV .....	6-18
6.5.10 DuoLevel.....	6-20
6.5.11 APRV .....	6-21
6.5.12 AMV.....	6-22
6.6 Additional settings for ventilation.....	6-24
6.6.1 Sigh .....	6-24
6.6.2 Leakage compensation .....	6-25
6.7 Set Alarm Limits .....	6-26
6.8 Start Ventilation.....	6-26
6.9 Ventilation Parameters .....	6-27
6.10 Enter Standby Status .....	6-30
6.11 Turn the System off.....	6-30
<b>7 CO<sub>2</sub> Monitoring.....</b>	<b>7-1</b>
7.1 Introduction.....	7-1
7.2 Use a Sidestream CO <sub>2</sub> Module.....	7-3
7.2.1 Prepare to Measure CO <sub>2</sub> .....	7-3
7.2.2 Make CO <sub>2</sub> Settings.....	7-5
7.2.3 Measurement Limitations.....	7-6
7.2.4 Troubleshooting.....	7-7
7.2.5 Zero the Sensor .....	7-7
7.2.6 Calibrate the Sensor .....	7-7
7.3 Use a Mainstream CO <sub>2</sub> Module .....	7-8
7.3.1 Prepare to Measure CO <sub>2</sub> .....	7-8
7.3.2 Make CO <sub>2</sub> Settings.....	7-10
7.3.3 Measurement Limitations.....	7-11
7.3.4 Zero the Sensor .....	7-11

---

---

7.3.5 Calibrate the Sensor .....	7-12
<b>8 SpO<sub>2</sub> Monitoring .....</b>	<b>8-1</b>
8.1 Introduction .....	8-1
8.2 Safety .....	8-2
8.3 Applying the Sensor .....	8-2
8.4 Make SpO <sub>2</sub> Settings .....	8-3
8.4.1 Set SpO <sub>2</sub> Monitoring .....	8-3
8.4.2 Set SpO <sub>2</sub> Sensitivity .....	8-3
8.4.3 Set Beat Vol .....	8-3
8.4.4 Set Sweep Speed .....	8-3
8.5 Measurement Limitations .....	8-4
<b>9 Special Functions.....</b>	<b>9-1</b>
9.1 Manual Breath .....	9-1
9.2 Expiration Hold .....	9-1
9.3 Inspiration Hold .....	9-2
9.4 Nebulizer .....	9-2
9.5 O <sub>2</sub> ↑ (O <sub>2</sub> enrichment).....	9-3
9.6 Suction .....	9-4
9.7 P0.1 .....	9-4
9.8 NIF .....	9-5
9.9 PEEPi .....	9-5
9.10 P-V Tool .....	9-6
9.11 Automatic Tube Resistance Compensation (ATRC) .....	9-7
9.12 IntelliCycle.....	9-8
9.13 O <sub>2</sub> Therapy .....	9-8
9.13.1 Preparing for O <sub>2</sub> Therapy .....	9-9
9.13.2 Switching on O <sub>2</sub> Therapy .....	9-11
9.13.3 O <sub>2</sub> Therapy Timer .....	9-13
9.13.4 Switching off O <sub>2</sub> Therapy.....	9-13
<b>10 Alarms .....</b>	<b>10-1</b>
10.1 Introduction .....	10-1
10.2 Alarm Categories.....	10-2
10.3 Alarm Priority Levels.....	10-2
10.4 Alarm Signals .....	10-2
10.4.1 Alarm Lamp .....	10-3
10.4.2 Audible Alarm Tones.....	10-3
10.4.3 Alarm Message .....	10-3
10.4.4 Flashing Alarm Numeric .....	10-3
10.4.5 Alarm Status Symbol.....	10-4
10.5 Set Alarm Volume .....	10-4
10.6 Set Alarm Limits .....	10-5

---

---

10.6.1 Auto Alarm Limits.....	10-5
10.7 AUDIO PAUSED.....	10-6
10.7.1 Set AUDIO PAUSED.....	10-6
10.7.2 Terminate AUDIO PAUSED.....	10-6
10.8 Recent Alarm.....	10-6
10.9 ALARM OFF.....	10-7
10.10 Alarm Tests.....	10-7
10.10.1 Battery in Use.....	10-7
10.10.2 Loss of Power.....	10-8
10.10.3 Paw Too High.....	10-8
10.10.4 T <sub>Ve</sub> Too Low.....	10-8
10.10.5 T <sub>Ve</sub> Too High.....	10-8
10.10.6 MV Too Low.....	10-9
10.10.7 O <sub>2</sub> Supply Failure.....	10-9
10.10.8 PEEP Too Low.....	10-9
10.10.9 Airway Obstructed.....	10-9
10.10.10 FiO <sub>2</sub> Too High.....	10-10
10.10.11 FiO <sub>2</sub> Too Low.....	10-10
10.10.12 EtCO <sub>2</sub> Too High.....	10-10
10.10.13 EtCO <sub>2</sub> Too Low.....	10-10
10.10.14 SpO <sub>2</sub> Too High.....	10-11
10.10.15 SpO <sub>2</sub> Too Low.....	10-11
10.10.16 SpO <sub>2</sub> Desat.....	10-11
10.10.17 PR Too High.....	10-11
10.10.18 PR Too LOW.....	10-12
10.11 Nurse Call.....	10-12
10.12 When an Alarm Occurs.....	10-13
<b>11 Cleaning and Disinfection.....</b>	<b>11-1</b>
11.1 Methods for Cleaning and Disinfection.....	11-2
11.2 Disassemble the Ventilator's Cleanable and Disinfectable Parts.....	11-5
11.2.1 Expiration Valve Assembly and Membrane.....	11-5
11.2.2 Inspiration Safety Valve Assembly.....	11-7
11.2.3 High Efficiency Particle Air (HEPA) Filter Assembly and Dust Filter.....	11-10
11.2.4 Fan Dust Filter.....	11-12
11.2.5 Main Unit Air Outlet Dust Filter.....	11-13
11.2.6 Patient Tubing.....	11-14
11.2.7 Nebulizer.....	11-16
11.2.8 Humidifier.....	11-17
11.2.9 Humidifier on the Ventilator.....	11-17
11.2.10 Mainstream CO <sub>2</sub> Sensor.....	11-20
<b>12 Maintenance.....</b>	<b>12-1</b>
12.1 Repair Policy.....	12-1

---

---

12.2 Maintenance Schedule .....	12-2
12.3 Pressure and Flow Zeroing.....	12-4
12.4 Flow Calibration .....	12-4
12.5 Oxygen Concentration Calibration.....	12-5
12.6 CO <sub>2</sub> Calibration.....	12-6
12.6.1 Sidestream CO <sub>2</sub> Module.....	12-6
12.6.2 Mainstream CO <sub>2</sub> Module .....	12-7
12.7 Touch Screen Calibration .....	12-7
12.8 Battery Maintenance .....	12-8
12.8.1 Battery Performance Conditioning.....	12-9
12.8.2 Battery Performance Checking .....	12-10
12.8.3 Battery Storage.....	12-10
12.8.4 Battery Recycling.....	12-11
12.9 Electrical Safety Inspection.....	12-12
12.10 Water Build-up in the Flow Sensor .....	12-13
12.10.1 Prevent Water Build-up .....	12-13
12.10.2 Clear Water Build-up.....	12-13
<b>13 Accessories .....</b>	<b>13-1</b>
<b>A Theory of Operation.....</b>	<b>A-1</b>
A.1 Pneumatic System .....	A-1
A.2 Electrical System.....	A-5
<b>B Product Specifications .....</b>	<b>B-1</b>
B.1 Safety Specifications .....	B-1
B.2 Environmental Specifications.....	B-2
B.3 Power Requirements.....	B-2
B.4 Physical Specifications .....	B-3
B.5 Pneumatic System Specifications .....	B-4
B.6 Ventilator Specifications.....	B-6
B.7 Ventilator Accuracy .....	B-8
B.8 Alarms .....	B-10
B.9 Special Functions .....	B-11
B.10 CO <sub>2</sub> Module Specifications .....	B-13
B.11 SpO <sub>2</sub> Module Specifications.....	B-15
B.12 O <sub>2</sub> Sensor Specifications .....	B-16
<b>C EMC .....</b>	<b>C-1</b>
<b>D Alarm Messages .....</b>	<b>D-1</b>
D.1 Physiological Alarm Messages.....	D-1
D.2 Technical Alarm Messages .....	D-4

---

---

<b>E Factory Defaults .....</b>	<b>E-1</b>
E.1 Screen .....	E-1
E.2 Setup .....	E-1
E.3 CO <sub>2</sub> Module.....	E-1
E.4 SpO <sub>2</sub> Module .....	E-2
E.5 Ventilation Mode .....	E-2
E.6 Alarm .....	E-7
E.7 History Data.....	E-7
E.8 Special Functions.....	E-7
E.9 O <sub>2</sub> Therapy.....	E-8
E.10 User Maintenance .....	E-8
E.11 Other .....	E-8
<b>F Symbols and Abbreviations.....</b>	<b>F-1</b>
F.1 Unit.....	F-1
F.2 Symbols.....	F-2
F.3 Abbreviations .....	F-3

---

**FOR YOUR NOTES**



# 1 Safety

---

---

## 1.1 Safety Information

---

---

### DANGER

---

- Indicates an imminent hazard that, if not avoided, will result in death or serious injury.
- 
- 

### WARNING

---

- Indicates a potential hazard or unsafe practice that, if not avoided, could result in death or serious injury.
- 
- 

### CAUTION

---

- Indicates a potential hazard or unsafe practice that, if not avoided, could result in minor personal injury and/or product/property damage.
- 
- 

### NOTE

---

- Provides application tips or other useful information to ensure that you get the most from your product.
- 
-

---

### 1.1.1 Dangers

There are no dangers that refer to the product in general. Specific “Danger” statements may be given in the respective sections of this manual.

### 1.1.2 Warnings

---

#### **WARNING**

---

- **The ventilator must only be operated and used by authorized medical personnel well trained in the use of this product. It must be operated strictly following the Operator’s Manual.**
  - **Before putting the system into operation, the operator must verify that the equipment, connecting cables and accessories are in correct working order and operating condition.**
  - **To avoid the risk of electric shock, this equipment must be connected to a properly installed power outlet with protective earth contacts only. If the installation does not provide for a protective earth conductor, disconnect it from the power line.**
  - **Use external power source (AC power or DC power) before the batteries are depleted.**
  - **After the first installation of the battery, please connect the external power source until the battery is fully charged.**
  - **To avoid explosion hazard, do not use the equipment in the presence of flammable anesthetic agent, vapors or liquids. When O<sub>2</sub> is used, keep the ventilator away from any fire sources.**
  - **Do not place the ventilator adjacent to any barrier, which can prevent cold air from flowing, resulting in equipment overheating.**
  - **Do not open the equipment housings. All servicing and future upgrades must be carried out by the personnel trained and authorized by us only.**
  - **Do not rely exclusively on the audible alarm system for patient monitoring. Adjustment of alarm volume to a low level may result in a hazard to the patient. Remember that alarm settings should be customized according to different patient situations and always keeping the patient under close surveillance is the most reliable way for safe patient monitoring.**
  - **The physiological parameters and alarm messages displayed on the screen of the equipment are for doctor’s reference only and cannot be directly used as the basis for clinical treatment.**
  - **To dispose of the package material, observe the applicable waste control regulations. And keep the package material out of children’s reach.**
-

---

---

 **WARNING**

---

- All staff should be aware that disassembling or cleaning some parts of the ventilator can cause risk of infection.
- Maintenance menu can only be accessed when the equipment is disconnected from the patient.
- Positive pressure ventilation may be accompanied by some side effects such as barotrauma, hypoventilation, hyperventilation, etc.
- Using high frequency electrosurgery equipment, defibrillators, or short-wave treatment equipment in the vicinity of the ventilator may interfere with its operation and pose a risk of patient injury.
- Do not use antistatic or conductive masks or patient tubing. They can cause burns if they are used near high frequency electrosurgery equipment.
- Do not use the ventilator in a hyperbaric chamber to avoid potential fire hazard due to an oxygen-enriched environment.
- If the equipment internal monitoring system malfunctions, an alternative plan must be available to ensure adequate level of monitoring. The operator of the ventilator must be responsible for patient's proper ventilation and safety under all circumstances.
- As required by the relevant rules and regulations, oxygen concentration should be monitored when the equipment is used on the patient. If your ventilator is not configured with such monitoring function or this function is turned off, use a monitor which complies with the requirements of ISO 80601-2-55 for oxygen concentration monitoring.
- All analog or digital products connected to this system must be certified to the specified IEC standards (such as IEC 60950 for data processing equipment and IEC 60601-1 for medical electrical equipment). All configurations shall comply with the valid version of IEC 60601-1. The personnel who are responsible for connecting the optional equipment to the I/O signal port shall be responsible for medical system configuration and system compliance with IEC 60601-1 as well.
- Do not touch the patient when connecting the peripheral equipment via the I/O signal ports or replacing the oxygen cell, to prevent patient leakage current from exceeding the requirements specified by the standard.
- This equipment is not suitable for use in an MRI environment.
- When the ventilator's gas supply input system fails or has faults, please contact us immediately for service by specified personnel.
- The ventilator shall not be used with helium or mixtures with Helium.
- Do not move the ventilator before removing the support arm from it, in order to avoid the ventilator getting tilted during the movement.
- The maximum pressure of hose is 1.4MPa@21°C and please check whether

---

---

 **WARNING**

---

gassupply pressure meets hose requirements before usage.

- **Hose connectors adopt standardized gas terminal connector with gas nature. Different types of gas and gas with different pressures shall not be exchanged with each other.**
  - **Hose may be aging quickly by long-term exposure to acidity, alkalinity or ultraviolet rays.**
  - **Don't cascade two or more hose assemblies together.**
  - **Do not block the air intake at the rear of the ventilator.**
  - **To prevent interrupted operation of the ventilator due to electromagnetic interference, avoid using the ventilator adjacent to or stack with other device. If adjacent or stacked use is necessary, verify the ventilator's normal operation in the configuration in which it will be used.**
  - **To prevent possible personal injury and equipment damage, ensure that the ventilator is secured to the trolley or placed on the safe and smooth surface.**
  - **To prevent possible equipment damage, avoid tipping over the ventilator when crossing thresholds.**
  - **To prevent possible equipment damage, push the brake down when parking the ventilator.**
  - **Avoid the use of polluted air. When the equipment uses air as gas source for ventilation, if the air is polluted, harmful substance may enter the patient tubing**
  - **To prevent patient injury caused by equipment malfunction, when the alarm [Technical Error\*\*] occurs, remove the equipment immediately, record failure code, and contact the Customer Service Department.**
  - **To prevent possible ventilator malfunction, do not spill liquid onto the ventilator.**
  - **A turbine can cause gas to be heated. To reduce the temperature of gas inside the tubing and prevent patient injury accordingly, ensure that the length of patient tubing from the humidifier to Y piece is greater than 1.2m.**
  - **The internal electrical power source is to be used if the integrity of the protective earth conductor or the protective grounding system in the installation is in doubt.**
  - **Nebulization or humidification can increase the resistance of breathing system filters, and that you need to monitor the filter frequently for increased resistance and blockage.**
  - **The ventilation accuracy can be affected by the gas added by use of a nebulizer.**
  - **The ventilator shall not be used with nitric oxide.**
  - **For non-invasive ventilation, the exhaled volume of the patient can differ from the measured exhaled volume due to leaks around the mask.**
- 
-

---

---

 **WARNING**

- Check if the alarm limit settings are appropriate before taking measurement.
  - When operating the unit with the power supply unit, always connect the unit to an easily accessible outlet so that it can be unplugged quickly in the event of a malfunction.
  - No modification of this equipment is allowed.
  - Failure to have an alternative means of ventilation such as a self-inflating, manually-powered resuscitator (as specified in ISO 10651-4) with mask can result in PATIENT death if the VENTILATOR fails.
  - Stop using the ventilator and contact us immediately when the buzzer sounds.
  - Under the ambient temperature of 40°C, the inspiratory pressure of the ventilator exceeds 60 cmH<sub>2</sub>O, and the maximum temperature on the surface of breathing mask may exceed 41°C but does not exceed 43°C.
  - When the turbine fails, the ventilator cannot supply the gas to the patient.
- 
- 

### 1.1.3 Cautions

---

 **CAUTION**

- The ventilator must be inspected and serviced regularly by trained service personnel.
  - To ensure patient safety, always prepare resuscitator for use.
  - Always have a special person attend and monitor the operation of the equipment once the ventilator is connected to the patient.
  - During the operation of the ventilator, do not disassemble the inspiration safety valve and expiration valve unless in standby status.
  - To ensure patient safety, use only parts and accessories specified in this manual.
  - At the end of its service life, the equipment, as well as its accessories, must be disposed of in compliance with the guidelines regulating the disposal of such products.
  - Magnetic and electrical fields are capable of interfering with the proper performance of the equipment. For this reason, ensure that all external devices operated in the vicinity of the equipment comply with the relevant EMC requirements. Mobile phone, X-ray equipment or MRI devices are a possible source of interference as they may emit higher levels of electromagnetic radiation.
  - This system operates correctly at the electrical interference levels identified in this manual. Higher levels can cause nuisance alarms that may stop mechanical ventilation. Pay attention to false alarms caused by high-intensity electrical fields.
- 
-

---

---

 **CAUTION**

---

- **Before connecting the equipment to the power line, check that the voltage and frequency ratings of the power line are the same as those indicated on the equipment's label or specified in this manual.**
  - **Always install or carry the equipment properly to avoid damage caused by dropping down, impact, strong vibration or other mechanical force.**
  - **Check whether the patient tubing is damaged or leaked repeatedly before usage. If so, don't use such tubing.**
  - **To electrically isolate the ventilator circuits from all poles of the supply mains simultaneously, disconnect the mains plug.**
  - **To minimize the risk of fire, do not use low-pressure gas tubes that are worn or contaminated with combustible materials like grease or oil.**
  - **It is the clinician's responsibility to ensure that all ventilator settings are appropriate.**
  - **To prevent possible patient injury, ensure the ventilator is set up for appropriate patient type with the appropriate patient tubing. Ensure the System Check is performed before each patient.**
  - **Perform Flow Sensor Calibration before the first use, or when the measured values have deviations.**
  - **To prevent possible patient injury, ensure the ventilation parameters are set up properly before ventilating the patient.**
  - **To ensure the accuracy of oxygen monitoring, replace an exhausted oxygen cell as soon as possible or use an external monitor that complies with ISO 80601-2-55.**
  - **A fan failure could result in oxygen enrichment inside the ventilator and a subsequent fire hazard.**
  - **To reduce the risk of explosion, do not burn the O<sub>2</sub> cell or force the cell open.**
  - **When ventilating with a mask, avoid high airway pressures. High pressures may cause gastric distension.**
  - **Peak pressures, exceeding 33 cmH<sub>2</sub>O, may increase the risk of aspiration due to gastric insufflation. When ventilating with such pressures, consider using an invasive mode.**
  - **To reduce the risk of fire, use only tube systems approved for medical purposes and for use with oxygen between the oxygen source and ventilator.**
  - **To reduce the risk of fire, ensure adequate ventilation at the rear of the ventilator.**
  - **To reduce the risk of fire, switch off the oxygen source when the ventilator is not in a ventilating mode.**
  - **Avoid putting the ventilator in the storage environment of more than 50°C for a long time. Such environment may damage or shorten the battery lives of internal**
-

---

---

## CAUTION

---

battery and oxygen sensor.

- Use the original packing materials to ship the ventilator.
  - To prevent fire hazard, use only specified fuses or fuses with the same type, rated voltage, and rated current as the existing fuses. When it is necessary to replace fuses, contact the Customer Service Department.
  - The ventilator is suitable for use within the **PATIENT ENVIRONMENT**.
  - Additional **MULTIPLE SOCKET- OUTLET** or extension cord shall not be connected to the system.
  - Before moving the ventilator, ensure that the casters and brakes can work properly, and the main unit is locked on the trolley.
- 





### 1.1.4 Notes







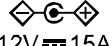











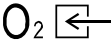
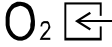





#### NOTE

---



























- Put the ventilator and its accessories in a location where you can easily see the screen and access the operating controls.
  - Keep this manual close to the equipment so that it can be obtained conveniently when needed.
  - The software was developed in compliance with IEC 62304. The possibility of hazards arising from software errors is minimized.
  - This manual describes all features and options. Your equipment may not have all of them.
  - When the oxygen supply is insufficient, the ventilator will automatically switch to the turbine and supply the ambient air to the patient.
  - The ventilator is equipped with barometric pressure sensors, and has the function of barometric pressure compensation.
- 



## 1.2 Equipment Symbols

	Battery		Fuse
	AC/DC power	 12V --- 15A	Direct current input port
RS-232 	RS-232 connector		Nebulizer connector

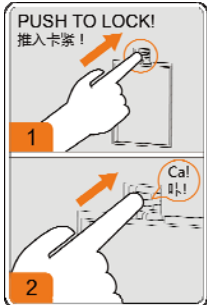
	VGA output connector		Oxygen sensor connector
	Network connector		USB connector
	Power switch		Nurse call connector
	Lock		Unlock
 280-600 kPa 41-87 psi V <sub>max</sub> 120l/min	High-pressure oxygen supply connector	 V <sub>max</sub> 15l/min	Low-pressure oxygen supply connector
	Ventilator gas outlet		Flow sensor
	Expiration connector		Inspiration connector
	AUDIO PAUSED		CO <sub>2</sub> module
	Date of manufacture		Manufacturer
	Serial number	IP21	Degree of protection provided by enclosure
	Caution		Protective earth ground
	no pushing		Refer to the operator's manual
SpO <sub>2</sub>	SpO <sub>2</sub> module		Disassemble the O <sub>2</sub> sensor
	Type BF applied part. Defibrillation-proof protection against electric shock.		MR Unsafe - do not subject to magnetic resonance imaging (MRI)



	European community representative		Temperature limitation
	Humidity limitation		Atmospheric pressure limitation
	This way up		Fragile, handle with care
	Keep dry		Stacking limit by number
	Alarm Setup key		Alarm reset key
	Nebulizer icon		Tools key
	Freeze key		Setup key
	Standby key		O2 ↑ key
	Invasive ventilation icon		Non-invasive ventilation icon
	Adult patient icon		Pediatric patient icon
	Inspiratory trigger icon		ALARM OFF icon
	Recent alarm icon		Multiple alarm icon
	Recyclable		High Efficiency Particle Air (HEPA) installation instruction
	Equipotentiality		

	<p>The following definition of the WEEE label applies to EU member states only.</p> <p>This symbol indicates that this product should not be treated as household waste. By ensuring that this product is disposed of correctly, you will help prevent bringing potential negative consequences to the environment and human health. For more detailed information with regard to returning and recycling this product, please consult the distributor from whom you purchased it.</p> <p>* For system products, this label may be attached to the main unit only.</p>
	<p>The product bears CE mark indicating its conformity with the provisions of the Council Directive 93/42/EEC concerning medical devices and fulfills the essential requirements of Annex I of this directive.</p> <p>Note: The product complies with the Council Directive 2011/65/EU.</p>
	<p>Unified circulation mark indicates that products marked them passed all specified in the technical regulations of the Customs Union of the procedure for the assessment (confirmation) of conformity and complies with the requirements applicable to all the products technical regulations of the Customs Union.</p>

# 2 The Basics

---

---

## 2.1 System Description

### 2.1.1 Intended Use

This product is intended to provide ventilation assistance and breathing support for adult, paediatric and infant patients.

### 2.1.2 Contraindications

There are no absolute contraindications for this product. For some special diseases, however, some necessary treatments shall be taken for ventilator mechanical ventilation, or special ventilation modes shall be adopted to prevent possible patient injury.

### 2.1.3 Components

The ventilator consists of a main unit (including pneumatic circuit, electronic system, mechanical structure, software, display, CO<sub>2</sub> module, SpO<sub>2</sub> module), trolley, and support arm.

Connect the patient to the ventilator via the patient breathing circuit.

The applied part of the ventilator is breathing masks.

---

## 2.2 Equipment Appearance

### 2.2.1 Front View

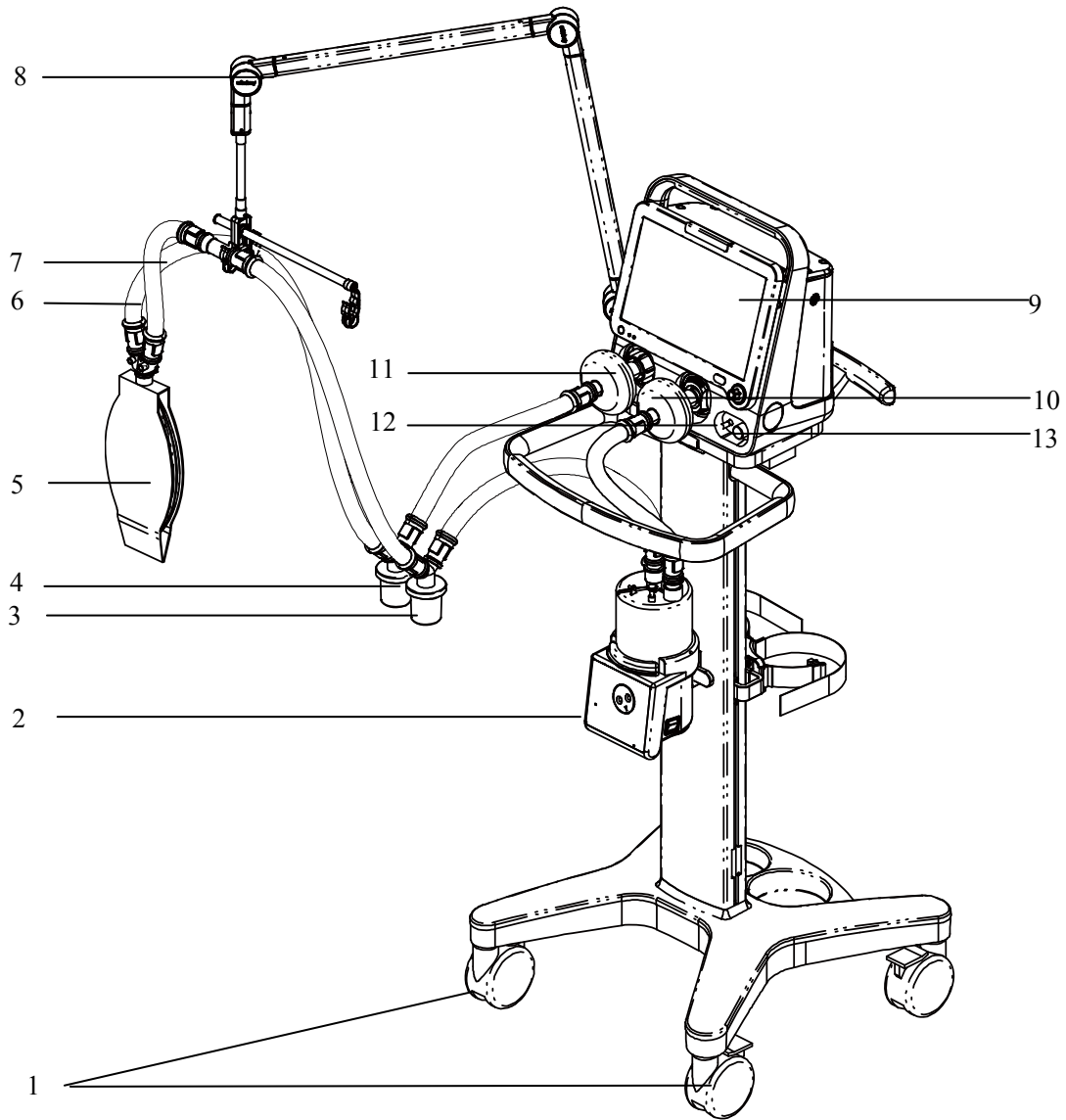

- 
1. Caster and brake  
The ventilator has four casters and all casters have brakes.
  2. Humidifier
  3. Inspiratory water trap  
Collects condensed water in the inspiratory tube.
  4. Expiratory water trap  
Collects condensed water in the expiratory tube.
  5. Test lung
  6. Expiratory tube
  7. Inspiratory tube
  8. Support arm  
Supports and hangs the patient tubing.
  9. Display
  10. Inspiratory filter
  11. Expiratory filter
  12. Nebulizer connector  
Connects the nebulizer.
  13. Leak test plug  
For System Check or Flow Calibration.

---

## 2.2.2 Rear View

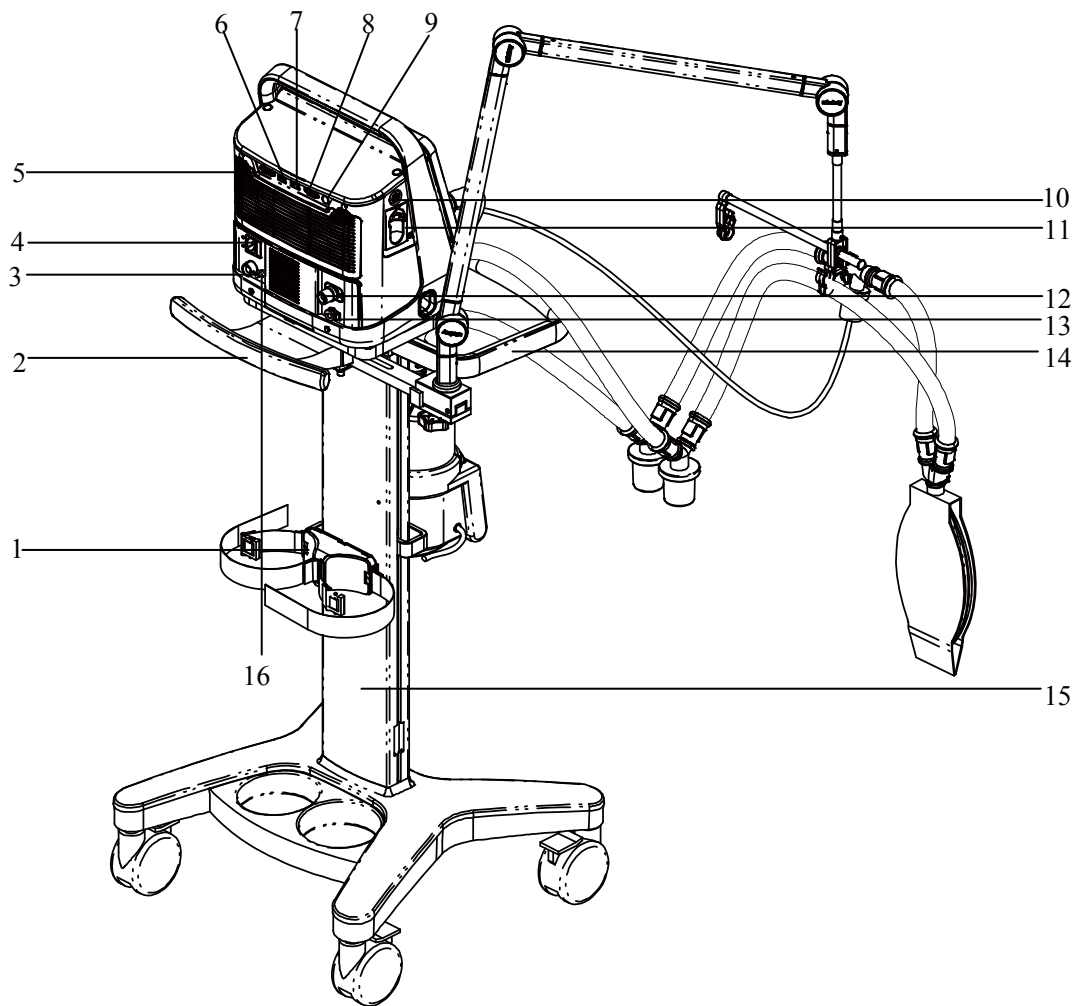

1. Cylinder retaining clip  
For retaining the gas cylinder.
2. Trolley rear handle
3. DC power connector
4. AC power receptacle
5. VGA connector  
Outputs VGA video signals with the same contents to the primary display and connects to the external display (supporting display with resolution of 1280\*800).
6. USB connector  
Conducts ventilator software upgrade, configuration information and history data (such as patient data, alarm log, calibration table) export, configuration transfer between machines of the same type via USB device.

- 
7. Network connector  
A connector which supports connection with a PC to realize software upgrade.
  8. RS-232 connector  
Connects to the external calibration device for calibrating pressure. An external medical device can be connected via this connector to communicate with the ventilator.
  9. Nurse call connector  
Connects to the hospital's nurse call system and outputs nurse call signals when an alarm occurs.
  10. SpO<sub>2</sub> connector  
Connects a SpO<sub>2</sub> sensor to monitor the patient's pulse and SpO<sub>2</sub>.
  11. CO<sub>2</sub> module  
Mainstream or sidestream CO<sub>2</sub> module for optional configuration. The connector varies depending on the configured module.
  12. Inlet of high-pressure O<sub>2</sub> supply
  13. Inlet of low-pressure O<sub>2</sub> supply
  14. Trolley front handle
  15. Trolley
  16. Equipotential stud / lug  
Provides a ground point. Eliminates the ground potential difference between different devices to ensure safety.

---

**FOR YOUR NOTES**



# 3 Installations and Connections

---

---

## WARNING

---

- Do not use antistatic or conductive masks or patient tubing. They can cause burns if they are used near high frequency electrosurgery equipment.
  - To ensure optimum performance of the ventilator, re-do System Check each time after changing the patient type, replacing the accessories or components like patient tubing, humidifier, and filter.
  - Adding accessories or other components to the breathing system of the ventilator can increase system inspiratory and expiratory resistance.
- 

### 3.1 Install the Main Unit

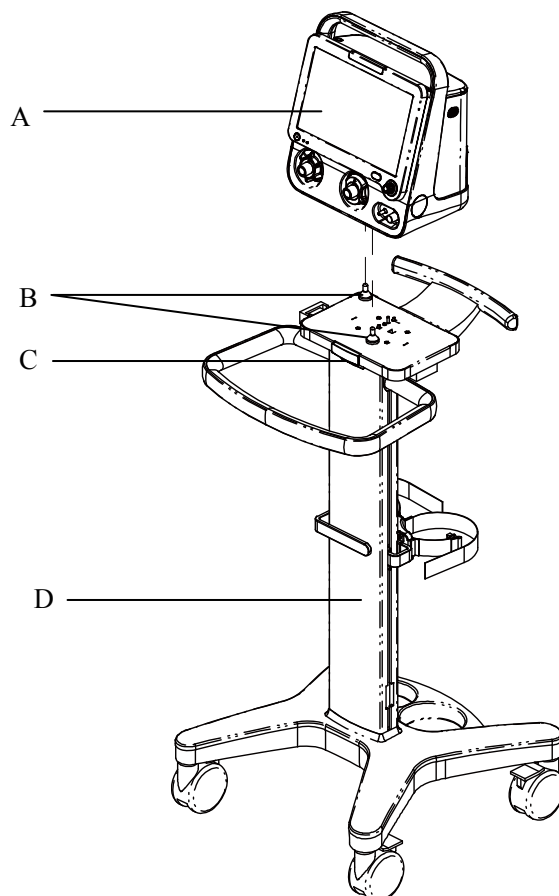

A. Main unit    B. Positioning post    C. Trolley unlocking button    D. Trolley

Align the main unit with the two positioning posts on the trolley and put it onto the trolley in place.

To remove the main unit from the trolley, depress the trolley unlocking button and then lift it up with both hands.

---

## 3.2 Connect to the Power Supply

### 3.2.1 Connect to AC Power

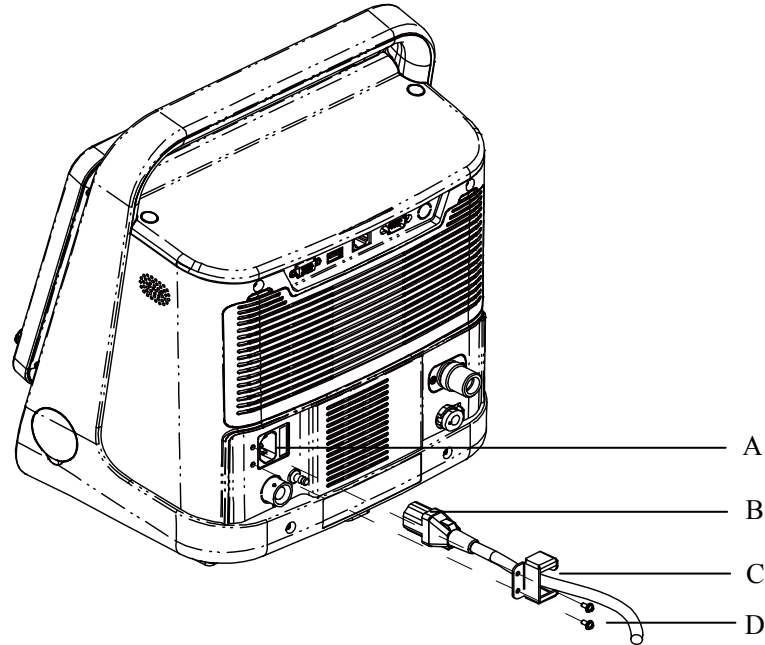

- A. AC power receptacle                      B. AC power cord  
C. Power cord retainer                      D. Screw

1. Insert the AC power cord into the AC power receptacle.
2. Place the power cord retainer above the power receptacle and align it with the screw holes.
3. Tighten the two screws.

---

### 3.2.2 Connect to DC Power

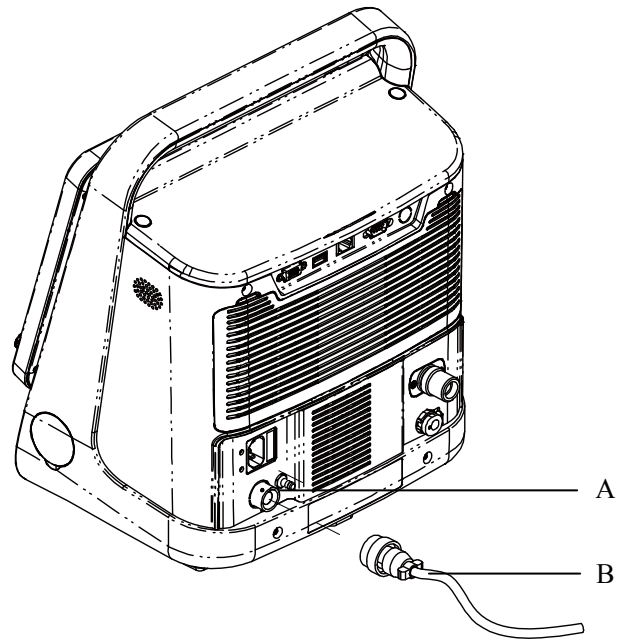

A. DC power connector

B. DC power cord

Insert the DC power cord into the DC power connector and then rotate the DC power cord clockwise. When a click is heard, it indicates that the DC power cord is inserted in place.

---

### 3.3 Connect to the Gas Supply

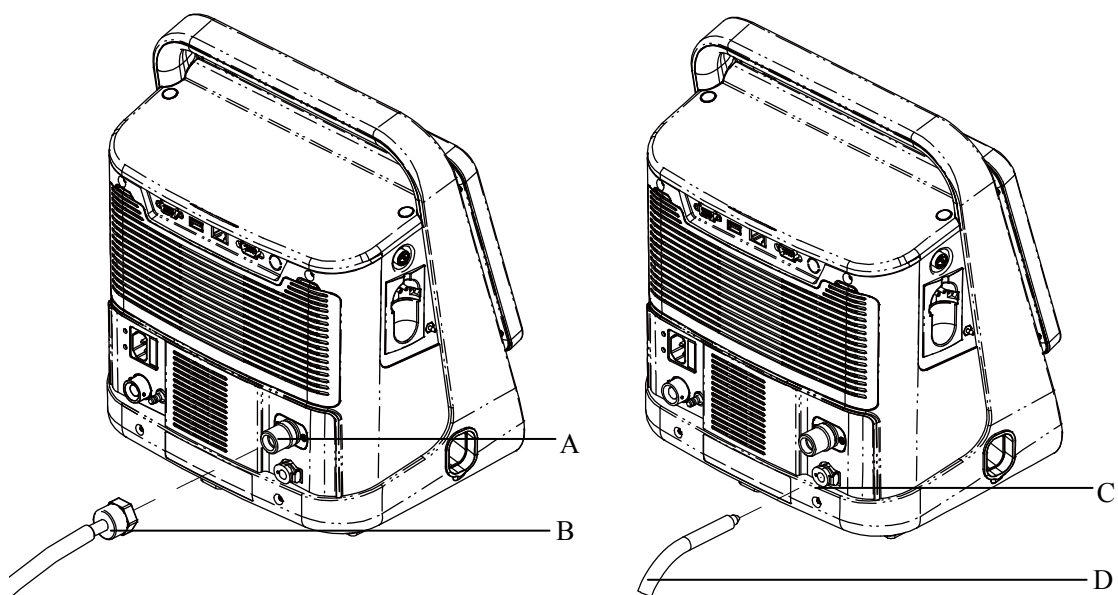

- A. High-pressure O<sub>2</sub> supply connector      B. High-pressure O<sub>2</sub> supply hose and fitting  
C. Low-pressure O<sub>2</sub> supply connector      D. Low-pressure O<sub>2</sub> supply hose

This ventilator provides two types of gas supply connection: high-pressure O<sub>2</sub> and low-pressure O<sub>2</sub>.

When the ventilator is connected to high-pressure O<sub>2</sub> supply, the normal working gas supply pressure is 280~600KPa. If gas supply pressure is less than 280KPa, it will compromise the performance of the ventilator and even stop ventilation. If gas supply pressure is within 600~1000KPa, it will compromise the performance of the ventilator but will not cause any hazard due to high-pressure gas. Connect the high-pressure O<sub>2</sub> supply as follows:

1. Check if the sealing ring at the gas supply connection is in good condition before connecting the gas supply hose. If the sealing ring is damaged, do not use the hose. Replace the sealing ring to prevent leakage.
2. Align the connector with and insert it into the inlet of high-pressure O<sub>2</sub> supply at the rear of the ventilator.
3. Ensure that the gas supply hose is properly connected to the gas supply inlet. Tighten the hose nut by hand.

When the ventilator is connected to low-pressure O<sub>2</sub> supply, the flow of low-pressure O<sub>2</sub> supply cannot exceed 15 L/min. To reduce the risk of fire, do not use a low-pressure O<sub>2</sub> supply that delivers a flow greater than 15 L/min. To connect the low-pressure O<sub>2</sub> supply, align the low-pressure O<sub>2</sub> supply hose with and insert it into the low-pressure O<sub>2</sub> supply connector. When a click is heard, it indicates that the gas supply hose is inserted in place. Depress the metal dome on the low-pressure O<sub>2</sub> supply connector to remove the gas supply hose.

---

---

 **WARNING**

- **Inspect the O<sub>2</sub> supply connector carefully and ensure there is no leakage. If gas leakage is significant, O<sub>2</sub> concentration in the ambient environment will exceed normal O<sub>2</sub> concentration in atmosphere, resulting in potentially dangerous O<sub>2</sub> enriched environment.**
  - **Place the O<sub>2</sub> supply hose carefully, avoiding exposure to the environment in which possible damage to the O<sub>2</sub> supply hose is easily caused by cut or heating.**
  - **To reduce the risk of fire, do not use a low-pressure O<sub>2</sub> supply that delivers a flow greater than 15 L/min.**
- 

---

---

 **CAUTION**

- **When the ventilator is sourced from an oxygen concentrator, never operate the concentrator with a humidifier. Any humidifier system supplied with the concentrator must be drained or removed before using the ventilator.**
  - **The ventilator's oxygen control is not active when low-pressure oxygen is used. To prevent possible patient injury, use low-pressure oxygen only in cases that the low-pressure supply can provide an adequate level of oxygenation.**
  - **Before starting ventilation, ensure the appropriate oxygen source, either high-pressure oxygen (HPO) or low-pressure oxygen (LPO), was selected during configuration, referring to 5.13 Set O<sub>2</sub> Supply Type.**
  - **To prevent possible patient injury, ensure that an emergency backup O<sub>2</sub> supply (for example, a gas cylinder) is available in case the low-pressure O<sub>2</sub> supply fails.**
  - **The low-pressure O<sub>2</sub> supply hose assembly shall comply with the requirements of ISO 5359.**
-

---

### 3.4 Install the Support Arm

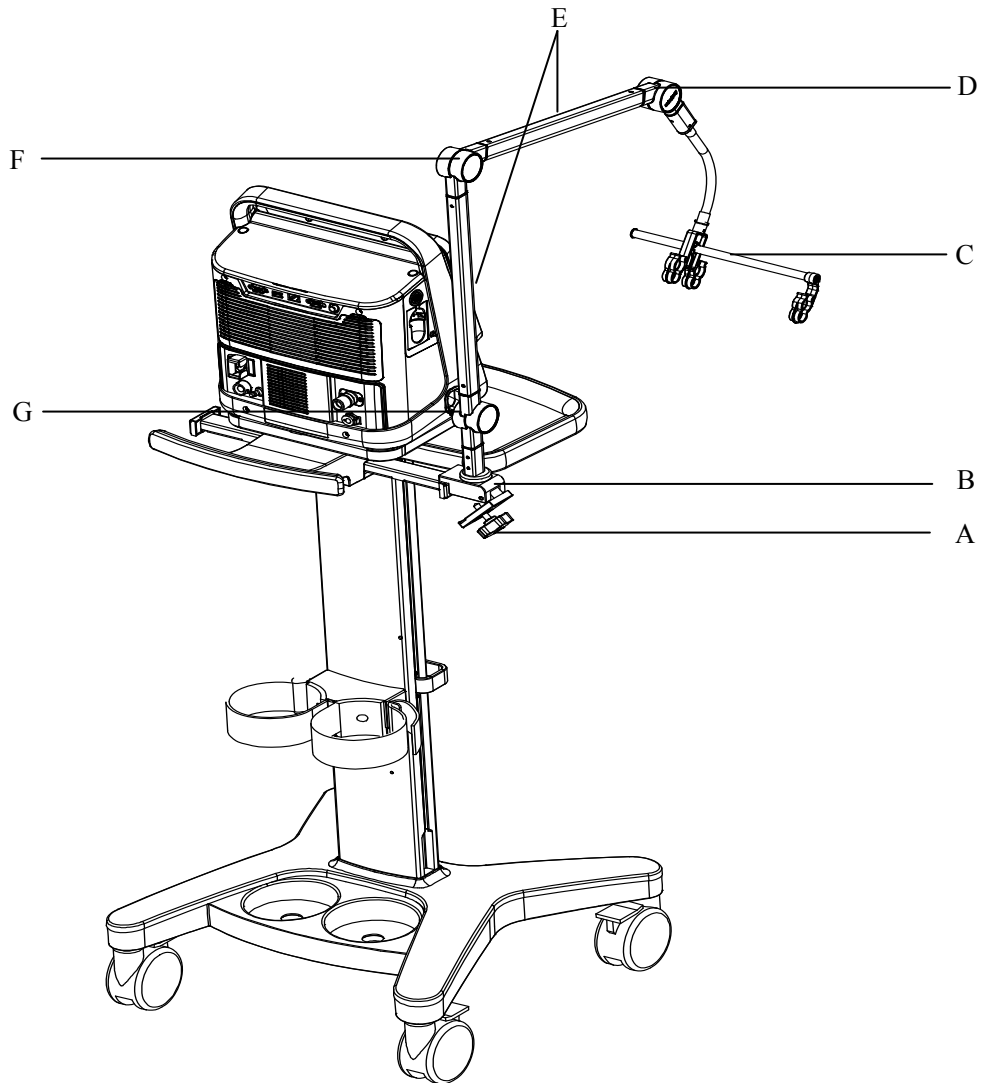

- |                      |                 |                      |
|----------------------|-----------------|----------------------|
| A. Fixing block knob | B. Fixing block | C. Tube hook         |
| D. Support arm joint | E. Support bar  | F. Support arm joint |
| G. Support arm joint |                 |                      |



- 
1. Loosen the fixing block knob. Place the fixing block onto the handle on the side of the ventilator.
  2. Tighten the fixing block knob.

---

## **WARNING**

---

- **To prevent possible patient injury due to accidental extubation, check the support arm joints and the connection security as necessary.**
- 

3. Adjust the support arm.
  - Support arm joint F or G: to adjust the upward-bending angle of the support arm, only lift up the support bar to the desired position without the need to push the blue unlocking button . To adjust the downward-bending angle of the support arm, lift up the support bar, and then push and hold the blue button  on support arm joint with one hand, and hold the support bar and press it downward with the other hand. Release the blue unlocking button  after adjusting the support bar to the desired position. Support arm joint F or G can be adjusted for up to 130°.
  - Support arm joint D: swivel upward or downward to the desired position.
  - Hold the bottom of support arm or the support bar beside support arm joint G and swivel it to the left, or to the right, with force to rotate the support arm to the desired position.
4. Place the patient tubing onto the tube hook.

## **NOTE**

---

- **Operate support arm joint F or G with both hands as shown below. Operating with a single hand will bring some risks.**



- **The maximum weight of the support arm is 1 kg.**
  - **The support arm can be fixed onto the handle on the either side of the ventilator.**
-

---

## 3.5 Install the Patient Tubing

---

### **WARNING**

---

- To minimize the risk of bacterial contamination or physical damage, handle bacteria filters with care.
  - To prevent patient or ventilator contamination, always use a bacteria filter between the ventilator and the patient inspiratory limb.
- 

### **CAUTION**

---

- The use of an expiratory filter may lead to a significant increase in expiratory resistance. Excessive expiratory resistance may compromise ventilation and increase patient's work of breathing and intrinsic PEEP.
  - The patient tubing shall comply with the requirements of ISO 5367.
  - The bacteria filters shall comply with the requirements of ISO 23328-1 and ISO 23328-2.
  - The Heat & Moisture Exchange (HME) shall comply with the requirements of ISO 9360-1 and ISO 9360-2.
-



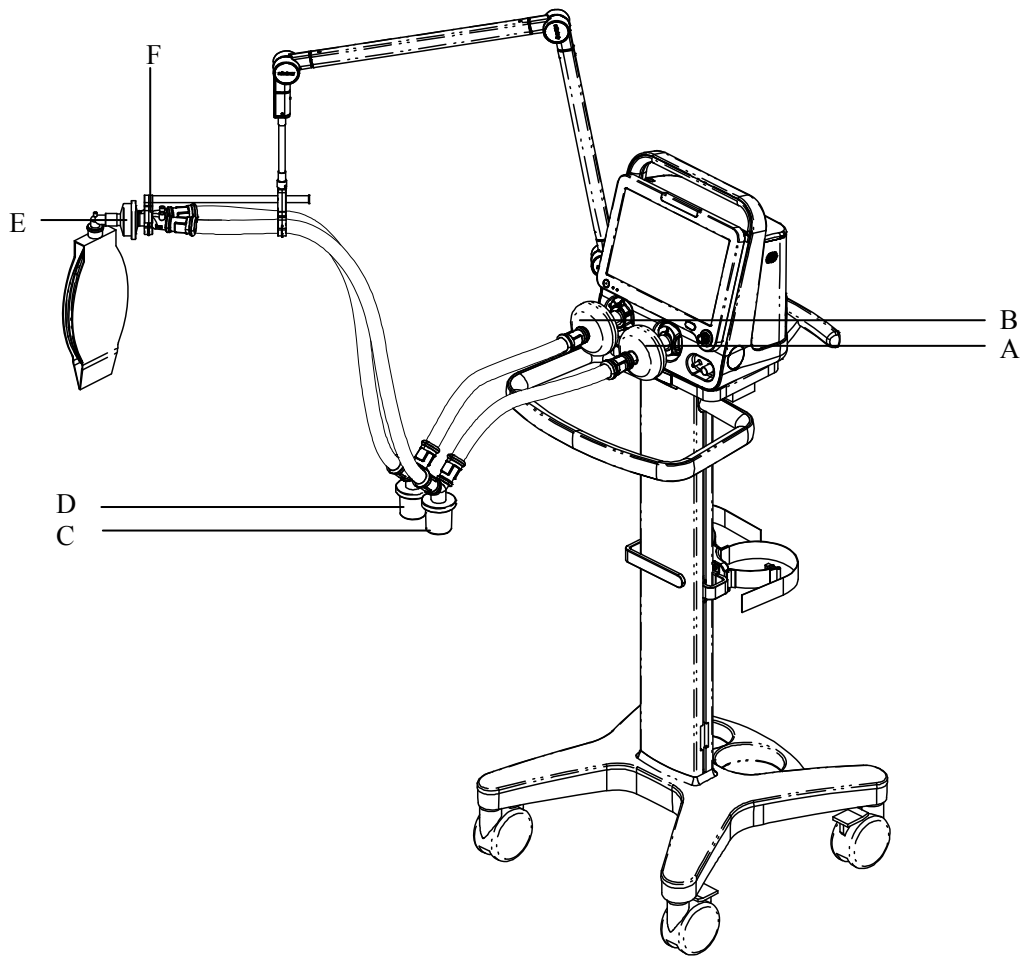

- |                           |                          |
|---------------------------|--------------------------|
| A. Inspiratory filter     | B. Expiratory filter     |
| C. Inspiratory water trap | D. Expiratory water trap |
| E. HME                    | F. Support arm hook      |

Connect the patient to the ventilator via the patient breathing circuit.

1. Mount the filters onto the inspiratory and expiratory ports.
2. Connect the inspiratory filter to the water trap via the tube. Connect the other end of the tube to the Y piece.
3. Connect the expiratory filter to the water trap via the tube. Connect the other end of the tube to the Y piece.
4. Connect the patient side of the Y piece to the HME and then connect the HME to the patient.
5. Place the patient tubing onto the support arm hook.

---

## 3.6 Install the Humidifier

---

### WARNING

- To prevent possible patient injury and equipment damage, do not turn on the humidifier until the gas flow has started and is regulated.
  - To prevent possible patient injury and equipment damage, ensure the humidifier is set to appropriate temperature and humidity.
- 
- 

### NOTE

- The humidifier shall comply with the requirements of ISO 8185. The humidifier assembly and its installation steps described in this section are only for reference.
- 
- 

### 3.6.1 Install the Humidifier onto the Ventilator

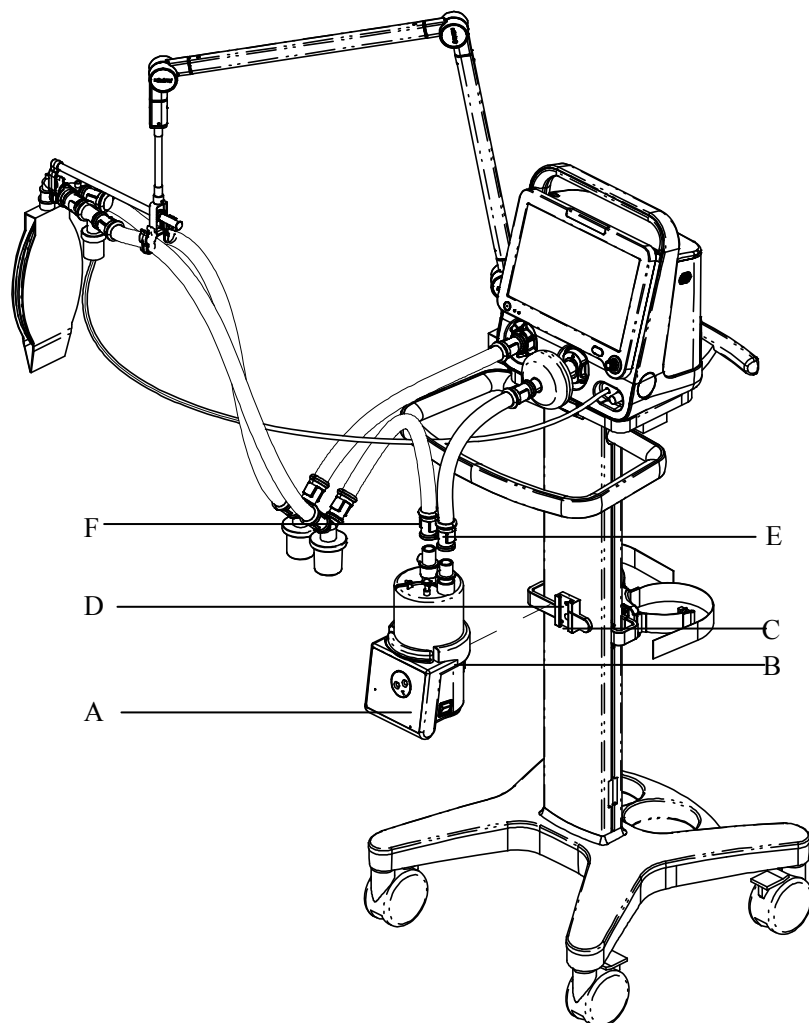

- 
- |               |                              |                            |
|---------------|------------------------------|----------------------------|
| A. Humidifier | B. Humidifier mounting plate | C. Humidifier bracket slot |
| D. Screw      | E. Humidifier inlet          | F. Humidifier outlet       |

1. Align the humidifier mounting plate and the slot, and slide the humidifier in.
2. Tighten the screw.
3. Mount the filters onto the inspiratory and expiratory ports.
4. Connect the inspiratory filter to the humidifier inlet via the tube.
5. Connect the humidifier outlet to the water trap via the tube. Then, connect the water trap to the Y piece via the tube.
6. Connect the expiratory filter to the water trap via the tube. Then, connect the water trap to the Y piece via the tube.
7. Place the patient tubing onto the support arm hook.

The rated range of the ventilator breathing system (VBS):

Inspiratory and expiratory gas pathway resistance: 0 to 6 cmH<sub>2</sub>O/ (L/s) at 60 L/min

VBS compliance: 0 to 5 mL/cmH<sub>2</sub>O.

---

### 3.6.2 Install the Humidifier onto the Pendant

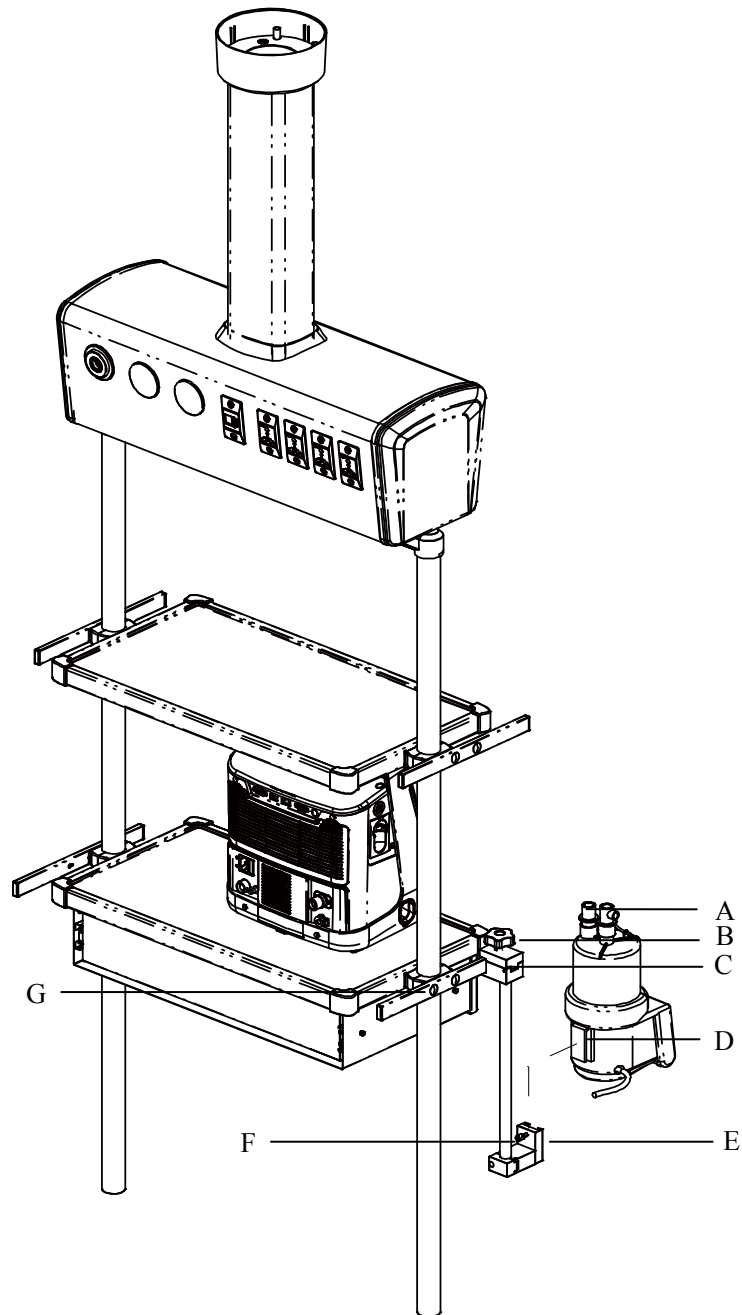

- |                              |                            |                 |
|------------------------------|----------------------------|-----------------|
| A. Humidifier                | B. Fixing block knob       | C. Fixing block |
| D. Humidifier mounting plate | E. Humidifier bracket slot | F. Screw        |
| G. Beam                      |                            |                 |

- 
1. Loosen the fixing block knob. Place the fixing block onto the pendant beam.
  2. Tighten the fixing block knob.
  3. Align the humidifier mounting plate and slot, and slide the humidifier in.
  4. Tighten the screw.
  5. Install the patient tubing. For details, refer to steps 3 through 7 in **3.6.1 *Install the Humidifier onto the Ventilator.***

---

 **WARNING**

---

- **When installing the humidifier, ensure that the humidifier connector shall be lower than the ventilator's breathing connectors and the patient.**
- 

## **3.7 Install the Nebulizer**

### **NOTE**

---

- **Install the specified nebulizer. The nebulizer assembly and its installation steps described in this section are only for reference. Refer to the nebulizer accompanying directions for use to install and use the nebulizer.**
  - **To prevent the expiration valve from sticking due to nebulized medications, use only medications approved for nebulization, and regularly check and clean or replace the expiration valve membrane.**
  - **Do not use an expiratory filter or HME in the patient's breathing circuit during nebulization. Nebulization can cause an expiratory side filter to clog, substantially increasing flow resistance and impairing ventilation.**
  - **Connect the nebulizer to the inspiratory limb. Connecting the nebulizer between the patient connector and the endotracheal tube increases dead space ventilation.**
-

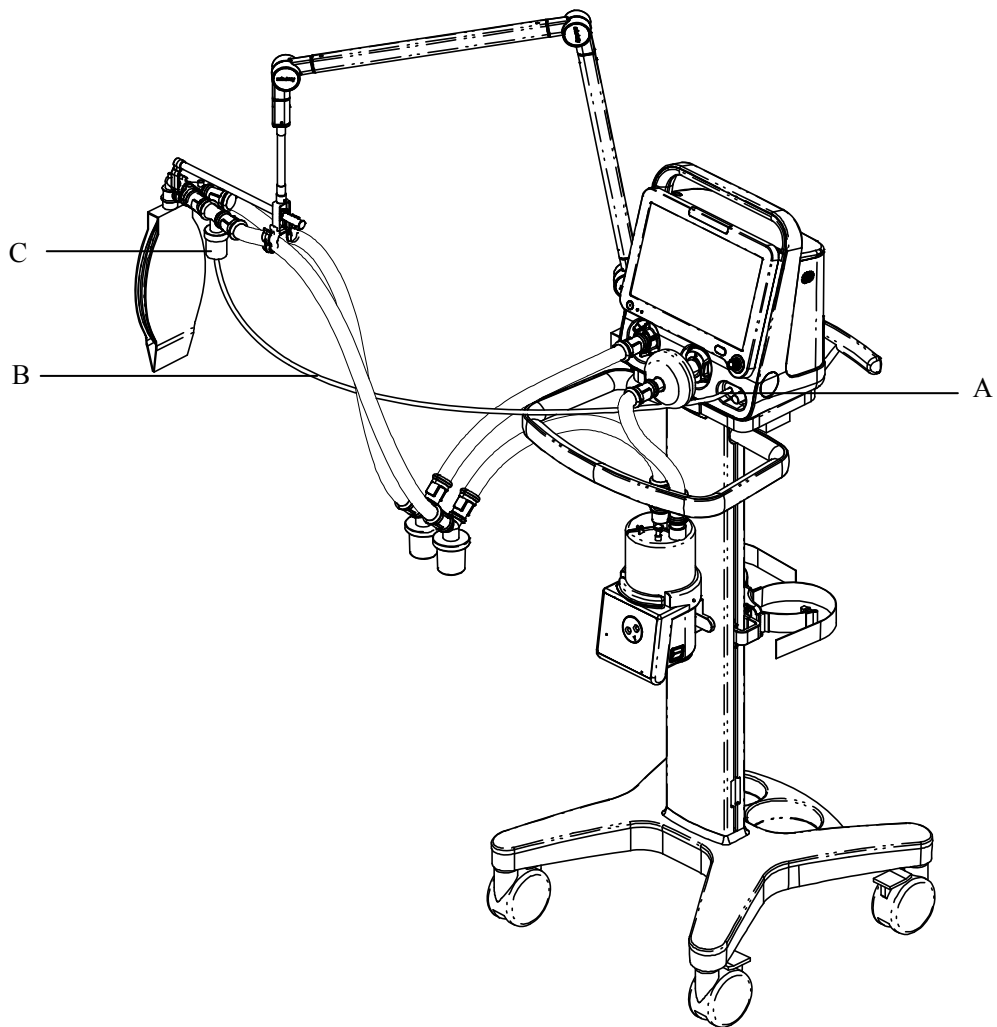

A. Nebulizer connector

B. Nebulizer tube

C. Nebulizer

1. Connect one end of the nebulizer tube to the nebulizer connector and the other end to the nebulizer.
2. Install the nebulizer to the inspiratory limb via the tube.

---

## 3.8 Install the O<sub>2</sub> Sensor

---

### CAUTION

- To reduce the risk of explosion, do not burn the O<sub>2</sub> cell or force the cell open.
- 

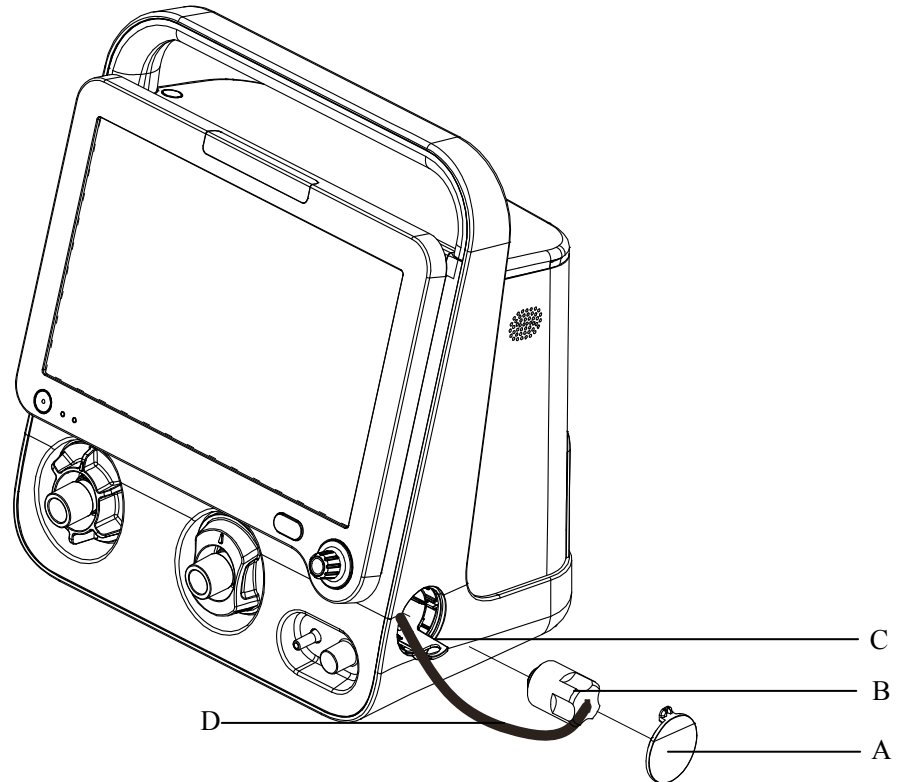

- |                               |   |
|-------------------------------|---|
| A. O <sub>2</sub> sensor door | B. O <sub>2</sub> sensor                  |
| C. Fixing seat                | D. O <sub>2</sub> sensor connection cable |

1. Rotate the O<sub>2</sub> sensor clockwise to install it.
2. Push the O<sub>2</sub> sensor and its fixing seat into the ventilator.
3. Connect the O<sub>2</sub> sensor connection cable.
4. Close the O<sub>2</sub> sensor door.

---

## 3.9 Install the Gas Cylinder

---

### CAUTION

---

- Ensure that the gas cylinder is equipped with pressure-reducing valve.
- 

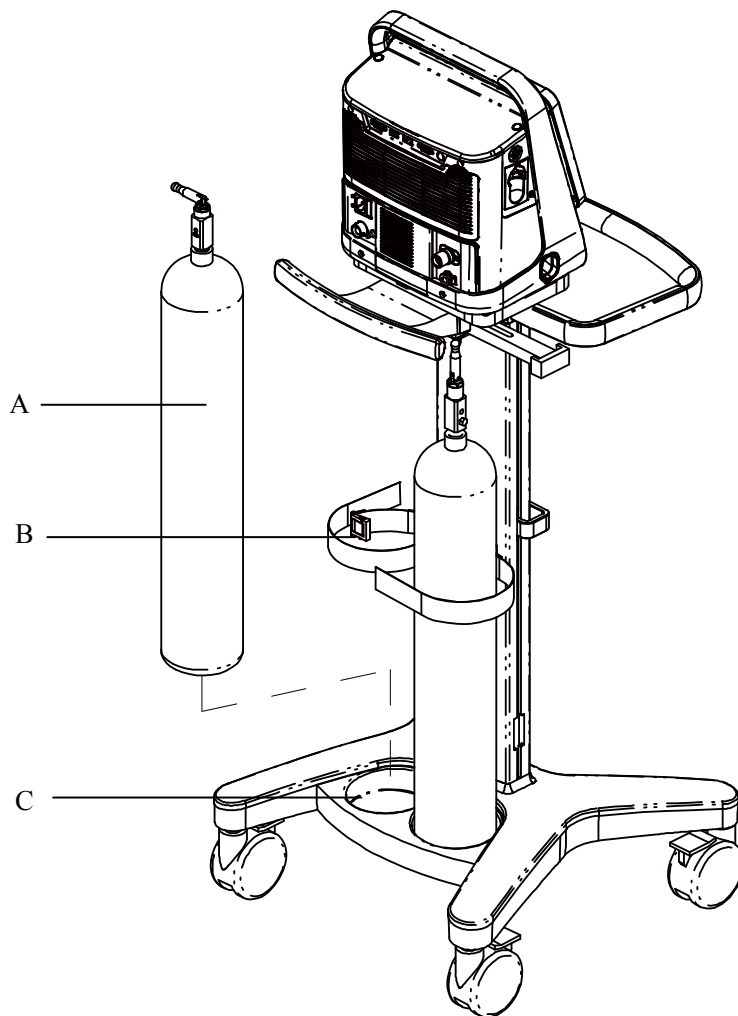

A. Gas cylinder

B. Cylinder fixing buckle

C. Trolley base

1. Place the gas cylinder onto the trolley base.
2. Fix the gas cylinder via cylinder fixing buckle.



# 4 User Interface

---

---

## 4.1 Display Controls

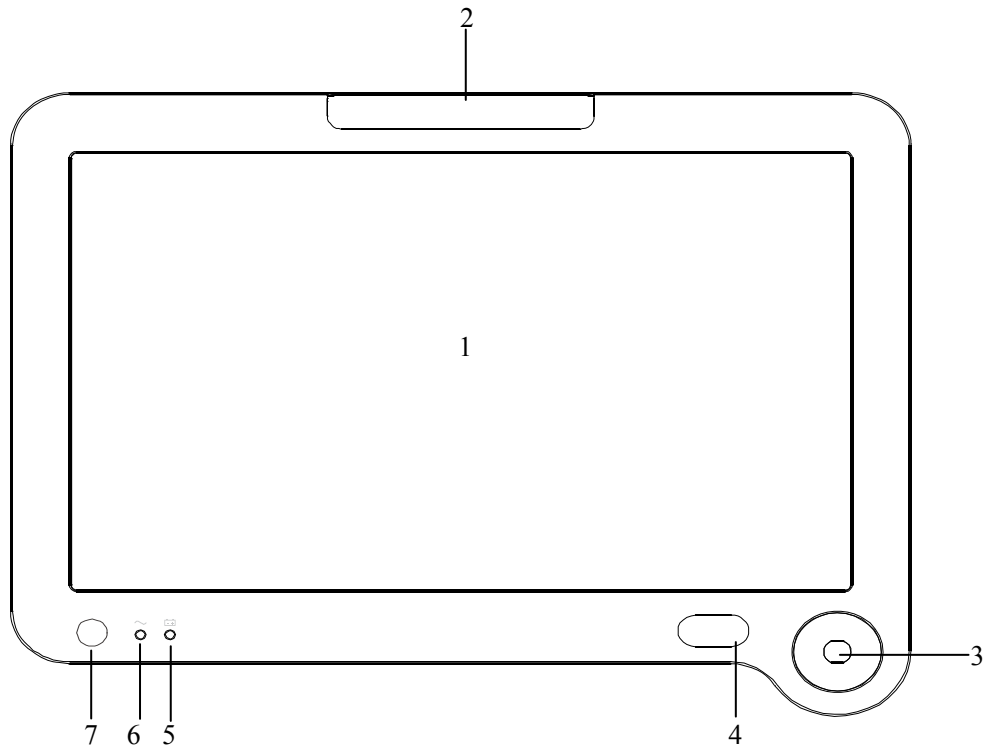

The control unit is characterized by a small number of operating elements. Its main elements are:

1. Display (touch screen)

The display shows the software screen of the ventilator system. You can select and change settings by touching the screen.

2. Alarm indicator light

The alarm indicator light indicates the priority of an active alarm by flashing different colors at different frequencies.

3. Control knob

Press to select menu items or confirm settings and rotate clockwise or counter-clockwise to scroll through menu items or change settings.

---

4. AUDIO PAUSED key

Press to initiate AUDIO PAUSED for 120 seconds, so that audible alarm tones of the active alarms are switched off. If AUDIO PAUSED exceeds 120 seconds, the AUDIO PAUSED status terminates automatically and audible alarm tones are restored. If a new alarm is triggered under AUDIO PAUSED status, the AUDIO PAUSED status terminates automatically and audible alarm tones are restored. Under the AUDIO PAUSED status, press this key a second time to terminate AUDIO PAUSED status.

5. Battery indicator light

- Lit: when the battery is being charged or is already fully charged, and the ventilator is operating on external power supply (AC power or DC power).
- Flash: when the ventilator is operating on battery power.
- Not lit: when the ventilator is not connected to an external power supply (AC power or DC power), or the ventilator is not equipped with a battery, or the ventilator battery is faulty.

6. External power indicator light

- Lit: when the ventilator is connected to an external power supply (AC power or DC power).
- Not lit: when the ventilator is not connected to an external power supply (AC power or DC power).

7. Power switch (with indicator light)

Press to power on/off the system. Switch is lit when the system powers on the ventilator and not lit when the system powers off the ventilator.

The ventilator display shows ventilation parameters, pressure/flow/volume waveforms and spirometry loops, etc.

The following is an example of Waveforms screen. Display screen may vary subject to the configurations.

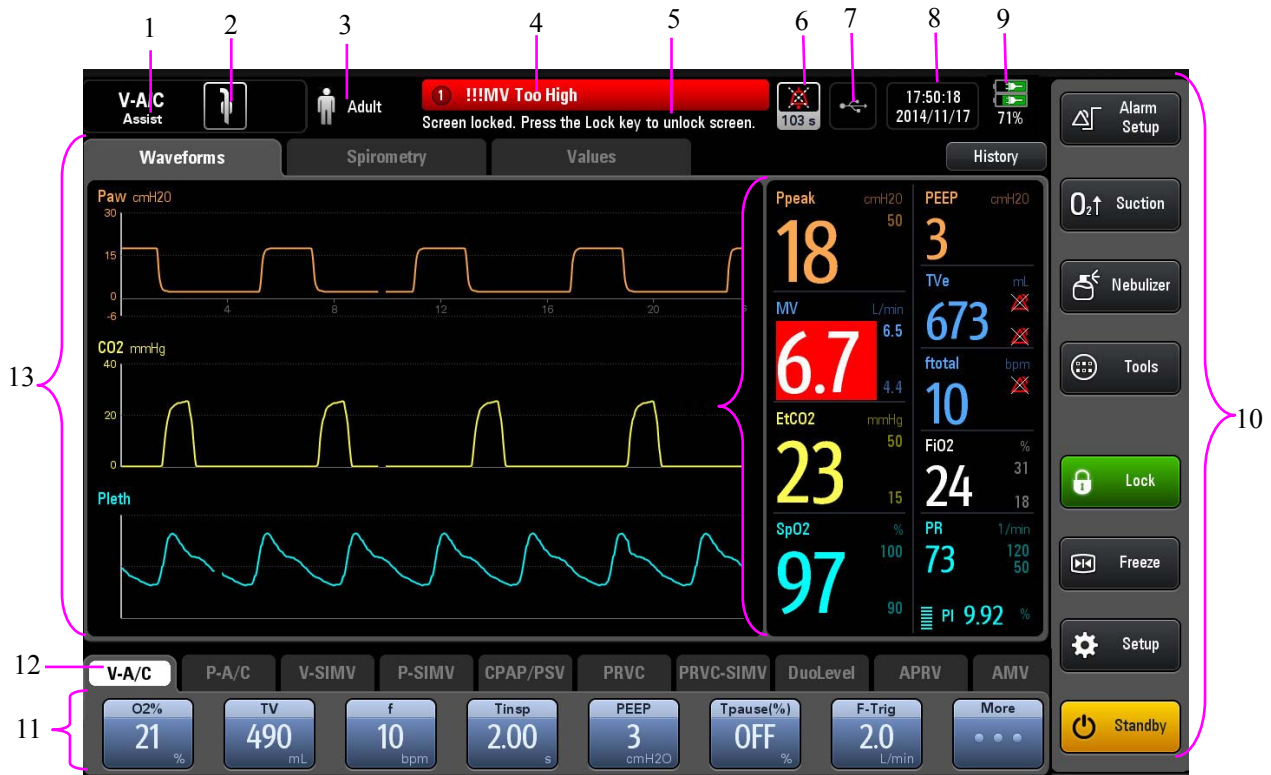



1. Ventilation mode field

Displays Standby or active ventilation mode and ventilation assist indication.

2. Ventilation type field

Displays Non-invasive or Invasive ventilation type:

- ◆ Displays the icon  for Non-invasive mask and NIV word when the ventilation type is Non-invasive.
- ◆ Displays the tube icon  when the ventilation type is Invasive and the ATRC function is switched off.
- ◆ Displays the tube icon , ATRC, and tube ID when the ventilation type is Invasive and the ATRC function is switched on.

3. Patient type / Inspiratory trigger icon field

Indicates current patient type: Adult or Pediatric. The icon for Inspiratory trigger is , which is displayed for 1 s.

---

4. Alarm message field

Displays the active alarm messages. When there are multiple alarm messages, the number of alarms is displayed. In this case, select the alarm message field, and you can view active alarm messages, alarm occurrence time and alarm level on the accessed window.

5. Prompt message field

Displays the active prompt messages.

6. AUDIO PAUSED icon and countdown field/inactive alarm prompt field

When the icon for 120-second AUDIO PAUSED countdown, which is , is displayed, it indicates that there are active alarms and the audible alarm tones are paused.

When the icon  is displayed, it indicates that there are most recent alarms but the alarm conditions disappear. Press this icon, and you can view the most recent alarms (up to 9 alarm messages are displayed) on the accessed window. You can also clear the most recent inactive alarms with the [**Reset**] button.

7. USB icon field

Displayed when the system is connected to an identifiable USB device.

8. System time field

Displays current system time.

9. Power status icon field

Displays the status of currently-used power supply.

10. Soft key field

Displays soft keys: Alarm Setup, O<sub>2</sub>↑ Suction, Nebulizer, Tools, Lock, Freeze, Setup and Standby.

11. Parameter setup quick key field

Displays ventilation setting parameters corresponding to the active ventilation mode.

12. Ventilation mode setup field

Displays the keys for setting up ventilation modes.

13. Waveforms/Spirometry/Values field

Displays waveforms, spirometry loops, or measured values.

14. Numerics

Displays measured values of most important parameters, as well as alarm limit values (where applicable), and alarm notification (flashing if alarm activated).

## 4.2 Waveforms Screen

Select the [Waveforms] button to access the screen as shown below.

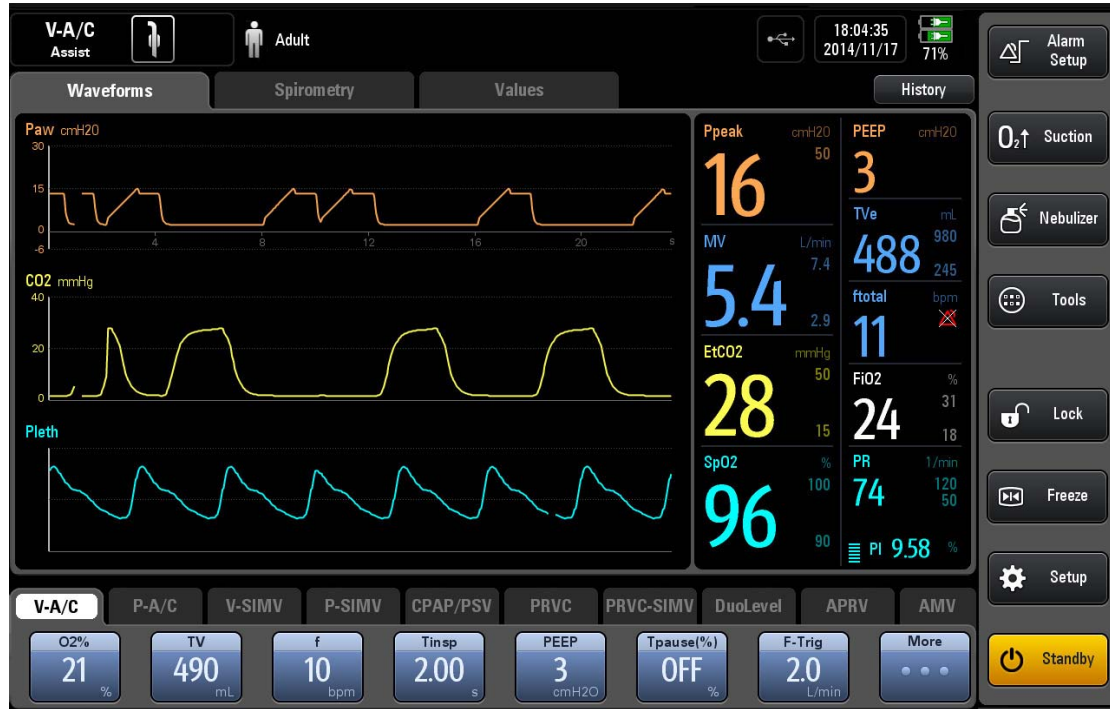

## 4.3 Spirometry Screen

Select the [Spirometry] button to access the screen as shown below.

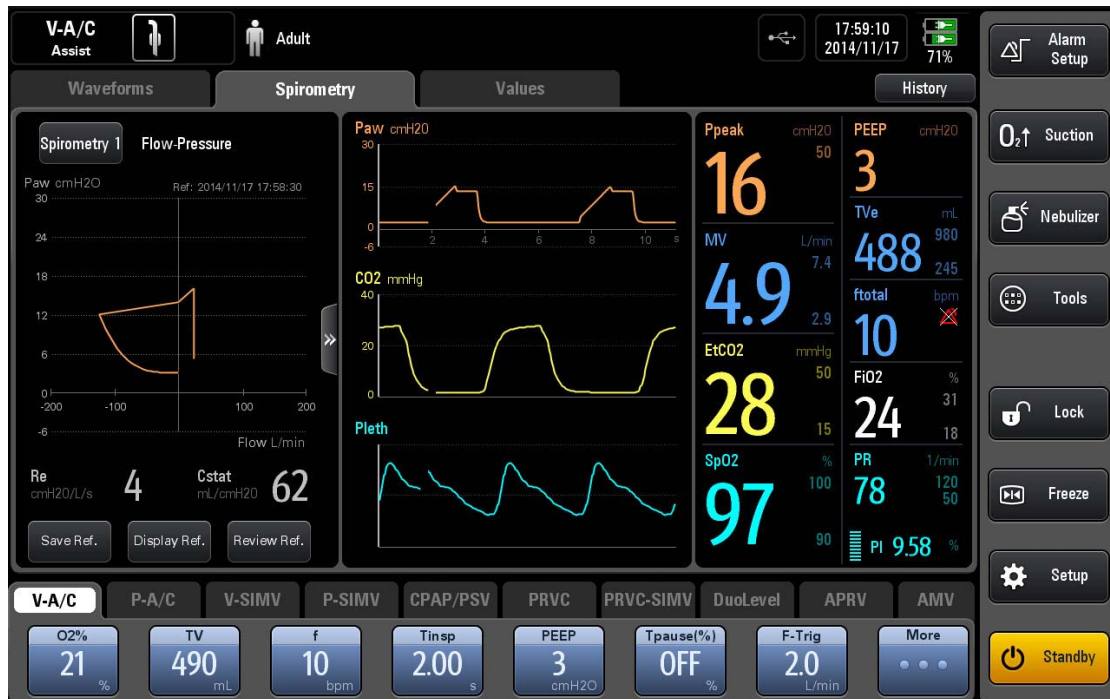

The screen as shown below is displayed by pressing the  button.

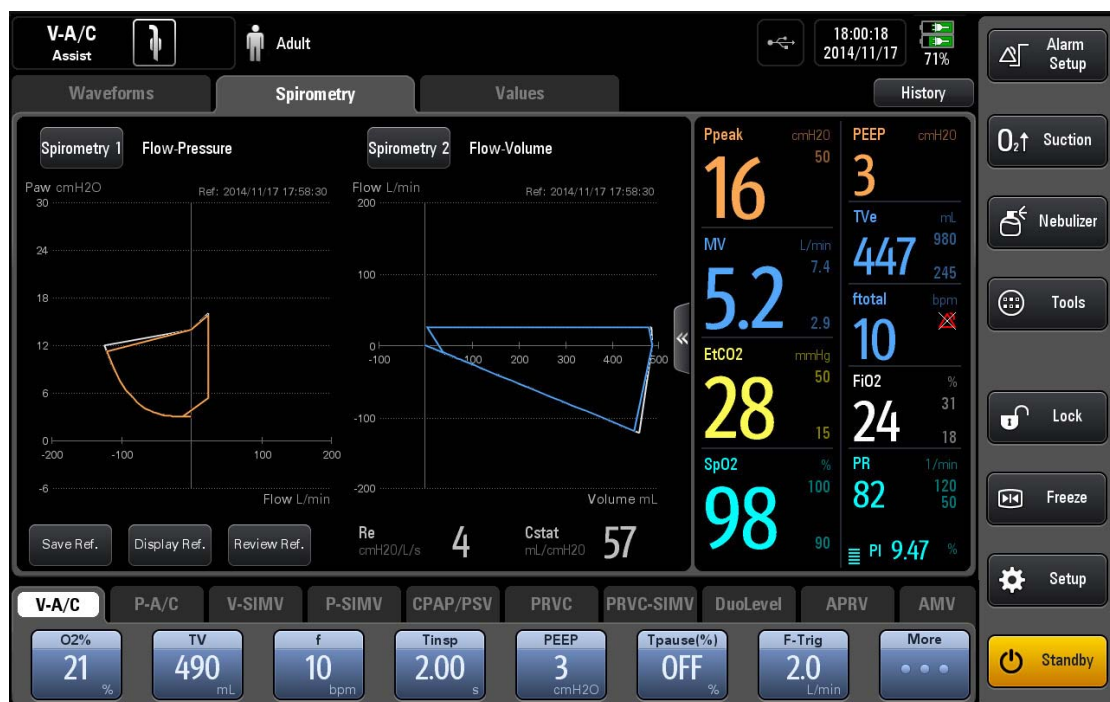

---

Spirometry loops reflect patient lungs function and ventilation condition as well, such as the patient's lungs compliance, over-inflation, breathing system leakage and airway blockage.

The system provides three types of spirometry loops: P-V (pressure-volume) loop, F-V (flow-volume) loop, and F-P (flow-pressure) loop. The data of P-V loop, F-V loop and F-P loop come from pressure, flow, and volume waveform data. When a mainstream CO<sub>2</sub> module is configured, a V-CO<sub>2</sub> loop can be displayed, as shown below.

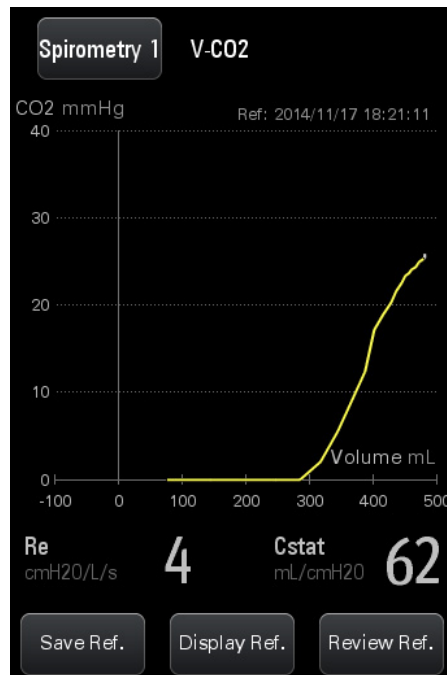

Up to two types of spirometry loop are displayed at a time. To select the desired loop:

1. Select [**Spirometry**] on the main screen.
2. Select [**Spirometry 1**] or [**Spirometry 2**] to set the desired loop or V-CO<sub>2</sub> loop to be displayed.

The ventilator provides the function of reference loop. When [**Save Ref.**] is selected, the loop of current breathing cycle is saved as reference loop, and the time when the reference loop is saved is displayed. By selecting [**Display Ref.**] and then selecting time, the reference loop saved at that time can be viewed. By selecting [**Display Ref.**] and then selecting [**OFF**], the currently displayed reference loop is hidden.

The ventilator saves up to 5 reference loops. If 5 reference loops are already saved, when [**Save**] is selected again, the system automatically clears the oldest reference loop and saves the loop of current breathing cycle as reference loop.

Select the **[Review Ref.]** button to display the window as shown below.

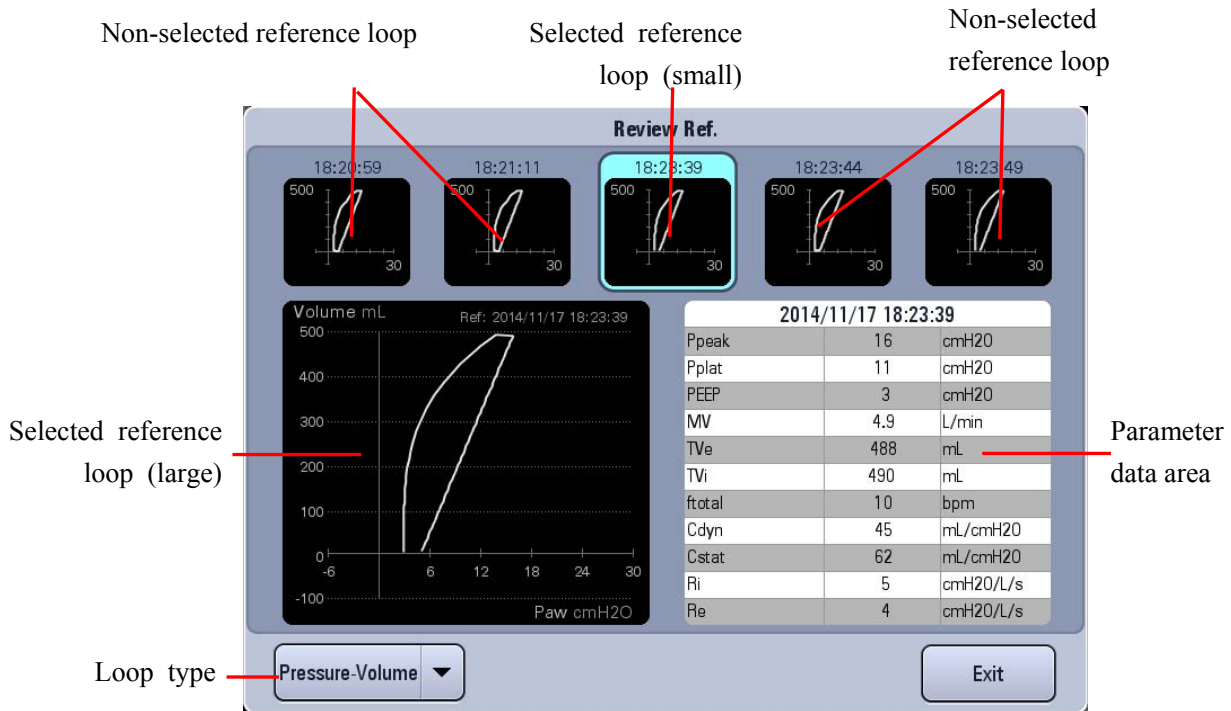

- **Small loop windows :** These small graphic windows show the reference loops. The reference loops (up to 5) are displayed from oldest (left) to newest (right). The information of selected reference loop is displayed in cyan highlight.
- **Large loop window :** This graphic window shows an enlarged view of the selected reference loop.
- **Loop type :** The Loop Type selection is used to choose the type of loop to review. The choices are P-V , F-V, P-F, and V-CO<sub>2</sub>. Default loop type is P-V.
- **Parameter data area :** This area displays monitored parameter data related to the saved reference loops.



## 4.4 Measured Values Screen

When the sidestream CO<sub>2</sub> module and SpO<sub>2</sub> module are configured, select the [Values] button to access the screen as shown below.

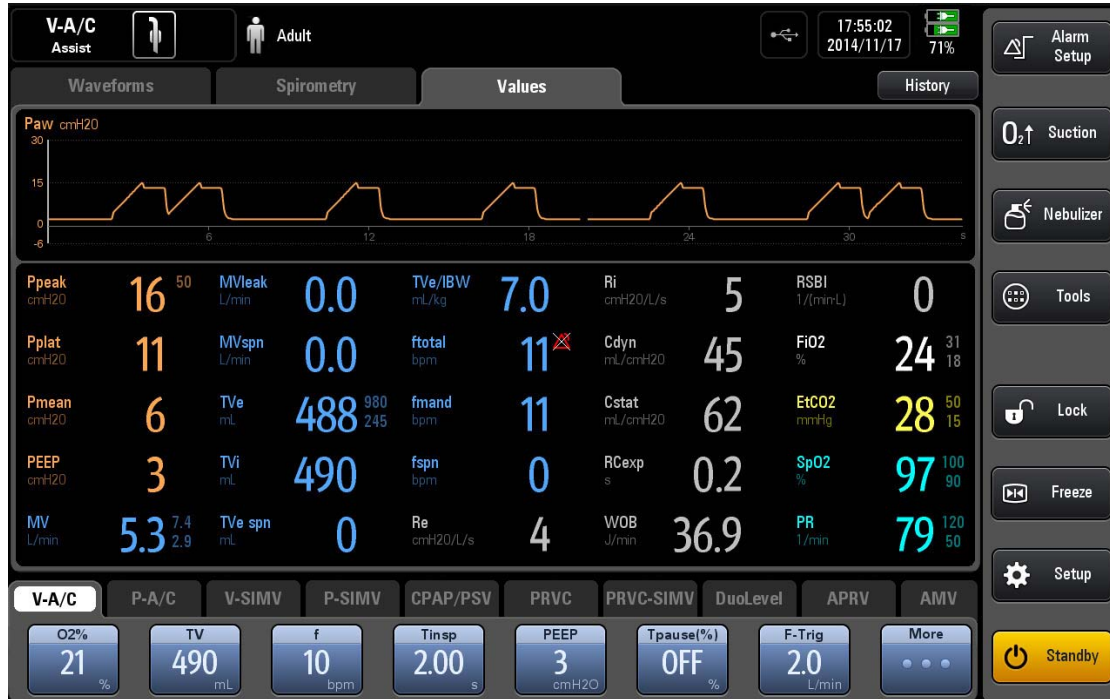

When the mainstream CO<sub>2</sub> module and SpO<sub>2</sub> module are configured, select the [Values] button to access the screen as shown below.

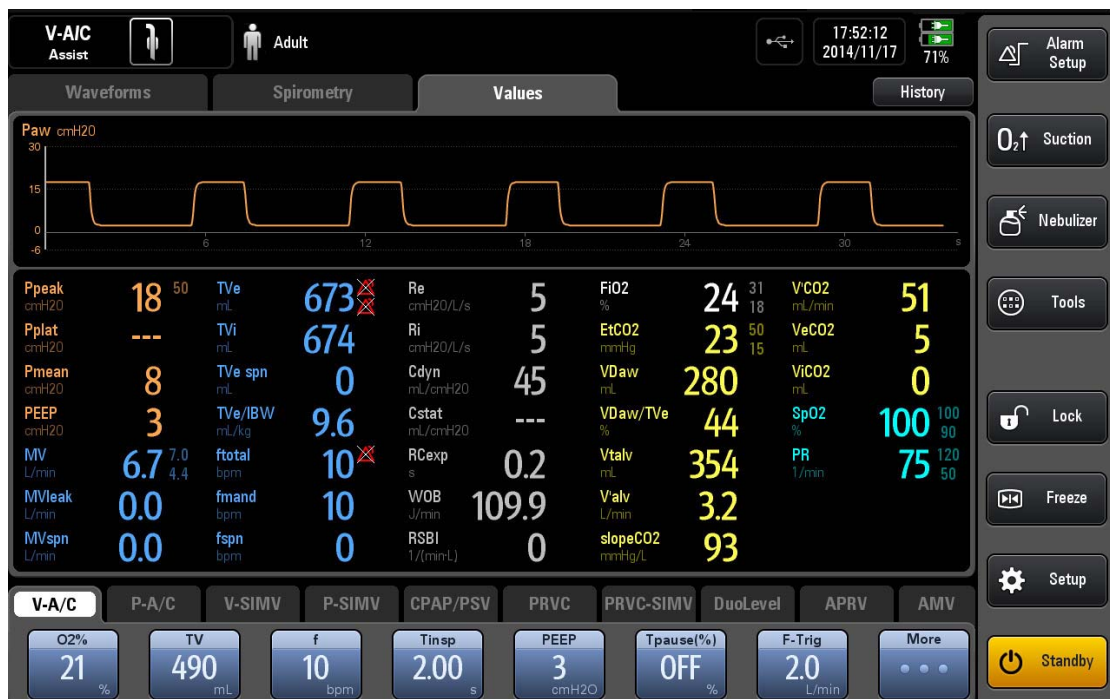

## 4.5 History Data

Select the **[History]** button to access the window as shown below. You can view tabular trend, graphic trend, setting trends, and event logbook in the History window.

### 4.5.1 Tabular Trend



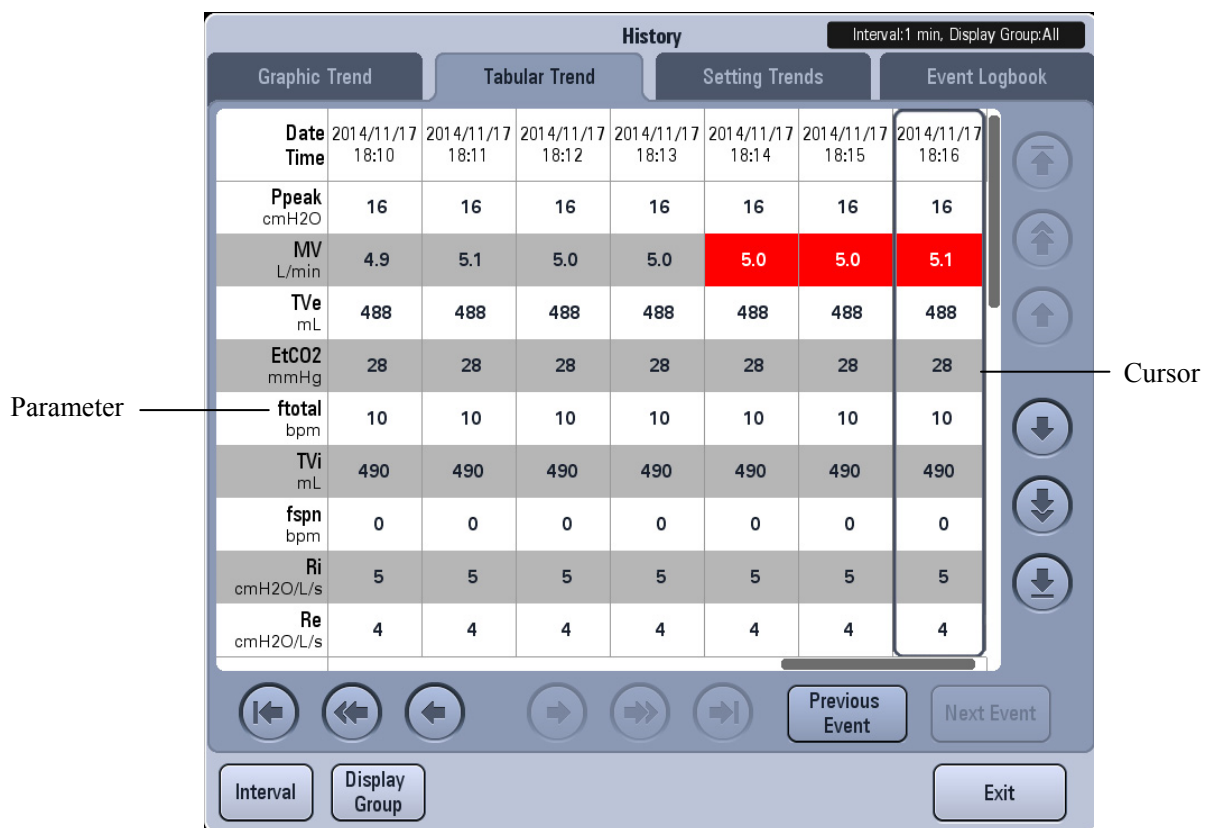









You can view the patient's monitored parameter data and events under the Tabular Trend tab. Trend data displays at one-minute intervals by default.



#### 4.5.1.1 About Tabular Trend

- Tabular Trend displays the time and date on the horizontal axis.
- Tabular Trend displays the parameter data on the vertical axis.
- Tabular Trend displays the most recent trend data on the rightmost side.
- Tabular Trend is not stored when the machine is in standby status.
- The system can display a rolling 72 hours of continuous trend data.
- Tabular Trend highlights the parameter data in the corresponding alarm color if an alarm condition existed for the parameter at the time of trend record storage.

### 4.5.1.2 Navigating in Tabular Trend

Button	Function
	Moves the cursor one record back/forward from its current position.
	
	Moves the cursor up/down one parameter from its current position.
	
	Moves the cursor one page back/forward from its current position.
	
	Moves the cursor up/down one page from its current position.
	
	Moves the cursor to the oldest/newest record from its current position.
	
	Moves the cursor to the top/bottom parameter from its current position.
	
Previous Event	Moves the cursor to the previous event from its current position.
Next Event	Moves the cursor to the next event from its current position.

### 4.5.1.3 Interval

In the Tabular Trend window, you can set [Interval] to [1min], [5min], [10min], [15min], [30min], [1h], and [2h].

### 4.5.1.4 Display Group

In the Tabular Trend window, you can set [Display Group] to [Pressure], [Volume], [Time], [Gas], [SpO<sub>2</sub>], [Other], and [All].

## 4.5.2 Graphic Trend

Graphic trend records the trend of parameter values. It is reflected through a curve. Every point on the curve corresponds to the value of physiological parameter at a specific time point. Graphic trend also records parameter alarm events. Graphic trend data displays at one-minute intervals by default unless the zoom is selected.

Current cursor. The corresponding time displays above the cursor. If alarms occurred at that time, the corresponding alarm information will also be displayed above the cursor.

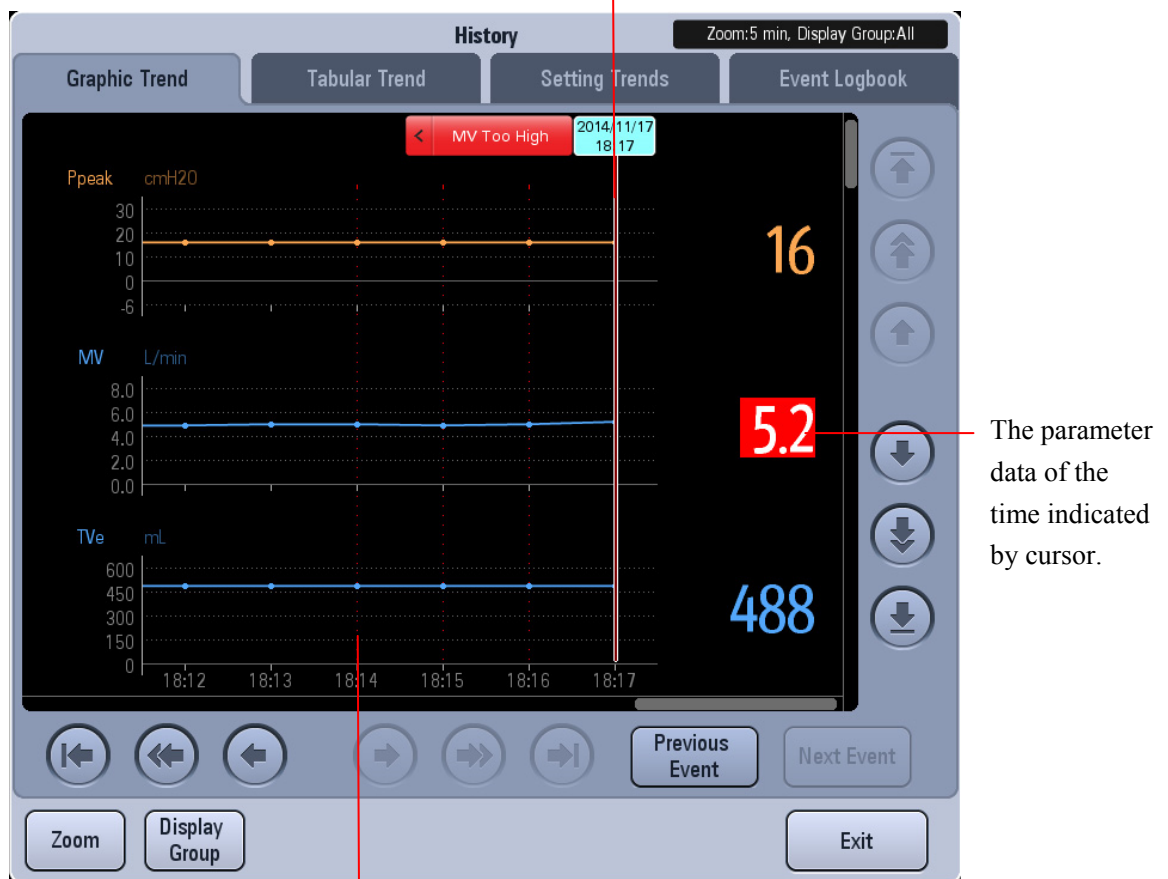









Event marker. The dotted, colored line indicates a parameter alarm event occurred at that time. A parameter alarm event is indicated by a dotted line in the same color with alarm. If multiple events occurred, the dotted line is in the same color of the highest level alarm.



---

### 4.5.2.1 About Graphic Trend

- Graphic Trend displays the time and date on the horizontal axis.
- Graphic Trend displays the parameter data on the vertical axis.
- Graphic Trend displays the most recent trend data on the rightmost side.
- Graphic Trend is not stored when the machine is in standby status.
- The system can display a rolling 72 hours of continuous trend data.
- Graphic Trend highlights the parameter data in the corresponding alarm color if an alarm condition existed for the parameter at the time of trend record storage.

### 4.5.2.2 Navigating in Graphic Trend

Button	Function
	Moves the cursor one record back/forward from its current position.
	
	Moves the cursor up/down one parameter from its current position.
	
	Moves the cursor one page back/forward from its current position.
	
	Moves the cursor up/down one page from its current position.
	
	Moves the cursor to the oldest/newest record from its current position.

	
	Moves the cursor to the top/bottom parameter from its current position.
	
Previous Event	Moves the cursor to the previous event from its current position.
Next Event	Moves the cursor to the next event from its current position.

### 4.5.2.3 Zoom

In the Graphic Trend window, you can set [Zoom] to [5min], [10min], [15min], [30min], [1h], and [2h].

### 4.5.2.4 Display Group

In the Graphic Trend window, you can set [Display Group] to [Pressure], [Volume], [Time], [Gas], [SpO<sub>2</sub>], [Other], and [All].

## 4.5.3 Setting Trends

Setting Trends is used to record ventilation mode settings and parameter settings.



Ventilation mode and setting parameter











Cursor



History							
Graphic Trend		Tabular Trend		Setting Trends		Event Logbook	
Date	Time	---	---	2014/11/17	2014/11/17	2014/11/17	2014/11/17
Time	---	---	---	17:53:54	17:53:54	17:54:12	18:07:26
Vent Mode				V-A/C	Start Ventilation	V-A/C	V-A/C
O2%				21	---	24	24
TV				490	---	490	490
ΔPinsp				---	---	---	---
PEEP				3	---	3	3
Phigh				---	---	---	---
Plow				---	---	---	---
f				10	---	10	10
fsimv				---	---	---	---

### 4.5.3.1 About Setting Trends

- Settings Trends displays the time and date on the horizontal axis.
- Settings Trends displays the ventilation mode and setting parameter on the vertical axis.
- Settings Trends displays the most recent trend data on the rightmost side.
- The system can store up to 5000 records of Setting Trends.

### 4.5.3.2 Navigating in Setting Trends

Button	Function
	Moves the cursor one record back/forward from its current position.
	
	Moves the cursor up/down one parameter from its current position.
	
	Moves the cursor one page back/forward from its current position.
	
	Moves the cursor up/down one page from its current position.
	
	Moves the cursor to the oldest/newest record from its current position.
	

	Moves the cursor to the top/bottom parameter from its current position.
	

## 4.5.4 Event Logbook

Event Logbook records such events as power-on/off, ventilation mode setup, ventilation parameter setup, technical alarm, physiological alarm, standby status, starting ventilation, new patient, special function, default settings management, calibration, System Check, and alarm AUDIO PAUSED.



The screenshot shows the 'History' screen with the 'Event Logbook' tab selected. A list of events is displayed, with the top event '18:13:01 2014/11/17 !!! MV Too High' highlighted. A cursor points to this event. To the right, a detailed view of this event is shown, listing parameters such as Vent Mode (V-A/C), Ventilation Type (Invasive), Patient Type (Adult), Working Mode (Non-Standby), FiO2 (24%), TVe (466 mL), TVi (490 mL), MV (5.4 L/min), ftotal (11 bpm), fspn (0 bpm), Pplat (11 cmH2O), Ppeak (16 cmH2O), PEEP (3 cmH2O), and EtCO2 (28 mmHg). Navigation arrows are visible on the right side of the interface.

### 4.5.4.1 About Event Logbook

- Event Logbook displays the most recent record at the top.
- The system can store up to 5000 records of Event Logbook.







#### NOTE

- The system can store up to 5000 records of Event Logbook. When a new event occurs after 5000 events are already stored, the new event overwrites the earliest one.



---

#### 4.5.4.2 Navigating in Event Logbook

Button	Function
	Moves the scroll up/down one record.
	
	Moves the scroll up/down one page.
	
	Moves the scroll to the top/bottom most parameter.
	

#### 4.5.4.3 Filter

In the Event Logbook window, you can set [Filter] to [High Alarms], [Med Alarms], [Low Alarms], [All Alarms], [Operation Information], and [All Events].

### 4.6 Freeze

The freeze function's feature is that it can pause the real-time refreshing of waveforms and spirometry loops on the screen, so that you can have a close examination of the patient's status within this time period. The reviewed data are waveforms and spirometry loops in the 30 seconds before entering freeze state.

#### 4.6.1 Enter freeze status

During ventilation, press the [Freeze] key and the [Freeze Active. Press the Freeze key to Unfreeze] prompt message is displayed on the screen. The system enters freeze status. Freeze cursors appear on the waveforms and loops. All displayed waves and loops are frozen, namely, they are not refreshed. The data in the parameter area are refreshed normally. In freeze status, the [Save Ref.] button is disabled, and you cannot save a loop as reference loop but can view already saved reference loops.

## 4.6.2 View frozen waveforms

In freeze status, cursors appear on the waveforms. You can rotate the control knob clockwise or counter-clockwise to move the cursor to view the waveforms.

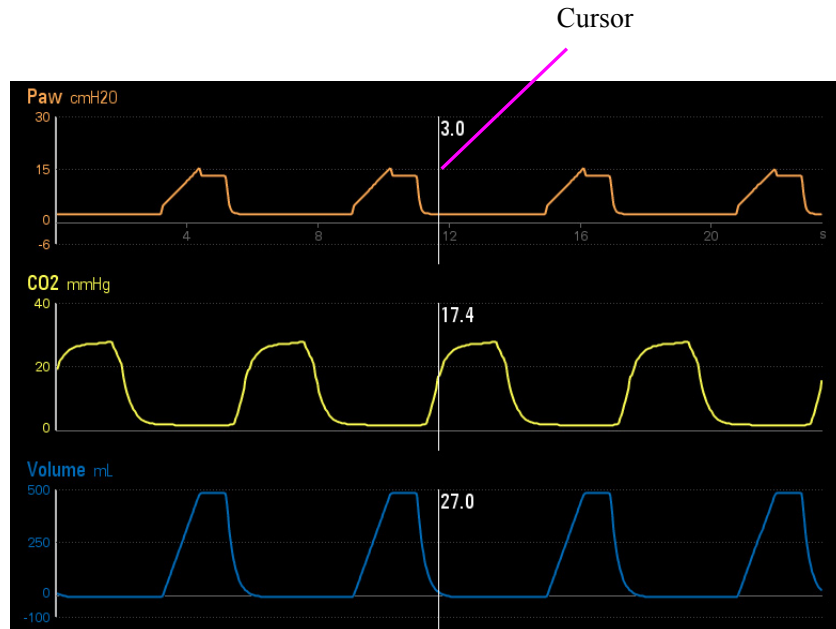

## 4.6.3 View frozen loop

In freeze status, cursors appear on the loops. You can rotate the control knob clockwise or counter-clockwise to move the cursor to view the loops.

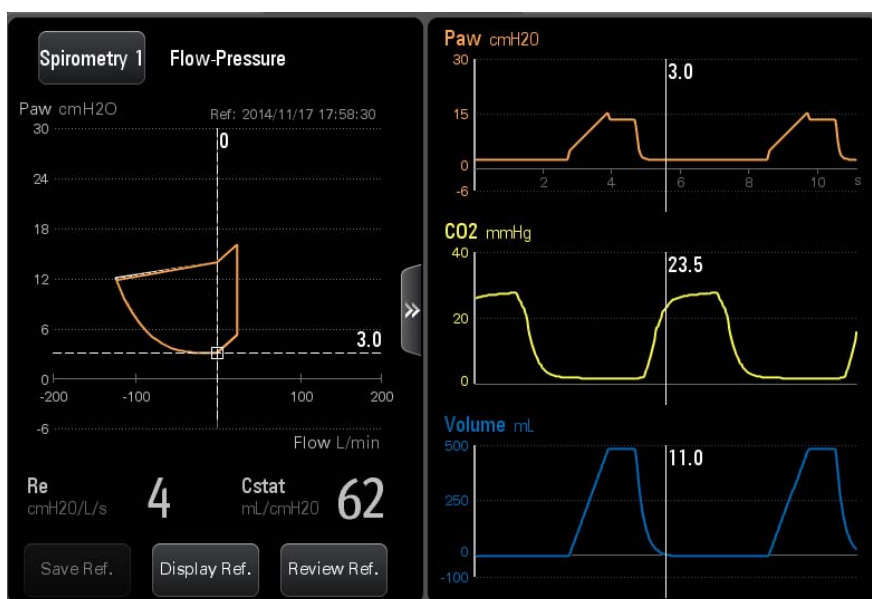



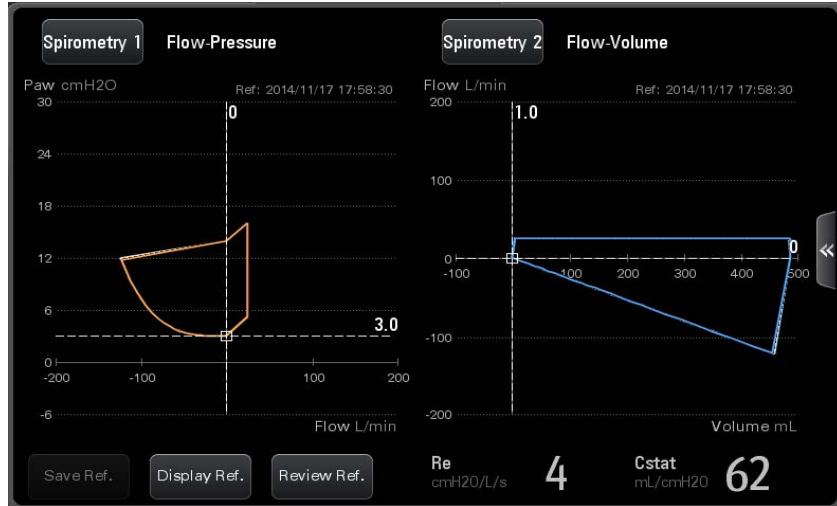

The screen as shown below is displayed by pressing the  button.



#### 4.6.4 Exit freeze status

In freeze status, press the [**Freeze**] key to exit freeze status. In freeze status, if no operation is performed on the ventilator for more than three (3) minutes, the system exits freeze status automatically.

#### 4.7 Lock Screen

Press the  soft key on the main screen to enter locked status, and the [**Screen locked. Press the Lock key to unlock screen.**] prompt message is displayed. During the period of screen locked, only , O<sub>2</sub>↑ Suction, and  key are enabled. Touch screen, control knob, and other keys are disabled. Press this key a second time to unlock the screen.

---

**FOR YOUR NOTES**

# 5 System Settings

---

## 5.1 Display Settings

### 5.1.1 Waveforms

1. Select [Setup]→[Setting]→[Screen Setup].
2. Set [Waveform Count] and select the number of waveforms to be displayed.
3. Select [Draw Wave] and toggle between [Curve] and [Fill].
  - ◆ [Curve]: the waveform is displayed as a curved line.
  - ◆ [Fill]: the waveform is displayed as a filled area.
4. Select waveform area. Set the waveform and waveform color to be displayed in the pop-up dialog box.

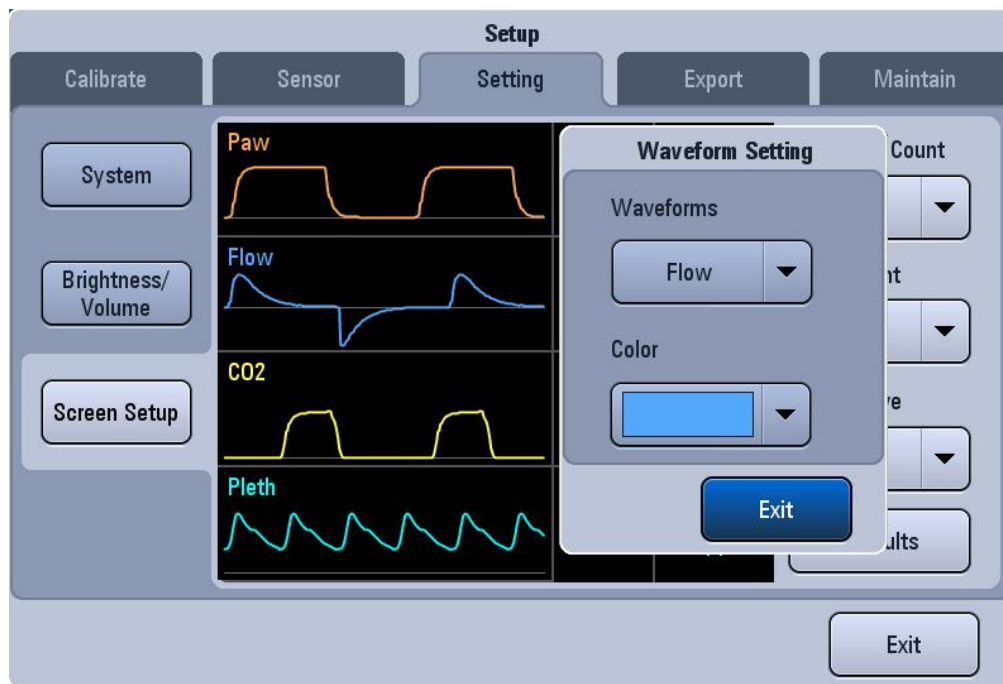

---

## 5.1.2 Measured Values

On the Waveforms or Spirometry screen, the right side of the screen is used to display parameters. To change the display in the parameter area:

1. Select [Setup]→[Setting]→[Screen Setup].
2. Set [Value Count] and select the number of measured values to be displayed.
3. Select parameter area. Set the parameter and parameter color to be displayed in the pop-up dialog box.



### 5.1.3 Colors

The colors of waveform, parameter, spirometry loop, and parameter alarm limit are linked. If you set the color of waveform or parameter, the color of the relevant parameter, waveform, or spirometry loop also changes. The color of related parameter alarm limit will be the dark color of the set color.

The following table lists the waveforms, related parameters, spirometry loops and alarm limits.

Waveform	Waveform related parameters	Waveform related spirometry loop	Waveform related alarm limits
Paw	Ppeak, Pmean, Pplat, PEEP	P-V loop, F-P loop	Ppeak
Flow	MV, MVleak, MVspn, TVe, TVi, TVspn, ftotal, fmand, fspn, TVe/IBW	F-V loop	MV, TVe, ftotal
Volume	/	/	/
/	FiO <sub>2</sub>	/	FiO <sub>2</sub>
CO <sub>2</sub>	EtCO <sub>2</sub> , Vdaw, Vdaw/TVe, Vtalv, V'alv, slopeCO <sub>2</sub> , V'CO <sub>2</sub> , VeCO <sub>2</sub> , ViCO <sub>2</sub> ,	V-CO <sub>2</sub> loop	EtCO <sub>2</sub>
Pleth	SpO <sub>2</sub> , PR, PI	/	SpO <sub>2</sub> , PR, SpO <sub>2</sub> Desat

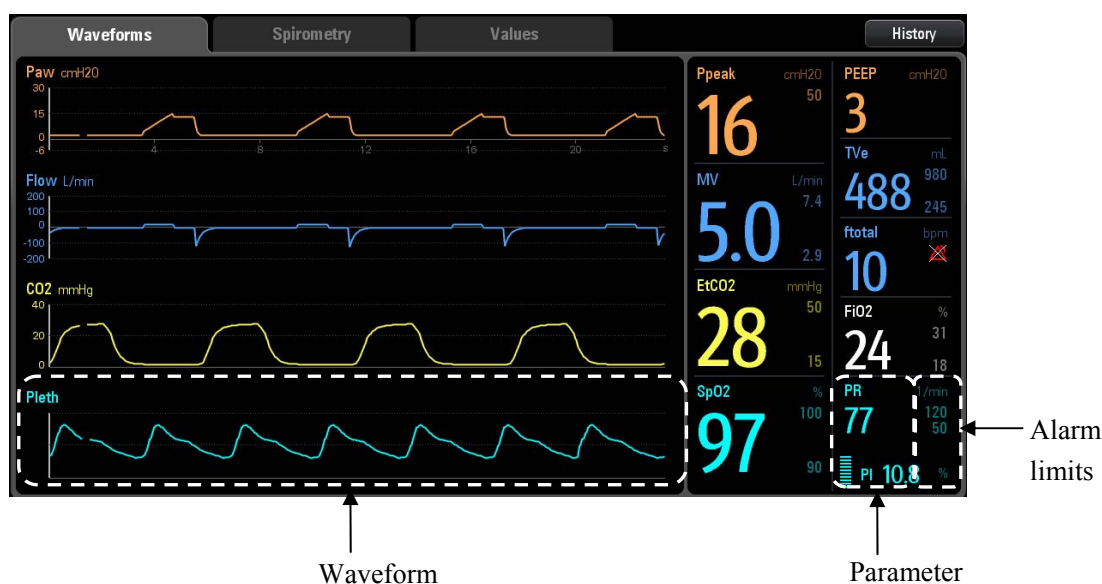

### 5.1.4 Defaults

1. Select [Setup] → [Setting] → [Screen Setup].
2. Set [Defaults] as required to restore the setting values in the screen setup menu to the default values.

---

## 5.2 Set Date and Time

1. Select the system time field on the main screen to pop up time setup menu.
2. Set **[Date]** and **[Time]**.
3. Set **[Date Format]** to **[YYYY-MM-DD]**, **[MM-DD-YYYY]** or **[DD-MM-YYYY]**.
4. Select **[Time Format]** and toggle between **[24 h]** and **[12 h]**.

## 5.3 Adjust Screen Brightness

1. Select **[Setup]**→**[Setting]**→**[Brightness/Volume]**.
2. Select **[Day]** or **[Night]** to choose the corresponding default screen brightness.
3. If the above screen brightness is not satisfactory, adjust the screen brightness by selecting the + (increase) or - (decrease) button. The LCD brightness has 10 levels of adjustment. If the ventilator is battery powered, you can select a less bright screen to save battery capacity.

## 5.4 Adjust Key Volume

1. Select **[Setup]**→**[Setting]**→**[Brightness/Volume]**.
2. Adjust the key volume by selecting the + (increase) or - (decrease) button. The key volume has 10 levels of adjustment.

## 5.5 Set Tinsp/I:E

1. Select **[Setup]**→**[Setting]**→**[System]**.
2. Select **[Tinsp/I:E]** and toggle between **[Tinsp]** and **[I:E]**. Based on your Tinsp/I:E selection, corresponding Tinsp or I/E ventilation setting parameters are adopted for V-A/C, P-A/C and PRVC modes.

## 5.6 Set IBW/Height

1. Select **[Setup]**→**[Setting]**→**[System]**.
2. Select **[IBW/Height]** and toggle between **[IBW]** and **[Height]**. When the ventilator is used on a new patient, the system calculates default values of TV, f, and fapnea in the ventilation mode automatically based on the set IBW or height and gender.



---

## 5.7 Set TV/IBW

1. Select [Setup]→[Setting]→[System].
2. Select [TV/IBW] and set it to appropriate ratio. The system sets TV default value in the ventilation mode based on [TV/IBW].

## 5.8 Set DuoLevel Timing

1. Select [Setup]→[Setting]→[System].
2. Select [DuoLevel Timing] and toggle between [Thigh] and [f]. In case of DuoLevel ventilation mode, the settable time control parameters are [Thigh] and [Tlow] if [DuoLevel Timing] is set to [Thigh]. In case of DuoLevel ventilation mode, the settable time control parameters are [f] and [Tinsp] if [DuoLevel Timing] is set to [f] and [Tinsp/I:E] is set to [Tinsp]. In case of DuoLevel ventilation mode, the settable time control parameters are [f] and [I:E] if [DuoLevel Timing] is set to [f] and [Tinsp/I:E] is set to [I:E].

## 5.9 Set IV Apnea Mode

1. Select [Setup]→[Setting]→[System].
2. Select [IV Apnea Mode] and toggle between [Volume Control] and [Pressure Control]. In case of invasive ventilation, the settable apnea ventilation control parameter is [TVapnea] if [IV Apnea Mode] is set to [Volume Control], and is [Δ Papnea] if [IV Apnea Mode] is set to [Pressure Control].

## 5.10 Set O<sub>2</sub> Sensor Monitoring

1. Select [Setup]→[Sensor]→[O<sub>2</sub>].
2. Select [Monitoring] and toggle between [ON] and [OFF]. When [ON] is selected, oxygen concentration of patient's inhaled gas can be monitored. You can set [Monitoring] to [OFF] if oxygen concentration monitoring function accompanying the ventilator is not needed. In this case, the [O<sub>2</sub> Monitoring Off] prompt message is displayed on the screen.

---

### CAUTION

---

- Switching off oxygen concentration monitoring is allowable. To prevent potential patient injury, it is suggested not to switch off oxygen concentration monitoring continuously.
-

---

## NOTE

---

- The system total response time for oxygen concentration monitoring is 23s.
  - It takes approximately 3 minutes from powering on the ventilator to reaching the oxygen concentration monitoring performance specified in section B.7 of this manual.
- 

## 5.11 Set Language

1. Select [Setup]→[Maintain]→[User]→enter the required password→[Setting].
2. Select [Language] and select the desired language.
3. Restart the ventilator to activate the selected language.

## 5.12 Set Unit

### 5.12.1 Set Weight Unit

1. Select [Setup]→[Maintain]→[User]→enter the required password→[Setting]→[Unit].
2. Set [Weight Unit] and toggle between [kg] and [lb].

### 5.12.2 Set Paw Unit

1. Select [Setup]→[Maintain]→[User]→enter the required password→[Setting]→[Unit].
2. Select [Paw Unit] among [cmH<sub>2</sub>O], [hPa], and [mbar].

### 5.12.3 Set CO<sub>2</sub> Unit

1. Select [Setup]→[Maintain]→[User]→enter the required password→[Setting]→[Unit].
2. Select [CO<sub>2</sub> Unit] among [mmHg], [kPa], and [%].

## 5.13 Set O<sub>2</sub> Supply Type

1. Select [Setup]→[Maintain]→[User]→enter the required password→[Setting]→[Gas Supply].
2. Select [O<sub>2</sub> Supply Type] and toggle between [HPO] and [LPO].

---

## 5.14 Manage Default Settings

The ventilator provides the following types of settings:

- Factory default settings, namely, values of factory preset setting items. There are two groups of default settings, adult and pediatric, based on patient type.
- Current settings. You can change the ventilator's default settings based on the current settings during ventilation and save the changed settings as default settings. There are two groups of default settings, adult and pediatric.
- Recent settings. In actual applications, you may change some settings, which, however, may not be saved as current settings. The ventilator stores these settings in real time. The stored settings are recent settings.

### NOTE

- 
- **Patient type, gender, height, IBW, ventilation mode, ventilation parameters, and alarm limit settings can be saved as current settings.**
- 

### 5.14.1 Save and Load Current Settings

You can change the ventilator's settings based on the actual requirement and save the changed settings as current settings.

1. Select **[Setup]→[Maintain]→[User]**→enter the required password→**[Default Settings]**.
2. Select **[Use Current Settings]** to save as current settings.

When the ventilator is used on a new patient after powered on, the system loads the saved current settings automatically.

### 5.14.2 Restore Factory Default Settings

You can restore factory default settings manually as required, while unit is in standby status.

1. Select **[Setup]→[Maintain]→[User]**→enter the required password→**[Default Settings]**.
2. Select **[Restore Factory Defaults]** to restore the defaults to factory defaults.

When the ventilator is used on a new patient after powered on, the system loads the factory default settings automatically.

---

### 5.14.3 Restore Recent Settings Automatically

When the ventilator is used on the same patient after powered on, the system adopts recent settings automatically.

#### NOTE

---

- **Records the system saves automatically include reference loop, monitored trend, event log (including alarm log), setup trend, special function measured values (including PEEPi, NIF, P0.1, and P-V Tool measured values), patient setup and equipment setup (including alarm setup). When there are changes in these data, the system stores the changed data in the flash memory chips of the main board automatically. When the ventilator restarts, the data are restored automatically.**
- 

## 5.15 Transfer Settings

You can export or import settings, while unit is in standby.

To export settings,

1. Insert the USB memory into the USB connector of the ventilator.
2. Select [Setup]→[Maintain]→[User]→enter the required password→[Data Transfer].
3. Select [Export Settings] to save the ventilator's current settings and default settings to the USB memory.

To import settings,

1. Insert the USB memory into the USB connector of the ventilator.
2. Select [Setup]→[Maintain]→[User]→enter the required password→[Data Transfer].
3. Select [Import Settings] to load the settings in the USB memory to the ventilator.

---

## 5.16 View System Information

### 5.16.1 Version Information

Select **[Setup]**→**[Maintain]**→**[User]**→enter the required password→**[Syst. Info]**→**[Versions]** to view the version information of system software.

### 5.16.2 Configuration Information

Select **[Setup]**→**[Maintain]**→**[User]**→enter the required password→**[Syst. Info]**→**[Config Info]** to view the configuration information of the ventilator such as ventilation mode.

### 5.16.3 Maintenance Information

Select **[Setup]**→**[Maintain]**→**[User]**→enter the required password→**[Syst. Info]**→**[Maintain]** to view the system total running time, system startup time, CO<sub>2</sub> last calibration time, O<sub>2</sub> sensor last calibration time, flow sensor last calibration time, time left for the next turbine blower maintenance, and time of last maintenance.

## 5.17 Export

The ventilator's export function means to export some data to USB memory.

### 5.17.1 Export Screen

Exporting screen means to export the last saved screen capture of the ventilator in the format of "bmp".

To export screen capture,

1. Insert the USB memory into the USB connector of the ventilator.
2. Select the desired screen to be exported and then press the **[Freeze]** key to capture the screen.
3. Select **[Setup]**→**[Export]**→**[Export Screen]**. The system checks the availability of USB memory. If the USB memory is available and has sufficient space, the system exports the last captured screen.
4. After exporting is completed, select **[Remove USB Memory]** to remove the USB memory.

---

## 5.17.2 Export Data

Exporting data means to export patient demographics, current setting parameters, current alarm limits, and trend data of the ventilator.

To export data,

1. Insert the USB memory into the USB connector of the ventilator.
2. Select **[Setup]**→**[Export]**→**[Export Data]**. The system checks the availability of USB memory. If the USB memory is available and has sufficient space, the system exports patient demographics, current setting parameters, current alarm limits, tabular trend, graphic trend, PEEP<sub>i</sub> measured value, P0.1 measured value, Vtrap measured value, and NIF measured value. The format of the exported data is “html”.
3. If it is necessary to export calibration data, event log, and check log besides the above mentioned data, select **[Setup]**→**[Maintain]**→**[User]**→enter the required password→**[Data Transfer]**→**[Export Data]**. The system checks the availability of USB memory. If the USB memory is available and has sufficient space, the system exports these data. The exported data is encrypted in the format of “blg”.
4. After exporting is completed, select **[Remove USB Memory]** to remove the USB memory.

### NOTE

- 
- **If you need to check the exported data in format of “blg”, please contact the Customer Service Department .**
-

# 6 Ventilation

---

---

## 6.1 Turn on the System

1. Insert the power cord into the power receptacle. Ensure the external power indicator light is lit.
2. Press the  key.
3. The alarm indicator light flashes yellow and red once in turn, and then the speaker and the buzzer give a check sound respectively.
4. A start-up screen and start-up check progress bar appear. Then the System Check screen is displayed.

### NOTE

---

- **When the ventilator is started, the system detects whether audible alarm tones and alarm lamp function normally. If yes, the alarm lamp flashes red and yellow successively, and the speaker and the buzzer give check tones. If not, do not use the equipment and contact us immediately.**
- 

## 6.2 System Check

---

---

### WARNING

---

- **To ensure optimum performance of the ventilator, re-do System Check each time after changing the patient type, replacing the accessories or components like patient tubing, humidifier, and filter.**
- 
- 

### CAUTION

---

- **Always run System Check before using the ventilator on a patient. If the ventilator fails any tests, remove it from clinical use. Do not use the ventilator until necessary repairs are completed and all tests have passed.**
  - **Before running System Check, disconnect the patient from the equipment and ensure that a backup ventilation mode is available for patient ventilation.**
- 
-

---

To enter the System Check screen,

- The System Check screen is accessed automatically after powering on the system.
- On the non-standby screen, select the [**Standby**] button and enter the Standby status after your confirmation. Select the [**System Check**] button in the Standby status to enter the System Check screen.

The system check screen displays the last system check time. Select the [**Details**] button to query the system check information of the ventilator system, including system check items, System Check results, and System Check time.

Connect the gas supply and block the Y piece as illustrated. Then select [**Continue**] to start System Check item by item.

System Check items include:

- Blower test: test the speed of the turbine blower.
- O<sub>2</sub> flow sensor test: test the flow sensor in O<sub>2</sub> limb.
- Inspiratory flow sensor test: test the inspiration valve and flow sensor.
- Expiratory flow sensor test: test the expiratory flow sensor.
- Pressure sensor test: test the pressure sensors at the inspiratory and expiratory ports.
- Expiration valve test
- Safety valve test
- Leakage (mL/min)
- Compliance (mL/cmH<sub>2</sub>O)
- Tube resistance (cmH<sub>2</sub>O/L/s)
- O<sub>2</sub> sensor test

System Check result can be:

- Pass: indicates that check of this item is completed and is passed;
- Fail: indicates that check of this item is completed but is failed;
- Cancel: indicates that check of this item is cancelled;
- O<sub>2</sub> Supply Failure: indicates that O<sub>2</sub> supply is insufficient when O<sub>2</sub> sensor test or O<sub>2</sub> flow sensor test is being carried out;
- Monitoring Off: indicates that sensor monitoring function may not be switched on when O<sub>2</sub> sensor test is being carried out.



---

Total selftest results are listed as follows after all selftest items have been completed:

- Pass: all selftest items successfully pass the selftest.
- Partially Pass: some selftest items fail, but the mechanical ventilation is allowed.
- Fail. Ventilation Disabled: some important selftest items fail, but the mechanical ventilation is not allowed.
- High Leakage, Ventilation Disabled: Expiratory flow sensor test, Pressure sensor test, Expiration valve test, or Safety valve test fails, the mechanical ventilation is not allowed.
- Cancel: some selftest items cancelled and other selftest items have been successfully passed.

During System Check, the system prompts [**Running**] on the right side of the current check item. In this case, if you select [**Skip**], the system stops the check of this item immediately and displays [**Cancel**] as the check result. The check of the next item begins at the same time. If you select [**Stop**], the system stops the check of the current item and also the check of the remaining items immediately, and displays [**Cancel**] as the check result.

When O<sub>2</sub> sensor test fails, the [**O<sub>2</sub> Calibration**] button is displayed. Press this button to open the O<sub>2</sub> calibration menu, and then to calibrate oxygen concentration.

When checks of all items are completed, if you select [**Retry**], the system starts a new round of checking. If you select [**Exit**], the system exits the check and enters Standby status.

## 6.3 Select Patient

### 6.3.1 Set Patient Information on the Ventilator

After System Check is completed, select [**Continue**] to enter Standby status. Then select patient. If you select [**Last Patient**], set ventilation type in the accessed screen, and then select [**Start Ventilation**]. If you select [**New Adult**] or [**New Pediatric**], set gender, [**Height**]/[**IBW**], ventilation type in the accessed screen, and then select [**Start Ventilation**].

---

## 6.3.2 Getting Patient Information from the ADT Server

The ventilator can connect with the Admit-Discharge-Transfer (ADT) server through the eGateway, and the ventilator can load the patient information from ADT server.

To load patient information from the ADT server, perform the following procedure:

1. Connect the network cables.
2. Select [Setup]→[Maintain]→ [User] →Enter user password→[Interface Setting].
3. Select [LAN Setup] tab, set [IP Config. Method], [IP Address], [Subnet Mask] and [Gateway] in the opened interface.
4. Select [eGateway] tab and set the [eGateway] to [ON] in the opened interface. Then set the [IP] of eGateway and ADT. Normally, there is no need to set the [Port], but you can change it as required.
5. Ensure the network status is [Connected] in the [eGateway] tab.
6. Enter Standby status.
7. Select , input [Patient ID] and [Visit Number] in the opened interface.
8. Select [Query]. Then list pops up, including all the patients that meet the query criteria.
9. Select a patient from the patient list, and then select [Import]. The imported data includes patient ID, visit number, first name, last name, bed number, Room number, department, and facility.

### NOTE

- 
- The IP address of the ventilator, eGateway and ADT must be on the same subnet.
  - When the [eGateway] is set to [ON], the ventilator can send the patient information, ventilation mode, ventilation type, monitored parameters, controlled parameters, waveforms and alarm limits data to the eGateway.
- 

## 6.4 Ventilation Type

The ventilator provides two ventilation types: invasive and non-invasive.

---

### WARNING



---

- Check the alarm limit settings after switching over from NIV to Invasive.
-

---

## 6.4.1 Invasive Ventilation

Invasive ventilation means to ventilate the patient through manual airway (ET tube or Trach tube). In invasive ventilation, all ventilation modes for adult and pediatric patients are enabled.

Select the icon  for invasive ventilation or select . Select [ATRC] in the accessed page and then make the relevant settings. For details, refer to **9.11 Automatic Tube Resistance Compensation (ATRC)**.

---

### WARNING

- **Incorrect tube type, ID or compensate setting can endanger the patient. Make sure to set them properly.**

---

### CAUTION

- **Do not attempt to use NIV on intubated patients.**

---

## 6.4.2 Non-invasive Ventilation (NIV)

NIV means to ventilate the patient by using a nasal mask or facial mask instead of ET tube or Trach tube. In NIV, the enabled ventilation modes include: P-A/C, P-SIMV, CPAP/PSV, DuoLevel and APRV in adult and pediatric patient ranges. The disabled ventilation modes in NIV appear grey.

---

### CAUTION

- **Do not use NIV on patients with no or irregular spontaneous breaths. NIV is intended to provide supplemental ventilatory support to patients with regular spontaneous breaths.**
- **Do not attempt to use NIV on intubated patients.**

---

## 6.4.3 Set Ventilation Type

To set ventilation type,

1. If the ventilator is in non-standby mode, press the [Standby] key and enter Standby status after confirmation.
2. Select [Last Patient], [New Adult] or [New Pediatric] in the Standby status.
3. Set ventilation type to [Non-Invasive] or [Invasive] on the accessed screen.

---

## 6.5 Ventilation Mode

### NOTE

- At the inspiratory phase, the ventilator will not automatically generate negative pressure. However, it may cause negative pressure because patients inhale air.
- The user can set high pressure alarm limit. If the pressure reaches the high pressure alarm limit in the inspiratory phase, the “Paw Too High” high-level alarm is triggered. The ventilator opens the expiration valve and switches to expiratory phase until the airway pressure reaches the preset PEEP value. If the airway pressure exceeds high pressure alarm limit+5 cmH<sub>2</sub>O (adjustable pressure limit) , the ventilator opens the safety valve to release pressure, so that the airway pressure falls to less than 3 cmH<sub>2</sub>O for continuous 0.5 s. Make sure to set high pressure alarm limit properly to ensure patient safety.
- The P-A/C and P-SIMV are the recommended ventilation modes for use with a closed-suction catheter during the suction. And the settings are decided by the operator according to the patient situation.
- In the inspiratory phase, waveforms turning red indicates that the patient has spontaneous inspiration or the pressure support ventilation is triggered in V-SIMV, P-SIMV, PRVC-SIMV, CPAP/PSV, DuoLevel, AMV or APRV mode.

---

### 6.5.1 Ventilation Mode and Parameter Setup



1. Ventilation mode setup field

Displays all the keys for setting up ventilation modes. The ventilator can be configured with the following ventilation modes: V-A/C, P-A/C, V-SIMV, P-SIMV, CPAP/PSV, PRVC, PRVC-SIMV, DuoLevel, APRV, and AMV. Your machine may have different ventilation modes.

2. Parameter setup quick key field

Displays ventilation setting parameters corresponding to the active ventilation mode.

Selecting  displays more ventilation setting parameters. The parameters of sigh function and ATRC function are also set here. Ventilation parameters vary subject to the ventilation mode.

---

To set ventilation mode,

1. In the ventilation mode setup field, select the key for the desired ventilation mode. The accessed window displays the ventilation parameters which can be set in the selected ventilation mode.
2. Select the key for the ventilation parameter to be set.
3. Press the control knob and turn it to set the selected parameter to the appropriate value.
4. Press the control knob to confirm the setting.
5. Set other parameters in the same way.
6. Select [**Ok**] when parameter setup is completed.

To set quick key ventilation parameters,

1. In the parameter setup quick key field, select the ventilation parameter to be set.
2. Press the control knob and turn it to set the selected parameter to the appropriate value.
3. Press the control knob to confirm the setting.
4. Set other parameters in the same way.

---

## 6.5.2 Apnea Ventilation

Apnea ventilation is a backup ventilation mode initiated when the ventilator detects patient apnea in CPAP/PSV, V-SIMV, P-SIMV, PRVC-SIMV, DuoLevel, and APRV modes. Apnea ventilation can exit only under the following circumstances: patient's spontaneous breathing has been detected continuously twice, ventilation mode is switched over, or apnea ventilation is switched off (in SIMV modes).

This ventilator provides two types of apnea ventilation mode: volume-controlled apnea ventilation and pressure-controlled apnea ventilation. Both volume-controlled apnea ventilation and pressure-controlled apnea ventilation are supported in case of invasive ventilation. Only pressure-controlled apnea ventilation is supported in case of non-invasive ventilation.

Volume-controlled apnea ventilation means that tidal volume, breathing frequency, and inspiration time in the apnea ventilation cycle can be set in the mode supporting apnea ventilation. After entering apnea ventilation, the ventilator executes PRVC ventilation with the set tidal volume, breathing frequency, and inspiration time in the apnea ventilation cycle (other parameter's setting values are unchanged).

Pressure-controlled apnea ventilation means that inspiration pressure, breathing frequency, and inspiration time in the apnea ventilation cycle can be set in the mode supporting apnea ventilation. After entering apnea ventilation, the ventilator executes P-A/C ventilation with the set inspiration pressure, breathing frequency, and inspiration time in the apnea ventilation cycle (other parameter's setting values are unchanged).

---

### CAUTION

---

- You are suggested to initiate apnea ventilation in SIMV mode.
-

### 6.5.3 V-A/C

V-A/C is volume-assist/control ventilation mode. In V-A/C mode, a certain tidal volume is delivered to the patient within a certain period of gas delivery time. During the expiratory phase, V-A/C mode supports synchronization trigger. Namely, when the ventilator detects patient inspiratory effort, it delivers next mechanical ventilation in advance.

The following figure shows typical waveforms in V-A/C mode. Pmax stands for high alarm limit of Paw.

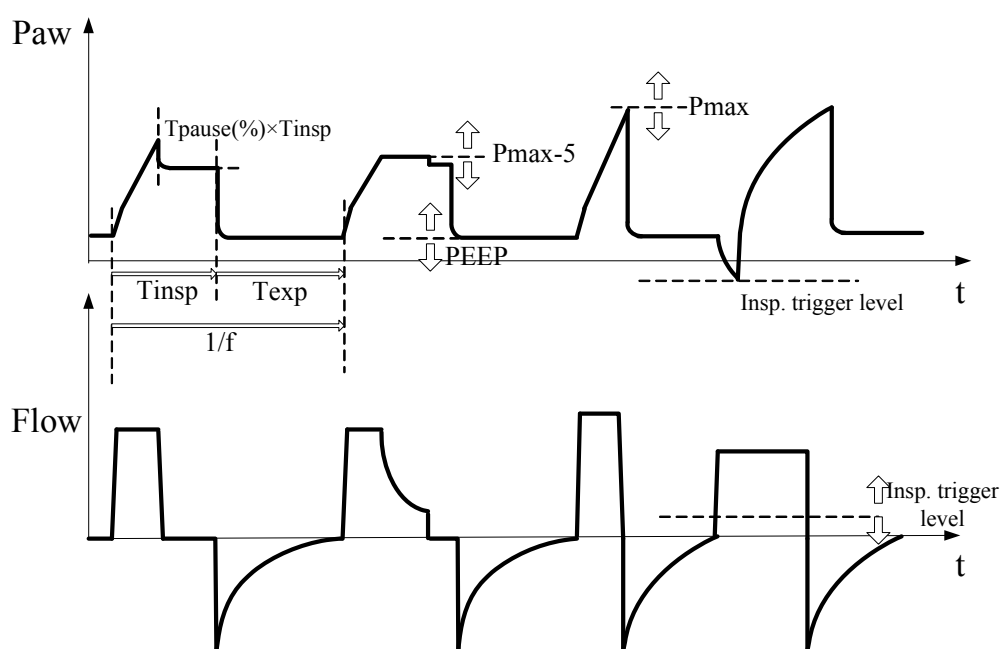

In V-A/C mode, you need to set the following ventilation parameters:

1. **[O<sub>2</sub>%]:** Oxygen concentration
2. **[TV]:** Tidal volume
3. **[T<sub>insp</sub>] or [I:E]:** Inspiration time or ratio of inspiratory time to expiratory time
4. **[f]:** Breathing frequency
5. **[PEEP]:** Positive end-expiratory pressure
6. **[Assist]:** Switching trigger ON/OFF
7. **[F-Trig] or [P-Trig]:** Inspiration trigger level
8. **[T<sub>pause</sub>(%)]:** Percent of inspiratory pause time

---

In V-A/C mode, you can set the following sigh function parameters as required:

1. [**Sigh**]: Switch for turning on sigh function
2. [**Interval**]: Time interval between two sighs
3. [**Cycles Sigh**]: Number of sigh cycles
4. [**Δint.PEEP**]: PEEP added in sigh cycle

In V-A/C mode, you can set the following ATRC function parameters as required in Invasive ventilation (this function is applied to all Invasive modes and the description is not repeated in the other ventilation modes section in this manual.):

1. [**Disable ATRC**]: Switch off ATRC function
2. [**ET Tube**]: Endotracheal tube
3. [**Trach Tube**]: Tracheal tube
4. [**Tube I.D.**]: Diameter of tube
5. [**Compensate**]: Compensate portion
6. [**Expiration**]: Compensate of expiration

#### **6.5.4 P-A/C**

P-A/C is pressure-assist/control ventilation mode. In P-A/C, the patient's airway pressure rises to the preset pressure level within the time of pressure rising, and is held at this level till inspiration time is completed. Then the system switches to expiration. When the airway pressure is held at the preset pressure level, delivered gas flow has decelerating shape, and varies with the resistance and compliance of the patient's lungs. During the inspiratory phase, when the delivered gas volume exceeds the tidal volume high alarm limit, the system switches to expiratory phase immediately. During the expiratory phase, synchronization trigger is supported. Namely, when the ventilator detects patient inspiratory effort, it delivers next mechanical ventilation breath immediately.



The following figure shows typical waveforms in P-A/C mode.

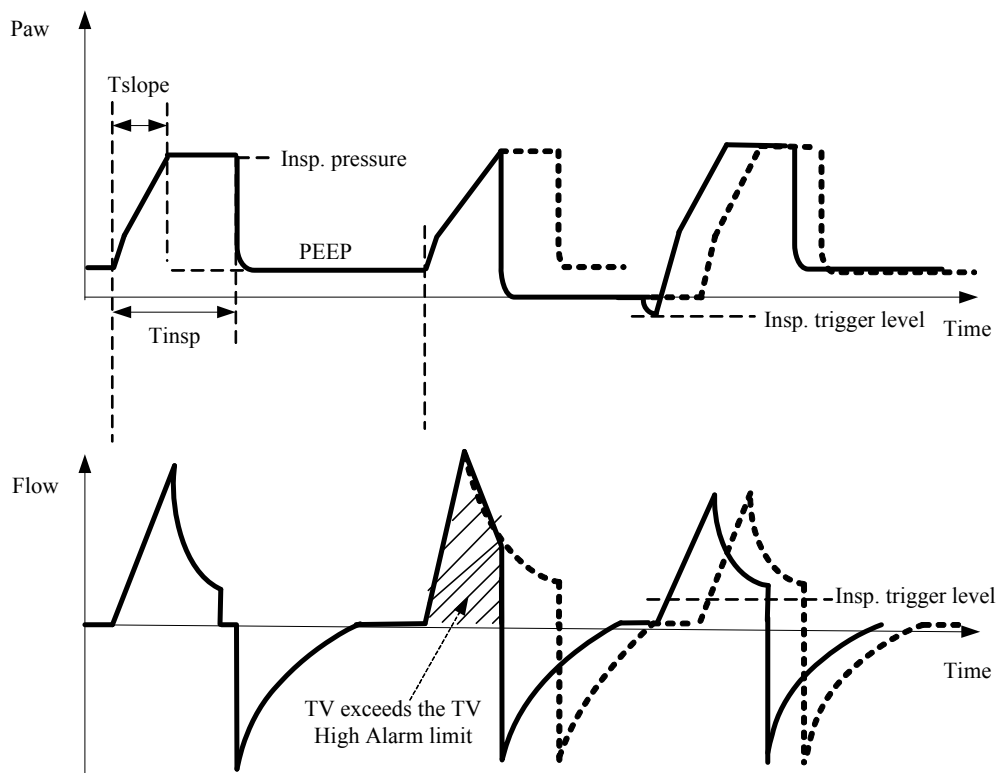

In P-A/C mode, you need to set the following basic ventilation parameters:

1. [O<sub>2</sub>%]: Oxygen concentration
2. [ΔP<sub>insp</sub>]: Inspiration pressure
3. [T<sub>insp</sub>] or [I:E]: Inspiration time or ratio of inspiratory time to expiratory time
4. [f]: Breathing frequency
5. [PEEP]: Positive end-expiratory pressure
6. [Assist]: Switching trigger ON/OFF
7. [F-Trig] or [P-Trig]: Inspiration trigger level
8. [Tslope]: Time of pressure rising

In P-A/C mode, you can set the following sigh function parameters as required:

1. [Sigh]: Switch for turning on sigh function
2. [Interval]: Time interval between two sighs
3. [Cycles Sigh]: Number of sigh cycles
4. [Δint.PEEP]: PEEP added in sigh cycle

---

## 6.5.5 V-SIMV

V-SIMV is volume-synchronized intermittent mandatory ventilation mode. It provides the minimum number of mandatory breaths based on the preset intermittent mandatory ventilation frequency. Mandatory ventilation mode is volume mode (V-A/C mode). If patient triggers within the trigger window, ventilator delivers mandatory volume control breath once. Mandatory volume control breath is also delivered once if it is not triggered at the end of trigger window. Spontaneous breathing or pressure support breathing is supported outside the trigger window.

Trigger window is a period of buffer time for patient's synchronization inspiration. The period is in the later expiration phase of the mechanical ventilation. The trigger window is 5 s long for adult and 1.5 s long for pediatric while simultaneously it cannot exceed the expiratory time.

The following figure shows typical waveforms in V-SIMV+PSV mode.

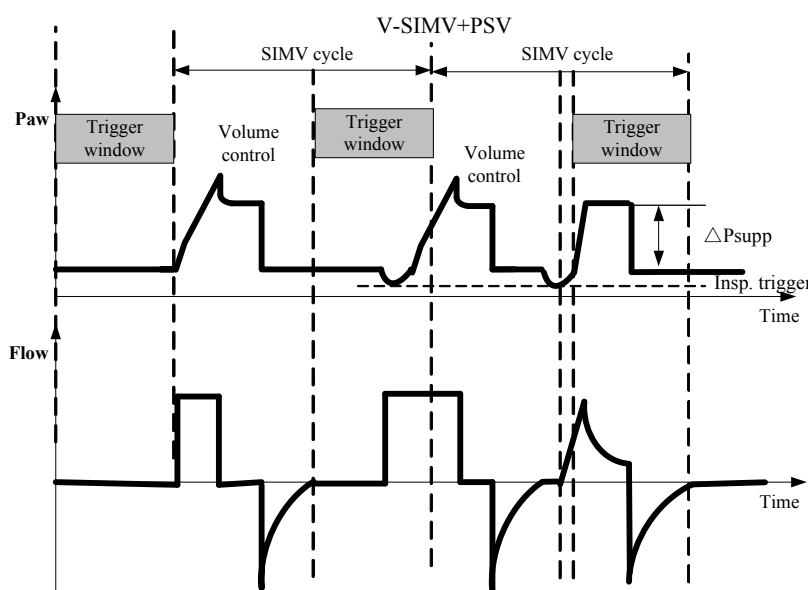

In V-SIMV mode, you need to set the following basic ventilation parameters:

1. **[O<sub>2</sub>%]:** Oxygen concentration
2. **[TV]:** Tidal volume
3. **[T<sub>insp</sub>]:** Inspiration time
4. **[f<sub>simv</sub>]:** Mandatory breathing frequency
5. **[T<sub>pause</sub>(%)]:** Percent of inspiratory pause time
6. **[ $\Delta P_{supp}$ ]:** Pressure support level
7. **[PEEP]:** Positive end-expiratory pressure
8. **[F-Trig] or [P-Trig]:** Inspiration trigger level
9. **[Exp%]:** Expiration trigger level

- 
- |                                      |   |
|--------------------------------------|---|
| 10. [Tslope]:                        | Time of pressure rising   |
| 11. [Apnea Ventilation]:             | Switch for apnea ventilation                                    |
| 12. [TVapnea] or [ $\Delta$ Papnea]: | Tidal volume or inspiration pressure in apnea ventilation cycle |
| 13. [fapnea]:                        | Frequency of apnea ventilation                                  |
| 14. [Apnea Tinsp]:                   | Inspiration time of apnea ventilation                           |

In V-SIMV mode, you can set the following sigh function parameters as required:

- |                          |                                     |
|--------------------------|-------------------------------------|
| 1. [Sigh]:               | Switch for turning on sigh function |
| 2. [Interval]:           | Time interval between two sighs     |
| 3. [Cycles Sigh]:        | Number of sigh cycles               |
| 4. [ $\Delta$ int.PEEP]: | PEEP added in sigh cycle            |

### 6.5.6 P-SIMV

P-SIMV is pressure-synchronized intermittent mandatory ventilation mode. It provides the minimum number of mandatory breaths based on the preset intermittent mandatory ventilation frequency. Mandatory ventilation mode is pressure mode (P-A/C mode). If patient triggers within the trigger window, ventilator delivers mandatory pressure control breath once. Mandatory pressure control breath is also delivered once if it is not triggered at the end of trigger window. Spontaneous breathing or pressure support breathing is supported outside the trigger window.

Trigger window is a period of buffer time for patient's synchronization inspiration. The period is in the later expiration phase of the mechanical ventilation. The trigger window is 5 s long for adult and 1.5 s long for pediatric while simultaneously it cannot exceed the expiratory time.

The following figure shows typical waveforms in P-SIMV+PSV mode.

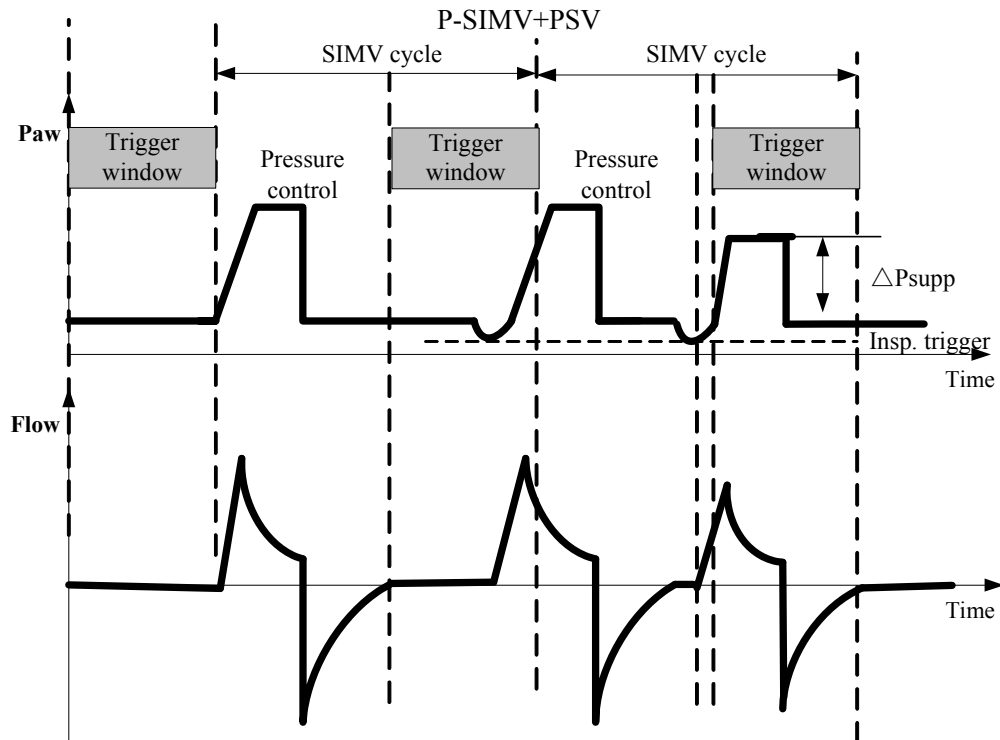

In P-SIMV mode, you need to set the following basic ventilation parameters:

1. [**O<sub>2</sub>%**]: Oxygen concentration
2. [**ΔP<sub>insp</sub>**]: Inspiration pressure
3. [**T<sub>insp</sub>**]: Inspiration time
4. [**f<sub>simv</sub>**]: Mandatory breathing frequency
5. [**T<sub>slope</sub>**]: Time of pressure rising
6. [**PEEP**]: Positive end-expiratory pressure
7. [**Exp%**]: Expiration trigger level
8. [**ΔP<sub>supp</sub>**]: Pressure support level
9. [**F-Trig**] or [**P-Trig**]: Inspiration trigger level
10. [**Apnea Ventilation**]: Switch for apnea ventilation
11. [**TV<sub>apnea</sub>**] or [**ΔP<sub>apnea</sub>**]: Tidal volume or inspiration pressure in apnea ventilation cycle
12. [**f<sub>apnea</sub>**]: Frequency of apnea ventilation
13. [**Apnea T<sub>insp</sub>**]: Inspiration time of apnea ventilation

In P-SIMV mode, you can set the following sigh function parameters as required:

1. [**Sigh**]: Switch for turning on sigh function
2. [**Interval**]: Time interval between two sighs

3. [Cycles Sigh]: Number of sigh cycles
4. [ $\Delta$ int.PEEP]: PEEP added in sigh cycle

### 6.5.7 CPAP/PSV

PSV is pressure support ventilation mode. The system delivers a PSV when it detects that patient inspiratory effort reaches the preset inspiration trigger level. Time of pressure rising and pressure support level are set by the user. At the beginning of inspiratory phase, the patient's airway pressure rises to the preset pressure level within the preset time of pressure rising, and is held at this pressure level till patient inspiratory flow is detected to reach the expiration trigger level. In PSV, when the airway pressure is held at the preset pressure level, delivered gas flow decelerates, and varies with the resistance and compliance of the patient's lungs.

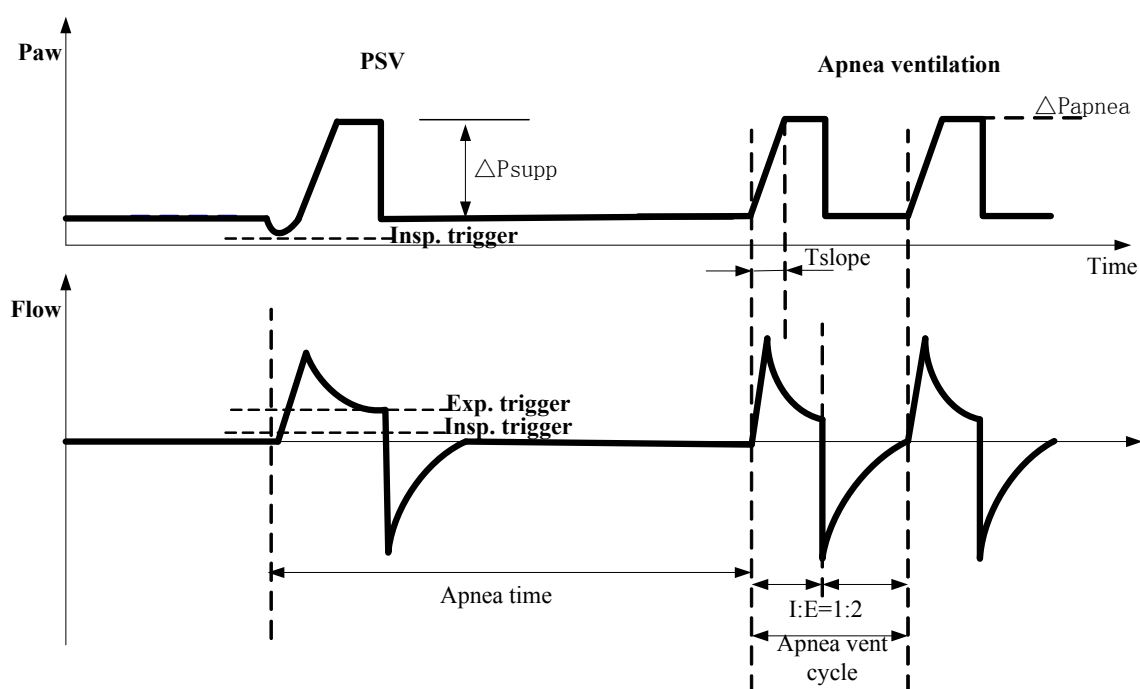

CPAP is continuous positive airway pressure ventilation mode. The airway pressure is held at the user-set positive pressure level throughout the ventilation cycle. The patient breathes spontaneously and determines his own breathing frequency, tidal volume, and breath time. The system starts apnea ventilation when it detects that the period of time in which patient does not perform continuous spontaneous breathing exceeds the preset apnea time.

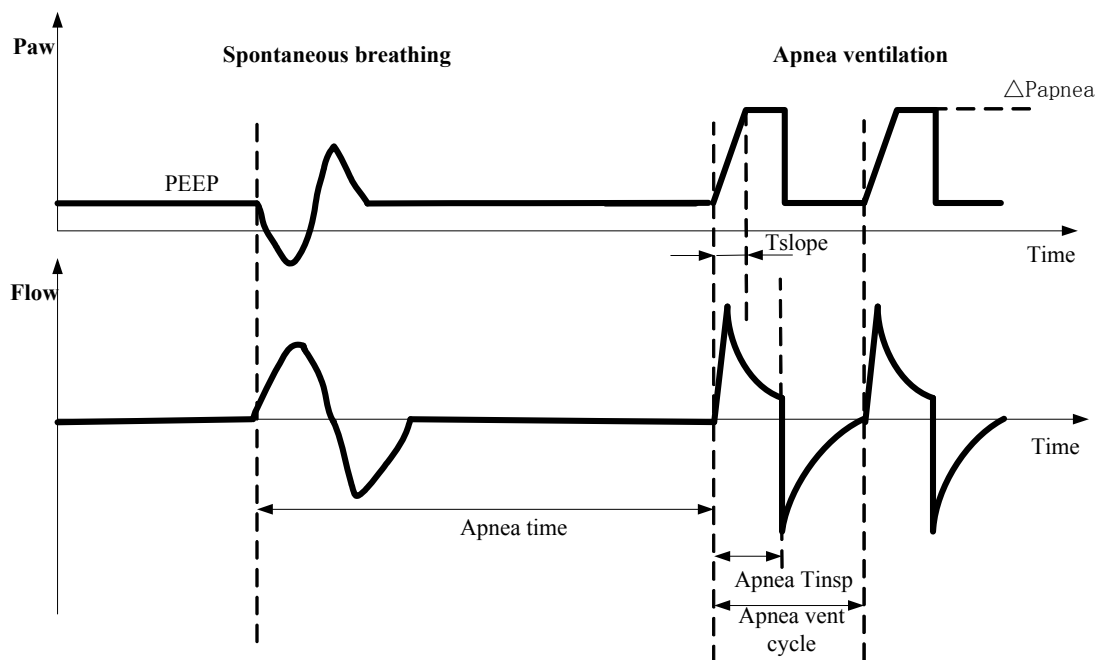

In CPAP/PSV mode, you need to set the following basic ventilation parameters in Invasive ventilation:

1. **[O<sub>2</sub>%]**: Oxygen concentration
2. **[\Delta P<sub>supp</sub>]**: Pressure support level (for PSV mode)
3. **[PEEP]**: Positive end-expiratory pressure
4. **[F-Trig]** or **[P-Trig]**: Inspiration trigger level
5. **[Exp%]**: Expiration trigger level
6. **[Tslope]**: Time of pressure rising
7. **[TV<sub>apnea</sub>]** or **[\Delta P<sub>apnea</sub>]**: Tidal volume or inspiration pressure in apnea ventilation cycle
8. **[f<sub>apnea</sub>]**: Frequency of apnea ventilation
9. **[Apnea Tinsp]**: Inspiration time of apnea ventilation

In CPAP/PSV mode, you need to set the following basic ventilation parameters in Non-Invasive ventilation (NIV):

1. **[O<sub>2</sub>%]**: Oxygen concentration
2. **[\Delta P<sub>supp</sub>]**: Pressure support level (in PSV mode)
3. **[PEEP]**: Positive end-expiratory pressure
4. **[Tinsp]**: Inspiration time
5. **[F-Trig]** or **[P-Trig]**: Inspiration trigger level
6. **[Exp%]**: Expiration trigger level

7. [Tslope]: Time of pressure rising
8. [TVapnea] or [ $\Delta P_{apnea}$ ]: Tidal volume or inspiration pressure in apnea ventilation cycle
9. [fapnea]: Frequency of apnea ventilation
10. [Apnea Tinsp]: Inspiration time of apnea ventilation

### 6.5.8 PRVC

PRVC is pressure regulated volume control ventilation mode. It implements delivering set tidal volume by the way of pressure control ventilation. In PRVC, a relatively low pressure level is held as much as possible during the inspiratory phase, and the gas volume delivered is guaranteed to be equal to the preset tidal volume. Ppeak will vary according to the tidal volume setting and the resistance and compliance of the patient's lungs. Pressure adjustment increase of the ventilator cannot exceed 10 cmH<sub>2</sub>O for the first 3 cycles, and cannot exceed 3 cmH<sub>2</sub>O for each of the following cycles. The maximum pressure cannot exceed the pressure alarm high limit-5 cmH<sub>2</sub>O.

The first PRVC delivered is experimental ventilation mode. And the gas delivery pressure of the first cycle is 10 cmH<sub>2</sub>O+PEEP for the purpose of calculating compliance and resistance of the system and patient's lungs, and calculating pressure level based on the patient's condition. This pressure level will then be used as a regulating object for tidal volume control in the following ventilation cycles.

The following figure shows typical waveforms in PRVC mode.

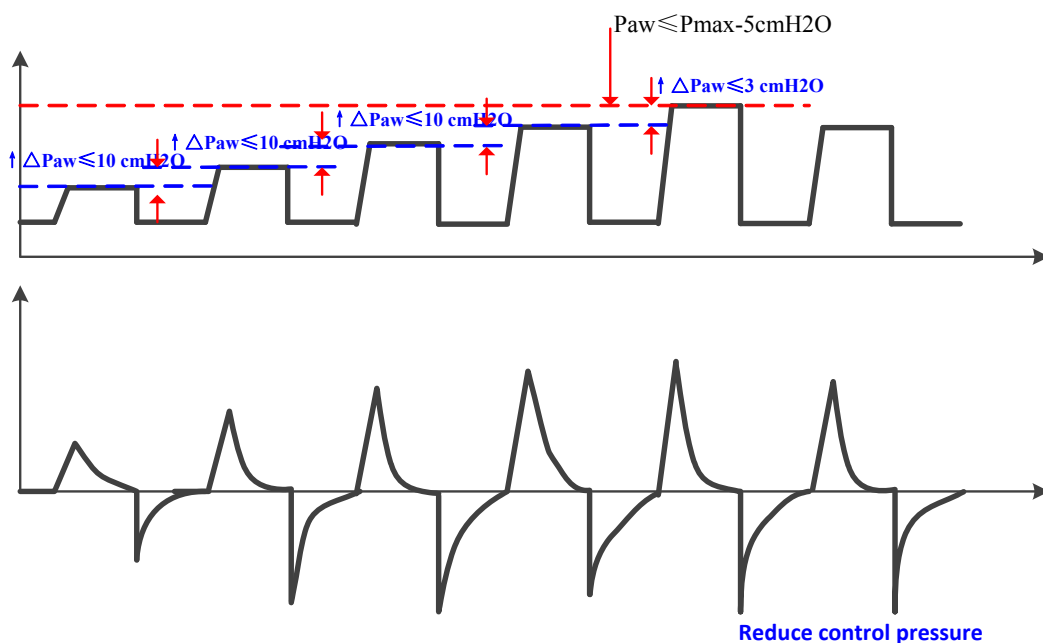

---

In PRVC mode, you need to set the following ventilation parameters:

1. [O<sub>2</sub>%]: Oxygen concentration
2. [TV]: Tidal volume
3. [T<sub>insp</sub>] or [I:E]: Inspiration time or ratio of inspiratory time to expiratory time
4. [f]: Breathing frequency
5. [PEEP]: Positive end-expiratory pressure
6. [Assist]: Switching trigger ON/OFF
7. [F-Trig] or [P-Trig]: Inspiration trigger level
8. [Tslope]: Time of pressure rising

In PRVC mode, you can set the following sigh function parameters as required:

1. [Sigh]: Switch for turning on sigh function
2. [Interval]: Time interval between two sighs
3. [Cycles Sigh]: Number of sigh cycles
4. [ $\Delta$ int.PEEP]: PEEP added in sigh cycle

### 6.5.9 PRVC-SIMV

PRVC-SIMV is pressure regulated volume control -synchronized intermittent mandatory ventilation mode. It provides the minimum number of mandatory breaths based on the preset intermittent mandatory ventilation frequency. The provided mechanical ventilation mode is volume mode (PRVC mode). If patient triggers within the trigger window, ventilator delivers mandatory PRVC breath once. Mandatory PRVC breath is also delivered once if it is not triggered at the end of trigger window. Spontaneous breathing or pressure support breathing is supported outside the trigger window.

Trigger window is a period of buffer time for patient's synchronization inspiration. The period is in the later expiration phase of the mechanical ventilation. The trigger window is 5 s long for adult and 1.5 s long for pediatric while simultaneously it cannot exceed the expiratory time.



The following figure shows typical waveforms in PRVC -SIMV+PSV mode.

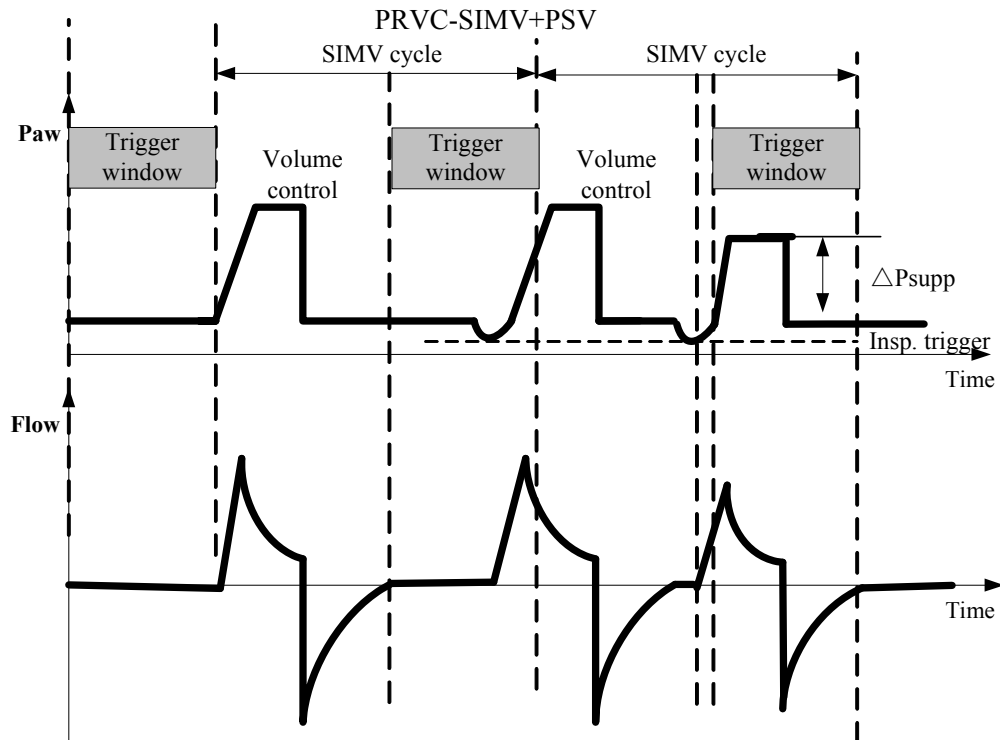

In PRVC-SIMV mode, you need to set the following basic ventilation parameters:

1. **[O<sub>2</sub>%]**: Oxygen concentration
2. **[TV]**: Tidal volume
3. **[T<sub>insp</sub>]**: Inspiration time
4. **[f<sub>simv</sub>]**: Mandatory breathing frequency
5. **[ΔP<sub>supp</sub>]**: Pressure support level
6. **[PEEP]**: Positive end-expiratory pressure
7. **[F-Trig]** or **[P-Trig]**: Inspiration trigger level
8. **[Exp%]**: Expiration trigger level
9. **[Tslope]**: Time of pressure rising
10. **[Apnea Ventilation]**: Switch for apnea ventilation
11. **[TV<sub>apnea</sub>]** or **[ΔP<sub>apnea</sub>]**: Tidal volume or inspiration pressure in apnea ventilation cycle
12. **[f<sub>apnea</sub>]**: Frequency of apnea ventilation
13. **[Apnea T<sub>insp</sub>]**: Inspiration time of apnea ventilation

---

In PRVC-SIMV mode, you can set the following sigh function parameters as required:

1. **[Sigh]:** Switch for turning on sigh function
2. **[Interval]:** Time interval between two sighs
3. **[Cycles Sigh]:** Number of sigh cycles
4. **[ $\Delta$ int.PEEP]:** PEEP added in sigh cycle

### 6.5.10 DuoLevel

DuoLevel is dual level positive airway pressure ventilation mode. In DuoLevel mode, the ventilator delivers positive airway pressure at two pressure levels alternatively during mechanical ventilation or spontaneous breathing. The patient can breathe spontaneously at either pressure level. During the low pressure phase, pressure support can be set. Trigger window is available during both high and low pressure phases, during which triggered transition to the other pressure level occurs. The trigger window during the low pressure phase is the later 5 seconds of low pressure time (Tlow), while the trigger window during the high pressure phase is the later 1/4 of high pressure time (Thigh). Within the trigger window of low pressure phase, inspiratory trigger transforms to high pressure gas delivery. Within the trigger window of high pressure phase, expiratory trigger transforms to low pressure gas delivery.

Trigger window is a period of buffer time for patient's synchronization inspiration. The period is in the later expiration phase of the mechanical ventilation. The trigger window is 5 s long for adult and 1.5 s long for pediatric while simultaneously it cannot exceed the expiratory time.

The following figure shows typical waveforms in DuoLevel mode.

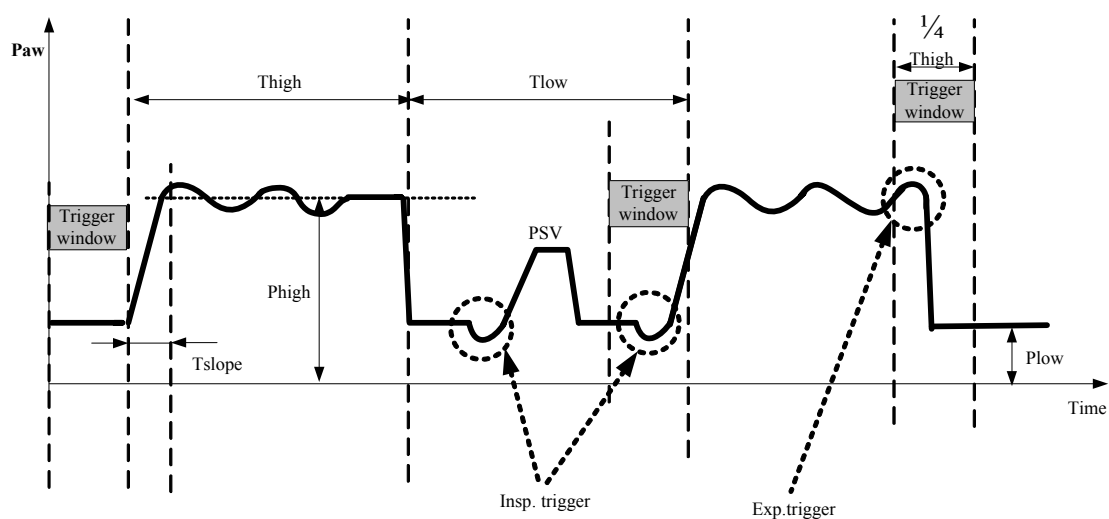

---

In DuoLevel mode, you need to set the following basic ventilation parameters:

1. **[O<sub>2</sub>%]**: Oxygen concentration
2. **[Phigh]**: High pressure
3. **[Thigh]** or **[f]**: Time of high pressure or breathing frequency
4. **[Plow]**: Low pressure
5. **[Tlow]**, **[Tinsp]** or **[I:E]**: Time of low pressure, inspiration time or ratio of inspiratory time to expiratory time
6. **[ $\Delta$ Psupp]**: Pressure support level
7. **[F-Trig]** or **[P-Trig]**: Inspiration trigger level
8. **[Exp%]**: Expiration trigger level
9. **[Tslope]**: Time of pressure rising
10. **[TVapnea]** or **[ $\Delta$ Papnea]**: Tidal volume or inspiration pressure in apnea ventilation cycle
11. **[fapnea]**: Frequency of apnea ventilation
12. **[Apnea Tinsp]**: Inspiration time of apnea ventilation

### 6.5.11 APRV

APRV is airway pressure release ventilation mode. It can be seen as periodical, short period airway pressure release in CPAP mode.

The following figure shows typical waveforms in APRV mode.

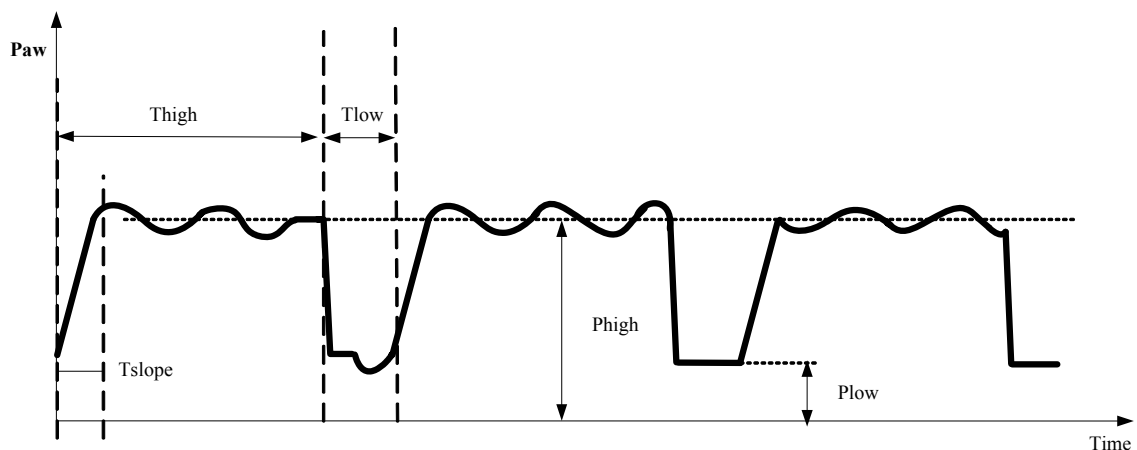

In APRV mode, you need to set the following ventilation parameters:

1. **[O<sub>2</sub>%]**: Oxygen concentration
2. **[Phigh]**: High pressure
3. **[Thigh]**: Time of high pressure
4. **[Plow]**: Low pressure
5. **[Tlow]**: Time of low pressure
6. **[Tslope]**: Time of pressure rising
7. **[TVapnea]** or **[ΔPapnea]**: Tidal volume or inspiration pressure in apnea ventilation cycle
8. **[fapnea]**: Frequency of apnea ventilation
9. **[Apnea Tinsp]**: Inspiration time of apnea ventilation
10. **[F-Trig]** or **[P-Trig]**: Inspiration trigger level

## 6.5.12 AMV

AMV refers to adaptive minute ventilation, which is a ventilation mode that adjusts the patient's ventilation parameters based on minimum work of breathing (WOB). The user only needs to enter the patient's ideal body weight (IBW) and target minute ventilation volume percentage, the ventilator will calculate the tidal volume and breathing frequency with the minimum WOB using the Otis equation. It will also adjust the I:E ratio depending on the measured lung time constant. AMV is only suitable for adult and pediatric ventilation.

Otis equation:

$$f = \sqrt{\frac{1 + 2a \cdot RC_{exp} \cdot \frac{MV - f \cdot V_d}{V_d} - 1}{a \cdot RC_{exp}}}$$

Where, f is the breathing frequency under minimum WOB, MV is target minute volume, V<sub>d</sub> is volume of patient's physiological dead space, RC<sub>exp</sub> refers to time constant of lung, a is coefficient of waveform, For sine-wave, a=2π<sup>2</sup>/60.

Target minute volume is calculated by the following formula:

Target minute volume MV= Minute volume %×f<sub>default</sub>×TV/IBW×IBW/1000

Where, TV/IBW refers to ideal body weight tide volume. IBW is ideal body weight. f<sub>default</sub> is a group of defaults related to IBW, which values are listed as below:

IBW (kg)	f <sub>default</sub> (/min)
[3, 9)	35
[9, 13)	30
[13, 17)	25
[17, 23)	20
[23, 29)	15
[29, 36)	14
[36, 200)	12

The first three cycles of AMV is PCV experimental ventilation to calculate patient's lung resistance and compliance. Initial ventilation parameters are:

Adult experimental ventilation cycle setting parameters

IBW (kg)	P <sub>insp</sub> (cmH <sub>2</sub> O)	T <sub>insp</sub> (s)	f(/min)
10-29	15	1	15
30-39	15	1	14
40-59	15	1	12
60-89	15	1	10
90-99	18	1.5	10
≥100	20	1.5	10

Pediatric experimental ventilation cycle setting parameters

IBW (kg)	P <sub>insp</sub> (cmH <sub>2</sub> O)	T <sub>insp</sub> (s)	f(/min)
3-5	15	0.4	30
6-8	15	0.6	25
9-11	15	0.6	20
12-14	15	0.7	20
15-20	15	0.8	20
21-23	15	0.9	15
24-29	15	1	15
30-35	15	1	14

After three experimental ventilation, enter the automatic adjustment stage. Based on the principle of minimum WOB, ensure that the actual minute volume is as close as possible to the preset minute volume value. Mandatory ventilation is administered if the patient has no spontaneous breathing. Support ventilation is administered if the patient restores spontaneous breathing.

The following figure shows typical waveforms in AMV mode.

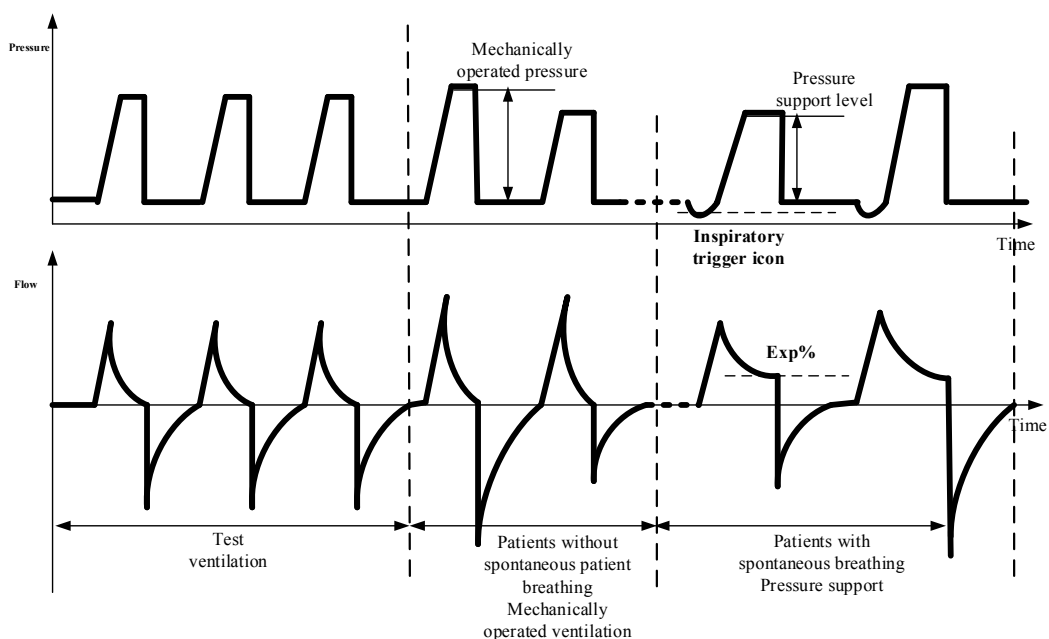

---

In AMV mode, you need to set the following basic ventilation parameters:

1. **[O<sub>2</sub>%]**: Oxygen concentration
2. **[MV%]**: Percentage of minute volume
3. **[PEEP]**: Positive end-expiratory pressure
4. **[F-Trig]** or **[P-Trig]**: Inspiration trigger level
5. **[Exp%]**: Expiration trigger level
6. **[Tslope]**: Time of pressure rising

## 6.6 Additional settings for ventilation

### 6.6.1 Sigh

Atelectasis can be prevented by activating the sigh function and setting the sigh in the form of an intermittent PEEP. The purpose of expiratory sigh is to open collapsed areas of the lung or to keep open "more dependent" areas of the lung.

The sigh function can be activated in V-A/C, P-A/C, PRVC, V-SIMV, P-SIMV, PRVC-SIMV and AMV ventilation modes. When the sigh function is activated, the end-expiratory pressure PEEP increases by the set value of  $\Delta\text{int.PEEP}$ .

The time between the two sigh phases can be set with **[Interval]**.

**[Cycles sigh]** controls how many respiratory cycles are covered by the sigh phase. The average airway pressure is higher, and a longer filling time is normally available.

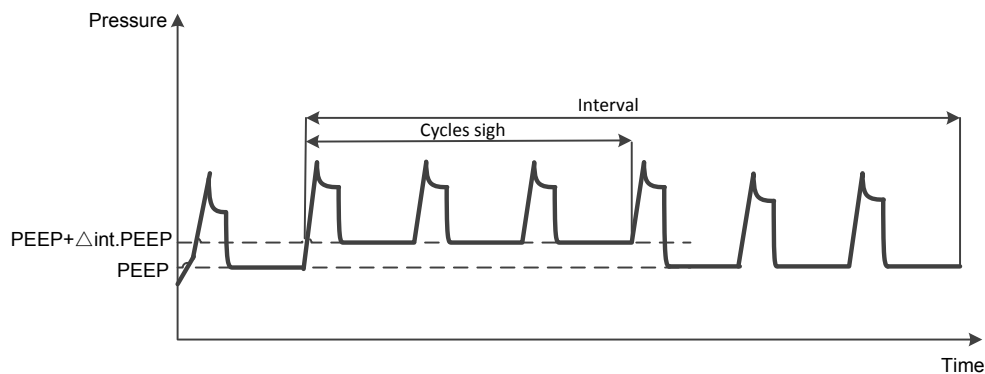

---

## 6.6.2 Leakage compensation

The leakage from the breathing circuit and mask may cause that the gas volume delivered to the patient's lung is lower than the setting value. The leakage also may cause the false inspiratory trigger or difficult switching between inspiratory and expiratory.

The ventilator provides automatic leakage compensation function. The ventilator updates the amount of leakage at the end of each breathing cycle according to the difference between the inspired tidal volume and expired tidal volume, and the amount of leakage can be used for the calculation of real-time leakage flow in next breathing cycle.

During the expiration stage, the base flow will be regulated automatically to compensate the leakage and maintain the PEEP valve. In order to prevent the false inspiratory trigger, flow trigger working mechanism is based on the compensated flow. Maximum leakage compensation flow is 65 L/min for adults and 45 L/min for pediatrics.

In volume control ventilation mode, the delivered gas volume is the sum of the setting TV and the amount of leakage. The leakage compensation in invasive ventilation: the upper limit of the leakage compensation is 80% of the setting TV.

In pressure control ventilation mode, the ventilator regulates the flow automatically to compensate the leakage in order to maintain the inspiratory pressure. But the upper limit of the compensation is restricted by the TV high limit. The ventilator will not increase the flow and display the **[Volume Limited]** alarm message when the flow exceeds the TV high limit (If you want to reach the maximum leakage compensation, you can set the TV high limit to off).

### Automatic leakage compensation

The ventilator determines the difference between the delivered flow on the inspiration side and the measured flow on the expiration side.

This difference provides a measure of the amount of leakage and is displayed by the ventilator as the leakage minute volume MV<sub>leak</sub>.

The ventilator can compensate for this leakage in volume controlled ventilation.

Example: Tidal volume setting TV = 600 mL, 10 % leakage in tube.

### Without Leakage compensation

The ventilator delivers 600 mL. This is indicated as the inspiratory tidal volume TV<sub>i</sub>. 60 mL escape as leakage during inspiration, and 540 mL reach the lung.

540 mL are expired, and 40 mL again escape as leakage. A tidal volume of 500 mL is measured on the expiration side and indicated as TV<sub>e</sub>.

With a ventilation rate of 10 strokes per minute, a minute volume of 6.0 L/min is delivered on the inspiration side and a minute volume of 5.0 L/min is measured on the expiration side. The lung is ventilated with an MV of 5.4 L/min.

Without leakage compensation, the set TV determines the volume delivered by the ventilator.

---

With Leakage compensation

With automatic leakage compensation, the ventilator delivers 660 mL on the basis of the measured leakage minute volume, instead of the 600 mL set.

600 mL enter the lung and the displayed inspiratory tidal volume TV is 600 mL.

The volume of 500 mL measured on the expiration side is displayed without compensation, even when leakage compensation is activated.

The minute volume measured on the expiration side is 5.0 L/min and is also uncompensated. If this were not so, the alarm for a low minute volume could be inhibited by the expiratory leakage compensation. The ventilator must always emit an alarm if the minute volume is too low.

With leakage compensation, the set TV determines the volume to be delivered to the patient. This example has been simplified:

In fact, the calculated leakage correction takes into account the pressures in the hose system. A higher percentage volume is lost on the inspiration side than on the expiration side because the pressure during inspiration is higher.

The displayed leakage minute volume MVLeak is based on the mean pressure Pmean.

The leakage minute volume MVLeak also takes the inspiratory leaks into account. The sum of the minute volume MV + the leakage minute volume MVLeak is consequently greater than the inspiratory minute volume delivered to the patient.

Unlimited volume compensation is inappropriate.

The ventilator compensates for losses of up to 100 % of the set tidal volume TV.

Due to technical tolerances, a small leakage minute volume may be displayed even if the hose system is leakproof.

## 6.7 Set Alarm Limits

You can set the alarm limits for Paw, MV, ftotal and TVe by pressing the [**Alarm Setup**] key and selecting alarm limits in the accessed menu. You can set EtCO<sub>2</sub> alarm limits if your ventilator is configured with CO<sub>2</sub> module. You can also set alarm volume and apnea time (Tapnea). For details, refer to *10 Alarms*.

## 6.8 Start Ventilation

---

### **WARNING**

---

- **Before using the ventilator on the patient, check that the oxygen concentration in the delivered gas is consistent with the setting value.**
  - **Adopt manual ventilation immediately if the ventilator malfunctions and cannot continue ventilating the patient.**
- 
- 

Select [**Start Ventilation**] in Standby status, and the system begins to ventilate the patient according to your settings.



---

## 6.9 Ventilation Parameters

---

### WARNING

- As required by the relevant rules and regulations, oxygen concentration shall be monitored when the equipment is used on the patient. If your ventilator is not configured with such monitoring function or this function is switched off, use a monitor which complies with ISO 80601-2-55 for oxygen concentration monitoring.
- 

### NOTE

- All the parameter values are calculated based on the real-time flow and pressure waveform data. For real-time flow and pressure data, low pass filter is adopted at original sampling rate of 1KHz and cutoff frequency of 20Hz.
  - Tidal volume, minute volume displayed on the ventilator and related calculation parameters are in the BTPS condition.
- 

Setting parameter	Description
TV	The gas volume the patient inspires or expires each time during resting breathing.
O <sub>2</sub> %	The volume percentage of oxygen in the mixed gas delivered to the patient.
I:E	The ratio between the inspiratory and expiratory time.
PEEP	Positive end-expiratory pressure.
Phigh	Phigh is the high pressure level at which the patient can spontaneously breathe and is an absolute value.
ΔP <sub>insp</sub>	It is a relative value of the pressure, relative to PEEP.
Plow	Plow is the low pressure level at which the patient can breathe spontaneously.
ΔP <sub>supp</sub>	Pressure support level in pressure control mode. It is a relative value relative to PEEP or Plow.
Tslope	Controls pressure rise slope in pressure mode.
T <sub>pause</sub> (%)	Percent of gas delivery pause time in inspiratory time within the inspiratory phase.
MV%	Used for calculating the patient's target minute volume Target minute volume is equal to ideal minute volume * minute volume%
f	The number of mechanically controlled breaths delivered to the patient in one minute.
f <sub>simv</sub>	Mandatory breathing frequency set in SIMV mode.
Thigh	Thigh is the time that the ventilator will hold the high pressure level.

<b>Setting parameter</b>	<b>Description</b>
Tlow	Tlow is the time that the ventilator will hold the low pressure level.
Tinsp	Inspiration Time in one breathing cycle.
F-Trig/P-Trig	Pressure trigger and flow trigger included. When the trigger level is detected, the ventilator starts to enter the inspiratory phase. When F-Trig is active, at the late stage of expiration the ventilator delivers a base flow from the inspiratory limb to the expiratory limb. The base flow is essential for flow trigger. In NIV, the ventilator adjusts base flow from 0 L/min to maximum flow automatically to maintain PEEP and establish baseline for patient triggering. Maximum flow is 65 L/min for adults and 45 L/min for pediatrics. In IV, the ventilator adjusts base flow from 3 L/min to maximum flow automatically to maintain PEEP and establish baseline for patient triggering. Maximum flow is 20 L/min.
Exp%	Inspiratory termination level. The ventilator is switched to the expiratory phase when the inspiratory flow drops to peak flow*Exp%.
Assist	Turn on or turn off the assisted trigger function. When this function is turned on, the patient is allowed to trigger mechanical ventilation at the end of expiration.
Apnea ventilation	Turn on or turn off apnea ventilation function.
$\Delta$ Papnea	It is inspiration pressure in apnea ventilation when pressure mode is selected for apnea ventilation. It is a relative value relative to PEEP or Plow.
fapnea	Breathing frequency set in apnea ventilation mode.
TVapnea	It is delivered tidal volume in apnea ventilation when volume mode is selected for apnea ventilation.
Apnea Tinsp	Inspiration time set in apnea ventilation mode.
Sigh	Turn on or turn off sigh function.
Interval	It is the setting value of time interval between two groups of sigh ventilation.
Cycles Sigh	It is the setting value of number of cycles of every group of sigh ventilation.
$\Delta$ int.PEEP	It is intermittent PEEP augmentation, added during the sigh cycle.
Disable ATRC	Turn on or turn off ATRC function.
ET Tube	Initiate ATRC function for ET tube.
Trach Tube	Initiate ATRC function for Trach tube.
Tube I.D.	It refers to the diameter of tracheal or ET tube.
Compensate	It refers to proportion of ATRC compensation.
Expiration	Turn on or turn off ATRC function during the expiratory phase.

<b>Monitored parameter</b>	<b>Description</b>
Ppeak	The maximum pressure value in one breathing cycle.
Pplat	The airway pressure during inspiratory pause.
Pmean	The mean pressure value in one breathing cycle.
PEEP	Positive end-expiratory pressure.
TVi	The inspired tidal volume in one cycle.
TVe	The expired tidal volume in one cycle.
TVe spn	The spontaneous expired tidal volume in one cycle.
TVe/IBW	Delivered tidal volume per ideal body weight.
MV	The accumulated expired tidal volume in one minute.
MVspn	The accumulated spontaneous expired tidal volume in one minute.
MVleak	The accumulated leakage (inspiratory volume minus expiratory volume) in one minute.
ftotal	The accumulated number of breaths in one minute.
fmand	The accumulated number of mandatory breaths in one minute.
fspn	The accumulated number of spontaneous breaths in one minute.
I:E	The ratio between the inspiratory and expiratory time.
Tinsp	Inspiration Time in one breathing cycle.
Ri	Inspiratory resistance the gas encounters when it flows inside the respiratory tract during respiration.
Re	Expiratory resistance the gas encounters when it flows inside the respiratory tract during respiration.
Cstat	Static compliance - easiness of patient's lungs being filled during mechanically assisted breathing. It is calculated in case of breathing paused and inspiration hold.
Cdyn	Dynamic compliance - easiness of patient's lungs being filled during mechanically assisted breathing. It is calculated during the inspiratory phase.
RSBI	Rapid shallow breathing index - quotient between fspn and TVe spn (measured in liters).
WOB	Work of breathing – work required to deliver a certain volume of gas to the patient's lungs within one cycle.
RCexp	Patient's expiratory time constant – resistance multiplied with compliance.
NIF	Patient's maximum inspiratory negative occlusion pressure.
P0.1	The occlusion pressure drop in the first 100 ms when the patient starts spontaneous breathing.
PEEPi	Intrinsic PEEP (The PEEPi value displayed has already included PEEP value and

Monitored parameter	Description
	is the actual airway pressure).
Vtrap	The volume of trapped gas in the lungs.
FiO <sub>2</sub>	The percentage of oxygen in the patient's inspired gas.
EtCO <sub>2</sub>	The concentration of CO <sub>2</sub> measured at the end of expiration.
Vdaw	Airway dead space.
Vdaw/TVe	Ratio of airway dead space to tidal volume.
Vtalv	Alveolar tidal ventilation.
V'alv	Alveolar minute ventilation.
slopeCO <sub>2</sub>	CO <sub>2</sub> rising slope.
V'CO <sub>2</sub>	CO <sub>2</sub> elimination.
VeCO <sub>2</sub>	Exhaled CO <sub>2</sub> volume.
ViCO <sub>2</sub>	Inspired CO <sub>2</sub> volume.

## 6.10 Enter Standby Status



Press the [Standby] key. Standby status commences after your confirmation.

### WARNING

- To prevent possible patient injury due to lack of ventilatory support, secure alternative ventilation for the patient before entering the Standby status. You must confirm that no patient is attached before entering Standby status.
- To prevent possible patient injury or damage to breathing circuit from overheated gas, turn off the humidifier before entering the Standby status.

## 6.11 Turn the System off

Press the  key in Standby, to turn the system off.

In non-standby status, if you press the  key, the system will prompt [Please enter Standby mode to shut down the system.]. Select [Ok] to return to non-standby status. Then press the [Standby] key to enter Standby status after your confirmation and press the  key to turn the system off.

# 7 CO<sub>2</sub> Monitoring

---

## 7.1 Introduction

CO<sub>2</sub> monitoring is a continuous, non-invasive technique for determining the concentration of CO<sub>2</sub> in the patient's airway by measuring the absorption of infrared (IR) light of specific wavelengths. The CO<sub>2</sub> has its own absorption characteristic and the amount of light passing the gas probe depends on the concentration of the measured CO<sub>2</sub>. When a specific band of IR light is passed through respiratory gas samples, some of IR light will be absorbed by the CO<sub>2</sub> molecules. The amount of IR light transmitted after it has been passed through the respiratory gas sample is measured with a photodetector. From the amount of IR light measured, the concentration of CO<sub>2</sub> is calculated.

The respiration rated range of sidestream EtCO<sub>2</sub> module is 0 to 120 bpm, and the data sample rate is 50 Hz. And the EtCO<sub>2</sub> concentration reading is using the highest values respectively of the temporal CO<sub>2</sub> waveform.

The respiration rated rate range of mainstream EtCO<sub>2</sub> module is 0 to 150 bpm, and the data sample rate 100 Hz. And the EtCO<sub>2</sub> concentration reading is using the peak of the expired CO<sub>2</sub> waveform (Averaging selections: 1 breath, 10 second, 20 second) .

The method used to determine the respiration rated range: Utilize a valve to permit switching between the two sampling gases at different frequencies (simulating the range of specified breath rates). Record the EtCO<sub>2</sub> value presented for each frequency. By drawing the coordinate diagram which indicates the corresponding relationship between end-tidal value and breathing frequency, the range of breathing frequency of EtCO<sub>2</sub> measurement accuracy complying with the specification can be obtained.

Both mainstream CO<sub>2</sub> module and sidestream CO<sub>2</sub> module this ventilator is configured with have the automatic atmospheric pressure compensation function.

The measurement provides:

1. CO<sub>2</sub> waveform.
2. End-tidal CO<sub>2</sub> (EtCO<sub>2</sub>) concentration: the CO<sub>2</sub> concentration measured at the end of the expiration phase.

---

For mainstream CO<sub>2</sub> module, besides the above mentioned CO<sub>2</sub> waveform and EtCO<sub>2</sub> monitored parameter, the measurement also provides:

1. V- CO<sub>2</sub> loop
2. Monitored parameters:
  - ◆ V<sub>daw</sub>: airway dead space.
  - ◆ V<sub>daw</sub>/T<sub>Ve</sub>: ratio of airway dead space to tidal volume.
  - ◆ V<sub>talv</sub>: alveolar tidal ventilation.
  - ◆ V'<sub>alv</sub>: alveolar minute ventilation.
  - ◆ slopeCO<sub>2</sub>: CO<sub>2</sub> rising slope.
  - ◆ V'<sub>CO<sub>2</sub></sub>: CO<sub>2</sub> elimination.
  - ◆ V<sub>e</sub>CO<sub>2</sub>: exhaled CO<sub>2</sub> volume.
  - ◆ V<sub>i</sub>CO<sub>2</sub>: inspired CO<sub>2</sub> volume.

Some monitored parameters of the mainstream CO<sub>2</sub> module (V<sub>daw</sub>, V<sub>daw</sub>/T<sub>Ve</sub>, V<sub>talv</sub>, V'<sub>alv</sub>, slopeCO<sub>2</sub>, V'<sub>CO<sub>2</sub></sub>, V<sub>e</sub>CO<sub>2</sub>, V<sub>i</sub>CO<sub>2</sub>) have reference significance only when the patient is in stable ventilation status. Stable ventilation status refers to the following situations:

- Patient is at rest for at least 30 minutes.
- Mechanical ventilation parameters (RR, TV, and etc) remain unchanged.
- No operations that may affect the patient's gas exchange or metabolism.

Some monitored parameters of the mainstream CO<sub>2</sub> module may be inaccurate in the following situations. The affected parameters include V<sub>daw</sub>, V<sub>daw</sub>/T<sub>Ve</sub>, V<sub>talv</sub>, V'<sub>alv</sub>, slopeCO<sub>2</sub>, V'<sub>CO<sub>2</sub></sub>, V<sub>e</sub>CO<sub>2</sub>, V<sub>i</sub>CO<sub>2</sub>.

- System leakage
- Patient ventilation condition is unstable
- High frequency ventilation (HFV)
- Breathing frequency greater than 35/min
- Neonate patient
- Non-invasive ventilation type
- Other circumstance causing wrong CO<sub>2</sub> and Flow measurements

---

## NOTE

---

- As required by the relevant rules and regulations, carbon dioxide concentration should be monitored when the equipment is used on the patient. If your ventilator is not configured with such monitoring function, use a monitor which complies with the relevant international rules and regulations for carbon dioxide concentration monitoring.
  - CO<sub>2</sub> cannot be measured in the aerosolized medicament environment. CO<sub>2</sub> module sampling and monitoring are disabled when the nebulizer is activated.
- 

## 7.2 Use a Sidestream CO<sub>2</sub> Module

### NOTE

---

- This section is only applicable to the ventilator configured with sidestream CO<sub>2</sub> module.
- 

### 7.2.1 Prepare to Measure CO<sub>2</sub>

1. Attach the water trap to the water trap fixer and then connect the CO<sub>2</sub> components as shown below.

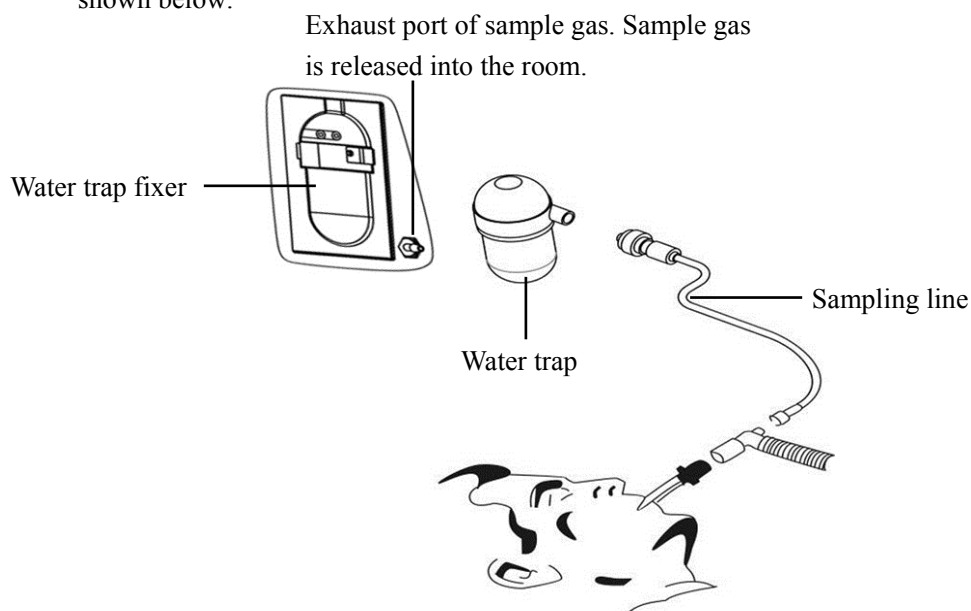

2. By default, the CO<sub>2</sub> module is in measure mode. When the CO<sub>2</sub> module is connected (CO<sub>2</sub> sensor monitoring is set to ON), the [CO<sub>2</sub> Startup] message is displayed on the screen.

- 
3. After start-up is finished, the **[CO<sub>2</sub> Warm-up]** message is displayed. The CO<sub>2</sub> module is in ISO accuracy mode. If you perform CO<sub>2</sub> measurements during warm-up, the measurement accuracy may be compromised.
  4. After warm-up is finished, the CO<sub>2</sub> module enters full accuracy mode.

## **NOTE**

---

- **To extend the lifetime of the water trap and CO<sub>2</sub> module, disconnect the water trap and set the CO<sub>2</sub> monitoring to OFF when CO<sub>2</sub> monitoring is not required.**
  - **It takes approximately 2 minutes from powering on the ventilator to reaching the sidestream CO<sub>2</sub> monitoring performance specified in section B.10 of this manual.**
  - **The sidestream CO<sub>2</sub> measurement can be used, with specified accessories, on intubated and non-intubated, adult and pediatric patients. A sample of the respiratory gas is drawn from the patient's breathing circuit through an airway adapter and a gas sampling line.**
  - **When dealing with water trap and sampling line, please comply with related biohazard regulations.**
  - **Please don't block this connector when the sample gas is emitted from CO<sub>2</sub> Module gas outlet.**
- 

## **CAUTION**

---

- **The water trap collects water drops condensed in the sampling line, and therefore it prevents water drops from entering the module. If the collected water reaches a certain amount, you should drain it to avoid blocking the airway. Dispose of accumulated fluids in accordance with the hospital policy or your local regulations.**
  - **The water trap has a filter preventing bacterium, vapor and patient secretions from entering the module. After a long-term use, dust or other substances may compromise the performance of the filter or even block the airway. In this case, replace the water trap. Replacing the water trap once a month is recommended. Or, replace the water trap when it is detected leaky, damaged or contaminated.**
-



---

## 7.2.2 Make CO<sub>2</sub> Settings

### 7.2.2.1 Set CO<sub>2</sub> Monitoring

When [**Monitoring**] is set to [**ON**], the CO<sub>2</sub> module enters operating mode. The ventilator displays CO<sub>2</sub> parameters and waveform, and provides physiological alarms and technical alarms related to CO<sub>2</sub> module. When [**Monitoring**] is set to [**OFF**], the CO<sub>2</sub> module enters standby mode. The ventilator does not display CO<sub>2</sub> parameters and waveform, and not provide physiological alarms related to CO<sub>2</sub> module either.

The standby mode of CO<sub>2</sub> module is relevant to the Standby status of ventilator:

- If the ventilator enters Standby status, the CO<sub>2</sub> module also enters standby mode.
- If the ventilator exits Standby status, the CO<sub>2</sub> module is restored to the CO<sub>2</sub> operating mode before standby mode.
- CO<sub>2</sub> module entering or exiting standby mode has no effect upon the ventilator.

To manually enter or exit standby mode, select the [**Setup**] key → [**Sensor**] → [**CO<sub>2</sub>**], and set [**Monitoring**] to [**OFF**] or [**ON**].

In standby mode, the working components of the CO<sub>2</sub> module, such as gas pump and infrared light source, are automatically turned off to extend the service life of the module.

### 7.2.2.2 Set Pump Rate

By selecting the [**Setup**] key → [**Sensor**] → [**CO<sub>2</sub>**], you can set the [**Pump Rate**] of the sampling of patient gas. When patient type is Adult, you can set [**Pump Rate**] to [**150**] mL/min, [**120**] mL/min, [**100**] mL/min, or [**70**] mL/min. When patient type is Pediatric, you can set [**Pump Rate**] to [**100**] mL/min or [**70**] mL/min.

The pump rate tolerance: 15 % or 15 mL/min, whichever is greater.

Normally the operator shall clear the water inside the CO<sub>2</sub> watertrap at regular intervals. For time interval to clear the watertrap, refer to section *B.10.1 Sidestream CO<sub>2</sub> Module*.

---

#### **WARNING**

- **Take the patient's actual breathing volumes into consideration, and select the appropriate pump rate for the patient.**
  - **Do not use a sidestream CO<sub>2</sub> module on the patient whose condition does not allow to take 70 mL/min out of his total minute ventilation.**
-

---

### 7.2.2.3 Set BTPS Compensation

The CO<sub>2</sub> module is configured to compensate CO<sub>2</sub> readings for either Body Temperature and Pressure, Saturated Gas (BTPS), to account for humidity in the patient's breath, or Ambient Temperature and Pressure, Dry Gas (ATPD).

1. ATPD:  $P_{CO_2}(mmHg) = CO_2(vol\%) \times P_{amb} / 100$
2. BTPS:  $P_{CO_2}(mmHg) = CO_2(vol\%) \times (P_{amb} - 47) / 100$

where,  $P_{CO_2}$  = partial pressure,  $vol\%$  = CO<sub>2</sub> concentration,  $P_{amb}$  = ambient pressure, and unit is mmHg.

For CO<sub>2</sub> module, BTPS compensation is switched on or off based on the actual situations.

1. Select the [Setup] key → [Sensor] → [CO<sub>2</sub> Module].
2. Set [BTPS Comp] to [ON] or [OFF] in either BTPS or ATPD.

### 7.2.2.4 Set Unit

1. Select the [Setup] key → [Maintain] → [User] → enter the required password → [Setting] → [Unit].
2. Set [CO<sub>2</sub> Unit] to [mmHg], [kPa] or [%].

### 7.2.2.5 Set CO<sub>2</sub> Waveform

Refer to 5.1.1 to set CO<sub>2</sub> waveform.

## 7.2.3 Measurement Limitations

Measurement accuracy may be compromised due to:

- Leakage or internal leakage of the sample gas
- Mechanical shock
- Cyclic pressure which is greater than 10 kPa (100 cmH<sub>2</sub>O)
- Other interference source (if available)

Measurement accuracy may be affected by the breath rate and I/E ratio as follow:

EtCO<sub>2</sub> is within specification for breath rate ≤ 60 bpm and I/E ratio ≤ 1:1;

EtCO<sub>2</sub> is within specification for breath rate ≤ 30 bpm and I/E ratio ≤ 2:1.

Measurement accuracy is unspecified for breath rate larger than 60 bpm.

---

## 7.2.4 Troubleshooting

When the sampling system of the CO<sub>2</sub> module works abnormally, check if the sampling line is kinked. If not, remove the sampling line from the water trap. Then, if a prompt message indicating airway malfunction appears on the screen, it means that the water trap is occluded. In this case, you must replace the water trap. If no such prompt message is displayed, it means that the sampling line is occluded. Then you must replace the sampling line.

## 7.2.5 Zero the Sensor

Zeroing the sensor aims to eliminate the effect of baseline drift on the readings during the measurement, so as to ensure measurement accuracy.

For CO<sub>2</sub> module, a zero calibration is carried out automatically if necessary. You can also start a manual zero calibration when it is necessary. To manually start a zero calibration, select the [**Setup**] key→[**Maintain**]→[**User**]→enter the required password→[**CO<sub>2</sub> In Maintenance**]. Then select [**Zero**]. Do not need to disconnect the sensor from the breathing system when performing the zeroing.

## 7.2.6 Calibrate the Sensor

For a sidestream CO<sub>2</sub> module, a calibration should be performed once a year or when the measured value has a great deviation. For details, refer to *12 Maintenance* .

---

## 7.3 Use a Mainstream CO<sub>2</sub> Module

### NOTE

- 
- This section is only applicable to the ventilator configured with mainstream CO<sub>2</sub> module.
- 

### 7.3.1 Prepare to Measure CO<sub>2</sub>

1. Connect the sensor to the CO<sub>2</sub> module.
2. By default, the mainstream CO<sub>2</sub> module is in measure mode. The [CO<sub>2</sub> Warm-up] message appears on the screen when the CO<sub>2</sub> module is switched on (CO<sub>2</sub> sensor monitoring is set to ON).
3. After warm-up is finished, connect the sensor to the airway adapter.
4. Perform a zero calibration, referring to **7.3.4 Zero the Sensor**
5. After the zero calibration is finished, connect the airway as shown below.

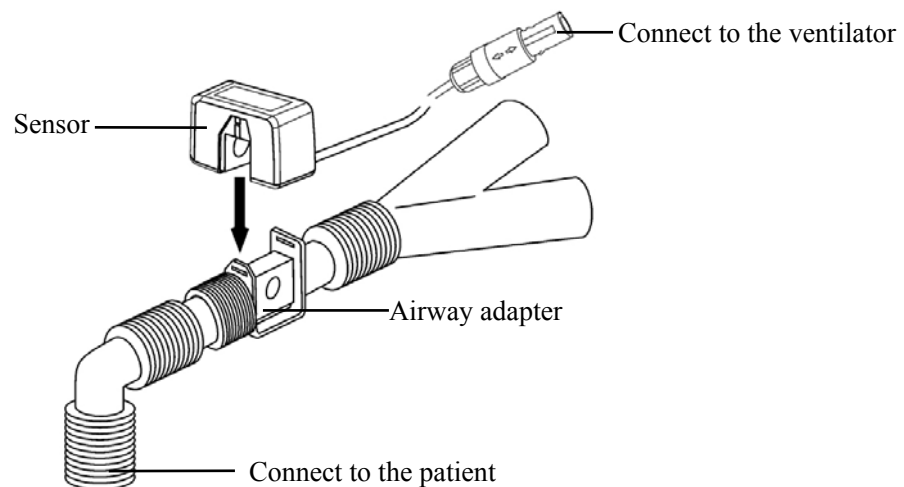

5. Ensure that there are no leakages in the airway, and then perform CO<sub>2</sub> measurements.

---

### WARNING

- 
- Always ensure the integrity of the patient breathing circuit by verifying a proper CO<sub>2</sub> waveform on the ventilator display after insertion of the airway adapter.
  - If the CO<sub>2</sub> waveform appears abnormally, inspect the CO<sub>2</sub> airway adapter and replace it if needed.
-

---

---

 **WARNING**

---

- Do not use the CO<sub>2</sub> sensor if it appears to have been damaged or if it fails to operate normally. Contact the Customer Service Department.
  - To reduce the risk of explosion, do not place the CO<sub>2</sub> sensor in a combustible or explosive environment.
  - Inspect the CO<sub>2</sub> airway adapter periodically for excess moisture and secretion accumulation.
  - Avoid permanent direct contact of the CO<sub>2</sub> sensor with the body.
- 

---

---

 **CAUTION**

---

- To prevent premature failure of the CO<sub>2</sub> sensor, CO<sub>2</sub> monitoring function is switched off from the moment of activating nebulization to one minute after the end of nebulization. The medication may contaminate the airway adapter window due to its viscosity. It is suggested to remove the CO<sub>2</sub> sensor and airway adapter from the pneumatic circuit.
- 

**NOTE**

---

- Always position the sensor above the adapter in an upright position to avoid collection of fluids on the windows of the adapter. Large concentrations of fluids at this point will obstruct gas analysis.
  - It takes approximately 2.5 minutes from powering on the CO<sub>2</sub> measurement to reaching the mainstream CO<sub>2</sub> monitoring performance specified in section B.10 of this manual.
  - The mainstream CO<sub>2</sub> measurement can be used, with specified accessories, on intubated and non-intubated, adult and pediatric patients.
-

---

## 7.3.2 Make CO<sub>2</sub> Settings

### 7.3.2.1 Set CO<sub>2</sub> Monitoring

When [**Monitoring**] is set to [**ON**], the CO<sub>2</sub> module enters operating mode. The ventilator displays CO<sub>2</sub> parameters and waveform, and provides physiological alarms and technical alarms related to CO<sub>2</sub> module. When [**Monitoring**] is set to [**OFF**], the CO<sub>2</sub> module enters standby mode. The ventilator does not display CO<sub>2</sub> parameters and waveform, and not provide physiological alarms related to CO<sub>2</sub> module either.

The standby mode of CO<sub>2</sub> module is relevant to the Standby status of ventilator:

- If the ventilator enters Standby status, the CO<sub>2</sub> module also enters standby mode.
- If the ventilator exits Standby status, the CO<sub>2</sub> module is restored to the CO<sub>2</sub> operating mode before standby mode.
- CO<sub>2</sub> module entering or exiting standby mode has no effect upon the ventilator.

To manually enter or exit standby mode, select the [**Setup**] key→[**Sensor**]→[**CO<sub>2</sub>**] to set [**Monitoring**] to [**OFF**] or [**ON**].

In standby mode, the working components of the CO<sub>2</sub> module, such as infrared light source, are automatically turned off to extend the service life of the module.

### 7.3.2.2 Set Maximum Hold

In the CO<sub>2</sub> parameter area, EtCO<sub>2</sub> value is refreshed in real-time. To set EtCO<sub>2</sub>:

1. Select the [**Setup**] key→[**Sensor**]→[**CO<sub>2</sub>**].
2. Select [**Max Hold**] and toggle between [**10 s**] and [**20 s**]. EtCO<sub>2</sub> is the maximum CO<sub>2</sub> concentration within the selected time interval.

### 7.3.2.3 Set Unit

1. Select the [**Setup**] key→[**Maintain**]→[**User**]→enter the required password→[**Setting**]→[**Unit**].
2. Set [**CO<sub>2</sub> Unit**] to [**mmHg**], [**kPa**] or [**%**].

### 7.3.2.4 Set CO<sub>2</sub> Waveform

Refer to 5.1.1 to set CO<sub>2</sub> waveform.

---

### 7.3.3 Measurement Limitations

Measurement accuracy may be compromised due to:

- Leakage or internal leakage of the sample gas
- Mechanical shock
- Cyclic pressure which is greater than 10 kPa (100 cmH<sub>2</sub>O)
- Other interference source (if available)

Measurement accuracy may be affected by the breath rate and I/E ratio as follow:

EtCO<sub>2</sub> is within specification for breath rate ≤ 60 bpm and I/E ratio ≤ 1:1;

EtCO<sub>2</sub> is within specification for breath rate ≤ 30 bpm and I/E ratio ≤ 2:1.

Measurement accuracy is unspecified for breath rate larger than 60 bpm.

### 7.3.4 Zero the Sensor

Zeroing the sensor aims to eliminate the effect of baseline drift on the readings during the measurement, so as to ensure measurement accuracy.

For mainstream CO<sub>2</sub> module, zero the sensor when:

1. The adapter is replaced.
2. The sensor is re-connected to the module.
3. The message [**CO<sub>2</sub> Zero Required**] is displayed. In this case, check the airway adapter for blockage. If a blockage is detected, clear or replace the adapter.

To zero the sensor, do as follows:

1. Connect the sensor to the CO<sub>2</sub> module.
2. Select the [**Setup**] key → [**Sensor**] → [**CO<sub>2</sub>**] and set [**Monitoring**] to [**ON**].
3. After warm-up is finished, connect the sensor to a clean, dry airway adapter. The adapter should be vented to the air and isolated from CO<sub>2</sub> sources, including ventilator, the patient's breathing and your own breathing.
4. Select the [**Setup**] key → [**Calibrate**] → [**Zero**]. Select the [**Start**] button corresponding to CO<sub>2</sub> zeroing on the right side of the screen, and the screen displays [**CO<sub>2</sub> Zeroing**].
5. A typical zeroing takes about 15 to 20 seconds. This message disappears after zeroing is completed.

---

#### **WARNING**

- **Before zeroing the sensor during the measurement, disconnect the sensor from the breathing system first.**
-

---

### **7.3.5 Calibrate the Sensor**

For a mainstream CO<sub>2</sub> module, calibration is not required. The system sends altitude to the mainstream CO<sub>2</sub> module for calibration compensation. Contact us if calibration of the mainstream CO<sub>2</sub> module is necessary.



# 8 SpO<sub>2</sub> Monitoring

---

## 8.1 Introduction

SpO<sub>2</sub> monitoring is a non-invasive technique, used to measure the amount of oxygenated haemoglobin and pulse rate by measuring the absorption of selected wavelengths of light. The light generated in the sensor passes through the tissue and is converted into electrical signals by the photo detector in the sensor. The SpO<sub>2</sub> module processes the electrical signal and displays a waveform and digital values for SpO<sub>2</sub> and pulse rate.

This device is calibrated to display functional oxygen saturation.

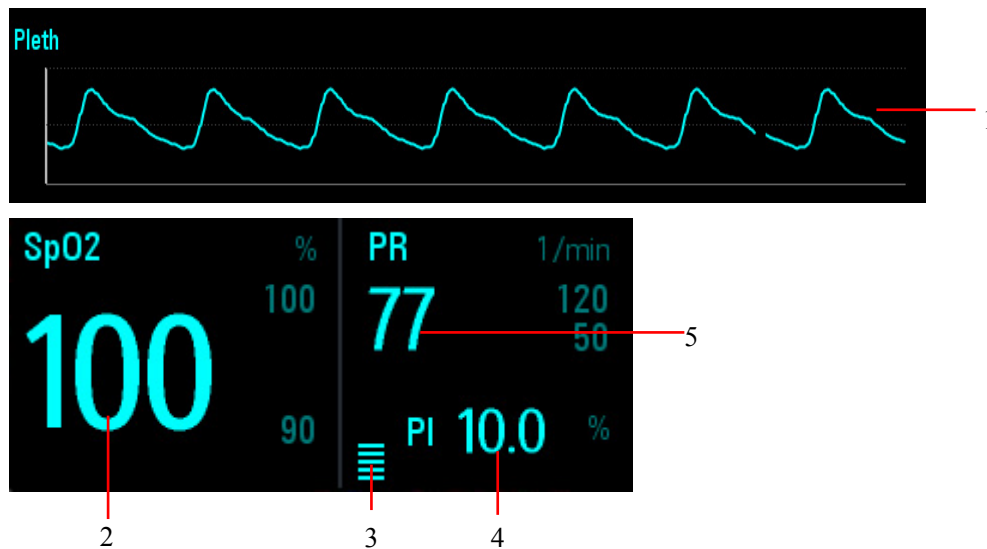

1. Pleth waveform: visual indication of patient's pulse. The waveform is not normalized.
2. Oxygen saturation of arterial blood (SpO<sub>2</sub>): percentage of oxygenated hemoglobin in relation to the sum of oxyhemoglobin and deoxyhemoglobin.
3. Perfusion indicator: the pulsatile portion of the measured signal caused by arterial pulsation.
4. Perfusion index (PI): gives the numerical value for the pulsatile portion of the measured signal caused by arterial pulsation. PI is an indicator of the pulsatile strength. You can also use it to assess the quality of SpO<sub>2</sub> measurement. Above 1 is optimal, between 0.3 and 1 is acceptable. Below 0.3 indicates low perfusion; reposition the SpO<sub>2</sub> sensor or find a better site. If low perfusion persists, choose another method to measure oxygen saturation if possible.
5. Pulse rate (derived from pleth wave): detected pulsations per minute.

---

## NOTE

---

- A functional tester or SpO<sub>2</sub> simulator can not be used to assess the accuracy of a SpO<sub>2</sub> module or a SpO<sub>2</sub> sensor.
  - A functional tester or SpO<sub>2</sub> simulator can be used to determine the pulse rate accuracy.
- 

## 8.2 Safety

---

### WARNING

---

- Use only SpO<sub>2</sub> sensors and cables specified in this manual. Follow the SpO<sub>2</sub> sensor's instructions for use and adhere to all warnings and cautions.
  - When a trend toward patient deoxygenation is indicated, blood samples should be analyzed by a laboratory co-oximeter to completely understand the patient's condition.
  - Do not use SpO<sub>2</sub> sensors during magnetic resonance imaging (MRI). Induced current could potentially cause burns. The sensor may affect the MRI image, and the MRI unit may affect the accuracy of the oximetry measurements.
  - Prolonged continuous monitoring may increase the risk of undesirable changes in skin characteristics, such as irritation, reddening, blistering or burns. Inspect the sensor site every two hours, and move the sensor if the skin quality changes. Change the application site every four hours. For patients with poor peripheral blood circulation or sensitive skin, inspect the sensor site more frequently.
  - The hospital needs to verify the compatibility of the ventilator, sensors, and cable before use, otherwise patient injury can result.
- 

## 8.3 Applying the Sensor

1. Select an appropriate sensor according to the module type, patient category and weight.
2. Remove colored nail polish from the application site, if applicable.
3. Apply the sensor to the patient.
4. Plug adapter cable into the SpO<sub>2</sub> connector on the ventilator.
5. Connect the sensor cable to the adapter cable.

---

---

 **WARNING**

---

- **If the sensor is too tight because the application site is too large or becomes too large due to edema, excessive pressure for prolonged periods may result in venous congestion distal from the application site, leading to interstitial edema and tissue ischemia.**
- 

## 8.4 Make SpO<sub>2</sub> Settings

### 8.4.1 Set SpO<sub>2</sub> Monitoring

Select the [Setup] key→[Sensor]→[SpO<sub>2</sub>] to set [Monitoring] to [OFF] or [ON].

### 8.4.2 Set SpO<sub>2</sub> Sensitivity

The SpO<sub>2</sub> value displayed on the ventilator screen is the average of data collected within a specific time. Sensitivity from high to low indicates the average time from short to long. Select the [Setup] key→[Sensor]→[SpO<sub>2</sub>] to set [Sensitivity] to [High], [Med] or [Low]. When the [Sensitivity] is set to [High], the ventilator is more sensitive to minor signals. To monitor critically ill patients whose pulsations are very weak, it is strongly recommended to set the sensitivity to [High]. During monitoring non-critically ill patients who tend to move a lot, noise or invalid signals may result. In this case, it is recommended to set the sensitivity to [Med] or [Low], so that the interference caused by motion can be filtered, and therefore the measurement stability can be ensured.

### 8.4.3 Set Beat Vol

Select [Setup] key→[Sensor]→[SpO<sub>2</sub>]. Adjust the beat volume by selecting the + (increase) or - (decrease) buttons. The beat volume has 10 levels of adjustment.

### 8.4.4 Set Sweep Speed

Select the [Setup] key→[Sensor]→[SpO<sub>2</sub>] to set [Sweep Speed] to [12.5 mm/s] or [25 mm/s].

---

## 8.5 Measurement Limitations

If you doubt the measured SpO<sub>2</sub>, check patient vital signs first. Then check the patient ventilator and SpO<sub>2</sub> sensor. The following factors may influence the accuracy of measurement:

- Ambient light
- Physical movement (patient and imposed motion)
- Diagnostic testing
- Low perfusion
- Electromagnetic interference, such as MRI environment
- Electrosurgical units
- Dysfunctional haemoglobin, such as carboxyhemoglobin (COHb) and methemoglobin (MetHb)
- Presence of certain dyes, such as methylene and indigo carmine
- Inappropriate positioning of the SpO<sub>2</sub> sensor, or use of incorrect SpO<sub>2</sub> sensor
- Drop of arterial blood flow to immeasurable level caused by shock, anemia, low temperature or vasoconstrictor.

# 9 Special Functions

---

---

## 9.1 Manual Breath

Select the [Tools] key→[Functions]→[Manual Breath], and the ventilator system delivers a breath to the patient based on the current ventilation mode.

### NOTE

---

- Pressing the [Manual Breath] key during inspiratory phase cannot initiate a manual breath.
  - Manual breath function is disabled in CPAP mode and is supported when apnea ventilation occurs.
  - Manual breath is disabled in Standby status.
- 

## 9.2 Expiration Hold

Expiration Hold means to extend the patient's time of expiratory phase manually and to prevent the patient from inspiration for a certain period of time.

Select the [Tools] key→[Functions]→[Exp. Hold]. Push and hold the [Exp. Hold] key. The ventilator starts the Expiration Hold function and the screen shows [Exp. Hold Active]. Release the [Exp. Hold] key. The ventilator terminates the Expiration Hold function. Expiration Hold is active for a maximum of 30 seconds. If the [Exp. Hold] key is pushed and held for more than 30 seconds or is released, the ventilator terminates the Expiration Hold function automatically.

During Expiration Hold, the ventilator calculates PEEP<sub>i</sub> automatically and displays the calculation results in the prompt message box.

### NOTE

---

- There is at least one inspiratory phase between two expiration holds.
  - The system responds to Exp. Hold key pressing operation only in non-standby status.
  - Expiration Hold function is disabled in CPAP mode and is supported when apnea ventilation occurs.
-

---

## 9.3 Inspiration Hold

Inspiration Hold means to extend the patient's time of inspiratory phase manually and to prevent the patient from expiration for a certain period of time.

Select the [Tools] key→[Functions]→[Insp. Hold]. Push and hold the [Insp. Hold] key. The ventilator starts the Inspiration Hold function and the screen shows [Insp. Hold Active]. Release the [Insp. Hold] key. The ventilator terminates the Inspiration Hold function. Inspiration Hold is active for a maximum of 30 seconds. If the [Insp. Hold] key is pushed and held for more than 30 seconds, the ventilator terminates the Inspiration Hold function automatically.

During Inspiration Hold, the ventilator calculates Cstat and Pplat automatically and displays the calculation results in the prompt message box.

### NOTE

---

- **There is at least one expiratory phase between two inspiration holds.**
  - **The system responds to Insp. Hold key pressing operation only in non-standby status.**
  - **Inspiration Hold function is disabled in CPAP mode and is supported when apnea ventilation occurs.**
- 

## 9.4 Nebulizer

During nebulization, aerosolized medicament is inhaled by the patient for the purpose of therapy.

Press the [Nebulizer] key and set the appropriate [Nebulizer Time] in the accessed menu. Select [Ok] to start nebulization. When nebulization starts, nebulization remaining time is displayed in the system prompt message field.

When the set nebulization time is up or the [Nebulizer] key is pressed again, the ventilator terminates nebulization.

### NOTE

---

- **CO<sub>2</sub> cannot be measured in the aerosolized medicament environment. CO<sub>2</sub> module sampling and monitoring are disabled when the nebulizer is started.**
  - **Nebulizer is disabled in Standby status.**
-

---

## NOTE

---

- **Nebulization is disabled in V-A/C, V-SIMV, PRVC-SIMV, AMV and PRVC modes when patient type is pediatric.**
  - **When O<sub>2</sub> supply type is low-pressure, pressing the [Nebulizer] key will not activate nebulizer, rather display the prompt message [Fail to Start with Low Pressure O<sub>2</sub> Supply].**
  - **Aerosolized medication may occlude the expiration valve and flow sensor. Please have them checked and cleaned after nebulization.**
  - **Nebulization may cause fluctuation in the patient's FiO<sub>2</sub>.**
  - **The ventilator switches off the nebulizer flow when the inspiratory flow is less than 15 L/min.**
- 

## 9.5 O<sub>2</sub> ↑ (O<sub>2</sub> enrichment)

O<sub>2</sub> ↑ is also called as O<sub>2</sub> enrichment. It means to deliver oxygen with concentration higher than normal level within the specified time period. In the adult patient group, the O<sub>2</sub> enrichment function delivers 100 % oxygen. In the pediatric patient group, the O<sub>2</sub> enrichment function delivers 1.25 times of the current oxygen concentration or 100 %, whichever is less.

Press the [O<sub>2</sub> ↑ Suction] key and the ventilator starts oxygen enrichment. The indicator light for [O<sub>2</sub> ↑ Suction] key is illuminated and the remaining oxygen enrichment time is displayed in the prompt message field. Oxygen enrichment is active for maximum two minutes. During oxygen enrichment, the currently set oxygen concentration is displayed in the [O<sub>2</sub> %] parameter setup quick key field.

When the 2-minute period of oxygen enrichment is up or the [O<sub>2</sub> ↑ Suction] key is pressed again, the ventilator terminates oxygen enrichment.

## NOTE

---

- **O<sub>2</sub> ↑ (oxygen enrichment) is disabled in Standby status.**
  - **When O<sub>2</sub> supply type is low-pressure, pressing the [O<sub>2</sub> ↑ Suction] key will not activate oxygen enrichment, rather display the prompt message [Fail to Start with Low Pressure O<sub>2</sub> Supply].**
  - **Removing the patient tubing during oxygen enrichment will start suction function. Refer to section 9.6 Suction.**
-

---

## 9.6 Suction

The ventilator provides a suction procedure to help the ICU staff to complete the suction maneuver. The ventilator detects the procedure of disconnecting or reconnecting the patient tubing. The ventilator starts oxygen enrichment before and after the suction, and disables the otherwise relevant alarm messages during the suction.

1. Press the [**O<sub>2</sub> ↑ Suction**] key. The system delivers oxygen enrichment to the patient and monitors within the 120-second period of oxygen enrichment if the patient tubing are disconnected. Disconnect the patient tubing in this period.
2. After disconnecting the patient tubing, the system prompts [**The Patient is Disconnected! Reconnect Patient after Suction Completed!**] and stops ventilating the patient. In this case, you can apply manual suction to the patient.
3. Reconnect the patient tubing after the suction. When patient connection is detected, the system delivers oxygen enrichment to the patient.

During the oxygen enrichment periods, pressing the [**O<sub>2</sub> ↑ Suction**] key can terminate the procedure.

### NOTE

- 
- **P0.1, PEEPi, and NIF are disabled after suction is activated.**
- 

## 9.7 P0.1

P0.1 is the occlusion pressure drop within the first 100 ms after a patient starts spontaneous breathing.

1. Select the [**Tools**] key→[**Diagnostics**]→[**P0.1**].
2. Select [**P0.1**] to access the P0.1 measurement window.
3. Select [**Start**]. The system starts P0.1 measurement and prompts [**Measurement Active**].
4. After the measurement is completed, the measurement result is displayed. The ventilator can display the three most recent measurement results.
5. After the measurement is completed, Waveforms and Spirometry screen is frozen automatically.

### NOTE

- 
- **Suction, PEEPi, and NIF are disabled after P0.1 is activated.**
  - **During P0.1 measurement, pressing the [Freeze] key does not produce freezing operation.**
  - **If no operation is performed on P0.1 measurement window within three minutes, the measurement window exits automatically.**
-



---

## 9.8 NIF

NIF is the maximum negative pressure generated by the patient's spontaneous breathing within a period of time.

1. Select the [**Tools**] key→[**Diagnostics**]→[**NIF**].
2. Select [**NIF**] to access the NIF measurement window.
3. Press and hold the [**Exp. Hold**] key on the screen and the system starts NIF measurement.
4. Release the [**Exp. Hold**] key. The measurement is completed. The measurement result is displayed. The ventilator can display the three most recent measurement results.

### NOTE

- 
- **If no operation is performed on NIF measurement window within three minutes, the measurement window exits automatically.**
- 

## 9.9 PEEPi

The PEEPi measurement function supports measurement of two parameters: PEEPi and Vtrap. PEEPi is the positive end-expiratory pressure produced by the trapped gas and Vtrap is the trapped gas volume.

1. Select the [**Tools**] key→[**Diagnostics**]→[**PEEPi**].
2. Select [**PEEPi**] to access the PEEPi measurement window.
3. Select [**Start**]. The system starts PEEPi measurement and prompts [**Measurement Active**].
4. After the measurement is completed, the measurement result is displayed. The ventilator can display the three most recent measurement results.
5. After the measurement is completed, waveforms and spirometry data are frozen automatically.

### NOTE

- 
- **During PEEPi measurement, pressing the [Freeze] key does not produce freezing operation.**
  - **Manual Breath, Inspiration Hold, and Expiration Hold are disabled during PEEPi measurement.**
  - **If no operation is performed on PEEPi measurement window within three minutes, the measurement window exits automatically.**
-

---

## 9.10 P-V Tool

Mechanical ventilation set with the optimal PEEP can improve oxygenation, improve alveolar mechanics and reduce injury to the lungs. By drawing static pressure-volume loop (static P-V loop), P-V tool is the method to determine the optimal PEEP based on the characteristic points on the static P-V loop. The doctor is able to determine the optimal PEEP for the patient with the help of this function.

### NOTE

---

- **The P-V tool function is disabled in the following cases: patient type is Ped ; in CPAP/PSV ; in NIV or apnea ventilation mode ; during O<sub>2</sub> ↑ (oxygen enrichment) ; during P0.1 measurement ; during nebulization or suction ; within one minute after nebulization or suction ; within one minute after last P-V loop measurement.**
  - **The P-V tool function is not recommended when there is great leakage or when the patient has spontaneous breathing. The relevant characteristic points, that the P-V tool function provides are only for your reference.**
  - **If no operation is performed on P-V tool window within three minutes, the measurement window exits automatically.**
- 

1. Select the [**Tools**] key→[**P-V Tools**].
2. Select [**P-V Tools**] to access the P-V tools window.
3. Read notes related to P-V tool on the Info screen.
4. Select [**Procedure**], and set parameters of Pstart, Flow, Pmax, and Vlimit on the Procedure screen. The system acquires Tmax parameter value based on the calculation formula and displays it on the procedure screen.
  - Flow: gas delivery and expiration flows of the static P-V loop.
  - Pstart: starting pressure of the static P-V loop.
  - Pmax: maximum pressure which the static P-V loop can reach.
  - Vlimit: maximum volume which the static P-V loop can reach.
  - Tmax: maximum measurement time required for completing static P-V loop measurement.
5. Select [**Start**] and the system starts P-V tool measurement. If you select [**Stop Insp**] during measurement, the system stops measurement test in the inspiratory limb immediately and starts measurement in the expiratory limb. If you select [**Abort**] during measurement, the system aborts measurement immediately.

- 
6. After the measurement is completed, the system enters Analysis screen. You can set the desired positions of [Cursor 1] and [Cursor 2]. When you select [Cursor 1] or [Cursor 2], the selected cursor turns green. You can move the position of the cursor via the control knob to determine the characteristic points. The system also displays the volume value and pressure value in the inspiratory limb and expiratory limb corresponding to the cursor position and displays the compliance of these limbs.
  7. Select [History] to select the desired loop in the accessed list. The system only displays the history loop you are viewing.
  8. Select [Ref. Loop] to select the desired loop in the accessed list. The system displays the reference loop you are viewing and the current loop as well.

## 9.11 Automatic Tube Resistance Compensation

### (ATRC)

ATRC stands for the function of automatic tube resistance compensation. By selecting appropriate endotracheal (ET) tube or tracheostomy (Trach) tube of different diameters for the user, the ventilator can adjust gas delivery pressure automatically, so that the pressure at the end of the tube is consistent with the ventilator's pressure setting value as much as possible.

The ATRC function can be set on the parameter setup window of each mode.

1. Select the desired ventilation mode and select [ATRC] to enter the ATRC screen.
2. Set Tube Type, Tube I.D., Compensate, and Expiration on the accessed screen.
  - Tube Type : ET tube and Trach tube
  - Tube I.D. : diameter of ET tube.
  - Compensate : percentage of ATRC.
  - Expiration : enable or disable compensation during exhalation.
3. Select [Ok] and the system starts ATRC. After ATRC is enabled, if you enter the ATRC screen and then select [Disable ATRC], the system terminates ATRC in the course of ventilation immediately.

When ATRC is enabled, Ptrach waveform is displayed with the Paw waveform. This waveform is independent of [Draw Wave] setting. For details about [Draw Wave], refer to *5.1.1 Waveforms*.

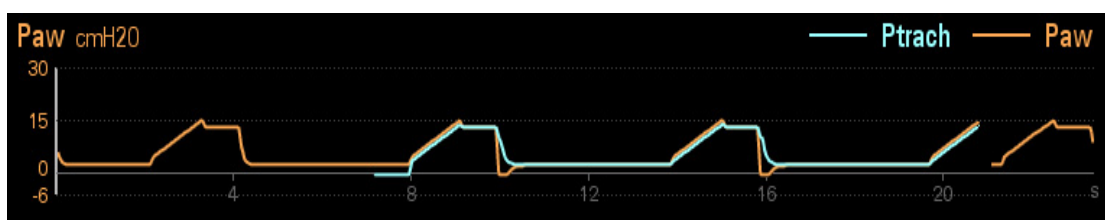

---

---

 **WARNING**

- **ATRC may induce autotriggering. If autotriggering occurs, first check the patient, breathing circuit, and other possible causes.**
- 

**NOTE**

- **Incorrect tube type or ID setting can endanger the patient. Make sure to set them properly.**
- 

## 9.12 IntelliCycle

IntelliCycle intelligent synchronous technology means that the user can set [Exp%] to [Auto] in CPAP/PSV, V-SIMV, P-SIMV, PRVC-SIMV, AMV and DuoLevel modes and ventilator will adjust [Exp%] dynamically by adaptive algorithm through extracting and analysing the waveform characteristics. This way, ventilator monitors and adapts [EXP%] according to patient condition and needs automatically, and ends inspiration with more synchrony.

## 9.13 O<sub>2</sub> Therapy

O<sub>2</sub> therapy is a method to increase O<sub>2</sub> concentration in the airway at normal pressure through simple tube connections. O<sub>2</sub> therapy is a medical measure which can increase O<sub>2</sub> concentration in the alveolar gas and facilitate O<sub>2</sub> diffusion so as to increase PaO<sub>2</sub> and SpO<sub>2</sub> saturation and relieve or correct hypoxia by increasing O<sub>2</sub> concentration in the inspired gas. O<sub>2</sub> therapy is a way for hypoxia prevention or treatment, providing O<sub>2</sub> concentration higher than that in the air.

---

 **WARNING**

- **During O<sub>2</sub> therapy, only the O<sub>2</sub> concentration FiO<sub>2</sub>, O<sub>2</sub> flow, SpO<sub>2</sub>, and pulse rate are monitored.**
  - **During O<sub>2</sub> therapy, all physiological alarms are shielded except O<sub>2</sub> concentration and SpO<sub>2</sub> module physiological alarms.**
  - **Airway pressure and expiration-dependent ventilation parameters, such as flow, minute volume, or apnea, are not monitored.**
  - **Use SpO<sub>2</sub> monitoring for patients who are dependent only on an increased defined O<sub>2</sub> concentration. Otherwise, a deterioration in the patient's condition cannot be recognized.**
  - **Only use oxygen masks or nasal catheters for O<sub>2</sub> Therapy. Do not use masks for non-invasive ventilation (NIV). The patient may be at risk if unsuitable masks are used.**
-

---

---

**⚠ WARNING**

---

- O<sub>2</sub> therapy can only be used on patients with spontaneous breathing.
- 

### 9.13.1 Preparing for O<sub>2</sub> Therapy

---

**⚠ WARNING**

---

- Do not use antistatic or conductive patient tubing. The use of such materials increases the risk of an electric shock for the patient and the risk of fire breaking out in oxygen- enriched atmospheres.
- 

#### 9.13.1.1 Using O<sub>2</sub> Therapy Mask for O<sub>2</sub> Therapy

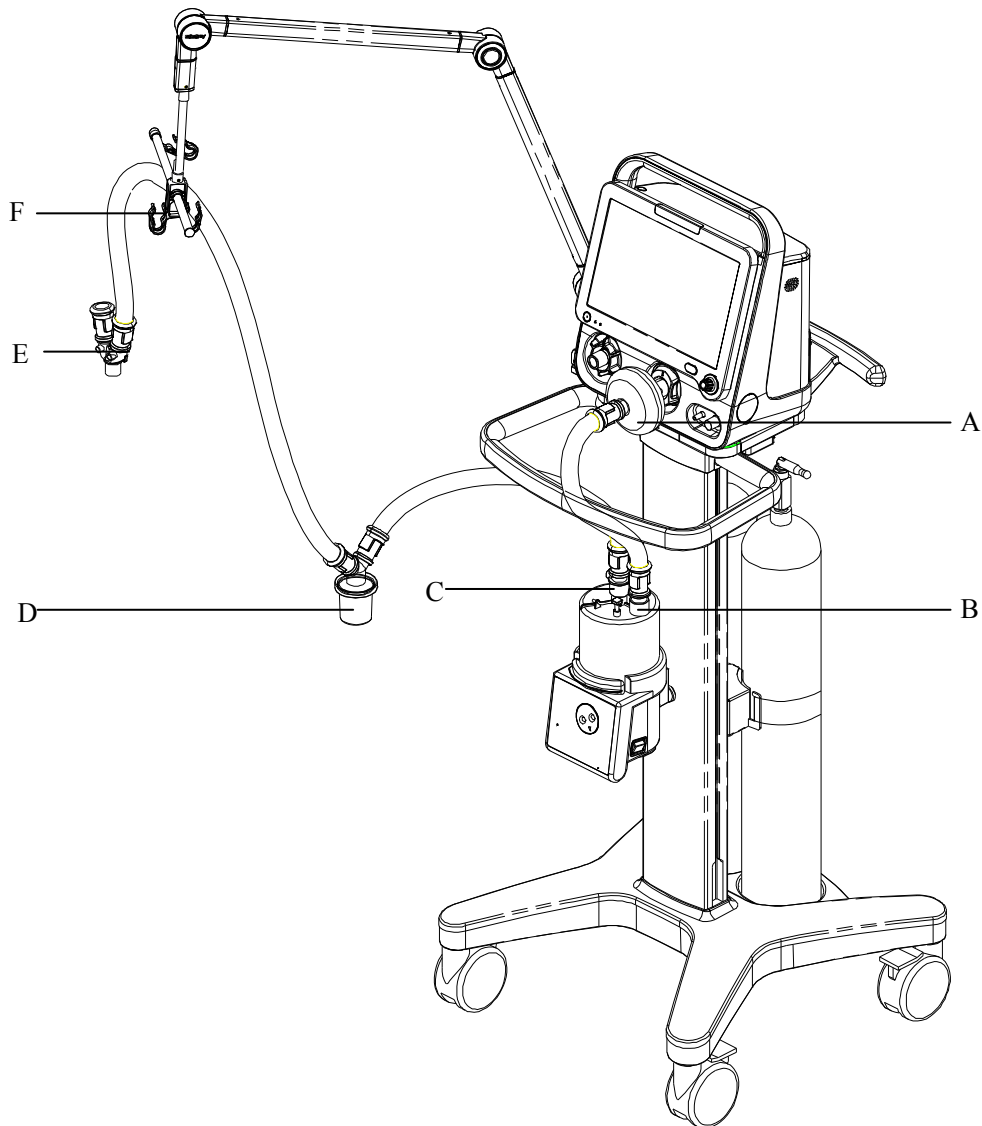

- A. Inspiratory filter
- B. Humidifier inlet
- C. Humidifier outlet
- D. Inspiratory water trap
- E. Y piece (connect with the O<sub>2</sub> therapy mask)
- F. Support arm hook

1. Mount the filter onto the inspiratory port.
2. Connect the inspiratory filter to the humidifier inlet via the tube.
3. Connect the humidifier outlet to the water trap via the tube. Then connect the water trap to the Y piece via the tube.
4. The expiratory port is not connected with a tube.
5. Place the tubes onto the support arm hook.

### 9.13.1.2 Using Nasal Cannula for O<sub>2</sub> Therapy

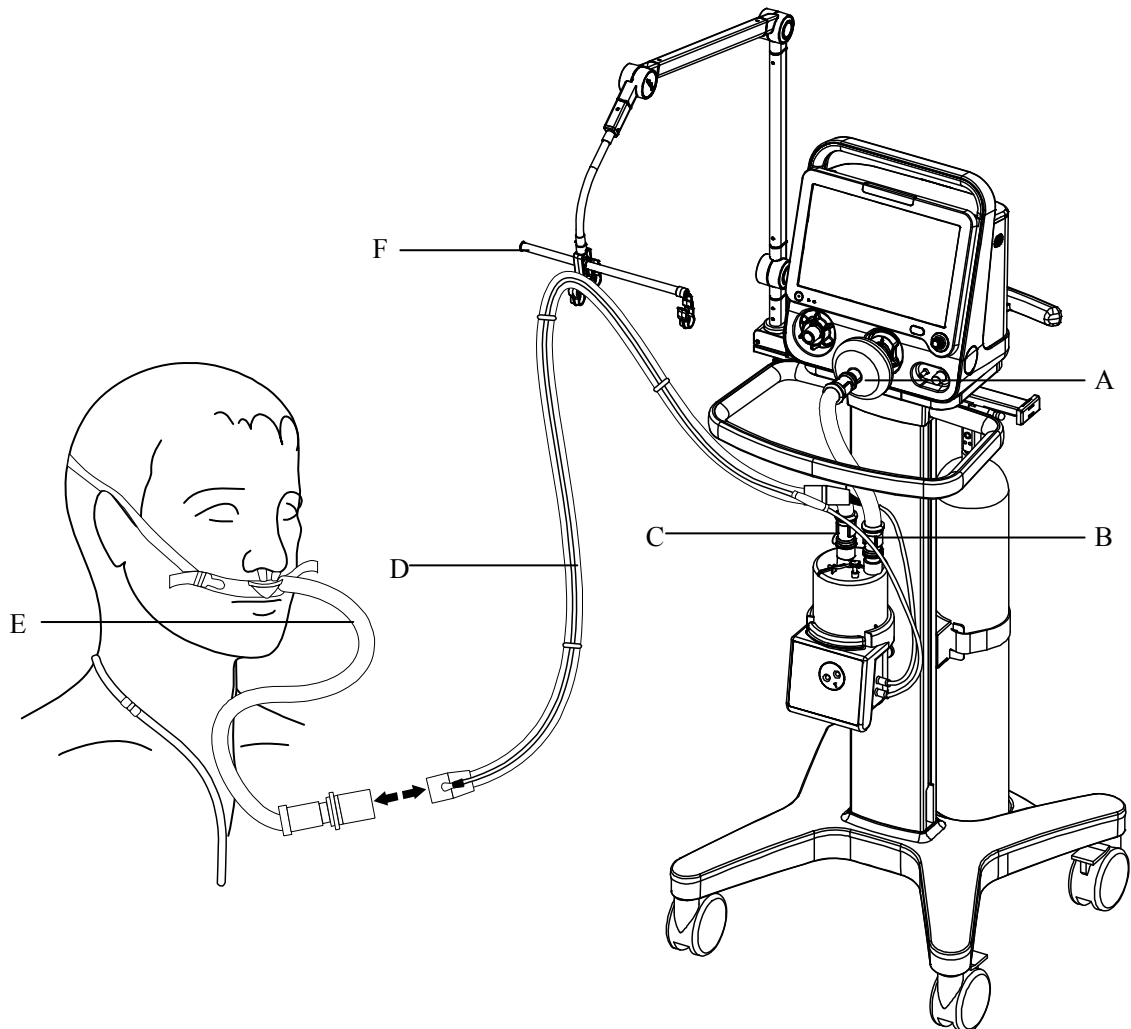

- A. Inspiratory filter
- B. Humidifier inlet
- C. Humidifier outlet
- D. Patient tubing with heating function
- E. Nasal cannula
- F. Support arm hook

1. Mount the filter onto the inspiratory port.
2. Connect the inspiratory filter to the humidifier inlet via the tube.
3. Connect the humidifier outlet to the nasal cannula via the tube with heating function.
4. The expiratory port is not connected with a tube.
5. Place the tubes onto the support arm hook.

### 9.13.2 Switching on O<sub>2</sub> Therapy

#### WARNING

- **The device must only be used under the supervision of qualified medical staff, so that help is immediately available if malfunctions occur or the patient has insufficient spontaneous breathing.**

1. Select the [**Standby**] key to enter Standby status after confirmation.
2. Select [**O<sub>2</sub> Therapy**] in the Standby status to enter O<sub>2</sub> therapy screen.
3. Set [**Flow**] and [**O<sub>2</sub>%**] to appropriate values as required.

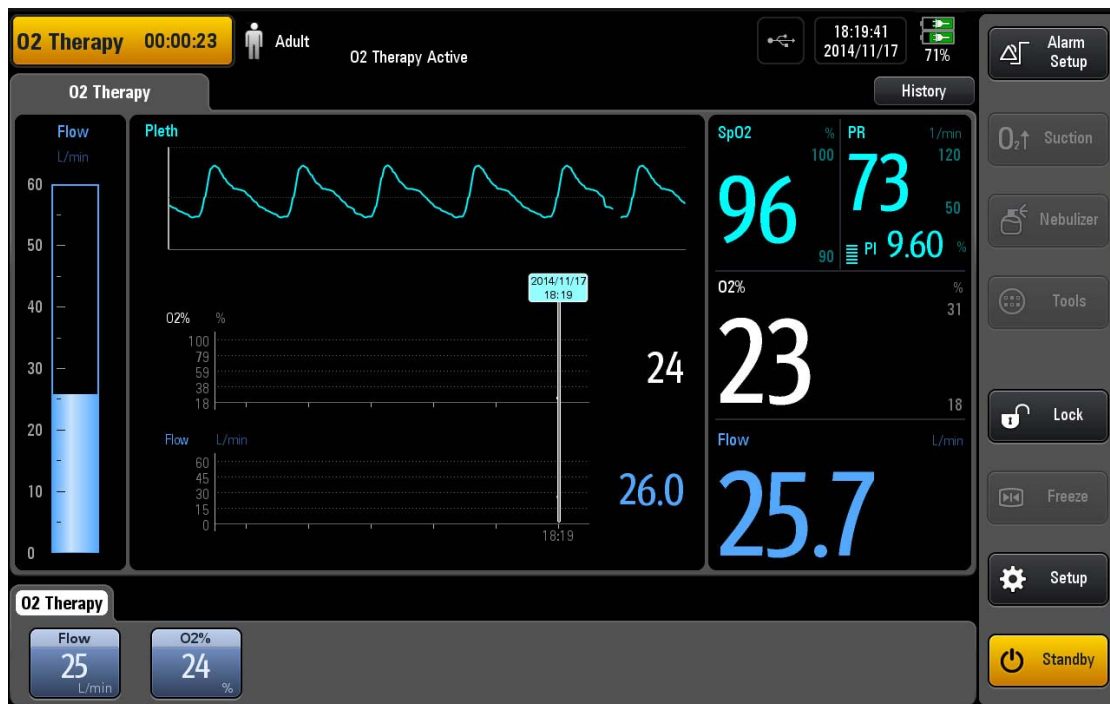

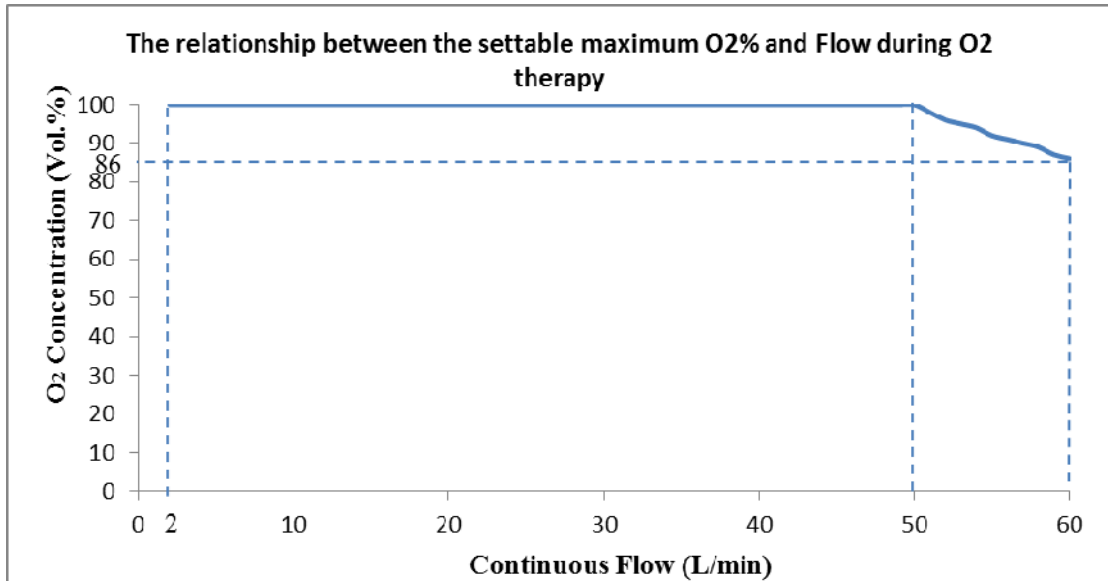

The relationship between the settable maximum O<sub>2</sub>% and Flow during the O<sub>2</sub> therapy

Continuous Flow (L/min)	O <sub>2</sub> concentration (Vol.%)
2-50	100
51	98
52	96
53	95
54	94
55	92
56	91
57	90
58	89
59	87
60	86



---

### 9.13.3 O<sub>2</sub> Therapy Timer

Select the O<sub>2</sub> Therapy Timer area in the top left corner to access the window as shown below.



Select [**Stop**]/[**Start**] to stop or start timing. Select [**Reset**] to reset the displayed time of the timer.

Enter the number of timing minutes in [**O<sub>2</sub> Therapy Time Setup**] to start the timer. When the set time is equal to the time of the timer, the system gives prompt sound and O<sub>2</sub> supply is not interrupted. The O<sub>2</sub> Therapy Timer area flashes until you perform the following operations:

- Stop the timer, or
- Adjust the set time, or
- Exit the O<sub>2</sub> Therapy

### 9.13.4 Switching off O<sub>2</sub> Therapy

During O<sub>2</sub> therapy, select the [**Standby**] key to enter Standby status after confirmation, so as to switch off the O<sub>2</sub> therapy function.

---

**FOR YOUR NOTES**

# 10 Alarms

---

---

## 10.1 Introduction

Alarms, triggered by a vital sign that appears abnormal or by technical problems of the ventilator, are indicated to the user by visual and audible alarm indications.

### NOTE

---

- **When the ventilator is started, the system detects whether audible alarm tones and alarm lamp function normally. If yes, the alarm lamp flashes red and yellow successively, and the speaker and the buzzer give check tones. If not, do not use the equipment and contact us immediately.**
  - **When multiple alarms of different priorities occur simultaneously, the ventilator selects the alarm of the highest priority and gives visual and audible alarm indications accordingly.**
  - **When multiple alarms of same levels occur simultaneously, the alarm messages are displayed in order of time of occurrence.**
  - **The ventilator restore the latest configuration if restarts within 60 seconds after the power failure. And it will restore the user configuration rather than the latest configuration if restarts 120 seconds later after the power failure. The ventilator may load either the latest configuration or the user configuration if restarts from 60-120 seconds after the power failure.**
  - **If the equipment power failure lasts for not more than 30 s, the alarm settings prior to the power failure are restored when the equipment is powered on again.**
- 
- 

### **WARNING**

---

- **A potential hazard can exist if different alarm presets are used for the same or similar equipment in any single area, e.g. an intensive care unit or cardiac operating room.**
-

---

## 10.2 Alarm Categories

By nature, the ventilator's alarms fall into three categories: physiological alarms, technical alarms and prompt messages.

### 1. Physiological alarms

Physiological alarms, also called patient status alarms, are triggered by a monitored parameter value that violates set alarm limits or an abnormal patient condition. Physiological alarm messages are displayed in the alarm message field.

### 2. Technical alarms

Technical alarms, also called system status alarms, are triggered by a device malfunction or a patient data distortion due to proper operation or mechanical problems. Technical alarm messages are displayed in the alarm message field.

### 3. Prompt messages

As a matter of fact, prompt messages are not alarm messages. Apart from the physiological and technical alarm messages, the ventilator will show some messages telling the system status. Messages of this kind are included into the prompt message category and are usually displayed in the prompt message field.

## 10.3 Alarm Priority Levels

By severity, the ventilator's alarms fall into three categories: high priority alarms, medium priority alarms and low priority alarms.

The priorities for all alarms are preset before the ventilator leaves the factory and are not user adjustable.

## 10.4 Alarm Signals

When an alarm occurs, the ventilator will indicate it to the user through visual or audible alarm signals.

- Alarm lamp.
- Audible alarm tones.
- Alarm message.
- Flashing numeric.

---

## 10.4.1 Alarm Lamp

If a technical alarm or physiological alarm occurs, the alarm lamp will flash. The flashing color and frequency match the alarm priority as follows:

- High priority alarms: the lamp quickly flashes red.
- Medium priority alarms: the lamp slowly flashes yellow.
- Low priority alarms: the lamp turns yellow without flashing.

## 10.4.2 Audible Alarm Tones

The ventilator uses different alarm tone patterns to match the alarm priority:

- High priority alarms: broadcasts the high priority alarm tone.
- Medium priority alarms: broadcasts the medium priority alarm tone.
- Low priority alarms: broadcasts the low priority alarm tone.

A-weighted sound pressure level of audible alarm signals:

- Position of the operator: 1-meter in front of and 1.5-meter above the ventilator.
- A-weighted sound pressure level: not less than 45dB and not greater than 85 dB. The high priority alarm volume is not less than 60dB at the default alarm volume level.

## 10.4.3 Alarm Message

When an alarm occurs, an alarm message will appear in the ventilator's alarm message filed.

The alarm message uses a different background color to match the alarm priority:

- High priority alarms: red
- Medium priority alarms: yellow
- Low priority alarms: yellow

The exclamatory marks (!) before the alarm message match the alarm priority as follows:

- High priority alarms: ! ! !
- Medium priority alarms: ! !
- Low priority alarms: !





## 10.4.4 Flashing Alarm Numeric

If an alarm triggered by an alarm limit violation occurs, the numeric of the measured parameter in alarm will flash at a specified frequency.

---

## 10.4.5 Alarm Status Symbol

Apart from the aforementioned alarm indicators, the ventilator still uses the following symbols telling the alarm status:

- : indicates that the alarm system is in AUDIO PAUSED state.
- : indicates multiple alarm messages when this icon is displayed before alarm messages to show the number of alarms. The alarm message uses a different background color to match the alarm priority. Red background means that the highest priority of the multiple alarm messages is high while yellow background means that the highest priority of the multiple alarm messages is medium. You can view active alarms by selecting the alarm message field.
- : indicates all active alarms are cleared and there are no currently active alarms. By pushing this icon, you can view the most recent inactive alarms in the accessed window (up to 9 alarm messages are displayed). You can also clear inactive alarms with the [Reset] button.
- : indicates that the alarm signal is in the ALARM OFF state.

## 10.5 Set Alarm Volume

Select [Alarm Setup] and then select [Audio]. Adjust the alarm audio by selecting the + (increase) or - (decrease) buttons. The alarm audio has 10 levels of adjustment. If there are no currently active alarms, you can also select [Test]. The system will broadcast low priority alarm tone once based on the selected alarm volume.

---

### **WARNING**

---

- **Do not rely exclusively on the audible alarm system when using the ventilator. Adjustment of alarm volume to a low level may result in a hazard to the patient. Always keep the patient under close surveillance.**
-

---

## 10.6 Set Alarm Limits

---

### CAUTION

---

- In case that high pressure alarm limit of 60 cmH<sub>2</sub>O is not required under clinical condition, setting high pressure alarm limit to 60 cmH<sub>2</sub>O or less is recommended so as to extend the service life of the turbine and the battery.
- 

### NOTE

---

- An alarm is triggered when the parameter value is higher than the high limit or lower than the low limit.
  - When using the ventilator, always keep an eye on whether the alarm limits of a specific parameter are set to the appropriate values.
- 

Select [**Alarm Setup**] and then select [**Limits 1**] or [**Limits 2**] to set the alarm limits for Paw, MV, ftot, TVe, Tapnea, EtCO<sub>2</sub>, or FiO<sub>2</sub> (when the ventilator is connected to low-pressure oxygen supply).

### 10.6.1 Auto Alarm Limits

Select [**Alarm Setup**]→[**Limits 1**]→[**Auto Alarm Limits**], the ventilator will update the parameter alarm limits based on the monitored value. The relationship is shown in the table below.

Alarm Limit	Adjust Formula
Paw High Limit	Average peak pressure+10cmH <sub>2</sub> O or 35cmH <sub>2</sub> O, whichever is greater
MV High Limit	1.5×MV monitored value
MV Low Limit	0.6×MV monitored value
TVe High Limit	1.5×TVe average value
TVe Low Limit	0.5×TVe average value
ftot High Limit	1.4×ftot monitored value
Tapnea	15 s

The value used for average uses the monitoring value of the last eight ventilation cycles or the monitoring value in one minute, whichever is smaller.

If the calculated alarm limit is more than the high threshold of setting range or less than the low threshold, the corresponding threshold is used as the auto alarm limit.

---

## 10.7 AUDIO PAUSED

### 10.7.1 Set AUDIO PAUSED

Push the  key to pause audio alarm of currently active alarms for 120 seconds.

---

#### WARNING

- Pay close attention to the patient and ventilator to ensure no alarm messages are ignored during the period of AUDIO PAUSED. Possible patient or equipment hazard may be produced if the alarm condition continues while no action is taken.

---

#### NOTE

- Under AUDIO PAUSED status, all the alarm indicators work normally except audible alarm tones.
- Under AUDIO PAUSED status, if a new technical or physiological alarm occurs, the AUDIO PAUSED status terminates automatically and audible alarm tones start again.
- When the 120 s countdown time is up, the AUDIO PAUSED status terminates and audible alarm tones start again.



---

### 10.7.2 Terminate AUDIO PAUSED

Under AUDIO PAUSED status, pushing the  key or triggering a new alarm will terminate the AUDIO PAUSED status and restore audible alarm tones. The AUDIO PAUSED icon and 120s countdown will disappear from the screen at the same time.

## 10.8 Recent Alarm

When there are currently active alarms, if the number is displayed before alarm messages, it indicates there are multiple all active alarm messages. By selecting the alarm message field, you can view active alarm messages, alarm occurrence time and alarm priority in the accessed most recent alarm window. Up to 9 alarm messages are displayed.

The icon  is displayed when all active alarms are cleared and there are no currently active alarms. By pushing the icon , you can view the most recent inactive alarms in the accessed window (up to 9 alarm messages are displayed). You can also clear the most recent inactive

alarms with the  button.



---

## 10.9 ALARM OFF

When TV high alarm limit, TV low alarm limit, or ftotal high alarm limit is set to [OFF], the

alarm off icon  will be displayed at the position of parameter alarm limits, and the physiological alarms of [TVe Too High], [TVe Too Low], or [ftotal Too High] will be switched off. Namely, the alarm message, alarm lamp, audible alarm tones, and flashing alarm numeric for this physiological alarm will be all switched off.

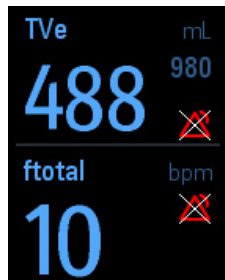

---

### WARNING

---

- Switching off alarms can endanger the patient. Handle with care.
- 

## 10.10 Alarm Tests

### 10.10.1 Battery in Use

1. Connect the ventilator to AC power and push the  hardkey to switch on.
2. Disconnect the AC power after the system starts up.
3. Verify that the [Battery in Use] alarm is activated and the ventilator is powered by batteries.
4. Reconnect the AC power.
5. Verify that the alarm resets and the ventilator is again powered by AC.

---

## 10.10.2 Loss of Power

1. Connect the ventilator to AC power and push the  $\odot/\circ$  hardkey to switch on.
2. After the system starts up, disconnect the external power supply when the battery is fully charged.
3. Connect a test lung to the ventilator and start normal ventilation.
4. The ventilation time is approximately 3 hours for the ventilator configured with one battery (approximately 6 hours for the ventilator configured with two batteries). The battery capacity is to be depleted. The [**System DOWN. Connect External Power Supply.**] alarm is activated.
5. Reconnect the external power supply.
6. Verify that the alarm resets and the ventilator is again powered by external power supply.

## 10.10.3 Paw Too High

1. After the ventilator system starts up normally, connect a test lung to the ventilator and start ventilation.
2. Set Paw high alarm limit to current Peak+5 cmH<sub>2</sub>O.
3. Squeeze the test lung hard during inspiration.
4. Verify that the [**Paw Too High**] alarm is activated, the ventilator cycles into expiration, and airway pressure falls to PEEP level.

## 10.10.4 TVe Too Low

1. After the ventilator system starts up normally, connect a test lung to the ventilator and start ventilation.
2. Set the TV low alarm limit to be greater than the current TVe. Verify that the [**TVe Too Low**] alarm is activated.

## 10.10.5 TVe Too High

1. After the ventilator system starts up normally, connect a test lung to the ventilator and start ventilation.
2. Set the TV high alarm limit to be less than the current TVe. Verify that the [**TVe Too High**] alarm is activated.

---

### 10.10.6 MV Too Low

1. After the ventilator system starts up normally, connect a test lung to the ventilator and start ventilation.
2. Set the MV low alarm limit to be greater than the current MV. Verify that the [**MV Too Low**] alarm is activated.

### 10.10.7 O<sub>2</sub> Supply Failure

1. Connect the ventilator to high-pressure O<sub>2</sub> supply.
2. Switch off the high-pressure O<sub>2</sub> supply. Verify that the [**O<sub>2</sub> Supply Failure**] alarm is activated.

### 10.10.8 PEEP Too Low

1. Remove the expiration valve membrane and install the expiration valve.

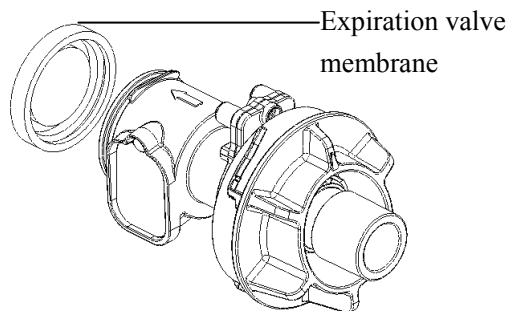

2. After the ventilator system starts up normally, connect a test lung to the ventilator and start ventilation.
3. Set PEEP to 5 cmH<sub>2</sub>O. Verify that the [**PEEP Too Low**] alarm is activated.

### 10.10.9 Airway Obstructed

1. After the ventilator system starts up normally, connect a test lung to the ventilator and set the ventilator to pressure mode to start ventilation.
2. Disconnect the Y-piece tube from the test lung and plug the Y-piece tube with the leak test plug.
3. Verify that the [**Airway Obstructed?**] alarm is activated after several breathing cycles.
4. Connect Y piece tube with the test lung and verify this alarm is reset automatically.

---

### 10.10.10 FiO<sub>2</sub> Too High

1. Connect the ventilator to low-pressure O<sub>2</sub> supply. Set the O<sub>2</sub> supply type to LPO.
2. Connect a test lung to the ventilator and start ventilation.
3. Set the FiO<sub>2</sub> high alarm limit to be less than the current O<sub>2</sub> concentration monitored value after ventilation is stable.
4. Verify that the **[FiO<sub>2</sub> Too High]** alarm is activated.

### 10.10.11 FiO<sub>2</sub> Too Low

1. Connect the ventilator to high-pressure O<sub>2</sub> supply. Set the O<sub>2</sub> supply type to HPO.
2. Connect a test lung to the ventilator and start ventilation.
3. Switch off the high-pressure O<sub>2</sub> supply after ventilation is stable.
4. Verify that the **[FiO<sub>2</sub> Too Low]** alarm is activated.

### 10.10.12 EtCO<sub>2</sub> Too High

1. Connect a test lung to the ventilator and start ventilation.
2. Connect the CO<sub>2</sub> test module. Select the **[Setup]** key → **[Sensor]** → **[CO<sub>2</sub>]** to set **[Monitoring]** to **[ON]**.
3. After CO<sub>2</sub> warm-up is completed and the CO<sub>2</sub> module enters operating mode, deliver 3 % to 7 % of CO<sub>2</sub> standard gas to the sampling port of sidestream CO<sub>2</sub> module or the airway adapter of mainstream CO<sub>2</sub> module. Set the EtCO<sub>2</sub> high alarm limit to be less than the standard gas concentration.
4. Verify that the **[EtCO<sub>2</sub> Too High]** alarm is activated.

### 10.10.13 EtCO<sub>2</sub> Too Low

1. Connect a test lung to the ventilator and start ventilation.
2. Connect the CO<sub>2</sub> test module. Select the **[Setup]** key → **[Sensor]** → **[CO<sub>2</sub>]** to set **[Monitoring]** to **[ON]**.
3. After CO<sub>2</sub> warm-up is completed and the CO<sub>2</sub> module enters operating mode, deliver 3 % to 7 % of CO<sub>2</sub> standard gas to the sampling port of sidestream CO<sub>2</sub> module or the airway adapter of mainstream CO<sub>2</sub> module. Set the EtCO<sub>2</sub> low alarm limit to be greater than the standard gas concentration.
4. Verify that the **[EtCO<sub>2</sub> Too Low]** alarm is activated.

---

### 10.10.14 SpO<sub>2</sub> Too High

1. Connect a test lung to the ventilator and start ventilation.
2. Connect the SpO<sub>2</sub> sensor and activate the SpO<sub>2</sub> monitoring function.
3. Connect the SpO<sub>2</sub> sensor to the index finger, set the SpO<sub>2</sub> Desat alarm limit as 0%, set the SpO<sub>2</sub> low alarm limit as 0% and the SpO<sub>2</sub> high alarm limit 2%.
4. Verify that the [**SpO<sub>2</sub> Too High**] alarm is activated.

### 10.10.15 SpO<sub>2</sub> Too Low

1. Connect a test lung to the ventilator and start ventilation.
2. Connect the SpO<sub>2</sub> sensor and activate the SpO<sub>2</sub> monitoring function.
3. Connect the SpO<sub>2</sub> sensor to the index finger, set the SpO<sub>2</sub> high alarm limit as 100% and the SpO<sub>2</sub> low alarm limit 98%.
4. Grasp the wrist with another hand to press the pulse until the SpO<sub>2</sub> reading is below 98 %, and verify that the [**SpO<sub>2</sub> Too Low**] alarm is activated.

### 10.10.16 SpO<sub>2</sub> Desat

1. Connect a test lung to the ventilator and start ventilation.
2. Connect the SpO<sub>2</sub> sensor and activate the SpO<sub>2</sub> monitoring function.
3. Connect the SpO<sub>2</sub> sensor to the index finger and set the SpO<sub>2</sub> high alarm limit as 100%, the SpO<sub>2</sub> low alarm limit 98%, and the SpO<sub>2</sub> Desat 98%.
4. Grasp the wrist with another hand to press the pulse until the SpO<sub>2</sub> reading is below 98 %, and verify that the [**SpO<sub>2</sub> Too Low**] alarm is activated.

### 10.10.17 PR Too High

1. Connect a test lung to the ventilator and start ventilation.
2. Connect the SpO<sub>2</sub> sensor and activate the SpO<sub>2</sub> monitoring function.
3. Connect the SpO<sub>2</sub> sensor to the index finger and set the PR high alarm limit as 15 l/min.
4. Verify that the [**PR Too High**] alarm is activated.

---

## 10.10.18 PR Too LOW

1. Connect a test lung to the ventilator and start ventilation.
2. Connect the SpO<sub>2</sub> sensor and activate the SpO<sub>2</sub> monitoring function.
3. Connect the SpO<sub>2</sub> sensor to the index finger, and set the PR high alarm limit as 300 1/min and the PR low alarm limit 298 1/min.
4. Verify that the [**PR Too Low**] alarm is activated.

## 10.11 Nurse Call

The ventilator provides nurse call function that enables the ventilator to output nurse call signals to the nurse call system when an alarm meeting the user set requirements occurs.

The nurse call function is activated only when:

1. The nurse call function is switched on;
2. An alarm which meets the user set requirements occurs;
3. The ventilator is not in AUDIO PAUSED status.

Follow these steps to set nurse call:

1. Push the [**Setup**] key. Select [**Maintain**] and select [**User**]. Enter the required password. Then select [**Interface Setting**] and select [**Nurse Call**].
2. Select [**Switch**] and toggle between [**ON**] and [**OFF**].
  - ◆ [**ON**]: to switch on the nurse call function.
  - ◆ [**OFF**]: to switch off the nurse call function.
3. Select [**Signal Type**] and toggle between [**Pulse**] and [**Continuous**].
  - ◆ [**Pulse**]: indicates that the nurse call signals outputted are pulse signals lasting for one second. When multiple alarms occur simultaneously, only one pulse signal is outputted. If a new alarm occurs when the ongoing alarm is not cleared yet, a new pulse signal will be outputted.
  - ◆ [**Continuous**]: indicates that the nurse call signal lasts until the alarm ends, i.e. the duration of a nurse call signal equals to that of the alarm.
4. Select [**Contact Type**] and toggle between [**Normally Open**] and [**Normally Closed**].
  - ◆ [**Normally Open**]: for systems that require normally open signal.
  - ◆ [**Normally Closed**]: for systems that require normally closed signal.
5. Select [**Alarm Level**] and select levels of alarm that will trigger nurse call signal.
6. Select [**Alarm Type**] and select types of alarm that will trigger nurse call signal.

If no setting is made for [**Alarm Level**] or [**Alarm Type**], nurse call signals will not be triggered no matter what alarm occurs.

---

---

 **WARNING**

- **Do not rely exclusively on the nurse call system for alarm notification. Remember that the most reliable alarm notification combines audible and visual alarm indications with the patient's clinical condition.**
  - **Use the specified nurse call cable when connecting with the hospital's nurse call system through the nurse call connection port. Failure to do so may burn the machine and produce electric shock hazard.**
  - **Inspect the ventilator alarm signals periodically when using the nurse call function.**
- 

## 10.12 When an Alarm Occurs

When an alarm occurs, do as follows:

1. Check the patient's condition.
2. Determine the alarming parameter or alarm category.
3. Identify the alarm source.
4. Take proper actions to eliminate the alarm condition.
5. Make sure the alarm condition is corrected.

For details about how to troubleshoot alarms, refer to *D Alarm Messages*.

---

---

---

 **WARNING**

- **To prevent possible patient injury when alarms are active, ensure that the patient receives adequate ventilation. Identify and remove the cause of the alarms. Readjust the alarm limits only when they are inappropriately set for the current conditions.**
- 

---

---

 **CAUTION**

- **Contact the Customer Service Department if the alarm persists without obvious cause.**
-

---

**FOR YOUR NOTES**



# 11 Cleaning and Disinfection

---

---

## **WARNING**

---

- Obey applicable safety precautions.
  - Read the material safety data sheet for each cleaning agent.
  - Read the operation and service instructions for all disinfection equipment.
  - Wear gloves and safety glasses. A damaged O<sub>2</sub> sensor can leak and cause burns (contains potassium hydroxide).
  - Reuse of undisinfected reusable accessories or components may cause cross-contamination.
  - To prevent leaks, avoid damaging any component in case of disassembling and reassembling the breathing system. Ensure the correct installation of the system. Make sure of the applicability and correctness of the cleaning and disinfection methods.
  - Disassemble and reassemble the breathing system as described in this manual. If you need further disassembly and reassembly, contact us. Improper disassembling and reassembling may cause breathing system to leak and compromise normal system use.
  - Seeping liquid into the control assembly can damage the equipment or cause personal injury. When cleaning the housing, ensure that no liquid flows into the control assemblies and always disconnect the equipment from the AC mains. Reconnect the AC mains after the cleaned parts are fully dry.
  - To avoid sticky residuals, do not use talc, zinc stearate, calcium carbonate, corn starch, or equivalent materials. These materials can go into the patient's lungs and airways and cause irritation or injury.
- 
- 

## **CAUTION**

---

- To prevent patient exposure to disinfection agents and to prevent premature deterioration of parts, use the cleaning and disinfection methods and agents recommended in this section.
  - To reduce the risk of electrical shock, disconnect electrical power from the ventilator before cleaning and disinfection.
- 
-

---

## NOTE

---

- **Clean and disinfect the equipment as required before it is put into use for the first time. Refer to this chapter for the cleaning and disinfection methods.**
  - **To help prevent damage, refer to the manufacturer's data if you have questions about a cleaning agent.**
  - **Do not use organic, halogenated, or petroleum based solvents, anesthetic agents, glass cleaners, acetone, or other harsh cleaning agents.**
  - **Do not use abrasive cleaning agents (such as steel wool, silver polish, or cleaner).**
  - **Keep all liquids away from electronic parts.**
  - **Do not permit liquid to go into the equipment housings.**
  - **Cleaning solutions must have a pH of 7.0 to 10.5.**
  - **After cleaning and disinfection is completed, run System Check before using the equipment. Use the equipment only when System Check is passed.**
  - **The expiration valve assembly, inspiration safety valve assembly, and patient hose of the gas pathways through the ventilator can become contaminated with body fluids and expired gases during both NORMAL CONDITION and SINGLE FAULT CONDITION.**
- 

## 11.1 Methods for Cleaning and Disinfection

Different parts of the ventilator can be disinfected by different methods. You need to select the appropriate method to clean and disinfect the parts based on the actual situations to avoid cross-contamination between the ventilator user and the patient.

This table is our recommended cleaning and disinfection methods for the ventilator parts, including use for the first time and use after many times.

Parts	Recommended frequency	Cleaning		Disinfection			
		①	②	A	B	C	D
<b>Ventilator Housing</b>							
Ventilator external surface (including housing, power cord, supply gas hose)	Each patient	①		A or D			
Trolley and support arm	Each patient	①		A or D			
Touch screen	Each patient	①		A or D			
Fan dust filter	Every four weeks/as necessary*	②		<b>B</b>			
Main unit air outlet dust filter	Every four weeks/as necessary*	②		<b>B</b>			
Air intake dust filter	Every four weeks/as necessary*	②		<b>B</b>			
<b>Ventilator inspiration safety valve assembly</b>							
Inspiration safety valve assembly	as necessary*		②	B or C			
<b>Ventilator expiration valve assembly</b>							
Expiration valve membrane (silicone)	Each patient/weekly		②	B or C			
Expiration valve assembly (except membrane)	Each patient/weekly		②	B or C			
<b>Ventilator patient tubing (reusable)</b>							
Patient tubing (including water trap, Y piece, adapter)	Each patient/weekly		②	B or C			
<b>Other</b>							
Mainstream CO <sub>2</sub> sensor	Each patient/weekly	Refer to the cleaning and disinfection methods provided by the mainstream CO <sub>2</sub> vendor.					
SpO <sub>2</sub> sensor	Each patient/weekly	Refer to the cleaning and disinfection methods provided by the attached package insert.					
SpO <sub>2</sub> sensor cable	Each patient/weekly	Refer to the cleaning and disinfection methods provided by the attached package insert.					
Nebulizer	Each patient/weekly	Refer to the cleaning and disinfection methods provided by the nebulizer vendor.					
Humidifier	Each patient/weekly	Refer to the cleaning and disinfection methods provided by the humidifier vendor.					

Parts	Recommended frequency	Cleaning		Disinfection			
		①	②	A	B	C	D
<b>Cleaning methods (Wipe and Bath Immersion) :</b>							
① Wipe: wipe with a damp cloth immersed in alkalescent detergent (soap water, etc.) or alcohol solution and then wipe off the remaining detergent with a dry lint free cloth.							
② Immersion: flush with water first and then immerse it in alkalescent detergent (soap water, etc.) (water temperature 40°C recommended) for approximately three minutes. Finally clean with water and dry completely.							
<b>Disinfection methods:</b>							
A: Wipe: wipe with a damp cloth immersed in medium- or high-efficiency detergent and then wipe off the remaining detergent with a dry lint free cloth.							
B: Immersion: immerse it in medium- or high-efficiency detergent for more than 30 minutes (recommended time). Then clean with water and dry completely.							
C: Steam autoclave at 134°C for 10 to 20 minutes (recommended time).							
D: Ultraviolet radiation for 30 to 60 minutes (recommended time).							

As necessary\*: shorten the cleaning and disinfection intervals if the equipment is used in dusty environment to ensure that the equipment surface is not covered by dust. Clean and disinfect the inspiration safety valve assembly only when the patient's exhaled gas may contaminate the inspiratory limb. For disassembling and installation methods, refer to **10.2.2**.

The table below lists the cleaning and disinfecting agents and autoclaving process that may be used on the ventilator.

Name	Type
Ethanol (75%)	Moderately efficient disinfectant
Isopropanol (70%)	Moderately efficient disinfectant
Glutaraldehyde (2%)	Highly efficient disinfectant
Ortho-Phthalaldehyde disinfectant (such as Cidex® OPA)	Highly efficient disinfectant
Soap water (pH value of 7.0~10.5)	Rinsing agent
Clean water	Rinsing agent
Steam autoclave*	Highly efficient disinfection

Steam autoclave\*: The recommended temperature of this disinfection method is 134°C (273°F).

---

## 11.2 Disassemble the Ventilator's Cleanable and Disinfectable Parts

### 11.2.1 Expiration Valve Assembly and Membrane

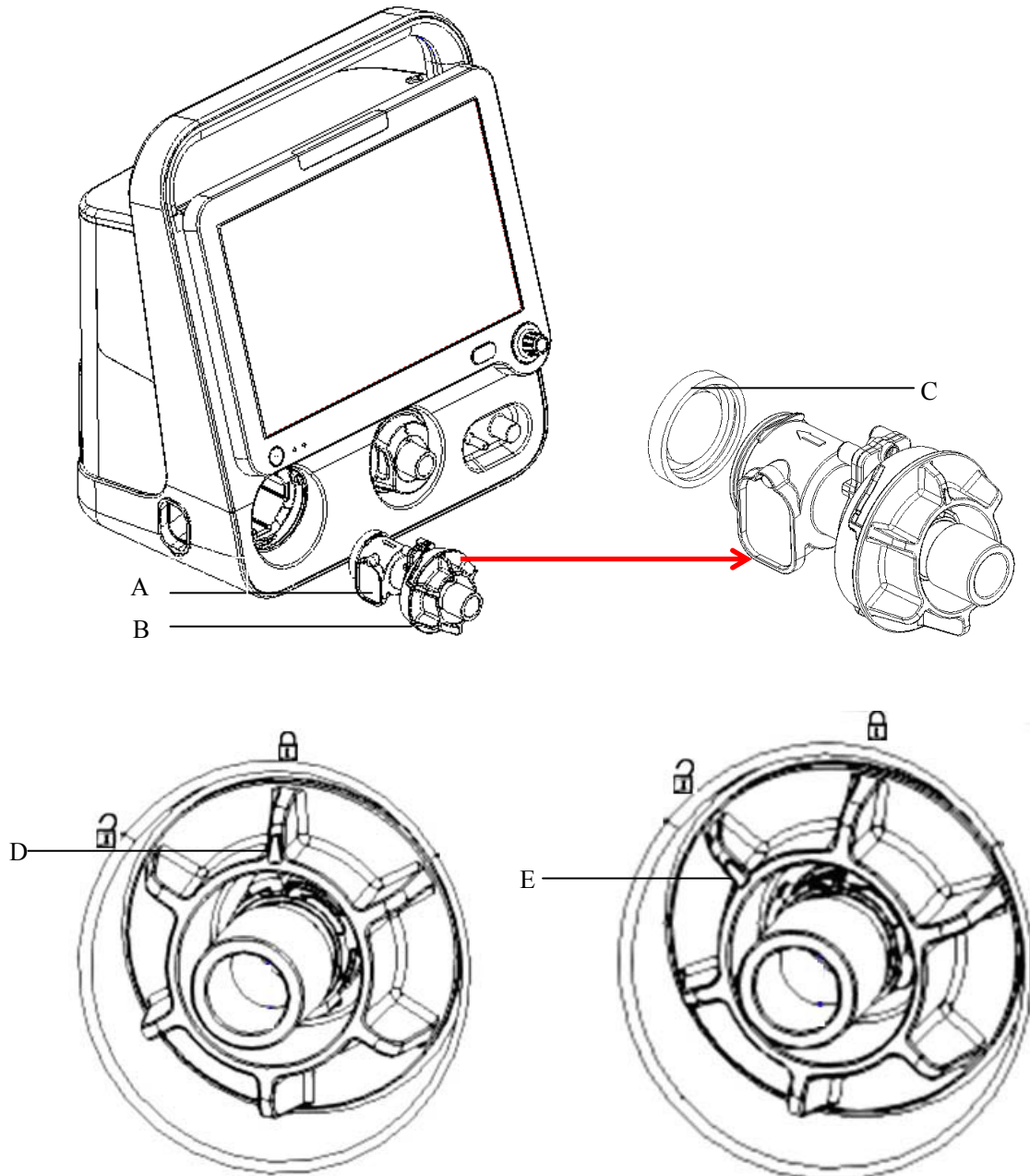

A. Expiration valve assembly

B. Expiration valve handwheel



C. Expiration valve membrane

D. Locked state of the expiration valve





E. Unlocked state of the expiration valve

---

■ To disassemble the expiration valve assembly:

1. Rotate the expiration valve handwheel counter-clockwise until the indicating arrow  on the handwheel aligns with the  position. Then pull out the expiration valve assembly horizontally.
2. Remove the expiration valve membrane.

■ To install the expiration valve assembly:

1. Install the expiration valve membrane onto the expiration valve assembly.
2. Ensure the indicating arrow  on the handwheel aligns with the  position. Push the expiration valve assembly into the corresponding connector on the ventilator horizontally to the end. Then rotate the expiration valve handwheel clockwise (and depress the handwheel in the direction the expiration valve is installed) until the indicating arrow  on the handwheel aligns with the  position.

---

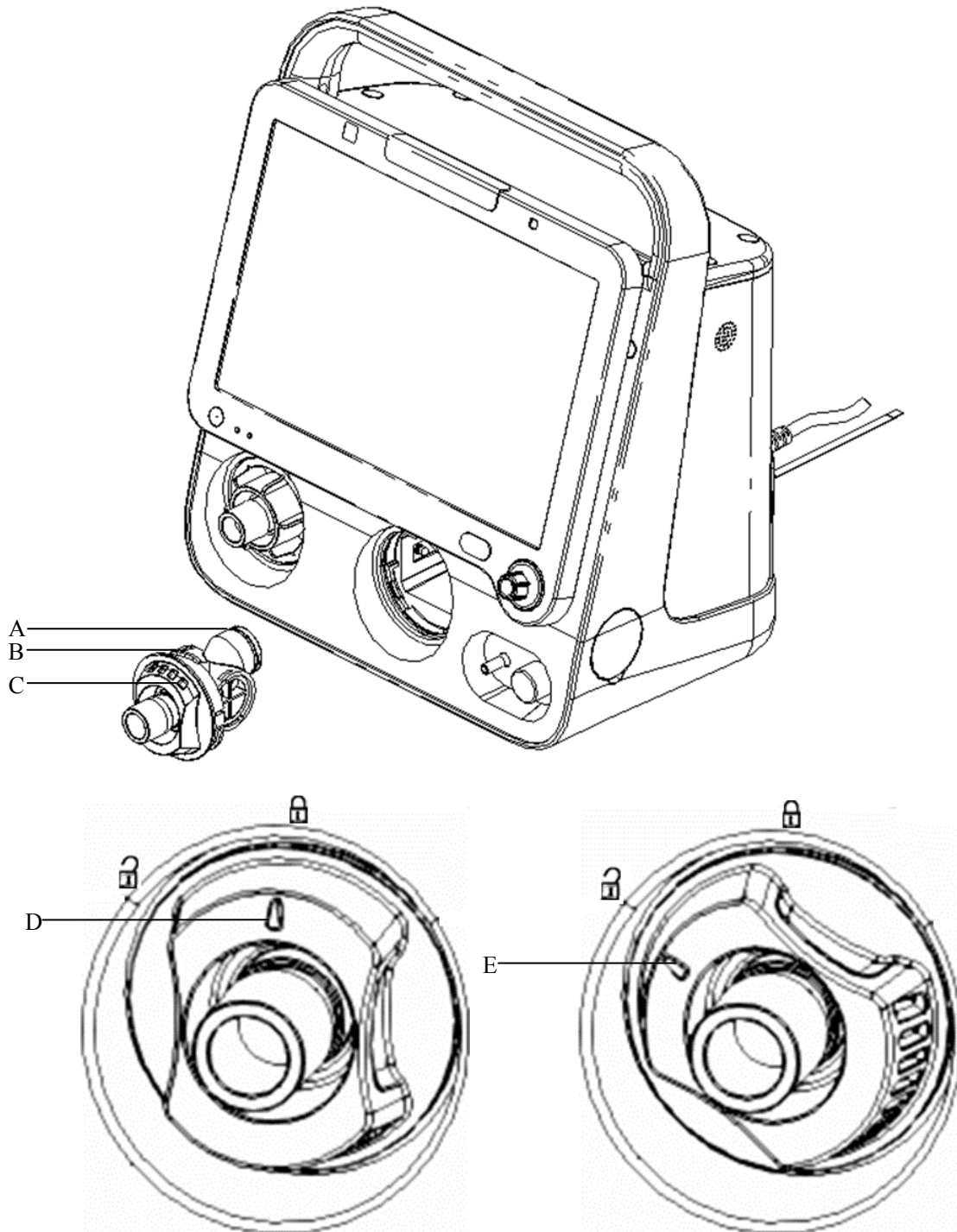

## 11.2.2 Inspiration Safety Valve Assembly

### 11.2.2.1 Inspiration Safety Valve Assembly







- A. Sealing ring
- B. Safety valve assembly
- C. Safety valve handwheel
- D. Locked state of the inspiration safety valve
- E. Unlocked state of the inspiration safety valve

- 
- To disassemble the inspiration safety valve assembly:

Ensure ventilator is in Standby or switched off. Rotate the inspiration safety valve handwheel counter-clockwise until the indicating arrow  on the handwheel aligns with the  position. Then pull out the inspiration safety valve assembly horizontally. Check if the sealing ring at the end of the inspiration safety valve is disconnected. If it is disconnected, re-install the sealing ring onto the inspiration safety valve.

- To install the inspiration safety valve assembly:

Push the inspiration safety valve assembly into the corresponding connector on the ventilator horizontally to the end. Ensure the indicating arrow  on the handwheel aligns with the  position. Then rotate the inspiration safety valve handwheel clockwise (and depress the handwheel in the direction the inspiration safety valve is installed) until the indicating arrow  on the handwheel aligns with the  position.



---

### 11.2.2.2 Inspiration Safety Valve Membrane

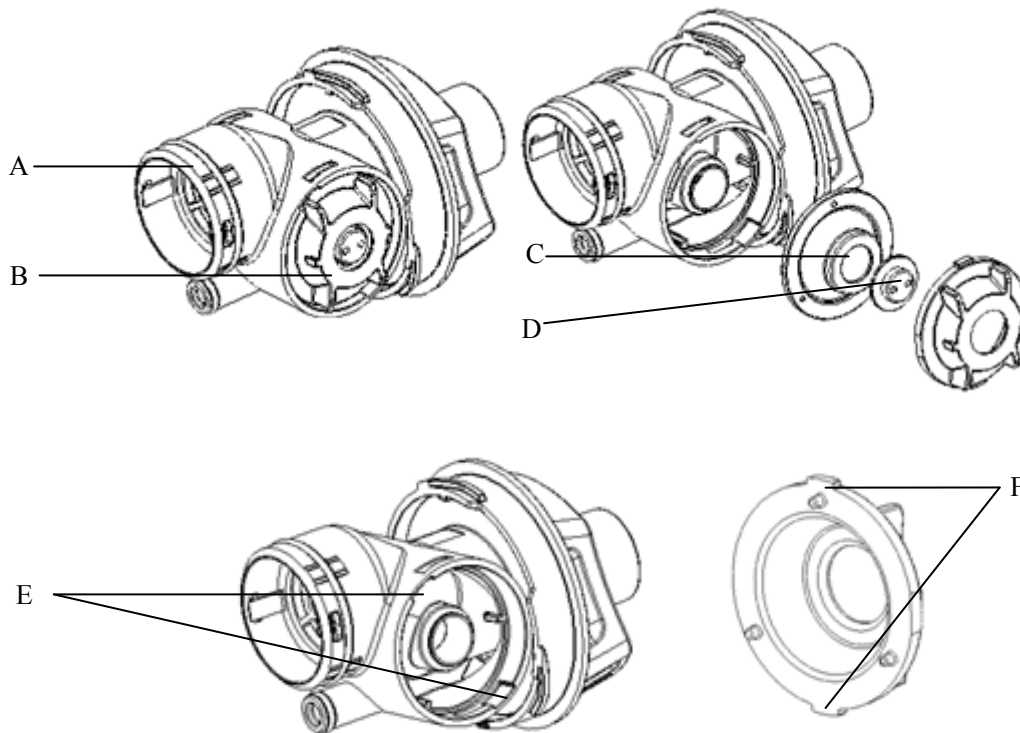

- |                                |                                   |
|--------------------------------|-----------------------------------|
| A. Safety valve body           | B. Membrane fixing knob           |
| C. Safety valve membrane       | D. Membrane support               |
| E. Groove of safety valve body | F. Guides on membrane fixing knob |

- To disassemble the inspiration safety valve membrane:
  1. Face the membrane fixing knob and rotate the membrane fixing knob counter-clockwise to the end position. When the knob guides reach the grooves of safety valve body, pull out the membrane fixing knob.
  2. Remove the safety valve membrane.

- To install the inspiration safety valve membrane:

1. Assemble the safety valve membrane to the membrane fixing knob. The 3 holes on the membrane match the 3 posts on the membrane fixing knob, as shown below. Ensure the metal side of the membrane support can be seen through the hole on the membrane fixing knob.

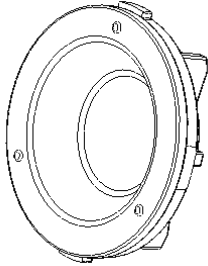

2. Align the guides on membrane fixing knob with the grooves of safety valve body. Insert the membrane fixing knob, press it tightly and rotate it clockwise to the end position.

### 11.2.3 High Efficiency Particle Air (HEPA) Filter Assembly and Dust Filter

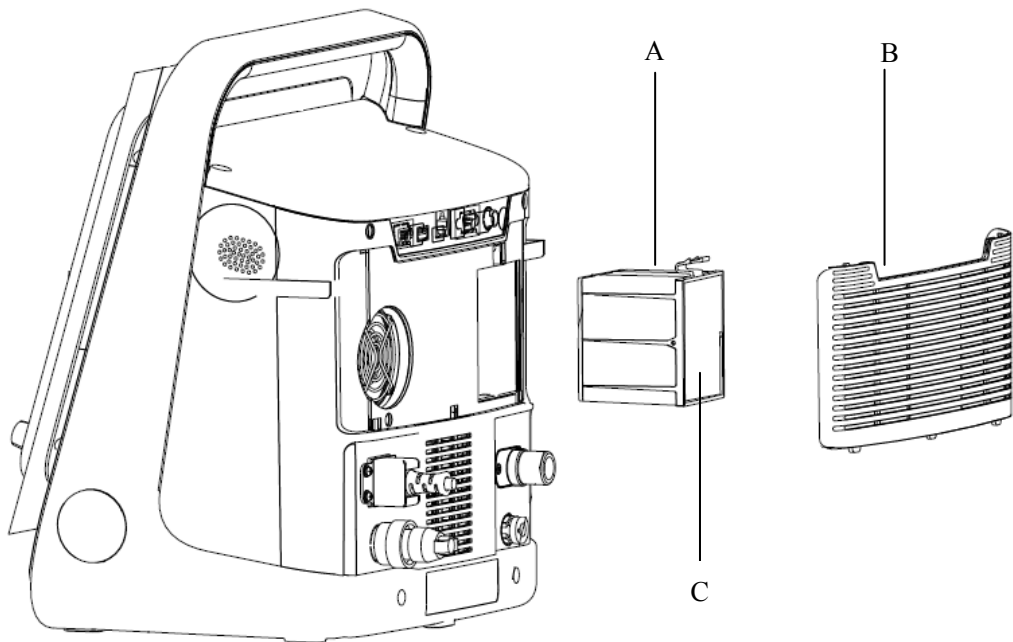

A. HEPA filter

B. Main unit air inlet grille

C. Air intake dust filter

- 
- To disassemble the HEPA filter assembly and air intake dust filter:
    1. Pull the two snaps on the main unit air inlet grille to remove the grille.
    2. Pull the snap on the HEPA filter to take it out. If it is necessary to remove the air intake dust filter, pinch the dust filter with two fingers and take it out.
  
  - To install the HEPA filter assembly and air intake dust filter:
    1. Align the HEPA filter with the corresponding slot, and push in the direction the HEPA filter is installed.
    2. Fasten the snap of the HEPA filter.
    3. Check the snap on the HEPA filter and make sure it is fastened in place.
    4. Install the main unit air inlet grille.

## NOTE

- 
- **Install the specified HEPA filter and air intake dust filter.**
- 

## CAUTION

- 
- **Do not run the ventilator if the ventilator is not equipped with HEPA filter to avoid contaminating the ventilator inspiration port and patient tubing.**
-

---

## 11.2.4 Fan Dust Filter

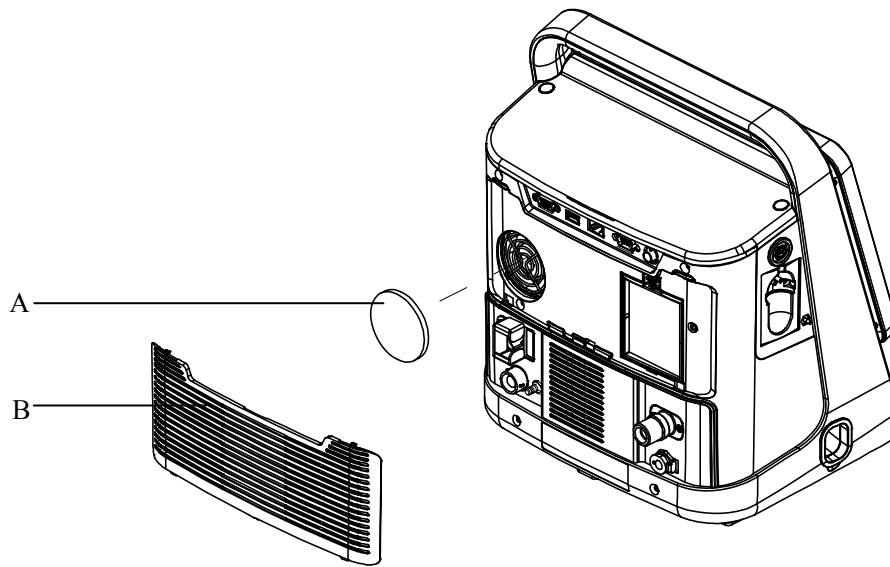

A. Fan dust filter

B. Main unit air inlet grille

■ To disassemble the fan dust filter:

1. Pull the two snaps on the main unit air inlet grille to remove the grille.
2. Remove the fan dust filter.

■ To install the fan dust filter:

1. Put the fan dust filter at the corresponding position of the cooling fan.
2. Insert the protruding points at the bottom of the main unit air inlet grille into the corresponding groove of the main unit to fasten the snap on the grille.

---

## 11.2.5 Main Unit Air Outlet Dust Filter

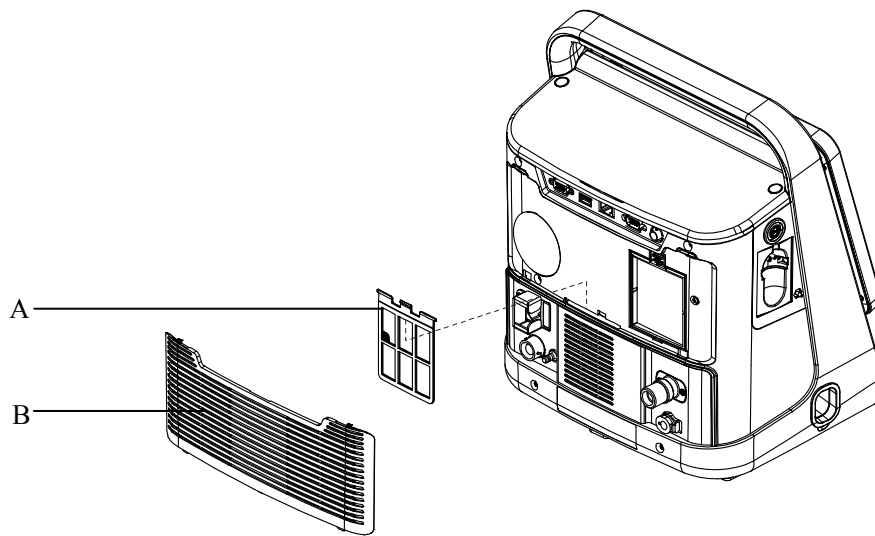

A. Main unit air outlet dust filter

B. Main unit air inlet grille

■ To disassemble the main unit air outlet dust filter:

1. Pull the two snaps on the main unit air inlet grille to remove the grille.
2. Pull out the main unit air outlet dust filter upward.

■ To install the main unit air outlet dust filter:

1. Insert the main unit air outlet dust filter into the corresponding position of the main unit.
2. Insert the protruding points at the bottom of the main unit air inlet grille into the corresponding groove of the main unit to fasten the snap on the grille.

---

## 11.2.6 Patient Tubing

---

### WARNING

- To minimize the risk of bacterial contamination or physical damage, remove and install the bacterial filter with care.
- 

### CAUTION

- When removing the reusable patient tubing, disconnect the tubes from the ventilator connectors instead of pulling the tubes.
- 

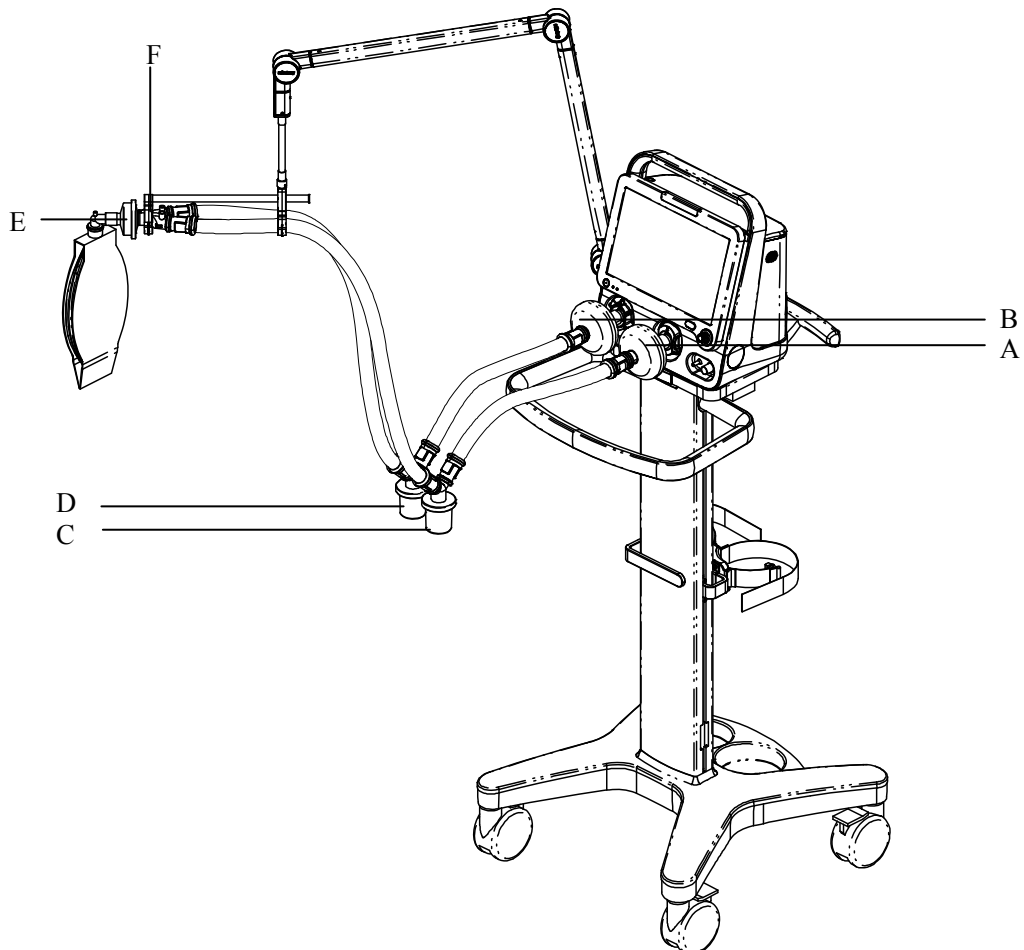

- |                                   |                          |
|-----------------------------------|--------------------------|
| A. Inspiratory filter             | B. Expiratory filter     |
| C. Inspiratory water trap         | D. Expiratory water trap |
| E. Heat & Moisture Exchange (HME) | F. Support arm hook      |

- 
- To disassemble the patient tubing:

Pull out the patient tubing one by one.

- To install the patient tubing:

1. Mount the filters onto the inspiratory and expiratory ports.
2. Connect the inspiratory filter to the water trap via the tube. Connect the other end of the tube to the Y piece.
3. Connect the expiratory filter to the water trap via the tube. Connect the other end of the tube to the Y piece.
4. Connect the patient side of the Y piece to the HME and then connect the patient to the HME.
5. Place the patient tubing onto the support arm hook.

---

## 11.2.7 Nebulizer

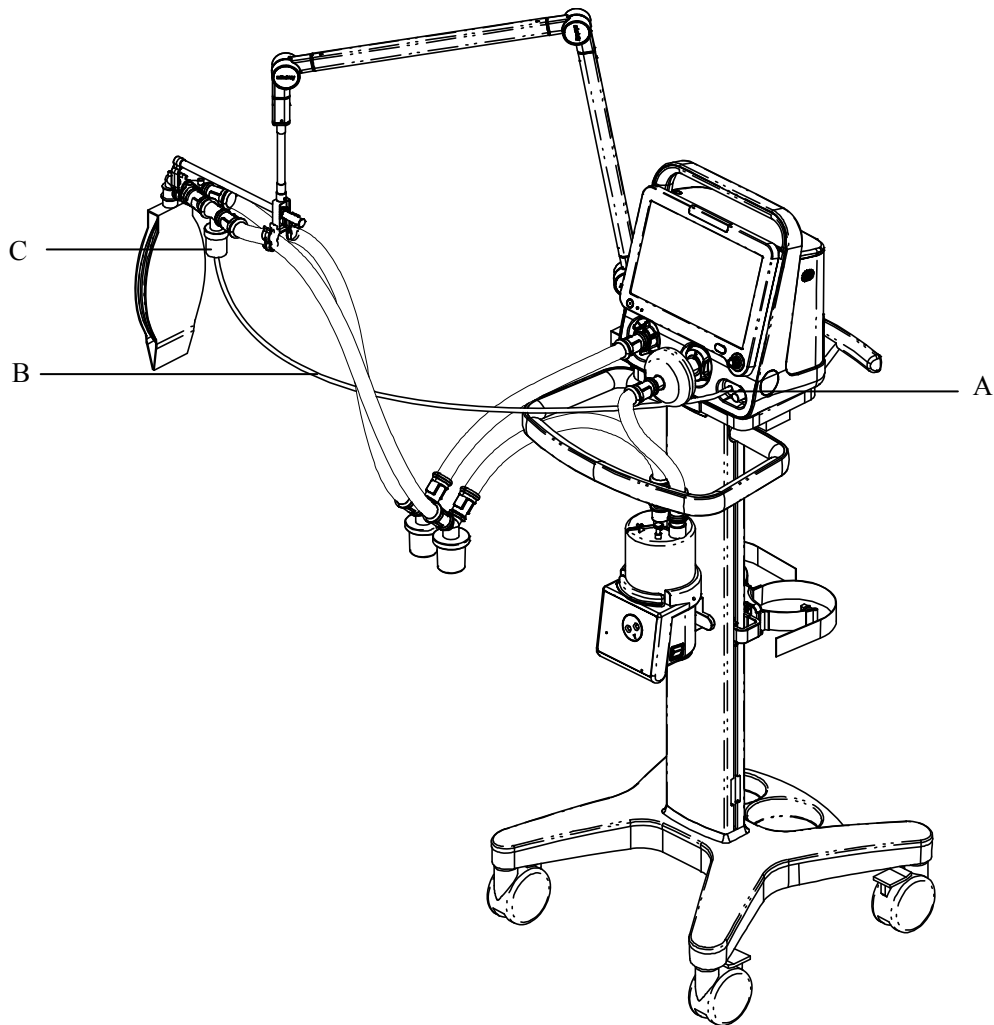

A. Nebulizer connector

B. Nebulizer tube

C. Nebulizer

■ To disassemble the pneumatic nebulizer:

1. Pull out the nebulizer tube from the nebulizer connector.
2. Pull out the nebulizer tube from the nebulizer and remove the nebulizer.

■ To install the pneumatic nebulizer:

1. Connect one end of the nebulizer tube to the nebulizer connector and the other end to the nebulizer.
2. Install the nebulizer in the inspiratory limb via the tube.



---

## NOTE

---

- Install the specified nebulizer. The nebulizer assembly, its installation and disassembling steps described in this section are only for reference.
- 

### 11.2.8 Humidifier

## NOTE

---

- The humidifier shall comply with the requirements of ISO 8185. The humidifier assembly, its installation and disassembling steps described in this section are only for reference.
- 

### 11.2.9 Humidifier on the Ventilator

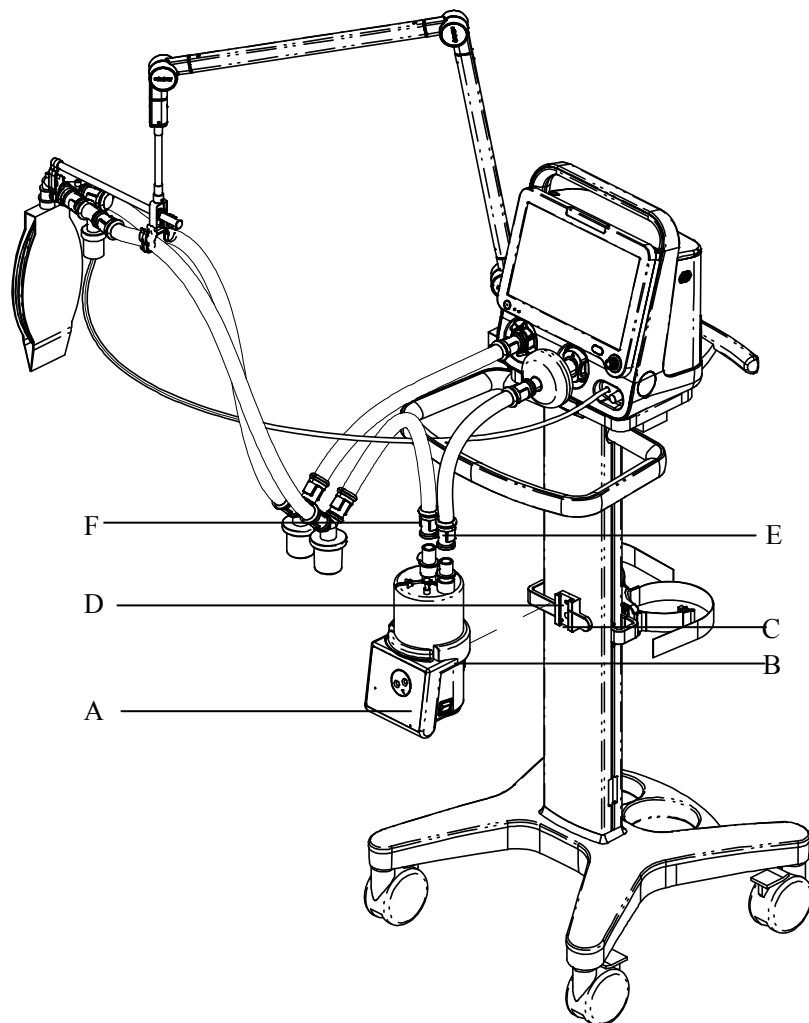

- |               |                              |                            |
|---------------|------------------------------|----------------------------|
| A. Humidifier | B. Humidifier mounting plate | C. Humidifier bracket slot |
| D. Screw      | E. Humidifier inlet          | F. Humidifier outlet       |

- 
- To disassemble the humidifier from the ventilator:
    1. Disconnect the tubes from the humidifier.
    2. Remove the screw.
    3. Lift up the humidifier to remove it from the humidifier bracket fixed seat.
  
  - To install the humidifier onto the ventilator:
    1. Align the humidifier mounting plate and the slot, and slide the humidifier in.
    2. Tighten the screw.
    3. Mount the filters onto the inspiratory and expiratory ports.
    4. Connect the inspiratory filter to the humidifier inlet via the tube.
    5. Connect the humidifier outlet to the water trap via the tube. Then, connect the water trap to the Y piece via the tube.
    6. Connect the expiratory filter to the water trap via the tube. Then, connect the water trap to the Y piece via the tube.
    7. Place the patient tubing onto the support arm hook.

---

### 11.2.9.1 Humidifier on the Pendant

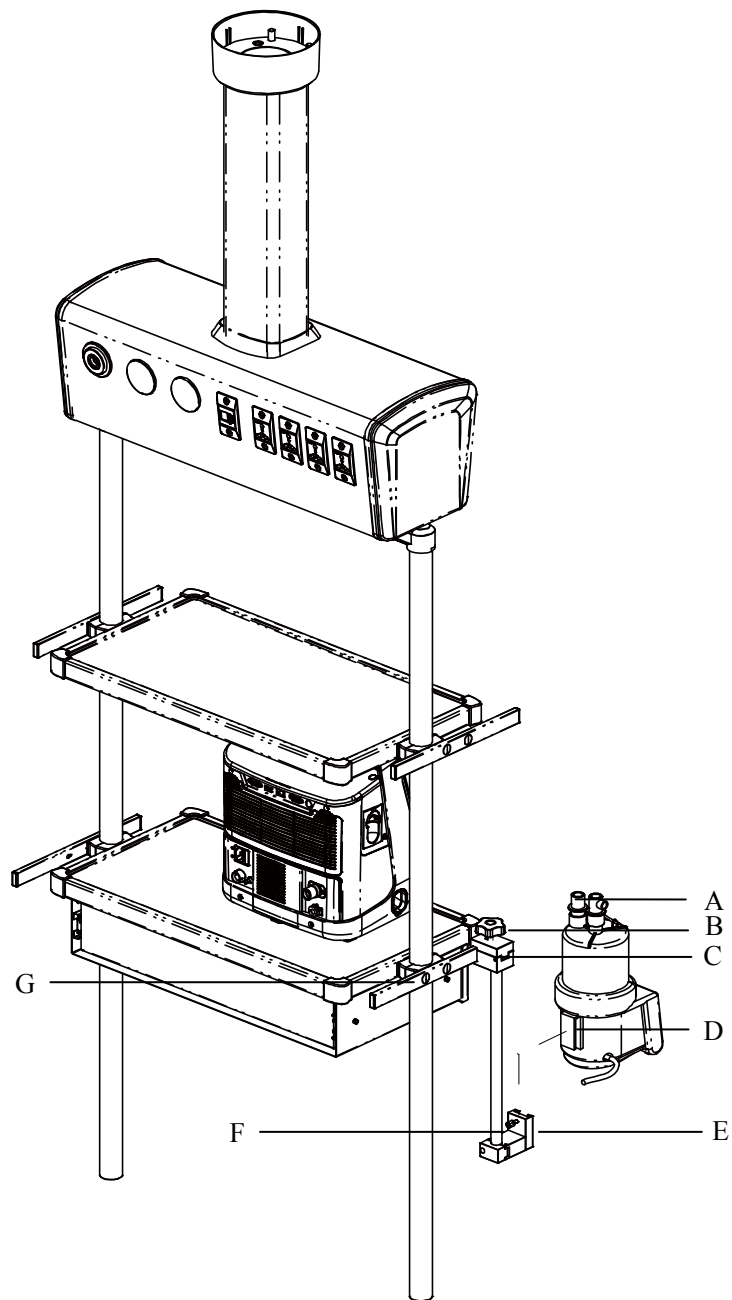

- |                              |                            |                 |
|------------------------------|----------------------------|-----------------|
| A. Humidifier                | B. Fixing block knob       | C. Fixing block |
| D. Humidifier mounting plate | E. Humidifier bracket slot | F. Screw        |
| G. Beam                      |                            |                 |

■ To disassemble the humidifier from the pendant:

1. Disconnect the tubes from the humidifier.
2. Remove the screw.
3. Lift up the humidifier to remove it from the humidifier bracket fixed seat.

- 
- To install the humidifier onto the pendant:
    1. Loosen the fixing block knob. Place the fixing block onto the pendant beam.
    2. Tighten the fixing block knob.
    3. Align the humidifier mounting plate and slot, and slide the humidifier in.
    4. Tighten the screw.
    5. Install the patient tubing. For details, refer to steps 3 through 7 in **11.2.9**.

---

**⚠ WARNING**

---

- **Before installing the humidifier, ensure that the humidifier connector shall be lower than the ventilator's breathing connectors and the patient.**
- 

### 11.2.10 Mainstream CO<sub>2</sub> Sensor

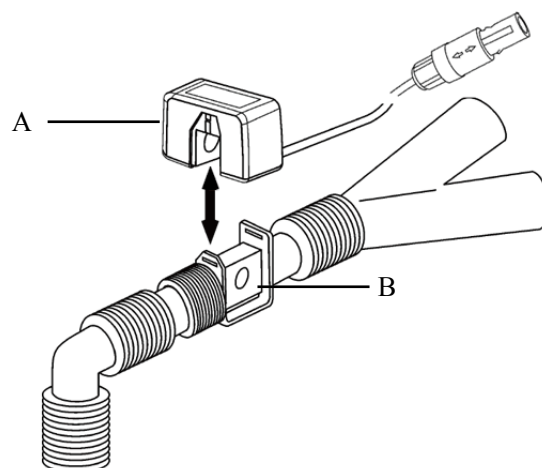

A. CO<sub>2</sub> sensor

B. CO<sub>2</sub> airway adapter

- To disassemble the CO<sub>2</sub> sensor:

Pull out the CO<sub>2</sub> sensor vertically.

- To install the CO<sub>2</sub> sensor:

Fix the CO<sub>2</sub> sensor on the CO<sub>2</sub> airway adapter vertically.

# 12 Maintenance

---

---

## 12.1 Repair Policy

---

### **WARNING**

---

- **Obey infection control and safety procedures. Used equipment may contain blood and body fluids.**
  - **Movable parts and removable components may present a pinch or a crush hazard. Take care to move or replace system parts and components.**
  - **Do not use lubricants that contain oil or grease. They burn or explode in high O<sub>2</sub> concentrations.**
- 
- 

Do not use malfunctioning ventilator. Have all repairs and services done by an authorized service representative. Replacement and maintenance of the parts listed in this manual may be undertaken by a competent, trained individual having experience in the repair of devices of this nature.

After repair, test the ventilator to ensure that it is functioning properly, in accordance with the specifications.

### **NOTE**

---

- **No repair should ever be attempted by anyone not having experience in the repair of devices of this nature.**
  - **Replace damaged parts with components manufactured or sold by us. Then test the unit to make sure that it complies with the manufacturer's published specifications.**
  - **Contact us for service assistance.**
  - **For further information about the product, contact us. We can provide documents about some parts depending on the actual condition.**
-

## 12.2 Maintenance Schedule

Interval	Part/accessory	Procedure
Each patient or as necessary	Patient tubing (including mask, inspiratory filter, flow sensor, expiration valve and membrane)	Perform pressure and flow zeroing. Perform System Check. Perform flow sensor calibration (refer to <b>12.4</b> ). Replace with disinfected parts or new disposable parts.
As necessary	Inspiration safety valve assembly	When the patient's exhaled gas may contaminate the inspiration safety valve assembly, it is necessary to replace with disinfected inspiration safety valve and membrane (refer to <b>11.2.2</b> ).
	Expiration valve	Replace the expiration valve if it is damaged (refer to <b>11.2.1</b> ).
	CO <sub>2</sub> calibration	Calibrate the CO <sub>2</sub> module when the CO <sub>2</sub> measured value has a great deviation.
	Touch screen	Calibrate the touch screen if its function is degraded.
Several times a day or as necessary	Patient tubing	Check the patient tubing and water traps for water build-up. Empty water build-up if there is. Inspect the parts for damage. Replace as necessary.
During cleaning and setup	Ventilator	Inspect the parts for damage. Replace as necessary.
Daily or as necessary	Ventilator	Clean the external surfaces.
	O <sub>2</sub> cell	Calibrate the O <sub>2</sub> cell.
Before each use or after continuous use of two weeks	Entire ventilator	Perform System Check. Check the breathing system resistance and leakage.
Monthly or as necessary	Air intake dust filter and fan dust filter	Check the dust filter for dust build-up. Clean or replace as necessary (refer to <b>11.2.4</b> ).
Check every 6 months and replace every two years	Lithium battery	Check the charging and discharging of the lithium battery every 6 months and replace the lithium battery every two years. Contact us for replacement.
Annually or as necessary	Inspiration safety valve membrane	Check the inspiration safety valve membrane. Contact us for replacement if necessary.

Interval	Part/accessory	Procedure
Annually, or every 5000 hours, or as necessary	O <sub>2</sub> cell	Replace the O <sub>2</sub> sensor if it is damaged (refer to 3.8) . [NOTE] Oxygen cell life specifications are approximate. The actual cell life depends on operating environment. Operation at higher temperatures or higher oxygen concentrations shortens cell life.
	Air intake HEPA filter	Replace (refer to <i>II.2.3</i> ).
	Ventilator	Contact us for preventive maintenance.
	Check valve	Check the check valves, including gas source check valve, spontaneously inspiratory check valve, and expiratory limb check valve. Contact us for replacement if necessary.
	Backup alarm system	Check the alarm duration of backup alarm system (buzzer). If it is too short, contact us.
	Gas source sealing ring	Check the gas source sealing ring. Contact us for replacement if necessary.
	Expiration valve membrane	Check the expiration valve membrane. Contact us for replacement if necessary.
Every 6 years or as necessary	Battery of the clock module	Replace the battery of the clock module. Contact us for replacement.
Every 20,000 hours	Turbine box	Contact us for replacement.

---

## 12.3 Pressure and Flow Zeroing

Zero pressure and flow when the monitored pressure or flow value has a great deviation. Zeroing can be performed in both Standby status and ventilation mode.

Follow these steps to zero pressure and flow:

1. Press the [**Setup**] key. Select [**Calibrate**] and select [**Zero**]. Select [**Start**] to which pressure and flow zeroing correspond on the right side to start P<sub>aw</sub> and flow zeroing. The [**Sensor Zeroing**] prompt message is displayed.
2. After a successful zeroing, the screen shows [**Sensor Zeroing Completed!**]. Otherwise, the message indicating zeroing failure is displayed. In this case, you need to do the zeroing again.

## 12.4 Flow Calibration

### NOTE

---

- **Do not perform calibration while the unit is connected to a patient.**
  - **Do not perform flow calibration when low-pressure oxygen source is used.**
  - **During calibration, do not operate the pneumatic parts. Especially, do not move or press the patient tubing.**
  - **Ensure that the system is in Standby status. If not, push the [Standby] key to enter standby screen.**
  - **It is recommended not to connect the humidifier to the ventilator before the calibration.**
- 

Calibrate the flow sensor when the measured value has a great deviation from the setting, or when the flow sensor is replaced.

Follow these steps to calibrate flow:

1. Ensure high-pressure oxygen source is connected.
2. Connect the patient tubing and insert the Y piece into the leak test plug to close the breathing circuit.
3. Press the [**Setup**] key. Select [**Calibrate**] and select [**Flow Calibration**]. Select [**Start**] on the right side to start Flow Calibration. The [**Calibrating**] prompt message is displayed.
4. During the calibration, if you select [**Stop**], the ongoing calibration will stop and the message [**Calibration Stopped! Calibration is unfinished.**] is displayed.
5. After a successful calibration, the screen shows [**Calibration Completed!**]. Otherwise, the message indicating calibration failure is displayed. In this case, you need to do the calibration again.



---

## NOTE

---

- **In case of calibration failure, check for relevant malfunctioning alarm and then troubleshoot it. If it still fails or great measurement error occurs after troubleshooting, replace the flow sensor and repeat the above operations. If the measurement error is still significant, contact the authorized service personnel.**
- 

## 12.5 Oxygen Concentration Calibration

### NOTE

---

- **Do not perform oxygen concentration calibration while the unit is connected to a patient.**
  - **Do not perform oxygen concentration calibration when low-pressure oxygen source is used.**
  - **Ensure that the system is Standby. If not, push the [Standby] key to enter standby screen.**
- 

Calibrate the oxygen concentration when the measured oxygen concentration has a great deviation from the setting, or when the O<sub>2</sub> sensor is replaced.

Follow these steps to calibrate the oxygen concentration:

1. Ensure high-pressure oxygen source is connected.
2. Press the [Setup] key. Select [Calibrate] and select [O<sub>2</sub> Calibration]. Select [Start] on the right side to start Flow Calibration. The [Calibrating] prompt message is displayed.
3. During the calibration, if you select [Stop], the ongoing calibration will stop and the message [Calibration Stopped! Calibration is unfinished.] is displayed.
4. After a successful calibration, the screen shows [Calibration Completed!]. Otherwise, the message indicating calibration failure is displayed. In this case, you need to do the calibration again.

### NOTE

---

- **In case of calibration failure, check for relevant malfunctioning alarm and then troubleshoot it. Then do the calibration again. In case of repeated calibration failures, replace the O<sub>2</sub> sensor and do the calibration again. If it still fails, contact your service personnel or us.**
-

---

## NOTE

---

- **Handle and dispose of the O<sub>2</sub> sensor according to your biohazard policies. Do not incinerate.**
  - **Oxygen concentration monitoring does not provide automatic atmospheric pressure compensation. Do oxygen concentration calibration again when atmospheric pressure has changed.**
  - **Increasing to periodical pressure of 10 kPa (100 cmH<sub>2</sub>O) has no effect upon oxygen concentration monitoring accuracy.**
  - **O<sub>2</sub> cell measures the partial pressure of oxygen. Increase or decrease of pressure (absolute pressure) affects the partial pressure of oxygen. Increase of pressure (absolute pressure) by 10 % causes oxygen concentration to increase by 10 %. Decrease of pressure (absolute pressure) by 10 % causes oxygen concentration to decrease by 10 %. Do oxygen concentration calibration when atmospheric pressure has changed.**
- 

## 12.6 CO<sub>2</sub> Calibration

### 12.6.1 Sidestream CO<sub>2</sub> Module

#### NOTE

---

- **Ensure that the system is in Standby. If not, push the [Standby] key to enter standby screen.**
- 

Prepare the following before doing the calibration:

- Gas cylinder: cylinders filled with 3 % to 7 % CO<sub>2</sub>
- T-shape connector
- Sampling line

Follow these steps to perform CO<sub>2</sub> calibration:

1. Check the airway and ensure that there are no occlusions or leaks. Ensure that the CO<sub>2</sub> module is already warmed up or started.
2. Select the [Setup] key → [Maintain] → [User] → enter the required password → [CO<sub>2</sub> In Maintenance] → [Zero].
3. After zeroing, connect the gas cylinder to the sampling line via a T-shape connector as shown below. Check the airway and ensure that there are no leaks.

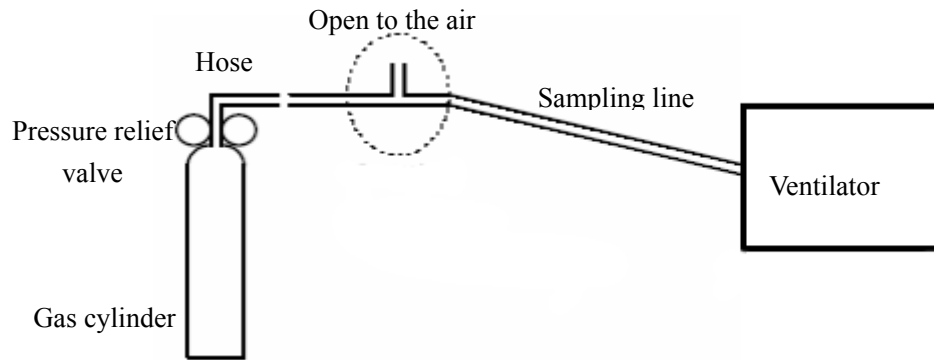

4. Expose the sampling line to the CO<sub>2</sub> by opening the cylinder pressure relief valve.
5. Input the applied CO<sub>2</sub> concentration in the entry box in screen window.
6. The measured CO<sub>2</sub> concentration is displayed. After the measured CO<sub>2</sub> concentration becomes stable, select [**Calibrate**] to calibrate the CO<sub>2</sub> module. The message [**CO<sub>2</sub> Cal. Running**] is displayed.
7. After a successful calibration, the screen shows [**CO<sub>2</sub> % Calibration Completed!**]. Otherwise, the message [**Calibration Failure! Try again!**] is displayed. In this case, you need to do the calibration again.



## 12.6.2 Mainstream CO<sub>2</sub> Module

For a mainstream CO<sub>2</sub> module, manual calibration is not required. The system sends altitude to the mainstream CO<sub>2</sub> module for calibration compensation.

## 12.7 Touch Screen Calibration

### NOTE

- 
- **Ensure that the system is in Standby. If not, push the [Standby] key to enter standby screen.**
- 

1. Press the [**Setup**] key. Select [**Calibrate**] and select [**Screen Calibration**]. Select [**Calibrate**] on the right side.
2. The  mark appears in different locations of the screen.
3. Click the central point of  one by one.
4. After the calibration, the message [**Screen Calibration Completed!**] is displayed. Select [**Ok**] to complete the calibration.

---

## 12.8 Battery Maintenance

---

### CAUTION

---

- The batteries can only be charged by this ventilator.
- 

### NOTE





---

- Use batteries at least once every month to extend their lives. Charge the batteries before they are depleted.
  - Inspect and replace batteries regularly. Battery life depends on how frequent and how long battery is used. For a properly maintained and stored lithium battery, its life expectancy is approximately 2 years. For more aggressive use models, life expectancy can be shortened. We recommend replacing lithium batteries every 2 years.
  - In case of battery failure, contact us or have your service personnel replace it. Do not replace the battery without permission.
  - Check battery performance once every six months. Checking battery performance is also required before ventilator repair is carried out or when battery is doubted to be the source for ventilator failure.
  - Condition batteries once every time when they have been used for three months or when the battery running time becomes noticeably short.
- 

The ventilator is designed to operate on battery power whenever power supply becomes interrupted. When the ventilator is connected to the external power source, the batteries are charged regardless of whether the ventilator is currently on or not. In case of power failure, the ventilator will automatically be powered by the internal batteries. When external power source is restored within the specified time, power supply is switched from battery to external power supply automatically to ensure continuous system use.

---

On-screen battery icon indicates the battery statuses as follows:

- : indicates that external power source is connected. The ventilator is powered by external power source. The solid green portion represents the current charge level of the batteries in proportion to its maximum charge level.
- : indicates that external power source is not connected. The ventilator is powered by built-in batteries. The solid blue portion represents the current charge level of the batteries in proportion to its maximum charge level.
- : indicates that external power source is not connected. The ventilator is powered by built-in batteries. The battery capacity is low and the batteries need to be charged immediately.
- : indicates that no batteries are installed.

If the capacity of the internal battery is limited, the alarm [**Low Battery. Connect External Power Supply.**] will be triggered. In this case, apply external power to the ventilator.

## 12.8.1 Battery Performance Conditioning

Condition batteries when they are put into use for the first time. A complete battery conditioning cycle is: uninterrupted charging, followed by uninterrupted discharging until the ventilator shuts off, and then uninterrupted charging. Condition batteries regularly to maintain their service lives.

### NOTE

- 
- **Condition batteries every time when they have been used for three months or when the battery running time becomes noticeably short.**
  - **Over time and with the use of the battery, the actual battery capacity will decrease. For an old battery, the battery full icon does not indicate that the battery capacity or battery running time still meets the requirement specified. When conditioning batteries, replace the battery when its running time becomes noticeably short.**
- 

Follow these steps to condition batteries:

1. Disconnect the patient from the ventilator and shut down the ventilator.
2. Connect the ventilator to the external power source and charge the batteries uninterruptedly for at least 10 hours.
3. Disconnect the external power source. Allow the ventilator to operate on battery power until the ventilator shuts off.
4. Re-connect the ventilator to the external power source and charge the batteries uninterruptedly for at least 10 hours.
5. Battery conditioning is now completed.

---

## 12.8.2 Battery Performance Checking

Check battery performance once every six months. Checking battery performance is also required before ventilator repair is carried out or when battery is doubted to be the source for ventilator failure. Battery performance may degrade over time.

Follow these steps to check battery performance:

1. Disconnect the patient from the ventilator and shut down the ventilator.
2. Connect the ventilator to the external power source and charge the batteries uninterruptedly for at least 10 hours.
3. Disconnect the external power source. Allow the ventilator to operate on battery power until the ventilator shuts off.
4. The running time of the battery reflects its performance.

If the running time of the battery is noticeably shorter than that stated in the specifications, replace the battery or contact the service personnel.

### NOTE

- 
- **If the running time of the battery is too short after fully charged, the battery may be damaged already or defective.**
  - **If obvious signs of damage are detected on the battery or the battery recharging has failed, replace the battery and recycle it properly.**
- 

## 12.8.3 Battery Storage

During storing batteries, ensure the battery electrodes do not get in touch with metal. In case of long-time storage, place batteries in a cool environment and keep battery power at 40% to 60%.

Placing batteries in a cool environment can delay battery aging. Ideally, batteries should be stored in a cool environment of 15°C (60°F). Do not store batteries outside the environmental range of -20°C (-4°F) to +60°C (140°F).

Remove the batteries from the ventilator if the ventilator is not used for a long time. Failure to do so will over-discharge the batteries and extend the battery charging time noticeably. Fully charge the batteries once every 2 months and keep battery power at 40% to 60%. Fully charge the batteries before use.

---

## NOTE

---

- **Remove the batteries from the equipment if the equipment is not used for a long time.**
  - **Long-time storage of batteries above 38°C (100°F) greatly shortens the battery life expectancy.**
- 

### 12.8.4 Battery Recycling

If obvious signs of damage are detected on the battery or the battery recharging is failed, replace the battery and recycle it properly. Dispose of the battery in compliance with the local laws regulating the disposal of such product.

---

### **WARNING**

---

- **Do not disassemble batteries, or dispose of them in fire, or short-circuit them. They may ignite, explode and leak, causing personal injury.**
-

---

## 12.9 Electrical Safety Inspection

### NOTE

---

- **Perform electrical safety inspection after servicing or routine maintenance. Before the electrical safety inspection, ensure all the covers, panels, and screws are correctly installed.**
  - **The electrical safety inspection should be performed once a year.**
- 

1. Perform protective earth resistance test:
  - a. Plug the probes of the analyzer into the protective earth terminal of the AC power cord and the screw.
  - b. Test the earth resistance with a current of 25A.
  - c. Verify the resistance is less than 0.1ohms (100 mohms).
  - d. If the resistance is larger than 0.1ohms (100 mohms) but less than 0.2ohms (200 mohms), disconnect the AC power cord and plug the probe, that was previously plugged in the protective earth terminal of the AC power cord, into the protective earth contact of the power outlet. Repeat steps a to c.
2. Perform the following earth leakage current tests:
  - normal polarity
  - reverse polarity
  - normal polarity with open neutral; and
  - reverse polarity with open neutral.
3. Verify the maximum leakage current does not exceed 500  $\mu$ A (0.5 mA) in the first two tests. While for the last two tests, verify that the maximum leakage current does not exceed 1000  $\mu$ A (1 mA).

### NOTE

---

- **Ensure the safety analyzer is authorized by certificate organizations (UL, CSA, or AAMI etc.). Follow the instructions of the analyzer manufacturer.**
-



---

## 12.10 Water Build-up in the Flow Sensor

### 12.10.1 Prevent Water Build-up

The patient's exhaled warm and moist gas is condensed when it flows through the expiratory hose. The condensed water remains on the hose wall and finally enters the water trap. When the patient's exhaled gas arrives at the expiration valve, condensed water may appear at the expiration valve (including the expiratory flow sensor), compromising the measurement accuracy of expiratory flow sensor.

Check the expiration valve for water build-up when abnormal flow waveform or unstable tidal volume fluctuation is detected. If there is water build-up inside the expiration valve, clear it before use.

Check the expiratory water trap for water during the use of the ventilator. If there is water build-up, empty it promptly. Water condensation in the expiration valve can be reduced by using a bacteria filter between the expiratory tube and expiration valve.

### 12.10.2 Clear Water Build-up

If there is water built up inside the expiration valve, remove the expiration valve and clear the water. Then reinstall the valve for use.

---

#### **WARNING**

---

- **Ensure that all breathing system parts are dry every time when the breathing system is cleaned and disinfected.**
  - **Check the expiration valve for water build-up when abnormal flow waveform or unstable tidal volume fluctuation is detected. If there is water build-up inside the expiration valve, clear it.**
-

---

**FOR YOUR NOTES**

# 13 Accessories

---

---

## WARNING

---

- Use only accessories specified in this chapter. Using other accessories may cause incorrect measured values or equipment malfunction.
  - Disposable accessories can not be reused. Reuse may degrade performance or cause cross infection of the next patient.
  - Check the accessories and their packages for damage. Do not use them if any sign of damage is detected.
  - Parts which are intended to contact patients must comply with the biocompatibility requirement of ISO10993-1 to prevent any adverse reactions arising from such contact.
  - Disposal of the accessories shall comply with the applicable waste control regulations.
  - The user shall buy legally launched products for other accessories required to implement the functions of the machine.
- 

## NOTE

---

- All the accessories listed are validated for use with this specific ventilator. And the hospital is responsible for ensuring the compatibility of the ventilator and the accessories before use. The incompatible parts can result in degraded performance.
  - The CO<sub>2</sub> and SpO<sub>2</sub> module accessory material that contacts the patients has undertaken the bio-compatibility test and is verified to be in compliance with ISO 10993-1.
- 

Accessories	Description	PN	Manufacturer
Patient tubing kit (including breathing tubes, connectors, water trap, etc.)	Reusable adult breathing circuit package	040-001892-00	Mindray
	Reusable pediatric/infant breathing circuit package	040-001894-00	Mindray
	Reusable breathing tube kit(adult)	040-003489-00	/
	Reusable breathing tube kit(child/neonate)	040-003490-00	/
	Disposable adult breathing circuit package	040-001884-00	Mindray

	Disposable pediatric breathing circuit package	040-001886-00	Mindray
Filter	Filter used for the breathing system (small size)	040-001570-00	VADI
	Filter used for the breathing system (large size)	040-001571-00	VADI
	Disposable anesthesia breathing filter	040-001831-00	Mindray
Nebulizer	Hand held micro spray bottle group	040-000799-00	VADI
Mask	NIV mask, small size, with head band	040-001860-00	Mindray
	NIV mask, medium size, with head band	040-001861-00	Mindray
	NIV mask, large size, with head band	040-001862-00	Mindray
	NIV mask, small size	040-002373-00	Fisher&Paykel
	NIV mask, medium size	040-002374-00	Fisher&Paykel
	NIV mask, large size	040-002375-00	Fisher&Paykel
O <sub>2</sub> therapy	O <sub>2</sub> therapy mask (large size, adult)	040-002365-00	Galeded
	O <sub>2</sub> therapy mask (small size, child)	040-002366-00	Galeded
	O <sub>2</sub> therapy nasal cannula for neonate	040-002904-00	Fisher&Paykel
	O <sub>2</sub> therapy nasal cannula for pediatric	040-002905-00	Fisher&Paykel
	Nasal catheter (small)(10)	115-037829-00	Fisher&Paykel
	Nasal catheter (medium)(10)	115-037830-00	Fisher&Paykel
	Nasal catheter (large)(10)	115-037831-00	Fisher&Paykel
	Nasal Cannula, small size	040-002376-00	Fisher&Paykel
	Nasal Cannula, medium size	040-002377-00	Fisher&Paykel
	Nasal Cannula, large size	040-002378-00	Fisher&Paykel
Test lung	Clipped Test Lung (adult)	040-000744-00	VADI
	Test Lung (infant)	040-000745-00	VADI
Humidifier kit (including humidifier, water tank, heated patient tubing, etc.)	Humidifier (SH330/European standard)	115-018049-00	Ji Ke
	Humidifier (SH330/Indian standard)	115-018050-00	Ji Ke
	Humidifier (SH330/American standard/110V)	115-018051-00	Ji Ke
	Humidifier (SH330/British standard)	115-018053-00	Ji Ke
	Humidifier (SH330/American standard/220V)	115-018054-00	Ji Ke
	Humidifier (SH530/heating/disposable tube/European standard)	115-018056-00	Ji Ke
	Humidifier (SH530/heating/disposable tube/Indian standard)	115-018057-00	Ji Ke
	Humidifier (SH530/heating/disposable tube/American standard/110V)	115-018058-00	Ji Ke
	Humidifier (SH530/heating/disposable tube/British standard)	115-018060-00	Ji Ke

Humidifier (SH530/heating/disposable tube/American standard/220V)	115-018061-00	Ji Ke
Humidifier SH530/heating/disposable tube/European standard (infant)	115-028494-00	Ji Ke
Humidifier SH530/heating/disposable tube/India (infant)	115-028496-00	Ji Ke
Humidifier SH530/heating/disposable tube/British standard (infant)	115-028498-00	Ji Ke
Humidifier SH530/heating/disposable tube/American standard 110V (infant)	115-028500-00	Ji Ke
Humidifier SH530/heating/disposable tube/American standard 220V (infant)	115-028502-00	Ji Ke
Humidifier (MR850/230V/adult/heating/tube)	115-004511-00	Fisher&Paykel
Humidifier (MR 850/ Australian standard/infant/heating/tube)	115-004512-00	Fisher&Paykel
Humidifier (MR850/115V/adult/heating/tube)	115-004513-00	Fisher&Paykel
Humidifier (MR850/115V/ infant/heating/tube)	115-004514-00	Fisher&Paykel
Humidifier (MR810/230V/adult /tube)	115-004515-00	Fisher&Paykel
Humidifier (MR810/115V/adult /tube)	115-004516-00	Fisher&Paykel
Humidifier (850/British standard/adult/heating/tube)	115-008352-00	Fisher&Paykel
Humidifier ( 850/British standard/infant/heating/tube)	115-008353-00	Fisher&Paykel
Humidifier (850/European standard/adult/heating/tube)	115-008354-00	Fisher&Paykel
Humidifier (850/European standard/infant/heating/tube)	115-008355-00	Fisher&Paykel
Humidifier (850/230V general/adult/heating/tube)	115-008356-00	Fisher&Paykel
Humidifier (850/230V general/infant/heating/tube)	115-008357-00	Fisher&Paykel
Humidifier (810/British standard/adult)	115-008358-00	Fisher&Paykel
Humidifier ( 810/European standard/adult)	115-008359-00	Fisher&Paykel
Humidifier (810/230V general/adult)	115-008360-00	Fisher&Paykel
Humidifier (850/Aus/adult/heating/disposable)	115-041049-00	Fisher&Paykel
Humidifier (850/Aus/infant/heating/disposable)	115-041050-00	Fisher&Paykel
Humidifier	115-046051-00	Fisher&Paykel

	(850/115V/adult/heating/disposable)		
	Humidifier (850/115V/infant/heating/disposable)	115-041052-00	Fisher&Paykel
	Humidifier (850/UK/adult/heating/disposable)	115-041053-00	Fisher&Paykel
	Humidifier (850/UK/infant/heating/disposable)	115-041054-00	Fisher&Paykel
	Humidifier (850/EU/adult/heating/disposable)	115-041055-00	Fisher&Paykel
	Humidifier (850/EU/infant/heating/disposable)	115-041056-00	Fisher&Paykel
	Humidifier (850/230V/general/adult/disposable)	115-041057-00	Fisher&Paykel
	Humidifier (850/230V/general/infant/disposable)	115-041058-00	Fisher&Paykel
Humidifier water tank	SH330B infant reusable humidifying water tank	040-002174-00	Ji Ke
	Disposable automatic humidifying water tank	040-002173-00	Ji Ke
	Humidifier water tank (with one connector) EU version	040-001530-00	Ji Ke
	Infant humidifying water tank	040-000709-00	Fisher&Paykel
	Adult humidifying water tank	040-000710-00	Fisher&Paykel
Humidifier tubing kit	Humidifier (reusable heating tube kit)	115-018062-00	Ji Ke
	Humidifier (heating/disposable tube kit)	115-018063-00	Ji Ke
	Humidifier disposable heating tube package (infant)	115-028490-00	Ji Ke
	Infant heating strip patient tubing	040-002172-00	Ji Ke
	Heating wire cable (RT)	040-003014-00	Fisher&Paykel
	Disposable breathing tube kit (adult, with water tank)	040-002892-00	Fisher&Paykel
	Disposable breathing tube kit (neonate, with water tank)	040-002891-00	Fisher&Paykel
	Infant single heating patient tubing package	040-000711-00	Fisher&Paykel
	Adult single heating patient tubing package	040-000715-00	Fisher&Paykel
Gas supply hose assembly	Ventilator oxygen hose accessories kit (German standard)	115-008257-00	GENTEC
	Ventilator oxygen hose accessories kit (French standard)	115-008259-00	GENTEC
	Ventilator oxygen hose accessories kit (Australian standard)	115-008261-00	GENTEC

	Ventilator oxygen hose accessories kit (American standard/dual connector/DISS)	115-008209-00	GENTEC
	Ventilator oxygen hose accessories kit (British standard)	115-008201-00	GENTEC
Oxygen sensor	Oxygen sensor	040-001275-00	City
CO <sub>2</sub> module accessories	Mainstream CO <sub>2</sub> module accessories kit	6800-30-50613	Respironics
	Sidestream CO <sub>2</sub> module accessories kit (adult/pediatric)	115-025015-00	/
	Sidestream CO <sub>2</sub> module accessories kit (neonatal)	115-025016-00	/
SpO <sub>2</sub> module accessories*	SpO <sub>2</sub> module accessories kit (adult)	0651-30-77014	/
	SpO <sub>2</sub> module accessories kit (pediatric)	0651-30-77015	/
Bracket	Pendant mounting bracket of the humidifier	115-006158-00	Mindray
Expiration valve	Sterilizable expiration valve assembly	115-021461-00	Mindray
Safety valve	Detachable part of the safety valve	115-021478-00	Mindray
Lithium battery	Lithium battery material kit (delivered separately)	115-025022-00	SANYO
Power cord	WIRE, power cord, British standard	DA8K-10-14453	BIZILINK
	WIRE, 3-core power cord, 2.5M 250V 10A NEMA5-15P receptacle	009-000567-00	BIZILINK
	AC power cord (European standard, 3.5M)M2511-V1625	TSB1-20-20509	VOLEX
	AC power cord (American standard, 3.5M)PS206-V1625	TSB1-20-20510	VOLEX
	Power cord, Brazil standard, 250V, 10A, 3M	009-001075-00	VOLEX
	3-core power cord (3.5m)	009-005400-00	VOLEX
	Power cord (South Africa, 3m)	009-007786-00	VOLEX
	Power cord (Indian, 3m)	009-007190-00	VOLEX
	DC power cord	009-003008-00	Taijia
Support arm	Support arm	045-000625-00	Mindray
Ventilator packing parts material kit (including power cord retainer)	Ventilator packing parts material kit	115-025211-00	Mindray
Trolley	Trolley (international/including packing materials)	115-025215-00	Mindray
Accompanying documents	SV300 Operator's Manual (English)	046-006329-00	Mindray
	SV300 Operator's Manual (French)	046-006331-00	Mindray
	SV300 Operator's Manual (Russian)	046-006333-00	Mindray
	SV300 Operator's Manual (Spanish)	046-006335-00	Mindray
	SV300 Operator's Manual (Turkish)	046-006337-00	Mindray

	SV300 Operator's Manual (German)	046-006339-00	Mindray
	SV300 Operator's Manual (Polish)	046-006341-00	Mindray
	SV300 Operator's Manual (Portuguese)	046-006343-00	Mindray
	SV300 Operator's Manual (Italian)	046-006345-00	Mindray
	SV300 Operator's Manual (Hungarian)	046-007587-00	Mindray
	SV series ventilator operation guide (English)	046-006330-00	Mindray
	SV series ventilator operation guide (French)	046-006332-00	Mindray
	SV series ventilator operation guide (Russian)	046-006334-00	Mindray
	SV series ventilator operation guide (Spanish)	046-006336-00	Mindray
	SV series ventilator operation guide (Turkish)	046-006338-00	Mindray
	SV series ventilator operation guide (German)	046-006340-00	Mindray
	SV series ventilator operation guide (Polish)	046-006342-00	Mindray
	SV series ventilator operation guide (Portuguese)	046-006344-00	Mindray
	SV300, SV350 Operator's Manual (Brazil)	046-007134-00	Mindray
	SV series ventilator operation guide (Italian)	046-006346-00	Mindray
	SV series ventilator operation guide (Hungarian)	046-007588-00	Mindray
Y piece	Reusable Y piece, with temperature and pressure measuring hole	040-001866-00	Mindray
Connector	Reusable L-shaped connector, 22M/15F, 15M	040-001867-00	Mindray
	Reusable L-shaped connector, 22M/15F, 22F	040-001868-00	Mindray
	Reusable straight connector, 22M/22M	040-001869-00	Mindray
	Reusable straight connector, 22M/15M	040-001870-00	Mindray
Extension tube	Reusable extension tube	040-001871-00	Mindray
Water collection cup	Reusable water collection cup	040-001872-00	Mindray
Upgrade package	Sidestream CO <sub>2</sub> upgrade package (adult/pediatric)	115-028389-00	/
	Sidestream CO <sub>2</sub> upgrade package (neonatal)	115-028385-00	/
	Mainstream CO <sub>2</sub> upgrade package	115-028386-00	/



	SpO <sub>2</sub> module upgrade package (adult)	115-028396-00	/
	SpO <sub>2</sub> module upgrade package (pediatric)	115-028395-00	/
HEPA filter	HEPA filter	045-001333-01	ZJNF
Dust filter	Air intake dust filter	045-001298-01	Guozhihuiifu
Gas supply hose assembly	Gas supply hose assembly, O <sub>2</sub> supply, European standard 34I-OXY-DS/NS-0.6	082-001926-00	GENTEC
	Gas supply hose assembly, O <sub>2</sub> supply, American standard 34U-OXY-DS/DS-0.6	082-001918-00	GENTEC
Gas valve	Gas valve, high-pressure cylinder pressure reducer, 14Mpa	082-001927-00	GENTEC
Low pressure oxygen connector	Connector, straight, white POM, with O-ring, applicable to 3/16"ID hose	082-001920-00	CPC

\* :

The pulse oximeter probes and probe cable extenders listed for this device have been validated and tested for compliance with ISO 80601-2-61.

The SpO<sub>2</sub> sensor material that contacts patients or other staff has undertaken the bio-compatibility test and is verified to be in compliance with ISO 10993-1.

Wavelength emitted by the sensors intended for Mindray SpO<sub>2</sub> module: red light: 660 nm, infrared light: 905 nm.

The maximum photic output consumption of the sensor is less than 18 mW.

The information about the wavelength range and maximum photic output consumption can be especially useful to clinicians, for example, clinicians performing photodynamic therapy.

---

**FOR YOUR NOTES**

# A Theory of Operation

## A.1 Pneumatic System

### A.1.1 Pneumatic Circuit Diagram

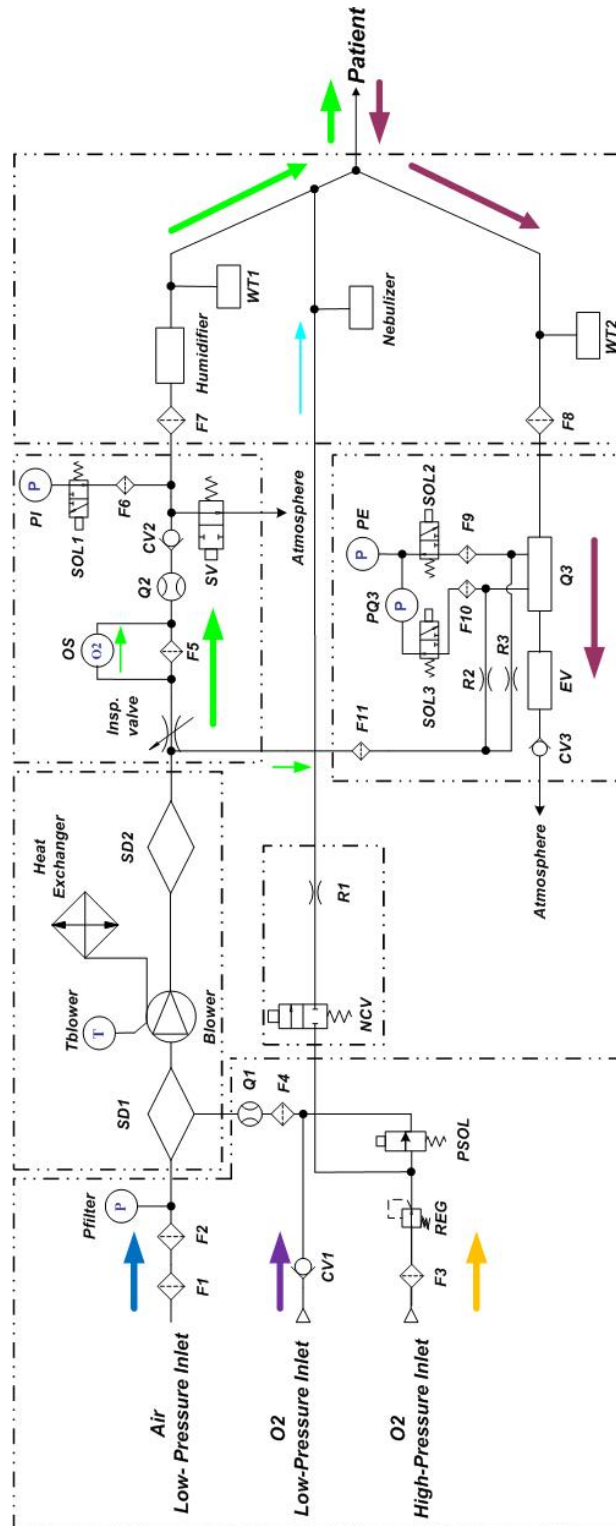

## A.1.2 Parts List

Symbol	Description	Symbol	Description
Air Low-Pressure Inlet	Air supply (low pressure)	SOL1	Zeroing three-way valve
F1	Dust filter (Air)	PI	Inspiratory pressure sensor
F2	HEPA filter (Air)	F6	Inspiratory pressure sensor filter
Pfilter	Vacuum sensor (Air)	Humidifier	Humidifier
O <sub>2</sub> Low-Pressure Inlet	O <sub>2</sub> supply(low pressure)	WT1	Water trap
CV1	Check valve	Patient	Patient
O <sub>2</sub> High-Pressure Inlet	O <sub>2</sub> supply(high pressure)	NCV	Nebulizer switch
F3	Filter (O <sub>2</sub> )	R1	Nebulizer resistor
REG	Regulator	Nebulizer	Nebulizer
PSOL	Proportional solenoid valve	WT2	Water trap
F4	Filter screen	F7	Bacteria filter (connecting to inspiratory port)
Q1	Flow sensor	Q3	Expiratory flow sensor
SD1	Level 1 mixed noise reduction chamber	F8	Bacteria filter (connecting to patient port)
Tblower	Temperature sensor	F9	Filter
Blower	Turbine blower	F10	Filter
SD2	Level 2 mixed noise reduction chamber	SOL2	Zeroing three-way valve
Heat Exchanger	Heat exchanger	SOL3	Zeroing three-way valve
Insp. valve	Inspiration valve	PQ3	Expiratory differential pressure sensor
OS	O <sub>2</sub> concentration sensor	PE	Expiratory pressure sensor
F5	Filter screen	F11	Filter
Q2	Flow sensor	R2	Resistor
CV2	Check valve	R3	Resistor
SV	Safety valve	EV	Expiration valve
Atmosphere	Atmosphere	CV3	Expiratory check valve

Note: the nebulizer mentioned in this manual shall be the legal product with medical device certificate registered in the People's Republic of China. This requirement applies to nebulizers mentioned in other places than here.

---

### A.1.3 Theory

This product is an electronically driven and electronically controlled ventilator. Oxygen is provided by high- or low-pressure oxygen port. Air is inhaled from the ambient atmosphere due to vacuum produced by the turbine motor. During the inspiratory phase, the inspiration valve opens. Gas with specific O<sub>2</sub> concentration is formed in the upstream of inspiration valve after Air and O<sub>2</sub> are mixed. Such gas becomes gas with specific flow or pressure after passing through the inspiration valve and enters the patient's lungs via inspiratory tube. During the expiratory phase, the inspiration valve is closed while the expiration valve opens. The gas reaches the expiration valve from the lungs via the expiratory tube and is finally discharged out of the human body.

When the turbine works to inhale Air from the ambient atmosphere, Filter (F1) filters dust in the Air. Filter (F2) is an HEPA filter for filtering bacteria. After the machine is used or placed for a period of time, dust or foreign substance absorbed on the surfaces of the two filters at the Air inlet can occlude the Air inlet when the dust or foreign substance is accumulated to a certain extent. This may cause insufficient Air intake of the machine and compromise the ventilation performance of the machine. Vacuum sensor (Pfilter) at the Air inlet monitors the vacuum at the Air inlet in real-time, effectively judges filter occlusion at the Air inlet, and gives the replacement prompt.

Check valve (CV1) ensures unidirectional flow of low-pressure O<sub>2</sub>. Filter (F3) filters foreign substance in the high-pressure O<sub>2</sub> supply. Regulator (REG) regulates and stabilizes the pressure of high-pressure O<sub>2</sub> supply to ensure the stability and repetitiveness of flow outputted by the rear proportional solenoid valve (PSOL).

Filter screen (F4) is placed before the flow sensor to stabilize gas flow for the convenience of sensor measurement. Flow sensor (Q1) is a hot-wire mass flow sensor which does not require calibration.

The gas supply part includes three parallel limbs: high-pressure O<sub>2</sub>, low-pressure O<sub>2</sub>, and low-pressure Air. The high-pressure O<sub>2</sub> and low-pressure O<sub>2</sub> converge before mixing with Air. High-pressure O<sub>2</sub> and low-pressure O<sub>2</sub> cannot be used at the same time. Flow sensor (Q1) is placed at the common outlet of low-pressure O<sub>2</sub> and high-pressure O<sub>2</sub> to monitor O<sub>2</sub>. Room air enters the machine after passing through filter (F1) and HEPA filter (F2).

---

Turbine blower (Blower) inhales the room air and externally connected O<sub>2</sub> and outputs them to the rear end of the inspiratory limb after compression. The turbine blower module contains two levels of labyrinth, which are located in the upstream and downstream of the turbine blower respectively. Air and O<sub>2</sub> are inhaled by the turbine blower after going through the first level of labyrinth chamber (SD1). The mixed gas of Air and O<sub>2</sub> is then compressed by the turbine blower and enters the second level of labyrinth chamber (SD2). These two levels of labyrinth chamber mix Air and O<sub>2</sub> and reduce noise. The turbine blower motor has a thermal conductive metal piece which conducts heat for heat dissipation via a cooling fan.

The large-diameter inspiration valve (Insp. valve) controls inspiratory pressure or flow. This valve uses voice coil motor as the driving component. In case of power failure, the valve port is automatically sealed via spring preload. When the voice coil motor takes actions, the valve port opens. Different output flows or pressures are acquired by exerting different control currents to the voice coil motor.

The outlet of large-diameter inspiration valve is connected to flow sensor (Q2) which monitors the flow in the inspiratory limb. Flow sensor (Q2) is a hot-wire mass flow sensor which does not require calibration. O<sub>2</sub> sensor (OS) monitors O<sub>2</sub> volume percentage concentration in the inspiratory limb.

Check valve (CV2) prevents patient's expired gas from polluting the components in the upstream of this valve under the single fault condition of expiratory limb being occluded.

Safety valve (SV) ensures that the pressure in the inspiratory limb is kept within the safe range and provides flow to the spontaneous inspiratory channel when the system is powered down. It is controlled by electromagnet. When the ventilator is in normal working state, the electromagnet is powered on and the safety valve is in closed state. When the pressure in the inspiratory limb exceeds the system setting pressure, the electromagnet is powered down and the safety valve is opened to release excess pressure. When the system is powered down, the electromagnet is in power-down state and the safety valve is opened by default. The patient inhales the external gas through the spontaneous inspiratory channel.

The expiration valve assembly integrates the expiration valve (EV) and flow sensor (Q3). Q3 is a diaphragm differential pressure flow sensor. It monitors the front and rear pressure and Flow Calibration processes for calibration via the differential pressure sensor PQ3. PE is an expiratory pressure sensor which monitors the airway pressure. F9, F10 and F11 are filters which protect the upstream components from being polluted by the patient's expired gas. R2 and R3 are resistors which flush weak flow introduced to the expiration valve from the gas source, preventing water vapour condensation from occluding the pressure measurement tubes. CV3 is a check valve which prevents gas from flowing in the reverse direction.

---

F7 and F8 are bacteria filters. They are connected to the inspiration port and patient port when they are used by the ventilator. The nebulizer is pneumatic. The drive gas is introduced into the nebulizer via the nebulizer connector on the front panel; and the liquid medicine is nebulized, enters the inspiratory tube, and reaches the patient's lungs. The pneumatic nebulizer can be connected only when the machine is connected with high-pressure O2.

## A.2 Electrical System

### A.2.1 Electrical System Structure Diagram

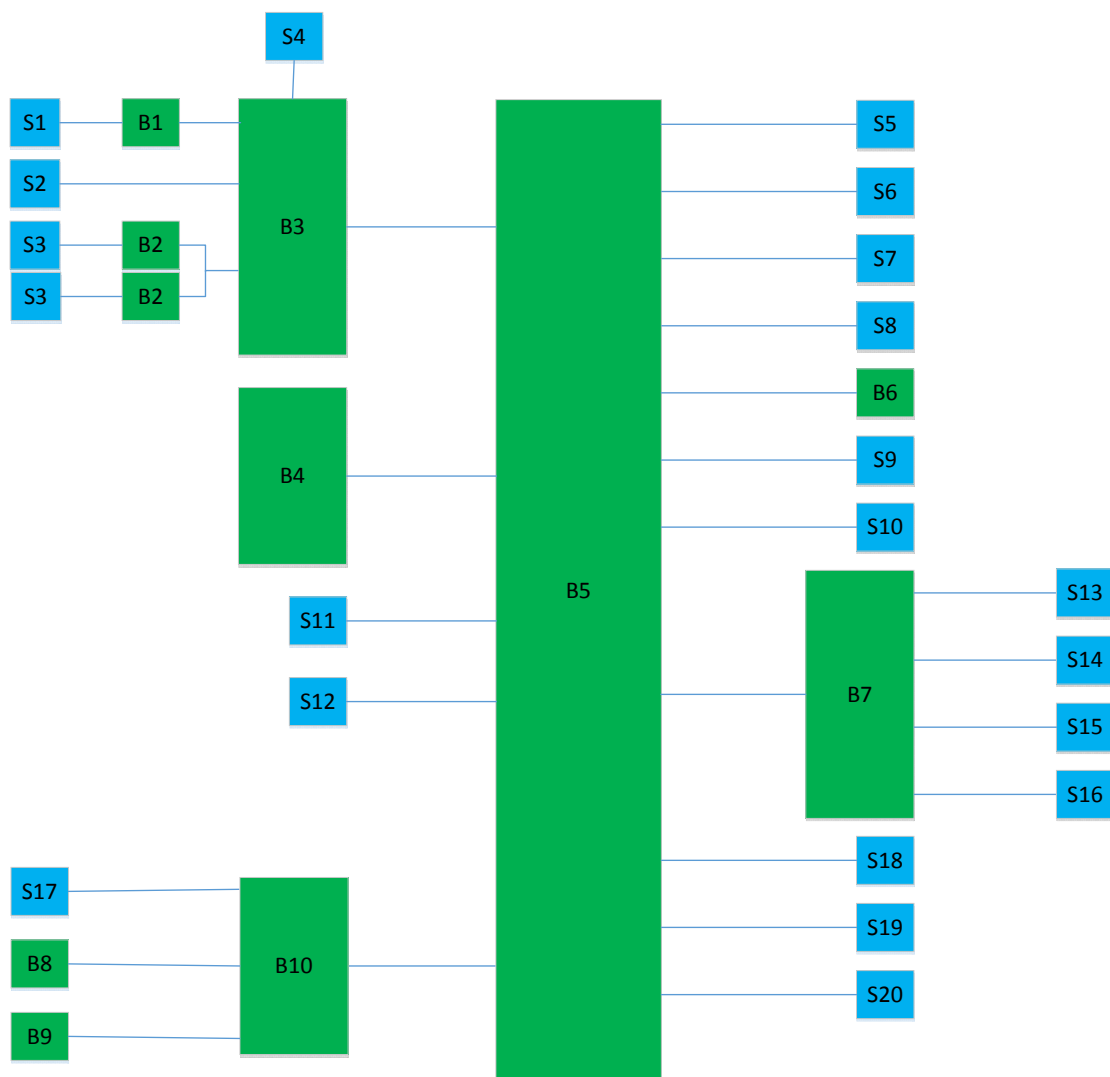

---

## A.2.2 Parts List

B1	AC-DC Power board	S6	Oxygen proportional valve
B2	Battery adapter board	S7	Turbine
B3	DC-DC Power board	S8	Temperature sensor
B4	Main control board	S9	Inspiration valve
B5	Monitoring module	S10	Expiration valve
B6	Vacuum sensor board	S11	Speaker
B7	Sensor adapter board	S12	Display
B8	Coder board	S13	O <sub>2</sub> sensor
B9	Alarm light board	S14	Oxygen flow sensor
B10	Key board	S15	Total flow sensor
S1	Total AC input and fuse	B16	Safety valve
S2	External DC-IN	S17	Touch screen
S3	Battery	S18	Sidestream CO <sub>2</sub> Module
S4	Radiator fan	S19	Mainstream CO <sub>2</sub> Module
S5	Nebulizing valve	S20	SpO <sub>2</sub> module



# B Product Specifications

---

---

The ventilator is already integrated with expiratory volume monitor, pressure measurement device, and pressure release device. It is equipped with alarm system, O<sub>2</sub> monitor, CO<sub>2</sub> monitor and SpO<sub>2</sub> monitor, where:

- The expiratory volume monitor, pressure measurement device, and pressure release device comply with ISO 80601-2-12 .
- The alarm system complies with IEC 60601-1-8.
- The O<sub>2</sub> monitor complies with ISO 80601-2-55.
- The CO<sub>2</sub> monitor complies with ISO 80601-2-55.
- The gas supply hose assembly complies with ISO 5359.
- The SpO<sub>2</sub> monitor complies with ISO 80601-2-61.

## B.1 Safety Specifications

Type of protection against electric shock	Class I equipment with internal electrical power supply.
Degree of protection against electric shock	BF, defibrillation-proof
Operating mode	Continuous
Degree of protection against hazards of explosion	Ordinary equipment, without protection against explosion; not for use with flammable anaesthetics.
Degree of protection against harmful ingress of water	Degrees of protection provided by enclosures(IP Code)—IP21 Protection Index according the EN 60529 standard: 2: Protected against solid foreign objects of 12.5 mm diameter and greater 1: Protected against vertically falling water drops
Electrical connections between the equipment and the patient	Non-electrical connections
Equipment type	Mobile

## B.2 Environmental Specifications

Main unit			
Item	Temperature (°C)	Relative humidity (non-condensing)	Barometric pressure (kPa)
Operating	5 to 40	10 to 95 %	62 to 106*
Storage and transport	-20 to +60 (O <sub>2</sub> sensor: -20 to +50)	10 to 95 %	50 to 106

The ventilator performance satisfies the specifications at barometric pressure 80 kPa to 106 kPa. The inspiration pressure of the ventilator can reach 60 cmH<sub>2</sub>O at barometric pressure 62 kPa to 80 kPa.

## B.3 Power Requirements

External AC power supply	
Input voltage	100 to 240 V
Input frequency	50/60 Hz
Input current	2.7 to 1.1A
Fuse	T3.15 AH/250 V
External DC power supply	
Input voltage	12 V
Input current	15A
Internal battery	
Number of batteries	One or two
Battery type	Lithium-ion battery
Rated battery voltage	14.8 VDC
Battery capacity	5800 mAh for a single battery
Overcurrent protection	8.2 ± 5 %A
Time to shutdown	10 min at least (powered by new fully-charged batteries after the first low battery alarm)
Battery run time	180 min (powered by one new fully-charged battery in standard working condition); 360 min (powered by two new fully-charged batteries in standard working condition).

The standard work condition is:

- Ventilation mode : P-A/C ;
- $\Delta P_{insp}$  : 10 cmH<sub>2</sub>O;
- f : 10 bpm ;

- T<sub>insp</sub> : 2 s ;
- O<sub>2</sub>% : 21 Vol.% ;
- PEEP : 5 cmH<sub>2</sub>O ;
- R: 20 cmH<sub>2</sub>O/L/s ;
- C: 20 ml/cmH<sub>2</sub>O ;
- Gas supply nominal work pressure : 400 ± 100 kPa.

## B.4 Physical Specifications

System noise	
System noise	A-weighted sound pressure level (L <sub>pA</sub> ) ≤45 dB(A) A-weighted sound power level (L <sub>WA</sub> ) ≤53 dB (A)
Main unit	
Dimensions	1365 mm × 526 mm × 544 mm (height × width × depth) (including the ventilator cart) 354 mm × 315 mm × 249 mm (height × width × depth) (excluding the ventilator cart)
Weight	Approximately 30 kg (including the ventilator cart) Approximately 10 kg (excluding the ventilator cart)
Caster	
Caster	4 casters. All casters have brakes.
Display	
Type	TFT LCD
Size	12.1"
Resolution	1280 x 800 pixels
Brightness	Adjustable
Touch screen	Available, anti-glare.
LED indicator	
Alarm LED	One (yellow and red. When high and medium priority alarms occur simultaneously, it flashes red only).
External power LED	One (green; lit when the external power supply is connected).
Battery LED	One (green; lit when batteries are installed and external power supply is connected; flashing when powered by batteries; extinguished when no batteries are installed or external power supply is not connected.)
Operating status LED	One, namely, power switch key background light (green; lit when powered on and extinguished when powered off).

<b>Audio indicator</b>	
Speaker	Gives off alarm tones and key tones; supports multi-level tone modulation. The alarm tones comply with the requirements of IEC60601-1-8.
Buzzer	Gives off auxiliary audio alarm in case of speaker malfunction.
<b>Connector</b>	
Network connector	A connector which supports connection with a PC to perform software upgrade and connection with external medical and information device.
RS-232 connector	Connects to the external calibration device for calibrating pressure. An external medical device can be connected via this connector to communicate with the ventilator.
USB connector	Exports captured screen, conducts ventilator software upgrade, configuration information export and history data (such as patient data, alarm log, calibration table) export, configuration transfer between machines of the same type via USB device.
Nurse call connector	Connects to the hospital's nurse call system.
VGA connector	Outputs VGA video signals with the same contents to the primary display and connects to the external display (supporting display with resolution of 1280*800).

## B.5 Pneumatic System Specifications

### NOTE

- All gas volume, flow and leakage specification are expressed at STPD except those associated with the VBS which are expressed at BTPS.

<b>High-pressure oxygen inlet</b>	
Gas type	O <sub>2</sub>
Pressure range	280 to 600 kPa
Rated flow requirement	No less than 120 L/min (STPD)
Connector	NIST or DISS
Fresh gas	Fresh gas is called after supplied Air and O <sub>2</sub> are mixed.
<b>Low-pressure oxygen inlet</b>	
Pressure range	Less than 100 kPa
Maximum flow	15 L/min(STPD)
Connector	CPC quick connector
<b>Inspiration module</b>	
Peak flow in case of single supply gas(air)	≥210 L/min(BTPS)

Pneumatic medicament nebulizer connector	Synchronous with inspiration at 6 to 9 L/min flow
Safety valve release pressure	<125 cmH <sub>2</sub> O
Inspiratory outlet (To patient port)	Coaxial 22 mm/15 mm conical connector
<b>Expiration module</b>	
Expiratory outlet (From patient port)	Coaxial 22 mm/15 mm conical connector
<b>System compliance and resistance</b>	
Compliance	<p>Adult disposable circuit (including inspiration safety valve, adult disposable patient tubing, water trap, expiration valve): ≤4 mL/cmH<sub>2</sub>O;</p> <p>Adult reusable circuit (including inspiration safety valve, adult reusable patient tubing, water trap, expiration valve, Y piece): ≤2 mL/cmH<sub>2</sub>O;</p> <p>Pediatric disposable circuit (including inspiration safety valve, pediatric disposable patient tubing, water trap, expiration valve): ≤2 mL/cmH<sub>2</sub>O;</p> <p>Pediatric reusable circuit (including inspiration safety valve, pediatric reusable patient tubing, water trap, expiration valve, Y piece): ≤2 mL/cmH<sub>2</sub>O;</p> <p>Infant reusable circuit (including inspiration safety valve, infant reusable patient tubing, water trap, expiration valve, Y piece): ≤1 mL/cmH<sub>2</sub>O.</p>
Inspiratory resistance	<p>Not greater than 6 cm H<sub>2</sub>O at 60 L/min flow (adult reusable patient tubing)</p> <p>Not greater than 6 cmH<sub>2</sub>O at 30 L/min flow (pediatric reusable patient tubing)</p> <p>Not greater than 6 cmH<sub>2</sub>O at 5 L/min flow (infant reusable patient tubing)</p>
Expiratory resistance	<p>Not greater than 6 cmH<sub>2</sub>O at 60 L/min flow (adult reusable patient tubing)</p> <p>Not greater than 6 cmH<sub>2</sub>O at 30 L/min flow (pediatric reusable patient tubing)</p> <p>Not greater than 6 cmH<sub>2</sub>O at 5 L/min flow (infant reusable patient tubing)</p>
Bacterial filter	<p>Resistance: &lt; 2 cmH<sub>2</sub>O at 60 L/min</p> <p>Particle size: Captures particles of 0.3 mm (micron) with &gt; 99.99% efficiency</p> <p>Dead space: &lt; 80 mL</p>

Leakage	
Leakage	Not greater than 200 mL/min@50 cmH <sub>2</sub> O (adult tubes) Not greater than 100 mL/min@40 cmH <sub>2</sub> O (pediatric tubes) Not greater than 50 mL/min@20 cmH <sub>2</sub> O (infant tubes)

## B.6 Ventilator Specifications

Controlled parameters			
Parameter	Range	Step	Unit
O <sub>2</sub> %	21 to 100	1	Vol. %
TV	Adult: 100 to 2000(BTPS) Pediatric: 20 to 300(BTPS)	Adult: 10 Pediatric: 1	mL
f	1 to 100	1	bpm
fsimv	1 to 60	1	bpm
T <sub>insp</sub>	0.20 to 10.00	0.05	s
I:E	4:1 to 1:10	0.5	/
T <sub>slope</sub>	0.00 to 2.00	0.05	s
T <sub>pause</sub> (%)	OFF, 5 to 60	5	%
PEEP	OFF, 1 to 45	1	cmH <sub>2</sub> O
△P <sub>insp</sub>	5 to 80	1	cmH <sub>2</sub> O
△P <sub>supp</sub>	0 to 80	1	cmH <sub>2</sub> O
P <sub>high</sub>	0 to 80	1	cmH <sub>2</sub> O
P <sub>low</sub>	0 to 45	1	cmH <sub>2</sub> O
T <sub>high</sub>	0.2 to 30.0	0.1	s
T <sub>low</sub>	0.2 to 30.0	0.1	s
Trigger	0.5 to 15.0	0.1	L/min
	-10.0 to -0.5	0.5	cmH <sub>2</sub> O
Assist	ON, OFF	/	/
△int.PEEP	OFF, 1 to 45	1	cmH <sub>2</sub> O
Exp%	Auto, 10 to 85	5	%
△P <sub>apnea</sub>	Provides pressure apnea setting. Refer to △P <sub>insp</sub> specification.		
f <sub>apnea</sub>	1 to 80	1	bpm
TV <sub>apnea</sub>	Adult: 100 to 2000 (BTPS) Pediatric: 20 to 300 (BTPS)	Adult: 10 Pediatric: 1	mL
Apnea T <sub>insp</sub>	0.20 to 10.00	0.05	s
MV%	25 to 350	1	%
Tube I.D.	Adult: 5.0 to 12.0	0.5	mm

	Pediatric: 2.5 to 8.0		
Compensate	0 to 100	1	%
Interval	20s to 180min	20s to 59s:1s 1min to 180min:1min	/
Cycles Sigh	1 to 20	1	/
<b>Controlled parameters (O<sub>2</sub> Therapy)</b>			
Continuous Flow	2 to 60	1	L/min
O <sub>2</sub> Concentration	21 to 100	1	Vol.%
<b>Weight</b>			
Pediatric	3 to 35	0.1	kg
Adult	10 to 200	1	kg
<b>Monitored parameters</b>			
<b>Parameter</b>	<b>Range</b>	<b>Resolution</b>	<b>Unit</b>
Ppeak	0 to 120	1	cmH <sub>2</sub> O
Pplat			
Pmean			
PEEP	0 to 120	1	cmH <sub>2</sub> O
TVi	0 to 4000 (BTPS)	1	mL
TVe			
TVe spn			
MV	0.0 to 100.0 (BTPS)	0.1	L/min
MVspn			
MVleak			
ftotal	0 to 200	1	bpm
fmand			
fspn			
Rinsp	0 to 600	1	cmH <sub>2</sub> O/(L/s)
Rexp	0 to 600	1	cmH <sub>2</sub> O/(L/s)
Cstat	0 to 300	1	mL/cm H <sub>2</sub> O
Cdyn	0 to 300	1	mL/cm H <sub>2</sub> O
RSBI	0 to 999	1	1/(L•min)
WOB	0.0 to 100.0	0.1	J/min
NIF	-45.0 to 0.0	1	cmH <sub>2</sub> O
P0.1	-20.0 to 0.0	0.1	cmH <sub>2</sub> O
PEEPi	0 to 80	0.1	cmH <sub>2</sub> O
FiO <sub>2</sub>	15 to 100	1	Vol.%

RCexp	0.0 to 10.0	0.1	s
TVe/IBW	0 to 50	0.1	mL/kg
Tinsp	0.00 to 60.00	0.01	s
I:E	100:1 to 1:150	0.1	/
<b>Monitored parameters (O<sub>2</sub> Therapy)</b>			
Continuous Flow	0 to 100	1	L/min
O <sub>2</sub> Concentration	15 to 100	1	Vol.%

## B.7 Ventilator Accuracy

<b>Control accuracy</b>	
O <sub>2</sub> %	± (3 Vol.% + 1% of setting)
TV	± (10 mL + 10% of setting) (BTPS)
f	±1 bpm
fsimv	±1 bpm
Tinsp	±0.1 s or ±10 % of setting, whichever is greater
I: E	2: 1 to 1: 4: ±10 % of setting Other range: ±15 % of setting
Tslope	± (0.2 s + 20 % of setting)
PEEP	± (2.0 cmH <sub>2</sub> O + 5 % of setting)
△Pinsp	± (2.0 cmH <sub>2</sub> O + 5 % of setting)
△Psupp	± (2.0 cmH <sub>2</sub> O + 5 % of setting)
Phigh	± (2.0 cmH <sub>2</sub> O + 5 % of setting)
Plow	± (2.0 cmH <sub>2</sub> O + 5 % of setting)
Thigh	± 0.2 s or ±10 % of setting, whichever is greater
Tlow	± 0.2 s or ±10 % of setting, whichever is greater
Trigger	± (1.0 cmH <sub>2</sub> O + 10 % of setting) ± (1.0 L/min + 10 % of setting)
△int.PEEP	± (2.0 cmH <sub>2</sub> O + 5 % of setting)
Exp%	± 10 %
fapnea	± 1 bpm
△Papnea	± (2.0 cmH <sub>2</sub> O + 5 % of setting)
TVapnea	± (10 mL + 10 % of setting) (BTPS)
Apnea Tinsp	± 0.1 s or ±10 % of setting, whichever is greater
Tpause(%)	± 0.1 s or ±10 % of setting, whichever is greater
MV%	±10% (absolute error) or ± 10% of set value, whichever is greater



<b>Control accuracy (O<sub>2</sub> Therapy)</b>	
Continuous Flow	± (2 L/min+10 % of setting) (BTPS)
O <sub>2</sub> Concentration	± (3 Vol.% +1 % of setting)
<b>Monitoring accuracy</b>	
Ppeak	± (2 cmH <sub>2</sub> O + 4 % of the actual reading)
Pplat	
Pmean	
PEEP	
TVi	0 mL~100 mL: ± (10 mL + 3 % of the actual reading) (BTPS); 100 mL~4000 mL: ± (3 mL + 10 % of the actual reading) (BTPS)
TVe	
TVe/IBW	
TVe spn	
MV	± (0.2 L/min + 10 % of the actual reading) (BTPS)
MVspn	
MVleak	
ftotal	±5 % of reading or ±1 bpm, whichever is greater
fmand	
fspn	
Rinsp	0 to 20: ±10 cmH <sub>2</sub> O/(L/s)
Rexp	Other range: 50%.
Cstat	± (2 mL/cmH <sub>2</sub> O + 20 % of the actual reading)
Cdyn	
RSBI	± (3 1/(L•min))+15 % of the actual reading)
WOB	± (1 J/min+15 % of the actual reading)
NIF	± (2 cmH <sub>2</sub> O + 4 % of the actual reading)
P0.1	± (2 cmH <sub>2</sub> O + 4 % of the actual reading)
PEEPi	No declaration
RCexp	± (0.2 s + 20 % of the actual reading)
FiO <sub>2</sub>	± (2.5 Vol. % + 2.5 % of the actual reading)
Tinsp	± 0.05 s
I:E	±50 ms or ±6%, whichever is greater.
Oxygen concentration controlling response time	the responded time of the oxygen concentration in the delivered volume to change from a volume fraction of 21 % to 90 % of the maximum settable oxygen concentration: when TV=500 mL, f=10 bpm, I:E=1:2, ≤90 s ; when TV=150 mL, f=20 bpm, I:E=1:2, ≤120 s ; when TV=30 mL, f=30 bpm, I:E=1:2, ≤90 s.

Monitoring accuracy (O <sub>2</sub> Therapy)	
Continuous Flow	± (2 L/min+ 10 % of the actual reading)(BTPS)
O <sub>2</sub> Concentration	± (2.5 Vol. % + 2.5% of the actual reading)

## B.8 Alarms

### B.8.1 Settable Alarms

Alarm settings				
Parameter		Setting range	Automatic threshold	Notes
TV	High limit	110 to 4000 mL, OFF (Adult) 25 to 600mL, OFF (Pediatric)	1.5 × TVE average value	High limit is greater than low limit.
	Low limit	50 to 4000 mL, OFF (Adult) 10 to 600mL, OFF (Pediatric)	0.5 × TVE average value	
MV	High limit	Pediatric: 0.2 to 60.0 L/min Adult: 0.2 to 100.0 L/min	1.5 × MV monitored value	
	Low limit	Pediatric: 0.1 to 30.0 L/min Adult: 0.1 to 50.0 L/min	0.6 × MV monitored value	
FiO <sub>2</sub>	High limit	Low-pressure oxygen: 20 Vol.% to 100 Vol.%	100 Vol.%	
	Low limit	Low-pressure oxygen: 18 Vol.% to 98 Vol.%	21 Vol.%	
Paw	High limit	10 to 85 cmH <sub>2</sub> O	Average peak pressure+10 cmH <sub>2</sub> O or 35 cmH <sub>2</sub> O, whichever is greater	/
f <sub>total</sub>	High limit	1 to 150, OFF	1.4 × f <sub>total</sub> monitored value	/
Tapnea		5 to 60s	15	/

## B.8.2 Internal Alarms

Parameter		Alarming condition
FiO <sub>2</sub>	High limit	High-pressure oxygen: FiO <sub>2</sub> exceeds the alarm limit for at least 30s. Internally set alarm limit: min (Set value + max (7 Vol.% or set value x 10%), 100 Vol.%).
	Low limit	High-pressure oxygen: FiO <sub>2</sub> is lower than the alarm limit for at least 30s. Internally set alarm limit: max (18 Vol.%, set value - max (7 Vol.% , set value x 10%)). Absolute FiO <sub>2</sub> low limit: 18 Vol.%
Sustained Airway Pressure		Internally set alarm limit: PEEP+15 cmH <sub>2</sub> O The alarm limit is exceeded for 15 s continuously.

## B.9 Special Functions

Function	Specification
Inspiration Hold	Push and hold the Insp. Hold key to activate this function. Inspiration Hold is active for a maximum of 30s.
Expiration Hold	Push and hold the Exp. Hold key to activate this function. Expiration Hold is active for a maximum of 30s.
O <sub>2</sub> ↑	O <sub>2</sub> ↑ is delivered for a fixed 2 min. During O <sub>2</sub> ↑ , O <sub>2</sub> concentration for adult patients is 100% and that for pediatric patients is 1.25 times of the currently set O <sub>2</sub> concentration or 100%, whichever is less.
Suction	Phase 1: O <sub>2</sub> ↑ before suction. Delivering 100% O <sub>2</sub> lasts for a maximum of 120 s. O <sub>2</sub> concentration for adult patients is 100% and that for pediatric patients is 1.25 times of the currently set O <sub>2</sub> concentration or 100%, whichever is less. When patient disconnection is detected, the system enters next phase automatically. Phase 2: suction. Suction lasts for a maximum of 120s. When patient reconnection is detected, the system enters next phase automatically. Phase 3: O <sub>2</sub> ↑ after suction. Delivering 100% O <sub>2</sub> lasts for a maximum of 120s. O <sub>2</sub> concentration for adult patients is 100% and that for pediatric patients is 1.25 times of the currently set O <sub>2</sub> concentration or 100%, whichever is less.
Nebulizer	Supports jet nebulizer; Supports to set nebulizer time ranging from 1 to 60 min.
Manual Breath	One breath is delivered in the expiratory stage. Manual breath is not responded if one breath is delivered in the inspiratory stage or when the expiratory stage is not finished.
P0.1	The pressure drop in the first 100 ms when the patient starts spontaneous breathing.

Function	Specification
NIF	Maximum negative pressure produced by patient's spontaneous breathing within a period of time.
PEEPi	The PEEPi measure function supports measurement of two parameters: PEEPi and Vtrap. PEEPi is the positive end-expiratory pressure produced by the trapped gas and Vtrap is the trapped gas volume.
P-V	By drawing static pressure-volume loop (static P-V loop), P-V tool is the method to determine the optimal PEEP based on the characteristic points on the static P-V loop.
ATRC	ATRC stands for the function of automatic tube resistance compensation. By selecting appropriate endotracheal (ET) tube or tracheostomy (Trach) tube of different diameters for the user, the ventilator can adjust gas delivery pressure automatically.
Sigh	<p>The sigh function is used to open collapsed areas of the lung or to keep the lung open.</p> <p>The sigh function can be activated in all ventilation modes except CPAP/PSV, DuoLevel, and APRV.</p> <p>Each time after the sigh function is activated, ventilation is controlled based on the user-set sigh ventilation cycles and the set value of <math>\Delta</math>int.PEEP. PEEP of the sigh ventilation cycle increases <math>\Delta</math>int.PEEP level. After that, sigh is automatically switched off until next sigh time interval.</p>
Screen Locking	Prevents ventilator settings and values displayed from being changed due to inadvertent key clicking.
O <sub>2</sub> Therapy	Continuous flow application with adjustable O <sub>2</sub> concentration and flow for patients with independent breathing and using oxygen masks.

## B.10 CO<sub>2</sub> Module Specifications

### B.10.1 Sidestream CO<sub>2</sub> Module

CO <sub>2</sub> module		
Measurement range and accuracy	Measurement range	Accuracy
	0 to 40 mmHg	±2 mmHg
	41 to 76 mmHg	±5 % of the actual reading
	77 to 99 mmHg	±10 % of the actual reading
Measurement accuracy drift	According to the test method of the standard ISO 80601-2-55, the module meets the requirement for measurement accuracy in this table.	
Resolution	1 mmHg	
Rise time	Adult water trap: <400 ms@70 mL/min <330 ms@100 mL/min <300 ms@120 mL/min <240 ms@150 mL/min Neonatal water trap: <400 ms@70 mL/min <330 ms@100 mL/min	
Total system response time	Using neonatal water trap, neonatal sampling line: <7.5 s @ 100 mL/min <8 s @ 70 mL/min Using adult water trap, adult sampling line: <7.5 s @ 150 mL/min <8 s @ 120 mL/min <8.5 s @ 100 mL/min <9.5 s @ 70 mL/min	
Pump rate	Adult: 70 mL/min, 100 mL/min, 120 mL/min and 150 mL/min optional. Pediatric: 70 mL/min and 100 mL/min optional. The flow control accuracy is ±15 % of the set value or ±15 mL/min, whichever is greater.	
Water trap cleaning time	Adult water trap: ≥24 h@150 mL/min ≥48 h@70 mL/min Neonatal water trap: ≥24 h@100 mL/min ≥48 h @70 mL/min	

Sidestream CO <sub>2</sub> alarm limits	Range	Step
EtCO <sub>2</sub> high limit	2 to 99 mmHg	1 mmHg
EtCO <sub>2</sub> low limit	0 to 97 mmHg	

Sidestream CO <sub>2</sub> environmental specifications			
Item	Temperature (°C)	Relative humidity (non-condensing)	Barometric pressure (kPa)
Operating	5 to 40	10 to 95 %	70 to 106
Storage and transport	-20 to +60	10 to 95 %	50 to 106

## B.10.2 Mainstream CO<sub>2</sub> Module

CO <sub>2</sub> module			
Measurement range and accuracy	Measurement range	Accuracy	
	0 to 40 mmHg	±2 mmHg	
	41 to 70 mmHg	±5 % of the actual reading	
	71 to 100 mmHg	±8 % of the actual reading	
	101 to 150 mmHg	±10 % of the actual reading	
Measurement accuracy drift	According to the test method of the standard ISO 80601-2-55, the module meets the requirement for measurement accuracy in this table.		
Resolution	1 mmHg		
Monitored parameters	<b>Parameters</b>	<b>Range</b>	<b>Resolution</b>
	slopeCO <sub>2</sub>	0 to 9.99 % /L	0.01 % /L
	V <sub>talv</sub>	0 to 9999 mL	1 mL
	V <sub>'alv</sub>	0 to 20 L/min	0.01 L/min for < 1 L/min 0.1 L/min for ≥ 1 L/min
	V <sub>'CO<sub>2</sub></sub>	0 to 9999 mL /min	1 mL/min
	V <sub>daw</sub>	0 to 999 mL	1 mL
	V <sub>daw</sub> /T <sub>Ve</sub>	0 to 100 %	1 %
	V <sub>eCO<sub>2</sub></sub>	0 to 999 mL	1 mL
	V <sub>iCO<sub>2</sub></sub>	0 to 999 mL	1 mL
Total system response time	<2.0 s		

Mainstream CO <sub>2</sub> alarm limits	Range	Step
EtCO <sub>2</sub> high limit	2 to 150 mmHg	1 mmHg
EtCO <sub>2</sub> low limit	0 to 148 mmHg	

Mainstream CO <sub>2</sub> environmental specifications			
Item	Temperature (°C)	Relative humidity (non-condensing)	Barometric pressure (kPa)
Operating	10 to 40	10 to 90 %	62 to 106
Storage and transport	-10 to +55	10 to 90 %	50 to 106

## B.11 SpO<sub>2</sub> Module Specifications

SpO <sub>2</sub> Module				
*Measurement accuracy verification: The SpO <sub>2</sub> accuracy has been verified in human experiments by comparing with arterial blood sample reference measured with a CO-oximeter. Pulse oximeter measurements are statistically distributed and about two-thirds of the measurements are expected to come within the specified accuracy range compared to CO-oximeter measurements.				
Measurement range	0 to 100 %			
Resolution	1 %			
Accuracy	70 % to 100 %: ± 2 % (measured without motion in adult/pediatric mode) 0 % to 69 %: Not specified.			
Data update period	≤30 s			
*Studies were performed to validate the accuracy of Pulse Oximeter with SpO <sub>2</sub> sensors by contrast with a CO-Oximeter. The statistical analysis of data of this study shows the accuracy (Arms) is within the stated accuracy specification. Please see the following table.				
Sensor type	Total	Data	Arms	
512F (adult, finger type, reusable)	10 (4 male&6 female)	200 pairs	1.91 %	
512H (pediatric, finger type, reusable)	10 (0 male&10 female)	200 pairs	1.95 %	
Skin color	Gender	Number	Age(years)	Health
Black	Male	1	26 ± 3.14	Healthy
	Female	1		
Yellow	Male	3		
	Female	9		

PR	
Measurement range	20 to 254 1/min
Resolution	1 1/min
Accuracy	$\pm 3$ 1/min
Data update period	$\leq 30$ s
PI	
measurement range	0.05 %~20 %
Resolution	0.05 ~ 9.99 %: 0.01 % 10.0 ~ 20.0 %: 0.1 %

SpO <sub>2</sub> alarm limits	Range	Step
SpO <sub>2</sub> high limit	2 to 100 %	1 %
SpO <sub>2</sub> low limit	0 to 98 %	
Desat limit	0 to 98 %	

PR alarm limit	Range	Step
PR high limit	17 to 300 1/min	1 1/min
PR low limit	15 to 298 1/min	

## B.12 O<sub>2</sub> Sensor Specifications

O <sub>2</sub> sensor	
Output	9 to 13 mV at 210 hPa O <sub>2</sub>
Range	0 to 1500 hPa O <sub>2</sub>
100% O <sub>2</sub> signal deviation	100 $\pm$ 1 %
Resolution	1 hPa O <sub>2</sub>
Expected service life	1.5 x 10 <sup>6</sup> % for measurement (20 °C) 0.8 x 10 <sup>6</sup> % for measurement (40 °C)
Response time (21 % air to 100 % O <sub>2</sub> )	<15 s
Linearity	Linear 0-100 % O <sub>2</sub>
Operating temperature range	-20 °C to +50 °C
Temperature compensation	$\pm 2$ % of fluctuation at 0 to 40 °C
Pressure range	50 to 200 kPa
Relative humidity	0 to 99%
100% O <sub>2</sub> concentration output drift	Over one year of typical value <5%
Material	White ABS
Packaging	Sealed package
Period of validity	Not more than 13 months after unpacked (in compliance with the conditions specified by the manufacturer)



Effect of interfering gas	
Gas under test	Error (%O <sub>2</sub> )
50% He/50% O <sub>2</sub>	<1 %
80% N <sub>2</sub> O/20% O <sub>2</sub>	1 % to 1.5 %
4% Halothane/28.8% O <sub>2</sub> /67.2% N <sub>2</sub> O	1.5 % to 2 %
5% Sevoflurane/28.5% O <sub>2</sub> / 66.5% N <sub>2</sub> O	1 % to 1.5 %
5% Enflurane/28.5% O <sub>2</sub> /66.5% N <sub>2</sub> O	1.2 % to 1.8 %
5% Isoflurane/28.5% O <sub>2</sub> /66.5% N <sub>2</sub> O	1.2 % to 1.8 %
5% CO <sub>2</sub> / 28.5% O <sub>2</sub> /66.5% N <sub>2</sub> O	<1 %

**Theory of Operation**

O<sub>2</sub> sensor can monitor the patient's FiO<sub>2</sub>. O<sub>2</sub> sensor is of the self-powered, diffusion limited, metal-air battery type comprising an anode, electrolyte, diffusion barrier and air cathode as shown below:

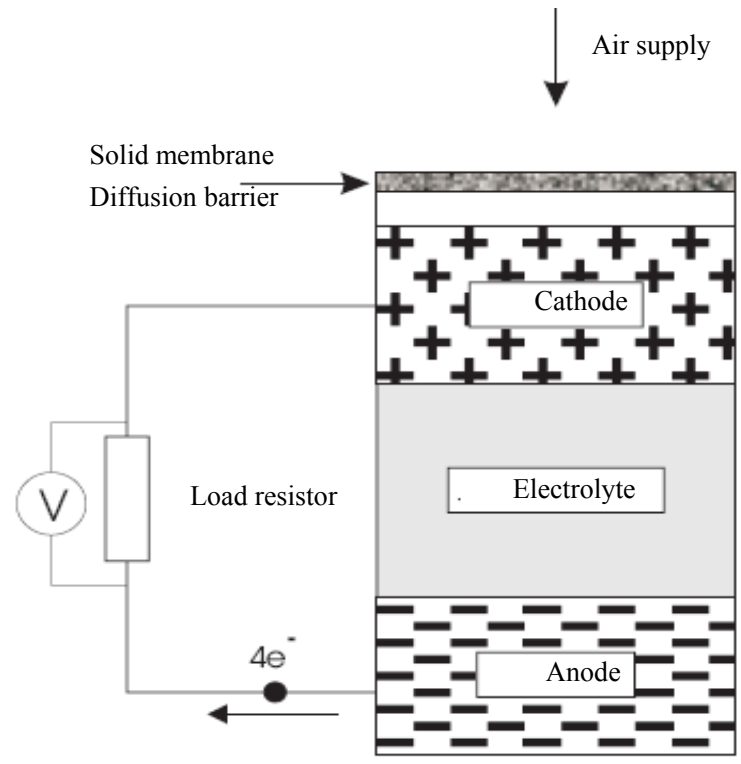

At the cathode oxygen is reduced to hydroxyl ions according to the equation:

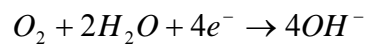

The hydroxyl ions in turn oxidise the metal anode as follows:

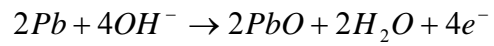

Overall the cell reaction may be represented as:

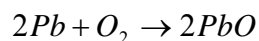

O<sub>2</sub> sensor is current generator, and the current is proportional to the rate of oxygen consumption (Faraday's Law). This current can be measured by connecting a resistor across the output terminals to produce a voltage signal. If the passage of oxygen into the sensor is purely diffusion limited, by the solid membrane diffusion barrier, then this signal is a representation of the oxygen partial pressure.

#### **Signal Stability**

O<sub>2</sub> sensor has highly stable outputs over their operating lives. Typical sensor drift rates are less than 1% per month when O<sub>2</sub> sensor is exposed to gas in typical applications. Thus a sensor with a starting signal of 12mV in 210mBar oxygen will typically still be showing a signal greater than 10mV as it approaches the end of its life.

#### **Humidity Effects**

Under conditions where liquid condensation may occur, care is needed to ensure the gas access holes do not become blocked. If liquids form in the region of the gas access hole, the flow of gas to the sensor will be restricted. With gas access restricted, a low signal will result. If a sensor shows signs of being affected by condensation, normal operation may be restored by drying the sensor with a soft tissue. Under no circumstances should these sensors be heated to dry them out. Changes in humidity levels which affect the O<sub>2</sub> partial pressure will correspondingly alter the output signal of the sensor.

#### **Pressure Effects**

Since the sensor measures O<sub>2</sub> partial pressure, the output will rise and fall due to pressure changes which affect the O<sub>2</sub> partial pressure. Thus an increase in pressure of 10% at the sensor inlet will produce a 10% increase in signal output. Nitrous oxide is highly soluble in neutral and alkaline solutions. Where the sensor is exposed to high levels of nitrous oxide, the solubility of this gas can in fact cause the internal pressure to increase to the point where the seals fail. O<sub>2</sub> sensor incorporates a patented pressure relief system in the rear of the sensor, limiting the internal pressure build up due to N<sub>2</sub>O dissolving in the electrolyte to a figure well within the capacity of the sealing system. Test data shows that sensors are unaffected by months of operation in 100% N<sub>2</sub>O. Cross-interference tests with 10% CO<sub>2</sub> (balance O<sub>2</sub>) show virtually no interference from CO<sub>2</sub>.

#### **Temperature Dependence**

The rugged design of O<sub>2</sub> sensor means it is resistant to damage from extremes of high or low temperature. Even so, the sensor must never be exposed to temperatures at which the electrolyte will freeze (approx. -25°C), or temperatures which will harm the components of the sensor, i.e. The plastic or seals (>70°C). Sensor lifetime is governed by the mass of lead available to react with oxygen and its rate of consumption. High oxygen partial pressures and high temperatures will increase the sensor output current, thus shortening the operating life.

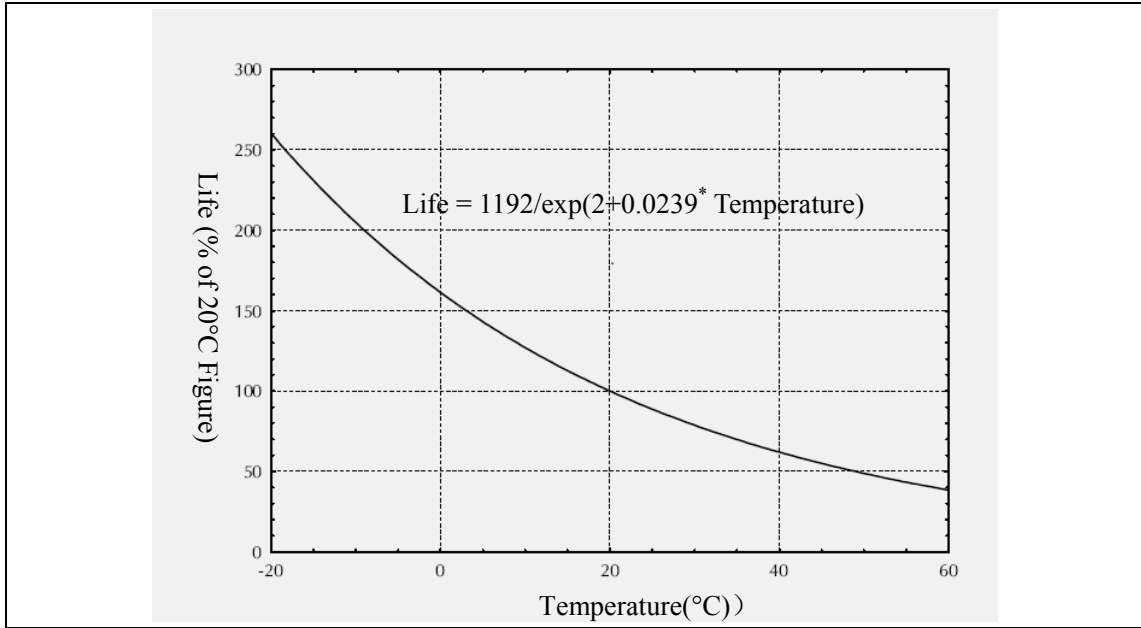

---

**FOR YOUR NOTES**

# C EMC

---

---

This equipment is in compliance with IEC 60601-1-2: 2014 for EMC.

The essential performance verified during the immunity testing comprise of TVi control accuracy, TVi monitoring accuracy, CO<sub>2</sub> monitoring accuracy, O<sub>2</sub> control accuracy, O<sub>2</sub> monitoring accuracy, PEEP control accuracy, PEEP monitoring accuracy, and SpO<sub>2</sub> monitoring accuracy.

## NOTE

---

- **Using accessories other than those specified may result in increased electromagnetic emission or decreased electromagnetic immunity of the equipment.**
  - **The ventilator or its components should not be used adjacent to or stacked with other equipment. If adjacent or stacked use is necessary, the ventilator or its components should be observed to verify normal operation in the configuration in which it will be used.**
  - **The ventilator needs special precautions regarding EMC and needs to be installed and put into service according to the EMC information provided below.**
  - **Use of portable or mobile communications devices can degrade the performance of the equipment.**
- 

## WARNING

---

- **Use of accessories, transducers and cables other than those specified or provided by the manufacturer of this equipment could result in increased electromagnetic emissions or decreased electromagnetic immunity of this equipment and result in improper operation.**
  - **Use of this equipment adjacent to or stacked with other device should be avoided because it could result in improper operation. If such use is necessary, this equipment and the other device should be observed to verify that they are operating normally**
  - **Portable RF communications equipment (including peripherals such as antenna cables and external antennas) should be used no closer than 30 cm (12 inches) to any part of the this equipment, including cables specified by the manufacturer. Otherwise, degradation of the performance of this equipment could result.**
  - **Other devices may interfere with this equipment even though they meet the requirements of CISPR.**
  - **When the input signal is below the minimum amplitude provided in technical specifications, erroneous measurements could result.**
-

<b>Guidance and manufacture's declaration - electromagnetic emissions</b>		
This equipment is intended for use in the electromagnetic environment specified below. The customer or the user of this equipment should assure that it is used in such an environment.		
<b>Emissions test</b>	<b>Compliance</b>	<b>Electromagnetic environment - guidance</b>
RF emissions CISPR 11	Group 1	This equipment uses RF energy only for its internal function. Therefore, its RF emissions are very low and are not likely to cause any interference in nearby electronic equipment.
RF emissions CISPR 11	Class B	This equipment is suitable for use in all establishments, including domestic establishments and those directly connected to the public low-voltage power supply network that supplies buildings used for domestic purposes.
Harmonic emissions IEC 61000-3-2	Class A	
Voltage fluctuations/flicker emissions IEC 61000-3-3	Complies	

<b>Guidance and manufacture's declaration - electromagnetic immunity</b>			
This equipment is suitable for use in the electromagnetic environment specified below. The customer or the user of this equipment should assure that it is used in such an environment.			
<b>IMMUNITY test</b>	<b>IEC 60601 test level</b>	<b>Compliance level</b>	<b>Electromagnetic environment - guidance</b>
Electrostatic discharge (ESD) IEC 61000-4-2	±8 kV contact ±15kV air	±8 kV contact ±15kV air	Floors should be wood, concrete or ceramic tile. If floors are covered with synthetic material, the relative humidity should be at least 30%.
Electrical fast transient/burst IEC 61000-4-4	±2 kV for power supply lines ±1 kV for input/output lines (length greater than 3 m)	±2 kV for power supply lines ±1 kV for input/output lines (length greater than 3 m)	Mains power quality should be that of a typical commercial or hospital environment.
Surge IEC 61000-4-5	±1 kV line(s) to line(s) ±2 kV line(s) to earth	±1 kV line(s) to line(s) ±2 kV line(s) to earth	Mains power quality should be that of a typical commercial or hospital environment.
Voltage dips and Voltage interruptions IEC 61000-4-11	0 % $U_T$ for 0.5 cycle  0 % $U_T$ for 1 cycle and 70 % $U_T$ for 25/30 cycles  0 % $U_T$ for 250/300 cycle	0 % $U_T$ for 0.5 cycle  0 % $U_T$ for 1 cycle and 70 % $U_T$ for 25/30 cycles  0 % $U_T$ for 250/300 cycle	Mains power quality should be that of a typical commercial or hospital environment. If the user of our product requires continued operation during power mains interruptions, it is recommended that our product be powered from an uninterruptible power supply or a battery.
RATED power frequency magnetic fields IEC 61000-4-8	30 A/m	30 A/m	Power frequency magnetic fields should be at levels characteristic of a typical location in a typical commercial or hospital environment.
Note: $U_T$ is the AC. mains voltage prior to application of the test level.			

<b>Guidance and Declaration - Electromagnetic Immunity</b>			
This equipment is suitable for use in the electromagnetic environment specified below. The customer or the user of this equipment should assure that it is used in such an environment.			
<b>Immunity test</b>	<b>IEC 60601 Test level</b>	<b>Compliance level</b>	<b>Electromagnetic environment - guidance</b>
Conducted RF IEC 61000-4-6	3 Vrms 150k to 80 MHz	3 Vrms (V1)	Portable and mobile RF communications equipment should be used no closer to any part of the device, including cables, than the recommended separation distance calculated from the equation applicable to the frequency of the transmitter.
	6 Vrms in ISM bands and amateur radio bands <sup>a</sup> between 0.15 MHz and 80 MHz	6 Vrms (V2)	
Radiated RF EM fields IEC 61000-4-3	3V/m 80 MHz to 2.7 GHz (for RGM, SpO <sub>2</sub> performance)	3 V/m (E1)	Recommended separation distance: $d = \left[ \frac{3.5}{V1} \right] \sqrt{P}$ 150kHz to 80 MHz $d = \left[ \frac{3.5}{E1} \right] \sqrt{P}$ 80 MHz to 800 MHz $d = \left[ \frac{7}{E1} \right] \sqrt{P}$ 800 MHz to 2.7 GHz
	10V/m 80 MHz to 2.7 GHz (for ventilator function)	10 V/m	
Proximity fields from RF wireless communications equipment IEC61000-4-3	27 V/m 380 MHz to 390 MHz	27 V/m	where P is the maximum output power rating of the transmitter in watts (W) according to the transmitter manufacturer and d is the recommended separation distance in meters (m) <sup>b</sup> . Field strengths from fixed RF transmitters, as determined by an electromagnetic site survey <sup>c</sup> , should be less than the compliance level in each frequency range <sup>d</sup> . Interference may occur in the vicinity of equipment marked with the following symbol: 
	28 V/m 430 MHz to 470 MHz, 800 MHz to 960 MHz, 1700 MHz to 1990 MHz, 2400 MHz to 2570 MHz	28 V/m	
	9 V/m 704 MHz to 787 MHz, 5100 MHz to 5800 MHz	9 V/m	
Note 1: At 80 MHz and 800 MHz, the higher frequency range applies.			
Note 2: These guidelines may not apply in all situations. Electromagnetic propagation is affected by absorption and reflection from structures, objects and people.			



---

a. The ISM (industrial, scientific, and medical) bands between 150 kHz and 80 MHz are 6.765 MHz to 6.795 MHz; 13.553 MHz to 13.567 MHz; 26.957 MHz to 27.283 MHz; and 40.66 MHz to 40.70 MHz. The amateur radio bands between 0.15 MHz and 80 MHz are 1.8 MHz to 2.0 MHz, 3.5 MHz to 4.0 MHz, 5.3 MHz to 5.4 MHz, 7 MHz to 7.3 MHz, 10.1 MHz to 10.15 MHz, 14 MHz to 14.2 MHz, 18.07 MHz to 18.17 MHz, 21.0 MHz to 21.4 MHz, 24.89 MHz to 24.99 MHz, 28.0 MHz to 29.7 MHz and 50.0 MHz to 54.0 MHz.

b Compliance level in the ISM frequency bands between 150 kHz to 80 MHz and in the frequency range 80 MHz to 2.7 GHz are intended to decrease the likelihood that portable/ mobile communication equipment could cause interference if it is inadvertently brought into patient areas. For this reason, an additional factor of 10/3 is used in calculating the recommended separation distance for transmitters in these frequency ranges.

c Field strengths from fixed transmitters, such as base stations for radio (cellular/cordless) telephones and land mobile radios, amateur radio, AM and FM radio broadcast and TV broadcast cannot be predicted theoretically with accuracy. To assess the electromagnetic environment due to fixed RF transmitters, an electromagnetic site survey should be considered. If the measured field strength in the location in which this equipment is used exceeds the applicable RF compliance level above, this equipment should be observed to verify normal operation. If abnormal performance is observed, additional measures may be necessary, such as reorienting or relocating the device.

d Over the frequency ranges 150 kHz to 80 MHz, field strengths should be less than 3V/m.

---

**Recommended Separation Distances between Portable and Mobile RF, Communications Equipment and This Equipment**

This equipment is intended for use in an electromagnetic environment in which radiated RF disturbance are controlled. The customer or the user of this equipment can help prevent electromagnetic interference by maintaining a minimum distance between portable and mobile RF communications equipment (transmitters) and this equipment as recommended below, according to the maximum output power of the communication equipment.

Rated Maximum Output power of Transmitter Watts (W)	Separation Distance According to Frequency of Transmitter (m)		
	150 kHz to 80 MHz $d = \left[ \frac{3.5}{V1} \right] \sqrt{P}$	80 MHz to 800 MHz $d = \left[ \frac{3.5}{E1} \right] \sqrt{P}$	800 MHz to 2.7 GHz $d = \left[ \frac{7}{E1} \right] \sqrt{P}$
0.01	0.12	0.12	0.23
0.1	0.38	0.38	0.73
1	1.20	1.20	2.30
10	3.80	3.80	7.30
100	12.00	12.00	23.00

For transmitters at a maximum output power not listed above, the recommended separation distanced in meters (m) can be determined using the equation applicable to the frequency of the transmitter, where P is the maximum output power rating of the transmitter in watts (W) according to the transmitter manufacturer.

Note 1: At 80 MHz and 800 MHz, the higher frequency range applies.

Note 2: These guidelines may not apply in all situations. Electromagnetic propagation is affected by absorption and reflection from structures, objects and people.

# D Alarm Messages

This chapter lists physiological and technical alarm messages.

Note that in this chapter:

- ◆ Column P stands for the default alarm level: H for high, M for medium and L for low.
- ◆ For each alarm message, corresponding actions are given instructing you to troubleshoot problems. If the problem persists, contact your service personnel.

## D.1 Physiological Alarm Messages

Source	Alarm message	P	Cause and action
Ventilator parameters	Paw Too High	H	The airway pressure exceeds the set pressure high alarm limit.
			<ol style="list-style-type: none"> <li>1. Check the patient.</li> <li>2. Check the ventilation parameter setup.</li> <li>3. Check the alarm limits.</li> <li>4. Check the patient tubing for occlusion.</li> </ol>
	FiO <sub>2</sub> Too High	H	The inspired O <sub>2</sub> concentration is greater than the FiO <sub>2</sub> high alarm limit for at least 30s.
			<ol style="list-style-type: none"> <li>1. Check the ventilation parameter setup.</li> <li>2. Check the alarm limits.</li> <li>3. Check the HEPA filter for occlusion.</li> <li>4. Calibrate the O<sub>2</sub> sensor.</li> </ol>
	FiO <sub>2</sub> Too Low	H	The inspired O <sub>2</sub> concentration is less than the FiO <sub>2</sub> low alarm limit for at least 30s or is less than 18 %.
			<ol style="list-style-type: none"> <li>1. Check the ventilation parameter setup.</li> <li>2. Check the alarm limits.</li> <li>3. Check the O<sub>2</sub> supply.</li> <li>4. Calibrate the O<sub>2</sub> sensor.</li> </ol>
	O <sub>2</sub> % Too High	H	During O <sub>2</sub> therapy, the O <sub>2</sub> concentration is greater than the O <sub>2</sub> % high alarm limit for at least 30s.
			<ol style="list-style-type: none"> <li>1. Check the ventilation parameter setup.</li> <li>2. Check the alarm limits.</li> <li>3. Check the O<sub>2</sub> supply.</li> <li>4. Calibrate the O<sub>2</sub> sensor.</li> </ol>
O <sub>2</sub> % Too Low	H	During O <sub>2</sub> therapy, the O <sub>2</sub> concentration is less than the O <sub>2</sub> % low alarm limit for at least 30s or is less than 18 %.	
		<ol style="list-style-type: none"> <li>1. Check the ventilation parameter setup.</li> <li>2. Check the O<sub>2</sub> supply.</li> <li>3. Calibrate the O<sub>2</sub> sensor.</li> </ol>	

	TVe Too High	M	The TVe monitored value is greater than TVe high alarm limit for continuous 3 mechanical ventilation cycles.		
			<ol style="list-style-type: none"> <li>1. Check the ventilation parameter setup.</li> <li>2. Check the alarm limits.</li> </ol>		
	TVe Too Low	M	The TVe monitored value is less than TVe low alarm limit for continuous 3 mechanical ventilation cycles.		
			<ol style="list-style-type: none"> <li>1. Check the patient.</li> <li>2. Check the ventilation parameter setup.</li> <li>3. Check the alarm limits.</li> <li>4. Check the patient tubing for leakage or occlusion.</li> <li>5. Perform System Check to test the leakage.</li> </ol>		
			MV Too High	H	MV is greater than MV high alarm limit.
					<ol style="list-style-type: none"> <li>1. Check the ventilation parameter setup.</li> <li>2. Check the alarm limits.</li> </ol>
			MV Too Low	H	MV is less than MV low alarm limit.
			<ol style="list-style-type: none"> <li>1. Check the ventilation parameter setup.</li> <li>2. Check the alarm limits.</li> <li>3. Check the patient tubing for leakage or occlusion.</li> <li>4. Perform System Check to test the leakage.</li> </ol>		
Apnea	H	The time of failure to detect respiration exceeds Tapnea.			
		<ol style="list-style-type: none"> <li>1. Check the patient.</li> <li>2. Manual breath.</li> <li>3. Check apnea time setup.</li> <li>4. Check if the patient tubing are disconnected.</li> </ol>			
Apnea Ventilation	H	The time of failure to detect respiration exceeds Tapnea.			
		<p>Start apnea ventilation mode.</p> <p>Check apnea ventilation parameter setup.</p>			
ftotal Too High	M	ftotal is greater than ftotal high alarm limit.			
		<ol style="list-style-type: none"> <li>1. Check the patient.</li> <li>2. Check the ventilation parameter setup.</li> <li>3. Check the alarm limits.</li> </ol>			
<b>Main control board</b>	Apnea Ventilation Ended	L	This alarm is given when apnea ventilation ends. There is no need to process this alarm.		

<b>CO<sub>2</sub> module</b>	EtCO <sub>2</sub> Too High	M	The monitored parameter value exceeds the alarm limit.
			1. Check the patient type. 2. Check the alarm limits.
	EtCO <sub>2</sub> Too Low	M	The monitored parameter value exceeds the alarm limit.
1. Check the patient type. 2. Check the alarm limits.			
Apnea CO <sub>2</sub>	M	The time of failure to detect respiration by the CO <sub>2</sub> module exceeds Apnea T <sub>insp</sub> .	
		1. Check the patient. 2. Check apnea time setup. 3. Check the connections of CO <sub>2</sub> module sampling device.	
<b>SpO<sub>2</sub> module</b>	SpO <sub>2</sub> Too High	M	The monitored parameter value exceeds the alarm limit.
			Check the patient's physiological condition. Check if the patient type and the alarm limit settings are correct.
	SpO <sub>2</sub> Too Low	M	The monitored parameter value exceeds the alarm limit.
			Check the patient's physiological condition. Check if the patient type and the alarm limit settings are correct.
	SpO <sub>2</sub> Desat	H	The SpO <sub>2</sub> value falls below the desaturation alarm limit.
			Check the patient's condition and check if the alarm limit settings are correct.
	PR Too High	M	The monitored parameter value exceeds the alarm limit.
Check the patient's physiological condition. Check if the patient type and the alarm limit settings are correct.			
PR Too Low	M	The monitored parameter value exceeds the alarm limit.	
		Check the patient's physiological condition. Check if the patient type and the alarm limit settings are correct.	
No Pulse	H	The pulse signal was so weak that the monitor cannot perform pulse analysis.	
		Check the patient's condition, SpO <sub>2</sub> sensor and measurement site.	

## D.2 Technical Alarm Messages

Source	Alarm message	P	Cause and action
Power board	Battery 1 Failure 01	H	The temperature of battery 1 is higher than expected.
			Contact your service personnel.
	Battery 1 Failure 02	H	Battery 1 Charge Failure
			Contact your service personnel.
	Battery 1 Failure 03	H	Battery 1 Aging
			Contact your service personnel.
	Battery 1 Failure 04	H	Battery 1 Comm Error
			Contact your service personnel.
	Battery 1 Failure 05	H	Battery 1 Failure
			Contact your service personnel.
	Battery 2 Failure 01	H	The temperature of battery 2 is higher than expected.
			Contact your service personnel.
	Battery 2 Failure 02	H	Battery 2 Charge Failure
			Contact your service personnel.
	Battery 2 Failure 03	H	Battery 2 Aging
			Contact your service personnel.
	Battery 2 Failure 04	H	Battery 2 Comm Error
			Contact your service personnel.
	Battery 2 Failure 05	H	Battery 2 Failure
			Contact your service personnel.
Battery Temp. High. Connect Ext.Pwr.	M	Battery temperature is a bit high during discharge.	
		Connect to the external power supply.	
Battery Temp High. Syst maybe Down	H	Battery temperature is too high during discharge. The system may be down.	
		Connect to the external power supply.	
Battery in Use	L	The current system is powered by battery. Connect to the external power supply.	
		Connect to the external power supply.	
Low Battery. Connect Ext. Power.	M	The remaining battery power is lower than a threshold.	
		Connect to the external power supply.	
System DOWN. Connect Ext. Power.	H	Battery power is depleted. The system will shut down in a few minutes.	
		Connect to the external power supply immediately.	
Power Board Comm Stop	H	Power board communication stops.	
		Contact your service personnel.	

	Battery Undetected	H	Battery is not available in the current system. Contact your service personnel.	
<b>Main control board</b>	Please Reset Date and Time	L	Button cell is available in the system. But the clock is powered down and reset. Re-set the date and time.	
	Apnea Ventilation Ended	L	This alarm is given when apnea ventilation ends. There is no need to process this alarm.	
	Key Error	L	Hardkey or rotary encoder is depressed continuously for more than 35s. Contact your service personnel.	
	Technical Error 01	M	Keyboard Comm Stop. Keys are faulty. Contact your service personnel.	
	Technical Error 02	M	Keyboard Selftest Error. Contact your service personnel.	
	Device Failure 04	H	Ctrl Module Init Error. Contact your service personnel.	
	Device Failure 05	H	Ctrl Module Comm Stop. Contact your service personnel.	
	Device Failure 19	H	Power Board Comm Stop. Contact your service personnel.	
	Device Failure 20	H	SpO <sub>2</sub> Comm Stop. Restart the ventilator or contact your service personnel.	
	Device Failure 21	H	Pressure Sensor Zero Point Error. Contact your service personnel.	
	<b>Monitor board</b>	Technical Error 03	M	Turbine blower Temp Sensor Failure. Contact your service personnel.
		Technical Error 04	M	Buzzer Failure. Contact your service personnel.
Technical Error 05		M	Atmospheric Pressure Sensor Failure. Contact your service personnel.	
Technical Error 06		M	HEPA Pressure Sensor Failure. Contact your service personnel.	
Technical Error 07		M	3-way Valve Failure. Contact your service personnel.	
Technical Error 08		M	Nebulizer Valve Failure. Contact your service personnel.	
Technical Error 09		M	Insp. Temp Sensor Failure. Contact your service personnel.	
Device Failure 01		H	Power Supply Voltage Error. Contact your service personnel.	
Device Failure 02		H	Memory Error. Contact your service personnel.	

Device Failure 03	H	Power Board Selftest Error.
		Contact your service personnel.
Device Failure 06	H	Ctrl Module Selftest Error.
		Contact your service personnel.
Device Failure 07	H	Insp. Module Comm stop.
		Contact your service personnel.
Device Failure 08	H	Exp. Module Comm stop.
		Contact your service personnel.
Device Failure 09	H	Pressure Sensor Failure.
		Contact your service personnel.
Device Failure 10	H	Safety Valve Failure.
		Contact your service personnel.
Device Failure 12	H	Insp. Limb Failure.
		Contact your service personnel.
Device Failure 13	H	O <sub>2</sub> Limb Failure.
		Contact your service personnel.
Device Failure 14	H	Turbine blower Failure.
		Contact your service personnel.
Device Failure 15	H	Turbine blower Temp Too High.
		Contact your service personnel.
Device Failure 16	H	Insp. Valve Disconnected.
		Contact your service personnel.
Device Failure 17	H	Insp. Module Selftest Error.
		Contact your service personnel.
Device Failure 18	H	Exp. Module Selftest Error.
		Contact your service personnel.
Device Failure 21	H	Pressure Sensor Zero Point Error.
		Contact your service personnel.
PEEP Too High	H	Monitored PEEP exceeds PEEP+5 cmH <sub>2</sub> O (PEEP+10 cmH <sub>2</sub> O for APRV mode) within any fully mechanical ventilation cycle.
		<ol style="list-style-type: none"> <li>1. Check the ventilation parameter setup.</li> <li>2. Check the patient tubing for occlusion.</li> </ol>
PEEP Too Low	M	Patient's PEEP is less than the setting value to a certain extent.
		<ol style="list-style-type: none"> <li>1. Check the patient tubing for leakage.</li> <li>2. Perform System Check to test the leakage.</li> </ol>
Airway Obstructed?	H	Tube is occluded.
		<ol style="list-style-type: none"> <li>1. Check and clean the patient tubing.</li> <li>2. Check and clean the expiration valve.</li> </ol>
Sustained Airway Pressure	H	The airway pressure measured by any pressure sensor is greater than or equal to the setting PEEP+15 cmH <sub>2</sub> O for continuous 15 s.



			<ol style="list-style-type: none"> <li>1. Check the patient.</li> <li>2. Check the ventilation parameter setup.</li> <li>3. Check the patient tubing for occlusion.</li> </ol>
Airway Leak?	L		<p>Tube is leaky.</p> <ol style="list-style-type: none"> <li>1. Check the patient tubing for leakage.</li> <li>2. Perform System Check to test the leakage</li> </ol>
Tube Disconnected?	H		<p>Tube is disconnected.</p> <p>Re-connect the patient tubing.</p>
Insp. Limb Airway Obstructed?	M		<p>The patient tubing is bent or occluded in case of O<sub>2</sub> therapy.</p> <p>Check if the patient tubing is occluded or bent. If yes, clear it.</p>
Pressure Limited	L		<p>In volume mode or pressure mode when ATRC function is enabled, the pressure reaches Paw high alarm limit-5.</p> <ol style="list-style-type: none"> <li>1. Check the patient.</li> <li>2. Check the ventilation parameter setup.</li> <li>3. Check pressure high alarm limit.</li> </ol>
Volume Limited	L		<p>In pressure mode, delivered gas volume exceeds the set TV high limit.</p> <ol style="list-style-type: none"> <li>1. Check the patient.</li> <li>2. Check the ventilation parameter setup.</li> <li>3. Check the alarm limits.</li> </ol>
Pinsp Not Achieved	L		<p>Pinsp is less than the pressure setting value by 3 cmH<sub>2</sub>O or 1/3 of the pressure setting value, whichever is less.</p> <ol style="list-style-type: none"> <li>1. Check the patient.</li> <li>2. Check TV alarm limits.</li> <li>3. Check the O<sub>2</sub> supply.</li> <li>4. Check the patient tubing for leakage.</li> <li>5. Check the HEPA filter for occlusion.</li> </ol>
TV Not Achieved	L		<p>TV<sub>i</sub> is less than the TV setting value for a period time.</p> <ol style="list-style-type: none"> <li>1. Check the patient.</li> <li>2. Check pressure high alarm limit.</li> <li>3. Check the HEPA filter for occlusion.</li> <li>4. Check the O<sub>2</sub> supply.</li> <li>5. Check the patient tubing for leakage or occlusion.</li> </ol>
Pressure Limited in Sigh cycle	L		<p>The pressure reaches Paw high alarm limit-5 in sigh cycle.</p> <ol style="list-style-type: none"> <li>1. Check the patient.</li> <li>2. Check pressure high alarm limit.</li> <li>3. Check the patient tubing for occlusion.</li> <li>4. Consider to turn off sigh.</li> </ol>
O <sub>2</sub> Supply Failure	H		O <sub>2</sub> pressure is low or high-pressure O <sub>2</sub> is not connected.

			<ol style="list-style-type: none"> <li>1. Check connection with O<sub>2</sub> supply.</li> <li>2. Check O<sub>2</sub> supply pressure.</li> </ol>
Tinsp Too Long	L	<p>In PSV mode, Tinsp exceeds 4s for adult and 1.5s for pediatric for continuous 3 cycles. This alarm is not triggered again after pressure sensor or flow sensor failure.</p> <ol style="list-style-type: none"> <li>1. Check the patient.</li> <li>2. Check the ventilation parameter setup.</li> <li>3. Check the patient tubing for leakage.</li> </ol>	
Please Check Exp. Flow Sensor	H	<p>Installing the expiratory flow sensor fails.</p> <p>Contact your service personnel.</p>	
Insp. Gas Temp Too High	H	<p>The gas temperature exceeds 45°C. Restart the machine.</p> <ol style="list-style-type: none"> <li>1. Disconnect the patient.</li> <li>2. Clean the fan dust filter.</li> <li>3. Restart the ventilator.</li> </ol>	
Replace HEPA Filter	L	<p>The resistance of HEPA becomes intense.</p> <p>Contact your service personnel.</p>	
Fan Failure	M	<p>Fan speed error. Restart the machine if the error cannot be corrected.</p> <p>Contact your service personnel.</p>	
Flow Sensor Type Error	H	<p>Installation error of Air flow sensor or O<sub>2</sub> flow sensor.</p> <p>Contact your service personnel.</p>	
Blower Temperature High	H	<p>Turbine blower temperature exceeds the threshold.</p> <ol style="list-style-type: none"> <li>1. Check if the operating ambient temperature of the machine exceeds the maximum operating temperature specified by the vendor.</li> <li>2. Check if the fan inlet and outlet are occluded. If yes, clear the foreign substance and dust.</li> <li>3. Check the rotation of the fan. If it runs abnormally (such as abnormal sound or rotation speed), replace the fan.</li> </ol>	
AMV: Cannot Meet Target	L	<p>Cannot meet established MV%</p> <ol style="list-style-type: none"> <li>1. Check the ventilation parameter setup.</li> <li>2. Check the alarm limits setting.</li> </ol>	
O <sub>2</sub> Sensor Unconnected	L	<p>The O<sub>2</sub> sensor is not connected.</p> <p>Connect the O<sub>2</sub> sensor.</p>	
Please Replace O <sub>2</sub> Sensor.	M	<p>The O<sub>2</sub> sensor is used up.</p> <p>Replace the O<sub>2</sub> sensor.</p>	
Please calibrate O <sub>2</sub> sensor.	L	<p>Calibrate the O<sub>2</sub> sensor.</p> <p>Calibrate O<sub>2</sub> concentration.</p>	
Please perform pressure calibration.	H	<p>Calibrate the pressure sensor.</p> <p>Contact your service personnel.</p>	
Please perform flow	H	<p>Calibrate the flow sensor.</p>	

	calibration.		Calibrate flow.
<b>CO<sub>2</sub> module</b>	CO <sub>2</sub> Module Failure 01	M	Sidestream CO <sub>2</sub> module zeroing fails. The gain input signal offset is too large, exceeding the adjustable range.
			Contact your service personnel.
	CO <sub>2</sub> Module Failure 02	M	CO <sub>2</sub> Init Error. An error occurs to the CO <sub>2</sub> module during initialization.
			Contact your service personnel.
	CO <sub>2</sub> Module Failure 03	M	CO <sub>2</sub> Selftest Error. An error occurs to the CO <sub>2</sub> module during selftest.
			Contact your service personnel.
	CO <sub>2</sub> Module Failure 04	M	CO <sub>2</sub> Hardware Error.
			Contact your service personnel.
	CO <sub>2</sub> Module Failure 05	M	CO <sub>2</sub> Comm Stop, CO <sub>2</sub> Module Failure, CO <sub>2</sub> Comm Error or communication failure reaches 10s.
			Contact your service personnel.
	CO <sub>2</sub> Module Failure 06	M	Mainstream CO <sub>2</sub> module zeroing fails.
			Contact your service personnel.
	CO <sub>2</sub> Sensor High Temp	L	The temperature of sensor assembly is too high (greater than 63°C).
			Contact your service personnel.
	CO <sub>2</sub> Sampleline Occluded	L	Sampling line is faulty or occluded.
1. Check the sampling line for occlusion.			
2. Replace the sampling line. 3. Replace the water trap.			
CO <sub>2</sub> No Watertrap	L	The water trap is disconnected or not connected properly. Check the water trap.	
		Re-install the water trap.	
EtCO <sub>2</sub> Overrange	L	Parameter measured values exceed the measurement range (error range is included).	
		1. Perform CO <sub>2</sub> module zeroing. 2. Contact your service personnel.	
Please Replace CO <sub>2</sub> Sensor	M	The mainstream CO <sub>2</sub> module sensor is faulty.	
		Contact your service personnel.	
CO <sub>2</sub> No Sensor	L	The mainstream CO <sub>2</sub> module sensor is not connected.	
		Connect the CO <sub>2</sub> sensor.	

<b>SpO<sub>2</sub> module</b>	SpO <sub>2</sub> Sensor Off	L	<p>Connected SpO<sub>2</sub> sensor became disconnected from patient tubing (e.g. wire disconnection or short circuit).</p> <ol style="list-style-type: none"> <li>1. Check the sensor application site and the sensor type, and make sure if the sensor is damaged.</li> <li>2. Reconnect the sensor or use a new sensor.</li> </ol>
	Please Replace SpO <sub>2</sub> Sensor	M	<p>SpO<sub>2</sub> sensor failure (e.g. wire disconnection or short circuit).</p>
			<ol style="list-style-type: none"> <li>1. Check the sensor application site and the sensor type, and make sure if the sensor is damaged.</li> <li>2. Reconnect the sensor or use a new sensor.</li> </ol>
	SpO <sub>2</sub> No Sensor	L	<p>The SpO<sub>2</sub> extension cable is detached from the module, or the SpO<sub>2</sub> sensor is detached from the module extension cable.</p>
			<ol style="list-style-type: none"> <li>1. Check the sensor application site and the sensor type, and make sure if the sensor is damaged.</li> <li>2. Reconnect the sensor or use a new sensor.</li> </ol>
	SpO <sub>2</sub> Too Much Light	L	<p>The ambient light of the sensor is too strong. The photoelectric detection end of the sensor absorbs ambient light.</p>
			<p>Move the sensor to a place with lower level of ambient light or cover the sensor to minimize the ambient light.</p>
	SpO <sub>2</sub> Non-Pulsatile	L	<p>The SpO<sub>2</sub> sensor failed to obtain pulse signal (or incomplete signal).</p>
			<p>Check the patient's condition and change the sensor application site. If the error persists, replace the sensor.</p>
	SpO <sub>2</sub> Module Error	M	<p>SpO<sub>2</sub> module failure.</p>
<p>Replace the SpO<sub>2</sub> module.</p>			
SpO <sub>2</sub> Overrange	L	<p>The measured value exceeds the measurement range.</p>	
		<ol style="list-style-type: none"> <li>1. Check if the measurement method is correct.</li> <li>2. Replace the SpO<sub>2</sub> module.</li> </ol>	
PR Overrange	L	<p>The measured value exceeds the measurement range.</p>	
		<ol style="list-style-type: none"> <li>1. Check if the measurement method is correct.</li> <li>2. Replace the SpO<sub>2</sub> module.</li> </ol>	

# E Factory Defaults

---

---

This chapter lists the most important factory default settings which are not user-adjustable. When necessary, you can restore the factory default settings.

## E.1 Screen

Setting	Factory default setting
Setup-screen setup-waveform count	3
Setup-screen setup-Draw Wave	Curve
Setup-screen setup- Value Count	9

## E.2 Setup

Setting	Factory default setting
Brightness/Volume-Key volume	2
Brightness/Volume-LCD brightness	5
System-Tinsp/I:E	Tinsp
System – Height/IBW	Height
System – DuoLevel Timing	Thigh
System-IV Apnea Mode	Pressure Control
System -TV/IBW	7 mL/kg
Sensor-O <sub>2</sub> - O <sub>2</sub> Monitoring	ON
Time-date	2012.01.01
Time-time	00:00:00
Time-date format	YYYY-MM-DD
Time-time format	24 h

## E.3 CO<sub>2</sub> Module

CO <sub>2</sub> module	Factory default setting
Monitoring	ON
Pump rate	100 mL/min
BTPS compensation	OFF
Max hold	10 s

## E.4 SpO<sub>2</sub> Module

SpO <sub>2</sub> module	Factory default setting
Monitoring	ON
Sensitivity	Med
Beat vol	1
Sweep Speed	25 mm/s

## E.5 Ventilation Mode

Ventilation mode setting parameter	Factory default setting
<b>V-A/C mode</b>	
TV	Adult: 490 mL pediatric: 106 mL
O <sub>2</sub> % (HPO)	21 %
f	Adult: 10 bpm pediatric: 20 bpm
PEEP	3 cmH <sub>2</sub> O
Δint.PEEP	5 cmH <sub>2</sub> O
Sigh	OFF
Interval	1 min
Cycles sigh	3
T <sub>insp</sub>	Adult: 2.00 s; pediatric: 1.00 s
T <sub>pause</sub> (%)	OFF
I:E	1:2
Assist	ON
F-trig	Adult: 2.0 L/min; pediatric: 1.0 L/min
ATRC-tube type	Disable ATRC
ATRC-Tube I.D.	Adult: 8.0 mm; pediatric: 5.0 mm
ATRC-compensate	80 %
<b>P-A/C mode</b>	
O <sub>2</sub> %	21 %
f	Adult: 10 bpm pediatric: 20 bpm
PEEP	3 cmH <sub>2</sub> O
ΔP <sub>insp</sub>	15 cmH <sub>2</sub> O
T <sub>insp</sub>	Adult: 2.00 s; pediatric: 1.00 s
I:E	1:2
T <sub>slope</sub>	0.20 s

Assist	ON
F-trig	Adult: 2.0 L/min; pediatric: 1.0 L/min
$\Delta$ int.PEEP	5 cmH <sub>2</sub> O
Sigh	OFF
Interval	1 min
Cycles sigh	3
ATRC-tube type	Disable ATRC
ATRC-Tube I.D.	Adult: 8.0 mm; pediatric: 5.0 mm
ATRC-compensate	80 %
<b>CPAP/PSV mode</b>	
O <sub>2</sub> %	21 %
PEEP	3 cmH <sub>2</sub> O
$\Delta$ P <sub>supp</sub>	0 cmH <sub>2</sub> O
T <sub>slope</sub>	0.20 s
F-trig	Adult: 2.0 L/min; pediatric: 1.0 L/min
Exp%	Auto
$\Delta$ P <sub>apnea</sub>	15 cmH <sub>2</sub> O
f <sub>apnea</sub>	Adult: 10 bpm pediatric: 20 bpm
T <sub>insp</sub> (only in NIV mode)	Adult: 2.00 s; pediatric: 1.00 s
ATRC-tube type	Disable ATRC
ATRC-Tube I.D.	Adult: 8.0 mm; pediatric: 5.0 mm
ATRC-compensate	80 %
<b>V-SIMV mode</b>	
TV	Adult: 490 mL pediatric: 106 mL
O <sub>2</sub> %	21 %
f <sub>simv</sub>	Adult: 5 bpm; pediatric: 20 bpm
PEEP	3 cmH <sub>2</sub> O
$\Delta$ P <sub>supp</sub>	0 cmH <sub>2</sub> O
T <sub>pause</sub> (%)	OFF
T <sub>insp</sub>	Adult: 2.00 s; pediatric: 1.00 s
T <sub>slope</sub>	0.20s
F-trig	Adult: 2.0 L/min; pediatric: 1.0 L/min
Exp%	Auto
$\Delta$ P <sub>apnea</sub>	15 cmH <sub>2</sub> O
f <sub>apnea</sub>	Adult: 10 bpm pediatric: 20 bpm
Apnea Ti	Adult: 2.0 s; pediatric: 1.0 s
TV <sub>apnea</sub>	Adult: 490 mL pediatric: 106 mL
Apnea ventilation	ON

Δint.PEEP	5 cmH <sub>2</sub> O
Sigh	OFF
Interval	1 min
Cycles sigh	3
ATRC-tube type	Disable ATRC
ATRC-Tube I.D.	Adult: 8.0 mm; pediatric: 5.0 mm
ATRC-compensate	80 %
<b>P-SIMV mode</b>	
O <sub>2</sub> %	21 %
fsimv	Adult: 5 bpm; pediatric: 20 bpm
PEEP	3 cmH <sub>2</sub> O
ΔPinsp	15 cmH <sub>2</sub> O
ΔPsupp	0 cmH <sub>2</sub> O
Tinsp	Adult: 2.00 s; pediatric: 1.00 s
Tslope	0.20 s
F-trig	Adult: 2.0 L/min; pediatric: 1.0 L/min
Exp%	Auto
ΔPapnea	15 cmH <sub>2</sub> O
fapnea	Adult: 10 bpm pediatric: 20 bpm
Apnea Ti	Adult: 2.0 s; pediatric: 1.0 s
TVapnea	Adult: 490 mL pediatric: 106 mL
Apnea ventilation	ON
Δint.PEEP	5 cmH <sub>2</sub> O
Sigh	OFF
Interval	1 min
Cycles sigh	3
ATRC-tube type	Disable ATRC
ATRC-Tube I.D.	Adult: 8.0 mm; pediatric: 5.0 mm
ATRC-compensate	80 %
<b>PRVC mode</b>	
TV	Adult: 490 mL pediatric: 106 mL
f	Adult: 10 bpm pediatric: 20 bpm
O <sub>2</sub> %	21 %
PEEP	3 cmH <sub>2</sub> O
Tinsp	Adult: 2.00 s; pediatric: 1.00 s
I:E	1:2
Tslope	0.20 s
Assist	ON



F-trig	Adult: 2.0 L/min; pediatric: 1.0 L/min
$\Delta$ int.PEEP	5 cmH <sub>2</sub> O
Sigh	OFF
Interval	1 min
Cycles sigh	3
ATRC-tube type	Disable ATRC
ATRC-Tube I.D.	Adult: 8.0 mm; pediatric: 5.0 mm
ATRC-compensate	80 %
<b>PRVC-SIMV mode</b>	
TV	Adult: 490 mL pediatric: 106 mL
O <sub>2</sub> %	21 %
f <sub>simv</sub>	Adult: 5 bpm; pediatric: 20 bpm
PEEP	3 cmH <sub>2</sub> O
$\Delta$ P <sub>supp</sub>	0 cmH <sub>2</sub> O
T <sub>insp</sub>	Adult: 2.00 s; pediatric: 1.00 s
T <sub>slope</sub>	0.20 s
F-trig	Adult: 2.0 L/min; pediatric: 1.0 L/min
Exp%	Auto
$\Delta$ P <sub>apnea</sub>	15 cmH <sub>2</sub> O
f <sub>apnea</sub>	Adult: 10 bpm pediatric: 20 bpm
Apnea Ti	Adult: 2.0 s; pediatric: 1.0 s
TV <sub>apnea</sub>	Adult: 490 mL pediatric: 106 mL
Apnea ventilation	ON
$\Delta$ int.PEEP	5 cmH <sub>2</sub> O
Sigh	OFF
Interval	1 min
Cycles sigh	3
ATRC-tube type	Disable ATRC
ATRC-Tube I.D.	Adult: 8.0 mm; pediatric: 5.0 mm
ATRC-compensate	80 %
<b>DuoLevel mode</b>	
O <sub>2</sub> %	21 %
$\Delta$ P <sub>supp</sub>	0 cmH <sub>2</sub> O
T <sub>slope</sub>	0.20 s
Phigh	15 cmH <sub>2</sub> O
Plow	3 cmH <sub>2</sub> O
Thigh	Adult: 2.0 s; pediatric: 1.0 s
Tlow	Adult: 4.0 s; pediatric: 2.0 s
F-trig	Adult: 2.0 L/min; pediatric: 1.0 L/min

Exp%	Auto
$\Delta$ Papnea	15 cmH <sub>2</sub> O
fapnea	Adult: 10 bpm pediatric: 20 bpm
Apnea Ti	Adult: 2.0 s; pediatric: 1.0 s
TVapnea	Adult: 490 mL pediatric: 106 mL
ATRC-tube type	Disable ATRC
ATRC-Tube I.D.	Adult: 8.0 mm; pediatric: 5.0 mm
ATRC-compensate	80 %
<b>APRV mode</b>	
O <sub>2</sub> %	21 %
Tslope	0.20 s
Phigh	15 cmH <sub>2</sub> O
Plow	3 cmH <sub>2</sub> O
Thigh	Adult: 2.0 s; pediatric: 1.0 s
Tlow	Adult: 4.0 s; pediatric: 2.0 s
F-trig	Adult: 2.0 L/min; pediatric: 1.0 L/min
$\Delta$ Papnea	15 cmH <sub>2</sub> O
fapnea	Adult: 10 bpm pediatric: 20 bpm
Apnea Ti	Adult: 2.0 s; pediatric: 1.0 s
TVapnea	Adult: 490 mL pediatric: 106 mL
ATRC-tube type	Disable ATRC
ATRC-Tube I.D.	Adult: 8.0 mm; pediatric: 5.0 mm
ATRC-compensate	80 %
<b>AMV mode</b>	
O <sub>2</sub> %	21 %
MV%	100%
PEEP	15 cmH <sub>2</sub> O
F-trig	Adult: 2.0 L/min; pediatric: 1.0 L/min
Exp%	Auto
Tslope	0.20 s

---

## E.6 Alarm

Alarm	Factory default setting
Paw high alarm limit	50 cmH <sub>2</sub> O
MV high alarm limit	Adult: 7.4 L/min; pediatric: 3.2 L/min
MV low alarm limit	Adult: 2.9 L/min; pediatric: 1.3 L/min
TVe high alarm limit	Adult: 980 mL; pediatric: 210 mL
TVe low alarm limit	Adult: 245 mL; pediatric: 55 mL
FiO <sub>2</sub> high alarm limit	100 %
FiO <sub>2</sub> low alarm limit	21 %
EtCO <sub>2</sub> low alarm limit	Adult: 15 mmHg; pediatric: 20 mmHg
EtCO <sub>2</sub> high alarm limit	50 mmHg
SpO <sub>2</sub> high alarm limit	100 %
SpO <sub>2</sub> low alarm limit	90 %
Desat alarm limit	80 %
PR high alarm limit	Adult: 120; pediatric: 160
PR low alarm limit	Adult: 50; pediatric: 75
f high alarm limit	OFF
Tapnea	15 s
Alarm volume	5

## E.7 History Data

Trend log	Factory default setting
Graphic trend-display group	All
Graphic trend-zoom	10 min
Tabular trend-display group	All
Tabular trend-interval	1 min
Event logbook-filter	All Events

## E.8 Special Functions

Special function	Factory default setting
Nebulizer time	30 min
P-V tool-Pstart	3 cmH <sub>2</sub> O
P-V tool-Pmax	15 cmH <sub>2</sub> O
P-V tool-Flow	6 L/min
P-V tool-Vlimit	770 mL
Recruitment Tool- $\Delta$ Pinsp	5 cmH <sub>2</sub> O

---

## E.9 O<sub>2</sub> Therapy

O <sub>2</sub> Therapy	Factory default setting
O <sub>2</sub> %	21 %
Flow	25 L/min

## E.10 User Maintenance

System	Factory default value
Setting-language	Chinese
Setting -gas supply-O <sub>2</sub> supply type	HPO
Interface setting-nurse call-switch	ON
Interface setting-nurse call-signal type	Continuous
Interface setting-nurse call-contact type	Normally Closed
Interface setting-nurse call-alarm type	Physiological alarm, technical alarm
Interface setting-nurse call-alarm level	High, Med
Setting -unit-CO <sub>2</sub> unit	mmHg
Setting -unit-Paw unit	cmH <sub>2</sub> O
Setting -unit-weight unit	kg
CO <sub>2</sub> maintenance-CO <sub>2</sub> calibration-CO <sub>2</sub> calibration concentration	3 %

## E.11 Other

Patient	Factory default setting
Weight	Adult: 70 kg; pediatric: 15.1 kg
Gender	Male
Height	Adult: 174 cm; pediatric: 99 cm
Ventilation type	Invasive

# F Symbols and Abbreviations

---

---

## F.1 Unit

A	ampere
Ah	ampere hour
bpm	breaths per minute
°C	centigrade
cc	cubic centimetre
cm	centimeter
cmH <sub>2</sub> O	centimeter of water
dB	decibel
°F	fahrenheit
g	gram
hr	hour
Hz	hertz
hPa	hectopascal
inch	inch
J	joule
k	kilo-
kg	kilogram
kPa	kilopascal
L	litre
lb	pound
m	meter
mAh	milliampere hour
mbar	millibar
mg	milligram
min	minute
mL	milliliter
mm	millimeter
mmHg	millimeter of mercury
ms	millisecond
mV	millivolt
mW	milliwatt
nm	nanometer
ppm	part per million
s	second
V	volt

---

VA	volt ampere
$\Omega$	ohm
$\mu\text{A}$	microampere
$\mu\text{V}$	microvolt
W	watt

## F.2 Symbols

-	minus
%	percent
/	per; divide; or
~	to
^	power
+	plus
=	equal to
<	less than
>	greater than
$\leq$	less than or equal to
$\geq$	greater than or equal to
$\pm$	plus or minus
*	multiply
©	copyright

---

## F.3 Abbreviations

AMV	Adaptive Minute Ventilation
APRV	Airway Pressure Release Ventilation
ATPD	Ambient Temperature and Pressure Dry
BTPS	Body Temperature and Pressure Saturated
Cdyn	Dynamic Compliance
CPAP/PSV	Continuous Positive Airway Pressure/ Pressure Support Ventilation
Cstat	Static Compliance
DuoLevel	Duo Level Ventilation
Et CO <sub>2</sub>	End-tidal Carbon Dioxide
FiO <sub>2</sub>	Inspired Oxygen Concentration
Flow	Flow
f	Breathing Frequency
fapnea	Frequency of Apnea Ventilation
fmand	Mandatory Frequency
fspn	Spontaneous Frequency
fsimv	Frequency of SIMV
ftotal	Total Breathing Frequency
I:E	Inspiratory Time : Expiratory Time Ratio
MV	Minute Volume
MV%	Percentage of Minute Volume
MVspn	Spontaneous Minute Volume
MVleak	Leakage Minute Volume
NIF	Negative Inspiratory Force
NIV	Non-Invasive Ventilation
O <sub>2</sub>	Oxygen
P0.1	100ms Occlusion Pressure
P-A/C	Pressure - Assist/Control Ventilation
Paw	Airway Pressure
PEEP	Positive End-Expiratory Pressure
PEEPi	Intrinsic PEEP
$\Delta$ P <sub>insp</sub>	Pressure Control Level of Inspiration
P <sub>mean</sub>	Mean Pressure

Ppeak	Peak Pressure
Pplat	Plateau Pressure
PR	Pulse Rate
PRVC	Pressure Regulated Volume Control Ventilation
PRVC-SIMV	Pressure Regulated Volume Controlled - Synchronized Intermittent Mandatory Ventilation
P-SIMV	Pressure - Synchronized Intermittent Mandatory Ventilation
int.PEEP	Intermittent Positive End-Expiratory Pressure
Papnea	Pressure of Apnea Ventilation
Psupp	Pressure Support Level
$\Delta$ int.PEEP	Intermittent Positive End-Expiratory Pressure (relative to PEEP)
$\Delta$ Papnea	Pressure of Apnea Ventilation (relative to PEEP/Plow)
$\Delta$ Psupp	Pressure Support Level(relative to PEEP/Plow)
$\Delta$ Pinsp	Pressure Control Level of Inspiration (relative to PEEP/Plow)
Ri	Inspiration Resistance
Re	Expiration Resistance
Sigh	Sigh
SIMV	Synchronized Intermittent Mandatory Ventilation
slopeCO <sub>2</sub>	CO <sub>2</sub> rising slope.
SpO <sub>2</sub>	Arterial oxygen saturation from pulse oximetry
STPD	Standard temperature and pressure dry
Texp	Expiration Time
Thigh	Time of High Pressure
Tinsp	Inspiration Time
Tlow	Time of Low Pressure
Tpause(%)	Percent of Inspiratory Pause Time
Tpause(s)	Pause Time
Tplat	Time of Plat In Inspiratory Period
Tslope	Time of Pressure Rising
TV	Tidal Volume
TVe	Expired Tidal Volume
TVe spn	Spontaneous Expired Tidal Volume



---

TVi	Inspired tidal Volume
TV/IBW	Tidal Volume Per Ideal Body Weight
Volume	Gas Volume
Vtrap	Volume of Trap Gas
V-A/C	Volume - Assist/Control Ventilation
V-SIMV	Volume - Synchronized Intermittent Mandatory Ventilation
RSBI	Rapid Shallow Breath Index
WOB	Work of Breath
Vdaw	Airway dead space.
VDaw/TVe	Ratio of airway dead space to tidal volume.
VeCO <sub>2</sub>	Exhaled CO <sub>2</sub> volume.
ViCO <sub>2</sub>	Inspired CO <sub>2</sub> volume.
Vtalv	Alveolar tidal ventilation.
V'alv	Alveolar minute ventilation.
V'CO <sub>2</sub>	CO <sub>2</sub> elimination.

---

**FOR YOUR NOTES**



