

**M7/M7T/M7 Premium/M7 Expert/M7
Super
Diagnostic Ultrasound System**

Operator's Manual

[Basic Volume]

Contents

Contents	i
Intellectual Property Statement.....	I
Responsibility on the Manufacturer Party.....	II
Warranty.....	II
Exemptions.....	II
Customer Service Department.....	III
Important Information.....	IV
About This Manual.....	IV
Notation Conventions.....	V
Operator's Manuals.....	V
Manuals on Paper.....	V
Software Interfaces in this Manual.....	V
Conventions.....	VI
1 Safety Precautions	1-1
1.1 Safety Classification.....	1-1
1.2 Meaning of Signal Words.....	1-1
1.3 Meaning of Safety Symbols.....	1-2
1.4 Safety Precautions.....	1-2
1.5 Latex Alert.....	1-9
1.6 Warning Labels.....	1-10
2 System Overview	2-1
2.1 Intended Use.....	2-1
2.2 Contraindication.....	2-1
2.3 Product and Model Code.....	2-1
2.4 Product Specifications.....	2-2
2.4.1 Imaging Modes.....	2-2
2.4.2 Power supply.....	2-2
2.4.3 Environmental Conditions.....	2-2
2.4.4 External Dimensions and Weight.....	2-3
2.5 System Configuration.....	2-3
2.5.1 Standard Configuration.....	2-3
2.5.2 Options.....	2-3
2.6 Introduction of Each Unit.....	2-8
2.7 Mobile trolley.....	2-9
2.8 Extend Modules.....	2-13
2.8.1 Probe Extend Module.....	2-13

2.8.2	I/O extend module	2-14
2.8.3	V/A Extend Module	2-15
2.8.4	ECG module	2-16
2.9	Control Panel	2-17
2.10	Symbols	2-21
3	System Preparation	3-1
3.1	Move/Posit the System	3-1
3.2	Power Supply	3-1
3.2.1	Connecting the External Power Supply	3-1
3.2.2	Powered by Batteries	3-2
3.3	Power ON /OFF	3-2
3.3.1	Powering ON the System	3-2
3.3.2	Powering OFF the System	3-3
3.3.3	Standby	3-4
3.4	Connecting /Disconnecting a Probe	3-5
3.4.1	Connecting a Probe	3-5
3.4.2	Disconnecting a Probe	3-5
3.5	Connecting the Footswitch	3-6
3.6	Connecting/ Removing a USB Memory Device	3-6
3.7	Graph /Text printer	3-7
3.8	Video Printer	3-8
3.9	Basic Screen and Operation	3-10
3.9.1	Basic Screen	3-10
3.9.2	Basic Operations of Screens	3-15
4	Exam Preparation	4-1
4.1	To Start an Exam	4-1
4.2	Patient Information	4-1
4.2.1	New Patient Information	4-2
4.2.2	Retrieve Patient Information	4-5
4.3	Select an Exam Mode and Probe	4-6
4.3.1	Supported Exam Modes	4-6
4.3.2	Selecting Exam Modes and Probes	4-7
4.4	Select the Imaging Mode	4-8
4.5	Activate & Continue an Exam	4-9
4.5.1	Activate an Exam	4-9
4.5.2	Continue an Exam	4-9
4.6	Pause Exam and End Exam	4-9
4.6.1	Pause an Exam	4-9
4.6.2	End an Exam	4-9

4.7	Cancel an Exam.....	4-10
4.8	Anonymous Patient Exam	4-10
5	Image Optimization.....	5-1
5.1	Switching Between Imaging Modes.....	5-1
5.2	Image Adjustment	5-1
5.3	B Mode Image Optimization	5-3
5.3.1	B Mode Exam Protocol.....	5-3
5.3.2	B Mode Parameters	5-3
5.3.3	B Mode Image Optimization.....	5-4
5.4	M Mode Image Optimization	5-11
5.4.1	M Mode Exam Protocol	5-11
5.4.2	M Mode Parameters.....	5-11
5.4.3	M Mode Image Optimization	5-12
5.5	Color Mode Image Optimization	5-15
5.5.1	Color Mode Exam Protocol	5-15
5.5.2	Color Mode Image Optimization.....	5-15
5.5.3	Color Mode Image Optimization.....	5-16
5.6	Power Mode Image Optimization.....	5-20
5.6.1	Power Mode Exam Protocol.....	5-20
5.6.2	Power Mode Image Parameters	5-21
5.6.3	Power Mode Image Optimization	5-21
5.7	PW/CW Doppler Mode Optimization	5-22
5.7.1	PW / CW Mode Exam Protocol	5-22
5.7.2	PW/CW Mode Image Parameters.....	5-23
5.7.3	PW/CW Doppler Mode Optimization.....	5-24
5.8	Anatomical M Mode	5-30
5.8.1	Free Xros M Mode.....	5-30
5.8.2	Free Xros CM (Curved Anatomical M Mode)	5-33
5.9	TDI	5-34
5.9.1	TDI Exam Protocol	5-34
5.9.2	TDI Image Parameters.....	5-35
5.9.3	TDI Image Optimization.....	5-35
5.9.4	TDI Quantitative Analysis (QA)	5-36
5.10	Color M Mode	5-39
5.10.1	Enter Color M Mode	5-40
5.10.2	Exit Color M Mode.....	5-40
5.10.3	Image Parameters.....	5-40
5.11	3D/4D	5-41
5.11.1	Note before Use	5-41

5.11.2	Overview	5-42
5.11.3	3D/4D Preset	5-46
5.11.4	Smart 3D	5-49
5.11.5	4D	5-61
5.11.6	Static 3D	5-64
5.12	iScape	5-66
5.12.1	Basic Procedures for iScape Imaging	5-66
5.12.2	iScape Preset	5-67
5.12.3	Image Acquisition	5-67
5.12.4	iScape Viewing	5-68
5.12.5	Cine Review	5-69
5.12.6	Save Image	5-70
5.13	Contrast Imaging	5-71
5.13.1	Basic Procedures for Contrast Imaging	5-71
5.13.2	Contrast Image Parameters	5-72
5.13.3	Measurement, Comments and Body Marks	5-73
5.14	Elastography	5-74
5.14.1	Basic Procedure for Elastography	5-74
5.14.2	Pressure Hint Curve	5-74
5.14.3	Mass Measurement	5-75
5.14.4	Cine Review	5-75
5.15	Image Preset	5-76
5.15.1	Image Preset	5-76
5.15.2	Soft Menu and Menu Preset	5-78
6	Stress Echo	6-1
6.1	About the Stress Echo Feature	6-1
6.2	Acquisition of Stress Echo Loops	6-1
6.3	Navigation Toolbar	6-3
6.4	Selecting Preferred Stress Echo Loops (Select Mode)	6-4
6.5	Review Mode	6-6
6.5.1	Playing Back Loops	6-7
6.6	Wall Motion Scoring and Reports	6-8
6.6.1	Entering Indications or Comments for the Reports	6-8
6.6.2	Wall Motion Scoring	6-9
6.6.3	Designating Stages for Inclusion in Reports	6-10
6.6.4	Previewing and Printing Reports	6-10
6.7	Maintenance and Protocol	6-10
6.7.1	Maintenance	6-10
6.7.2	Protocol Edit	6-12

6.8	Saving Stress Echo Data	6-14
6.9	Exiting the Stress Echo Feature	6-14
6.10	Measurement	6-14
7	Display & Cine Review	7-1
7.1	Image Display	7-1
7.1.1	Splitting Display	7-1
7.1.2	Image Magnification	7-1
7.1.3	Spot	7-1
7.1.4	Pan	7-2
7.1.5	iZoom (Full-screen Zooming)	7-2
7.1.6	Freeze/ Unfreeze the Image	7-2
7.2	Cine Review	7-3
7.2.1	Entering/ Exiting Cine Review	7-4
7.2.2	Cine Review in 2D Mode	7-4
7.2.3	Cine Review in M or D Mode	7-5
7.2.4	Linked Cine Review	7-6
7.3	Image Compare	7-6
7.3.1	Cine Compare	7-6
7.3.2	Frame Compare	7-7
7.4	Cine Saving	7-7
7.4.1	Review Play	7-7
7.5	Live Capture	7-7
7.6	Cine Memory	7-8
7.6.1	Cine Memory Setting	7-8
7.6.2	Cine Memory Clear	7-8
7.7	Cine Settings	7-9
8	ECG	8-1
8.1	ECG Operation Basic Procedures	8-2
8.2	ECG Setting	8-2
8.3	Parameter Description	8-3
8.4	ECG Review	8-4
9	Measurement	9-1
9.1	Basic Operations	9-1
9.2	General Measurements	9-2
9.2.1	2D General Measurements	9-2
9.2.2	M General Measurements	9-2
9.2.3	Doppler General Measurements	9-3
9.3	Application Measurement	9-3

9.4	Measurement Accuracy	9-5
10	Comments and Body Marks.....	10-1
10.1	Comments (Annotations).....	10-1
10.1.1	To Add Comments.....	10-1
10.1.2	Comment Menu.....	10-1
10.1.3	Adding Comments.....	10-2
10.1.4	Moving Comments	10-4
10.1.5	Modifying (Editing) Comments	10-4
10.1.6	Deleting Comments.....	10-4
10.2	Body Marks (Pictograms).....	10-5
10.2.1	Soft Menu for Body Marks.....	10-5
10.2.2	Adding Body Marks	10-5
10.2.3	Moving Body Marks.....	10-6
10.2.4	Deleting Body Marks	10-6
11	Patient Data Management	11-1
11.1	Patient Information Management.....	11-1
11.1.1	Enter Patient Information	11-1
11.1.2	Patient Information Setting.....	11-1
11.2	Image File Management	11-2
11.2.1	Memory Media.....	11-2
11.2.2	Image File Formats	11-2
11.2.3	Image Storage Preset	11-2
11.2.4	Saving Images to the System	11-3
11.2.5	Quickly Saving Images to USB Flash Drive	11-4
11.2.6	Quickly Saving Full Screen Image to the System	11-4
11.2.7	Thumbnails.....	11-4
11.2.8	Image Review and Analysis	11-5
11.2.9	iVision.....	11-7
11.2.10	Sending Image File	11-8
11.3	Report Management	11-9
11.4	Patient Data Management (iStation).....	11-9
11.4.1	Viewing Patient Information.....	11-10
11.4.2	Searching a Patient.....	11-10
11.4.3	Patient Data Management.....	11-10
11.4.4	Examinations.....	11-11
11.5	Network Storage	11-12
11.6	Print Job Management.....	11-12
11.7	Backing Up and Erasing Files through DVD Drive	11-13
11.8	Patient Task Management	11-14

11.9 Administration	11-14
11.9.1 Access Setting.....	11-14
11.9.2 Setting Access Control	11-15
11.9.3 System Login.....	11-15
11.9.4 Add/ Delete a User	11-15
11.9.5 Modify Password	11-16
11.10 Q-Path.....	11-16
11.10.1 Overview	11-16
11.10.2 Q-Path Basic Procedure	11-17
11.10.3 Q-Path Functions using Q-view	11-18
12 DICOM	12-1
12.1 DICOM Preset.....	12-1
12.1.1 Local TCP/IP Setting	12-1
12.1.2 DICOM Local Setting.....	12-3
12.1.3 DICOM Server Setting.....	12-4
12.1.4 DICOM Service Setting	12-5
12.2 Verify Connectivity	12-16
12.3 DICOM Service	12-16
12.3.1 DICOM Storage	12-16
12.3.2 DICOM Print	12-18
12.3.3 DICOM Worklist.....	12-19
12.3.4 MPPS	12-20
12.3.5 Storage Commitment.....	12-20
12.3.6 Query/ Retrieve	12-21
12.4 DICOM Media Storage.....	12-22
12.5 Structured Report (SR)	12-24
12.6 Showcase Recording	12-24
12.7 DICOM Task Management.....	12-24
13 Probes and Biopsy	13-1
13.1 Probe.....	13-1
13.1.1 Name and Function of Each Part of the Probe	13-3
13.1.2 Orientation of the Ultrasound Image and the Probe Head.....	13-4
13.1.3 Procedures for Operating	13-4
13.1.4 Wearing the Probe Sheath.....	13-7
13.1.5 Probes Cleaning and Disinfection	13-9
13.1.6 Storage and Transportation.....	13-12
13.2 Biopsy Guide.....	13-13
13.2.1 Basic Procedures for Biopsy Guiding.....	13-15
13.2.2 Needle-guided Brackets	13-16

13.2.3	Biopsy Preset	13-23
13.2.4	Needle-guided Bracket Inspection and Installation	13-23
13.2.5	Biopsy Menu.....	13-28
13.2.6	iNeedle	13-29
13.2.7	Verifying the Biopsy Guide Line	13-31
13.2.8	Removing the Needle-guided Bracket	13-32
13.2.9	Clean and Sterilize the Needle-guided Bracket	13-34
13.2.10	Storage and Transportation	13-35
13.2.11	Disposal.....	13-35
13.3	Middle Line.....	13-35
14	Recording.....	14-1
14.1	DVR.....	14-1
14.1.1	DVR Recording	14-1
14.1.2	DVR Video Replay	14-1
15	Setup	15-1
15.1	System Preset.....	15-1
15.1.1	Region	15-2
15.1.2	General.....	15-3
15.1.3	Image Preset.....	15-4
15.1.4	Meas.....	15-5
15.1.5	OB	15-5
15.1.6	Comment.....	15-5
15.1.7	Key Config.....	15-5
15.1.8	Biopsy.....	15-9
15.1.9	Option.....	15-9
15.1.10	Admin	15-10
15.2	Exam Preset	15-10
15.2.1	Exam Selection	15-10
15.2.2	Exam Configuration.....	15-10
15.2.3	User-defined Exam Modes.....	15-11
15.3	Image Preset.....	15-12
15.4	Measure Preset.....	15-12
15.5	Body Mark Preset	15-12
15.5.1	Preset Body Mark for Exam Mode	15-12
15.5.2	User-defined Body Marks.....	15-13
15.5.3	Body Mark Softkey Preset.....	15-15
15.6	Comment Preset.....	15-15
15.6.1	Custom Comments.....	15-15
15.6.2	Comment Softkey Preset	15-16

15.7	Peripheral Preset	15-16
15.8	Network Preset	15-18
15.9	Manage Settings.....	15-19
15.9.1	Exporting Setup Data	15-19
15.9.2	Importing Setup Data	15-19
15.10	Maintenance	15-20
15.11	System Information	15-20
16	Batteries	16-1
16.1	Overview	16-1
16.2	Precautions	16-2
16.3	Installing and Removing the Batteries	16-2
16.4	Battery Status Indicator.....	16-3
16.5	Checking Battery Performance.....	16-3
16.6	Battery Disposal.....	16-3
17	Acoustic Output.....	17-1
17.1	Concerns with Bioeffects	17-1
17.2	Prudent Use Statement.....	17-1
17.3	ALARA Principle (As Low As Reasonably Achievable).....	17-1
17.4	MI/TI Explanation	17-2
17.4.1	Basic Knowledge of MI and TI	17-2
17.4.2	MI/TI Display	17-3
17.5	Acoustic Power Setting.....	17-3
17.6	Acoustic Power Control.....	17-4
17.7	Acoustic Output.....	17-5
17.7.1	Derated Ultrasonic Output Parameters	17-5
17.7.2	Limits of Acoustic Output.....	17-5
17.7.3	Differences between Actual and Displayed MI and TI.....	17-5
17.8	Measurement Uncertainty.....	17-6
17.9	References for Acoustic Power and Safety	17-6
18	Guidance and Manufacturer's Declaration	18-1
19	System Maintenance	19-1
19.1	Daily Maintenance	19-1
19.1.1	Cleaning the System	19-1
19.1.2	Checking the Probe.....	19-5
19.1.3	Checking the Power Cable and Plug	19-5
19.1.4	Checking Appearance	19-5
19.1.5	Backup of the System Hard Drive	19-5
19.2	Troubleshooting	19-5

Appendix A	Wireless LAN	A-1
Appendix B	Barcode Reader	B-1
Appendix C	iScanHelper.....	C-1
Appendix D	Electrical Safety Inspection	D-1

©2010-2019 Shenzhen Mindray Bio-Medical Electronics Co., Ltd. All Rights Reserved.
For this Operator's Manual, the issue date is 2019-08.

Intellectual Property Statement

SHENZHEN MINDRAY BIO-MEDICAL ELECTRONICS CO., LTD. (hereinafter called Mindray) owns the intellectual property rights to this Mindray product and this manual. This manual may refer to information protected by copyright or patents and does not convey any license under the patent rights or copyright of Mindray, or of others.

Mindray intends to maintain the contents of this manual as confidential information. Disclosure of the information in this manual in any manner whatsoever without the written permission of Mindray is strictly forbidden.

Release, amendment, reproduction, distribution, rental, adaptation, translation or any other derivative work of this manual in any manner whatsoever without the written permission of Mindray is strictly forbidden.

mindray ,  and **MINDRAY** are the trademarks, registered or otherwise, of Mindray in China and other countries. All other trademarks that appear in this manual are used only for informational or editorial purposes. They are the property of their respective owners.

Responsibility on the Manufacturer Party

Contents of this manual are subject to change without prior notice.

All information contained in this manual is believed to be correct. Mindray shall not be liable for errors contained herein or for incidental or consequential damages in connection with the furnishing, performance, or use of this manual.

Mindray is responsible for the effects on safety, reliability and performance of this product, only if:

- all installation operations, expansions, changes, modifications and repairs of this product are conducted by Mindray authorized personnel;
- the electrical installation of the relevant room complies with the applicable national and local requirements; and
- the product is used in accordance with the instructions for use.



This equipment must be operated by skilled/trained clinical professionals.



It is important for the hospital or organization that employs this equipment to carry out a reasonable service/maintenance plan. Neglect of this may result in machine breakdown or personal injury.

Warranty

THIS WARRANTY IS EXCLUSIVE AND IS IN LIEU OF ALL OTHER WARRANTIES, EXPRESSED OR IMPLIED, INCLUDING WARRANTIES OF MERCHANTABILITY OR FITNESS FOR ANY PARTICULAR PURPOSE.

Exemptions

Mindray's obligation or liability under this warranty does not include any transportation or other charges or liability for direct, indirect or consequential damages or delay resulting from the improper use or application of the product or the use of parts or accessories not approved by Mindray or repairs by people other than Mindray authorized personnel.

This warranty shall not extend to:

- **Malfunction or damage caused by improper use or man-made failure.**
- **Malfunction or damage caused by unstable or out-of-range power input.**
- **Malfunction or damage caused by force majeure such as fire and earthquake.**
- **Malfunction or damage caused by improper operation or repair by unqualified or unauthorized service people.**
- **Malfunction of the instrument or part whose serial number is not legible enough.**
- **Others not caused by instrument or part itself.**

Customer Service Department

Manufacturer: Shenzhen Mindray Bio-Medical Electronics Co., Ltd.
Address: Mindray Building, Keji 12th Road South, High-tech industrial park,
Nanshan, Shenzhen 518057,P.R.China
Website: www.mindray.com
E-mail Address: service@mindray.com
Tel: +86 755 81888998
Fax: +86 755 26582680

Manufacturer: Mindray DS USA, Inc.
Address: 800 MacArthur Blvd.
Mahwah, NJ 07430-0619 USA
Toll Free: +1 (800) 288-2121
Tel: +1(201) 995-8000
Fax: +1 (800) 926-4275

Important Information

1. It is the customer's responsibility to maintain and manage the system after delivery.
2. The warranty does not cover the following items, even during the warranty period:
 - (1) Damage or loss due to misuse or abuse.
 - (2) Damage or loss caused by Acts of God such as fires, earthquakes, floods, lightning, etc.
 - (3) Damage or loss caused by failure to meet the specified conditions for this system, such as inadequate power supply, improper installation or environmental conditions.
 - (4) Damage or loss due to use of the system outside the region where the system was originally sold.
 - (5) Damage or loss involving the system purchased from a source other than Mindray or its authorized agents.
3. This system shall not be used by persons other than fully qualified and certified medical personnel.
4. Do not make changes or modifications to the software or hardware of this system.
5. In no event shall Mindray be liable for problems, damage, or loss caused by relocation, modification, or repair performed by personnel other than those designated by Mindray.
6. The purpose of this system is to provide physicians with data for clinical diagnosis. It is the physician's responsibility for diagnostic procedures. Mindray shall not be liable for the results of diagnostic procedures.
7. Important data must be backed up on external memory media.
8. Mindray shall not be liable for loss of data stored in the memory of this system caused by operator error or accidents.
9. This manual contains warnings regarding foreseeable potential dangers, but you shall always be alert to dangers other than those indicated as well. Mindray shall not be liable for damage or loss that results from negligence or from ignoring the precautions and operating instructions described in this operator's manual.
10. If the manager for this system is changed, be sure to hand over this operator's manual to the new manager.

About This Manual

This operator's manual describes the operating procedures for this diagnostic ultrasound system M7/M7T/M7 Premium/M7 Expert/M7 Super and the compatible probes. To ensure safe and correct operations, carefully read and understand the manual before operating the system.

Notation Conventions

In this operator's manual, the following words are used besides the safety precautions (refer to "Safety Precautions"). Please read this operator's manual before using the system.

 CAUTION:	<ol style="list-style-type: none">1. The diagnostic ultrasound system is not intended for ophthalmic use. Its use in this clinical specialty is contraindicated.2. U.S.A. Federal Law restricts this device to sale by or on the order of a physician.
---	---

Operator's Manuals

You may receive multi-language manuals in compact disc or paper. Please refer to English manual for latest information and register information.

The content of the operator manual, such as screens, menus or descriptions, may be different from what you see in your system. The content varies depending upon the software version, options and configuration of the system.

Manuals on Paper

- Operator's Manual [Basic Volume]: Describes the basic functions and operations of the system, safety precautions, exam modes, imaging modes, preset, maintenance and acoustic output, etc.
- Operator's Manual [Advanced Volume]: Describes measurement preset, measurements and calculations, etc.
- Operator's Manual [Acoustic Power Data and Surface Temperature Data]: Contains data tables of acoustic output for transducers.
- Operation Note: Contains quick guide for basic operations of the system.

NOTE:	<ol style="list-style-type: none">1. The manuals in CD are the manuals translated into languages other than English according to English manuals.2. When you find that the contents of the manuals in CD are NOT consistent with the system or English manuals, please ONLY refer to the corresponding English manuals.3. The accompanying manuals may vary depending upon the specific system you purchased. Please refer to the packing list.
--------------	---

Software Interfaces in this Manual

Depending on the software version, preset settings and optional configuration, the actual interfaces may be different from those in this manual.

NOTE:	M7T is not sold in Canada.
--------------	----------------------------

Conventions

In this manual, these conventions are used to describe the buttons on the control panel, the items in menu, buttons in dialog box and some basic operations:



- `<Buttons>`: The angular bracket indicates buttons, knobs and other controls on control panel.
- `[Items in menu and buttons in dialog box]`: The square bracket indicates items in menu or the soft menu, or buttons in dialog box.
- `Click [Items or Button]`: Move the cursor to the item or button and press `<Set>`, or click it on the soft menu.
- `[Items in Menu]→[Items in Submenu]`: Selects a submenu item following the path.
- `[Dyn Rng (Value)]`: Indicates menu items with parameter, (value) shows the current value of the item.



1 Safety Precautions

1.1 Safety Classification

- According to the type of protection against electric shock:
CLASS I EQUIPMENT
- According to the degree of protection against electric shock:
Type-BF applied part
- According to the degree of protection against harmful ingress of water:
The main unit belongs to IPX0, and the probes belong to IPX7
Footswitch: 971 SWNOM belongs to IP68
Footswitch: SP-997-350 (3-pedal) belongs to IP68
- According to the degree of safety of application in the presence of a FLAMMABLE ANESTHETIC MIXTURE WITH AIR or WITH OXYGEN OR NITROUS OXIDE:
EQUIPMENT not suitable for use in the presence of a FLAMMABLE ANESTHETIC MIXTURE WITH AIR or WITH OXYGEN OR NITROUS OXIDE
- According to the mode of operation:
CONTINUOUS OPERATION
- According to the installation and use:
PORTABLE EQUIPMENT
MOBILE EQUIPMENT (when the system is installed on the mobile trolley)



1.2 Meaning of Signal Words

In this manual, the signal words " **DANGER**", " **WARNING**", " **CAUTION**", "**NOTE**" and "Tips" are used regarding safety and other important instructions. The signal words and their meanings are defined as follows. Please understand their meanings clearly before reading this manual.

Signal word	Meaning
 DANGER	Indicates an imminently hazardous situation that, if not avoided, will result in death or serious injury.
 WARNING	Indicates a potentially hazardous situation that, if not avoided, could result in death or serious injury.
 CAUTION	Indicates a potentially hazardous situation that, if not avoided, may result in minor or moderate injury.
NOTE	Indicates a potentially hazardous situation that, if not avoided, may result in property damage.

Signal word	Meaning
Tips	Important information that helps you to operate the system more effectively.

1.3 Meaning of Safety Symbols

Symbol	Description
	Type-BF applied part. The ultrasound probes connected to this system are type-BF applied parts. The ECG module connected to this system is Type-BF applied part.
	Caution

1.4 Safety Precautions

Please observe the following precautions to ensure patient and operator's safety when using this system.

 **DANGER:** DO NOT use flammable gasses, such as anesthetic gas or hydrogen, or flammable liquids such as ethanol, near this system, because there is danger of explosion.

 **WARNING:**

1. Do connect the adapter power plug of this system and power plugs of the peripherals to wall receptacles that meet the ratings indicated on the rating nameplate. Using a multifunctional receptacle may affect the system protective grounding performance, and cause the leakage current to exceed safety requirements.
Use the cable provided with this system to connect the printer. Other cables may result in electric shock.
You must use the power adapter provided with the system; otherwise electric shock may result.
You can only adopt the power supply method provided by Mindray, other power supply modes (e.g. using a UPS) may result in electric shock.
2. Connect the protective grounding conductor before turning ON the system. Disconnect the grounding cable after turning OFF the system. Otherwise, electric shock may result.
3. For the connection of power and grounding, follow the appropriate procedures described in this operator's manual. Otherwise, there is risk of electric shock. DO NOT connect the grounding cable to a gas pipe or water pipe; otherwise, improper protective grounding may result or a gas explosion may occur.

4. **Before cleaning the system, disconnect the power cord from the outlet. System failure and electric shock may result.**
5. **This system is not water-proof designed. DO NOT use this system in any place where water or any liquid leakage may occur. If any water is sprayed on or into the system, electric shock or device malfunction may result. If water is accidentally sprayed on or into the system, power off the system immediately and contact Mindray Customer Service Department or sales representative.**
6. **DO NOT use a probe that has a damaged, scratched surface, or exposed wiring of any kind. Immediately stop using the probe and contact Mindray Customer Service Department or sales representative. There is risk of electric shock if a damaged or scratched probe is used.**
7. **DO NOT allow the patient to contact the live parts of the ultrasound system or other devices, e.g. signal I/O ports. Electric shock may occur.**
8. **Do not use an aftermarket probe other than those specified by Mindray. The probes may damage the system, causing a profound failure, e.g. a fire in the worst case.**
9. **Do not subject the probes to knocks or drops. Use of a defective probe may cause an electric shock.**
10. **Do not open the covers and front panel of the system. Short circuit or electric shock may result when the system hardware is exposed and powered on.**
11. **DO NOT use this system simultaneously with equipment such as an electrosurgical unit, high-frequency therapy equipment, or a defibrillator, etc. Otherwise, there is a risk of electric shock to the patient.**
12. **Only use the ECG leads provided with the ECG module; otherwise electric shock may result.**
13. **When moving the system, you should first fold the LCD display, disconnect the system from other devices (including probes) and disconnect the system from the power supply.**

14. **Accessory equipment connected to the analog and digital interfaces must comply with the relevant IEC standards (e.g., IEC 60950 information technology equipment safety standard and IEC 60601-1 medical equipment standard). Furthermore, all configurations must comply with the standard IEC 60601-1-1. It is the responsibility of the person, who connects additional equipment to the signal input or output ports and configures a medical system, to verify that the system complies with the requirements of IEC 60601-1-1. If you have any questions regarding these requirements, consult your sales representative.**
15. **Prolonged and repeated use of keyboards may result in hand or arm nerve disorders for some individuals. Observe the local safety or health regulations concerning the use of keyboards.**
16. **The operator SHOULD NOT touch SIP/SOP and the patient at the same time.**
17. **If the battery cannot be automatically maintained in a fully usable condition, please conduct periodic checking of the battery.**
18. **The ultrasound system use a mains plug as isolation means to the mains power supply. Please do not set the ultrasound system in a place difficult to operate the mains plug.**
19. **Do not modify this equipment without authorization of the manufacture.**

**CAUTION:**

1. **Precautions concerning clinical examination techniques:**

This system must be used only by qualified medical professionals.

This operator's manual does not describe clinical examination techniques. The clinician should select the proper examination techniques based on specialized training and clinical experience.
2. **Malfunctions due to radio wave:**
 - **If a radio wave emitting device is used in the proximity of this system, it may interfere with operations. DO NOT use or take any devices transmitting RF signals (such as cellular phones, transceivers and radio controlled products) in the room placing the system.**
 - **If a person brings a device that generates radio waves near the system, ask him / her to immediately turn OFF the device.**

- 3. Precautions concerning movement of the system:**
 - When you place the system on the mobile trolley and move them together, you must secure all objects on the mobile trolley to prevent them from falling. Otherwise you should separate the system from the mobile trolley and move them individually. When you have to move the system with the mobile trolley upward or downward the stairs, you must separate them first and then move them individually.
 - Object placed on the monitor may fall and injure an individual when moving.
 - Confirm that there is no peripheral device connected to the system before moving the system. Otherwise, peripheral device may fall and injure an individual.
- 4. DO NOT expose the system to excessive vibration through transportation. Mechanical damage may result.**
- 5. Do not connect this system to outlets with the same circuit breakers and fuses that control the current of devices such as life-support systems. If this system malfunctions and generates over current, or when there is an instantaneous current at power ON, the circuit breakers and fuses of the building's supply circuit may be tripped.**
- 6. Always keep the system dry. Avoid transporting this system quickly from a cold place to a warm place; otherwise condensation or water droplets may form allowing a short circuit and possible electric shock.**
- 7. If the circuit protector is tripped, it indicates that the system or a peripheral device was improperly shut down and the system is unstable. You cannot repair the system under this circumstance and must call the Mindray Customer Service Department or sales representative.**
- 8. There is no risk of high-temperature burns during normal ultrasound examinations. It is possible for the surface temperature of the probe to exceed the body temperature of a patient due to environmental temperature and exam mode combinations. Apply the probe only for a period of time required for the purpose of diagnosis.**
- 9. The system and its accessories are not disinfected or sterilized prior to delivery. The operator is responsible for the cleaning and disinfection of probes and sterilization of biopsy brackets according to the manuals, prior to the use.**

All items must be thoroughly processed to completely remove harmful residual chemicals, which will not only harmful to the human body, but also damage the accessory.

10. It is necessary to press [End Exam] to end the current scan that is in progress and clear the current Patient Information field. Otherwise, new patient data may be combined with the previous patient data.
11. **DO NOT** connect or disconnect the system's power cord or its accessories (e.g., a printer or a recorder) without turning **OFF** the power first. This may damage the system and its accessories or cause electric shock.
12. If the system is powered off improperly during operation, it may result in data damage of the system's hard disk or system failure.
13. Do not use the system to examine a fetus for a long period of time.
14. Do not use a USB memory device (e.g., a USB flash drive, removable hard disk) which has unsafe data. Otherwise, system damage may result.
15. It is recommended to only use the video devices specified in this manual.
16. Do not use gel, disinfectant, probes, probe sheath or needle-guided brackets that are not compatible with the system.
17. Read the Acoustic Output Principle in the operation manual carefully before operate this system on clinical examination.
18. Please use the ultrasound gel compliant with the relevant local regulations.
19. The system should be powered by battery when the integrality and reliability of the protective grounding of external power supply is indeterminate.
20. **DO NOT** touch the Signal I/O ports if in contact with the patient; otherwise patient injury may result.
21. When using intra-cavity transducers, do not activate the transducer outside the patient's body.

- NOTE:
1. **DO NOT** use the system in the vicinity of strong electromagnetic field (such as a transformer), which may affect the performance of the system.
 2. **DO NOT** use the system in the vicinity of high-frequency radiation source, which may affect the performance of the system or even lead to failure.

3. To avoid damaging the system, DO NOT use it in following environment:
 - (1) Locations exposed to direct sunlight.
 - (2) Locations subject to sudden changes in environmental temperature.
 - (3) Dusty locations.
 - (4) Locations subject to vibration.
 - (5) Locations near heat generators.
 - (6) Locations with high humidity.
4. Turn ON the system only after the power has been turned OFF for a while. If the system is turned ON immediately after being turned OFF, the system may not be rebooted properly and could malfunction.
5. When using or placing the system, keep the system horizontal to avoid imbalance.
6. Remove ultrasound gel from the face of a probe when the examination is complete. Water in the gel may enter the acoustic lens and adversely affect the performance and safety of the probe.
7. You should properly back up the system to a secure external storage media, including system configuration, settings and patient data. Data stored to the system's hard drive may be lost due to system failure, improper operation or accident.
8. Do not apply external force to the control panel; otherwise, the system may be damaged.
9. If the system is used in a small room, the room temperature may rise. Please provide proper ventilation and free air exchange.
10. To dispose of the system or any part, contact Mindray Customer Service Department or sales representative. Mindray is not responsible for any system content or accessories that have been discarded improperly.
11. Electrical and mechanical performance may be degraded due to long usage (such as current leakage or distortion and abrasion); the image sensitivity and precision may become worse too. To ensure optimal system operations, it is recommended that you maintain the system under a Mindray service agreement.
12. The iScape feature constructs a single extended image from a series of individual image frames. The quality of the final image is user-dependent and requires skill to efficiently apply the feature and technique. Exercise caution when measurements are performed from an iScape image.
13. Ensure that the current exam date and time are the same as the system date and time.
14. DO NOT turn OFF the power supply of the system during printing, file storage or invoking other system operations. An interrupted process may not be completed, and can become lost or corrupted.

Please read the following precautions carefully to ensure the safety of the patient and the operator when using the probes.



WARNING: 1.

The ultrasonic probe is only for use with the specified ultrasonic diagnostic system. Please refer to the ultrasonic diagnostic system operator's manual to select the proper probe.

2. Confirm that the probe and cable are normal before and after each examination. A defective probe may cause electric shock to the patient.
3. Do not subject the probe to shock. A defective probe may cause electric shock to the patient.
4. Do not disassemble the probe to avoid the possibility of electric shock.
5. Never immerse the probe connector into liquids such as water or disinfectant because the connector is not waterproof. Immersion may cause electric shock or malfunction.
6. A probe sheath must be installed over the probe before performing intra-cavity or biopsy examination.



CAUTION:

1. When using the probe, wear sterile gloves to prevent infection.
2. Be sure to use sterile ultrasound gel. Please use the ultrasound gel compliant with the relevant local regulations. And manage the ultrasound gel properly to ensure that it does not become a source of infection.
3. In normal diagnostic ultrasound mode, there is no danger of a normal-temperature burn; however, keeping the probe on the same region of the patient for a long time may cause such a burn.
4. Do not use the carrying case for storing the probe. If the carrying case is used for storage, it may become a source of infection.
5. It is required to practice ALARA when operating ultrasound system. Minimize the acoustic power without compromising the quality of images.
6. The probe and accessories supplied with it are not delivered disinfected or sterilized. Sterilization (or high-level disinfect) before use is required.
7. Disposable components are packaged sterile and are single-use only. Do not use if integrity of packaging violated or if expiration date has passed. Please use the disposable components compliant with the relevant local regulations.
8. Please use the disinfection or sterilization solution that recommended in this operator's manual; otherwise Mindray will not be liable for damage caused by other solutions. If you have any questions, please contact Mindray Customer Service Department or sales representative.
9. The probe sheath contains natural rubber that can cause allergic reactions in some individuals.

- Do not use pre-lubricated condoms as a sheath.**
10. Lubricant may not be compatible with the transducer material and damage may result.

Transducer damage may be caused by inappropriate gel, detergent or cleanser:

11. **Do not soak or saturate transducers with solutions containing alcohol, bleach, ammonium chloride compounds, acetone or formaldehyde.**

Avoid contact with solutions or coupling gels containing mineral oil or lanolin.

- NOTE:
1. Read the following precautions to prevent the probe from malfunction:
 - Clean and disinfect the probe before and after each examination.
 - After the examination, wipe off the ultrasound gel thoroughly. Otherwise, the ultrasound gel may solidify and the image quality would be degraded.
 2. Ambient conditions:

To prevent the probe from being damaged, do not use it where it will be exposed to:

 - Direct sunlight or X-rays
 - Sudden changes in temperature
 - Dust
 - Excessive vibration
 - Heat generators

Use the probes under the following ambient conditions:

 - ambient temperature: 0°C ~ 40°C
 - relative humidity: 30% ~ 85% (no condensation)
 - atmospheric pressure: 700 hPa ~ 1060 hPa.

Use the L16-4Hs/4CD4s probe under the following ambient conditions:

 - ambient temperature: 10°C ~ 40°C
 - relative humidity: 30% ~ 85% (no condensation)
 - atmospheric pressure: 700 hPa ~ 1060 hPa
 3. Repeated disinfection will eventually damage the probe, please check the probe's performance periodically.

1.5 Latex Alert

When choosing a probe sheath, it is recommended that you directly contact CIVCO for obtaining probe sheath, pricing information, samples and local distribution information. For CIVCO information, please contact the following:

CIVCO Medical Instruments

Tel: 1-800-445-6741

WWW.civco.com



⚠️ WARNING: Allergic reactions in latex (natural rubber) sensitive patients may range from mild skin reactions (irritation) to fatal anaphylactic shock, and may include difficulty in breathing (wheezing), dizziness, shock, swelling of the face, hives, sneezing or itching of the eyes (FDA Medical Alert on latex products, “Allergic Reactions to Latex-containing Medical Devices”, issued on March 29, 1991).

1.6 Warning Labels

The warning labels are attached to this system in order to call your attention to potential hazards.

The warning labels use the same signal words as those used in the operator’s manual. Read operator’s manual carefully before using the system.

The name, pattern and meaning of each warning label are described as follows:

No.	Warning Labels	Meaning
1		Please carefully read this manual before use device.
2	<p>The following labels are available when the system works with the mobile trolley.</p> 	<p>a. Do not place the device on a sloped surface. Otherwise the device may slide, resulting in personal injury or the device malfunction. Two persons are required to move the device over a sloped surface.</p> <p>b. Do not sit on the device.</p> <p>c. DO NOT push the device when the casters are locked.</p>
3	<p>ETL CLASSIFIED</p>  <p>Intertek 3179617</p>	<p>CONFORMS TO AAMI STD 60601-1, IEC STD 60601-2-37, IEC STD 60601-2-18;</p> <p>CERTIFIED TO CSA STD C22.2 NO. 60601-1, 60601-2-37, 60601-2-18</p>

2 System Overview

2.1 Intended Use

The M7/ M7T/ M7 Premium/ M7 Expert/ M7 Super Diagnostic Ultrasound System is applicable for adults, pregnant women, pediatric patients and neonates. It is intended for use in gynecology, obstetric, abdominal, pediatric, small parts (breast, testes, thyroid), neonatal cephalic, transcranial, cardiac, transvaginal, transrectal, peripheral vascular, urology, orthopedic, and musculoskeletal (conventional and superficial), Intraoperative and Transesophageal (cardiac) exams.

2.2 Contraindication

The diagnostic ultrasound system is not intended for ophthalmic use.

2.3 Product and Model Code



NOTE: The functions described in the operator's manual may vary depending upon the specific system you purchased.

2.4 Product Specifications

2.4.1 Imaging Modes

B Mode	B
M Mode	M Anatomical M: Free Xros M, Free Xros CM Color M Mode (CM)
C Mode	Color Power (Dirpower)
D Mode	PW Doppler CW Doppler
Special Imaging	Smart 3D Static 3D 4D iScape TDI (Tissue Doppler imaging)

2.4.2 Power supply

Voltage	100-240V~ (AC adapter) 100-127V~, 50/60Hz (when configured with mobile trolley UMT-300)
Frequency	50/60Hz (AC adapter)
Input Power	1.5 – 0.6A (AC adapter) 600 VA (when configured with mobile trolley UMT-300)
Fuse	250V~ T3.15AL(when configured with mobile trolley UMT-300)

2.4.3 Environmental Conditions

	Operating conditions	Storage and transportation conditions
Ambient temperature	0°C~40°C	-20°C~55°C
Relative humidity	30%~85% (no condensation)	30%~95% (no condensation)
Atmospheric pressure	700hPa~1060hPa	700hPa~1060hPa



WARNING: Do not use this system in the conditions other than those specified.

2.4.4 External Dimensions and Weight

- External dimensions: 361mm(H)×357mm(L)×75mm(W)
- Net weight: 5.05Kg (including no batteries, CW board or 4D board)

2.5 System Configuration

2.5.1 Standard Configuration

- Main unit
- Accessories
 - Operator's manuals
 - Ultrasound gel (made by Eco-Med Pharmaceuticals, model: Eco Gel 200)
 - Power adapter and connecting cable
 - Batteries
 - Multilingual controls overlay
 - Travelling case

2.5.2 Options

2.5.2.1 Probes and Needle-guided Brackets Available

Probe model	Type	Intended Use	Region Applied
C5-2s	Convex	Fetal, abdominal, pediatric, peripheral vascular	Body surface
7L4s	Linear	Abdominal, pediatric, small organ (breast, thyroid, testes), neonatal cephalic, musculo-skeletal (conventional, superficial), peripheral vascular	Body surface
L7-3s	Linear	Abdominal, pediatric, small organ (breast, thyroid, testes), musculo-skeletal (conventional, superficial), peripheral vascular	Body surface
L12-4s	Linear	Abdominal, pediatric, small organ (breast, thyroid, testes), neonatal cephalic, musculo-skeletal (conventional, superficial), peripheral vascular	Body surface
L14-6s	Linear	Pediatric, small organ (breast, thyroid, testes), neonatal cephalic, musculo-skeletal (conventional, superficial), peripheral vascular	Body surface

Probe model	Type	Intended Use	Region Applied
7L5s	Linear	Pediatric, small organ (breast, thyroid, testes), musculo-skeletal (conventional, superficial), peripheral vascular	Body surface
P4-2s	Phased	Abdominal, pediatric, neonatal cephalic, adult cephalic, cardiac adult, cardiac pediatric	Body surface
P7-3s	Phased	Abdominal, pediatric, neonatal cephalic, adult cephalic, musculo-skeletal conventional, cardiac adult, cardiac pediatric	Body surface
P12-4s	Phased	Abdominal, pediatric, neonatal cephalic, adult cephalic, cardiac adult, cardiac pediatric	Body surface
V10-4s	Transvaginal	Fetal, trans-rectal, trans-vaginal, urology	Transvaginal
V10-4Bs	Transvaginal		Transvaginal
4CD4s	4D convex	Fetal, abdominal, pediatric	Body surface
6C2s	Convex	Abdominal, pediatric, neonatal cephalic, adult cephalic, musculo-skeletal (conventional, superficial), peripheral vascular	Body surface
L14-6Ns	Linear	Pediatric, small organ (breast, thyroid, testes), musculo-skeletal (conventional, superficial), peripheral vascular	Body surface
CW2s	Pencil probe	Pediatric, adult cephalic, adult cardiac, pediatric cardiac	Body surface
7LT4s	Linear	Abdominal, Intraoperative (abdominal, thoracic, and vascular), Pediatric, Small Organ (breast, thyroid, testes), Neonatal Cephalic, Musculo-skeletal (Conventional and Superficial), Peripheral Vascular	Intra-operative
P7-3Ts	Phased probe	Trans-esoph.(Cardiac)	Transesophageal
CW5s	Pencil probe	Pediatric, adult cephalic, adult cardiac, pediatric cardiac	Body surface
SP5-1s	Phased probe	Abdominal, pediatric, neonatal cephalic, adult cephalic, cardiac adult, cardiac pediatric	Body surface
C11-3s	Convex	Abdominal, pediatric, neonatal cephalic, adult cephalic, musculo-skeletal (conventional, superficial), peripheral vascular	Body surface
L16-4Hs	Linear	Abdominal, intra-operative, pediatric, small organ (breast, thyroid, testes), neonatal cephalic, musculoskeletal (conventional and superficial)	Body surface

Note: Probe 7LT4s and P7-3Ts are not available with 03.02.00 version software.

Some of the probes have matched needle-guided brackets for biopsy, the available probes and the corresponding needle-guided brackets are listed as follows:

Probe Model	Needle-guided Bracket Model	Biopsy Angle/Depth ($\pm 1^\circ$)	Applicable Biopsy Needle
V10-4s/ V10-4Bs/	NGB-004 Metal/needle un-detachable	/	16G, 17G, 18G
6C2s	NGB-005 (metal/needle un-detachable)	12.7°, 24.2°	13G, 15G, 16G, 18G, 20G
L7-3s/ 7L4s/ L12-4s/ 7L5s/ L14-6Ns	NGB-007 Plastic/needle detachable; Metal/needle detachable	40°, 50°, 60°	Metal: 14G, 16G, 18G, 20G, 22G Plastic: 13G, 15G, 16G, 18G, 20G
P4-2s/SP5-1s	NGB-011 Metal/needle un-detachable	11°, 23°	13G, 15G, 16G, 18G, 20G
C5-2s	NGB-015 Metal/needle detachable	25°, 35°, 45°	14G, 16G, 18G, 20G, 22G
L14-6s	NGB-016 Metal/needle detachable	30°, 40°, 50°	14G, 16G, 18G, 20G, 22G
7LT4s	NGB-010 (metal/needle detachable)	30°, 40°, 50°	13G, 15G, 16G, 18G, 20G
C11-3s	NGB-018 metal/needle detachable	15°, 25°, 35°	14G, 16G, 18G, 20G, 22G

Note: NGB-010 bracket is not available with 03.02.00 version software.

2.5.2.2 Options

No.	Item
1.	iClear module
2.	CW module (requires to be configured in factory)
3.	iScape module
4.	Free Xros M module
5.	Free Xros CM module (Curved Free Xros M)
6.	Smart 3D module
7.	4D module (requires to be configured in factory)
8.	TDI (Tissue Doppler imaging) module
9.	TDI Quantitative Analysis (Only can be applied with TDI module configured)

No.	Item
10.	IMT module (Only can be applied with the Vascular Package configured)
11.	Abdominal Package(including relevant exam mode, comments, measurements, body marks and report)
12.	Obstetrical Package(including relevant exam mode, comments, measurements, body marks and report)
13.	Gynecological Package(including relevant exam mode, comments, measurements, body marks and report)
14.	Cardiac Package(including relevant exam mode, comments, measurements, body marks and report)
15.	Small Parts Package(including relevant exam mode, comments, measurements, body marks and report)
16.	Urological Package(including relevant exam mode, comments, measurements, body marks and report)
17.	Vascular Package(including relevant exam mode, comments, measurements, body marks and report)
18.	Pediatric Package(including relevant exam mode, comments, measurements, body marks and report)
19.	Nerve Package(including relevant exam mode, comments, measurements, body marks and report)
20.	Emergency Medicine Package(including relevant exam mode, comments, measurements, body marks and report)
21.	DICOM Basic module (including: task management, DICOM storage, DICOM print, DICOM storage commitment, DICOM media storage (including DICOM DIR) and etc.)
22.	DICOM Worklist module (only can be applied with the DICOM basic function module configured)
23.	DICOM MPPS (only can be applied with the DICOM basic function module configured)
24.	DICOM OB/GYN structured report (only can be applied with the DICOM basic function module configured)
25.	DICOM Vascular structured report (only can be applied with the DICOM basic function module configured)
26.	DICOM Cardiac structured report (only can be applied with the DICOM basic function module configured)
27.	DICOM Query/Retrieve (only can be applied with the DICOM basic function module configured)
28.	DVD R/W Drive: Model: SE-S224Q (USB port)
29.	I/O Extend Module (IOM-21, with DVI-to-VGA port)
30.	Probe Extend Module: PEM-21, support all optional probes except pencil probe.
31.	V/A Extend Module (VAM-11)

No.	Item
32.	ECG module (ECG-21: only can be applied with I/O Extend Module configured)
33.	ECG Lead
34.	Footswitch: 971-SWNOM (2-pedal) 971-SWNOM(3-pedal) FS-81-SP-2 (1-pedal)
35.	Mobile Trolley: UMT-200, UMT-300 Options for UMT-300: power module, probe extend module PEM-21, built-in DVD R/W drive, display module SMM-11; where, SMM-11 can be applied only when I/O extend module and power module are configured, and the built-in DVD R/W driver can be applied only when power module is configured.
36.	Pack
37.	Dust-proof cover
38.	Battery Pack (LI23I001A)
39.	Wireless adapter
40.	iNeedle
41.	Stress Echo
42.	Contrast Imaging
43.	Strain Elastography

Note: iNeedle feature and Stress Echo feature do not apply to 03.02.00 version software.

2.5.2.3 Peripherals Supported

No.	Item	Model
1.	Black /white video printer	MITSUBISHI P93W-Z; SONY UP-X898MD SONY UP-D898MD; MITSUBISHI P95DW-N
2.	Color video printer	SONY UP-D25MD
3.	Graph / text printer	HP OfficeJet J3600 (HP Officejet J3608 All-in-One) HP Color LaserJet CM1015 HP Deskjet D2568
4.	Barcode reader	SYMBOL LS2208(1-D) SYMBOL DS4308(2-D)

■ Parts can be used in the patient environment:

- Main unit;
- Probes;
- Footswitch;
- Printers: MITSUBISHI P93W-Z; SONY UP-X898MD, SONY UP-D898MD; MITSUBISHI P95DW-N, SONY UP-D25MD





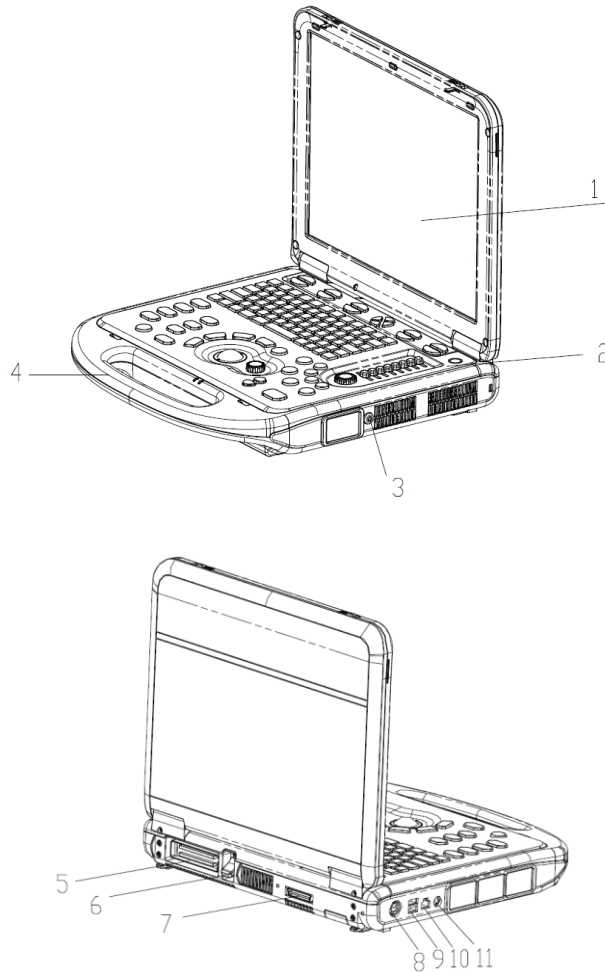

**WARNING:**

This system complies with IEC60601-1-2:2007, and its RF emission meets the requirements of CISPR11 Class B. In a domestic environment, the customer or the user should guarantee to connect the system with Class B peripheral devices; otherwise RF interference may result and the customer or the user must take adequate measures accordingly.

2.6 Introduction of Each Unit



No.	Name	Function
1	Monitor	Displays the images and parameters during scanning.
2	Control Panel	Operator-system interface or control.
3	CW pencil probe port	Connects the pencil probe to the main unit
4	Handle	Used for carrying the system.
5	Probe port 	Connects a probe to the main unit; or connects a probe extend module.

No.	Name	Function
6	Transducer locking lever	Locks or unlocks the probe connected with the main unit.  : locked symbol  : unlocked symbol
7	I/O extend port 	Connects the I/O extend module.
8	Power input port 12V  9A (Max.)	Connects the power adapter.
9	USB port 	Connects USB devices.
10	Network port 	Connects the network.
11	S-Video separate video output 	Connects DVR recorder or video printer.

2.7 Mobile trolley

The system can be configured with 2 models of mobile trolley: UMT-200 and UMT-300. Mobile Trolley is used for placing the ultrasound system, extend modules and etc.

 WARNING:	<ol style="list-style-type: none"> 1. Be sure to connect the equipotential wire before inserting the power plug into the receptacle; be sure to remove the power plug from the receptacle before disconnecting the equipotential wire; otherwise electric shock may result. 2. When you connect another device to the trolley, you should use the equipotential wire to connect each of equipotential terminals; otherwise electric shock may result. 3. Connect the earth cable before powering ON. Disconnect the earth cable after powering OFF. Otherwise, electric shock may result. 4. DO NOT connect the trolley to the outlets with the same circuit breakers and fuses that control the current to devices such as life-support systems. If the trolley or the system malfunctions and generates over-current, or when there is an instantaneous current at power ON, the circuit breakers and fuses of the building's supply circuit may be tripped. 5. If UMT-300 has configured with display module, please take care of the display module position to leave enough space below when adjusting the display support arm, so that the display module will not hit into the monitor of the ultrasound system.
---	---

**CAUTION:**

1. When moving the trolley with mounted system, please take care of the connector of the power adapter in case of damage.
2. Maximum output power of the outlet in the trolley is 350VA.

NOTE

1. If UMT-300 has configured with display module, please take care of the display module position in case of hurting one's head.
2. If probe extend module is configured, please do not place any objects under the module.

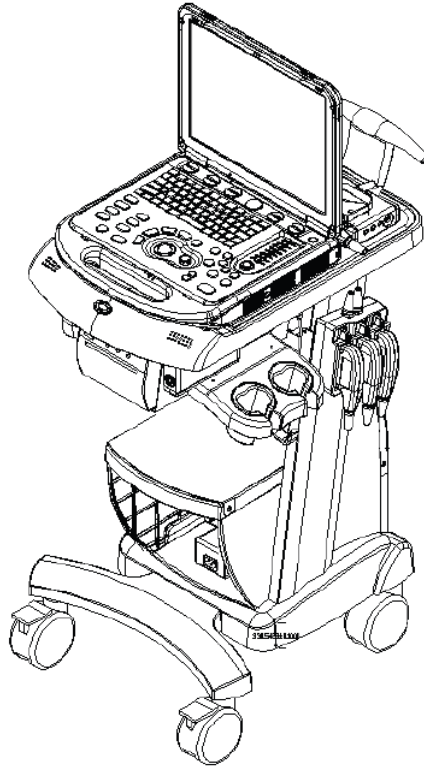
UMT-200

UMT-300

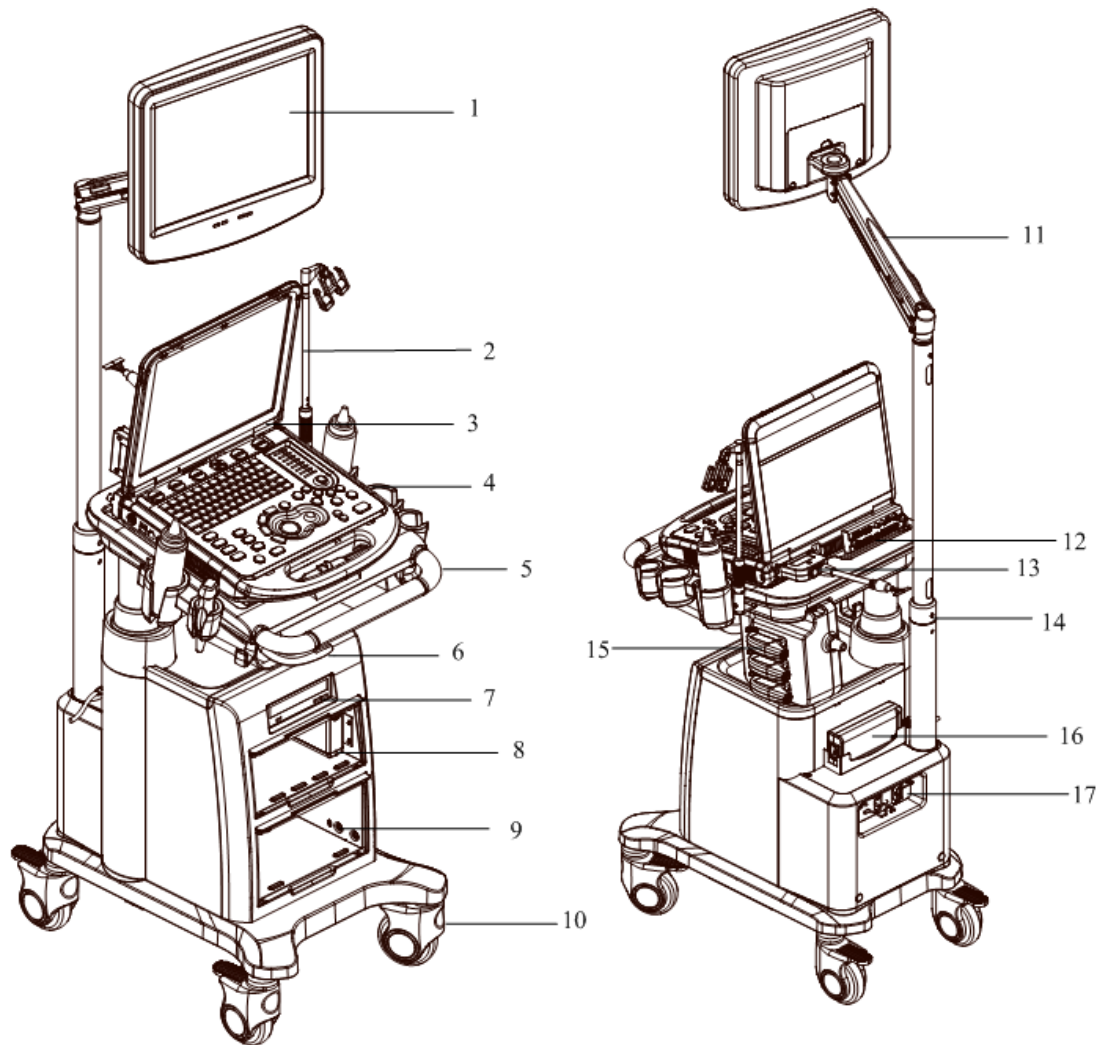

No.	Name	Function
1	Display module	Displays the image and parameters during scanning
2	Probe cable hook	Probe cable hanger
3	Ultrasound system	/
4	Probe holder	Used for placing probes temporarily
5	Operating platform	To place the ultrasound system
6	Adjustable telescopic column switch	Raise the handle to adjust height of the platform
7	Built-in DVD RW drive	DVD-RW drive
8	Compartment for placing ECG module or B/W printer	/
9	Compartment for placing color printer	/

No.	Name	Function
10	Caster	Used for securing or moving the system
11	Display support arm	Supports the display module, for adjusting the height and position of the display module.
12	I/O extend module	To extend I/O ports
13	Probe port	To connect probe or probe extend module.
14	Adjustable telescopic column	To adjust height of the operating platform
15	Probe extend module	To extend ports for connecting probes
16	Power adapter	/
17	Power module	Power supply input/output interface, equipotential terminal, breaker and power indicator

■ Power Panel

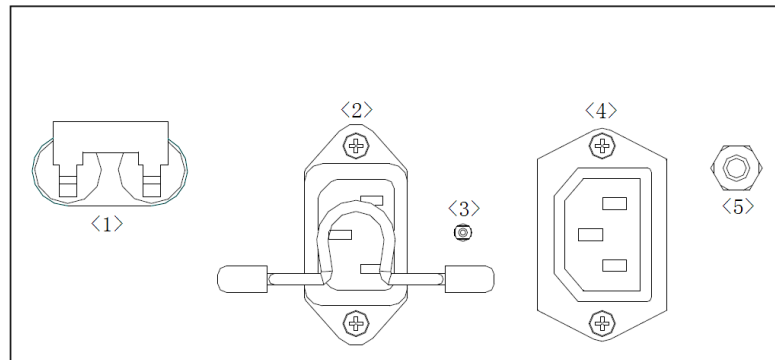

No.	Name	Function
1	Circuit breaker	Switch on or off the mains power supply
2	Power inlet	AC power inlet
3	Power indicator	Indicates if the trolley is connected to the mains power supply: If connected with mains power and the breaker is on, the indicator illuminates in green color If not connected with mains power or the breaker is off, the indicator does not illuminate
4	Power outlet	Supply power for optional peripheral devices (e.g. DVR)
5	Equipotential terminal	Used for equipotential connection, to balance the protective earth potentials between the system and other electrical equipment

2.8 Extend Modules

There are four extend modules available for the system:

- Probe extend module
- I/O extend module
- V/A extend module
- ECG module

2.8.1 Probe Extend Module

■ Overview

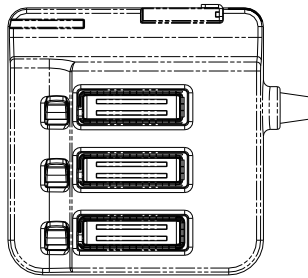

■ To connect the module:

- Insert the module connector into the probe port with its bulge facing to the right side of the system (when you are facing to the front of the system).
- Toggle the lock lever to the top position.

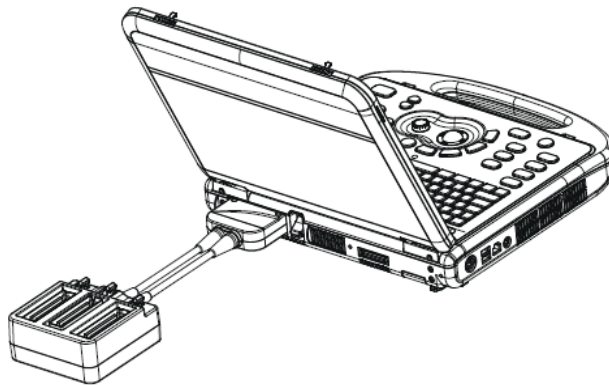

CAUTION: You must turn off the ultrasound system before connecting or disconnecting the probe extend module. Otherwise the system may be damaged.







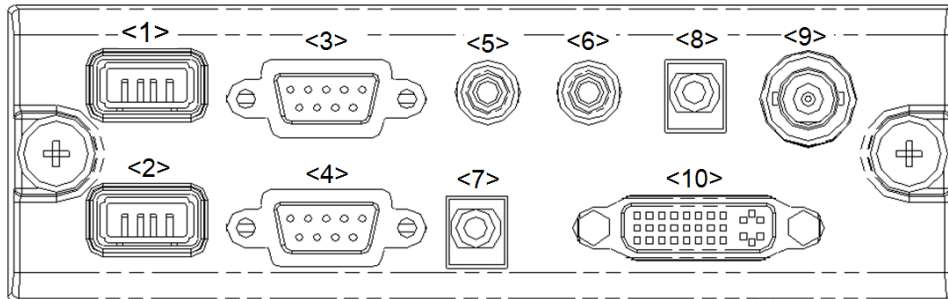

NOTE:

1. Before connecting/disconnecting the probe extend module, please freeze the image first to keep the module in a good condition.
2. If you use the probe extend module to connect a probe, the image quality may be degraded.

2.8.2 I/O extend module

■ Overview



No.	Symbol	Function
<1>, <2>	USB port 	Connects USB devices.
<3>	ECG Port 	Connects the ECG module
<4>	Serial port 	Connects serial port devices
<5>, <6>	Audio output port 	Used for audio signals of Doppler mode sound from DVD output or audio comments
<7>	Mic In port 	Reserved. (Connects a microphone used for receiving audio comments when a recorder is used to record images)
<8>	Remote control port 	Connects the control port of the video printer
<9>	Composite video output port 	Used for receiving the output image signal of the video printer or DVD recorder
<10>	DVI-I output port 	Connects a display or projector

■ To connect the module:

Connect the I/O extend module to the main unit via the I/O extend port, thus the data port is extended. As shown in the following figure.

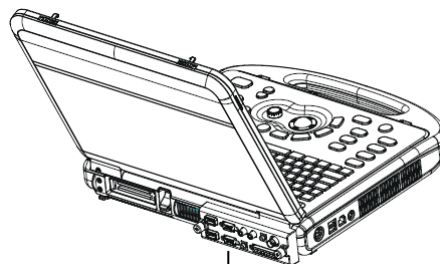

I/O Extend Module

CAUTION: When connects serial port devices (via port <4>) or the ECG module (via port <3>), you should first freeze the image or power off the machine, or malfunction may result.

2.8.3 V/A Extend Module

■ Overview

The module is connected to the USB port of the main unit via a USB cable.

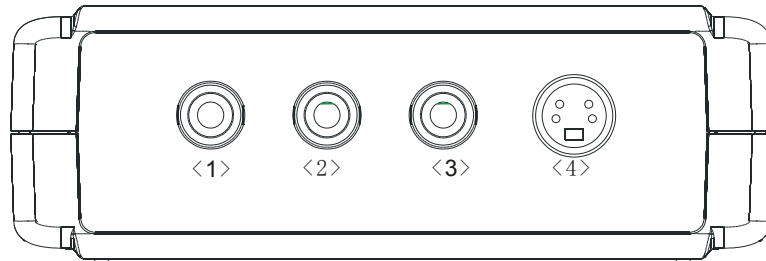

No.	Name	Function
<1>, <2>	Audio input port	Used for audio signal input
<3>	Composite video input port	Used for composite signal video input
<4>	Separate video input port	Used for separate signal video input

■ Connection

Connect the V/A extend module to the main unit via a USB port. As shown in the following figure.

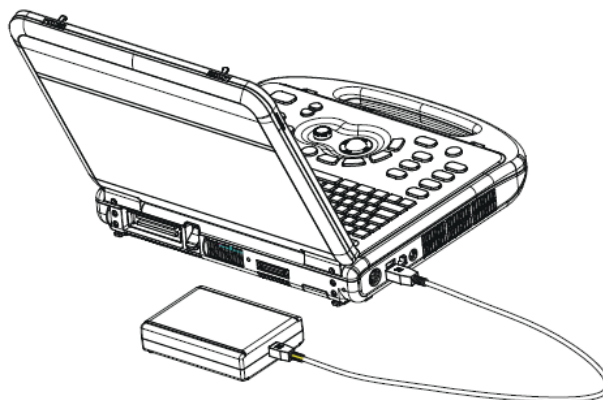



2.8.4 ECG module

■ Overview

To connect the ECG module, the system should also be configured with the I/O extend module.

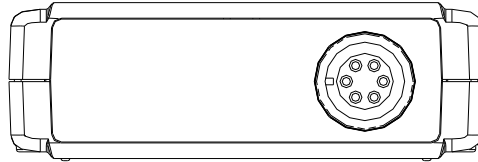
The ECG module is connected to main unit via connection to the I/O extend module.



Name	Function
ECG lead port 	Used for ECG signal input

■ Connection

Connect the ECG module to the main unit via the I/O extend module, see "2.8.2 I/O extend module" for details). As shown in the following figure.

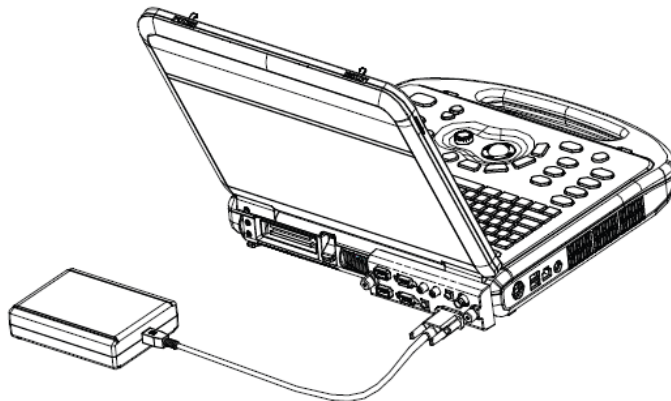

NOTE: You must turn off the ultrasound system before connecting or disconnecting the ECG module. Otherwise the system or the module may be damaged.

2.9 Control Panel

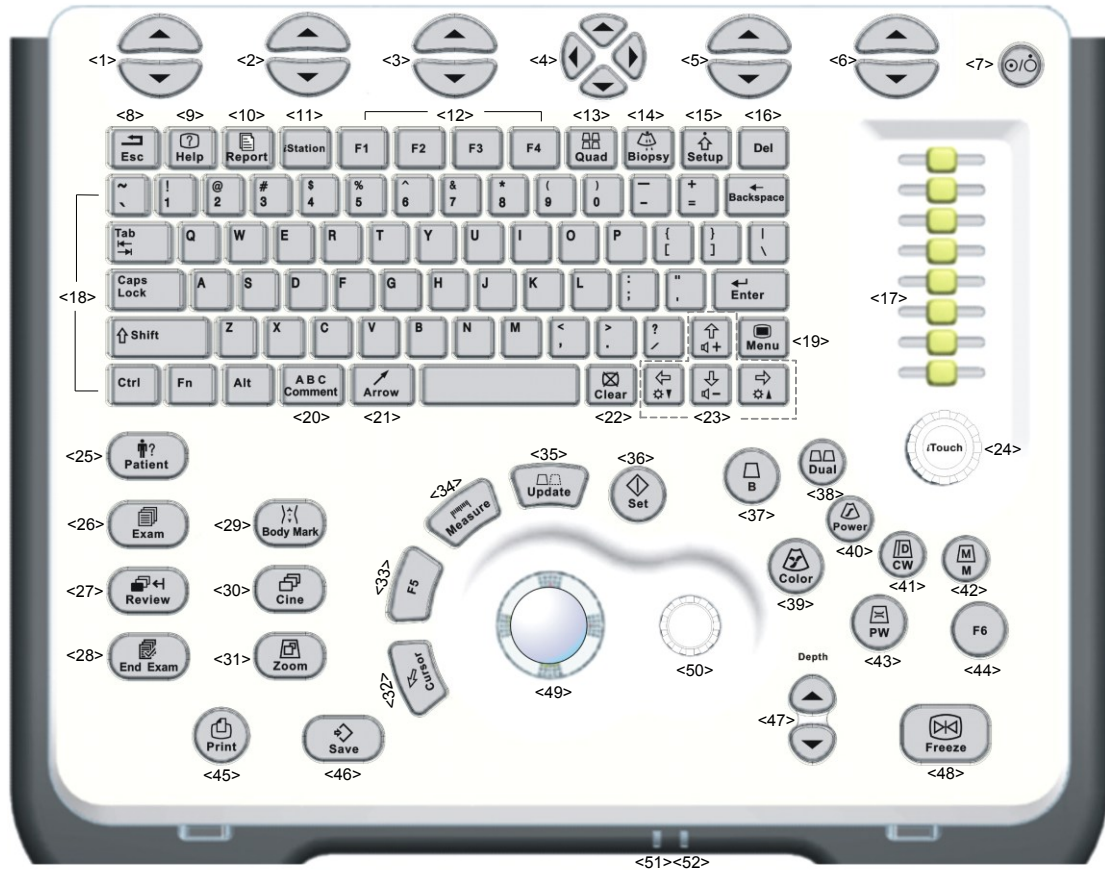

No.	Name	Description	Function
<1>	/	Soft menu controls 1	Press to select the soft menu items displayed on the bottom of the screen. Refer to the subsequent contents for specific functions.
<2>	/	Soft menu controls 2	Press to select the soft menu items displayed on the bottom of the screen. Refer to the subsequent contents for specific functions.
<3>	/	Soft menu controls 3	Press to select the soft menu items displayed on the bottom of the screen. Refer to the subsequent contents for specific functions.
<4>	/	Soft menu controls 4	Up/ down controls are used to turn pages up/down when there is more than one page for the soft menu. Left/ right keys are used to switch among the different modes.

No.	Name	Description	Function
<5>	/	Soft menu controls 5	Press to select the soft menu items displayed on the bottom of the screen. Refer to the subsequent contents for specific functions.
<6>	/	Soft menu controls 6	Press to select the soft menu items displayed on the bottom of the screen. Refer to the subsequent contents for specific functions.
<7>	/	Power button	It does not illuminate when the system is turned off. Press the button to turn on the system, the system enters work status and the indicator lights on and becomes green. When the system enters the standby status, the indicator turns orange.
<8>	Esc	Exit	Press to exit the current status to the previous status.
<9>	Help	Help	Press to open or close the accompanying help documents.
<10>	Report	Report	Press to open or close the diagnosis reports.
<11>	iStation	/	Press to enter or exit the patient information management system.
<12>	F1-F4	User-defined key	You can assign a function to the key.
<13>	Quad	Quad-split screen	Press to enter Quad mode. Switch image windows in the Quad mode.
<14>	Biopsy	Biopsy	Press to show or hide the biopsy guide line.
<15>	Setup	Setup	Press to show the Setup menu.
<16>	Del	/	Press to delete the comment, etc.
<17>	TGC	/	Move to adjust time gain compensation.
<18>	/	Alphanumeric keys	Same as those of PC.
<19>	Menu	Main menu	Press to display or hide a mode-specific parameter menu.
<20>	Comment	ABC (Comments)	Press to enter or exit the character comment status.
<21>	Arrow	Arrow	Press to enter or exit the arrow comment status.
<22>	Clear	Clear	Press to clear the comments or measurement calipers on the screen.
<23>	Direction keys		Press "Fn+/" to adjust volume or monitor brightness

























No.	Name	Description	Function
<24>	iTouch	/	Rotate to increase or decrease the image gain. Press to optimize the image, serving as a one-key optimization.
<25>	Patient	Patient Information	Press to enter the [Patient Info] screen.
<26>	Exam	Exam Type	Press to select an exam mode and a probe.
<27>	Review	Review	To review the stored images.
<28>	End Exam	End Exam	Press to end an exam.
<29>	Body Mark	Body Marks	Press to enter or exit the Body Mark status.
<30>	Cine	Cine Review	Press to enter or exit the Cine Review status.
<31>	Zoom	Zoom	Press to enter or exit the Zoom status.
<32>	Cursor	Cursor	Press to show the cursor.
<33>	F5	User-defined key	You can assign a function to the key.
<34>	Measure	Measurement	Press to enter or exit the measurement state.
<35>	Update	/	Press to change the currently active window. Or start/stop image acquisition in iScape or 3D/4D.
<36>	Set	Set	Press to confirm an operation, same as the left-button of the mouse.
<37>	B	/	Press to enter B mode
<38>	Dual	/	Press to enter Dual mode from another modes. Press to switch between the two windows in Dual mode.
<39>	Color	/	Press to enter Color mode.
<40>	Power	/	Press to enter Power mode.
<41>	CW	/	Press to enter CW mode.
<42>	M	/	Press to enter M mode.
<43>	PW	/	Press to enter PW mode.
<44>	F6	User-defined key	You can assign a function to the key.
<45>	Print	Print	Press to print; user-defined key.
<46>	Save	Save	Press to save; user-defined key.
<47>	Depth	Depth	Press to increase or decrease the imaging depth in scanning mode.
<48>	Freeze	Freeze	Press to freeze or unfreeze the image.
<49>	/	Trackball	Roll the trackball to change the cursor position.

No.	Name	Description	Function
<50>	/	Multifunctional knob	<p>Rotate to adjust image parameters or direction of comment arrows.</p> <p>Press to show the menu, rotate to select the item.</p>
<51>	/	Indicator 1	<p>Indicates if the main unit is connected to the power supply.</p> <p>If not connected, the indicator does not illuminate.</p> <p>If connected, the indicator illuminates in green color.</p>
<52>	/	Indicator 2	<p>Indicates the current status of the batteries.</p> <p>When the system is supplied with power by the batteries and the power capacity is lower than 30%, the indicator is yellow and flashes.</p> <p>When the batteries are being charged, the indicator light is on and in yellow color.</p> <p>When the battery capacity is charged to the full capacity, the indicator color turns green.</p> <p>In other statuses, the indicator light is off.</p>

Tip: “/” means the key / knob has no silk-printed name.

2.10 Symbols

This system uses the symbols listed in the following table, and their meanings are explained as well.

No.	Symbol	Description
1		Type-BF applied part
2		Caution
4		No user serviceable parts (applied to the power adapter)
5		Indoor, dry location use only (applied to the power adapter)
6		Power button
7		Probe port
8		Network port
9		USB port
10		S-VIDEO signal interface; VIDEO signal interface
11		AC (Alternating current)
12		Battery Status Indicator
13		Pencil probe port (reserved)
14		I/O extend port
15		Probe connection unlocked symbol
16		Probe connection locked symbol
17		Battery installation position indicator
18		Connects serial port devices
19		ECG function
20		Connects a display or projector
21		Audio signal
22		Microphone input jack
23		Remote control port
24		Product serial number
25		Manufacture date

3 System Preparation

3.1 Move/Posit the System

Please read and understand the safety precautions before placing the system to ensure safety for both operator and device.

1. Turn off the power and disconnect the system from all peripherals.
2. Carry the system by holding the handle.
3. Place the system in a desired location.
4. Leave at least 20cm at the back and both sides of the system.

 **CAUTION:** Maintain a generous-free air flowing space around the back and both sides of the system; failure may result due to increased rise in system operating temperature.

3.2 Power Supply

This system can work normally only when it is connected to the external power supply or the battery capacity is sufficient.

3.2.1 Connecting the External Power Supply

1. Connect the connector of the power adapter to the adapter port in the system.
 2. Use a three-wire cable to connect the adapter with the external power supply.
 3. The external power supply system must meet the following requirements:
 - Power supply voltage: 100-240V~
 - Power supply frequency: 50/60Hz
 - Input current: 1.5- 0.6A
- The model of the power adapter: ADP1210-01.

If you have any question about the power adapter, please contact your sales representative.

NOTE: 1. You must use the specified power adapter.
2. Do not use this power adapter in the conditions other than those specified.

3.2.2 Powered by Batteries

- When connected to the external power supply, the system is powered by the external power. The lithium ion batteries inside it are in the charging status.
- When disconnected from the external power supply, the system is powered by the lithium ion batteries. Refer to “Chapter 15 Batteries” for the detailed operations and precautions.

3.3 Power ON /OFF

3.3.1 Powering ON the System

 **CAUTION:** To ensure safe and effective system operation, you must perform daily maintenance and checks.

If the system begins to function improperly – immediately stop scanning. If the system continues to function improperly – fully shut down the system and contact Mindray Customer Service Department or sales representative.

If you use the system in a persistent improperly functioning state – you may harm the patient or damage the equipment.

- Checking before Power ON

To check the system before the system is turned on:

No.	Check Item
<1>	The temperature, relative humidity and atmospheric pressure shall meet the requirements of operating conditions. See "2.4.3 Environmental Conditions" for details.
<2>	There shall be no condensation.
<3>	There shall be no distortion, damage or dirt on the system and peripheral devices. If any dirt is found, cleaning shall be performed as defined in section “19.1.1 Cleaning the System”.
<4>	There shall be no loose screws on the monitor or control panel.
<5>	There shall be no cable damage (e.g. power cord). Maintaining secure connections to the system at all times.
<6>	The probes and probe cables shall be free of damage or stains. See chapter 12 for details on probe cleaning and disinfection.
<7>	No miscellaneous odds and ends are allowed to be attached or affixed to the control panel.
<8>	Ensure that all connections are free from damage and remain clear of foreign object blockages. There shall be no obstacles around the system and its air vent.
<9>	Probe cleaning and disinfection. (Please refer to “12 Probe and Biopsy” for details)

No.	Check Item
<10>	The overall scanning environment and field must be clean.

■ Turning on the Power

To turn on the system:

1. Press the power button in the upper right corner on the control panel
2. The system enters the work status.
3. The indicator lights on and becomes green.

■ To check the system after it is turned on

Press the power button in the upper right corner on the control panel to turn on the system.

To check the system after the system is turned on:

No.	Check Item
<1>	There shall be no unusual sounds or smells indicating possible overheating.
<2>	There shall be no persistently displayed system error message.
<3>	There shall be no evident excessive noise, discontinuous, absent or black artifacts in the B mode image.
<4>	Check if there is abnormal heat on the surface of the probe during an ultrasound procedure.
<5>	The control panel keys and knobs are fully functional.
<6>	The exam date and time are the same as the system date and time, and are displayed correctly.

 <p>WARNING:</p>	<ol style="list-style-type: none"> 1. If you use a probe giving off excessive heat, it may burn the patient. 2. If you find anything not functioning properly, this may indicate that the system is defective. In this case, shut down the system immediately and contact Mindray Customer Service Department or sales representative.
--	--

<p>NOTE: When you start the system or switch between probes, you will hear clicking sounds – this is expected behavior.</p>
--

3.3.2 Powering OFF the System

You need to follow the correct procedures to power off the system. In addition, after you upgrade the software or when the system is down, you need to power off and restart it.

If you will not use the system for a long period of time, you shall:

1. Disconnect the power adapter.
2. Disconnect the mains power.
3. Turn off powers of all peripherals connected to the system.

- To power off your system normally:

Gently press the power button once on the upper right corner of the control panel. The [Shutdown Confirm] screen appears. As the following:



- Shut down: To power off the system normally.
- Standby: Click to enter the standby status.
- Cancel: to cancel the operation.

- To shut down the system in a direct way if you cannot do it normally:

Press and hold the power button for a long time and the system will power off without displaying the [Shutdown Confirm] screen. However, shutting down the system this way may destroy the data.

NOTE: 1. DO NOT rush shutdown of the system in a direct way. It may destroy the data.
2. After the software upgrade, please shut down the system in the normal way (using "Shut down" method) so as to guarantee a fully update.

3.3.3 Standby

Definition of standby: in a normal environmental temperature and humidity condition, the system is connected with only one probe while no other external devices or extend modules are connected, only 3V3_STB and 5V_STB power supply is available and in the meantime, the standby indicator is in orange.

When the battery capacity is charged to the full capacity, the standby time of the system is no less than 64 hours.

- To enter standby:

- Fully fold the LCD display and wait for 30 sec, then the system enters the standby status.
- Open [Setup]→[System Preset]→"General" to set the time for screensaver and standby. If there is no operation, the system enters screensaver after the waiting time set for screensaver, and if there is still no operation, the system enters standby after the waiting time for standby.
- Press the power button and select "Standby".

When the system enters the standby status, the power button backlight turns orange.

- To exit standby

- Unfold the LCD display.
- Press the power button.

- When the system enters the standby status, if need to power off:

- Long press the power button for 8s.

Press the power button to exit the standby status and then power off the system.

- NOTE:**
1. Power off the system if you will not use the system for a long period of time (including storage/ transportation condition), and you should not allow the system in standby status, otherwise the batteries will be out of power and permanently damaged.
 2. If you will not use the system for a long period of time, **DO NOT** leave the system in the standby status, you should shut down the system, disconnect power adapter, mains power, and turn off powers of all connected peripherals.

3.4 Connecting /Disconnecting a Probe

- CAUTION:**
1. When connecting or disconnecting a probe, place it in a proper position, to prevent the probe from falling off or becoming damaged.
 2. Only use the probes provided by Mindray. Aftermarket probes may result in damage or cause a fire.

3.4.1 Connecting a Probe

WARNING: The probes, cables and connectors are in proper operating order and free from surface defects, cracks and peeling. Using a defective probe may cause electric shock.

1. Keep the cable end of the probe to the right side of the system, and insert the connector into the port of the system, and then press in fully. See the figure below.
2. Toggle the locking lever to the top position.
3. Place the cable properly to avoid being treaded or wrapping with other devices. **DO NOT** allow the probe head to hang free.

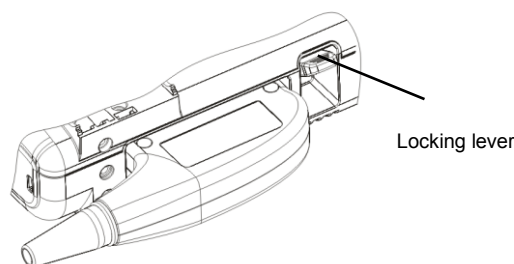

3.4.2 Disconnecting a Probe

1. Toggle the locking lever to the bottom position to unlock the connector of the probe.
2. Pull the probe connector straight out as shown in the figure below.

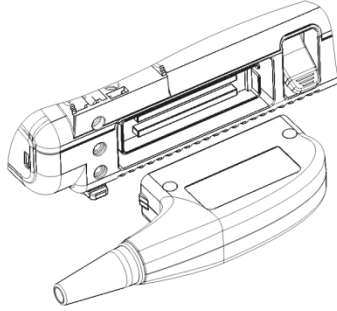

3.5 Connecting the Footswitch



Connect the footswitch to the main unit via a USB port. As shown in the following figure.



Set the functions of the footswitch in the [Key Config] page. Refer to "15.1.7 Key Config" for details.

3.6 Connecting/ Removing a USB Memory Device

WARNING: DO NOT directly remove a USB memory device; otherwise, the USB memory device and /or the system may be damaged.

- When connecting a USB memory device to the ultrasound system via a USB port:
 1. You can hear a sound if it is connected successfully.
 2. You can see the symbol  in the lower right corner of the imaging screen.
- To remove the USB memory device:
 1. Click  to open the "Remove USB Device" dialogue box.
 2. Select the memory device to be removed.
 3. Click [OK] and you can hear a sound.
 4. Remove the USB memory device. There will be sound feedback when remove the USB memory device.

3.7 Graph /Text printer

■ Connecting a local printer

As shown in the figure below, a graph /text printer has a power cord and data cable. The power cord shall be directly connected to a protective grounding wall receptacle as required.

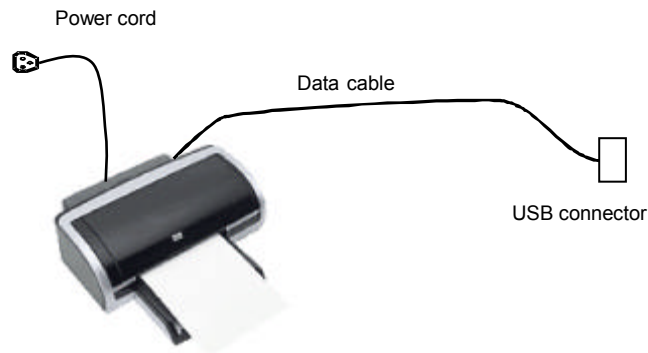

1. Connect the two USB ports of the printer and the system with the USB cable of the printer.
2. Power on the system and the printer.
3. Install the printer driver: "[Setup]→ [Peripheral Preset]→[Printer]→[Printer Driver]" and click [Add Printer], as shown in the figure:

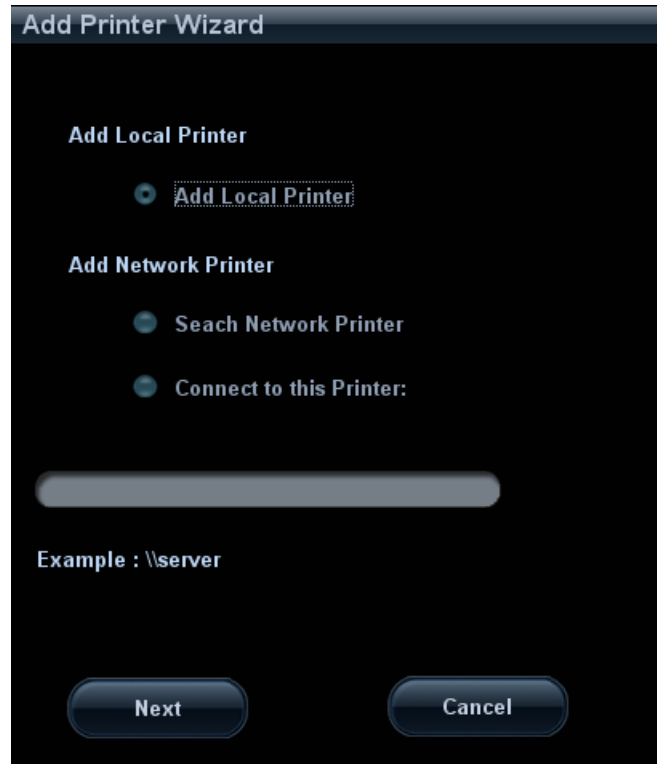

4. Select "Add Local Printer" and click [Next] to enter the screen of browsing driver; select the desired driver and click [OK] to install the driver.
 - Printers listed in "2.5 System Configuration" have drivers installed already.

- Click [Printer Attribute] to see the printer attribute.
5. Click [OK] to finish the installation.
- Add Network Printer
- After the system is connected into a LAN, enter the "[Setup] → [Peripheral Preset] → [Printer] → [Printer Driver]" screen.
1. Click [Add Printer] and select the types of adding network printer
 - Search Network Printer
Select "Search Network Printer" and click [Next] to search for the printer; select the domain and server in the screen to find the printer.
 - Connecting to the specified printer
Select "Connect to this Printer" and enter the printer address in the field box.
 2. When the network printer is successfully connected, you can see the printer in the list.
- Tips: the network printer functions depending on the configured network environment in the hospital, please consult the network configuration manager in case of failure.

NOTE: When you install the printer's driver, you must specify the specific path for installation; otherwise, vague path may result in longer time for searching.

- Report print
- You can use a graph/ text printer to print report or images.
- To set the default report printer and properties:
In "[Setup] → [Print Service]" screen, select the "Report Print" column in the service list, set the items in the "Property" box.
 - To print a report:
Click [Print] in the report dialog box to print a report; or, use the user-defined key to print, see "15.1.7 Key Config" for details.

Please refer to the accompanying manuals of the printers for more details.

3.8 Video Printer

The system support digital video printers, including B/W printers and color printers.

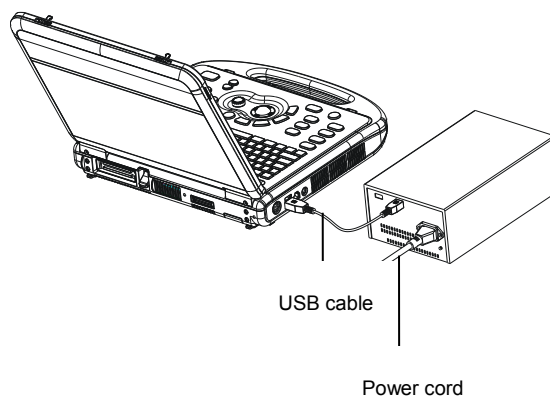

- Connecting a local printer (MITSUBISHI P93D as an example)
1. Place the printer in the proper position.
 2. Connect the power cord of the printer to a receptacle. Use a USB cable to connect the USB port of the system with the USB port of the printer.
 3. Load a paper roll, and turn on the system and printer.

4. Install the printer driver (steps are the same as of graph/text printers; please refer to relevant chapters for details). Printers listed in 2.5.2.3 Peripherals Supported have drivers installed already.
5. Add a print service:
 - (1) Open "[Setup] → [Peripheral Preset] → [Print Service]" screen.
 - (2) Click [Add Service] to enter the following page.

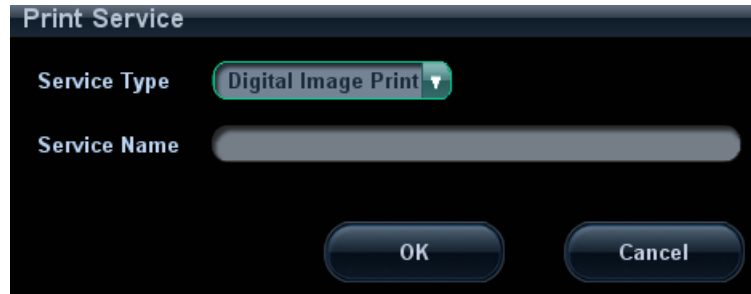

- (3) Select the service type as "Digital Image Print" and enter the service name manually.
- (4) Click [OK] to return to the Printer Service page.
- (5) Set the items in the Property box and click [Save] to save the settings.

■ Image print

Video printers are mainly used for image print; refer to DICOM chapter for DICOM image print.

- Modify print service:
 - a) Select a printer service in the list.
 - b) Select the printer type in the Property box.
 - c) Set print properties: Paper size, Paper orientation, Rows*Columns, Vertical Align, Page margin etc.
 - d) Click [Save] to confirm.
- Video output settings:

Enter "[Setup] → [Peripheral Preset] → [Input & Display]"; set the output size.
- Image print
 - Select the image to be printed on the iStation or Review screen, and click [Send To] to select the printer to print.
 - To print by the user-defined key (<Print> key as an example):
 - a) Enter "[Setup] → [System Preset] → [Key Config]".
 - b) Select "Print" in the "Key Function" list, and select the desired print service in the right "Print" list.

Please refer to the accompanying manuals of the printers for more details.

3.9 Basic Screen and Operation

3.9.1 Basic Screen

The following diagram maps out the different areas in the screen:

Logo	Hospital Name	Exam Time	Acoustic Power	MI/TI		Accession#	Freeze icon
	Patient Information		Probe	Exam Mode	Operator		
Image Parameter and Menu Area		Image area				Thumbnail Area of Images Stored	
Image-in-image Thumbnail	Cine Review						
	Body Mark Area						
	Help information area		Cursor area				
Soft Menu Area					System status icon		

■ Information Area



The information area displays manufacturer logo, hospital name, exam date & time, acoustic power & MI/TI, freeze icon, patient information, probe model, current exam mode, ECG icon (if ECG module is connected), and accession #, etc.

To preset whether gender, age or operator is displayed: Enter "[Setup]→[System Preset]→[General Preset]" and check "Gender", "Age" or "Operator" in the [Patient Info] box in the upper left corner of the screen.

- Logo
Manufacture logo, displayed in the upper left corner of the screen.
- Hospital name
Display the hospital name. Hospital name can be set via "[Setup] → [System Preset] → [Region]".
- Exam time
Displays the exam time, including date and time. Exam time can be set via "[Setup]→[System Preset]→[Region]". Exam time will be frozen with the frozen image.

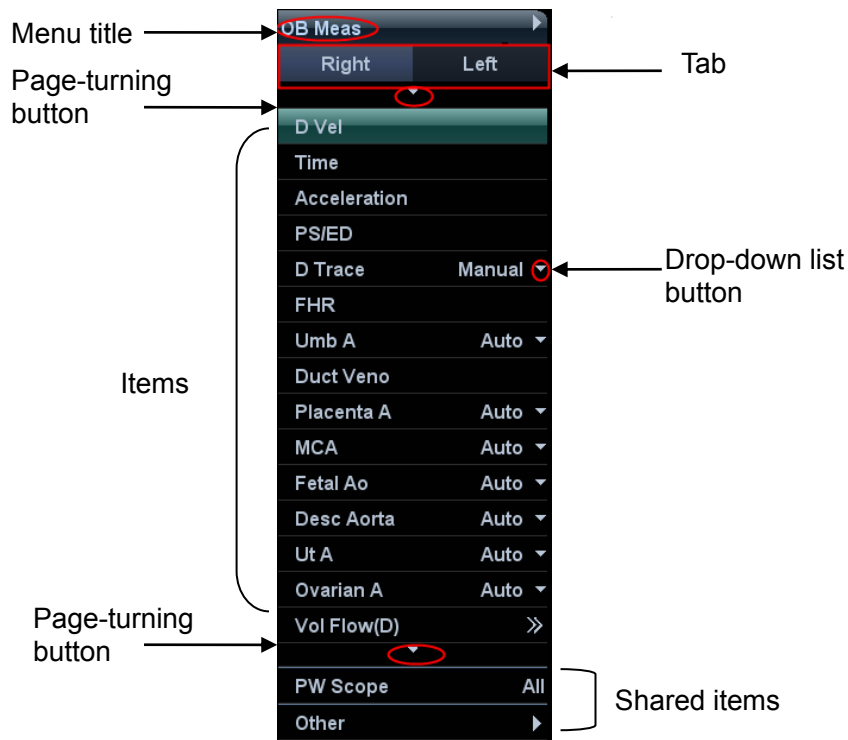
- Acoustic power & MI/TI
Display the acoustic power, including the acoustic power, MI (Mechanical Index) and TI (Thermal Index).
 - Freeze icon
The freeze icon  means the image is frozen.
 - Patient Information
Displays patient name, ID, gender and age etc. Enter the patient information through the "Patient Info" screen. Or, import the saved patient data from iStation or the DICOM Worklist server.
 - Probe Model
Display the currently-used probe model, or the default model.
 - Exam Mode
Displays the currently used exam type, e.g. A-Abdomen, is displayed.
 - Operator
Displays the operator's name on the screen. This information is entered through the "Patient Info" screen.
 - ECG icon
Displays ECG icon, which consists of a heart icon and heart rate, e.g. "♥75bpm"
 - Accession#
Serial number used in DICOM or the manually entered serial number in "Patient Info" screen.
- Image Parameter and Menu Area
- The image parameter and menu are both displayed in this area. When no menu is available; this area displays the image parameters of the current mode.
- Menu area
When an image menu is displayed, the imaging parameters will be covered by the menu.
Include image menu, measurement menu, comment menu, body mark menu and so on. Use the trackball or the multifunctional knob to operate on the menu.
Use the <Menu> to show or hide the menu, or press the multifunctional knob.
The menu area consists of menu title, menu items and page-turning button. As shown in figure below.



- **Menu title**
Displays the menu name.
- **Tab**
Divide the menu items according to measurement conditions.
- **Page-turning button**
When there are too many items in a menu, the items will be divided into more than one page.
You can turn pages by page-turning buttons,  and .
- **Items**
Refers to the items on a menu. For item that is applicable for more than one mode, the item appears as shared item in the certain mode. Items of image modes and measurement can be preset.
- **Down-drop list button**
If there are several options available for one item, you can choose the options through the  button.
- **Return to previous menu**
Click [Return] to return to the previous menu.
The multifunctional knob can be used to operate the menu. Press the knob to open the menu; rotate the knob to navigate through the items one by one, and press it to select the item.
Depending on the item types, the multifunctional knob can:
 - For a commanding item or command optional item: press the knob to directly activate the item.
 - For a parameter item or ON/OFF item: press the knob to lock and select the item, then rotate the knob to switch among the available values; press the knob again to release and deselect the item.

- For an item with sub-menu: press the knob to extend the sub-menu, and the cursor navigates to the first sub-item. Operate the sub-menu through the multifunctional knob. At the same time, you can exit from the sub-menu to the previous item by clicking “Exit” in the sub-menu.
 - For tab items in the menu: e.g. the “Right” and “Left” items in the measurement menu. Rotate the multifunctional knob to navigate the tab, and press the knob to select the tab.
- Parameter Area

Display the image parameters for the activated image window. If there are more than one imaging modes, the system displays the parameters of each image mode respectively. For details, please refer to the corresponding imaging mode(s).
- Image area

The image area displays the ultrasound images, ECG waveforms, probe mark (or activating window mark), time line (in M or PW mode), coordinate axis (including depth, time, velocity/frequency), focal position (located at depth axis in the form of ) , besides, the annotation, body mark, measurement calipers, color bar/grayscale bar are also displayed here.

Tips: Amplitude and position of ECG waveform can be preset, for more details, please refer to “8.2 ECG Setting”.
- Image-in-Image Area





In the zoom status, this area displays the thumbnail of a complete image, and a rectangular frame is used to highlight the currently magnified area. This feature is called image-in-image.
- Cursor area

The status icon area indicates the current cursor status, such as  in cineloop status.
- Help information area

The help information area displays various help information or progress bar in the current status.

Besides, the system can provide help for each key. Press <Fn>+<Help> to enter key-help status, you can see the cursor changes into an arrow with a question mark on it. Press any key on the control panel, the screen displays the key-relevant information, meanwhile, the system exits the key-help status.



Tips: in terms of help information, “TB” refers to “Trackball”; “Knob” refers to “Multifunctional knob”.
- Thumbnail area of images stored

Displays the thumbnail images stored under the current patient.
- Image manage area
 - Page up/down: when there are more than one page images have been stored, you can turn to the next or preview page by  or  respectively.
 - Delete: select a thumbnail image, and click  to delete it.
 - Send to: select a thumbnail image, and click  to send it to external devices.
- Soft Menu Area

The soft menu items displayed are corresponding to functions of soft menu controls in the control panel. The soft menu items are related to image mode and settings of each mode in preset.

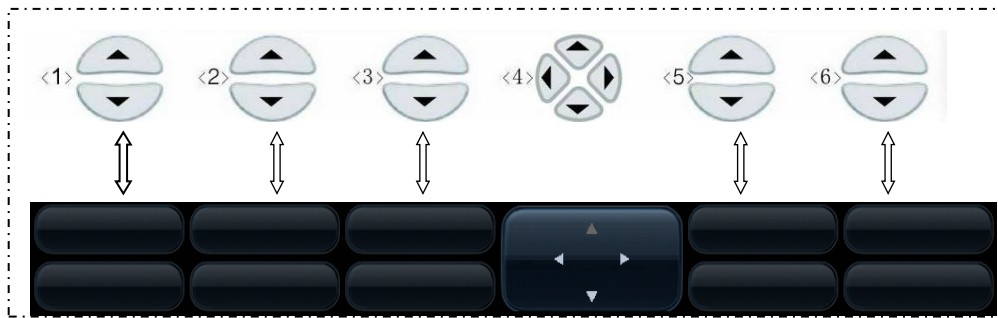
The soft menu controls are located at the top of the control panel, shown in the following figure.



- **Page-turning:**
Use the up/down keys in soft menu controls <4> to turn pages up or down; you can operate the items only when they are highlighted.
- **Mode switching:**
Left / right keys in <4> are used to switch among the modes. The soft menu items vary depending on the mode. The menu navigation will cause the change of the menu, while the change of the menu will cause the menu navigation.
- **Soft menu control:**
The soft menu items are operated respectively through the five groups of soft menu controls <1>, <2>, <3>, <5> and <6>.
The soft menu items can also be adjusted by <Set> on the control panel. Move the cursor onto a soft menu item and press <Set> to change the parameter of the item.
- **System status area**
This area displays the relevant system icons, such as USB memory device, printer, network connection, and current system time, etc.
Click  to see the hidden status icons.
- **None-fixing Area**
Areas illustrated here are position-changeable; you can move them by the trackball within a certain area on the monitor.
 - **Result window**
The measurement result window displays the results of recently performed measurements.
To move the result window:
 - a) Place the cursor on the title of result window (you can see the cursor changes into .
 - b) Press <Set> and move the trackball, the window moves together with the cursor.
 - c) Move the cursor to the target position, press <Set> again to anchor the result window in the target position.
 - **Comment area**
For details, please refer to “10 Comments and Body Marks”.
 - **Body mark area**
For details, please refer to “10 Comments and Body Marks”.

3.9.2 Basic Operations of Screens

A screen consists of title, page tabs, contents and buttons, as shown in the following figure:



Composition	Description
Title Bar	The title bar is used to give a description for the content and function of the screen.
Page Tab	For some screens, contents are distributed across several pages. Click the tab by pressing <Set> key to open/close the available pages.
Contents	<ul style="list-style-type: none"> ■ Radio button: click to select the item. ■ Check box: click to check or uncheck the item. ■ Entry box: enter characters manually via the keyboard. Position the cursor into the box, and then enter the letters or characters. ■ Drop-down list box: click “▼” to show the list and select an item.
[OK] and [Cancel]	When the operation of a screen is complete, press the [OK] or [Cancel] button to save or cancel the operation, and close the screen.

- To reposition a dialogue box:
 1. Roll the trackball to move the cursor onto the title bar of the dialogue box. At this time the cursor becomes a \updownarrow ; press <Set>.
 2. Roll the trackball and reposition the rectangular graphic to the new desired location.
 3. Press the <Set> key, and the dialogue box is moved to the desired position.

4 Exam Preparation

 **CAUTION:** Before examining a new patient, press <End Exam> to end the exam of the previous patient, update the patient ID and information, to avoid mixing data of the next new patient.

4.1 To Start an Exam

You can start a patient exam in the following situations:

- New patient information: Enter the patient information, if it is a new patient, refer to "4.2.1 New Patient Information" for details; however, the system also supports anonymous patient exam, refer to "4.8 Anonymous Patient Exam" for details.
- New exam: to start a new exam for an already registered patient, the recorded information can be obtained either through iStation or Worklist, refer to "4.2.2.1 iStation" and "4.2.2.2 DICOM Worklist" for details.
- Activate an exam: select an exam that is ended within 24 hours, and continue the exam. For details, please refer to "4.5 Activate & Continue an Exam".
- Continue an exam: select an exam that is paused within 24 hours, and continue the exam. For details, please refer to "4.5 Activate & Continue an Exam".

General procedure for an exam: Enter the patient information → Select an exam mode and probe → Choose an imaging mode → Start the exam.

To start a new patient exam, it is better to enter the detailed patient information. The system will set up a unique information database for each patient based on the patient information entered, so that the information of one patient will not be confused with that of another patient.

4.2 Patient Information

- To enter the "Patient Info" screen
 - Press <Patient>, or,
 - Move the cursor onto the patient information area on the monitor and press <Set> to open the screen.
- To exit the "Patient Info" screen
 - Click [OK] on the "Patient Info" screen; or, press <Patient> on the control panel again, to save the settings and exit the screen.
 - Click [Cancel] or press <Esc> to exit the screen without saving any of the entered patient data.
 - Press or <Freeze> to return to the current exam mode with the entered information being saved.

- Click [Basic] or [Detail] on the screen to show or hide the detailed patient information.

4.2.1 New Patient Information

The "Patient Info" screen is shown as follows (Take abdomen exam for example):

Place the cursor onto the targeted box. The field box is highlighted and a flashing cursor appears. Information can be entered or selected from the options.

You can also change the cursor position by <Tab>, <Enter> or direction keys.

The screenshot shows the 'Patient Info' screen with the following elements:

- 1**: General Information section containing fields for Patient ID (HDBE), Last Name, First Name, M.I., DOB (DD/MM/YYYY), Age (Years), and Gender (Unknown). A 'Patient data in' panel on the right has buttons for 'iStation', 'WorkList', and 'Basic'.
- 2**: Exam Selection section with tabs for ABD, OB, GYN, CARD, VAS, URO, SMP, and PED. Below are fields for Study Description, Primary Indications, Secondary Indications, CPT4 Code, CPT4 Description, Height (cm), Weight (kg), and BSA (m²).
- 3**: Accession #, Ref. Physician, Diagnostician, Operator (Admin), and a large Comment text area.
- 4**: Bottom navigation bar with buttons for 'New Patient', 'New Exam', 'Pause Exam', 'Cancel Exam', 'OK', and 'Cancel'. A system tray at the bottom right shows the time 16:53.

Detailed information is described as follows:

1. General information

- Patient ID

Once you enter the ID and confirm it, you are not allowed to change it. There are 2 ways to generate the patient ID. “\” is not permitted.

Tips: Patient ID of an activated exam (within 24 hours) can be modified. (This feature is only applied to 04.00.00 version software or higher versions.)

- Auto generate ID

Select "Auto generated ID" through the path: [Setup] → [System Preset] → [General]. System will automatically populate the (patient) ID field with a unique time-stamp identification code. The auto generated ID can be edited manually.

- Enter the ID

If you deselect "Auto Generated ID", you need to enter an ID.

If an ID that is already existed in the system is entered, the system prompts "The ID existed, load data", you can choose to import the data.

- Name

Enter the patient name directly through the keyboard. Characters of A through Z and 0 through 9 and "." are allowed.

“\”, “^”, “=”, and “,” are not permitted.

- Gender

Select Male, Female or Unknown for patient gender in the drop down list.

- DOB (Date of birth):

You can either enter the birth date of a patient manually according to the format displayed in the field, or click  to select the date. In the table, you can select the desired year (or enter it manually); month and day, then click [OK] to finish it.

- Age:

- Auto generated age: once the DOB is entered, the system can display an auto-generated age in the field box; the unit can be “Years”, “Months” or “Days”. If the age is less than one year, the system will automatically calculate the age in months or days.
- Also, you can manually enter the age.

NOTE: When you enter the date manually, please enter it in the format as that of the system.

2. Exam Type

- Exam application type

You can select among 8 types: ABD (Abdomen), OB (Obstetrics), GYN (Gynecology), CARD (Cardiac), VAS (Vascular), URO (Urology), SMP (Small Part), and PED (Pediatrics).

Select the exam type tab to enter the exam-specific information.

- General information:

Study description: To enter description for each exam.

Primary indications: To enter the primary indications (reason to perform the exam.)

Secondary indications: To enter the secondary indications.

CPT4 code: To enter the CPT4 code.

CPT4 description: To enter the CPT4 description.

- Exam specified information:

Exam Type	Information	Description
ABD (Abdomen)	Height	/
	Weight	/
	BSA (body surface area)	After the height and weight are entered, the system will automatically calculate the BSA based on the formula which is set via "[Setup] → [System Preset] → [General]".

Exam Type	Information	Description
OB (Obstetric)	Calculation index	<p>According to the entered index (can be selected in the drop-down list); including LMP (last menstrual period), IVF (in vitro fertilization), PRV (previous exam date), BBT (basic body temperature)), the system can automatically calculate GA and EDD (estimated delivery date); or, calculates GA and LMP according to the EDD and entered date.</p> <ul style="list-style-type: none"> ● LMP: After you enter LMP, the system will calculate and display GA and EDD. ● IVF: After you enter IVF, the system will calculate GA and EDD. ● PRV: input the date and GA of the last exam, the system will calculate a new GA and EDD. ● BBT: input BBT, the system will calculate the GA and EDD. ● EDD: after you enter EDD, the system will calculate and display GA and LMP.
	Gravida	Times of pregnancy.
	Ectopic	Times of abnormal pregnancy. e.g. extrauterine pregnancy
	Gestations	Number of embryos (1, 2, 3; 1 is default)
	Para	Times of delivery
	Aborta	Times of abortion
GYN (Gynecology)	LMP	Last menstrual period
	Gravida	Times of pregnancy.
	Para	Times of delivery
	Ectopic	Times of abnormal pregnancy. e.g. extrauterine pregnancy
	Aborta	Times of abortion
Cardiology	Height	/
	Weight	/
	BSA (body surface area)	After the height and weight are inputted, the system will automatically calculate the BSA based on the formula which is set via "[Setup] → [System Preset] → [General]".
	BP	Blood pressure.
	HR	/
	RA Press	Right Atrium Pressure
VAS (Vascular)	BP(L)	Input left blood pressure.
	BP(R)	Input right blood pressure.
URO (Urology)	Serum PSA	/
	PPSA coefficient	/
SMP (Small Parts)	None	/

Exam Type	Information	Description
PED (Pediatrics)	None	/

3. Operating Information

- Accession #: exam number used in DICOM. It should be entered within 16 letters or characters; "\" is not permitted.
- Diagnostician: people who is responsible for the exam. "\", "^", "=", " and ", " are not permitted.
The system remembered automatically the diagnostician information that is inputted. Click the Diagnostician drop-down list, select "Del Single" or "Del All" to delete the information of the diagnostician.
- Operator: people who is responsible for images acquisition and scanning. "\", "^", "=", " and ", " are not permitted.
The system remembered automatically the operator information that is inputted. Click the operator drop-down list, select "Del single" or "Del All" to delete the information of the operator.
- Ref. Physician: the people who requires the ultrasound exam. "\", "^", "=", " and ", " are not permitted.
The system remembered the Ref.Physician information that is inputted. Click the Ref. Physician drop-down list, select "Del single" or "Del All" to delete the Ref.Physician information.
- Comment: exam-specific explanation or remarks.

4. Functional key

- [Pause Exam]: to pause the current exam.
- [Cancel Exam]: to cancel the current exam.
- [New Patient]: click to clear the current patient information in the patient information screen in order to input information of a new patient.
- [New Exam]: click to clear the entered exam information to start a new exam for the current patient.
- [OK]: click to save the patient data entered and exit the screen.
- [Cancel]: click to cancel the patient data entered and exit the screen.

4.2.2 Retrieve Patient Information

4.2.2.1 iStation

The patient data can be obtained in iStation from the system hardware or USB memory device. You can enter the searching conditions for the patient.

1. To enter iStation screen:
 - Press <iStation> on the control panel; or,
 - Click [iStation] in the "Patient Info" screen; or
 - Press the <Review> key on the control panel and click [iStation] in the screen.
2. Select the data source:

Select the data source in the drop-down list of "Data Source". The occupying space percentage of the selected data source will be displayed.
3. Set the searching condition

Define the searching item: Name, ID, BOD or Exam Date; and then enter the related keyword.

- Select “Find in results”, the system will search the keyword based on the existed searched results.
 - Click [Reset], the system will clear the information you entered, and all the recorded patient information of the system will be listed out.
4. Select the desired patient information from the list.
- [New Exam]: click to enter “Patient Info” screen, meanwhile, the corresponding patient information is also imported to the new exam. After you edit the patient information in the [Patient Info] screen, select [OK] to start a new exam.
 - [Activate Exam]: click to continue an exam that is finished within 24 hours.
 - [Continue Exam]: click to continue an unfinished exam that is carried out within 24 hours.
 - [Review]: click to switch to the Review screen.
 - [Exit]: click to exit to iStation dialogue box.

4.2.2.2 DICOM Worklist

When the DICOM basic package is configured and the Worklist server has been set, click [Worklist] in the "Patient Info" screen to query or import the patient data. (For the setting of Worklist server, please refer to “12.1.4.3 DICOM Worklist Setting”).

Procedure:

1. Select data source: choose a worklist server in the drop-down list of “Worklist Server”, and then all the patient exam records in the server are listed out.
2. Set the searching condition:
 - Enter the period which includes the exam date, and click [Query] to search.
 - Enter patient ID, patient name, accession #, the system provides the result in real-time.
 - Or select the keyword type, enter the keywords and then click [Query] to search.
 - To reset the criteria, click [Clear] button.
3. Select the desired patient from the list, and:
 - Click [Start Exam], the patient information is imported into the system and then an exam is started.
 - Click [Transfer], the patient information is imported into the "Patient Info" screen. After you edit the patient information in the "Patient Info" screen, click [OK] to start a new exam.
 - Click [Show Detail] to see details of patient data.
4. Click [Exit] to exit the Worklist.

4.3 Select an Exam Mode and Probe.

	<p>CAUTION: If the exam mode is changed during a measurement, all measurement calipers on the image will be cleared. The data of general measurements will be lost, but the data of application measurements will be stored in the reports.</p>
---	--

4.3.1 Supported Exam Modes

The system can be configured with applications including abdominal, gynecology, obstetrics, cardiac, vascular, small parts, urological, pediatrics, EM and nerve use, and the

system will support corresponding exam modes related to the application software (refer to “2.5.2 Options” for details); the system also supports user-defined exam modes.

The system supports to preset application type, measurements, comments, body marks, image parameters for each exam mode (including user-defined exam modes). For details, please refer to “15.2 Exam Preset”.

You can select exam modes for the probes. For details, please refer to “15.2.1 Exam Selection”.

4.3.2 Selecting Exam Modes and Probes

- Select the exam mode(when connecting with one probe):
 - (1) Press <Exam> to open the following dialog box.

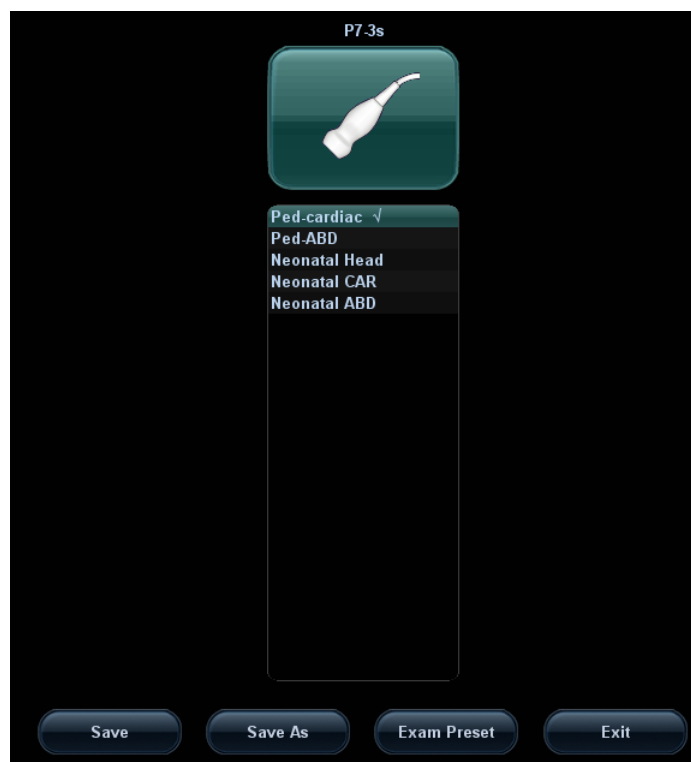

- (2) Roll the trackball and press <Set> to select the exam mode.
- Select the exam mode (when more than one probe are connected):
 - (1) Press <Exam> to open the following dialog box.



(2) Roll the trackball and press <Set> to select the exam mode, and use the left/right keys of the soft menu controls to switch the probe.

- To save the current settings for the current exam mode quickly:

(1) Press <Exam> to open the dialog box.

(2) Click [Save], to save the image parameters of the current image mode as setup data. A dialogue box pops up to prompt you that the operation will cover the current image preset data.

(3) Click [Save as] to save the current image parameter, measurement, comments and body mark settings to the designated exam mode.

- Click [Exam Preset] to enter the exam preset screen. For exam preset, please refer to “15.2 Exam Preset”.

- Exit:

Click [Exit] or press <Exam> to exit, press , <Freeze> or <ESC> can also exit the screen.

4.4 Select the Imaging Mode

Use the corresponding keys in the control panel to enter the imaging modes.

For the detailed operations in each imaging mode, please refer to “5 Image Optimization”.

4.5 Activate & Continue an Exam

4.5.1 Activate an Exam

Select an exam that is finished within 24 hours, click [Activate Exam] in “iStation” or “Review” screen to activate the exam.

Tips:

- The system can automatically load the patient information and exam data to continue the exam.
- If you want to activate an exam with data in an external memory database, you have to first import the patient data to the system’s patient database.

4.5.2 Continue an Exam

Select an exam that is paused within 24 hours, click [Continue Exam] in “iStation” or “Review” screen to continue the exam.

If you want to continue an exam with data in an external memory database, you have to first allow the system to load the patient data to the system’s patient database.

4.6 Pause Exam and End Exam

4.6.1 Pause an Exam

- Sometimes, you have to stop an uncompleted exam due to some special causes or system power off/ when the exam is paused, the system can begin other exams.
 1. Press <Patient> to enter "Patient Info" screen.
 2. Click [Pause Exam].
- If the system is powered off during scanning, the exam status turns "paused" after the system restart.

Only one exam can be paused every time.

When an exam is paused, the system will do the following:

1. Save the exam-related images, reports and measurement data, and modify the status as “Paused”.
2. Save the exam information, including report, imaging mode, exam mode, image parameters, operation mode, imaging /measurement data and so on.
3. If the system has been configured with a MPPS server, it will send the status information to the server. For details, please refer to the DICOM chapter.

4.6.2 End an Exam

Before examining a new patient, press <End Exam> to end the exam of the previous patient, update the patient ID and information, to avoid mixing data of the next new patient.

To end an exam, you can do one of the following:

- Press <End Exam> on the control panel.

- Click [New Patient] on the Patient Info screen to end the last patient exam and clear the patient information.
- Click [New Exam] on the Patient Info screen (or iStation screen, or Review screen) to end the last exam and clear the exam data.

4.7 Cancel an Exam

An undergoing exam can be stopped by clicking [Cancel Exam] in the Patient Info screen.

1. Press <Patient> to enter "Patient Info" screen.
2. Click [Cancel Exam].
3. The system prompts the confirmation message, and requires to select the reason for canceling the exam as the following figure:

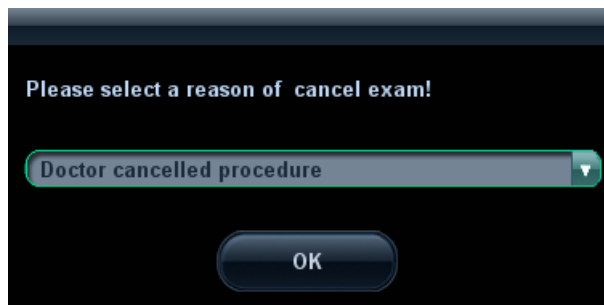

4. Select the reason and click [OK].
 5. After the above operations being taken, the exam is cancelled, and images, measurements and report are saved with the status of the exam to be "Canceled".
- If the system has been configured with a MPPS server, it will send the status information "Cancelled" to the server. For details, please refer to relevant description in the DICOM chapter.

4.8 Anonymous Patient Exam

The system can also carry out image scanning and measurement even though no patient information is available:

- Deselect "Save image without patient info" in "[Setup] → [System Preset] → [General]".

When saving an image, the system pops up the Patient Info screen to ask for the patient information.









- Enter the information and click [OK] to save the image and data.
- Select [Cancel] and the system will not save the images.
- If "Save image without patient info" is selected
The system will automatically generate an ID, and save the images in the ID.

5 Image Optimization

 **WARNING:**

1. The images displayed in this system are only reference for diagnosis. Mindray is not responsible for the correctness of diagnostic results. It is the responsibility of the clinician, who performs the exam, to capture the correct diagnostic results.
2. In Dual-B imaging mode, the measurement results of the merged image may be inaccurate. Therefore, the results are provided for reference only, not for confirming a diagnosis. Tissue Harmonic Imaging does not use contrast agents.

5.1 Switching Between Imaging Modes

Key	Description
	B Mode key: press to enter B Mode.
	M Mode key: press to enter M Mode.
	PW Mode key: press to enter PW Mode. In 3D/4D mode, press to enter 3D image in single window.
	CW Mode key: press to enter CW Mode.
	Color Mode key: press to enter Color Mode.
	Power mode key: press to enter Power Mode.
	Dual-split display key: press to enter the Dual-split display mode, and to switch between the windows.
	Press to change the currently active window. Press to start or end image capture in 3D/4D or iScape.
	Press to enter the quad-split screen display, or switches image window in the Quad mode.

5.2 Image Adjustment

Before optimizing the image by adjusting image parameters, adjust the brightness and contrast of the monitor to the best.

Requirement	Available Operations
To modify the brightness	Adjust gain Adjust TGC Adjust [A. power] (do try to adjust gain first before increasing the acoustic power)
To modify gray scale image effect	Adjust [Dyn Ra.] Adjust [Gray Map] Adjust [Persistence] Adjust [iClear] (optional)
To increase frame rate of gray scale imaging	Decrease depth Decrease the [Focus Number] in B mode Decrease the [FOV] in B mode Decrease [Line Density] Turn on [High FR] in harmonic mode
To increase frame rate of color imaging	Decrease ROI in Color/Power mode Turn on [B/C Wide] in Color/Power mode Decrease [Packet Size] in Color mode Decrease [Line Density]
To modify flow images effect (Resolution and sensitivity)	Adjust [Freq] Adjust [Scale] Adjust [Packet Size] Adjust [Line Density] Adjust [Smooth]

- Adjustment through image menu
Press <Menu> or multifunctional knob to open the menu; use the trackball and <Set> or the multifunctional knob to adjust.
- Adjustment through soft menu controls
The soft menu locates at the bottom of the screen, items of which are dependent upon image modes and preset. Take B mode adjustment as an example.

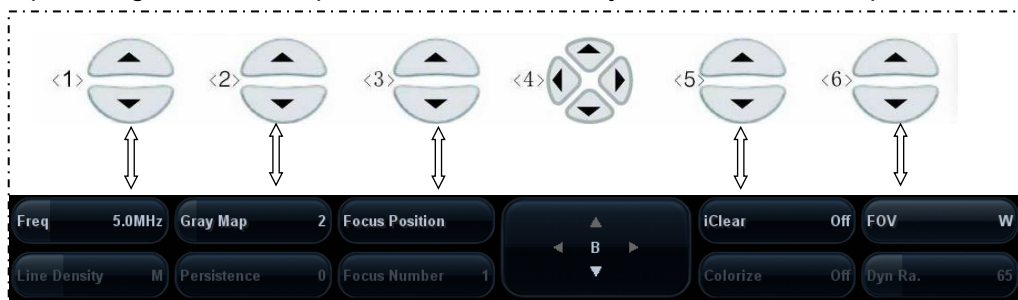

- Image mode switching
Use left/ right controls in soft menu controls <4> to switch among the modes. The soft menu items vary depending on the mode. The menu navigation will cause the change of the menu, while the change of the menu will cause the menu navigation.
- Page up/down

Use the up/down keys in soft menu controls <4> to turn pages up or down; you can operate the items only when they are highlighted.

- Soft menu controls operation
 - a) The soft menu items are operated respectively through the five groups of soft menu controls <1>, <2>, <3>, <5> and <6>.
 - b) You can also move the cursor to the certain soft menu item, and then press <Set> or rotate the multifunctional knob to adjust.
- Adjustment through image parameter area

The image parameter area is located in the upper left corner of the screen. The image parameters are displayed while the image menu is not available.

 - (1) Move the cursor to the item on the parameter area, and a frame will be around the certain item, as .
 - (2) Press <Set> to adjust, and rotate the multifunctional knob to select the values.
- Adjustment through control panel
 - Trackball, control panel key, knob or sliders.
- Adjustment through grayscale/ color bar
 - Move the cursor onto the grayscale bar, and press <Set> to switch among the gray maps.
 - Move the cursor onto the color bar, and press <Set> to switch among the color maps.

5.3 B Mode Image Optimization

B mode is the basic imaging mode that displays real-time images of anatomical tissues and organs.

5.3.1 B Mode Exam Protocol

1. Enter the patient information, and select the appropriate probe and exam mode.
 2. Press on the control panel to enter B mode.
 3. Adjust parameters to optimize the image.
 4. Perform other operations (e.g. measurement and calculation) if necessary.
- In real-time scanning of all imaging modes, press on the control panel to return to B mode.

5.3.2 B Mode Parameters

- In B Mode scanning, the image parameter area in the upper left corner of the screen will display the real-time parameter values as follows:

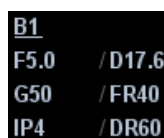

```

B1
F5.0 / D17.6
G50 / FR40
IP4 / DR60
  
```

Display	F 5.0	D 17.6	G 50	FR 40	IP 4	DR 60
Parameter	Frequency	Depth	Gain	Frame Rate	B IP	B Dynamic Range

- Parameters that can be adjusted to optimize the B Mode image are indicated in the following.

Adjustment	Items
Control Panel	Gain, Depth, TGC, iTouch
Menu and Soft Menu	Dynamic Range, Focus Number, FOV Position, Line Density, IP, Colorize, L/R Flip, Rotation, Persistence, Colorize Map, U/D Flip, iTouch, Frequency, Gray Map, Focus Position, iClear, FOV, Smooth, TSI, Curve, Gray Rejection, γ , High FR, iTouch Bright, A. power, B Steer, iBeam, Trapezoid, Image Merge

- Items that appear in the menu or the soft menus are dependent upon preset, which can be changed or set through "[Setup] → [Image Preset]"; please refer to "5.15 Image Preset" for details.

5.3.3 B Mode Image Optimization

Gain

Description To adjust the gain of the whole receiving information in B mode. The real-time gain value is displayed in the image parameter area in the upper left corner of the screen.

Operation Rotate the <iTouch> knob clockwise to increase the gain, and anticlockwise to decrease.

Or adjust it in the image parameter area.



The adjusting range is 0-100.

Effects Increasing the gain will brighten the image and you can see more received signals. However, noise may also be increased.

Depth

Description This function is used to adjust the display depth of sampling, the real-time value of which is displayed on the image parameter area in the upper left corner of the screen.

Operation To change depth, press keys in the lower right corner of the control panel.

Press  key to decrease the depth; Press  key to increase the depth.

Or adjust it in the image parameter area.

The adjustable depth values vary depending upon the probe types.

Effects Increase the depth to see tissue in deeper locations, while decrease the depth to see tissue in shallower locations.

Impacts Depth increase will cause a decrease in the frame rate.

TGC

Description The system compensates the signals from deeper tissue by segments to optimize the image.

There are 8-segment TGC sliders on the control panel corresponding to the areas in the image.

Operation To increase the gain compensation at an area of interest, move the TGC slider to the right.
To decrease the gain compensation at the corresponding area of interest, move the TGC slider to the left.
About 1.5s after the adjustment is finished, the TGC curve disappears.

Effects Adjust the signal gain for the certain image area to get a balanced image.

Frequency

Description This function is used to select the operating frequency of the current probe, the real-time value of which is displayed in the image parameter area in the upper left corner of the screen, where "F" represents B mode frequency, and "FH" represents harmonic frequency.

Operation You can select a harmonic frequency or a B mode frequency.
Adjust the frequency value through the [Frequency] item in the soft menu or menu, "H" indicates harmonic frequency.
Or adjust it in the image parameter area.
Values of frequency vary depending upon the probe types.
Select the frequency according to the detection depth and current tissue characteristics.

Effects The higher the frequency the better the near field resolution but the worse the force of penetration.
Harmonic imaging enhances near field resolution and reduces low-frequency and large amplitude noise, so as to improve small parts imaging.

Acoustic Power

Description Refers to the power of ultrasonic wave transmitted by the probe, the real-time value of which is displayed in the image parameter area in the upper left corner of the screen.

Operation Adjust through the [A. power] item in the soft menu or menu.
The adjusting range is 7%-100% in increments of 3%.

Effects Generally, increasing the acoustic power will increase the brightness and contrast of the image as well as the force of penetration.

Impacts You should perform exams according to actual situation and follow the ALARA Principle.

Focus

Description Refers to adjustment of focus of the ultrasonic beams, symbols as "◀" of which are displayed on the right of the image.

Operation Adjust the focus number through the [Focus Number] in the soft menu or menu.
Adjust the focus position through the [Focus Position] in the soft menu or menu.
In B mode, focus number can be switched among 1-4.

Effects The area that is focused will be of a higher contrast and resolution to provide a much clearer image.

Impacts The greater the number of focus, the slower the frame rate to image.

Imaging Display Adjustment

Description More information can be obtained without moving the probe or changing the sampling position.

FOV (Field of View) Change the scan range through the [FOV] item in the soft menu or menu. The system provides four levels of scan range: W, N, M1, and M2.

You can get a much larger field of view when selecting a larger FOV, but the frame rate will decrease.

FOV Position Change the scan position through the [FOV Position] item in the soft menu or menu.

When the scan range is "W", the FOV position cannot be changed.

B Steer This function is to steer the beam transmitted by the probe.

Steer the transmitting beam through the [B Steer] item in the soft menu or menu.

Trapezoid Turn on or off the function through [Trapezoid] item in the soft menu or menu.

You can define user-defined key for trapezoid function in "[Setup] → [System Preset] → [Key Config]".

ExFOV Turn on or off the function through [ExFOV] item in the soft menu or menu.

Impacts The FOV position is available only for the convex and phased probes. The B Steer and Trapezoid function are available only for linear probes. The ExFOV function is available only for convex probes.

Line Density

Description The function determines the quality and information of the image.

Operation Adjust through the [Line Density] item in the soft menu or menu.

There are three levels of line density available: M, H, L, UH.

Effects The higher the line density, the higher the resolution, and the lower the frame rate.

Dynamic Range

Description This function is used to adjust the B image resolution to compress or expand the gray display range.

The real-time dynamic range value is displayed on the image parameter area in the upper left corner of the screen.

Operation Adjust through the [Dyn Ra.] item in the soft menu or menu.

Or adjust it in the image parameter area.

The adjusting range is 30-160dB in increments of 5dB.

Effects The more the dynamic range, the more specific the information, and the lower the contrast with more noise.

iClear

Description This function is used to increase image profile, so as to distinguish the image boundary.

Operation Adjust through the [iClear] item in the soft menu or menu.
The system provides 5 levels of iClear effects adjustment, off represents no iClear is turned on, and the bigger the value the stronger the effect.

Effects The bigger the value the more clearly the profile of the image.

Impacts This function is optional.

Smooth

Description This function is to reject image noise and to make images smooth.

Operation Adjust through the [Smooth] item in the soft menu or menu.
The system provides 4 levels of smooth function, the bigger the value the higher the smooth adjustment.

Persistence

Description This function is used to superimpose and average adjacent B images, so as to optimize the image and remove noises.

Operation Adjust through the [Persistence] item in the soft menu or menu.
The system provides 8 level of frame average adjustment, the bigger the value the stronger the effect.

Effects Persistence can remove image noise to make details to be clearer.

Impacts Persistence increase may lead to signal missing.

Invert /Rotation

Description This function provides a better observation for image display.

Invert(U/D Flip and L/R Flip) To invert the image horizontally or vertically.
Click [L/R Flip] or [U/D Flip] in the menu or the soft menu to invert the image.

Rotation Rotate the image through the [Rotation] item in the menu or the soft menu.
Image can be rotated by the manners in angle of 0°, 90°, 180°, and 270°. When the image is rotated at the angle of 90° or 270°, the depth scale is displayed on the upper part of the screen.

When you invert or rotate an image, the “M” mark will change its position correspondingly on the screen; the M mark is located in the upper left corner of the imaging area by default.

Impacts The function is available in real-time imaging, freeze or cine review status.

iBeam

- Description** This function is used to superimpose and average images of different steer angles to obtain image optimization.
- Operation** Adjust through the [iBeam] item in the soft menu or menu.
The system provides 3 levels of iBeam adjustment, off represents no iBeam, and while 2 represents maximum iBeam optimization.
- Effects** Images after iBeam processing can be optimized with less spot noise and higher resolution, so that more details for the structure are revealed.
- Impacts** When linear probe is being used, iBeam function is not available when trapezoid function is turned on or B steer is adopted.

Image Merge

- Description** In the Dual-split mode, when the images of the two windows use the same probe type, depth, invert status, rotation status and magnification factor, the system will merge the two images so as to extend the field of vision.
- Operation** Turn on or off the function through the [Img Merge] item in the soft menu or menu.
- Impacts** iBeam is available only for linear probes.
The function is available in real-time imaging, freeze or cine review status.

Gray Map

- Description** This function applies the gray correction to obtain the optimum images.
- Operation** Select among the maps through the [Gray Map] item in the soft menu or menu.
You can also adjust through the grayscale bar: move the cursor to the grayscale bar and press <Set> on the control panel to adjust.
The system provides 8 groups of gray map.
- Impacts** The function is available in real-time imaging, freeze or cine review status.

IP (Image Processing)

- Description** IP is a combination of several image processing parameters, which is used for a fast image optimization, the real-time group of which is displayed in the image parameter area in the upper left corner of the screen.
The IP combination parameters include dynamic range, iClear, persistence and smooth.
- Operation** Select among the IP groups through the [IP] item in the soft menu or menu.
Or adjust it in the image parameter area.
The system provides 8 groups of IP combinations, and the specific value of each parameter can be preset.

Colorize and Colorize Map

- Description** Colorize function provides an imaging process based on color difference rather than gray distinction.

- Operation** Turn on or off the function through the [Colorize] item in the soft menu or menu.
 Select the colorize map through the [Colorize Map] item in the soft menu or menu.
 The system provides 10 colorize maps to be selected among.
- Impacts** The function is available in real-time imaging, freeze or cine review status.

TSI (Tissue Specific Imaging)

- Description** The TSI function is used to optimize the image by selecting acoustic speed according to tissue characteristics.
- Operation** Select among the TSI modes through the [TSI] item in the soft menu or menu.
 The system provided 4 ways of optimization for specific tissues: general, muscle, fluid and fat.

iTouch

- Description** To optimize image parameters as per the current tissue characteristics for a better image effect.
- Operation** Press <iTouch> on the control panel to turn on the function, the symbol of which will be displayed in the image parameter area of the screen; long press <iTouch> to exit iTouch status.
 Click [iTTouch] on the soft menu or menu to adjust the gain in iTouch, with the adjusting range of -12-12dB.
 Click [iTTouch Bright] on the soft menu or menu to adjust the brightness, with adjusting range of -2-+2.

Post Process

- Description** Post process is used to apply modifications to a gray map in order to optimize overall image quality. Post process function includes 3 parameters: curve, gray rejection and γ .
- Gray Rejection** This function is to reject image signals less than a certain gray scale, then the rejected signal corresponding area turns black.
 Click [Gray Rejection] in the soft menu or menu to adjust.
 The adjusting range is 0-5.
- Curve** To manually enhance or restrain the signal in the certain scale.
 Click [Curve] in the soft menu or menu to open the dialogue box to adjust.
 Drag the curve node to increase or decrease the gray scale information: drag the node up to increase the information and down to decrease.
- γ** The γ correction is used to correct non-linear distortion of images.
 Click [γ] in the soft menu or menu to adjust.
 The adjusting range is 0-3; the image turns dark when the value is increased.
- Impacts** The function is available in real-time imaging, freeze or cine review status.
 The post process adjustment will not influence the cine review.

High FR

Description When the THI function is turned on, this function can provides you with much higher frame rate.

Operation In single B mode when THI is turned on, click the [High FR] item in the soft menu or menu to obtain images with high frame rates.

LGC

Description Adjust gain of the corresponding image areas to increase the image lateral resolution.

Operation Adjust through the [LGC1]-[LGC8] item in menu.

The 8-segment LGC indicate the corresponding image areas on the main screen.

The adjusting range is -5-5 in increments of 1.

Increasing the LGC value will increase the gain of the corresponding image areas.

HScale

Description Display or hide the width scale (horizontal scale).

The scale of the horizontal scale is the same as that of vertical scale (depth), they change together in zoom mode, or when the number of the image window changes. When image is turned up/down, the HScale will also be inverted.

Operation Click [HScale] on the soft menu to display or hide the scale.

Patient Temperature

Description If the current active probe is P7-3Ts, the parameter will display under the B mode menu. You can enter the patient temperature by this function.

Operation Enter the temperature by [Patient Temperature] on the soft menu.

Impacts This feature is only applied to 05.00.00 version software or higher versions.



WARNING:

If the patient temperature is above 37° C (98.6° F) and the [Patient Temperature] setting is below the actual reading, the system could overestimate the temperature of TEE transducer's distal tip. This could trigger the Auto-Cool function. If the patient temperature reaches or is above 37° C (98.6° F) and the [Patient Temperature] setting is above the actual reading, the system could underestimate the temperature of the TEE transducer's distal tip. The patient is exposed to excessive temperatures.

5.4 M Mode Image Optimization

5.4.1 M Mode Exam Protocol

1. Select a high-quality image during B mode scanning, and adjust to place the area of interest in the center of the B mode image.
 2. Press <M> on the control panel, and roll the trackball to adjust the sampling line.
 3. Press <M> on the control panel again or <Update> to enter M mode, and then you can observe the tissue motion along with anatomical images of B mode.
During the scanning process, you can also adjust the sampling line accordingly when necessary.
 4. Adjust the image parameters to obtain optimized images.
 5. Perform other operations (e.g. measurement and calculation) if necessary.
- If you choose "Enter 1D Mode Directly" in "[Setup]→[Image Preset]→[Other]", then the sampling line will be displayed at all times in B mode images, and pressing <M> will directly enter M mode.

5.4.2 M Mode Parameters

- In M mode scanning, the image parameter area in the upper left corner of the screen displays the real-time parameter values as follows:



Display	V 3	IP 6	DR 65	G 45
Parameter	M Speed	M IP	M Dynamic Range	M Gain

- Parameters that can be adjusted to optimize the M mode image are indicated in the following.

Adjustment	Items
Control Panel	Gain, TGC, Depth
Menu and Soft Menu	IP, Time Mark, Speed, Colorize, Colorize Map, Acoustic Power, Edge Enhance, Frequency, Gray Map, Focus Position, Dynamic Range, M Soften, Curve, Gray Rejection, γ , Display Format

- During M mode imaging, menus for B mode and M mode are displayed in the soft menu at the same time, use the left/right keys of soft menu controls <4> to switch between the menus of B mode and M mode.
- During M mode scanning, frequency and acoustic power of the probe are synchronous with that of B mode.
- Adjustment of the depth, focus position or TGC to the B mode image will lead to corresponding changes in M mode image.
- Press <Update> to switch between the real-time B and freezing B images.
- Items that appear in the menu or the soft menus are dependent upon preset, which can be changed or set through "[Setup] → [Image Preset]"; please refer to "5.15 Image Preset" for details.

5.4.3 M Mode Image Optimization

Gain

Description To adjust the gain of M mode image. The real-time gain value is displayed in the image parameter area in the upper left corner of the screen.

Operation Rotate the <iTouch> knob clockwise to increase the gain, and anticlockwise to decrease.

Or adjust it in the image parameter area.

The adjusting range is 0-100.

Effects Increasing the gain will brighten the image and you can see more received signals. However, noise may also be increased.

Focus Position

Description To change the focus position in M mode, symbols as "◀" of which are displayed on the right of the image.

Operation Adjust the focus position through the [Focus Position] item in the soft menu or menu.

Time Mark

Description To show the time mark in M mode image.

Operation Turn on or off the function through [Time Mark] item in the soft menu or menu.

Effects When time mark is displayed on the M mode image, it's much easier to identify the cardiac cycles and detect more details.

Impacts The function is available in real-time imaging, freeze or cine review status.

Display Format

Description To set the display format of M mode image with B mode image.

Operation Adjust through the [Display Format] item in the soft menu or menu.

There are 4 formats available for image display: L/R, V1:1, V1:2, Full.

Effects Adjust according to the actual situation and obtain a desired analysis through comparison.

Impacts The function is available in real-time imaging, freeze or cine review status.

Speed

Description This function is used to set the scanning speed of M mode imaging, and the real-time speed value is displayed in the image parameter area in the upper left corner of the screen.

Operation Change the speed through the [Speed] item in the soft menu or menu.
Or adjust it in the image parameter area.
There are 6 levels of scan speed available, the smaller the value the faster the speed.

Effects Speed changing makes it easier to identify disorders in cardiac cycles.

IP (Image Processing)

Description IP is a combination of several image processing parameters, which is used for a fast image optimization. The IP combination number is displayed in the image parameter area in the upper left corner of the screen.

The M IP combination parameters include dynamic range, edge enhance, and M soften.

Operation Select among the IP groups through the [IP] item in the soft menu or menu.
Or adjust it in the image parameter area.

The system provides 8 groups of IP combinations, and the specific value of each parameter can be preset.

Colorize and Colorize Map

Description Colorize function provides an imaging process based on color difference rather than gray distinction.

Operation Turn on or off the function through the [Colorize] item in the soft menu or menu.
Select the colorize map through the [Colorize Map] item in the soft menu or menu.
The system provides 10 different maps to be selected among.

Impacts The function is available in real-time imaging, freeze or cine review status.

Post Process

Description Post process is used to apply modifications to the image in order to optimize overall image quality. Post process function includes 3 parameters to adjust: curve, gray rejection and γ .

Gray Rejection This function is to reject image signals less than a certain gray scale.

Click [Gray Rejection] in the soft menu or menu to adjust.

The adjusting range is 0-5.

Curve To manually enhance or restrain the signal in the certain scale.

Click [Curve] in the soft menu or menu to open the dialogue box to adjust.

Drag the curve node to increase or decrease the gray scale information: drag the node up to increase the information and down to decrease.

- γ** The γ correction is used to correct non-linear distortion of images.
Click [γ] in the soft menu or menu to adjust.
The adjusting range is 0-3.
- Impacts** The function is available in real-time imaging, freeze or cine review status.
The post process adjustment will not influence the cine review.

Gray Map

- Description** This function applies the gray correction to obtain the optimum image through adjusting 3 parameters: curve, gray rejection and γ.
- Operation** Select among the maps through the [Gray Map] item in the soft menu or menu.
You can also adjust through the grayscale bar: move the cursor to the grayscale bar and press <Set> on the control panel to adjust.
The system provides 8 groups of gray map.
- Impacts** The function is available in real-time imaging, freeze or cine review status.

Edge Enhance

- Description** This function is used to increase image profile, so as to distinguish the image boundary.
- Operation** Adjust through the [Edge Enhance] item in the soft menu or menu.
The system provides 4 levels of edge enhance effects, off represents no edge enhance is turned on, and the bigger the value the stronger the effect.
- Impacts** Larger edge enhance may lead to noise increasing.

Dynamic Range

- Description** This function is used to adjust the B image resolution to compress or expand the gray display range. The real-time dynamic range value will be displayed in the image parameter area in the upper left corner of the screen.
- Operation** Adjust through the [Dyn Ra.] item in the soft menu or menu.
Or adjust it in the image parameter area.
The adjusting range is 30-160dB in increments of 5.
- Effects** The more the dynamic range, the more specific the information, and the lower the contrast with more noise.

M Soften

- Description** This feature is used to process the scan lines of M images to reject noise, making the image details to be clearer.
- Operation** Adjust through the [M Soften] item in the soft menu or menu.
The system provides 5 levels of M Soften adjustment, the bigger the value the stronger the effect.

5.5 Color Mode Image Optimization

The Color mode is used to detect color flow information, and the color is designed to judge the direction and speed of blood flow.

Generally, the color above the color bar indicates the flow towards the probe, while the color below the color bar indicates the flow away from the probe; the brighter the color, the faster the flow speed; while the darker the color, the slower the flow speed.

5.5.1 Color Mode Exam Protocol

1. Select a high-quality image during B mode scanning, and adjust to place the area of interest in the center of the image.
2. Press <Color> to enter B+Color mode. Use the trackball and <Set> to change position and size of the Region of Interest (ROI).
3. Adjust the image parameters during scanning to obtain optimized images.
4. Perform other operations (e.g. measurement and calculation) if necessary.

5.5.2 Color Mode Image Optimization

- In Color mode scanning, the image parameter area in the upper left corner of the screen displays the real-time parameter values as follows:

C
F3.3 / G38
IP1 / WF43
PRF0.4k

Display	F 3.3	G38	IP 1	WF 43	PRF 0.4k
Parameter	Frequency	Color Gain	Color IP	Color Wall Filter	Pulse Repetition Frequency PRF

- Parameters that can be adjusted to optimize the Color mode image are indicated in the following.

Adjustment	Items
Control Panel	Gain, Depth
Menu and Soft Menu	B/C Wide, Frequency, Priority, Baseline, Packet Size, Dual Live, Color IP, Map, A. power, Focus Position, Scale, Flow State, WF, Invert, Line Density, Smooth, Persistence, B Display, Steer

- In Color mode, acoustic power is synchronous with that of B mode. Adjustment of the depth or zoom to the B mode image will lead to corresponding changes in Color mode image.
- During Color mode imaging, menus for B mode and Color mode are displayed in the soft menu at the same time, use the left/right keys of soft menu controls <4> to switch the menus of B mode and Color mode.
- Items that appear in the menu or the soft menus are dependent upon preset, which can be changed or set through "[Setup] → [Image Preset]"; please refer to "5.15 Image Preset" for details.

5.5.3 Color Mode Image Optimization

Color Gain

- Description** Refers to the overall sensitivity to flow signals, and this function is used to adjust the gain in Color mode. The real-time gain value is displayed in the image parameter area in the upper left corner of the screen.
- Operation** Rotate the <iTouch> knob clockwise to increase the gain, and anticlockwise to decrease.
Or adjust it in the image parameter area.
The adjusting range is 0-100.
- Impacts** Increasing the gain will increase the flow signal presented as well as noise, while the signals may be missing when the gain is adjusted too low.

ROI Adjustment

- Description** To adjust the width and position of ROI in Color mode.
- Operation** When the ROI box is dotted line, roll the trackball to change its size.
When the ROI box is solid line, roll the trackball to change the position.
Press <Set> to switch between the solid line and the dotted line status.
You can set the default ROI position and size in "[System Preset]→[Image Preset]→ Color".
- Impacts** The larger the ROI box, the lower the frame rate, and the lower the resolution and color sensitivity.

Frequency

- Description** Refers to the operating frequency in Color mode of the probe, the real-time value of which is displayed in the image parameter area in the upper left corner of the screen.
- Operation** Select the frequency value through the [Frequency] item in the soft menu or menu.
Or adjust it in the image parameter area.
Values of frequency vary by probes. Select the frequency value according to the need of the detection depth and the current tissue characteristics.
- Effects** The higher the frequency, the worse the axial resolution, and the better the force of penetration.

Focus Position

- Description** To adjust the color focus position against the ROI position.
- Operation** Change the position through the [Focus Position] item in the soft menu or menu.

B Display

- Description** To turn on or off the B image display as Color imaging remains active.
- Operation** Turn on or off the function through the [B Display] item in the soft menu or menu.
- Impacts** The function is available in real-time imaging, freeze or cine review status.

B/C Wide

- Description** To set and constrain the maximum width of the B mode image to that of the Color ROI.
- Operation** Turn on or off the function through the [B/C Wide] item in the soft menu or menu.
- Impacts** Frame rate will increase when the function is turned on.

Dual Live

- Description** This function is used to display B image and Color image synchronously.
- Operation** Click [Dual Live] in the soft menu or menu to turn on or off the function. When the function is turned on, the window will be automatically switched to the dual windows (one for B image, and the other for Color image).
- Impacts** The function is available in real-time imaging, freeze or cine review status.

Steer

- Description** The feature is used to adjust the ROI of color flow with different angles with immobility of the linear probe.
- Operation** Adjust through the [Steer] item in the soft menu or menu, or rotate the multifunctional knob to adjust.
Values of steering angles vary by probes.
- Effects** This function is used to adjust the scan angle of linear probes, so as to change the angle between the transmitting beam and flow direction.
- Impacts** Steer is available only for linear probes.

Line Density

- Description** The function determines the quality and information of the image.
- Operation** Adjust through the [Line Density] item in the soft menu or menu.
There are 2 levels of line density provided: UH, H, M, L.
- Effects** The higher the line density, the higher the resolution.
- Impacts** The higher the line density, the smaller the frame rate.

Packet Size

Description This function is an indication of the ability to detect flow, which is used to adjust the accuracy of color flow.

Operation Adjust through the [Packet Size] item in the soft menu or menu.
There are 4 levels of packet size provided, 0 represents no packet size control and the bigger the value the higher the sensitivity.

Effects The higher the packet size, the more sensitive indication for low-velocity flow.

Impacts Increasing the packet size will lead to frame rate decrease.

Flow State

Description This function is used for a fast image optimization by providing an adjustment of 2 parameters, including scales and filters.

Operation Adjust through the [Flow State] item in the soft menu or menu.
There are 3 levels provided to adjust: L, M, H.

Persistence

Description This function is to adjust the temporal smooth in Color mode to optimize the image.

Operation Adjust through the [Persistence] item in the menu or the soft menu.
The system provides 5 levels of persistence adjustment, 0 represents no persistence and the bigger the value the stronger the effect.

Smooth

Description This feature is used to reject noise and smooth the image.

Operation Adjust through the [Smooth] item in the soft menu or menu.
The system provides 5 levels of smooth function, the bigger the value the higher the smooth.

Scale

Description This function is used to adjust the speed range of color flow, which is adjusted through PRF in the system. The real-time PRF value will be displayed in the image parameter area in the upper left corner of the screen.

Operation Adjust the speed range through the [Scale] item in the menu or the soft menu.
The adjusting range varies by frequency, probe and depth; adjust according to the actual situation.

Effects To provide a much clearer color flow image.
Use low PRF to observe low-velocity flows, and high PRF to observe high-velocity flows.

Impacts Aliasing may occur if low velocity scale is used and high velocities are encountered.
Low velocities may not be identified when a high velocity scale is used.

Baseline

Description Refers to the area where the velocity is zero in the scale. Adjust according to the actual situation so as to get an optimum flow display.

Operation Adjust through the [Baseline] item in the soft menu or menu.
Positive value means to increase the signals above the baseline, and negative value means to increase the signals below the baseline.

Impacts The function is available in real-time imaging, freeze or cine review status.

Invert

Description To set the display mode of the color flow, and the color scale will be inverted when the function is turned on.

Operation Turn on or off the function through the [Invert] item in the soft menu or menu.
Select "Auto Invert" in the "[Setup] → [System Preset] → [Image Preset]", then the color bar can automatically invert when the color flow is steered to a certain angle to accommodate operator's habit of distinguishing flow direction.

Impacts The function is available in real-time imaging, freeze or cine review status.

Map

Description This function is a combination of several image parameters, which indicates the display effect of color image.

Operation Select among the maps through the [Map] item in the soft menu or menu.
You can also adjust through the color bar: move the cursor to the color bar and press <Set> on the control panel to adjust.
The system provides 21 different maps to be selected among, where the V group provides 11 ordinary maps and the VV group provides 10 2-D maps.

Impacts The function is available in real-time imaging, freeze or cine review status.

Color IP

Description Color IP is a combination of several image processing parameters, which is used for a fast image optimization. The IP combination number is displayed in the image parameter area in the upper left corner of the screen.

The Color IP combination parameters include persistence and smooth.

Operation Select among the maps through the [Color IP] item in the soft menu or menu.

Or adjust it in the image parameter area.

The system provides 8 groups of IP combinations, and the specific value of each parameter can be preset.

WF (Wall Filter)

Description It filters out low-frequency signals to provide effective information, and this function is used to adjust the filtered frequency. The real-time value is displayed in the image parameter area in the upper left corner of the screen.

Operation Select through the [WF] item in the soft menu or menu.
Or adjust it in the image parameter area.
There are 8 levels of wall filter function, adjust according to the actual situation and the probe.

Impacts Flow signals may be missing.

Priority

Description This function is used to set levels of the flow display, to display the grayscale signal or color signal.

Operation Select the value through the [Priority] item in the soft menu or menu.
The adjusting range is 0-100%.

Effects The higher the value, color signals are prior to be displayed; while the lower the value, grayscale signals are prior to be displayed.

iTouch

Description To optimize image parameters as per the current tissue characteristics for a better image effect.

Operation Press <iTouch> on the control panel to turn on the function, the symbol of which will be displayed in the image parameter area of the screen.

Smart Track

Description To optimize image parameters as per the current tissue characteristics for a better image effect. The angle and the position of the ROI are adjusted after the function is enabled. The area is tracked without being affected by the dynamic moves.

Operation Tap [Smart Track] on the soft menu under Color/Power mode. The vessels lay in the middle of the ROI.

Impacts All linear probes under Vascular, carotid and EM VAS exam modes supports the smart track.

5.6 Power Mode Image Optimization

Power mode provides a non-directionally display of blood flow in the form of intensity as opposed to flow velocity.

DirPower (Directional Power Mode) provides the additional information of flow direction towards or away from the probe.

5.6.1 Power Mode Exam Protocol

1. Select a high-quality image during B mode or B+ Color scanning, and adjust to place the area of interest in the center of the image.
2. Press <Power> to enter B+Power mode. Use the trackball and <Set> to change position and size of the Region of Interest (ROI).
3. Adjust the image parameters to obtain optimized images.

4. Perform other operations (e.g. measurement and calculation) if necessary.

5.6.2 Power Mode Image Parameters

- In Power mode scanning, the image parameter area in the upper left corner of the screen displays the real-time parameter values as follows:

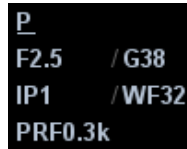

Display	F 2.5	G 38	IP 1	WF32	PRF 0.3k
Parameter	Frequency	Power Gain	Power IP	Power Wall Filter	Pulse Repetition Frequency PRF

Parameters that can be adjusted to optimize the Power mode image are indicated in the following.

Type	Parameter
Control Panel	Gain, TGC, Depth
Menu and Soft Menu	B/C Wide, Frequency, Priority, Dynamic Range, Packet Size, Dual Live, Power IP, Map, Acoustic Power, Focus Position, Scale, Flow State, Wall Filter, Invert, Line Density, Smooth, Persistence, B Display, Steer

- During Power mode imaging, menus for B mode and Power mode are displayed in the soft menu at the same time, use the left/right keys of soft menu controls <4> to switch between the menus of B mode and Power mode.
- In Power mode, acoustic power is synchronous with that of B mode. Adjustment of the depth or zoom to the B mode image will lead to corresponding changes in Power mode image.
- Items that appear in the menu or the soft menus are dependent upon preset, which can be changed or set through "[Setup] → [Image Preset]"; please refer to "5.15 Image Preset" for details.

Parameters consistent with those in Color mode and B mode are not to be introduced, please refer to relevant section of the Color mode and B mode, while special items of the Power mode are introduced in the following.

5.6.3 Power Mode Image Optimization

Power Gain

Description Refers to the overall sensitivity to flow signals, and this function is used to adjust the gain in Power mode. The real-time gain value is displayed in the image parameter area in the upper left corner of the screen.

Operation Rotate the <iTouch> knob clockwise to increase the gain, and anticlockwise to decrease.

Or adjust it in the image parameter area.

The adjusting range is 0-100.

Effects Increasing the gain will increase the flow signal presented as well as noise, while the signals may be missing when the gain is adjusted too low.

Map

Description This feature indicates the display effect of power image. The maps in Power mode image are grouped into two categories: Power maps and Directional Power maps.

Operation Select the map through the [Map] item in the soft menu or menu.
There are 8 kinds of maps provided: P0-3 belong to Power Mode maps, while dP0-3 belong to Directional Power Mode maps.

The Power maps provide information of blood flow, which are highly sensitive to the low-velocity flows.

The Directional Power maps provide information of flow direction.

Impacts The function is available in real-time imaging, freeze or cine review status.

Dynamic Range

Description This function is to adjust the transformation of echo intensity into color signal.

Operation Adjust through the [Dyn Ra.] item in the soft menu or menu.
The adjusting range is 10-70dB in increments of 5dB.

Effects Increasing dynamic range will lead to higher sensitivity to low-power signals, thus enhances the range of signals to display.

5.7 PW/CW Doppler Mode Optimization

PW (Pulsed Wave Doppler) mode or CW (Continuous Wave Doppler) mode is used to provide blood flow velocity and direction utilizing a real-time spectral display. The horizontal axis represents time, while the vertical axis represents Doppler frequency shift.

PW mode provides a function to examine flow at one specific site for its velocity, direction and features; while CW mode proves to be much more sensitive to high velocity flow display. Thus, a combination of both modes will contribute to a much more accurate analysis.

5.7.1 PW / CW Mode Exam Protocol

1. Select a high-quality image during B mode or B+ Color (Power) scanning, and adjust to place the area of interest in the center of the image.
2. Press <PW>/<CW> to enter the sampling state,
 - The sampling parameters will be displayed in the image parameter area on the left part of the screen as follows:



PW
SVD10.5
SV3.0



CW
SVD13.2

- The sampling correction angle value will be displayed above the image, as described in the following table: 

PW Sampling Line Adjustment	SV Size	SV 3.0
	Angle	Angle 0°
	SVD	SVD 10.5cm
CW Sampling Line Adjustment	Angle	Angle 0°
	CW Focus Depth	SVD 13.2cm

3. Set the SVD by rotating the trackball; adjust the angle and SV size according to the actual situation.
 4. Press <PW>/<CW> again or <Update> to enter PW/CW Mode and perform the examination. You can also adjust the SV size, angle and depth in the real-time scanning.
 5. Adjust the image parameters during PW/CW mode scanning to obtain optimized images.
 6. Perform other operations (e.g. measurement and calculation) if necessary.
- If you choose "Enter 1D Mode Directly" in "[Setup]→[Image Preset]→[Other]", then the sampling line will be displayed at all times in B mode images, and pressing <PW>/<CW> will directly enter PW/ CW mode.

5.7.2 PW/CW Mode Image Parameters

In PW/ CW mode scanning, the image parameter area in the upper left corner of the screen displays the real-time parameter values as follows:

PW F2.5 / G60 PRF3.6k WF 295 SVD8.8 SV 3.0	CW F3.3 / G30 PRF7.3k WF 407 SVD35.0
--	---

PW	Display	F 2.5	G 60	PRF 3.6k	WF295	SVD 8.8	SV 3.0
	Parameters	Frequency	Gain	Pulse Repetition Frequency PRF	WF (Wall Filter)	SV Position	SV Size
CW	Display	F 3.3	G 30	WF407	PRF 7.3k	SVD 35.0	
	Parameters	Frequency	Gain	WF (Wall Filter)	Pulse Repetition Frequency PRF	SV Position	

Parameters that can be adjusted to optimize the PW/ CW mode image are indicated in the following.

Adjustment	Items
Control Panel	Gain, TGC, Depth

Adjustment		Items
Soft Menu & Menu	PW	Invert, SV, WF, Frequency, Duplex/Triplex, V Max, V Mean, Audio, Trace Area, Colorize Map, Speed, Acoustic Power, Trace Sensitivity, T/F Res, Gray Map, Dynamic Range, Scale, Baseline, Colorize, Quick Angle, Angle, Trace Smooth, Time Mark, HPRF, Curve, Gray Rejection, γ , Display Format, Auto Calculation, Auto Calculation Parameter, PW Steer
	CW	WF, Invert, Colorize Map, Frequency, Speed, V Max, V Mean, Dynamic Range, Audio, Trace Area, Trace Sensitivity, Gray Map, Scale, Baseline, Colorize, Quick Angle, Angle, Acoustic Power, Trace Smooth, Time Mark, T/F Res, Curve, Gray Rejection, γ , Display Format, Auto Calculation, Auto Calculation Parameter

- During PW/ CW mode imaging, menus for B mode and PW/ CW mode are displayed in the soft menu at the same time, use the left/right keys of soft menu controls <4> to switch the among menus of B mode and PW/ CW mode.
 - In PW/CW mode, acoustic power of the probe is synchronous with that of B mode.
 - When you adjust the depth of the B mode image, related changes will occur in PW/CW Mode image as well.
 - Most of the parameters are the same for the PW mode and CW mode, so parameters of the both are combined together to be introduced here.
 - Adjustment items, such as SV, steer, Duplex, Triplex, iTouch and HPRF, are not available in the CW mode.
 - Items that appear in the menu or the soft menus are dependent upon preset, which can be changed or set through "[Setup] → [Image Preset]"; please refer to "5.15 Image Preset" for details.
 - Press <Update> to switch between the real-time B and freezing B images.
- Only phased probes support CW mode.

5.7.3 PW/CW Doppler Mode Optimization

Gain

Description This function is intended to adjust the gain of spectrum map. The real-time gain value is displayed in the image parameter area in the upper left corner of the screen.

Operation Rotate the <iTouch> knob clockwise to increase the gain, and anticlockwise to decrease.

Or adjust it in the image parameter area.

The adjusting range is 0-100.

Effects Increasing the gain will brighten the image and you can see more received signals. However, noise may also be increased.

Frequency

Description Refers to the operating frequency in PW mode of the probe, the real-time value of which is displayed in the image parameter area in the upper left corner of the screen.

Operation Select the frequency value through the [Frequency] item in the soft menu or menu.
Or adjust it in the image parameter area.
Values of frequency vary depending upon the probe types.
Select the frequency according to the detection depth and current tissue characteristics.

Effects The higher the frequency, the better the resolution and sensitivity, and the worse the force of penetration.

Scale

Description This function is used to adjust the speed range of color flow, which is adjusted through PRF in the system. The real-time PRF value will be displayed in the image parameter area in the upper left corner of the screen.

Operation Adjust the speed range through the [Scale] item in the menu or the soft menu.
The adjusting range varies by frequency, probe and depth; adjust according to the actual situation.

Effects To provide a much clearer color flow image.
Use low PRF to observe low-velocity flows, and use high PRF to observe high-velocity flows.

Impacts Aliasing may occur if low velocity scale is used and high velocities are encountered.
Low velocities may not be identified when a high velocity scale is used.

iTouch

Description To optimize image parameters as per the current tissue characteristics for a better image effect.

Operation Press <iTouch> on the control panel to enter the iTouch status, the symbol of which will be displayed in the image parameter area of the screen.
You can preset the mode for iTouch function.

It is not available in the CW mode.

Auto Calculation and Auto Calculation Parameter

Description This function is used to trace the spectrum and calculate parameters of PW/CW mode image, and the results of which are displayed in the result window.

Operation Click [Auto Calc] in the soft menu or menu to turn on or off the function.
Select parameters in the dialogue box prompted by clicking [Auto Calc Param].
In real-time scanning, the results displayed are derived from the calculation of latest cardiac cycle.
In the freezing and cine status, the results displayed are calculated from the current selected area.
You can define user-defined key for auto calculation function in "[Setup] → [System Preset] → [Key Config]".

Impacts Note: heart rate value obtained by auto calculation may be of deviation, please adopt manual measurement or ECG function (optional) to get the precise value.

Auto Calc Cycle

Description To set the number of heart cycle for auto calculation.

Operations Click [Auto Calc Cycle] on the soft menu or the menu.

Invert

Description This function is used to set the display manner of spectrum.

Operation Turn on or off the function through the [Invert] item in the soft menu or menu.

Select "Auto Invert" in the "[Setup] → [System Preset] → [Image Preset]", then the color bar can automatically invert when the color flow is steered to a certain angle to accommodate operator's habit of distinguishing flow direction.

Impacts The function is available in real-time imaging, freeze or cine review status.

Speed

Description This function is used to set the scanning speed of PW mode imaging.

Operation Adjust the speed through the [Speed] item in the soft menu or menu.
There are 6 levels of scan speed available, the smaller the value the faster the speed.

Effects Changing the speed makes it easier to identify the cardiac cycles and to detect more details.

T/F Res

Description This function is used to adjust for a balance between time resolution and spatial resolution.

Operation Adjust through the [T/F Res] item in the soft menu or menu.
There are 4 levels of T/F Res values available, adjust according to the actual situation and the transducer.

WF (Wall Filter)

Description It filters out low-velocity signals to provide effective information, and this function is used to adjust the filtered frequency. The real-time value is displayed in the image parameter area in the upper left corner of the screen.

Operation Select through the [WF] item in the soft menu or menu.
Or adjust it in the image parameter area.
There are 7 levels of wall filter function available, adjust according to the actual situation and the transducer.

Impacts Flow signals may be missing.

Time Mark

- Description** Turn on or off the function to show the time mark in PW mode image, which facilitates to specify the time information of special points.
- Operation** Turn on or off the function through [Time Mark] item in the soft menu or menu.
- Effects** This function facilitates to specify the time information of special points, and makes it easier to identify the cardiac cycles and detect more details.
- Impacts** The function is available in real-time imaging, freeze or cine review status.

Colorize and Colorize Map

- Description** Colorize function provides an imaging process based on color difference rather than gray distinction.
- Operation** Turn on or off the function through the [Colorize] item in the soft menu or menu.
Select the map through the [Colorize Map] item in the soft menu or menu.
The system provides 10 colorize maps to be selected among.
You can define user-defined key for colorize function in "[Setup] → [System Preset] → [Key Config]".
- Impacts** The function is available in real-time imaging, freeze or cine review status.

Trace

- Trace Area** To set the trace area of the Doppler wave in the spectrum map, applicable for auto calculation, V Max and V Mean display.
Change the trace area through the [Trace Area] item in the soft menu or menu.
The available selections of trace area are: Above, Below, All.
- Trace Smooth** To set the smooth level when tracing.
Change the effect through the [Trace Smooth] item in the soft menu or menu.
There are 5 levels of smooth effect provided, the bigger the value, the higher the smooth processing.
- Trace Sensitivity** This function is used to set the sensitivity of tracing in the spectrum.
Adjust through the [Trace Sensitivity] item in the soft menu or menu.
There are 6 levels of sensitivity adjustment, the bigger the value the higher the sensitivity.
- V Max & V Mean** To display maximum speed and average speed in the spectrum automatically.
Click [V Max] or [V Mean] in the soft menu or menu to turn on or off the function.
In the spectrum map, maximum speed is displayed in red curve, while the average speed is displayed in blue curve.
- Impacts** The function is available in real-time imaging, freeze or cine review status.

Gray Map

Description This function applies the gray correction to obtain the optimum image.

Operation Select among the maps through the [Gray Map] item in the soft menu or menu.

There are 8 different gray maps available.

Impacts The function is available in real-time imaging, freeze or cine review status.

Display Format

Description To set the display format of PW mode image with B mode image.

Operation Adjust through the [Display Format] item in the soft menu or menu.

There are 4 formats to display the images: V1:1, L/R, V1:2, Full.

Impacts The function is available in real-time imaging, freeze or cine review status.

Duplex/ Triplex

Description This function is used to set if B image (B+Color image) and PW image are displayed synchronously.

Operation Turn on or off the function through the [Duplex] / [Triplex] in the soft menu or menu.

Impacts The function is available in real-time imaging, freeze or cine review status.

HPRF

Description HPRF mode is used when detected velocities exceed the processing capabilities of the currently selected PW Doppler scale or when the selected anatomical site is too deep for the selected PW Doppler scale.

Operation Turn on or off the function through the [HPRF] item in the soft menu or menu.

Effects HPRF enhances the range of detecting high-velocity flow.

Baseline

Description Refers to the area where the velocity is zero in the spectrum.

Operation Adjust through the [Baseline] item in the soft menu or menu.

Effects Adjust baseline according to the actual situation to change the range of flow velocity to optimize the image.

Positive value means to enhance the signals above the baseline, and negative value means to enhance the signals below the baseline.

Impacts The function is available in real-time imaging, freeze or cine review status.

Angle

Description This function is used to adjust the angle between Doppler vector and flow to make the velocity more accurate.

The real-time adjusting angle value is displayed on the right part of the spectrum map.

- Operation** Adjust through the [Angle] item in the soft menu or menu.
The adjustable angle range is -89~89° in increments of 1°.
- Impacts** The function is available in real-time imaging, freeze or cine review status.

Quick Angle

- Description** To adjust the angle faster in increments of 60°, and the real-time value of which is displayed on the right part of the spectrum map.
- Operation** Adjust through the [Quick Angle] item in the soft menu or menu.
There are 3 angles for quickly adjustment: -60°, 0°, and 60°.
- Impacts** The function is available in real-time imaging, freeze or cine review status.

Dynamic Range

- Description** The dynamic range conveys the information being transformed from echo intensity to gray scale.
- Operation** Adjust through the [Dyn Ra.] item in the soft menu or menu.
The adjusting range is 24-72dB in increments of 2dB.
- Effects** The more the dynamic range, the more specific the information, and the lower the contrast with more noise.
- Impacts** The function is available in real-time imaging, freeze or cine review status.

Audio

- Description** This function is used to adjust the output audio in spectrum map,
- Operation** Adjust through the [Audio] item in the soft menu or menu.
Or press "<Fn>+ Directional key (Up/Down)" to adjust.
The adjusting range is 0-100%.
- Effects** Audio helps to identify the feature and status of flow.
- Impacts** The function is available in real-time imaging, freeze or cine review status.

PW Steer

- Description** This function is used to adjust the scan angle of linear probes, so as to change the angle between the transmitting beam and flow direction.
- Operation** Adjust through the [PW Steer] item in the soft menu or menu.
Values of steering angles vary by probes.
- Effects** This feature is used to steer the direction of the beam so as to change the angle between the beam and flow direction with immobility of the linear probe.

Post Process

- Description** Post process is used to apply modifications to the image in order to optimize overall image quality. Post process function includes 3 parameters : curve, gray rejection and γ .
- Gray** This function is to reject image signals less than a certain gray scale.

Rejection	Click [Gray Rejection] in the soft menu or menu to adjust. The adjusting range is 0-5.
Curve	To manually enhance or restrain the signal in the certain scale. Click [Curve] in the soft menu or menu to open the dialogue box to adjust. Drag the curve node to increase or decrease the gray scale information: drag the node up to increase the information and down to decrease.
γ	The γ correction is used to correct non-linear distortion of images. Click [γ] in the soft menu or menu to adjust. The adjusting range is 0-3.
Impacts	The function is available in real-time imaging, freeze or cine review status. The post process adjustment will not influence the cine review.
SV	
Description	To adjust the SV position and size of sampling in PW mode, the real-time value of SV and SVD are displayed in the image parameter area in the upper left corner of the screen.
Operation	Adjust the SV size through the [SV] item in the soft menu or menu. Roll the trackball to adjust the SV depth. Or adjust the SV directly in the image parameter area. The adjusting range is 0.5-20.0mm.
Effects	The smaller the SV size, the more accurate the result; and more information can be obtained when selected large SV size.

5.8 Anatomical M Mode

	CAUTION: Anatomical M images and Color Anatomical M images are provided for reference only, not for confirming a diagnosis. Please compare the image with that of other machines, or make diagnosis using none-ultrasound methods.
---	---

5.8.1 Free Xros M Mode

For an image in the traditional M mode, the M-mark line goes along the beams transmitted from the probe. Thus it is difficult to obtain a good plane for difficult-to-image patients that cannot be moved easily. However, in the anatomical M mode, you can manipulate the M-mark line to move to any position at desired angles. The system supports anatomical M scanning (including Free Xros M mode and Free Xros CM mode) in 2D imaging modes (B, Color, Power and TVI mode).

5.8.1.1 Imaging

- Shortcut key for Free Xros M mode

Assign a user-defined shortcut key for Free Xros M: [Setup] → [System Preset] → [Key Config]. Please refer to "15.1.7 Key Config" for details.

- Real-time Imaging

1. In real-time B mode or M mode, adjust the probe and image to obtain the desired plane.
2. Click [Free Xros M] in the soft menu or menu to enter Free Xros M mode, or press the user-defined key.
3. Adjust the M-mark (single or multiple) line to obtain optimized images and necessary information.

In Dual-split or Quad-split mode, it is the current activated window that enters the Free Xros M Mode.

- Imaging in Freeze Mode

1. Free Xros M imaging of images in cine memory
 - For B frozen images, press <M> or click [Free Xros M] in the soft menu, or press the user-defined key directly.
 - For B+M frozen images, click [Free Xros M] in the soft menu, or press the user-defined key directly.
 - For B+Power/Color/TVI frozen images, enter single-B cine memory first (refer to "7.2.2 Cine Review in 2D Mode") and click [Free Xros M] in the soft menu or press <M> on the control panel, or press the user-defined key.
 - If it is in the dual-split or quad-split scanning, it is the current activated window that enters the Free Xros M mode, and click [Update] to switch between the images in dual-split or quad-split B mode images.
2. Adjust the M-mark line (single or multiple) and image parameters to obtain optimized images and necessary information.

5.8.1.2 Free Xros M Image Parameters

- In Free Xros M mode imaging, the image parameter area in the upper left corner of the screen displays the real-time parameter values as follows:

Free Xros M
V3 / G62

Display	G 62	V 3
Parameter	Free Xros M Gain	Free Xros M Speed

- Parameters that can be adjusted to optimize the Free Xros M mode image are indicated in the following.

Adjustment	Items
Control Panel	Gain, TGC
Menu and Soft Menu	Colorize, Post Process (γ, curve, gray rejection), Display Format, Display, Mark Adjustment, Time Mark, Angle, Speed, Gray Map, Colorize Map

- During real-time Free Xros M mode imaging, menus for B mode, Free Xros M mode and other modes are displayed in the soft menu at the same time, use the left/right keys of soft menu controls <4> to switch the menus.
- While imaging in freeze mode, menus of image optimization for B mode, Free Xros M mode and other modes are displayed in the soft menu at the same time. Use the left/right keys of soft menu controls <4> to switch the menus.
- Parameters consistent with those in M mode are not to be introduced, please refer to relevant section of the M mode, while special items of the Free Xros M mode will be introduced in the following.
- Items that appear in the menu or the soft menus are dependent upon preset, which can be changed or set through "[Setup] → [Image Preset]"; please refer to "5.15 Image Preset" for details.

Display or Hide the M-mark Line

- Description** There are 3 M-mark lines available, each with a symbol of "A", "B" or "C" at the one end as identification and an arrow on the other end as a mark for direction.
- Operation** Click [Show A], [Show B], [Show C] in the soft menu or menu to display or hide the sampling line, and the corresponding image will be displayed on the screen once the related item is selected.
- Impacts** When there is only one M-mark line on the screen, you cannot hide it.

Switching between the M-mark Lines

- Description** To switch between the M-mark lines in Free Xros M mode.
- Operation** Press <Set> to switch between the M-mark lines and press <Cursor> to show the cursor.
The activated M-mark line will be green and the inactivated one will be white.

Adjustment of the M-mark Line

- Description** To adjust the position and angle of the M-mark line.
- Operation**
- Position Adjustment
When the M-mark line is activated, move the trackball left and right to adjust the position. The direction is recognized by the arrow at the end of the line.
 - Angle Adjustment
When the M-mark line is activated, move the trackball to adjust the fulcrum of the line, and adjust the angle via the [Angle] in the soft menu or the multifunctional knob.
The adjusting angle range is 0-360 in increments of 1.

Display

- Description** This function is to adjust the display of the images when there is more than one M-mark line.
- Operation** Adjust through the [Display] item in the soft menu or menu.
You can choose to display image of the current M-mark line or the all.

5.8.1.3 Exit

- In Free Xros M mode, click [Free Xros M] in the soft menu or press or the user-defined key to exit.

5.8.2 Free Xros CM (Curved Anatomical M Mode)

	CAUTION: Free Xros CM images are provided for reference only, not for confirming a diagnosis. Please compare the image with that of other machines, or make diagnosis using none-ultrasound methods.
---	---

In Free Xros CM mode, distance/time curve is generated from the sample line manually depicted at anywhere on the image. Free Xros CM mode can be entered through B, Color, Power and TVI modes.

5.8.2.1 Basic Workflow in Free Xros CM

First accessing to Free Xros CM mode after system has been started up:

1. In 2D real time scanning mode, adjust the probe and image to get the desired image, and then fix the probe.
2. Click [Free Xros CM] on the B mode soft menu or press the user-defined key on the control panel to enter Free Xros CM mode.
3. Roll the trackball to define the start point of the sample line on the 2D image.
The cursor displays as , and can be moved within the 2D image only.
4. Press <Set> key to fix the start point, and the digital number “1” is marked beside the point.
5. Define the next point using the trackball and <Set> key (click [Undo] to cancel the current point and activate the preview point), the system updates the time-motion curve in real time. The sample line is displayed in green, and each point is marked with a number in sequence.
6. Repeat Step 4 and 5 to finish the sample line.
7. Double click <Set> key to end the editing, and the sample line is displayed in white.
8. Adjust the image parameters to optimize the image, obtain the interested tissue image for data analysis, and then save the image if necessary.
9. Click [Free Xros CM] again to exit Free Xros CM mode.

Sample Line Modification

1. To enter into curve (sample line) modification status:
 - When enter the Free Xros CM mode (not the first time after system started up), the sample line of the last Free Xros CM exam is displayed in edit status, and the cursor is displayed as .
 - For a finished sample line, set [Edit] as “On”, the sample line is editable.
2. Anchor the cursor on a certain point, press <Set> key to activate the point, then roll the trackball to drag the point for a desired sample line.
3. Double click <Set> key to end the edit and the sample line is displayed in white.
4. Click [Free Xros CM] again to exit Free Xros CM mode.

Delete the Sample Line

Click the sample line to select it, and click [Delete] to delete the selected line and you can re-depict a new sample line.

Tips:

Parameters of Free Xros M mode and Free Xros CM mode are dependent from each other, but their functions are the same, parameters of Free Xros CM are not to be introduced, please refer to relevant sections of the M mode and Free Xros M mode.

5.9 TDI

TDI mode is intended to provide information of low-velocity tissue motion, specifically for cardiac movement.

There are 4 types of TDI mode:

- Tissue Velocity Imaging (TVI): This imaging mode is used to detect tissue movement with direction and speed information.
 - Tissue Energy Imaging (TEI): This imaging mode reflects the status of cardiac movement by displaying the intensity of tissue, the brighter the color the less the intensity.
 - Tissue Velocity Doppler Imaging (TVD): This imaging mode provides direction and speed information of the tissue quantitatively with doppler spectrum.
 - Tissue Velocity M Imaging (TVM): This function assists to observe the cardiac motion through a direct angle. TVM mode is also called Color Tissue M mode, refer to "5.10 Color M Mode" for details.
- Only phased probe is valid for TDI function.

5.9.1 TDI Exam Protocol

- Enter TDI
- User-defined shortcut key
 - a) Assign a user-defined shortcut key for TDI: the setting path is "[Setup] → [System Preset] → [Key Config]". Please refer to "15.1.7 Key Config" for details.
 - b) Press the user-defined key in B mode to enter TVI mode.
 - In real-time mode, click [TDI] in the soft menu or menu to enter the corresponding TDI mode as follows:
 - In Color mode, click [TDI] to enter TVI mode, parameters of TVI mode will be displayed in the soft menu.
 - In Power mode, click [TDI] to enter TEI mode, parameters of TEI mode will be displayed in the soft menu.
 - In PW mode, click [TDI] to enter TVD mode, parameters of TVD mode will be displayed in the soft menu.
 - In M mode, click [TDI] to enter TVM mode, parameters of TVM mode will be displayed in the soft menu.
- Switching between the TDI modes
- In TDI mode, press <Color>, <Power>, <M> or <PW> to switch between the modes.

- Exit TDI
 - Click [TDI] or press the user-defined key to exit TDI mode and enter general imaging modes.
 - Or, press on the control panel to return to B mode.

As in TDI mode, [TDI] item in the soft menu is the pathway for entering and exiting TDI mode, you can preset its performance through the path "[Setup] → [Image Preset] → [Menu Preset]".

5.9.2 TDI Image Parameters

- In TDI mode scanning, the image parameter area in the upper left corner of the screen will display the real-time parameter values as follows:
 - TVI

```
TVI
F3.3 /G38
IP1 /WF3
PRF0.4k
```

Display	F 3.3	G 38	IP1	PRF 0.4k	WF 3
Parameter	Frequency	Gain	TVI IP	PRF	WF (Wall Filter)

- TEI

```
TEI
F3.3 /G38
IP1 /WF3
PRF0.4k
```

Display	F 3.3	G 38	IP1	PRF 0.4K	WF 3
Parameter	Frequency	Gain	TEI IP	PRF	WF (Wall Filter)

- TVD

```
TVD
F3.2 /G30
PRF5.3k
WF 296
SVD30.0
SV 0.5
```

Display	F 3.2	G 30	PRF 5.3k	WF 296	SVD 30.0	SV 0.5
Parameter	Frequency	Gain	PRF	WF (Wall Filter)	SV Position	SV Size

- TVM

Image parameters combine the parameters of TVI mode and M mode.

5.9.3 TDI Image Optimization

Parameters that can be adjusted to optimize the TDI mode image are indicated in the following.

TDI	Operation	Items
TVI	Control Panel	Gain, Depth
	Menu and Soft Menu	Baseline, TVI IP, Acoustic Power, Line Density, B Display, Smooth, Persistence, Focus Position, Packet Size, B/C Wide, Dual Live, Map, Priority, WF, Frequency, Scale, Invert, Tissue State, Line Density
TEI	Control Panel	Gain, Depth
	Menu and Soft Menu	Dual Live, TEI IP, Focus Position, Frequency, Scale, Tissue State, Invert, WF, Persistence, Smooth, Dynamic Range, B/C Wide, Map, Packet Size, B Display, Priority, Line Density, Acoustic Power
TVD	Control Panel	Gain, Depth
	Menu and Soft Menu	Invert, SV, WF, Frequency, Duplex/Triplex, V Max, V Mean, Dynamic Range, Audio, Trace Area, Colorize Map, Speed, Acoustic Power, Trace Sensitivity, T/F Res, Gray Map, Scale, Baseline, Colorize, Quick Angle, Angle, Trace Smooth, Time Mark, Curve, Rejection, γ , Display Format, Auto Calculation, Auto Calculation Parameter, Auto Calculation Cycle

- In TVM mode, adjustable parameters are the same as those in B, M, and TVI modes; please refer to the relevant contents for details.
- Items that appear in the menu or the soft menus are dependent upon preset, which can be changed or set through "[Setup] → [Image Preset]"; please refer to "5.15 Image Preset" for details.

In each TDI mode, parameters that can be adjusted are similar to those in the color flow modes (Color, PW, and Power); please refer to relevant chapters for details. The following is to introduce the specific items in TDI mode.

Tissue State

Description This function is used for a fast image optimization by providing an adjustment on 2 parameters, including scale and filter.

Operation Adjust through the [Tissue State] item in the soft menu or menu.
There are 3 levels provided to adjust: L, M, H.

5.9.4 TDI Quantitative Analysis (QA)

	<p>CAUTION: TDI Quantitative Analysis results are provided for reference only, not for confirming a diagnosis. Please compare the results with that of other machines, or make diagnosis using none-ultrasound methods.</p>
---	--

TDI QA is applied for TVI original data analysis, for evaluating the velocity change of the same cardiac muscle with cardiac cycles.

Workflow of TDI QA:

1. Perform image scanning on cardiac muscle, freeze the image and select a range of images for analysis; or select a desired cine loop from the stored images.

Tips:

- Images from the current scan session (already in freeze mode) or from a saved image loop can be used for TDI QA.
 - TDI QA is only available for cine files. If the user has selected a single-frame image, TDI QA function cannot be activated.
2. Click [TDI QA] on the TVI soft menu to activate TDI QA function.
 3. Mark out the interesting part.
 4. Save the curved image, export the data and do parameter analysis.
 5. Exit TDI QA function.
 - Press <Freeze> key on the control panel.

5.9.4.1 TDI QA Screen Description

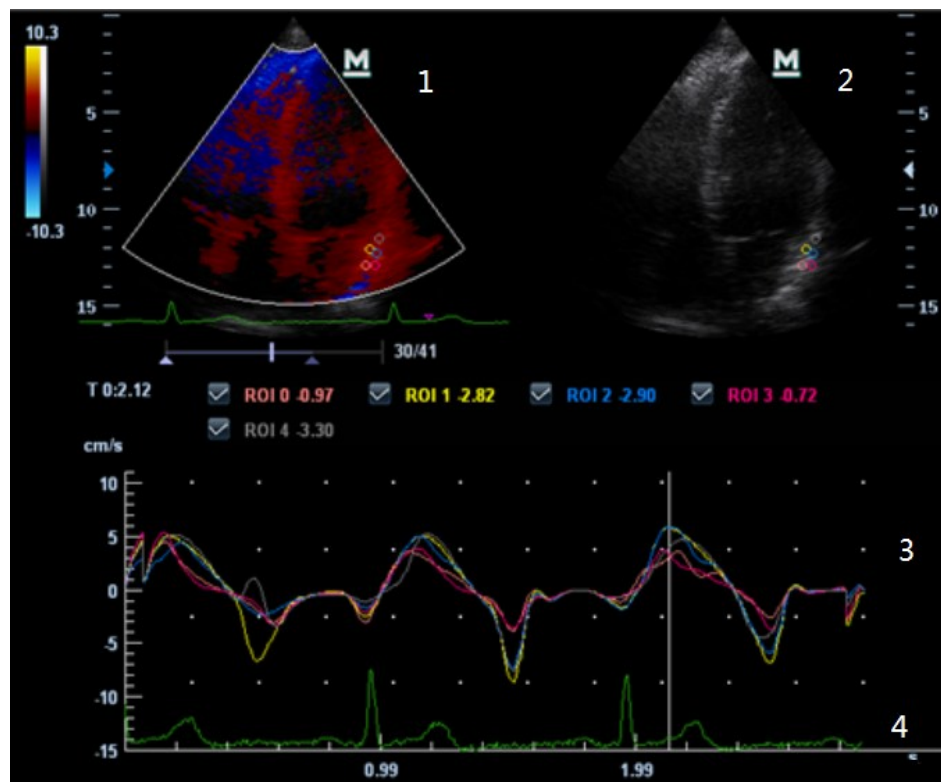

1---TVI Cineloop window

Sample area: indicates sampling position of the analysis curve. The sample area is color-coded, 8 (maximum) sample areas can be indicated.

2---B Cineloop window

Tips:

- Images in the TVI cineloop window and B cineloop window are the frozen image of the same moment; roll the trackball to review the images in the two cineloop windows.
- Sample areas are linked in the TVI cineloop window and B cineloop window.

3---Displays analysis curve

- Y axis represents the velocity (unit: cm/s), while X axis represents the time (unit: s).
- Frame marker: a line that perpendicular to the X axis, can be moved horizontally left to right (right to left) by rolling the trackball.
- Click the check box beside the ROI to set if to hide or to display the TIC curve.

4---Displays ECG trace.

5.9.4.2 Basic Operations of TDI QA

Selecting TIC Analysis Image Range

A range of frames is selected for the TDI quantitative analysis in Cine mode (before accessing TDI QA). Only the frames in this range are used for the TDI quantitative analysis. If a range is not selected prior to accessing the TDI QA, the system uses the default cine start and end frames as the default TDI QA start and stop frames.

- Move the cursor onto the desired start of the cineloop; click [Set First Frame] to set the start point.
- Move the cursor onto the desired end of the cineloop; click [Set End Frame] to set the end point.

Setting ROI

Up to eight ROIs can be saved on the reference image, with the corresponding eight traces plotted simultaneously on the graph. Each ROI display has a different color, and its corresponding trace data is plotted using that same color.

There are two different methods for determining the shapes of the sample area: Standard ROI and Freehand ROI.

■ Standard ROI

1. Click [Standard ROI] on the soft menu.
2. When the trackball positions the image display cursor over the reference image(s), an elliptical ROI is automatically generated and displays on the reference image(s).
The average intensity value inside the ellipse is calculated for every image in the image analysis range and plotted in the image display area.
3. The last generated or selected ellipse is considered the active ROI, and its trace plot automatically updates as the user repositions it on the reference image. Old traces are erased.
4. When scanning with an elliptical ROI, press <Set> to fix the ROI position and freeze its corresponding trace on the plot. A new active ROI is generated whose position is manipulated by the trackball and whose analysis curve traces will be plotted as before, while the previous ROI and trace remain fixed at the points where they were saved at.

■ Freehand ROI

1. Click [Freehand ROI] on the soft menu, when the cursor is evolved in the image review area (TVI image review window or 2D image review window), it displays as a color-coded ellipse.
2. Review the image to a desired frame.
3. Use the trackball to position the caliper on the reference image at the start point. Press <Set> to fix the start point.
4. Trace the outline of the desired ROI by moving the cursor with the trackball.
5. Press and hold <Set> key, and roll the trackball to depict the ROI. When a suitable ROI has been drawn, confirm the ROI by double clicking <Set> key, press <Clear> key to cancel the last point. The system will update the graphics and the data as well.

The system automatically links the start point to the end point by drawing a straight line between them. The caliper is then free for repositioning for another freehand ROI.

You cannot go outside the image boundary when drawing a freehand ROI.

■ Delete ROI

Press <Clear> key to clear out the last ROI; click [Delete All] on the soft menu to clear out all ROIs.

The corresponding traces for the deleted ROIs are erased from the plot.

Deleting an ROI causes the ROIs to be deleted from all frames in the analysis loop.

■ Standard Height/Standard Width/Standard Angle

Click soft menu selections [Std. Height], [Std. Width], [Std. Angle] to adjust the height, the width and the tilt angle of the standard ROI for the undergoing or afterward ROIs.

Tips:

- Once eight ROIs have been saved, the system does not automatically generate an active ROI when the cursor is positioned over the displayed reference image.
- The saved ROIs can be a mixture of elliptical and freehand ROIs.
- Elliptical ROIs can be positioned in any manner that keeps their center within the image boundaries. In the case that part of the ROI is outside the image boundary, only data from within the image boundary is used for calculating the mean intensity value.
- When the user repositions an ROI, the old trace data is erased from the plot and the trace data for the new position re-plotted.

Hide/Show

Click [Hide] or [Show] on the soft menu to hide or display the analysis curve area.

Export/Save Trace Data

1. Click [Export] on the soft menu.
2. Select the drive and enter the file name in the displayed window.
3. Select [OK] to save the data and return to the TIC Analysis screen.
 - All displayed ROI traces are saved in the exported file.
 - The parameters are included in the trace file if the user has fixed a ROI.
 - After the exporting is succeeded, a .BMP format image is displayed in the thumbnail area at the lower part of the screen.
 - Only data from the user selected image range is included in the exported trace file.

5.10 Color M Mode

Color M mode provides information of color flow or tissue movement on the M mode images to indicate cardiac motion state. It is highly sensitive to the flow or tissue movement.

The Color M mode includes Color Flow M mode and Color Tissue M mode (also known as TVM).

5.10.1 Enter Color M Mode

- Color Flow M mode
 - In B+M Mode, press <Color>.
 - In B+Color, B+ Color+ Pw or B+ Color+ CW mode, press <M>.
- Color Tissue M mode(TVM)
 - In Color Flow M mode, click [TDI]
 - In B+TVI/TVD, or B+TVI+TVD mode, press <M>.
 - In Color Flow M mode, click [TDI] in the soft menu or press the user-defined TDI key.

5.10.2 Exit Color M Mode

- Press <Color> or <M> on the control panel to exit Color M mode.
- Or, press on the control panel to return to B mode.

5.10.3 Image Parameters

- In Color Flow M mode, parameters that can be adjusted are in accordance with those in B, M and Color modes; please refer to relevant sections of B, Color and M mode for details.
- In Color Tissue M mode, parameters that can be adjusted are in accordance with those in B, M and TVI modes; please refer to relevant sections of B, Color and TVI modes for details.
- In Color M mode scanning, the image parameter area in the upper left part of the screen will display the real-time parameter values as follows:

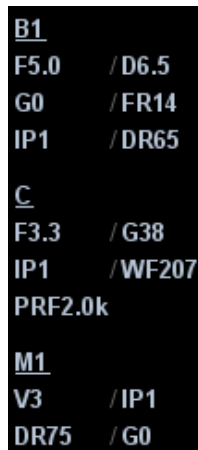

```
B1
F5.0 / D6.5
G0 / FR14
IP1 / DR65

C
F3.3 / G38
IP1 / WF207
PRF2.0k

M1
V3 / IP1
DR75 / G0
```

- ROI Adjustment

The ROI size and position determine the size and position of the color flow or color tissue displayed in the Color M mode image.

- Set the position of the sampling line by moving the trackball left and right, and set the ROI position by moving the trackball up and down.
- Set the ROI size by moving the trackball up and right.
- Press <Set> to switch between the cursor status between the ROI position adjustment and ROI size adjustment.

- Press <Update> on the control panel to switch between the real-time mode and freeze mode.

Tips: In Color M mode, ECG function is supported.

5.11 3D/4D

Tips:

- You can select 4D optional module. 4D module includes 4D and Static 3D functions. You can also select Smart3D optional module only.
- If Smart3D optional module is selected, to enter the Smart3D imaging, you should select [Smart3D] instead of [3D/4D] as described in this Operator's Manual.

NOTE: 3D/4D imaging is largely environment-dependent, so the images obtained are provided for reference only, not for confirming a diagnosis. Please compare the images with that of other machines, or make diagnosis using none-ultrasound methods.

5.11.1 Note before Use

5.11.1.1 3D/4D Image Quality Conditions

NOTE: In accordance with the ALARA (As Low As Reasonably Achievable) principle, please try to shorten the sweeping time after a good 3D imaging is obtained.

The quality of images rendered in the 3D/4D imaging is closely related to the fetal condition, angle of a B tangent plane and scanning technique (Smart3D). The following description uses the fetal face imaging as an example, the other parts imaging are as the same.

■ Fetal Condition

- Gestational age
Fetuses of 24~30 weeks old are the most appropriate for 3D imaging.
- Fetal Body Posture
Recommended: Cephalic face up (figure a) or face aside (figure b).
NOT recommended: Cephalic face down (figure c).

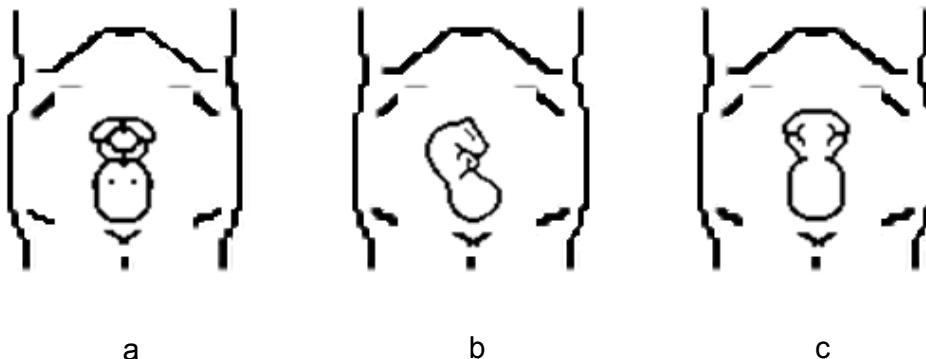

- Amniotic fluid(AF) isolation
The region desired is isolated by amniotic fluid adequately.
The region to imaging is not covered by limbs or umbilical cord.

- The best condition is that the fetus keeps still. If there is a fetal movement in Smart 3D or Static 3D imaging, you need a rescanning when the fetus is still.
- Angle of a B tangent plane

The optimum tangent plane to the fetal face 3D/4D imaging is the sagittal section of the face, or the coronal section. To ensure high image quality, you'd better scan maximum face area and keep edge continuity.
- Image quality in B mode (2D image quality)

Before entering 3D/4D capture, optimize the B mode image to assure:

 - High contrast between the desired region and the AF surrounded.
 - Clear boundary of the desired region.
 - Low noise of the AF area.
- Scanning technique (only for Smart3D)
 - Stability: body, arm and wrist must move smoothly, otherwise the restructured 3D image distorts.
 - Slowness: move or rotate the probe slowly.
 - Evenness: move or rotate the probe at a steady speed or rate.

NOTE:

1. A region with qualified image in B mode may not be optimal for 3D/4D imaging.
E.g. adequate AF isolation for one sectional plane doesn't mean the whole desired region is isolated by AF.
2. More practices are needed for a high success rate of qualified 3D/4D imaging.
3. Even with good fetal condition, to acquire an approving 3D/4D image may need more than one scanning.

5.11.2 Overview

Ultrasound data based on three-dimensional imaging methods can be used to image any structure where a view can't be achieved by standard 2D-mode to improve understanding of complex structures.

4D provides continuous, high volume acquisition of 3D images. 4D adds the dimension of "movement" to a 3D image by providing continuous, real-time displays.

- Mode definition
 - Smart 3D

The operator manually moves the probe to change its position/angle when performing the scanning. After the scanning, the system carries out image rendering automatically, and then displays a frame of 3D image.
 - Static 3D

Posit the probe at a fixed place; the probe automatically performs the scanning. After the scanning is completed, the system carries out image rendering, and then displays a frame of 3D image.
 - 4D

The probe performs the scanning automatically. During the scanning, the system renders 3D images in real time, and all 3D images are displayed in real time.

- Terms
 - Volume: a three-dimensional content.
 - Volume data: the image data set of a 3D object rendered from 2D image sequence.

- 3D image: the image displayed to represent the volume data.
- View point: a position for viewing volume data/3D image.
- Section image: tangent planes of the 3D image obtained by algorithm. As shown in the figure below, XY-paralleled plane is C-section, XZ-paralleled plane is B-section, and YZ-paralleled plane is A-section. The probe is moved along the X-axis.
- ROI (Region of Interest): a volume box used to determine the height and width of scanning volume.
- VOI (Volume of Interest): a volume box used to determine the area of a sectional plane for 3D imaging.

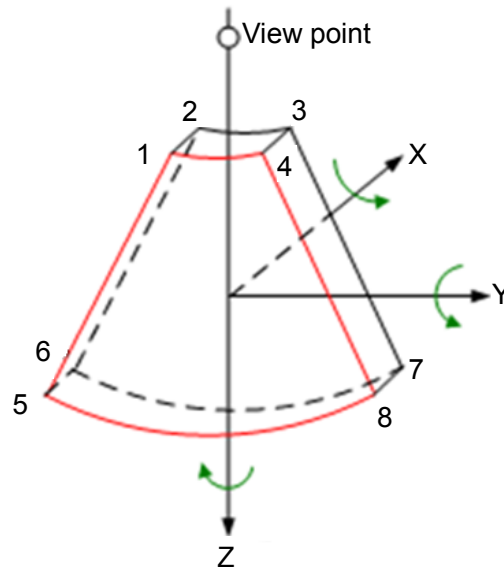

■ ROI and VOI

Before image acquisition after the system enters 3D/4D imaging, a B image with ROI displays on the screen. A line (shown in the following figure) that shows the upper edge position of VOI is inside ROI.

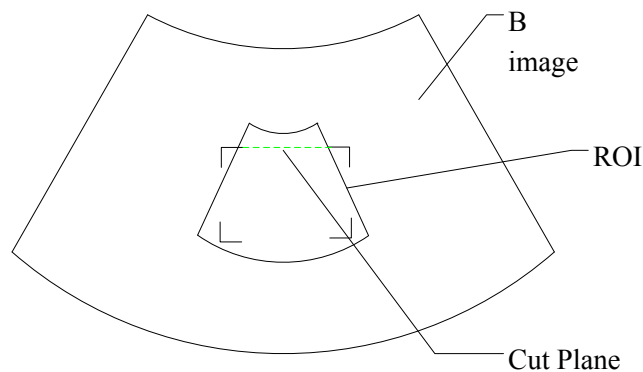

- ROI size and position
Roll the trackball to change the ROI size and position, press the <Set> key to toggle between setting the size (dotted line) and position (solid line).
- Curved VOI adjustment

Roll the trackball to change the curve VOI position, press <Set> key to switch among the state of changing ROI and curve VOI.

This function is to change the curved shape of the nearest VOI section, to facilitate observation for the interested volume data.

It can be adjusted both in acquisition preparation status, and in A, B, C sections of review/ 4D imaging status, and a triangle of control point on the curved VOI is displayed.

Depending on the view direction, the orientation and the shape (line or dot) of curved VOI vary:

View	Curved VOI
U/D	At the upper part of curved VOI
D/U	At the lower part of curved VOI
L/R	At the left part of curved VOI
R/L	At the right part of curved VOI
F/B	Displays as a dot
B/F	Displays as a dot

NOTE: To define a ROI, please try to cut the useless data as to reduce the volume data, shortening the time for image storing, processing and rendering.

■ 3D view direction definition

You can adjust the view direction of the ROI.

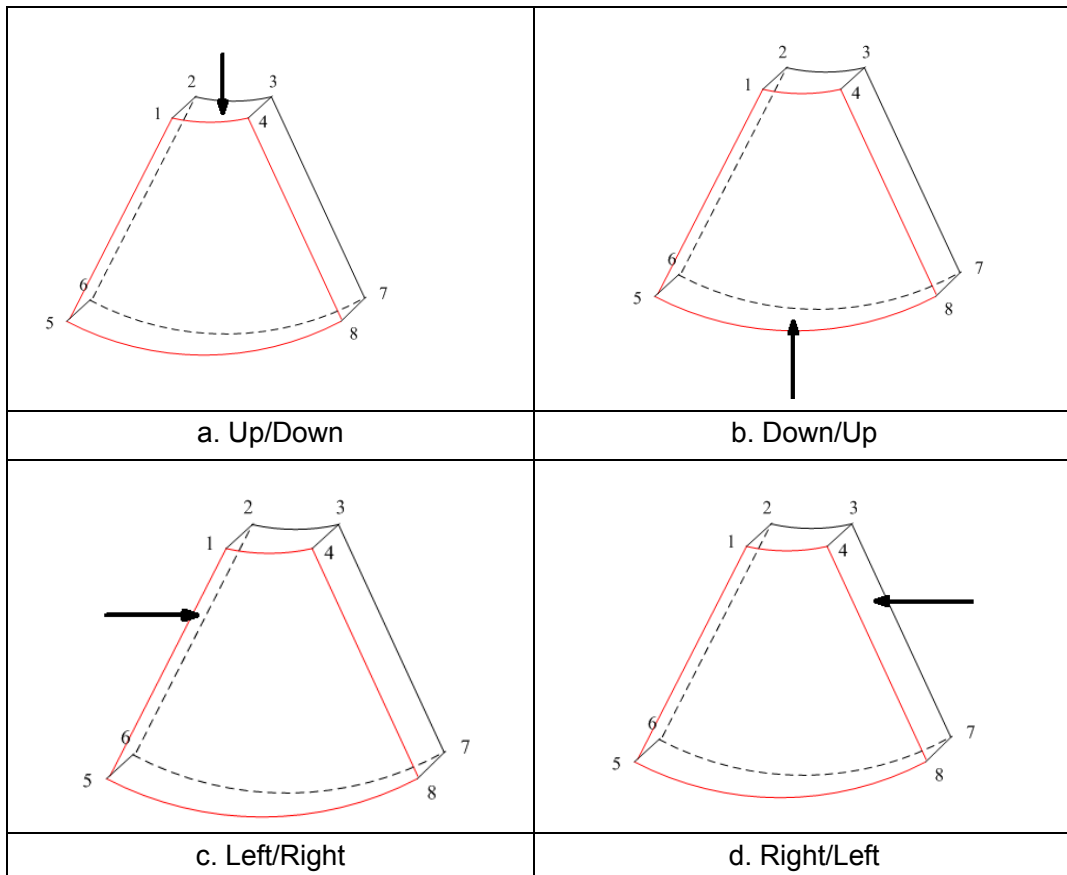

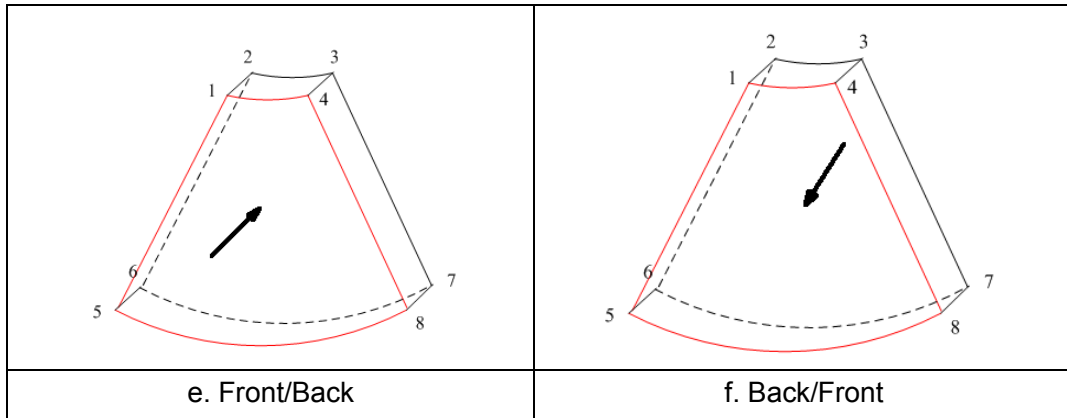

Tips: Changing the view direction only changes the 3D/4D image; images of the 3 sections do not change.

■ Probe

A 2D imaging probe can be applied for Smart 3D imaging, however, to realize static 3D imaging or 4D imaging, a volume probe should be selected.

■ Sectional plane

The principle of 3D imaging is to render a 3D image from multiple 2D image information. The following describes the spatial relation of 3 sectional planes (A, B and C) and the 3D image.

The sectional plane can be viewed in the following status:

- 3D image viewing status of Smart3D
- 3D image viewing status of Static 3D
- Real time 4D or frozen 4D status

In the quad display format view, the screen displays A, B, C 3 sectional planes and the 3D image.

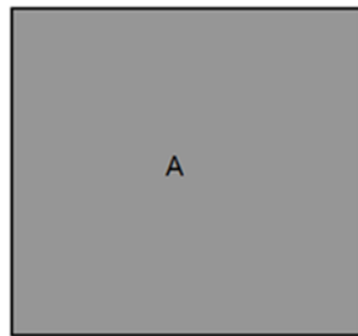

A sectional plane window



B sectional plane window



C sectional plane window

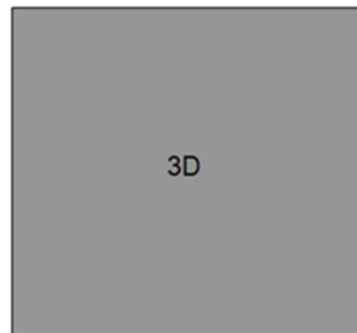

3D image window



The current window's icon is highlighted, e.g., the icon  shows that A window is the current window.

A, B, C section images are illustrated as the following sections of 3D image.

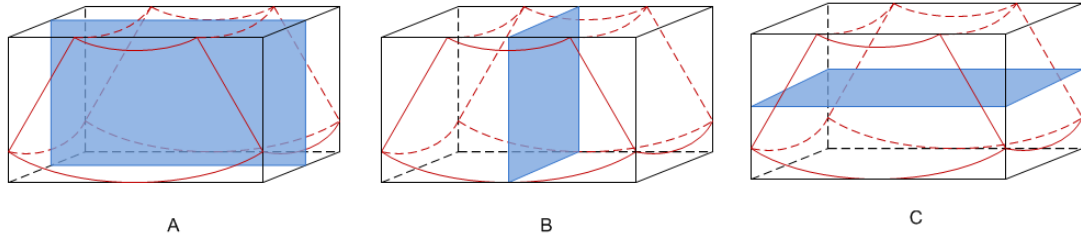

- Section A: corresponds to the 2D image in B mode. Section A is the sagittal section in fetal face up posture, as shown in the figure A above.
- Section B: it is the horizontal section in fetal face up posture, as shown in the figure B above.
- Section C: it is the coronal section in fetal face up posture, as shown in the figure C above.

Tips: the upper part of the 3D image in the D window is corresponding to the orientation mark on the probe, if the fetal posture is head down (orientating the mother's feet), and the orientation mark is orientating the mother's head, then the fetus posture is head down in the 3D image, you can make the fetus head up by rotating the 3D image by clicking [Quick Rot.] to be "180°" in the soft menu.

■ Wire cage

When you view a 3D/4D image on the display monitor, it's sometimes difficult to recognize the orientation. To help, the system displays a three-dimensional drawing to illustrate the orientation. Of which, the blue plane presents the image acquisition where started, while the red plane presents the image acquisition where ended, besides, a yellow plane in the wire cage presents the position of the sectional plane. See the graphic below:

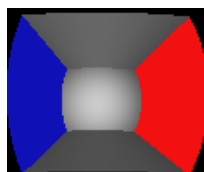

Wire Cage

⚠ CAUTION: The ultrasound images are provided for reference only, not for confirming a diagnosis. Please use caution to avoid misdiagnosis.

5.11.3 3D/4D Preset

5.11.3.1 Shortcut Key Preset

The system supports setting shortcut key to enter 3D/4D imaging. Assign a key as user-defined 3D/4D key, the setting path is "[Setup] → [System Preset] → [Key Config]". Refer to "15.1.7 Key Config" for details.

5.11.3.2 Menu Preset

Open the Menu Preset screen via “[Setup] → [Image Preset] → [Menu Preset]”.

1. Select the probe type and imaging mode (Smart3D, Static 3D or 4D).
2. Set the soft menu items for Smart3D, Static 3D or 4D imaging respectively, refer to “5.15.2 Soft Menu and Menu Preset” for details.

5.11.3.3 Parameter Preset

Open the 3D/4D Image Preset interface via “[Setup] → [Image Preset] → 3D/4D”.

The main preset page is shown as follows:

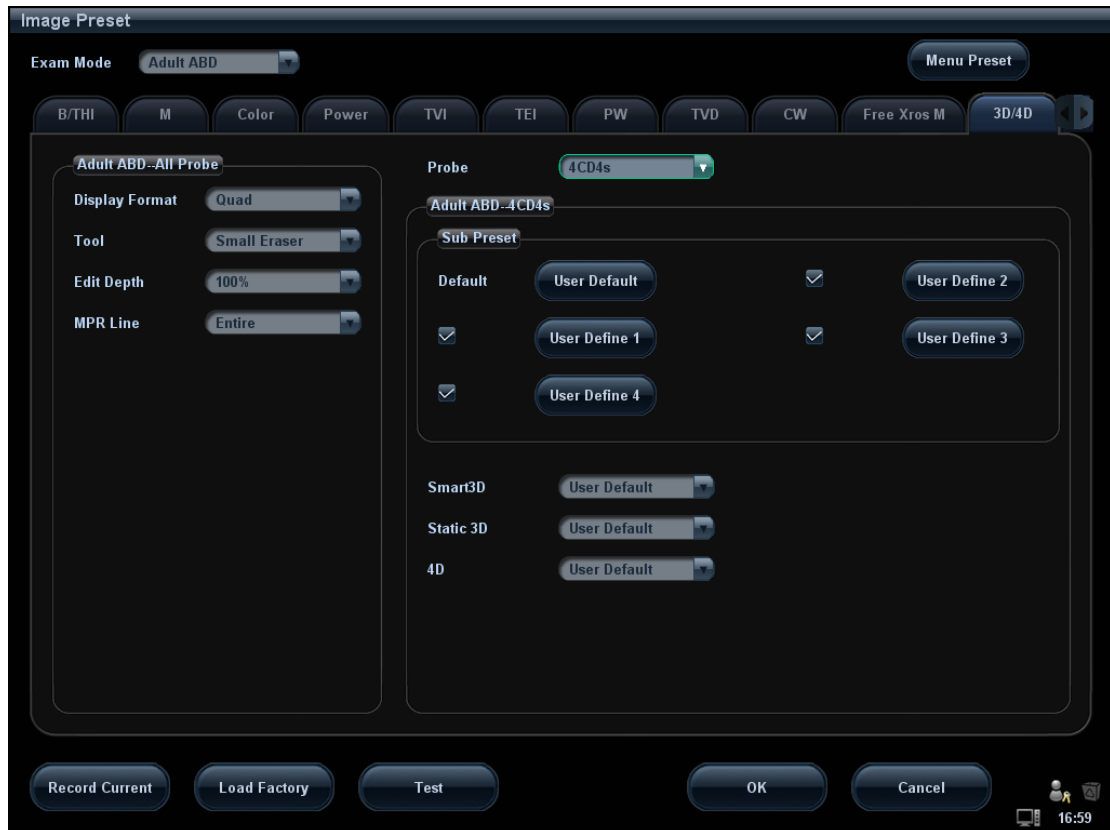

Select the Probe

Select a probe model in the drop-down list .

General Parameters Preset

- Display Format: to set the image display format in 3D image viewing status.
- Tool: to set the edit type in image edit mode.
- Edit Depth: to set the edit depth in image edit mode.
- MPR Line: to set the display manner of MPR Line in image rendering mode.

Parameter Package Preset

There are five presettable parameter packages for each mode. They are independent from each other.

Click the button of one package to enter the Sub Preset interface, see the following figure.



1. Name: move the cursor to the Name column and enter the preset package name.
2. General parameters preset:
 - Render: select image rendering mode.
 - Direction: select 3D view direction.
 - Quick Rot.: set the angle for quick rotation.
 - ROI Height: set ROI height.
 - ROI Width: set ROI width.
 - ROI Center Depth: set ROI center depth.
3. Sub modes parameters preset
 - Set mode-specified parameters for Smart3D, Static 3D or 4D separately.
4. Parameters of rendering modes
 - There are two types of rendering modes: grayscale rendering and inversion, both includes four types: Surface, Max, Min, X Ray. Click a rendering mode tab to preset its rendering parameters.

Select Default Preset Package for Sub-modes

After setting preset packages, you can select the default preset package for sub modes. See the figure below:

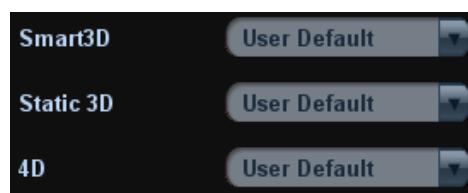

5.11.4 Smart 3D

5.11.4.1 Basic Procedures for Smart 3D Imaging

NOTE: In Smart 3D image scanning, if the probe orientation mark is oriented to the operator's finger, please perform the scanning from right to left in linear scan; or rotate the probe from left to right in fan scanning; otherwise, the 3D image direction is wrong.

To perform Smart 3D imaging:

1. Select the proper probe and connect it to the ultrasound system. Make sure there is sufficient gel on the probe for scanning.
2. Select the scanning probe and exam mode, and do parameter setting if necessary.
3. Obtain a 2D image. Optimize the image as usual.
4. Enter 3D/4D imaging preparation status:
 - Press the user-defined key on the control panel; or,
 - Move the cursor onto the image menu, navigate the cursor to [Other] item and press <Set>. Select [3D/4D] in the "Other" menu to enter the 3D/4D imaging mode.

5. Switch to Smart 3D imaging by clicking [Smart 3D] on the soft menu, and define the ROI as well as curve VOI.

6. Select a parameter package, set parameters like [Direction], [Method] (including the range or angle to be scanned), [Display Format] in the soft menu according to your preference.

7. Click [Start]; or, press <Update> on the control panel to begin the 3D image acquisition. For details, please refer to "5.11.4.3 Smart 3D Image Acquisition".

The system enters into 3D image viewing status when the acquisition is completed; or, you can finish the acquisition ahead by clicking [Stop] in the soft menu (or press <Freeze> or <Update> on the control panel).

In image viewing status, you can perform operations like VOI setting, image editing, for details, please refer to "5.11.4.4 Smart 3D Image Viewing".

8. Return to image acquisition preparation:

Press <ESC>, <Update> or <Freeze> to return to image acquisition and perform imaging again if necessary.

9. Exit 3D/4D.

Press button, 3D/4D shortcut key, or press <ESC> twice to exit Smart 3D imaging.

5.11.4.2 Smart 3D Acquisition Preparation

Select a parameter package, set parameters like [Method] (including the scanning range and angle), [Direction], and [Disp Format].

■ Method

You can capture images by Linear scan or Fan scan.

- Linear scanning
Move the probe across the surface. See the following figure.

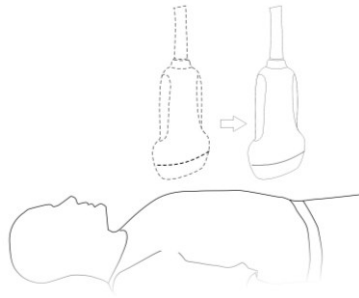

- Fan scanning
Rotate the probe once from the left to the right side (or from the right to the left) to involve the whole region desired. See the following figure.

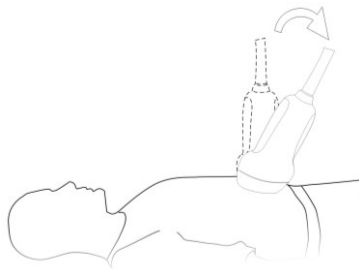

■ Parameters description:

Type	Parameter	Description
Acquisition	Start	To begin image acquisition.
	Stop	To stop image acquisition.
Parameter adjusting	Direction	Function: to set the fast view direction in viewing mode or in real-time displaying mode. Selection: Up/Down, Down/ UP, Left/Right, Right/Left, Front/Back, Back/Front. The commonly viewed direction is Up/Down.
	Display Format	Function: to set the image display format in real-time displaying mode (only for 4D imaging) or viewing mode. Selection: Single, Dual, Quad
	Method	Function: select the image acquisition method. Selection: Fan, Linear. Linear mode: during the sweep, the probe may not be moved parallel, the speed at which you scan should be constant. Fan mode: in this mode, the probe must be moved to a position where you can clearly see a middle cut of the object you want to scan and render. Tilt the probe to about 30 degrees until the object you want to scan disappears. Start the acquisition and tilt the probe over a distance of around 60 degrees until the object disappears again. During the sweep, the probe may not be moved parallel, just tilted.

Type	Parameter	Description
	Distance	Function: to set the distance the probe covered from one end to the other end during a linear sweep. Range: 10-200mm, in increments of 10mm.
	Angle	Function: to set the angle the probe covered during a fan sweep. Range: 10-80°, in increments of 2°.
	Reserve Curve	To reserve the VOI edge line to be plane.
Parameter package	/	Provides 5 parameter packages. The package name as well as all the parameters can be preset. Parameter packages of each mode are independent (vary with the imaging mode).

5.11.4.3 Smart 3D Image Acquisition

The following takes the fetal face 3D imaging as an example.

1. Optimize the 2D image of the desired region.

Make sure:

- High contrast between the desired region and the AF (amniotic fluid) surrounded.
- Clear boundary of the desired region.
- Low noise of the AF area.

2. Set ROI (Region of Interest) on the 2D image.

3. Roll the trackball to change the ROI size and position and VOI curve, press the <Set> key to toggle between setting the ROI size or position.

To set the ROI /VOI, make sure:

- Set ROI on the 2D image with the largest section area of the fetal face.
- Set ROI a little larger than the fetal head.

Take scanning the fetal face sagittally as an example, the largest ROI is set on the 2D image acquired from the sagittally section across the center of the face (with the largest face section area), as shown in Figure a below. If not, a smaller face section appears and results in a smaller ROI, as shown in Figure b below. (The left figure below takes a 3D rendered fetal face to indicate the fetal under exam.)

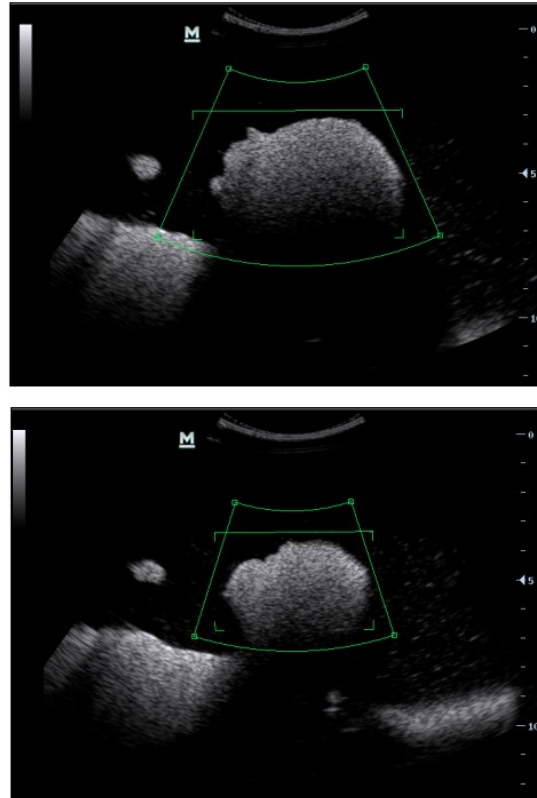
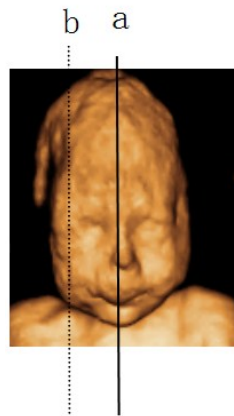

A small ROI results in an incomplete 3D image, which can be corrected by resetting ROI after acquisition. For details, please refer to “Reset ROI”.

4. Click [Start] to begin the acquisition.
5. Perform the acquisition according to the scanning technique stated above. (Take fan scanning as an example).
6. Viewing and adjusting 3D image.

In image viewing status, you may have to adjust the VOI and image parameters to optimize the 3D image, refer to “5.11.4.4 Smart 3D Image Viewing” for details.

5.11.4.4 Smart 3D Image Viewing

- The system enters the Image Viewing status once image acquisition is finished:
 - Clicking [Stop] in the soft menu; or,
 - Pressing <Update> or <Freeze> on the control panel; or,
 - Wait until the 3D acquisition automatically completed.
- In 3D image viewing, the system supports the following functions:
 - View the section image.
 - Rotate 3D image.
 - Image zooming.
 - Auto rotation.
 - VOI adjustment.
 - Image edit.
 - 3D image parameters adjustment.
 - B mode image parameter adjustment.
 - Reset ROI.

- Display format setting.
- Image reset.

Entering/Exiting Image Viewing

■ Exit

To return to 3D/4D image acquisition preparation status, you can,

- Click [Return] in the soft menu,
- Press <Freeze>, <Update> or <Esc>.

B Mode Parameters Adjustment

Use the left/ right keys of soft menu controls <4> to switch to the B menu, and adjust the image effect by B image parameters.

Image Rendering Parameters

In image viewing status, you can render the image by adjusting the parameters.

Render setting parameters description:

Parameter		Description
Render Gray/Inversion	Surface	Function: set Surface as 3D image rendering mode. This is helpful for surface imaging, such as fetus face/hand or foot. Tips: you may have to adjust the threshold to obtain a clear body boundary.
	Max	Function: set Max as 3D image rendering mode, displays the maximum intensity of gray values in the ROI. This is helpful for viewing bony structures.
	Min	Function: set Min as 3D image rendering mode, displays the minimum number of gray values in the ROI. This is helpful for viewing vessels and hollow structures.
	X-ray	Function: set X-ray as 3D image rendering mode. Displays the average value of all gray values in the ROI. X Ray: used for imaging tissues with different structure inside or tissues with tumor.
<p>The above four rendering manners can be applied to both gray and inversion modes.</p> <p>Where, inversion is to inverse the grayscale of the image, so as to enhance observation for low-echo region, applicable for vessel, cyst and etc.</p> <p>When the function is turned on, the rendering mode parameters change into the corresponding inverse parameters.</p>		

Parameter	Description
Threshold	Function: to set the threshold for 3D image rendering. 3D image is rendered using the signal between the high and low thresholds. Range: 0%-100%, in increments of 1%. Only used in surface imaging.
Transparency	Function: to set the transparency value for 3D image rendering. Range: 0%-100%, in increments of 5%. The higher the number, the more transparent the gray scale information. Only used in surface imaging.
Smooth	Function: to set the smoothness of 3D image. Selection: 0-20. 0 refers to no smooth effect, 0-20 present 21 effects in incremental order. Tips: insufficient smoothness can result in a fuzzy image; however, over smoothness will lead to image distortion.
Brightness	Function: to set the brightness of 3D image. Range: 0%-100%, in increments of 2%. 0% presents the minimum brightness, while 100% the maximum.
Contrast	Function: to set the contrast of 3D image. Range: 0%-100%, in increments of 2%.
MPR Line	Function: using the lines to show the position information of the other sections on a section image or 3D image. Selection: Entire, Partial, Off. Entire means to display the whole line crossing the section image. Partial means to display part of the line at both ends of the MPR line.
Colorize/Colorize Map	Switch on/off colorize map, selection: Off, 1-5.
Quick Rot.	To quick rotation the 3D image. Selection: 0°, 90°, 180°, 270°.
Reset Ori	To reset the volume rotation, shifting and zooming to original status.
Reset All	To reset volume to original orientation and original parameters.

Display Format

Image display format: click [Display Format] in the soft menu to set the image display format, each adjustment cycles you to the next setting. Here,

- Select [Single], the system displays one image, which can be a section image or a 3D image.
- Select [Dual], system displays two images left and right. (The left one can be section A, section B or section C image, and the right one is 3D image.)
Or directly press <Dual> on the control panel.
- Select [Quad], system displays four images. (The upper left one is section A image, the lower left one is sectional C image, the upper right one is section B image, and the lower right one is 3D image.)
Or directly press <Quad> on the control panel.

Adjust VOI

■ Function

Adjusting the VOI box size and position is to select the volume data needed to re-render the 3D image and improve the re-render effect.

■ Procedures

- (1) In image viewing mode, click [Accept VOI] to be "Off".
 - (2) Select a desired sectional plane by clicking [Current Window X]. Then VOI on section A, B and C are adjustable.
 - (3) Roll the trackball to change the ROI size and position as well as VOI curve, press the <Set> key to toggle among setting the ROI size, position and VOI curve, or, rotate the multifunctional knob to change the position of VOI.
- Click [Accept VOI] to be "On" to exit VOI adjusting. In Accept VOI, a green dotted-line is displayed presenting the position of the section plane, using the trackball to move the reference point on the MPR to slicing, and the point is the rotation center. Roll the trackball to view a section image; you can see the corresponding MPR lines are moving.

Figure a and Figure b below show the 3D image before and after VOI adjusting. VOI adjusting helps to re-render a better 3D image.

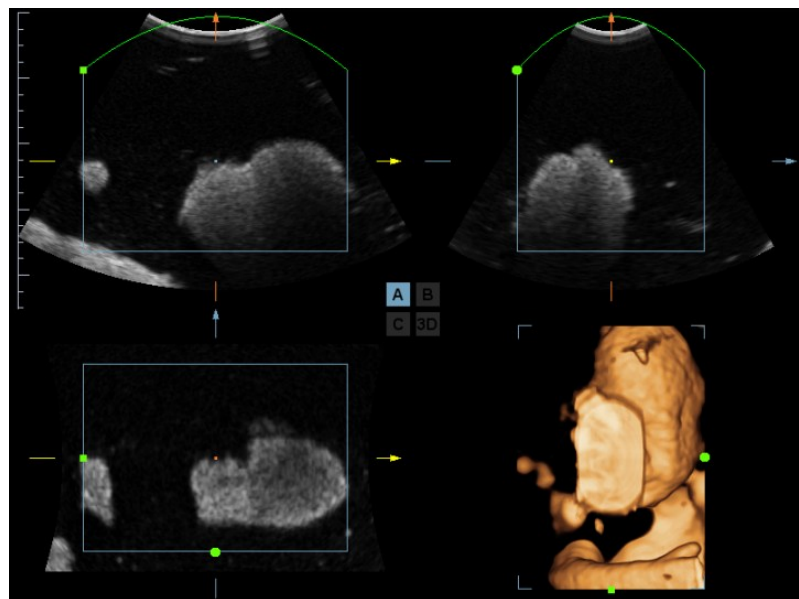

a

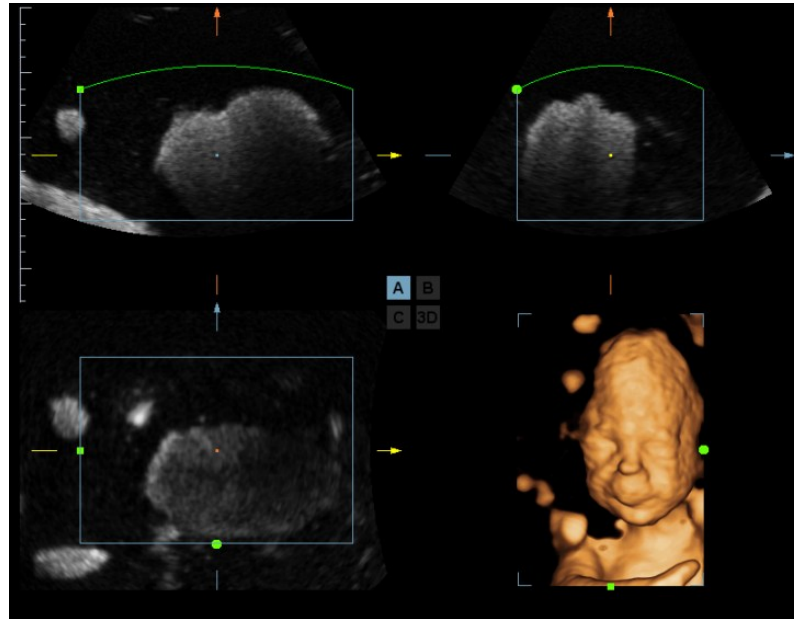

b

When 3D image or the MPR the direction of which is the same as 3D image is active, a control point is displayed on the 3D image, roll the trackball to move the control point.

Section Image Viewing

The principle of 3D imaging is to render a 3D image from multiple 2D image information. You can move the MPR line to view the different position of the section image.

■ Sectional plane position

In the quad display format view, there are 3 sectional planes (A, B and C) and the 3D image.

To understand the sectional plane, please refer to “5.11.2 Overview”.

■ Procedures

- (1) Set a section (A, B or C) as the current window.
- (2) Click [Adjusting VOI] to be “Off” to enter the sectional plane viewing.
- (3) Roll the trackball to view the sectional plane.

Positions of the other two sectional planes are indicated in the selected plane. You can roll the trackball to change the position. As shown in the figure below.

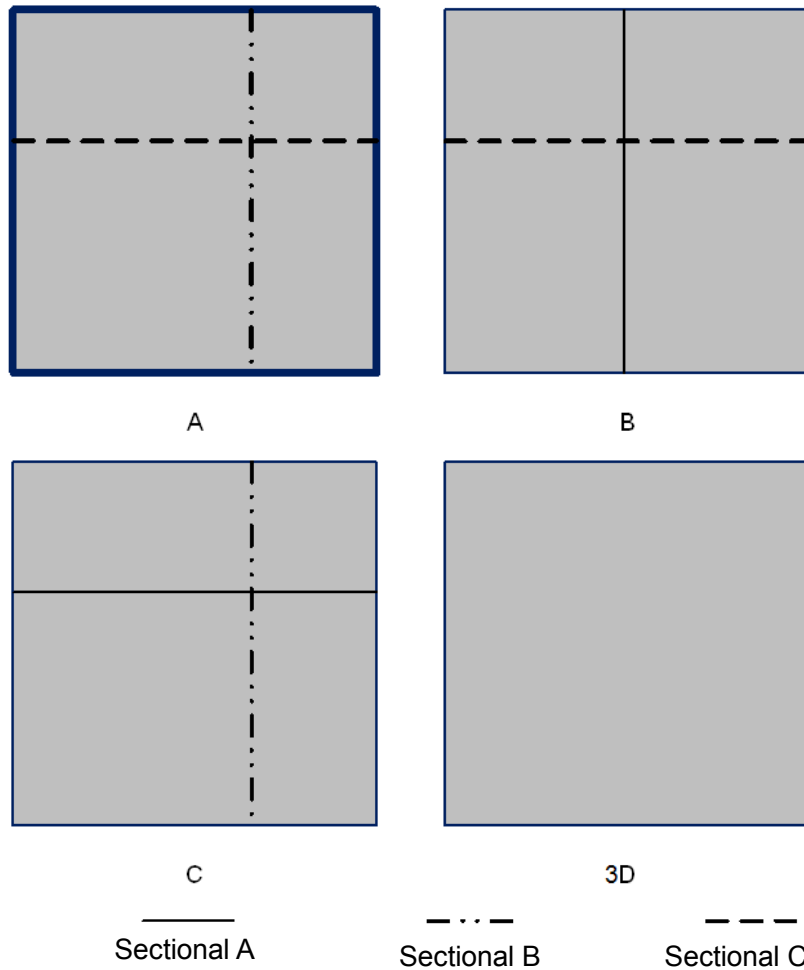

E.g. select A as the current window and roll the trackball, MPR lines (indicating the position of section A) in the B and C windows move, and image in A window changes.

Tips:

- In actual system displaying, different colors of the window box and the section lines are used to identify the section A, B and C. Here, three types of line are used.

Section A MPR line=blue

Section B MPR line=yellow

Section C MPR line=orange

- Scanning plane and the probe movement

Move the probe across the body surface.

Arrow in the figure below indicates the movement of the probe (you can move the probe in the contrary direction of the arrow.).

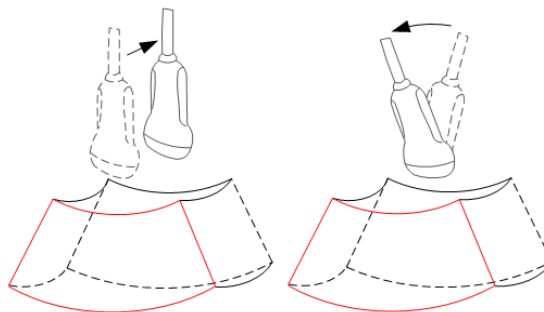

Rotating the Image

The system supports the following rotation modes:

- Sphere center rotation
- Axial rotation
- Auto rotation
- Sphere center rotation

Rotate the 3D image around the center point of the 3D image.

- Procedures

- a) Set 3D image window as the current window.

Click [Current Window] to be "3D" in the soft menu; or, press <Cursor> on the control panel to show the cursor, then move the cursor onto 3D image window, and press <Set> to select the 3D image window as the current window.

- b) The system activates sphere center rotation mode by default. You can roll the trackball to rotate the 3D image.

In sphere center rotation, the three sectional planes will change in real-time with the rotation of 3D image.

- Axial rotation

Axial rotation is to rotate the 3D image around the X, Y or Z axis.

- Procedures

- a) Set 3D image window as the current window. The procedures are the same as described in sphere center rotation.

- b) Rotate the corresponding knobs to make the image rotate, here,

- To rotate along X-axis: click [X Rotation].
- To rotate along Y-axis: click [Y Rotation].
- To rotate along Z-axis: click [Z Rotation].

You can also move the cursor to click [X Rotation], [Y Rotation], [Z Rotation], and then rotate multifunctional knob to adjust.

- Auto rotation:

1. In 3D viewing mode, click [Auto Rot.], the system enters auto rotation preparation state, and there displays the 3D image only.
2. Click [Direction] to set the auto rotation direction.
3. Click [Repeat Mode] to set the auto rotation mode.
4. Click [Speed] or rotate the corresponding knob to set the rotate speed.
5. Set Start position and End position:

Start position: roll the trackball to view to a certain position, click [Set Start Pos].

End position: roll the trackball to view to a certain position (after you rotate the image), click [Set End Pos].

6. Click [Auto Rot.] to be "On" begin the rotation, and you can also adjust the above parameters during the rotation.
7. Click [Save AVI to USB] to save images to the connected peripheral storage devices in AVI format.
8. Exit auto rotation:
Click [Exit] or press <ESC> on the control panel.

NOTE: You can view the back of the 3D image by rotating it 180°, but the back view image may not as vivid as the front. (Here we call the initial view of the 3D image you see as “front”). It’s recommended to re-capture than to rotate the 3D image remarkably if a certain region desired is blocked in the 3D image.



Image Zooming

- **Function**
Adjust the zoom factor of 3D image; the section images will be zoomed in/out accordingly.
- **Operation**
Set 3D image window as current window, Press <Zoom> button on the control panel to enter the image magnification status; rotate the multifunctional knob to increase or decrease the magnification factor.
- **Range**
The magnification factor can be 0.2-4, in increments of 0.2. The initial factor is 1.
- **Image relationship**
 - When the 3D image is zoomed in or out, the sectional plane images are changed along with it.
 - In “Adjusting VOI” to be “On” status, both the VOI box size and position are fixed. In “Adjust VOI” to be “Off” status, roll the trackball, the sectional planes are shifted along with it.

Comment and Body Mark

- **Function:**
Add comment and body mark to the sectional planes and 3D image.
- **Operation:**
The operation is the same as adding comment and body mark in B image mode.

Image Edit

- **Function**
Image editing is a more elaborate function than VOI adjusting to optimize the 3D by clipping (removing) the part blocked the region of interests.
Tips:
 - In image edit status, no image parameter can be changed. There displays a cutting cursor  or an eraser cursor .
 - The editing function is only available on a 3D rendered image.
 - Editing of the 3D image does not affect the sectional plane of A, B and C window
- **Procedures**
 - (1) Enter image editing status by clicking [Edit].
 - (2) Select an edit type.
 - (3) Set cut depth.
 - (4) Roll the trackball and press the <Set> key to position the start point, roll the trackball to set a region and press the <Set> key again, the selected region will be cut from the 3D rendered image.
If the Inside Contour/Outside Contour/Inside Polygon/Outside Polygon is selected, the region that will be cut is defined when the start point and the end point coincide.

If the eraser is selected, with the eraser moving the region that will be cut is defined in real time

- To undo the last cutting, click [Undo] in the soft menu.
- To restore the cut region, click [Redo].
- To undo all cuttings, click [Undo All].
- Click [Done] to confirm the cutting.

(5) Click [Exit] to exit image editing.

The image cutting parameters are described as follows:

Type	Parameters	Description
Edit Type	Contour. In	Allows you to trace the portion of the image you want to cut. Inside Contour removes all portions of the image that fall inside your traced region.
	Contour. Out	Allows you to trace the portion of the image you want to cut. Outside Contour removes all portions of the image that fall outside your traced region.
	Rect. In	Displays a box you can use to define the portion of the image you want to cut. Inside Rect removes all portions of the image that fall inside of the box.
	Rect. Out	Displays a box you can use to define the portion of the image you want to cut. Outside Rect removes all portions of the image that fall outside of the box.
	Eraser. Big	Provides a big eraser tool you can use to define the portion of the image to cut by hand.
	Eraser. Small	Provides a small eraser tool you can use to define the portion of the image to cut by hand.
	Polygon. In	Allows you to trace a polygon on the image you want to cut. Inside Polygon removes all portions of the image that fall inside your traced region.
	Polygon. Out	Allows you to trace a polygon on the image you want to cut. Outside Polygon removes all portions of the image that fall outside your traced region.
Edit Depth	Depth	Function: allows you to define the image depth to be cut. 3D image changes in real time along with the depth. Full: the full depth of the selected region will be cut. Define: allow you to define the depth to be cut. When [Full Depth] is "Off", you can define the depth by clicking [Edit Depth]. The range is 0%-100%, in increments of 5%.
Other Operations	Undo	To undo the last cut only.
	Redo	To restore the cut region.
	Undo All	To undo all cuts since you entered image edit mode.
	Done	Click to confirm the edit.

Tips: when reset ROI, entering cine review, exiting "Accept VOI", unfreezing the system, or entering acquisition preparation, the system will confirm with you "This operation will clear all edit effect, are you sure to continue?".

Reset ROI

■ Function

Reset ROI is to reset the region of interest to re-render the 3D image.

It's performed on frozen images.

NOTE: 1. Resetting ROI is not to re-capture images but to re-render 3D image with the image data acquired already. Usually, if the ROI set before capture is not the optimal one (e.g. the one contains the largest fetal face section area), you can reset it to improve the 3D imaging effect.

2. Resetting ROI cannot improve 3D image with a bad imaging condition, such as the un-optimal fetal posture s or lack of amniotic fluid, etc.

■ Procedures

- (1) Enter reset ROI mode: in Smart 3D image viewing mode, click [Reset ROI] in the soft menu or the menu. There displays the original B-mode images marking with ROI/VOI and progress bar.
- (2) Adjust the ROI /VOI in size and position, for details; please refer to “Adjust VOI”.
- (3) Set first frame/end frame: roll the trackball to view to a certain 2D image, click [Set First Frame]/ [Set First Frame].
- (4) After the ROI is reset, click [ReImaging] item in the soft menu to enter the 3D viewing screen. The system will create a new 3D image based on the reset ROI.

In ROI resetting status, the parameters in the soft menu can be divided into image acquisition parameter and image viewing parameter. Here,

- 3 image acquisition parameters: Method, Distance or Angle, reset curve, their functions and adjusting method are the same as the parameters in “Smart3D Acquisition Preparation”.
- 3 image viewing parameters: Set First Frame, Set End Frame, Auto Play, their functions and adjusting method are the same as the parameters in “Cine Review”.

5.11.4.5 Image Saving and Reviewing in Smart 3D

■ Image saving

- In the 3D viewing mode, press the image-saving key (Save Image to hard drive) to save the current image to the patient information management system in the set format and image size.
- Save clip: in 3D viewing mode, press the cine-saving key (Save Clip (Retrospective) to hard drive) to save CIN-format clip to the hard drive.
- Save AVI as USB: in auto rotation mode, click [Save AVI as USB] to save the auto rotation images to the USB disk.

■ Image review

Open an image file to enter the image review mode. In this mode, you can perform the same operations as what you can do in 3D image viewing mode.

5.11.5 4D

4D provides continuous, high volume acquisition of 3D images.

Make sure to perform 4D imaging with an appropriate 4D-compatible probe—4CD4s. Only if the current probe is an effective one, can the system enters 4D imaging mode. During the scanning, the probe performs the scanning automatically.

5.11.5.1 Basic Procedures for 4D Imaging

1. Select the appropriate probe and connect it to the ultrasound system (the leftmost port). Make sure there is sufficient gel on the probe for scanning.
Tips: if the current probe doesn't support 4D imaging, then [4D] button in the soft menu is disabled when entered 3D/4D imaging.
2. Select the scanning probe and exam mode, and do parameter preset if necessary.
3. Obtain a 2D image. Optimize the image as usual.
4. Enter 3D/4D imaging preparation status:
 - Press the user-defined key on the control panel; or,
 - Move the cursor onto the image menu, navigate the cursor to [Other] item and press <Set>. Select [3D/4D] in the Other menu to enter the 3D/4D imaging mode.
5. Switch to 4D imaging by clicking [4D], and define the ROI as well as curve VOI. For details, please refer to "5.11.4.1 Basic Procedures for Smart 3D Imaging".
To set a ROI, please try to cut the useless data as to reduce the volume data, shortening the time for image storing, processing and reconstruction.
6. Select a parameter pack, set parameters like [Direction], [Angle], [Image Quality], [Display Format] in the soft menu accordingly.
7. Click [Start]; or, press <Update> on the control panel to enter the 4D image real-time displaying status.
8. Press <Freeze> key on the control panel to freeze the image. Do image cutting, rotation, annotation, image saving if necessary. For the detailed operations, please refer to "5.11.4.4 Smart 3D Image Viewing".
9. Exit 4D.
Click [Exit]; or, press <ESC> button on the control panel, to exit 4D imaging.

5.11.5.2 4D Acquisition Preparation

Click [4D] on the 3D/4D page to enter 4D acquisition preparation status. In 4D imaging, you may have to set [Quality] and [Angle] except all other items in Smart 3D imaging.

- Angle
 - Function: to set the range for 4D imaging.
 - Adjusting range: 10° -70° , in increment of 5° .
 - Quality
 - Function: to adjust the image quality by changing the line density. Image quality can affect the imaging speed that the better the image quality, the lower the speed, so the frame rate is lower.
 - Range: Low2, Low1, Mid, High1, High2.
- Other parameters are the same as that of Smart 3D, for details; please refer to "5.11.4.2 Smart 3D Acquisition Preparation".

5.11.5.3 4D Image Acquisition

1. Optimize the 2D image of the desired region.
 - High contrast between the desired region and the surroundings.
 - Clear boundary of the desired region.
 - Little noise
2. Set ROI (Region of Interest) and curve VOI on the 2D image.
Roll the trackball to change the ROI size and position as well as curve VOI, press the <Set> key to toggle among setting the ROI size, position or curve VOI.

Set ROI on the 2D image with the largest area of the target region. The imaging area should be only a little larger than ROI; otherwise frame rate may be too low.

3. Click [Start] to begin the acquisition.

In 4D image acquisition, the probe performs swinging in the defined range of angle automatically.

5.11.5.4 4D Real-time Display

In 4D real-time display status, the following operations can be performed (for the details, please refer to the corresponding contents in Smart 3D.).

- Set [Quality] and [Angle].
- Set the image display format. The system can support three formats: Single, Dual and Quad.
- Set 3D image view direction by clicking [Direction].
- Select section image to define the VOI.
- Set the brightness, contrast and colorize map for 3D image.
- Rotate and shift the 3D images, and reset the images to original status by clicking [Reset].
- View section image and 3D image.
- Image rendering setting.
- Save single frame image by a user-defined save key.
- Other general operations like zooming, comment and body mark.

5.11.5.5 4D Cine Reviewing

In 4D real-time display mode, press <Freeze> on the control panel to enter the freeze mode.

The following operations can be performed (for the details, please refer to the corresponding contents in Smart 3D).

- Set the image display format. The system can support three formats: Single, Dual and Quad.
- Select section image to define the VOI.
- Rotate, zoom in/out and shift the 3D images, and reset the images to original status by clicking [Reset].
- Set 4D image view direction by clicking [Direction].
- 3D image editing (You can enter image cutting mode by clicking [Edit].).
- Set the parameters to render 3D image.
- Set the brightness, contrast and colorize map and so on for 3D image.
- Section image viewing.
- Image rotation (including auto rotation).
- Save a single frame image, save the on-screen image.
- Save cine and export AVI cine.
- Review 3D images.

4D Cine Review

Press <Freeze> key on the control panel to enter cine review status.

Cine review parameters are described as follows:

Parameter	Description
Skip to First	Skip to the first frame of image.

Parameter	Description
Skip to Last	Skip to the last frame of image.
Set First Frame	To set the current frame as the start frame for a cine to be saved. Method: review to a certain frame, and click [Set First Frame].
Set End Frame	To set the current frame as the end frame for a cine to be saved. Method: review to a certain frame, and click [Set End Frame].
Auto Play	Activate auto play, and set the cine review speed.

Tips: when system is frozen, or when open a 4D cine file, rolling the trackball left/right controls the cine frame backward/forward, while rolling the trackball up/down (a range more than 45°) makes the 3D image move forward/backward around Z-axis. Press <Set> or click soft menu item, the system returns to image viewing status.

5.11.5.6 4D Image Saving

- In the 3D viewing mode, press the image-saving key (Save Image to hard drive) to save the current image to the patient information management system in the set format and image size.
- Save clip: in 3D viewing mode, press the cine-saving key (Save Clip (Retrospective) to hard drive) to save CIN-format clip to the hard drive.
- Save as AVI: in auto rotation mode (freeze mode), click [Save AVI to USB] to save the auto rotation images to the USB disk.

5.11.6 Static 3D

Static 3D provides single frame image acquisition of 3D images. Make sure to perform static 3D imaging with an appropriate static 3D-compatible probe—4D probe. Only if the current probe is an effective one, can the system enter static 3D imaging mode. During the scanning, the probe performs the scanning automatically.

5.11.6.1 Basic Procedures for Static 3D Imaging

To perform static 3D imaging:

1. Select the appropriate static 3D-compatible probe and connect it to the ultrasound system (the leftmost port). Make sure there is sufficient gel on the probe for scanning.
Tips: if the current probe doesn't support static 3D imaging, the [Static 3D] item in the soft menu is disabled when entered 3D/4D imaging.
2. Select the scanning probe and exam mode, and do parameter preset if necessary.
3. Obtain a 2D image. Optimize the image as usual.
4. Enter 3D/4D imaging preparation status:
 - Press the user-defined key on the control panel; or,
 - Move the cursor onto the image menu, navigate the cursor to [Other] item and press <Set>. Select [3D/4D] in the Other menu to enter the 3D/4D imaging mode.
5. Switch to static 3D imaging by clicking [Static 3D], and define the ROI.
For details, please refer to "5.11.4.1 Basic Procedures for Smart 3D Imaging".
To set a ROI, please try to cut the useless data as to reduce the volume data, shortening the time for image storing, processing and reconstruction.
6. Select a parameter pack, set parameters like [Direction], [Angle], [Image Quality], [Display Format] in the soft menu accordingly.

7. Click [Start]; or, press <Update> on the control panel to begin the 3D image acquisition.

The system enters into 3D image viewing status when the acquisition is completed; or, you can finish the acquisition ahead by clicking [Stop] in the soft menu.

In image viewing status, you can perform all operations (except reset ROI) that can be performed in Smart 3D. For details, please refer to “5.11.4.4 Smart 3D Image Viewing”.

8. Return to image acquisition preparation:

Press <ESC>, <Update> or <Freeze> to return to image acquisition and perform imaging again if necessary.

9. Exit 3D/4D.

Press button, 3D/4D shortcut key, or press <ESC> twice to exit Smart 3D imaging.

5.11.6.2 Static 3D Acquisition Preparation

Click [Static 3D] in the soft menu to enter the static 3D acquisition preparation status.

Adjustable parameters in static 3D acquisition preparation status are the same as that of Smart 3D and 4D, for details, please refer to the corresponding contents in “Smart 3D” and “4D”.

5.11.6.3 Static 3D Image Acquisition

Image acquisition operations are basically similar with that of 4D, the only difference is: in static 3D imaging, only a single frame 3D image is captured, while in 4D imaging, continuous, high volume acquisition of 3D images are provided. The system enters static 3D image viewing status when the acquisition is completed.

5.11.6.4 Static 3D Image Viewing

All functions (except ROI reset) in Smart 3D image viewing mode are available in static 3D image viewing mode, for details; please refer to “5.11.4.4 Smart 3D Image Viewing”.

5.11.6.5 Static 3D Image Saving

For details, please refer to “5.11.4.5 Image Saving and Reviewing in Smart 3D”.

5.12 iScape

The iScape panoramic imaging feature extends your field of view by piecing together multiple B images into a single, extended B image. Use this feature, for example, to view a complete hand or thyroid.

When scanning, you move the probe linearly and acquire a series of B images, the system piece these images together into single, extended B image in real time. Besides, the system supports out-and-back image piecing.

After you obtain the extended image, you can rotate it, move it linearly, magnify it, add comments or body marks, or perform measurements on the extended image.

You can perform the iScape panoramic imaging feature on B real time images using all linear and convex (including 4D probes) probes.

	CAUTION: iScape panoramic imaging constructs an extended image from individual image frames. The quality of the resulting image is user-dependent and requires operator skill and additional practice to become fully proficient. Therefore, the measurement results can be inaccurate. Exercise caution when you perform measurements in the iScape mode. Smooth even speed will help produce optimal image results.
---	--

Tips:

- iScape is an optional module, the function is available only if the module has been installed on the ultrasound system.
- The display of the biopsy guideline is not allowed in iScape mode.

5.12.1 Basic Procedures for iScape Imaging

To perform iScape imaging:

1. Connect an appropriate iScape-compatible probe. Make sure that there is enough coupling gel along the scan path. Set parameters if necessary, for details; please refer to “5.12.2 iScape Preset”.
2. Enter iScape:
 - Click [iScape] in the soft menu in B-mode; or,
 - Press the user-defined key on the control panel; or,
 - Move the cursor onto the image menu, navigate the cursor to [Other] item and press <Set>. Select [iScape] in the Other menu to enter the iScape imaging mode.

3. Optimize the B mode image:

In the acquisition preparation status, click [B] page tab to go for the B mode image optimization.

Tips: in iScape mode, [FOV] is limited to “W”.

4. Image acquisition:

Click [iScape] page tab to enter the iScape acquisition preparation status. Click [Start Capture] or press <Update> on the control panel to begin the acquisition. For details, please refer to “5.12.3 Image Acquisition”.

The system enters into image viewing status when the acquisition is completed. You can perform operations like parameter adjusting. For details, please refer to “5.12.4 iScape Viewing”.

5. Exit iScape

- Click [Return], or press <Esc> to return to iScape preparation; or press button to return to B mode. If it is in the capture status, click [Exit] in the menu; or, press the <Esc> key; or, press button on the control panel.

5.12.2 iScape Preset

■ Shortcut key preset

The system supports shortcut key to enter iScape mode. Assign a key as user-defined iScape key: [Setup] → [System] → [Key Config]. Refer to “15.1.7 Key Config” for details.

■ Parameter preset

● iScape ruler display

Function: to set if to display the ruler on the edge of the extended image.

Method: open Image Preset page via “[Setup] → [System Preset] → [Image Preset]”, and then check “iScape Ruler Display”.

Tips: when there are abrupt changes in speed of motion, the ruler will not entirely match with the edge of the merged image.

■ Menu preset

To set displayed menu and soft menu items in image capture, iScape viewing and image review, refer to section “5.15.2 Soft Menu and Menu Preset” for details.

5.12.3 Image Acquisition

To create an iScape image, you start with an optimized 2D image. The 2D image serves as the mid-line for the resulting iScape image.

1. Press the <Update> key or click [Start Capture] in the soft menu to start the iScape image capture.
2. Scan slowly to obtain a single extended field of view image; you can also perform erasing and retracing if the image is not satisfied.

To end image acquisition and exit iScape: press <Esc>; or, press button; or, press the user-defined key on the control panel.

3. End image capture:

To end the image capture:

- Click [Stop Capture] in the soft menu; or,
- Press the <Update> key; or,
- Press <Freeze> key; or,
- Wait until the acquisition is finished automatically.

After the acquisition is completed, the panoramic image will be displayed. And the system enters iScape viewing mode.

Tips:

- During the image acquisition, no parameter is adjustable, and functions like measurement, comment and body mark are not available.
- ROI: a green box on the image indicating the boundary between the merged images and the unfinished images.
- Tips about the probe speed: during image slicing, the system gives feedbacks about the probe moving speed in the form of color and words, the relations are listed as follows:

Status	ROI Color	Tips
Speed too low	Blue	Moving speed of the probe is too low.
Appropriate	Green	None
Speed too high	Red	Moving speed of the probe is too high.

Guidance and precautions for uniform motion:

- Make sure that there is enough coupling gel along the scan path.
- Always move the probe slowly and steadily.
- Continuous contact is required throughout the length of the extended image. Don't lift the probe from the skin surface.
- Always keep the probe perpendicular to the skin surface. Don't rock, rotate or tilt the probe during the scan.
- The system accommodates a reasonable range of motion velocity. Don't make abrupt changes in speed of motion.
- Deeper scans generally require reduced acquisition speed.

5.12.4 iScape Viewing

After completing the image acquisition, the system performs image splicing and then enters the iScape viewing mode.

In iScape viewing mode, you can perform the following functions:

- Image parameters setting, for details, please refer to "5.12.4.1 Image Parameters".
- Image zooming, for details, please refer to "5.12.4.2 Image Zooming".
- Image rotation, for details, please refer to "5.12.4.3 Rotating the Image".
- Measurement, comment, and body mark, for details, please refer to "5.12.4.4 Measurement, Comment, and Body Mark".

5.12.4.1 Image Parameters Setting

In image viewing mode, you can adjust the following parameters:

- Image size
 - Click [Actual Size] to display the image in its actual size.
 - Click [Fit Size] to display the image in an appropriate size according to the current window. Also this is the system default format.
- Colorize and colorize map
 - Click [Colorize] to activate the colorize function, and then change the effect by clicking [Colorize Map] in the soft menu.
- Ruler
 - Click [Ruler] to turn on or off the ruler display on the image.

5.12.4.2 Image Zooming

Press <Zoom> button on the control panel to enter image zooming mode. Rotate the multifunctional knob to zoom in/out the panoramic image.

- Rotate the knob clockwise to zoom in the image, the maximum factor is 4.
- Rotate the knob anticlockwise to zoom out the image, the minimum factor is 0.01.
- Roll the trackball to change position of the magnified image.
- Press the <Zoom> key again to exit the zoom mode.

- When image displayed is bigger than the image area, the thumbnail is automatically displayed.

5.12.4.3 Rotating the Image

For the convenience of viewing the image, you can rotate the image by clicking [Rotation] in the soft menu.

5.12.4.4 Measurement, Comment, and Body Mark

In iScape image viewing status, you can perform measurement, comment, and body mark. The operations are the same as that of B mode.

- NOTE:**
1. The measurement accuracy for the spliced image may be degraded, exercise caution when measurements are performed on an iScape image.
 2. If there is a trace during the retracing, please don't perform measurement across the trace.

5.12.4.5 Evaluate Image Quality

Many variables may affect the overall image quality. It is important to evaluate the image content and quality before an image is used for diagnosis or measurements.

- NOTE:** iScape panoramic imaging is intended for well-trained ultrasound operators or physicians. The operator must recognize image artifacts that will produce a sub-optimal or unreliable image.

The following artifacts may produce a sub-optimal image. If the image quality cannot meet the following criteria, you shall delete the image and do image acquisition again.

- The Image must be continuous (no part of an image moves suddenly or disappears.)
- No shadow or absent signal along the scan plane.
- Clear profile of anatomy through the entire scan plane without distortion.
- Skin line is continuous.
- The images are captured from the same plane.
- There is no large black area in the image.

5.12.5 Cine Review

Click [Review Cine] in the soft menu in panoramic image viewing status to enter cine reviewing mode.

In cine review status:

- Roll the trackball to review the captured images frame by frame.
- Click [Auto Play] to start or end auto play.
- In auto play mode, click [Auto Play] in the soft menu; or, press/rotate the corresponding knob to change the play speed. When the speed is 0, the system exits auto play mode.
- Review to a certain image; click [Set First Frame] to set the start point. Review to another image; click [Set End Frame] to set the end point. In auto play mode, the review region is confined to the set start point and end point.
- Click [iScape] item in the soft menu to exit the cine review mode, and there displays the panoramic image.

- In cine review mode, press <Freeze> on the control panel to return to the acquisition preparation status.
- Click [Save Cine] to save the images.

5.12.6 Save Image

- Panoramic image viewing mode:
 - Press <Save> key (with user-defined saving function) to save the extended image to the default position in the format of FRM.
 - Click [Save Cine] item in the soft menu to save the extended image and its series of images acquired in the format of CIN.
- Cine reviewing mode:
 - Press <Save> key (with user-defined saving function) to save the single-frame image to the default position, in the format of FRM.
 - Click [Save Cine] to save the extended image and its series of images acquired in the format of CIN.

5.13 Contrast Imaging

2D contrast imaging is used in conjunction with ultrasound contrast agents to enhance the imaging of blood flow and microcirculation. Injected contrast agents re-emit incident acoustic energy at a harmonic frequency which is much more efficient than the surrounding tissue. Blood containing the contrast agent stands out brightly against a dark background of normal tissue.

Contrast imaging is an option.

Only probe C5-2s in Adult ABD support contrast imaging.

- Items that appear in the menu or the soft menus are dependent upon preset, which can be changed or set through "[Setup] -> [Image Preset]"; please refer to "5.15 Image Preset" for details.

CAUTION: Set MI index by instructions in the contrast agent accompanied manual.

Read contrast agent accompanied manual carefully before using contrast function.

NOTE: Be sure to finish setting the parameters before injecting the agent into the patient to avoid affecting the image consistency. This is because the agent's acting time is limited.

The contrast agent used must comply with the relevant local regulations.

5.13.1 Basic Procedures for Contrast Imaging

To perform successful contrast imaging, start with an optimized B image and have the target region in mind. To perform contrast imaging:

1. Select an appropriate probe and exam mode. Perform 2D imaging to obtain the target image, then fix the probe.
2. Enter Contrast mode: click [Contrast Imaging] on the soft menu or press the user-defined Contrast key directly.
3. Adjust the acoustic power experientially to obtain a good image.
Observe the tissue image to find the target view.
4. Inject the contrast agent, and set [Timer 1] to "ON" to start the contrast timing. When the timer begins to work, the time will be displayed on the screen.
5. Observe the image. Use the [Pro Capture] and [Retro Capture] on the soft menu or the user-defined keys (defined as prospective capturing and retrospective capturing) to save the images. Click those soft menu controls again or press <Freeze> to end the live capture.
Perform several live captures if there are more than one sections of interest.
6. At the end of contrast imaging, set [Timer 1] to "OFF" to exit the timing function.
Perform procedures 3-5 if necessary.
For every single contrast imaging procedure, use [Timer 2] for timing.
If necessary, activate the destruction function by clicking [Destruct] to turn it to "ON" and destruct the micro-bubbles left by the last contrast imaging, or to observe the reinfusion effect in a continuous agent injecting process.
7. Exit contrast imaging.

Click [Exit] on the menu in the top-left part of the screen to exit contrast imaging mode, or press to return to B mode.

5.13.2 Contrast Image Parameters

Parameter Area Display

When entering contrast imaging mode, the screen displays the contrast image. If the [Dual Live] on the soft menu is "ON", both the contrast image (marked with "C") and tissue image (marked with "T") are displayed (the two window positions can be changed). Parameter area displays as follows:

Type	Parameter	Description
Contrast	FCH	Contrast frequency.
	D	Depth.
	G	Gain.
	FR	Frame rate.
	IP	Post processing parameter
	DR	Dynamic Range.
Tissue	G	Gain
	IP	Post processing parameter
	DR	Dynamic Range.
Timing (if timer is "ON")	/	In real-time mode, the time displayed is the elapsed time. In freeze mode, the timer stops working and the elapsed time is displayed.

Image Optimization

To adjust the contrast image as well as the tissue image, use the left/right keys of soft menu controls <4> to switch between the menus of tissue image and contrast image.

The parameters in Contrast mode are similar to those in B mode. See chapter B for details. Special Contrast imaging parameters are introduced below.

Timer

The two timers are used to record the total time of the contrast imaging and the single time of one contrast exam.

After the image is frozen, Timer 1 is still running, and after unfreezing the image, the corresponding time can be seen.

Timer 2 stops timing when a contrast exam is frozen, and after unfreezing the image Timer 2 is off.

NOTE: The starting time displayed may be inconsistent with the actual one due to system error or some other human error. Check the agent-injecting time.

Set [Timer 1(2)] to "ON" to start timing from the moment you inject the contrast agent. The screen displays the times in the bottom-right corner.

- The time begins at 0.
- In live mode, the elapsed time is displayed. For example, **00:00:08** means the elapsed time is 8 seconds.
- If the image is frozen during timing, the timer stops working and the elapsed time will be displayed after defreezing the image.
- Set [Timer 1] or [Timer 2] to “OFF” and the timer stops running.

Micro-bubble Destruction

Function: to destroy the micro-bubbles left by the previous contrast imaging, or observe the reinfusion effect in a continuous agent injecting process.

- Entering: click [Destruct] on the soft menu to enable the micro-bubble destruction function.
- Parameters: set the parameters using the soft menu.
 - DestructAP: adjust the destruct acoustic power.
 - Destruct Time: adjust the destruct time with the adjusting range of 100-2000ms

Dual Live

In live mode or freeze mode, set the soft menu item [DualLive] to “ON” to enable the dual live function. Both the contrast image (marked with “**C**”) and the tissue image (marked with “**T**”) are displayed (the position can be changed). Use the left/right keys of soft menu controls <4> to switch between the menus of tissue image and contrast image so that you can adjust the corresponding parameter.

Tip:

- In dual live mode, the screen displays the contrast image and tissue image
- In freeze mode, only one cine review progress bar displays as the contrast image and tissue image are reviewed synchronously.

- Image position

Use [CEUSPos: XX] to adjust the position of the contrast image.

When it is selected as “Left”, the image displays at the left side of the screen.

Max FR

Function: to define FR limitation for current status. Parameters like depth, line density and frequency may affect the frame rate of the system. This feature will confine the max frame rate at a certain level.

The system provides 4 levels

Image Saving

- Live capture

In live mode, you can save the images of interest by clicking [Pro Capture] and [Retro Capture] or press the user-defined save key.

- Cine saving

In live mode, press the <Freeze> key on the control panel to enter cine review status.

5.13.3 Measurement, Comments and Body Marks

The system supports image measurement, comment and body mark functions. For details, see the relevant sections.

5.14 Elastography

CAUTION: Elastography images are provided for reference only, not for confirming diagnoses.

Elastography imaging is an option.

Linear probes L12-4s and L14-6Ns under thyroid and breast exam modes support the Elastography function.

- Items that appear in the menu or the soft menus are dependent upon preset, which can be changed or set through "[Setup] -> [Image Preset]"; please refer to "5.15 Image Preset" for details.

5.14.1 Basic Procedure for Elastography

1. Perform a B scan to locate the region.
2. Select the appropriate probe and exam mode.
3. Click [Elasto] on the soft menu or press the user-defined key to enter the mode. Adjust the ROI according to the actual situation.
4. Select the probe according to the experience and actual situation.
5. Adjust the image parameters to obtain the optimized image and necessary information.
6. Adjust the ROI on the frozen image if necessary.
7. Save the image or review the image if necessary.
8. Perform measurement or add comments/body marks to the image if necessary.
9. Estimate the hardness of lesions according to the results.
10. Press to return to B mode.

5.14.2 Pressure Hint Curve

The screen displays the pressure curve in real time:



The X-axis represents time and the Y-axis represents pressure.

ROI Adjustment

Description To adjust the width and position of the ROI in Elasto imaging.

Operation When the ROI box is solid line, roll the trackball to change its position.
When the ROI box is a dotted line, roll the trackball to change the size.
Press <Set> to switch between the solid line and the dotted line status.

Smooth

Description To adjust the smooth feature of the Elasto image.

Operation To adjust the image smoothness. Adjust using the [Smooth] on the soft menu.
The system provides 5 levels of smooth function: the bigger the value the stronger the effect.

Opacity

Description To adjust the opacity feature of the Elasto image.

Operation Use [Opacity] on the soft menu.
The system provides 5 levels of opacity function: the bigger the value the stronger the effect.

Invert

Description To invert the E color bar and therefore invert the colors of benign and malignant tissue.

Operation Click [Invert] on the soft menu.

Single E

Description To switch between the B+E dual window and the single E window.
E represents the Elastography image.

Operation Click [Single E] on the soft menu. When the button is highlighted in green, the screen displays the single window E image.

Map

Description To select different maps for observation.

Operation Use [Map] on the soft menu to select the map.
The system provides 6 maps, including 1 grayscale map and 5 color maps.

Tip: In Elasto imaging mode, image magnification is not available.

5.14.3 Mass Measurement

Press <Measure> to enter measurement status.

You can measure shell thick, strain ratio, strain-hist, etc.

For details, see [Advanced Volume].

5.14.4 Cine Review

Press <Freeze> or open an elastography imaging cine file to enter cine review status.

5.15 Image Preset

In the Image Preset interface, you can preset image parameters of exam modes and soft menu and menu layout of imaging modes.

5.15.1 Image Preset

The image preset is used to set image parameters for all the probes and a specific probe in a specific exam mode. The setting methods are similar although parameter items are different in each image mode.

An example is provided below to demonstrate the steps of preset as in Adult ABD exam, B/THI mode for the P7-3s probe, for special imaging modes (Free Xros M, 3D/4D, iScape), please refer to the relevant sections of each mode:

1. Press <Setup> on the keyboard to enter the Setup menu.
2. Select “[Image Preset] → [B/THI]” to enter the B mode parameters preset, as shown in the following figure.



3. Select the exam mode and probe.
 - Select “Adult ABD” from the “Exam Mode” drop-down list.
 - Select “P7-3s” from the “Probe” drop-down list.
4. Image parameter preset
 - The [Adult ABD-All Probe] field on the left side of the screen displays the parameter preset for all probes in Adult ABD exam mode.

Parameter	Type	Description
Acoustic Power	Drop-down list	To set the default acoustic power.
Thermal index	Check box	TIC, TIB, TIS, to choose the item to be displayed on the screen.
Colorize	Check box	To set the default status of colorize function in B mode, to turn on or off.
Colorize Map	Drop-down list	To set the default colorize map in B mode.
TSI	Drop-down list	To set the default TSI mode for B mode.
iTouch	Drop-down list	To set the default gain of iTouch in B mode.
iTouch Bright	Drop-down list	To set the default brightness of iTouch.

- The [Adult ABD-P7-3s] field on the right side of the screen displays the parameter preset for the P7-3s probe in Adult ABD exam mode.

Parameter	Type	Description
Depth	Drop-down list	To set the default depth in B mode.
Frequency	Drop-down list	To set the default frequency of the probe.
FOV	Drop-down list	To set the default FOV in B mode.
Focus Position	Drop-down list	To set the default focus position in B mode.
Focus Number	Drop-down list	To set the default focus number in B mode.
Steer	Drop-down list	To set the default steer angle for the linear probe in B mode.
Line Density	Drop-down list	To set the default line density in B mode.
B Gain	Drop-down list	To set the default gain value in B mode.
THI gain	Drop-down list	To set the default THI gain value in B mode.
B Gray Map	Drop-down list	To set the default gray map in B mode.
THI Gray Map	Drop-down list	To set the default gray map in THI mode.
iBeam	Drop-down list	To set the default iBeam value for the linear probe in B mode.
L/R Flip	Radio button	To set the default horizontal flipping mode: Left or Right.
U/D Flip	Radio button	To set the default vertical flipping mode: Up or Down.
Rotation	Drop-down list	To set the default rotate angle in B mode.
B IP	Drop-down list Button	To set the default B IP value and you can preset each parameter in the button.
THI IP	Drop-down list Button	To set the THI IP parameters and you can preset each parameter in the button.
High FR	Radio button	To set if high FR is turned on by default.

- Click [Record Current] to record all the currently-used setting and values for each preset image parameter.
- Click [Load Factory] to restore the settings to the original factory default.

5. Exit:

- Click [OK] to save the settings and exit.
- Click [Cancel] to abandon the settings and exit.

5.15.2 Soft Menu and Menu Preset

Click [Menu Preset] on the Image Preset screen to open the Menu Preset page. The default is the currently-used probe in the current imaging mode.

The system supports menu preset of all image modes including image freeze, cine review and sub modes (3D View, Static 3D, 4D, Smart 3D, Reset ROI, etc.) with all probe types. Menu items in cine reviewing of all image modes are the same.

Since the preset operations are the same for different image modes and status, the following case (linear probe in real time B mode) is taken as an example.

5.15.2.1 Soft Menu Preset

The soft menu preset screen is shown as the figure below:



1. Click [Image Params] page tab to enter image parameter setting page.
2. Select the probe type: select “Linear” in the corresponding drop-down list.
3. Select image mode: select “B” in the drop-down list.
4. Select image status: select [Active] in the left size, and the system shows the corresponding available items.
5. Click [Softkey] on the right side of screen to begin the setting.
 - Add the item (s)
Select an item in the Available Item list, and click  to add the item to the soft menu.

Double click the item in the Available Item list continuously to add the items one by one.

Click **>>** to select all items in the Available Item list to the soft menu.

- Withdraw the item (s)

Select an item in the soft menu page, and click **<** to delete the item in the soft menu.

Click **<<** to delete all the selected items in the soft menu.

- Position adjusting

Position interchange: select an item in the soft key page, and then click a blank button or a different item to interchange the position.

Change position of the selected items: select an item on the right side box and click [Up], [Down], [Left] or [Right] button to move the position of the item.

Blank line

Click [Add Blank Line] to add a new blank line.

Click [Del Blank Line] to delete an extra line.

6. Click [OK] to complete the setting.

5.15.2.2 Menu Preset

On Menu Preset page, click Menu on the right side to enter the menu preset page. See the figure below:

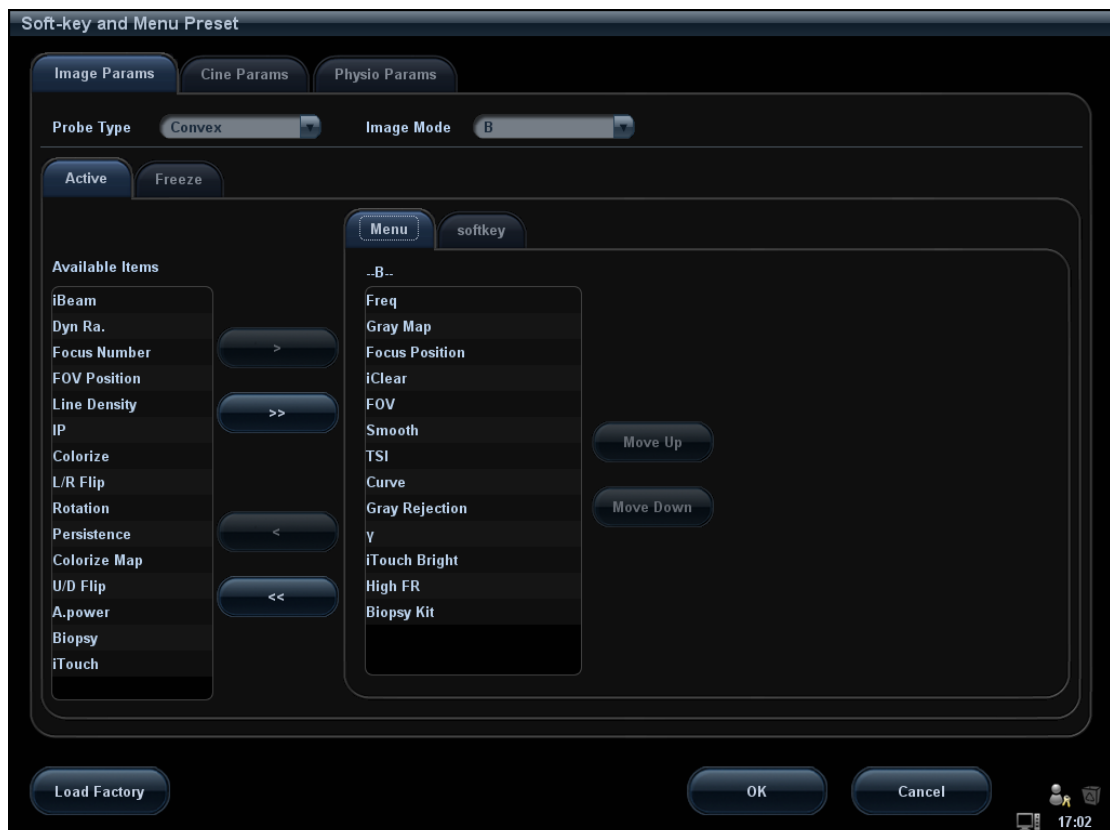



1. Click [Image Params] page tab to enter image parameter setting page.
2. Select the probe type: select "Linear" in the corresponding drop-down list.
3. Select image mode: select "B" in the drop-down list.

4. Select image status: select [Active] in the left size, and the system shows the corresponding available item.
5. Click [Menu] on the right side of screen to begin the setting.
 - Add/withdraw item(s)

Click  to add the selected item in the Available Item list to Menu page; or, double click the item in the Available Item list continuously to add the items one by one.

Click  to add all items in the Available Item list to Menu page.

Click  to withdraw the selected item in the Menu page to the Available Item list.

Click  to withdraw all the items on the Menu page to the Available Item list.
 - Change position of an item

To change position of an item, select the item in the right side box and click [Move Up] or [Move Down].
6. Click [OK] to confirm the setting and exit Menu Preset page.

6 Stress Echo

 **CAUTION:** Stress echo data are provided for reference only, not for confirming a diagnosis.

Note: Stress Echo feature does not apply to 03.02.00 version software.

6.1 About the Stress Echo Feature

The optional Stress Echo feature allows you to capture and review cardiac loops for multiple-phase (multiple-stage) Stress Echo protocols. It provides tools for ECG-triggered acquisition, display, selection, comparison, evaluation, and archiving of multiple cardiac loops during various stages of the Stress Echo portion of a patient examination.

Stress Echo data consists of Stress Echo loops, wall motion scores, and all other information pertaining to the Stress Echo portion of a patient examination.

6.2 Acquisition of Stress Echo Loops

A loop is a clip that displays motion of a whole heart cycle or from beginning systole to end systole, as indicated by the R-wave of the ECG trace and determined by the QT – Time Table in the Maintenance dialog box.

The loops in a given protocol are acquired by stages (phases), according to stage configuration (continuous (prospective) or retrospective (non-continuous)).

Loops in non-continuous stages are limited to a specified loop-per-view maximum (such as four). View labels can be selected only in the configured order. Acquisition is retrospective; when you click [Save Clip] key or press <Save 1> key on the control panel, the system saves the previously acquired images.

For an alternative workflow, you can configure stages in Stress Echo protocols using the Clip Capture option. Loops in continuous stages are limited by time rather than a maximum number of loops—the system stops acquisition after two minutes. Acquisition is prospective; when you select the stage label and then press <Save 1> key on the control panel, the system starts saving newly acquired images. With this workflow, you assign view labels to the loops after acquisition is complete, using controls in the Stress Echo screen to select the "preferred" loop for each view.

Tips:

For continuous stage loops, you must assign view labels to use the wall motion scoring function in the Stress Echo screen.

When you save images, the system places a green checkmark to the left of the view or continuous stage and then shifts the red arrow to the next view or continuous stage. When image acquisition is completed for the first stage, the system can display a reference image (the position of the reference image can be changed manually) of the corresponding view from the first stage (if the stage is non-continuous and if reference image display is enabled).

To acquire Stress Echo loops:

To acquire Stress Echo loops that are based on the systolic cycle, enable the ECG option. If this option is not enabled, the system acquires one-second clips by default. ECG must be enabled for continuous stages.

1. Click [Stress Echo] icon on the lower left corner of the screen, or press the customized key.
2. The system displays the Select Protocol window with protocol selections. Select the desired protocol and then click [OK].

The system displays the real-time imaging screen.

If the Stress Echo manual ROI option is selected in the Maintenance dialog box, then the system also displays a region of interest (ROI). If Acquire Mode is set as Full-screen in Maintenance, then no ROI box is displayed.

3. If an ROI is displayed, adjust the ROI size and position, click [Fix ROI] or press <Update> key on the control panel to confirm the ROI.

Tips:

- You cannot adjust the ROI size during acquisition.
4. Press <Save > key on the control panel to start acquisition.

The system displays the Protocol window on the left of the screen, listing the phases for the selected protocol along with the views of the first phase (Phases are stages). The system selects the first view for acquisition by default, indicating view selection by placement of a red arrow to the left of the view.

5. Proceed through each view in each stage using the following instructions (for non-continuous stages):
 - To save acquired images for the selected view, click [Save Clip] on the soft menu or press <Save > key on the control panel, and the system goes to the next view for acquisition by default.
 - To skip the selected view, click [Skip View].
 - Click [Stage] and [View] to select the stage and view for image acquisition (or reacquisition), press <Save> key to start the acquisition.

Tips: views can be re-acquired until you click [End Acquisition].

At completion of acquisition for each stage, the system advances to the next stage. If the stage is non-continuous, then the system displays the views of the stage. When image acquisition is completed for all views and continuous stages, the system shifts the red arrow to the Stop Grabbing selection in the Protocol window.

If the protocol contains continuous stages (for alternative workflow), then proceed through each continuous stage using the following instructions:

- To begin saving acquired images for the selected stage, press <Save 1> key on the control panel or click [Save Clip] on the control panel.
The system displays a percentage marker below the selected stage indicating the progress of the continuous capture.
- To stop saving acquired images for the selected stage (before the system automatically completes the continuous capture), click [Stop Acquisition] or press <Freeze>, the percentage stops to increase, and you can click [Continue Acquisition] or press <Freeze> key again to continue. To end the exam, press <Save 1> on the control panel.
- To skip the selected stage, click the [Skip Stage] on the soft menu.
- To select another continuous stage, position the trackball pointer over the stage and then press the <Set> key on the control panel, or click [Stage] on the soft menu.

At completion of acquisition for each stage, the system advances to the next stage. If the stage is non-continuous, then the system displays the views of the stage. When image acquisition is completed for all views and continuous stages, the system shifts the red arrow to the Stop Grabbing selection in the Protocol window.

6. To start or restart the timer, click [Stage Timer] / [Exam Timer] on the soft menu.
Stage time is displayed at the right side of each stage in the protocol list, while Exam time is displayed on the right side of the monitor.
Each saved image will be marked with two times T1 and T2 (displayed if enabled), T1 refers to the total time of the whole acquisition, while T2 means the time the acquisition lasted for a certain stage.
7. To adjust the ROI position during acquisition, press the <Update> key on the control panel or click [Set ROI] on the soft menu and then roll the trackball until you achieve the required ROI position. And then press the <Update> key on the control panel again or click [Fix ROI] on the soft menu to continue acquiring Stress Echo loops.
8. To review loops before ending acquisition, click [Review] on the soft menu. You can redisplay the real-time imaging screen to continue acquisition by clicking [Acquire] on the soft menu.
9. To end acquisition and review the acquired images, click [End Acquisition] on the soft menu.
When the acquisition is ended, no stress echo image acquisition can be performed for the same exam.

6.3 Navigation Toolbar



The function of the buttons from left to right separately is:

- Acquire Mode: Return to live imaging from stress echo review screen. Only available when stress echo acquisition is not yet complete.
- Select Mode: Enables selection of preferred loops.
- Review Mode: Return to stress echo review.
- Wall Motion Scoring Mode: Assign wall motion scores to specific segments within each view.



- Indication: Enter indications or comments as text or as predefined terms.
- Save Examination: Saves stress echo data with all loops (for each view and continuous stage).
- Save Examination (only selected loops): Saves only stress echo loops selected as preferred (one loop for each view).
- Report Preview: Displays report for current mode when available.
- Print Report: Prints report for current mode.
Reports are in a PDF format.



- PrintPdf: Export the report in PDF format.
- Maintenance: Displays Maintenance dialog box for protocol customization.
- Exit: Closes stress echo screen and exits stress echo feature, displays Patient Info screen.



- Toggle Play.
- Frame-by-frame loop review or direct access to first/last loop in series.
- Decrease Speed/Increase Speed: Decrease or increase playback speed.
- Sweeping Play: Continuous sweeping playback of loops forward-backward-forward.
- Labels on/off: hide/display graphics on loops.



- Specifies loop segment of display.

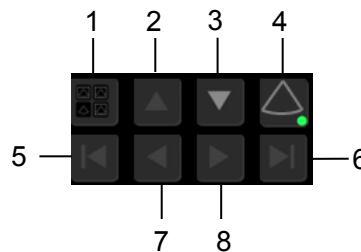

- Bookmark Review: turns on/off the bookmark function.
- Scroll Up: Displays loops in previous view.
- Scroll Down: Displays loops in next view.
- Quad/Single: to display all loops of the exam.
- Home: Selects first loop in currently displayed view.
- To Left: Selects previous loop in currently displayed view.
- To Right: Selects the next loop in currently displayed view.
- End: Selects last loop in currently displayed view.

Tips:

1. For a Continuous stage, Scroll Up and Scroll Down buttons display the preferred loop for the view. If no loop is designated as preferred for the selected view, these buttons will have no effect.
2. For a Continuous stage, the Home, To Left, To Right and End buttons display loops saved for the stage (not view).

6.4 Selecting Preferred Stress Echo Loops (Select Mode)

The selected clips are used for analysis in the review mode and wall motion scoring mode. Select Mode is used for the selection of the best loops of the examination.

When acquisition is ended, select mode is enabled automatically, or, select the Select Mode toolbar button at the top of the screen.

In Select Mode, you can select the representative loop ("preferred" loop) for each view. If you activate Review Mode without first selecting preferred loops, then the system uses the default loop selection to represent each view (for non-continuous stages). The default loop selection is the loop acquired immediately prior to the last loop. For example, if four loops are acquired for every view, then the default loop selection is the third loop.

Loops for views in non-continuous stages are labeled with the view name at acquisition. Loops for views in continuous stages are labeled with the view name when you select the “preferred” loop.

To select “preferred” loops:

1. Activate Select Mode by clicking [Select] on the soft menu, or selecting Select Mode icon  on the top of the screen.

The system displays the acquired loops for the first view in the protocol (for non-continuous stages). If the first stage is continuous, then the system displays the first set of acquired loops for that stage.

2. Select the loop. Use the buttons displayed during Select Mode to designate another loop or another view for display.

The system outlines the selected loop in gray graphical boarder to indicate selection and click the selected loop to cancel its “selected state”.

- Double click a clip, the clip will be selected, and the system will go for clip selection of the next view.
- Click [Next], [Previous], [First], [Last] to display another loop in the current view. For a continuous stage, the [Next], [Previous], [First], [Last] buttons display loops saved for the stage (not the view).
- Select Scroll Up or Scroll Down to display another view. For a continuous stage, click the Scroll Up and Scroll Down buttons to display the preferred loop for the view. If no loop is designated as preferred for the selected view, then these buttons have no effect.

Scroll Up: displays loops in the previous view.

Scroll Down: displays loops in the next view.

3. Select the stage and view to display all loops for the view and then continue designating the “preferred” loop for each displayed view until all views are completed.

Description of select mode pertinent soft menu keys:

Selection	Description
1.Clip/2.Clip/3.Clip/4.Clip	For selecting views in the selected stage.
Next	Next four Clips.
Previous	Previous four Clips.
First	Go to “first” Clips.
Last	Go to “last” Clips.
Text “On”/“Off”	Function that turns on screen graphic text “On”/“Off”. The function is the same as Labels on/off icon on the top of the screen. Information includes: name of level, name of view, heart rate, time stamp acquisition, timers, frame slider, loop ID, clip control. For the cine without distributed view, name of level, name of view are displayed in “---”.
Apply edit all	Clip edit applied to all clips taken.
Bookmark	For continuous acquisition, when bookmark is set “On”, only the selected loops for the current view can be displayed.

Selection	Description
Clip Length	Set the clip length: Systole, User Defined.
Save Selected	Saves only the selected clips for the study.
Save All	Saves all the clips acquired for the study.
Suspend	Pause the stress echo exam but not end the stress echo exam. When stress echo exam is suspended, the user can perform image acquisition of all other imaging modes, or perform operations like measurement.
End	End the stress echo exam.
Stage	Rotate the knob to find the stage and press it to select.
View	Rotate the knob to find the view and press it to select.
Full Screen	Select whether to display all loops of the exam or not.

6.5 Review Mode

Review mode is used by cardiologist to evaluate clips for cardiac wall motion abnormalities. Different views, from different stages, will be selected to display to compare in a wide variety of combinations. The most common workflow is to compare “same views” but at “different stages” of the exam (Example: PSLA view, Rest stage compared to PSLA view, Post exercise stage).

- Enter review mode

Select the Review Mode toolbar button at the top of the screen. Or, click [Review] on the soft menu.

- To restrict the display to a selected phase or view

1. Set [Shuffle] as “On” on the soft menu, or select shuffle mode icon  on the monitor.

2. Select the label of the phase or view (for example, Rest or Long Axis).
The system displays all loops that represent the selected phase or view.

- To display phases side by side for the selected view(s)

1. The system include all phase or view in display, select the leftmost, gray box to the left of each required phase and/or view.

The system inserts a checkmark into each selected gray box.

2. To exclude a phase or view from display, select the rightmost, blue box to the left of each required phase and/or view.

The system inserts a red X into each selected blue box.

3. Select the Display Selected Loops button on the right.

The system displays selected phases for each selected view side by side.

- To display all views for a specific phase:

Select the phase label (for example, Rest).





- To display all phases for a specific view:

Select the view label (for example, Long Axis).

The system displays all phases for the selected view. If fewer than four phases exist, then the system also displays phases for the next view.

- To display a loop in full-screen format:
 1. Select the loop to activate it.
The system outlines the loop in gray to indicate activation.
 2. Select the loop again.
The system displays the loop in full-screen format.
 3. To display the loop in its initial size, select the loop again.

Description of review mode pertinent keys (the keys with the same function as in select mode will not be described below):

Key	Description
Shuffle	Perform side by side comparison of same views by different stages (PSSA, PSLA, 4CH, 2CH at “Rest” compared to PSSA, PSLA, 4CH, 2CH “Post Exercise”). Clips are synchronized. Selection: On, Off
Shuffle Forward	Displays next view when that view is not deselected. (Available only when the Display Selected Loops button is disabled.)
Shuffle Back	Displays previous view when that view is not deselected. (Available only when the Display Selected Loops button is disabled.)
Display Selected	Display loops of all the stages and views selected.
Indication	Open the Indication page for patient indication.
Select Bookmarked	Select the dog ear controls on screen (a dog ear will appear on the right upper corner of the view if there is more than one loop for a view) or use the soft menu change/review the bookmarked views. One can quickly change to the various bookmark clips saved for each view.
	Toggle Play: play all loops.
 or	Start of sequence/ End of sequence: direct access to first/last loop in series.
 or	Step backward/Step forward: frame-by-frame loop review.
 or	Decrease speed/increase speed: decrease or increase playback speed.
	Sweeping play: continuous sweeping playback of loops forward-backward-forward.
Clip Length	Specifies loop segment of display (Full heartbeat, Systole, Diastole, User-defined, Fixed range).

6.5.1 Playing Back Loops

You can play back loops in the Stress Echo screen. By default, the system plays back

loops in the forward direction only, from beginning systole to end systole (end diastole to end systole). You can play back the loops in both directions, forward from beginning systole to end systole and then reversed from end systole to beginning systole. You can change the speed of playback and you can display a specific frame.

- To playback the displayed loops

1. Select (highlight) the Toggle Play toolbar button at the top of the screen.

The system plays the displayed loops in one direction, from beginning systole to end systole. When the last frame is played, the system restarts playback from the first frame.

2. To stop playing the displayed loops, select the Toggle Play toolbar button again.

- To playback the displayed loops in both directions (from diastole to systole and then back to diastole)

Select (highlight) the Sweeping play toolbar button at the top of the screen.

The system initially plays the displayed loops in one direction, from beginning systole to end systole. When the last frame is played, the system reverses the playback direction, playing the displayed loops from end systole to beginning systole.

- To change the playback speed

Select the Decrease Speed toolbar button or the Increase Speed toolbar button at the top of the screen.

- To display a specific frame in the loops

Select one of the following toolbar buttons at the top of the screen:

Start of sequence – displays the first frame of each loop.

Step backward – displays the previous frame of each loop.

Step forward – displays the next frame of each loop.

End of sequence – displays the last frame of each loop.

- To set the cine segment

Drag the inverted triangle on the cine slider. Click [Apply Edit All] and the edit is applied to all clips.

6.6 Wall Motion Scoring and Reports

The WMS-Report lists user-assigned wall motion scores and associated data. Reports contain the entered indication, if any; and report also contains any entered comments that are specific to the report. You can include or exclude data from specific phase(s). You can preview and print the report for the currently selected mode. You can also enable colored report printing in Maintenance.

Stress echo exam data and the reports can be sent to DICOM.

On the iStation page, if stress echo exam was performed on the patient, the patient exam record will be marked with a tick in the SE Exam list.

6.6.1 Entering Indications or Comments for the Reports

You can enter an indication for display in Stress Echo reports.

To enter an indication:

6-8 Stress Echo

1. Select [Indication] on the soft menu.
2. Use the keyboard to enter text into the Indication dialog box and then click [OK].

Besides, you can insert text for indication:

1. Select [Indication] on the soft menu.
2. Click [Insert Text] on the Indication dialog box to pop up the Select Text to Insert dialogue box.

3. Select the available texts.

Besides, you can:

- Edit a selected text by clicking [Edit].
 - Delete a selected text by clicking [Delete].
 - Create a new text by clicking [New].
 - Restore the factory-default texts by clicking [Default].
4. Select the text position and choose whether to insert the text in a separate line.
 5. Click [OK] to insert the text.

6.6.2 Wall Motion Scoring

The Wall Motion Score (WMS) measurement is an application prepared for assisting in stress echo semi-quantitative evaluations of abnormalities with left ventricular wall motion or changes in wall thickness. The left ventricle is divided into segments to score each segment to evaluate the degree of abnormality using the motion of the walls of entire left ventricle from the sum of scores in each segment. Scoring is displayed in the report.

You can assign wall motion scores to specific portions within each view (representative loop). You can also assign a normal wall motion score (WMS) to the currently selected view or to all displayed views.

ASE 16 and ASE 17 two methods of chamber segments divisions are supported. In addition, each segment can be done 4, 5 and 7 points scoring.

To activate Wall Motion Scoring Mode:

- Select the Wall Motion Scoring Mode toolbar button  at the top of the screen.
Or,
- Click [WMS] on the soft menu.

To assign a wall motion score (WMS):

1. Activate Wall Motion Scoring Mode.
2. Select a colored number in the lower-right area of the screen.

The signification and color used in segments are listed in the table below.

Score	Signification	Color
1	Normal	Green
2	Hypokinesis	Yellow
2.5	SevereHypokinesis	Khaki
3	Akinesis	Blue
4	Dyskinesis	Red
5	Aneurysm	Purple

3. Select a loop.

The system outlines the loop in gray to indicate selection.

4. Select the required portion of the WMS graphic that corresponds to the selected loop.
 - To assign a normal wall motion score (WMS) to all currently displayed loops:
Select the All Visible Loops Normal button on the lower right of the screen.
 - To assign a normal wall motion score (WMS) to the currently selected loop:
Select the Selected Loop Normal button on the lower right of the screen.
 - To switch the position of WMS schemas and the clips:
Select the Toggle Display button on the lower right of the screen to switch the position of WMS schemas and the clips.

6.6.3 Designating Stages for Inclusion in Reports

You can designate phase data for inclusion in or exclusion from a report.

The following information is always included in WMS-Reports: patient name, ID, BOD, gender, date of Stress Echo examination, and any user-entered indication or report-specific comment, wall-motion scores for each segment, along with the sum and average for each phase.

To include data for a specific phase:

1. Activate Wall Motion Scoring Mode.
2. Select (highlight) the printer graphic to the left of the phase.
3. To exclude the phase's data from the report, select the printer graphic again.

6.6.4 Previewing and Printing Reports

You can preview and print the report for the currently selected mode.

- To preview the report for the currently selected mode
The Report Preview toolbar button is available only when a printer driver is installed.
Select the Report Preview toolbar button at the top of the screen.
- To print the report for the currently selected mode
The Print toolbar button is available only when a laser printer is connected.
Select the Print toolbar button at the top of the screen.
To exclude stage's report from printing, click the printer icon (set it as gray in color) at the left side of the stage.

6.7 Maintenance and Protocol

6.7.1 Maintenance

You can access the Maintenance dialogue box by clicking [Maintenance] on the soft menu clicking the Maintenance toolbar button at the top of the screen. As shown in the figure below:

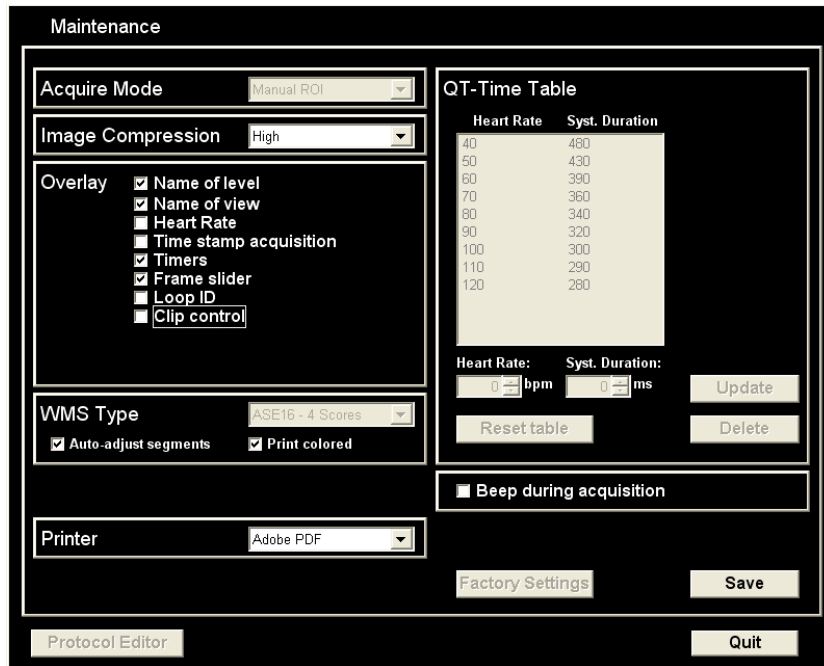

Item	Function Description
Acquire mode	Set the type of ROI: manual ROI or full-screen.
Image compression	Set image compression level.
Overlay	Select the items to be labeled on each loop.
WMS type	Set the methods of chamber segments division.
Printer	Set the printer used for report printing.
QT-Time Table	To customize the length of systolic duration acquired for a specific heart rate. You can add and remove entries in this table. You can also load the factory defaults.
Heart rate	Enter the heart rate.
Syst. duration	Enter the systolic duration.
Beep during acquisition	Set if to beep during the acquisition.
Reset table	To reset the QT time table.

QT-Time Table Operation:

- To add an entry:
Enter a heart rate and the referring systolic duration and then click [Update].
- To delete an entry:
Select the required heart rate and systolic duration pair from the QT – Time Table and then click [Delete].
- To load the factory defaults:
Select the [Factory Settings] button.

6.7.2 Protocol Edit

You can create, edit, and delete Stress Echo protocols using the Protocol Editor dialog box. Your changes will display in the Select Protocol to Load window the next time you activate the Stress Echo feature.

Access the Protocol Editor dialog box by clicking [Protocol] on the soft menu; or clicking [Protocol Editor] on the Select Protocol screen. As shown in the figure below:

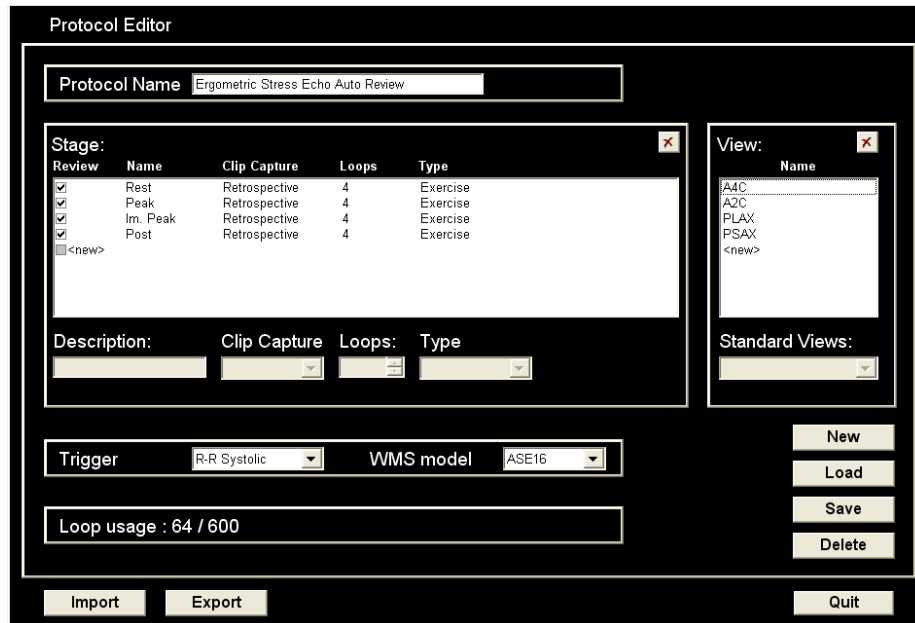

Item	Function Description
Protocol name	Enter the protocol name.
Stage	Set stages for the protocol.
Trigger	Set the trigger type.
WMS model	Set the methods of chamber segments division.
Loop usage	Displays the acquired loop number as well as the total usable loop number.
View	Set the views for the each stage.
Standard views	Set the standard view.
Import	Import a protocol.
Export	Export a protocol.
New	Create a new protocol.
Load	Load an existing protocol.
Save	Save the change (s) for the protocol.
Delete	Delete the protocol.
Quit	To remove the Protocol Editor dialogue box.

Creating a Stress Echo Protocol

To create a stress echo protocol:

6-12 Stress Echo

1. Click [New] button on the right of the Protocol Editor dialog box.
2. Enter the protocol name in the Protocol Name box at the top.
3. For each phase in the protocol:
 - (a) Select "new" in the Stage list.
 - (b) Enter a phase name in the Description box.
 - (c) Select the required option from the Clip Capture drop-down list.
 - (d) Select the number of loops to acquire (per view in the selected phase) in the Loops list (for non-continuous stages).
 - (e) Select the type: exercise or drug.
4. For each view (all views display for each phase):
 - (a) Select "new" in the View list.
 - (b) Select a standard view from the Standard View list.
5. Click [Save] to save changes and then click [Quit] to remove the Protocol Editor dialog box from the screen.

Editing or Deleting a Stress Echo Protocol

To delete a protocol:

Select the protocol or one of its component phases or views and then click [Delete].

To Edit a Stress Echo Protocol:

You cannot edit a protocol during Acquire Mode.

Method one:

1. Select the [Load] button on the right.
The system displays the Select Protocol to load window.
2. Select the protocol and then click [OK].
The system displays the name of the selected protocol in the Protocol Name box and lists the protocol's phases and views.
3. To change the name of the protocol, enter the required name in the Protocol Name box.
4. To change the name of a phase, select the phase and then enter the required name in the Description box.
5. To change the type of clip capture (continuous or retrospective), select the appropriate option from the Clip Capture drop-down list.
6. To change the number of loops acquired for each view in a phase, select the phase and then select the required number from the Loops list (for retrospective stages).
7. To change the type of stage, select exercise or drug in the drop-down list.
8. To delete a phase or view, select the phase or view and then press the key on the keyboard.
9. Click [Save] to save changes and then click [Quit] to remove the Protocol Editor dialog box from the screen.

Method two:

1. Click an available protocol on the Select Protocol screen.
2. Click [Protocol Editor] to enter the Protocol Editor screen.

3. Follow the steps 3-8 above to finish the protocol editing.

6.8 Saving Stress Echo Data

Stress Echo data consists of Stress Echo loops, wall motion scores, and all other information pertaining to the Stress Echo portion of a patient examination. You can save all acquired loops (all loops acquired for each view) or you can just save the preferred loops (the single representative loop for each view).

- To save all acquired loops

Select the Save Examination toolbar button.

The system saves the stress echo data, including all acquired loops, to the storage device designated in system presets.

- To save the preferred loops only

You must select preferred loops for the continuous stages before using this save method.

Select the Save Examination (only selected loops) toolbar button.

The system saves the stress echo data, with only the selected “preferred” loops, to the storage device designated in system presets.

6.9 Exiting the Stress Echo Feature

When you exit the Stress Echo feature, the system removes the display of the Stress Echo screen and displays the Patient Info screen for entering new patient information.

If later review of the stress echo data is required, then you must save the stress echo data before exiting the Stress Echo feature.

To exit the Stress Echo feature:

- Select the Exit toolbar button ; Or,
- Click [End] on the soft menu. The system removes the display of the Stress Echo screen. Or,
- Press <End Exam> key on the control panel.

6.10 Measurement

Suspend the stress echo exam by clicking [Suspend Exam] on the soft menu, press measurement related keys or buttons to enter cardiology measurement. For details, please refer to the [Advanced Volume].

7 Display & Cine Review

7.1 Image Display

7.1.1 Splitting Display

The system supports dual-split and quad-split display format. However, only one window is active at one time.

- Dual-split: press <Dual> key on the control panel to enter the dual-split mode, and using <Dual> key to switch between the two images; press on the control panel to exit.
- Quad-split: press <Quad> key on the control panel to enter the dual-split mode, and using <Quad> key to switch between the two images; press on the control panel to exit.

Imaging modes support splitting display: B mode, Color mode, Power mode, TVI mode, TEI mode.

7.1.2 Image Magnification

The system supports three magnifications: spot, pan and iZoom, which can be realized by different operations through the related keys.

<p>NOTE: Zooming an image changes the frame rate which tends to change thermal indices. The position of the focal zones may also change which may cause the peak intensity to occur at a different location in the acoustic field. As a result, the MI may change.</p>

7.1.3 Spot

Procedures:

1. In image scanning mode, press <Zoom> key to enter the sample volume definition status.
2. Define the sample volume: roll the trackball to change the box size and position, press <Set> to toggle between setting the size and position. And after sample volume is set, press <Zoom> key again to enter spot zoom status.
Here, the sampled image is displayed, and meanwhile, image-in-image is displayed.
3. Click [Magnify] on the soft menu to change the magnification factor. The system provides a zoom range of 1-10. Roll the trackball to move the magnified image.
4. Exit: in spot zooming status, press <Zoom> key again or press <Esc> to exit image magnification.

Tips:

- Spot zooming only can be realized on a scanning image.
- The size and position of sample volume box will be changed along with scanning depth and area.

7.1.4 Pan

Procedures:

1. Click [Magnify] on the soft menu to directly enter the pan zooming status; or press <Zoom> in freezing status. Image-in-image is displayed.
2. Click [Magnify] on the soft menu or rotate the multifunctional knob to change the magnification factor. The system provides a zoom range of 1-10.
3. Exit pan zooming: press <Zoom> knob; or press <Esc> key.

7.1.5 iZoom (Full-screen Zooming)

- Function: to magnify the image in full screen.

According to the region to be zoomed, the system supports two types of full-screen zooming:

- The first type is to zoom in the standard area, including image area, parameter area, image banner, thumbnail area and so on.
- The second type is to zoom in the image area only.

- Manner:

1. User-defined key setting:
 - (1) Enter "[Setup] → [System Preset] → [Key Config]".
 - (2) Select a function-free key in the function list.
 - (3) Select "iZoom" in the "Other" page.
 - (4) Click [OK] to complete the setting.
2. Open the image (or the under scanning image), press the user-defined iZoom key once to zoom in image in the way of the first type, and then press the key again to zoom in the image in the way of the second type.
3. Press the user-defined key again to return to normal status.

- In iZoom status:

Press any key of the soft menu controls, the soft menu will appear in the screen for image adjustment.

Measurements, adding comments and body marks are allowed in the status.

It is the currently zooming region that is used for video output, image saving and print functions.

Press <Exam>, <Patient>, <iStation>, <Review> or enter Report or Preset, the system will exit zoom status.

7.1.6 Freeze/ Unfreeze the Image

Press <Freeze> on the control panel to freeze a scanning image. In freeze mode, the probe stops transmitting acoustic power, and all images as well as the parameters are kept still.

Tip: after freezing an image, the system may enter cine review, measure, comment adding, or body mark mode, which is dependent upon preset. (Setting path: [Setup] → [System Preset] → [Image Preset] → "Freeze Config")

Press <Freeze> in freeze mode to unfreeze the image, the system continues image scanning.

7.1.6.1 Imaging Mode Switching When Frozen

Imaging mode switching in freeze mode follows the following principles:

- In splitting display B mode, press to exit splitting display mode and display the image of the currently activated window in full screen.
- In freeze mode, the system supports imaging mode switching between the sub-modes (only for the activated window). For example, if the frozen image is of B+C+PW mode, then the system supports imaging mode switching between B+C+PW, B+C, B+PW and B.
- The imaging mode and parameters of an unfrozen image is the same as the corresponding one that before frozen; but the display format is the same as the one before unfrozen.

7.1.6.2 Imaging Display Format Switching When Frozen

Image display format switching in freeze mode follows the following principles:

■ 2D+M/PW (Press <Freeze> in 2D+M/PW scanning mode)

If the imaging mode before frozen is 2D (frozen) +M/PW (real time) or 2D (real time) +M/PW (frozen), then in freeze mode, you can switch between 2D (frozen) +PW (activated) or 2D (activated) +PW (frozen) (2D(real time)+M(real time) or 2D(frozen)+M(real time)) by pressing <Update> key on the control panel.

■ Dual/quad splitting display mode (Press <Freeze> key in dual/quad splitting display mode)

- When enters freeze mode, the default activated window is the real-time window before frozen. Other image windows display the corresponding cine memories, if a certain cine memory is empty, then no image is displayed.
- Press <Dual> or <Quad> to switch between dual-splitting and quad-splitting modes.
- Press button on the control panel to enter the single display format, which displays the currently activated window. In single display format, press <Dual> or <Quad> to switch between dual-splitting and quad-splitting mode.
- Unfrozen: in splitting display status, when you unfreeze the image you can only unfreeze the image in the activated window, other images still keep frozen. In single-window display status, the system displays single image after being unfrozen.

7.2 Cine Review

After you press <Freeze>, the system allows you to review and edit the images prior to the image frozen. This function is known as cine review. The magnified images can also be reviewed after <Freeze> is pressed, and the operating method is the same. You can perform post process operations, measurements, comments adding and body marks on the images being reviewed.

The system supports manual review as well as automatic review. The default mode is Manual Cine, but you can switch between Auto Cine and Manual Cine.

In addition, the system supports the images reviewed along with physiological waveforms, if the detection of physiological waveforms is performed.

<p>⚠ CAUTION:</p>	<ol style="list-style-type: none"> 1. Cine Review images can be inadvertently combined in-between separate patient scans. The cine memory must be cleared at the end of the current patient and the onset of the next new patient by selecting the <End Exam> key on the control panel. 2. Cine files stored in the system's hard drive shall contain patient information, to avoid the selection of an incorrect image file and potential misdiagnosis.
--------------------------	--

7.2.1 Entering/ Exiting Cine Review

- To enter cine review:
 - Enter "[Setup] → [System Preset] → [Image Preset]" and set "Status after Freeze" to be "Cine". Press <Freeze> to freeze the image and enter the cine status, the <Cine> key indicator lights on automatically.
 - Open cine files in thumbnail, iStation or Review, the system enters automatic cine review status.
- To exit cine review:
 - Press <Freeze> key again, the system will return to image scanning and exit cine review.
 - Press <Cine> or <Esc>, the images are still frozen but the system exits cine review.

7.2.2 Cine Review in 2D Mode

■ Manual cine review

After entering the cine review of 2D mode, rolling the trackball or rotating the multifunctional knob will display the cine images on the screen one by one.

If you roll the trackball to the left, the review sequence is reversed to the image-storing sequence, thus the images are displayed in descending order. Whereas, if you roll the trackball to the right, the review sequence is the same as the image-storing sequence, thus the images are displayed in ascending order. When the reviewing image reaches the first or the last frame, further rolling the trackball will display the last or first frame.

The cine progress bar at the bottom of the screen (as shown in the figure below):

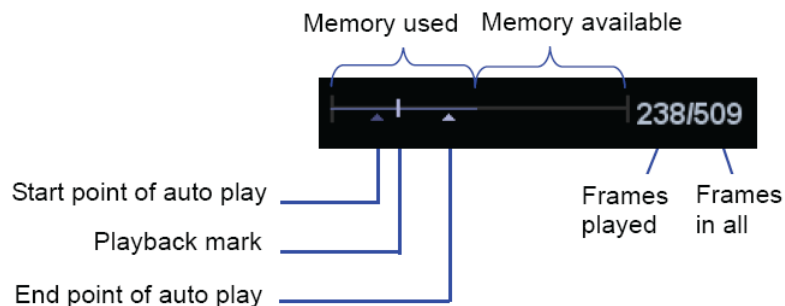

■ Auto Review

● Reviewing all

- a) In the manual cine review status, click [Auto Play] in the soft menu to activate auto cine review.
- b) Reviewing speed: In the auto cine review status, click [Auto Play] in the soft menu to adjust the review speed. The available values are $\times 0$, $\times 1/10$, $\times 1/5$, $\times 1/4$, $\times 1/3$, $1/2$, $\times 1$, $\times 2$, and $\times 3$.
- c) In auto review status, Click [Auto Play] to be 0, or roll the trackball to enter manual review, or press <Cine> to exit cine reviewing.

● Setting Region of Auto Review

You can set a segment of cine loop which can be reviewed automatically. After the auto review region is set, the auto cine review can only be performed within this region; but the manual cine review can be performed beyond this region. When the cine file is saved, only the images within this region are saved.

- a) Set first frame: Manually review the images until the frame which you want to set it as start point, and then click [Set First Frame] to set it as the start point.
- b) Set end frame: Manually review the images until the frame which you want to set it as end point, and then click [Set End Frame] to set it as the end point.
- c) Use the soft menu control to click [Auto Play] to set the value (except 0), then the system enters the auto cine status, and use this control to adjust speed.
- d) Click [Auto Play] again or roll the trackball to enter manual review status; or press <Cine> to exit cine reviewing.
- e) Click [Skip to First]/ [Skip to Last] to review the first or last image.
- f) Click [Save Cine] in the soft menu to save the cine images of the set region.

Tips: you can perform cine review on each image window in the dual/ quad splitting mode.

You can also press <Menu> to see the menu, and use the corresponding items to do the above settings.

7.2.3 Cine Review in M or D Mode

Enter cine review in M or D mode, and then roll the trackball or rotating the multifunctional knob, the cine images are displayed on the screen one by one.

Roll the trackball to the left, the review progress slider moves to the left, the images moves to the right, and the earlier stored images are invoked. Whereas roll the trackball to the right, the review progress slider moves to the right, and the images move to the left, the recently stored images are invoked. When you review the images until the earliest or the latest frame, further rolling the trackball will display the last or first frame.

The cine progress bar at the bottom of the screen (as shown in the figure below):

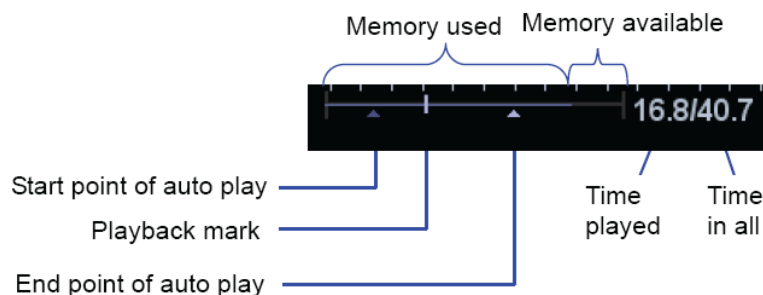

Cine review operations are the same as those of 2D mode.

7.2.4 Linked Cine Review

The linked cine review refers to review of the images captured at the same moment.

- Dual live mode(B+C)
- B+M
- PW+B duplex mode
- PW+C+B triplex mode

There displays the frame mark  on the time mark of M/PW image indicating the current 2D image. In statuses other than duplex or triplex mode, you can only review images of the currently active window, use the <Update> to switch the window (if it is in Dual-split or Quad-split window, use <Dual> or <Quad> key).

1. Click [Cine Compare] to be "On" to enter the windows of different frames.
2. Roll the trackball or rotate the multifunctional knob to review the images; switch the window by pressing <Update>.
3. Click [Cine Compare] again to exit cine compare or press <Freeze> to exit cine review state.

Tips: cine compare can only be performed on single-format 2D images only.

7.3 Image Compare

7.3.1 Cine Compare

1. Select the image files to be compared: click two or more than two image files of the same exam or exams of the same patient.
2. Click [Compare] to enter into image compare mode.
3. Review the images of different image windows (cine replaying can't be performed for single-frame image file), press <Update> key to switch the active image window, and roll the trackball to review the images.
 - If two image files are to be compared, the screen displays in dual-split mode when come into image compare.
 - If more than two image files are to be compared, the screen displays in quad-split mode when come into image compare.
 - For image compare of more than 4 image files, you can first select an image window, and double click a thumbnail, and then the image will be displayed in the selected image window.
 - Switch to single, dual, or quad mode by pressing , <Dual> key, or <Quad>.
4. Adjust the image parameters or do other operations (like image zoom in/zoom out, comment) if necessary.
5. Save the image.

In non-single display format, image will be saved in BMP-format; in single display format, FRM image will be saved in FRM-format, and CIN image file will be saved in CIN-format.
6. Click [Return] or press <Freeze> to exit image compare.

7.3.2 Frame Compare

1. Click [Frame Compare] to be "On" to enter the windows of different frames.
2. Roll the trackball or rotate the multifunctional knob to review the images; switch the window by pressing <Update>.
3. Click [Frame Compare] again to exit cine compare or press <Freeze> to exit cine review state.

Tips: cine compare can only be performed on single-format 2D images only.

7.4 Cine Saving

In freeze mode, click [Save Cine] in the soft menu or menu to save the cine.

After the cine is successfully saved, there is a thumbnail displayed on the screen.

You can also perform cine saving by set user-defined shortcut keys: [Setup] → [System Preset] → [Key Config]. (For details, please refer to "15.1.7 Key Config")

7.4.1 Review Play

The system provides auto-play of cine file in the review screen.

1. Activate the feature by selecting "Dyn Thumbnail" in the path: [Setup] -> [System Preset] -> [General].
2. Enter Review screen.
3. Select different values for "Layout" to change cine file display.
4. Select "Play Speed": fast, medium and slow.

7.5 Live Capture

Live capture refers to save images or cines in image scanning status, and after the storage, the system continues image scanning.

Live capture can be divided into 2 kinds: retrospective and prospective saving.

Retrospective saving is to save the specified images before the current moment, that is to save the images stored in the cine memory to the system hard disk. Prospective saving is to save the specified images later than the current moment, that is to save the images to both the cine memory and the system hard disk.

To perform a live capture:

- In scanning mode, press the user-defined key for live capture (for user-defined key setting, please refer to "15.1.7 Key Config").

Tips:

- In retrospective saving, if any parameter is modified during saving, the changes will not be saved to the cine. While in prospective saving, any parameter modification before the saving finished can be saved into the cine.
- If you press the user-defined key for saving or <Freeze> again during cine saving process, the cine saving is cancelled.

- There is sound feedback after a saving is completed; meanwhile, a thumbnail is showed in the Thumbnail area. If the saving fails, please pay attention to the help information.
- If you perform any operation that will clear the cine memory during the cine saving process, the cine saving is cancelled. (Refer to 7.6 Cine Memory for details).

7.6 Cine Memory

7.6.1 Cine Memory Setting

There are 2 ways of cine memory split: auto and split.

Setting path: select "Auto" or "Split" for cine memory in [Setup] → [System Preset] → [Image Preset].

Where,

- "Auto" for the cine memory indicates the system splits the cine memory as per the number of B image windows.
- "Split" indicates the system always splits the cine memory, even if in the single-B window, the system splits the cine memory into two as well. You can press key to switch and display the images in either memory, so you can compare images in Split mode.

The memory capacity is evenly distributed as per splitting number, as shown in the following table (Taking B images in low density as an example, the capacity of B cine memory is N frames):

Imaging Mode \ Split	Single-B/ Color	Dual	Quad
Auto	One memory, with capacity N frames.	The memory splits into two, with capacity N/2 frames each	The memory splits into four, with capacity N/4 frames each
Split	The memory splits into two, with capacity N/2 frames each	The memory splits into two, with capacity N/2 frames each	The memory splits into four, with capacity N/4 frames each

7.6.2 Cine Memory Clear

In the following conditions, the cine review memory will be cleared:

- Start an exam of a new patient.
- Start a new exam for the same patient.
- Switching the probe (if the cine memory is split, only the cine memory corresponding to the currently activated window is cleared)
- Changing the exam condition (if the cine memory is split, only the cine memory corresponding to the currently activated window is cleared)
- Switching in some imaging mode: include imaging mode switching among B, M, Color, PW, Power, rescanning imaging in iScape, and image re-acquisition in 3D/4D, display mode switching etc.

- Parameters modification, including:
 - Parameters that can result in imaging region or direction changing, such as depth, FOV, trapezoid, steer, zoom and so on.
 - Parameters that can result in image frame changing, such as line density, focus number and so on.
 - Change ROI position and size.
 - Change speed in M/D mode, or change the scale in PW mode.
 - 2D image cleared/
- Unfreeze the image: after the image is unfrozen, images stored in the cine memory will be cleared, but if the cine memory is split, only the currently cine memory corresponding to the activated window will be cleared.
- Open/ close the image file that occupies cine memory.

7.7 Cine Settings

You can set the cine length via “[Setup] → [System Preset] → [General]”. The items are shown as follows:

- Non-live storage
 - For Time without ECG(s), 1~60s, the default is 5s.
 - For Time (with ECG Loop): the unit is Beat, 1~16, the default is 5.
- Live capture
 - Type: Retrospective, Prospective.
 - Cine length.

8 ECG

The system can be configured with the optional ECG module. In that case, the ECG signal is displayed on the image, and can be reviewed simultaneously with the image.

- When the system is connected with the ECG module:
 - The Physio menu is available.
 - The ECG icon including heart-shaped symbol and heart rate symbol are displayed on the screen.
- The system supports ECG signal from ECG lead or external ECG signal devices.
 - Use DC-IN to connect to the external ECG signal devices.



WARNING:

1. **DO NOT use the physiological traces for diagnosis and monitoring.**
2. **To avoid electric shock, the following checks shall be performed prior to an operation:**
The ECG electrode cable shall not be cracked, frayed or show any signs of damage or strain.
The ECG electrode cable shall be correctly connected.
You should use the ECG leads provided with the ECG module. Otherwise it may result in electric shock.
3. **The ECG electrode cable must be connected to the system first. Only after the cable is connected to the system, can the patient be connected to the ECG electrodes. Failure to follow these instructions may subject the patient to electric shock.**
4. **DO NOT place the ECG electrodes directly in contact the patient's heart; otherwise it may lead to stop of the patient's heartbeat.**
5. **DO NOT apply the ECG electrodes if the voltage exceeds 15 volts. This could produce an electric shock.**
6. **Before using high frequency electric surgical unit, high frequency therapeutic equipment or defibrillator, be sure to remove the ECG electrode from the patient, in order to prevent electric shock.**
7. **Conductive parts of electrodes and associated connectors for ECG should not contact other conductive parts including earth/grounding.**
8. **Frequent trampling or squeezing on the cables may result in cable break-down or fracture.**

NOTE: When abnormality is detected in physio trace, please check if ECG leads are properly connected with the system.

8.1 ECG Operation Basic Procedures

1. Connect the ECG device.

Set ECG parameters if necessary.

- Turn off the power supply of the system, and connect the ECG module to the system (For connection, please refer to “2.8 Extend Modules”)
- Turn on the power supply of the system
- Place the ECG electrodes on the patient’s body (as shown in the following figure)

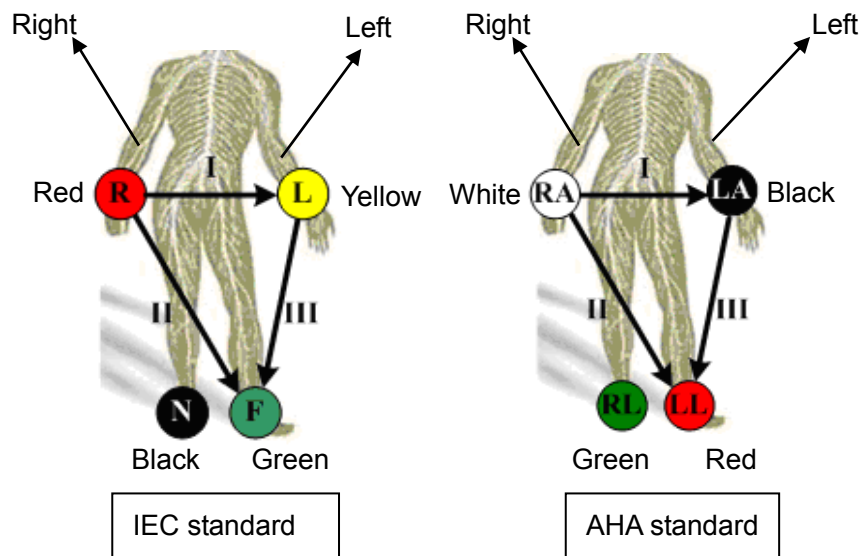

2. Enter physio operation status:
 - Press ECG user-defined key (set in “[Setup] → [System Preset] → [Key Config]”).
 - Move the cursor to the menu; navigate the cursor onto [Physio] and press <Set> or the multifunctional knob.
3. Select [ECG] to be “On”, and the heart-shaped symbol appears on the upper right part of the screen.
4. Switch the imaging modes and display formats, and adjust relevant parameters to optimize the image.
5. Parameter adjustment:

On the Physio page, you can adjust [Speed], [ECG Gain], [ECG Pos].
6. Freeze the images and review them. For details, please refer to “8.4 ECG Review”
7. Exit ECG mode, and remove ECG electrodes from the patient.

In ECG mode, set [ECG] to be “Off”, the ECG waveform disappears and the system exits ECG mode.

8.2 ECG Setting

■ Parameter preset

Enter “[Setup] → [Image Preset] → Physio” to preset the ECG mode parameters.

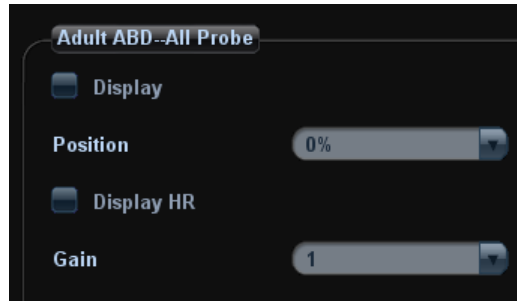

■ Menu Preset

Click [Menu Preset] in the Image Preset screen to enter the menu preset page, and click “Physio” page tab to go for the setting.

Parameter	Description
Display	Function: to set if to display ECG trace on the screen.
Position	Function: to set the vertical position of the ECG trace on the image display. Value: 0%-100%, in increments of 5%.
Display HR	Function: to set if to display patient heart rate on the screen.
Gain	Function: to set the amplitude of ECG trace. Value: 0-30, in increments of 1.

8.3 Parameter Description

Parameter	Description
ECG	Function: to control the display of ECG trace in live status. Value: On/Off, On is to display the trace, while Off is to hide the trace. In scanning mode, turn off ECG display will stop ECG signal acquisition. In freeze mode, this is used to show or hide the ECG trace.
ECG Gain	Function: to set the amplitude of ECG trace. Method: click [Gain] in the soft menu or menu. Value: 0-30, in increments of 1.
ECG Position	Function: to set the vertical position of the ECG trace on the image display. Method: click [ECG Pos] in the soft menu or menu. Value: 0%-100%, in increments of 5%.
Speed	Function: change the speed of the physio trace. Value: 1-4 The refresh speed of the physio signal on B image is independent from the refresh speed of timeline refresh speed (M mode, PW and CW mode)

8.4 ECG Review

When an image is frozen, the ECG waveform will be frozen at the same time. When images are reviewed with the ECG electrodes connected, the ECG waveform is the reference for time.

After the images are frozen, all real time images are in the status of linked review.

The frame position marker indicates the time relationship between the currently reviewed 2D image and the ECG trace or M/D image.

9 Measurement

You can perform measurements on a zoomed image, cine reviewing image, real-time image, or frozen image. For measurements details, please refer to the [Advanced Volume].

 WARNING:	<ol style="list-style-type: none">1. Be sure to measure areas of interest from the most optimal image plane to avoid misdiagnosis from inaccurate measurement values.2. To obtain accurate Doppler flow measurement values, make sure the transmitting beam is not perpendicular to the flow, otherwise false readings and potential misdiagnosis may result.
---	--

 CAUTION:	<ol style="list-style-type: none">1. If an image is unfrozen or the mode is changed during a measurement, the calipers and measurement data will be cleared from the screen. The general measurement data will be lost (the application measurement data are stored in the report).2. If the system is turned off or <End Exam> is pressed during a measurement, the data not saved will be lost.3. In Dual-B imaging mode, the measurement results of the merged image may be inaccurate. Therefore, the results are provided for reference only, not for confirming a diagnosis.
---	--

9.1 Basic Operations

- To enter/ exit measurement
Press the user-defined key for caliper (refer to "15.1.7 Key Config" for user-defined key setting) to enter general measurement.
Press <Measure> key to enter application measurement.
Press <Caliper> (user-defined) key or <Measure> key again to exit.
- Measurement result and help information
The system displays and updates measurement results in the result window.
The help information concerning measurement and calculation is displayed in the Help Information area at the bottom of the screen.

9.2 General Measurements

9.2.1 2D General Measurements

2D general measurements refer to general measurements on images of B, Color, Power or iScape imaging modes. The measurements listed below can be performed:

Measurement Tools	Function
Distance	Measures the distance between two points of interest.
Depth	The distance between probe surface and the probing point along ultrasound beam.
Angle	The angle between two intersected planes.
Area	Measures the area and perimeter of a closed region.
Volume	The volume of a target.
Cross Line	The length of two line segments, which are perpendicular to each other.
Parallel Line	The distance between each pair of parallel lines in a sequence.
Trace Length	Measures the length of a curve on the image.
Distance Ratio	Measures the lengths of any two line segments and the calculated ratio.
Area Ratio	The areas of any two regions and the calculated ratio.
B histogram	The grayscale distribution of ultrasonic echo signals in a closed region.
B profile(not available for M7T)	The grayscale distribution of ultrasonic echo signals across a line.
Color Velocity	Color flow velocity (only valid for Color mode).
VF Diam	Measures the distance between two points on the image to obtain the vessel flow diameter.

9.2.2 M General Measurements

M general measurements refer to general measurements on M mode, Color M mode, Free Xros M mode images. The measurements listed below can be performed:

Measurement Tools	Function
Distance	The vertical distance between two points.
Time	The time interval between any two points.
Slope	Measures the distance and time between two points and calculates the slope.

Measurement Tools	Function
HR	Measures the time of n ($n \leq 8$) cardiac cycles and calculates the heart rate in M mode image.
Velocity	Calculates the average velocity by measuring the distance and time between two points.

9.2.3 Doppler General Measurements

Doppler general measurements refer to general measurements on PW/CW mode images. The measurements listed below can be performed:

Measurement Tools	Function
Time	The time interval between any two points.
HR	N intervals ($n \leq 8$) are measured to calculate a PW mode derived HR value in Beats Per Minute (BPM).
D Velocity	On the Doppler mode image, measure velocity, PG (pressure gradient) and spectrum correction angle of a point on the Doppler spectrum waveform and etc.
Acceleration	Measure the velocities of two points and their time interval on the Doppler image, and calculates the acceleration, pressure gradient, velocity difference and correction angle.
D Trace	On the PW mode image, one or several Doppler waveforms are traced to obtain speed and PG, etc.
PS/ED	Measure the Peak Systolic (PS) velocity and End Diastolic (ED) velocity on the Doppler spectrum, and calculates resistance index (RI), S/D and correction angle.
Vas Area	Measures the area of vessels on the image.
Velocity Ratio	Measure two D velocity values on one or two spectrum and calculate the ratio to analysis the flow information.
VTI Ratio	Measure two VTI values on the spectrum and calculate the ratio.

9.3 Application Measurement

The system can be configured with the following application measurement packages corresponding to the application packages (refer to "2.5 System Configuration" for details):

- Abdomen measurements - Used for measurements of abdominal organs (liver, gall bladder, pancreas and kidney, etc.) and large abdominal vessels.
- OB measurements- Used for measurements of fetal growth indexes (including EFW) as well as GA and EDD calculations. The fetus can be evaluated through growth graph analysis and fetal biophysical profile.
- Cardiac measurements- Used for left ventricle function measurements and measurements of main artery and vein parameters, etc.
- Gynecology measurements - Used for the uterus, ovary and follicles, etc.
- Small Part measurements – Used for small parts such as thyroid.
- Urology measurements - Used for prostate, seminal vesicle, renal, adrenal, micturated and testicle volume.
- Orthopedics measurements - Used for hip joint measurement.
- Peripheral vessel measurements – Used for carotid, cerebral, upper and lower extremities vessels, etc.
- Emergency measurements – Used for measurements of emergency applications.

9.4 Measurement Accuracy

Table 1 Error of 2D Images

Parameter	Value Range	Error
Distance	Full screen	Within $\pm 3\%$; or when the measured value is less than 40 mm, the error is less than 1.5 mm.
Area (Trace)	Full screen	Within $\pm 7\%$; or when the measured value is less than 16 cm ² , the error is less than 1.2 cm ² .
Area (ellipse, circle)	Full screen	Within $\pm 7\%$; or when the measured value is less than 16 cm ² , the error is less than 1.2 cm ² .
Angle	Full screen	Within $\pm 3\%$.
Circumference	Full screen	Within $\pm 10\%$.

Table 2 Volume Measurements

Parameter	Value Range	Error
Volume	Full screen	Within $\pm 10\%$; or when the measured value is less than 64 cm ³ , the error is less than 6.4 cm ³ .

Table 3 Time/Motion Measurements

Parameter	Value Range	Error
Distance	Full screen	Within $\pm 3\%$; or when the measured value is less than 40mm, the error is less than 1.5mm.
Time	Timeline Display	Within $\pm 2\%$.
Heart rate	Timeline Display	Within $\pm 4\%$.

Table 4 Doppler Velocity Measurements

Parameter	Value Range	Error
Velocity (PW mode)	10-200cm/s (for 6C2s, L7-3s, P7-3s, V10-4s, V10-4Bs, 7L5s, L12-4s, 7L4s, 7LT4s, P7-3Ts, C11-3s, L16-4Hs) 10-150cm/s (for L14-6s, L14-6Ns, P12-4s) 10-300cm/s (for C5-2s, P4-2s, 4CD4s, SP5-1s)	When angle $\leq 60^\circ$, $\leq 5\%$.
Velocity (CW mode)	10-300cm/s (for P12-4s, P4-2s, P7-3s, P7-3Ts)	When angle $\leq 60^\circ$, $\leq 5\%$.

The above measurements are not applicable for the pencil probe (CW2s and CW5s).

Table 5 Contrast Measurements

Probe Type	Max. Depth(cm)
C5-2s	≥ 12 cm

Table 6 Elastography Measurements

Probe Type	Max. Depth(cm)	Spatial Resolution	Accuracy of Geometric for the Lateral
L12-4s	$\geq 30\text{mm}$	$\leq 10.5\text{mm}$	within $\pm 20\%$
L14-6Ns	$\geq 30\text{mm}$	$\leq 10.5\text{mm}$	within $\pm 20\%$

NOTE: Within the selected field range, the measurement accuracy is ensured within the range mentioned above. The accuracy specifications are performance in the worst conditions, or based on the real test for the system, regardless of acoustic speed error.

10 Comments and Body Marks

10.1 Comments (Annotations)

Comments can be added to an ultrasound image to bring attention, notate or communicate information observed during the examination. You can add comments to: zoomed image, cine review image, real-time image, frozen image. You can type the character as comments; insert the pre-defined comments from the comment library; insert arrow markers, or trace a graphics.

 **WARNING:** You must ensure that the entered comments are correct. Incorrect comments may cause misdiagnosis!

10.1.1 To Add Comments

1. To enter comment status:
 - Press the <Comment> key, and the cursor becomes “[”.
 - Press any alphanumeric key, and the corresponding letter or numeral is displayed besides the cursor.
 - Press the <Arrow> key to enter the arrow-adding status.

Tips: when the system entered comment status, the default characters entered are uppercase. You can see the <Caps Lock> indicator lights on.

2. Place the cursor to the desired place to set the comment location. Add new comment to the image according to actual situation. Here, you can modify, move, delete, hide or display the completed comments.
3. To exit comment status:
 - In the comment status, press <Comment> key.
 - Or press <ESC> or other operating mode keys, such as <Measure> etc.
 - In the arrow-adding status, press the <Arrow> key.

10.1.2 Comment Menu

You can adjust relevant settings in comment status via menu or the soft menu.

- Display or hide the soft menu

After entering the comment status, pressing the <Menu> key or the multifunctional knob will show or hide the Comment Text Library menu.

- Home of comments

Move the cursor to the desired location for a comment and click [Set Home]. The current position of the cursor is set to be the default position of the comment adding. When clicking [Home], the cursor will return to the default setting position.

Assign the user-defined key for the set home function in “[Setup] → [System Preset] → [Key Config]”.

- Change Font Size/Arrow Size

- Click [Font Size] to change the font size of comment: Small, Mid, Big.
- Click [Arrow Size] to change the arrow size of comment: Small, Mid, Big.

- Navigating through comment libraries

- Press <Menu> to show the comment menu, and select the menu title to change the comment library (the available ones are those customized libraries for all the exams assigned to the current probe). See the screen below:

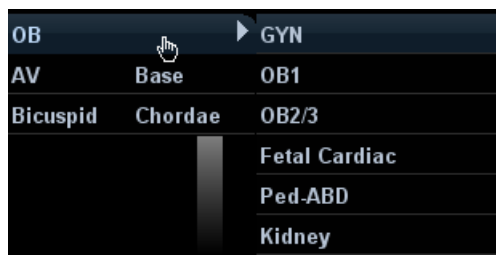

- Click [Library] on the soft menu to change among comment text libraries (the available ones are those customized libraries for all the exams assigned to the current probe). The default is the customized comment text library in the current exam mode.

When entered the comment status, the system displays the customized comment text library for the current exam. If there is no customized comment text library for the current exam, it will display the comment text libraries of all the exam modes assigned for the current probe. And if no text library for all the exam modes is customized, no comment text will be displayed.

Please refer to “15.6 Comment Preset” for comment preset for the specific exam mode.

- ABC Display

Click [ABC Display] to display or hide the added comments. Assign the user-defined key for the function in “[Setup] → [System Preset] → [Key Config]”.

- Set comment language

Click [English] to turn on or off the English comments. If “English” is turned on, the comments will display in English; if turn off, the comments will display in the language you set.

If the current language is English, this selection is not available.

- Trace

Click [Trace] to enter the trace commenting status.

10.1.3 Adding Comments

The system can be configured with comment text libraries including Abdomen, Cardiology, GYN (Gynecology), OB (Obstetrics), Urology, SMP (Small Part), Vascular, PED (Pediatric) Nerve Blocks and EM (Emergency). For details, please refer to “2.5 System Configuration”

■ Typing comment characters

1. To set the comment location:

Roll the trackball or press directional keys on the control panel to move the cursor to the desired location for comments.

2. To type the alphanumeric characters:

- Type the alphanumeric characters through the qwerty (The default characters are uppercase).
- To type the upper characters, press <Shift> on the control panel and the character key at the same time.

3. Move to a new line:

In the edit status (the characters are in green color), press <Enter> to move the cursor to the new line, and the location of the cursor is aligned with that of the first line.

4. In the edit status, move the trackball or press the multifunctional knob to confirm the character added, and the color of the character added turns yellow.

■ Adding a Comment Text

Move the cursor onto the desired comment text in the menu and press <Set> or the multifunctional knob, and then the system adds the selected comment text on the set location. The added comment text is in the edit status, so you can edit the comment text added.

- Add combined comment
 - a) Press <Menu> or the multifunctional knob to show the menu.
 - b) Rotate the multifunctional knob to view the comments one by one
 - c) Press the knob again to add the selected item onto the image (comment added in an editable state)
 - d) Rotate the multifunctional knob to search for the next part, and press the knob again to add the second part of the combined comment.
 - e) Repeat procedures to add other parts of a combined comment.
 - f) Press <Set> to complete the comment.

■ Adding an Arrow

You can add an arrow to a location where you want to pay attention.

1. Press the <Arrow> key, and an arrow will appear at the default position.

2. Adjust the arrow

- Adjust the position and orientation of the arrow: roll the trackball to the desired position and use the multifunctional knob to change the orientation in 15° increments.
- click the [Arrow Size] item on the soft menu to change the arrow size:

3. Press <Set> or <Enter> to anchor the arrow position, and then the arrow turns yellow.

4. Repeat the above steps to add more arrows if necessary.

5. Press <Arrow> key, <ESC> or to exit the arrow comment status.

■ Trace

1. In the comment status, click [Trace] to activate trace.

2. Roll the trackball to move the cursor to a desired position and press <Set> to confirm the start point.

3. Roll the trackball to move the cursor along the edge of the desired region and trace the outline of the region.

- Rotate the multifunctional knob anticlockwise, to cancel trace of 1 pixel.
- Rotate the multifunctional knob clockwise, to restore trace of 1 pixel.



- Press <Clear> to clear the trace(s).
- 4. Press <Set> to finish a tracing.
- 5. Click <Trace> again to exit the status.

10.1.4 Moving Comments

1. Move the cursor onto the comment that needs to be moved. Press <Set> to select it, and a highlighted box appears around the comment.
2. Roll the trackball to move the comment to the new position.
3. Press the <Set> key to anchor the comment in the new position, and the comment-moving operation is complete.

10.1.5 Modifying (Editing) Comments

■ Modifying (Editing) characters

1. In the comment status, move the cursor onto the comment that needs to be modified:
 - Directly enter the character at the position that the cursor stays; or,
 - Double press the <Set> key to enter the edit status, use the  or  key to move the cursor to a location where needs to insert characters, and type characters.
2. Press the key to delete the comment character or text on the right side of the cursor; Press the <Backspace> key to delete the comment character or text on the left side of the cursor.
3. Roll the trackball or press the <Set> key or the multifunctional knob to confirm the modification and to exit the edit status, and the color of the comments turns yellow.

■ Modifying (Editing) Arrows

1. Move the cursor on the arrow that needs to be modified. After the cursor turns to , press the <Set> key. The color of the current arrow turns green, and there is green frame around the arrow, indicating the arrow can be edited. Move the cursor to change the arrow position.
2. Rotate the multifunctional knob to modify the arrow direction.
3. Press the <Set> key or the <Enter> key to complete the operation.

10.1.6 Deleting Comments

■ Deleting Comment Characters, Texts or Arrows

1. Move the cursor to the comment to be deleted.
2. Press the <Set> key to select the comment.
3. Press the or <Back> key to complete the deleting operation.

■ Deleting a recently-added character, text or arrow

After you add several comments and the cursor is in the “|” or “↖” status, pressing <Clear> can delete the recently-added or recently-edited comment.

■ Delete word

Click <Delete Word> to delete the word in the reserved order. You can also assign the user-defined key for the function in “[Setup] → [System Preset] → [Key Config]”.

- Delete all comments (characters, texts or arrows)

Click [Erase All Text] to delete all the comment items on the screen. You can also assign the user-defined key for the function in “[Setup] → [System Preset] → [Key Config]”.

Or, press and hold the <Clear> to delete all the comments.
- Clear comments automatically

It can be set if to clear the comment when the image is unfrozen or the probe or exam is changed. The setting path is: “[Setup] → [System Preset] → [Comment]”.

NOTE: 1. When no object is selected, pressing the <Clear> key will clear all comments and all measurements calipers.

2. After powering off, the system will clear all comments on the image.

10.2 Body Marks (Pictograms)

The Body Mark (Pictogram) feature is used for indicating the exam position of the patient as well as probe position and orientation. The system can be configured with body mark libraries including Abdomen, Cardiology, GYN (Gynecology), OB (Obstetrics), Urology, SMP (Small Part), Vascular, EM (Emergency) and Nerve. For details, please refer to “2.5 System Configuration”. You can preset body marks for specific exam modes, customize the body marks and import/ export the body marks.

10.2.1 Soft Menu for Body Marks

The body mark soft menu displays the settings for the current mode:

- Library

Click [Library] to switch the body mark library, the corresponding body marks are shown at the bottom of the image.

- Display

Set [Display] to be “On” or “Off” to turn on or off the body mark display.

- Page-turning

If there is more than one page of the body marks, click [Page Down]/ [Page Up] to turn pages.

- Current BM (Body Mark)

The Current BM (Body Mark) has two statuses, “1st” and “2nd”. The Current BM 1st is default.

If you want to add two body marks onto an image, after you add the first body mark, you should select [Current BM] to be 2nd and then add the second body mark.

10.2.2 Adding Body Marks

- To add the first body mark:

1. Press <Body Mark> to enter the body mark status. Select the body mark group through the [Library].
2. Move the cursor onto the desired body mark to highlight your choice (See the figure below).



3. Press <Set> to confirm the selection.
4. To adjust the probe position and orientation marker:
 - Roll the trackball to place the probe marker at the correct position.
 - Rotate the multifunctional knob to adjust the orientation.
 - Press the <Set> key to confirm the position and orientation of the probe marker and exit the body mark mode.
- To add a second body mark after the first body mark is added:

Set the type for the second body mark (the types of the two should be different). E.g. the first body mark was added as "1st" in the [Current BM], and then the second body mark should be "2nd".

 1. Set the [Current BM] to be "2nd".
 2. Add the second body mark according to the steps previously noted for the 1st body mark as above.

10.2.3 Moving Body Marks

You can move the body mark graphics to any desired position within the image area.

1. Roll the trackball to move the cursor onto the body mark. The cursor changes into , indicating you can move the pictogram to a new position.
2. Press <Set> key to select the body mark, and a frame will appear around the graphics.
3. Roll the trackball to move the body mark to the desired position.
4. Press <Set> to anchor and confirm the new graphics position.

NOTE: In Dual B Mode, a body mark cannot be moved between the separated image windows.

10.2.4 Deleting Body Marks

- To delete a body mark
 1. Use the trackball to position the cursor on the body mark graphic and Press <Set> to select.
 2. Press <Clear> to delete the selected body mark.

NOTE: In the Body Mark mode, if no object is selected, pressing the [Clear] key will clear all comments, body marks and general measurements from the screen.

Tips:

- Powering off, preset returning, switching the exam/ patient/ mode/ probe will clear the body marks.

11 Patient Data Management

An exam record consists of all information and data of one exam.

An exam record consists of the following information:

- Patient basic information and exam data
- Image files
- Reports

NOTE:

1. DO NOT use the internal hard drive for long-term image storage. Daily backup is recommended. External storage media is recommended for image archive.
2. The system patient database space is limited, please back up or clear patient data in time.
3. Mindray is not responsible for lost data if you DO NOT follow suggested backup procedures.

11.1 Patient Information Management

11.1.1 Enter Patient Information

The general patient information and exam information are entered through the Patient Info screen, for details; please refer to “4.2.1 New Patient Information”

After completion of patient information entry, click [OK] to save the patient information to the patient data.

11.1.2 Patient Information Setting

Open “[Setup] → [System Preset] → [General]”, and then set the following in the Patient Info area. Here, you can select if to display patient gender, age or operator in the screen; set the H&W applied unit and select the using surface formula.

- Setting patient information display
- H&W Unit
- Surface formula setting

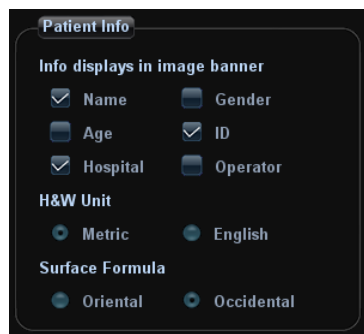

11.2 Image File Management

You can store the image files either in the patient database in the system, or to external memory devices. For a saved image, you can perform operations like image reviewing, analyzing and demonstration (iVision).

11.2.1 Memory Media

System supported memory media including:

- System hard disk
- USB memory devices: USB flash drive, removable USB hard disk
- DVD+RW, DVD+R, DVD-R, DVD-RW, CD-RW, CD-R

11.2.2 Image File Formats

The system supports two types of image file formats: system-relevant and PC-compatible.

■ System-relevant formats:

- Single-frame image file (FRM)
Refers to single-frame static image files not to be compressed; you can perform measurements and comments adding on this type of files.
- Cine file (CIN)
System-defined multi-frame file format; you can perform manual or auto cine review, and perform measurements or add comments for the reviewed images. After you open a stored CIN file, the system automatically enters cine review status.

The system can save FRM files as BMP, JPG, TIFF or DCM files, or save CIN files as AVI, DCM files. The system can also open FRM, JPG, BMP and CIN files.

■ PC-compatible formats:

- Screen file (BMP)
Single-frame file format, used to save the current screen, non-compressed format.
- Screen file (JPG)
Single-frame file format, used to save the current screen in the compressed format; you can set the compression ratio.
- TIFF: Single-frame export format
- Multi-medium files (AVI)
Multi-frame file format, general cine file format.
- DICOM files (DCM)
DICOM standard files format, single-frame or multi-frame format, used to record patient information and images.

11.2.3 Image Storage Preset

■ Set image size

You can set the image size via “[Setup] → [System Preset] → [General]”. The items are shown as follows:

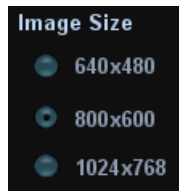

- Set single frame export format
 - Format

You can select the image export format in the “Send To” dialogue box.

You can set the JPG compression ratio via “[Setup] → [System Preset] → [General]”.

NOTE: Compression in a JPEG format may result in image distortion.

- Set cine saving length
 - Live Capture
 - Clip length

For details, please refer to “7.2 Cine Review”.
- Send to DICOM print when ending the exam

Open “[Setup] → [System Preset] → [General]”, check “Send/ Print Image after End Exam” in “Patient Management” area. Then every time you press <End Exam>, the system will send images of the exam to the connected default DICOM server.
- Storage image/clip linked operation

You can set to send image/clip to other media when you save/clip to hard disk (11.2.4 Saving Images to the System), the setting path is: [Setup] → [System Preset] → [General] → “Image/clip storage”

 - Image can be sent to: local default printer, DICOM storage, DICOM printer.
 - Clip can be sent to DICOM storage.

11.2.4 Saving Images to the System

- To save a single-frame image in the system:
 - (1) Set the user-defined key in the path: [Setup] → [System Preset] → [Key Config].
 - (2) Press the user-defined key to save the image.
 - In the image screen, press the shortcut key to save the current single-frame image with the image frozen, and the image is saved with the default file name in the default file directory in the FRM format. The thumbnail of this image will appear in the thumbnail area on the right side of the screen. When you move the cursor onto the thumbnail, its filename with suffix will be displayed.
 - When a dialog box is displayed on the current screen, press the shortcut key to save the screen in the BMP format.
- To save cineloop image in the system:

Freeze an image and click [Save Cine] in the soft menu to save the current cine file in the default file directory in the dynamic image format CIN.

The thumbnail of this image will appear in the thumbnail area on the right side of the screen. When you move the cursor onto the thumbnail, its filename with suffix will be displayed.

11.2.5 Quickly Saving Images to USB Flash Drive

Use user-defined keys to quickly save the single-frame or cine to USB flash drive.

The image file is stored in the directory: U disk\ US Export\ patient folder\ exam folder\ Image ID.bmp, where,

- Patient folder name: patient name + patient ID
- Exam folder name: exam mode+ exam time
- To store single-frame image to USB flash drive:
 - (1) Set the user-defined key through the path: [Setup] → [System Preset] → [Key Config].
Select a key in the Key Function page on the left side and select “Send image to USB disk” in the Output page of Function field on the right side.
 - (2) Press the user-defined key to save the image to the USB flash drive.
- To store cine to USB flash drive
Save cine images to a USB flash drive in the AVI format.
 - (1) Set the user-defined key through the path: [Setup] → [System Preset] → [Key Config].
Select a key in the Key Function page on the left side and select “Send AVI Cine to USB disk” in the Output page of Function field on the right side.
 - (2) Press the user-defined key to save the cineloop.

11.2.6 Quickly Saving Full Screen Image to the System



This function can save the current full screen image to the system with the image in real-time status.

Set the user-defined key through the path: [Setup] → [System] → [Key Config]. Select a key in the Key Function on the left side and select “Save Full Screen Image to hard drive” in the Output page of Function field on the right side.

After the setting, you can use the user-defined key to save full screen image to the system.

11.2.7 Thumbnails

The stored images or cineloops are displayed in the form of thumbnails on the screen:

- In the iStation screen, the thumbnails refer to the images stored for the selected exam or the selected patient.
- In the scanning or freeze mode, the thumbnails refer to the images stored in the current exam. You can click  or  to page down or up the thumbnails when there are more than one page.
- In the Review screen, the thumbnails refer to the images stored in the same exam.
- In the Review screen, open an image to enter the image analyzing status, all the thumbnails belong to the exam are displayed.
- When you move the cursor onto a thumbnail, its name and format will be displayed.

11.2.8 Image Review and Analysis

You can review and analyze the stored images (only refer to the images stored in the system default path).

11.2.8.1 Review an Image

You can review all images stored in an exam, and send, delete or analyze the stored images.

- To enter Review:
 - Press <Review> to enter Review screen. The system displays the images stored in this exam of the current patient (if there is no current patient information, you can review the images of the latest exam).
 - Select an exam of a patient in the iStation screen, and press <Review> to enter the Review screen to review the images of the patient. You can also select more than one exam, and the system will display images of the latest exam images in Review status.

The Review screen is shown as follows:



- To exit Review:
 - Click [Exit] on the Review screen; or,
 - Press <ESC> or <Review> again.
- Basic operations
 1. Move the cursor onto an exam record in the Exam History area and press <Set>. The selected item is highlighted.
 2. Click [Info] or [Report] to view patient information or report.
 3. Double-click a thumbnail to view and analyze an image. Rotating the Multifunctional knob will navigate through thumbnails.

The function buttons are described as follows:



- Exam History:
 - You can select one certain exam from the exam directory to review the images.
 - If entered from iStation, the screen displays the record(s) selected in the iStation. If no patient is selected when it was in iStation, then all the patients in the system database will be displayed, and the current patient exam is listed.
 - If entered from the imaging status, the Review screen displays the images of the current exam, and the default selected image is the one displayed on the preview main screen.
- [Info]:
 - Click to enter the Patient Info screen, you can review or edit the currently-selected patient information.
- [Report]
 - Click to review or edit the currently-selected patient report.
- Image operations
 - [Select All]: click to select all images in the thumbnail window.
 - [Deselect All]: after clicking the [Select All], the button changes into [Deselect All], you can cancel all the selections by clicking [Deselect All].
 - [Send To]: click to send the selected image to other location, DICOM server, printer and etc.
 - [Delete]: click to delete the selected image.
- Layout:
 - You can select the layout of the Review screen among three selections: 1×1, 2×2 and 4×4.
- Switching operations:
 - [New Exam]: click to create a new exam for the selected patient and open the Patient Info screen.
 - [Activate Exam]: click to enter the currently selected exam and enter the image scanning screen; it grays out if the current patient cannot be activated.
 - [Open]: click to open the selected image.
 - [iStation]: click to enter the iStation screen.
 - [Exit]: click to exit the Review status, and return to the main screen.

11.2.8.2 Image Analysis

For the image analysis, you can view, zoom, perform post processing and measurements, add comments and perform cine (multi-frame) review for a stored image. The operation steps are the same as those for real-time scanning; please refer to relevant sections for details.

- To enter image analysis:
 - In the image scanning or freeze status, double-click a thumbnail stored in the exam to enter the image analysis status; or
 - In the Review status, select a thumbnail and click [Open] or directly double-click the selected thumbnail to open the image.
- To exit the image analysis:
 - Press <Freeze> to exit and enter the real-time scanning status.
 - Press <Review> to exit from the image analysis to the Review status.
 - Press <ESC> to return to the previous screen.

- For BMP-formatted image, click [Exit] at the lower right corner of the image to exit.

In image analysis status, the selected image is open on the screen, and the thumbnails of the same exam are displayed on the Thumbnail area, you can click  to turn pages, click  to delete or click  to send a selected image.

11.2.9 iVision

iVision function is used for demonstration of the images stored. Image files are played according to file names one by one (including the image of system-relevant and PC-compatible format).

To perform image demonstration:

1. Enter iVision screen:
 - Move the cursor onto [iVision] in the Other menu, and press <Set>.
 - Press the user-defined key (setting path: [Setup]→[System Preset]→[Key Config])
2. Add the contents to be played and select the demo mode.
3. Select an item in the list, and click [Start] to begin the demonstration.
4. Click [Exit] or press <ESC> to exit the iVision status.

■ Demonstration item

The demonstration items are the image files in the formats that the system supports. You can add the exam data in patient database (D:\PatientData) or system supported image files and folders to demonstration item list. For files and folders in demonstration list, the images in the directory and subdirectory are played one by one, and the system will automatically jump over the files that can't be opened.

■ Demonstration item

There are two kinds of catalogs: Demo Catalog and Customize Catalog.

- Demo Catalog: demo catalog is the folder in hard disk (E disc), where the factory DEMO is stored. The system plays the images in this folder when performs demonstration.

The system supports import, delete or clear the data in demo catalog.

Click [Demo Manager] to operate:

: To import data to demo catalog.

: To delete the selected data.

: To delete all data.

- Customize Catalog: what saved here is the catalog of the displayed image. The system plays the images in the catalog when performs demonstration.

Operate the catalog by the buttons on the right:

[Add File]: to add files to the file list.

[Add Catalog]: to add catalog to the file list.

[Delete]: to delete the selected file or catalog in the file list.

[Clear]: to clear all the files or catalogs in the file list.

[Export]: export the selected directory/file to the specified external storage devices.

Select or deselect the directory/file by checking or un-checking the check box before the file list, only the selected directories/files will be replayed.

- Demo mode

The system automatically plays all the image files in the list one by one. The time intervals between images played can be changed through the drop-down list of "Interval".

- Option of Demo

You can choose whether to repeat the demonstration or exit after a demonstration is completed.

11.2.10 Sending Image File

- On the image screen, select a stored image thumbnail (press <Shift> to select more than one at the same time), click  (Send To) on the lower right corner of the screen, the image can be sent to the external devices.
- In the iStation or Review screen, click [Send To] to send the selected image to the external devices.

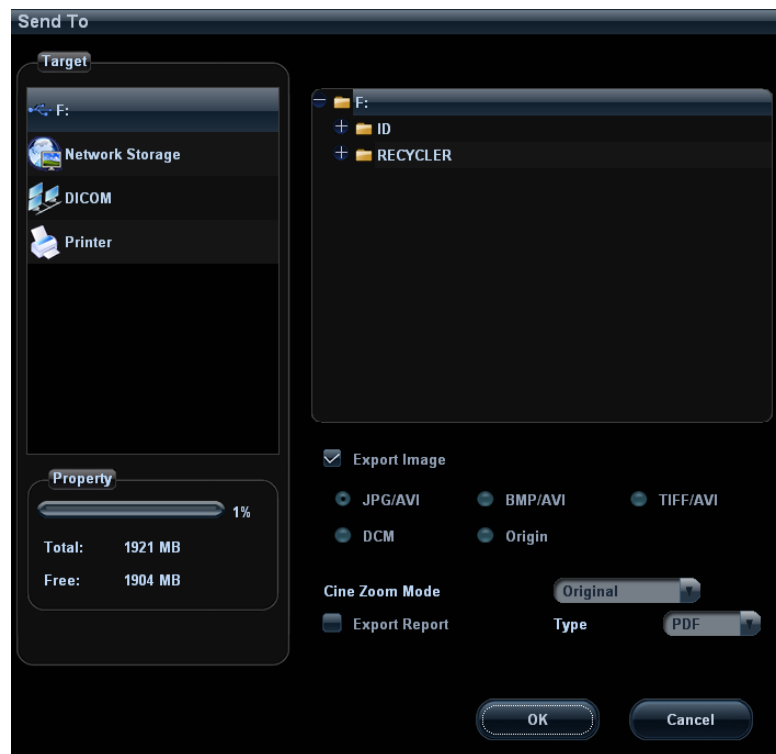

- For external memory devices (e.g. USB memory devices, DVD-RW, MedSight devices or network storage server):
 - a) PC format transfer: JPG/ AVI, BMP/ AVI, TIFF/ AVI. Where a single-frame image is exported as JPG, TIFF or BMP, and the cine file exported as AVI.
 - b) DCM format transfer: DCM (including single-frame DCM and multi-frame DCM).
 - c) You can also select to export report format.
 - d) Select the cine zoom mode.
- For DICOM Storage or Print server, select the DICOM Storage or Print server.
- For a video printer, send images to the video printer connected with the system. For a graph/ text printer, send the images to the default graph/ text printer.

11.3 Report Management

- Report storage:

The exam reports are stored under the directory of the exam of the patient.

- Importing, exporting and sending a report

In the iStation screen, select patient data, click [Restore] or [Backup] to import or export patient information, images and reports from or to an external memory device or network storage server.

You can also select whether to remove local patient exams data or only images after backup.

See the following figure:



In the iStation or Review screen, click [Send To] to send patient data to an external memory device or network storage server, you can choose if reports are exported with images.

To export the report:

- (1) Check "Export Report" on the screen.
- (2) Click [OK] to confirm.

You can select paper size for the report in the path: [Setup] → [Peripheral Preset]

- Printing report

Use a connected graph/text printer to print a report. Please refer to "15.7 Peripheral Preset" for details about default report printer setting.

For details on report relevant operations, please refer to [Advanced Volume].

11.4 Patient Data Management (iStation)

The patient data include basic patient information, exam information, image files and reports. You can search, view, backup, send, restore or delete patient data in iStation.

- To Enter iStation

- Press <iStation> key on the control panel; or
- Click [iStation] in the Patient Info screen; or
- Click [iStation] in the Review screen.

11.4.1 Viewing Patient Information

- Data Source
Select the data source of patient data, the system patient database is default.
- Patient list
Display patient information, exam mode, number of images and cines, exam state, backed up or not.
- Info
Select an exam of a patient, click [Info] on the right side to display the patient information of this exam.
- Report
After you select an exam of a patient, click [Report] to view the report of this exam for this patient. If no report is generated in the exam, the system prompts that "There is no report belongs to the exam".
- Review
Select an exam of a patient, click [Review] to enter Review screen.
- Select All/Deselect All
Click [Select All] to select all the patient data listed. Then the button changes into [Deselect All], you can cancel all the selections by clicking [Deselect All].

11.4.2 Searching a Patient

- (1) Select the data source.
- (2) Set search items of Name, ID, DOB, and Exam Date in the "Item" drop-down list.
- (3) Enter the keyword in accordance with the "Item" selected, and the system searches and displays the results in the patient list.
- (4) When you select a patient in the patient list, the images of this patient will be displayed at the bottom of the screen.

Tips:

- When you clear the keyword, enter other keywords or cancel the selection "Find in results", the system will refresh the searched results.
- Click [Reset], the system will clear the information you entered in Keyword, and all the recorded patient information will be listed out.
- Select "Find in results", the system will do searching based on the last searched results.

11.4.3 Patient Data Management

- Send To
The system supports to send data to external memory, DVD-RW/DVD+RW, network storage server or DICOM server or send images or reports to printers to print.
 - The [Send To] button on the right side of the patient list is used to send exam data or images of the selected exam.
 - The [Send To] button on the right side of the thumbnail area below the patient list is used for sending selected images.
 - Send patient exam data to USB devices, DVD-RW/DVD+RW drive, network storage.

- Send images to USB devices, disc, DICOM storage server, DICOM printer, video printer, text/ graph printer, network storage.
- Send images with report to USB devices, DVD-RW/DVD+RW drive, and network storage.
- Format transfer is available when sending images to USB devices, DVD-RW/DVD+RW drive or network storage. (Please refer to “11.2.10 Sending Image File” for details.)
- Press <Shift> on the control panel to select more than one exam or image at one time.

■ Delete

To delete the selected patient or exam data, click the [Delete] button on the right side of the patient list. However, you cannot delete patient data being printed, exported or sent, or delete the current exam.

- The [Delete] button on the right side of the patient list is used to delete exam data of the selected exam.
- The [Delete] button on the right side of the thumbnail area below the patient list is used for deleting selected images.

■ Recycle bin

The recycle bin is used to store the deleted patient data, exam data and images (time lasts from deleting to system is powered off). The system supports recovery of the data from the recycle bin.

Tips: The recycle bin will be cleared after the system is powered off.

To recover the deleted patient data, click  at the lower right corner of the screen to enter the Patient Recycle Bin screen.

(1) Select items to be recovered in the list.

(2) Select operations:

- Click [Restore Items] to restore the item back to iStation.
- Click [Delete] to delete the item permanently, and the item can never be restored again.
- Click [Restore All Items] to restore all the items back to iStation.
- Click [Empty Recycle Bin] to empty the recycle bin and all items can never be restored again.
- Click [Exit] to exit Recycle Bin screen and return to iStation.

■ Backup/ Restore

You can back up the selected patient data to the system-supported media in order to view it on computers, or restore the patient data to the system from an external media.

[Backup]: click to export the selected patient data to the system-supported media.

[Restore]: click to import the patient data from an external media. If no external data source is connected, then the button is unavailable.

11.4.4 Examinations

■ New Exam:

After you select a patient data or exam in the iStation screen, click the [New Exam] to enter the Patient Info screen, where you can select a new exam mode and click [OK] to begin a new exam.

- **Activate exam**

After you select an exam, which has been performed within 24 hours, click [Activate Exam] to activate the exam and load the basic patient information and measurement data to continue the exam.

If you want to select a patient data in an external memory database to start a new exam or recover the exam, you have to first allow the system to load the patient data to the system's patient database.

- **Continue Exam**

Select an exam that is paused within 24 hours, click [Continue Exam] to activate the exam and load the basic patient information and measurement data to continue the exam.

If you want to select a patient data in an external memory database, you have to first allow the system to load the patient data to the system's patient database.

11.5 Network Storage

Network storage is used to save image files and measurement reports to the remote PC server.

Open "[Setup]→[Network Preset]→[Network Storage]" to set properties for network storage. (For details, please refer to "15.8 Network Preset")

1. Enter iStation; select one (or more than one) patient data or image in the local data source.
2. Click [Send To].
3. Select [Network Storage] in the Send To dialogue box, and select the PC server on the right side.
4. Select PC transfer format and check if to send report.
5. Click [OK] to start sending.

- **User-defined key for network storage**

- Send Image to Network Storage: to send image(JPG format) to the default network server.
- Send AVI Cine to Network Storage: to send image(AVI format) to the default network server.

11.6 Print Job Management

You can manage the pending print tasks for graph/text or digital video printer.

After the printer is successfully connected and print task is undergoing, click the printer

icon  in the lower right corner of the screen to open the Print Task Manager screen.

Information of all print tasks is displayed in the list, including name, status (being printing or suspended), printer and submit time.

If all print tasks are finished, the print icon will disappear from the screen, if not, please check the manager to see if there is any failure task.

- To delete a print task
Select the print task in the list and click [Delete].
- To restart a print task after it is suspended
Click [Restart] to restart the paused print task.





11.7 Backing Up and Erasing Files through DVD Drive

The system supports DVD-RW drive to write data in CD/DVD and to read data from CD/DVD in PC.

The system supports the following media: DVD+RW, DVD-R, DVD-RW, DVD+R, CD-RW, CD-R.

The DVD-RW drive can write the files in the format of ISO or UDF, and the setting path is: [Setup] → [System Preset] → [General] → “File System Type”.

■ To write data to a CD/DVD:

- (1) Put a CD/DVD in the tray, and the symbol  appears in the lower right corner of the screen.
- (2) Select the data to be backed up, click [Send To] or [Back Up] in the screen (in iStation or Review). Select the target drive in the Send To or Back Up Patient Record dialogue box.
- (3) Click [OK] or [Backup] to begin writing, the task management icon displays , and the disc symbol displays .
- (4) After the writing process is completed, click  to pop up the Disc Option dialogue box, and select [Eject] to eject the CD/DVD.

■ To erase data from a CD/DVD

- (1) Put the CD/DVD in the tray.
- (2) Click the  symbol to pop up the Disc Option dialogue box, as shown in the figure below.
- (3) Click [Erase] to erase data from a CD/DVD.
- (4) After the erasing process is completed, click [Eject] in the Disc Option dialogue box.

Tips:

- Writing data using “Send To” supports PC format transfer function, while CD/DVD written by “Backup” supports only system-relevant formats.
- The  symbol indicates that the input CD/DVD is damaged or with data of wrong format.

 **CAUTION:** During the backup process, if a CD/DVD is forcibly taken out or you perform other operations, the backup process will fail or the system may malfunction.

NOTE: Directly removing a DVD-RW drive may result in the damage of DVD-RW drive and /or the system, please refer to 3.6 Connecting/ Removing a USB Memory Device” for disconnection.

11.8 Patient Task Management



Click  at the lower right corner of the screen to pop up the dialogue box.

The system supports three types of task management:

- Storage Task: displays the DICOM storage task.
- Print Task: displays the DICOM print task.
- Media Storage Task:
 - DICOM media storage task(including DVD-RW and USB devices)
 - Backup task (system-relevant format): select the exam in iStation and click [Backup].
 - Send to external devices (including DVD-RW and USB devices): select exam data or images in iStation or Review screen, click [Send To].
 - Network Storage task.
 - MedSight storage task:
 - In iStation screen, send exam to MedSight devices.
 - On review screen, iStation screen, thumbnail area, send the image(s) to MedSight devices.

In the Task Management dialogue box, patient ID, name, destination, progress, type, contents and task created time are displayed.

You can do the following operations:

- Click [Cancel] to cancel the selected task.
- Click [Retry] to retry the failed task.
- Click [Select All] to select all the tasks.
- Task status
 - When there is/are task (s) undergoing, the task management icon displays as , you can click the icon to check the process.
 - When there is any task failed, the task management icon displays as , you can click the icon to check the failure.
 - When the task management icon displays as , it means no task is undergoing or no failure.

11.9 Administration

11.9.1 Access Setting

There are two kinds of users: the system administrator and operator.

The system administrator can view all patient data, such as patient information, image and report, etc. The operator can only view the exam information saved in the system and operated by himself or herself, such as patient information, image and report, etc. The operator cannot view the exam data operated by others.

Emergency operators are general ones; they can enter the system without entering password. But they can't modify or delete the password.

11.9.2 Setting Access Control

The system administrator can preset the access control, that is, if an operator has the right to access to the data in the system.

The access control only can be set by the system administrator.

Setting access control:

1. Open the “Admin” page through the path: [Setup]→[System Preset]→[Admin].
2. If  **Enable User Account Control!** is selected, you need to have the authority before accessing the data. If not, you can access all the data without the authority.

11.9.3 System Login

If access control has been set by the system administrator, you can access the data in the system only after you log on the system.

You need to enter user name and password in the following cases:

- Before entering the system
- Changing user

As long as the system is in the working status, you can enter the above screens without entering user name and password repeatedly.

■ Log on the system:

- (1) If the system requires you to log on the system before you access the data.
- (2) Select the user name in the drop-down list of User Name.
- (3) Enter password and click [Login].

■ For emergency users, click [Emergency] directly to log on.

■ To change user:

- (1) To log out the current user and change to another user, click  at the lower right corner of the screen to pop up the dialogue box.
- (2) Click [Change User] to pop up the Login dialogue box.
- (3) Enter the user name and password in the field box.

11.9.4 Add/ Delete a User

The system administrator can add and delete a user, while the operator can't.

Add a User

Premise: you must log on the system as the system administrator. If not, you will be required to enter administrator name and password before the setting.

1. Open the “Admin” page through the path: [Setup]→[System Preset]→[Admin].
2. Click [Add] to enter the dialogue box.
3. Enter the user name (you are not allowed to enter the same name or modify the name already exist).
4. Enter the password and the confirm password (the password is consist of 6-16 characters)
5. Set the user role in the drop-down list: administrator or operator.

6. Click [OK] to confirm the setting and exit the dialogue box, then the new user will appear on the User List.

Delete a User

Premise: you must log on the system as the system administrator. If not, you will be required to enter administrator name and password before the setting.

1. Open the “Admin” page through the path: [Setup]→[System Preset]→[Admin].
2. Select the user to be deleted in the User List (Emergency user can’t be deleted), click [Delete] to delete the selected user.

11.9.5 Modify Password

The system administrator can modify password of all users.

The operator can only modify his/her own password.

To modify the password, the user has to log on the system first.

There are two ways to modify password: modify it on “Admin” page or on “Session Manage” dialogue box.

- “Admin” page (administrator can modify the password)
 - (1) Open the “Admin” page through the path: [Setup]→[System Preset]→[Admin].
 - (2) Select the user name to be modified (except emergency operator) in User List, click [Change Password] to open the dialogue box.
 - (3) Enter new password and confirm password, then click [OK].
- Session Manage page (general operator and administrator can modify the password).

When the user has logged on the system, you can see  at the lower right corner of the screen.

- (1) Click  at the lower right corner to pop up the Session Manage dialogue box, on which you can see the current user’s information.
- (2) If you want to modify the current password, click [Change Password] to pop up the Change Password dialogue box.
- (3) Enter the previous and the new password in the dialogue box.
- (4) Click [OK] to exit.

11.10 Q-Path

NOTE:	When logging on the Q-path service, the ultrasound system is connected to the external network and it may be infected by virus. Please do not access the unrelated website or perform any unrelated operations. If abnormal data or link is discovered after logging on the Q-path service, please stop operation and contact the Q-path service provider.
--------------	---

11.10.1 Overview

You can use the ultrasound system to check data on browser directly. After you have ordered storage service of a network website service, you can check data using the

website, authorized account and password (provided by the service vendor). You can open the browser (Q-View) to review previously sent DICOM data.

Q-path is a network server provided by Telexy Healthcare Inc. for digital image storage. Q-View is a client viewing tool for the server. Telexy Healthcare developed technology and a command structure that allows any Q-view enabled ultrasound system to access Q-path directly from the ultrasound system using a single control. The primary purpose for Q-view is to provide remote access to Q-path from the ultrasound system to complete the exam report on the ultrasound system and submit for QA,

To access Q-Path on M7, the user just opens the Q-View first and then enters the URL, user account and password provided by Telexy Healthcare, and M7 software system will call Q-View tool then for user Q-Path application.

For details, please contact Q-Path service provider.

11.10.2 Q-Path Basic Procedure

- 1、 Set related setting: check the check box by "Enable Q-Path" in the path: "[Setup]→ [Network Preset]→ [Q-Path]", enter the website, account and password of the target service, as shown in the following:



Figure 1

- 2、 Set the user-defined key through the path: [Setup]→ [System Preset]→ [Key Config]. Select a key in the Key Function field on the left side and select "Q-Path" in the Other page of Function field on the right side.
- 3、 Click [OK] to confirm.
- 4、 Press the user-defined key to turn on the function, and you will enter Q-View screen.

Note: the following prompt will display every time you enter Q-Path after powering on the machine. Select "Yes" to enter the website service.

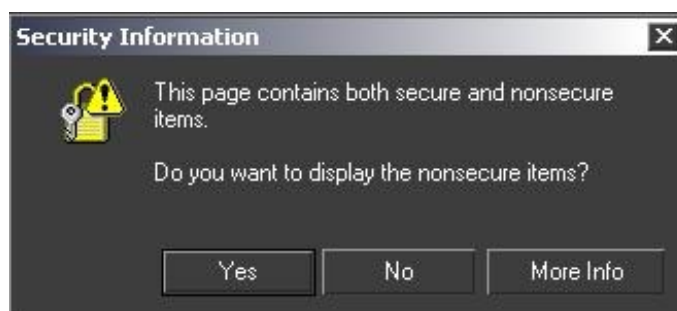

Figure 2

- 5、 Press <ESC> or the user-defined key to exit the function.

NOTE: If you use the function to connect to websites other than Q-Path applications (website setting in “[Setup]→[Network Preset]→ [Q-Path]”), the system will prompt the following information:

Only Q-path application is allowed to be loaded!

11.10.3 Q-Path Functions using Q-view

When Q-Path is accessed from the ultrasound system using Q-view, access is restricted to the active exam and only certain functions are available.

NOTE: What functions you can acquire by using Q-View is only related to what you have purchased from Q-Path service provider. Please contact Q-Path service provider for details.

The primary purpose of accessing Q-path from an ultrasound machine using Q-view is to complete the exam report template and submit the exam for review or quality assurance, eliminating the necessity to log in to Q-path from a separate workstation.

■ Q-path Functions Available on the Ultrasound System:

- Update Patient and Exam Information;
- Image Annotation;
- Image thumbnails;
- Exam Worksheets;

Note: Only credentialed physicians are authorized to approve or sign a report.

- Submit Exam for QA.

12 DICOM

NOTE: Before using DICOM, please read the electronic file DICOM CONFORMANCE STATEMENT along with the device.

This chapter is confined to the preset, connection verification and DICOM services of the DICOM-configured ultrasound machine, not including SCP configurations like PACS/ RIS/ HIS.

The DICOM package is optional, so the description here is only applicable for the system configured with the DICOM package.

This system supports the following optional DICOM functions:

- DICOM Basic function: DICOM connection verify, DICOM task management, DICOM storage, DICOM print, DICOM storage commitment, DICOM media storage (DICOmdir review)
- DICOM Worklist
- MPPS (Modality Performed Procedure Step)
- Structured Report (SR)
- DICOM Query/ Retrieve

Workflows of DICOM preset and application are briefly described as follows:

1. DICOM preset (Local TCP/IP setting, DICOM local setting, DICOM server setting, and DICOM service setting)
2. Verify connectivity.
3. DICOM Services (image storage, print, MPPS, Worklist, storage commitment, media storage, DICOmdir review, task management).

12.1 DICOM Preset

12.1.1 Local TCP/IP Setting

NOTE DO Not edit IP address in Network Preset page as the network task is executed, otherwise it fails. View if there is any undergoing task in task manager of the system.

To set the network properties of the ultrasound system.

1. Press <Setup> to enter the Setup menu.
2. Move the cursor onto [Network Preset], select [Local TCP/IP] to open the screen, as shown in the figure below:

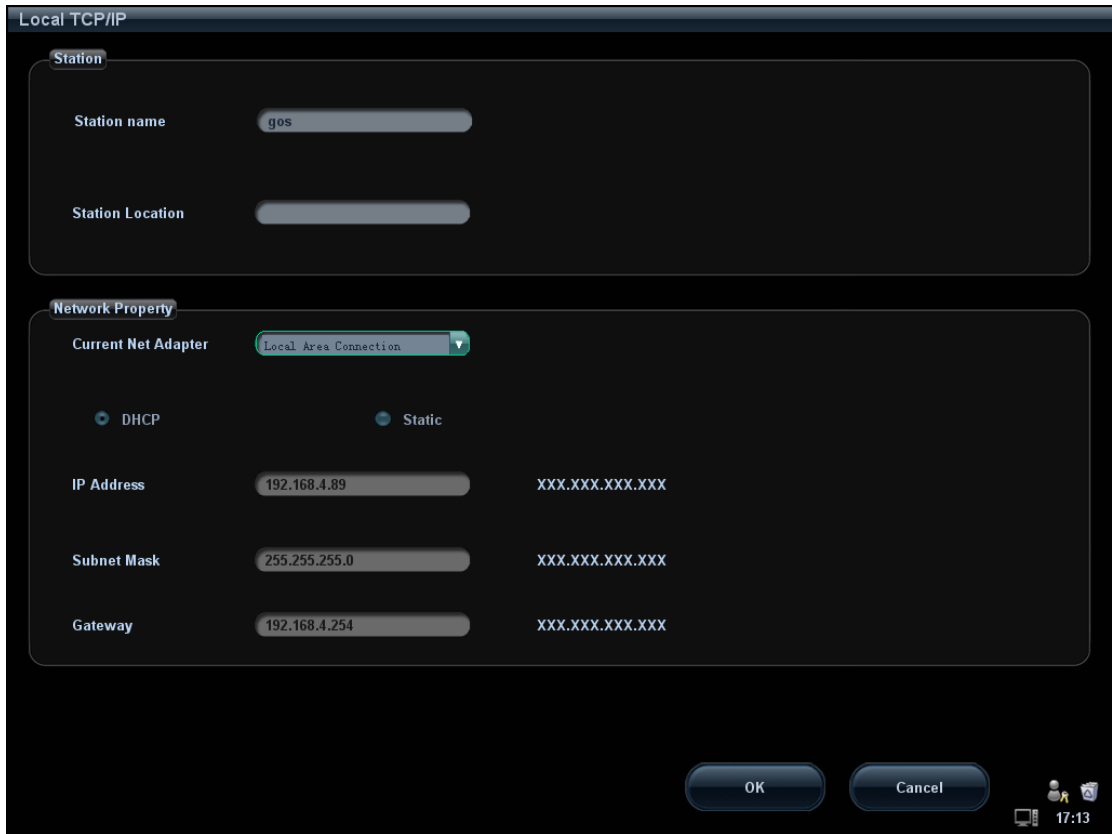

3. Local TCP/ IP preset items are described as follows:

Name	Description
Station Name	Name of the ultrasound system. Tips: you need to restart the system to make the modification effective (press the power button and select "Shut Down" to power off the system, and then wait for a while to power on the system.).
Station Location	Location or department where the system is placed.
Current Net Adapter	To select the net adapter.
DHCP / Static	If "DHCP" is selected, IP address will be automatically obtained from DNS server; if "Static" is selected (using static IP address), you need to enter the IP address.
IP Address	IP address of the system.
Subnet Mask	Used to set different network segment.
Gateway	Used to set the gateway IP.
OK	Click to confirm parameter setting.
Cancel	Click to cancel parameter preset.

Tips: The IP address of the system should not be occupied by other devices in the network, or the DICOM function will fail.

12.1.2 DICOM Local Setting

To set the DICOM server properties and log saving manner.

1. Press <Setup> to enter the Setup menu.
2. Move the cursor onto [Network Preset], select [DICOM Local] to open the screen, as shown in the figure below:

3. DICOM Local Setting items are described as follows:

Name	Description
AE Title	Application entity title of the ultrasound system. The AE title here should be the same with the one of the acceptable SCU set in the server.
Port	DICOM communication port, which should be the same with the one in the server.
PDU	Maximum PDU data package size ranging from 16384 to 65536.
Log Setting	File Name: name of the DICOM log, generated by the system automatically. Log Level: to set the log type. The available selections: No log, Service result log, Service process log, All log. We suggest setting "All log", so that you can see the DICOM log on the E disk.
OK	Click to confirm parameter setting.
Cancel	Click to cancel parameter setting.

Enter AE Title, Port, PDU according to the actual situation, and then click [OK] to exit the screen.

Tips:

- AE Title should be the same with the SCU AE Title preset in the server (PACS/ RIS/ HIS), for example, if the AE Title of the server preset in the storage server is AAA, and the AE Title of the accepted SCU is preset as MMM, then in the figure above, the AE Title of Local should be MMM, and the AE Title of storage server should be AAA.
- Same IP Address may result in DICOM abnormality.

12.1.3 DICOM Server Setting

To add or delete DICOM servers, or set IP address and name for the DICOM server.

1. Press <Setup> to enter the Setup menu.
2. Move the cursor onto [Network Preset]; select [DICOM Server] to open the screen, as shown in the figure below.

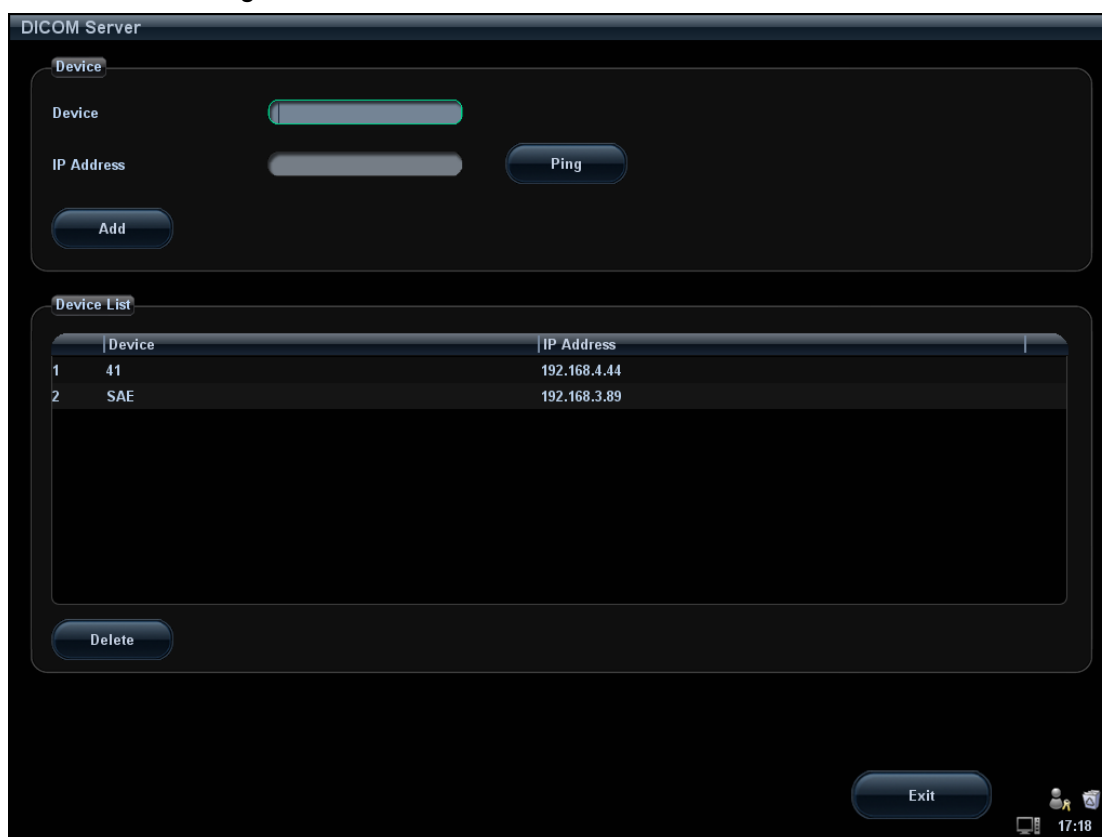

3. DICOM server setting items are described as follows:

Name	Description
Device	Name of the device supporting DICOM services
IP Address	IP address of the server
Ping	You can ping other machines to verify connection after entering the correct IP address. Also you can check the connection of the already added server in the list.
Add	Click to add servers to the device list
Delete	Click to delete the selected server(s) in the device list

Name	Description
Exit	Click to exit the DICOM Server screen

Tips:

- If the currently entered name has already existed, the system will pop up: “The server name exists!” Click [OK] to enter another name.

12.1.4 DICOM Service Setting

When the system is configured with DICOM basic function module, and installed DICOM Worklist, MPPS, DICOM Structured Reporting, DICOM storage commitment, and Query/Retrieve modules, the corresponding preset settings can be found in DICOM Service screen.

Open “[Setup]→[Network Preset]→[DICOM Service]” to set properties of DICOM services.

12.1.4.1 Storage Setting

1. Enter the “Storage” page: “[Setup]→[Network Preset]→[DICOM Service]→Storage.
 - Select device, enter the information. For device setting, please refer to “12.1.3 DICOM Server Setting”.
 - Click [Add] to add the service to the Service list.
 - Select an item in the service list, change the parameters in the above area, and click [Update] to update the item in the service list.
 - Select an item in the service list, and click [Delete] to delete the service.
 - Select an item in the service list, and click [Default] to set the server to be the default service.
2. Select an item in the service list, and click [Verify] to verify the connection.
3. Click [Exit] to confirm the setting and exit the page.



DICOM storage setting items are described as follows:

Name	Description
Device	After you set the server(s) in DICOM Server Setting, the name(s) will appear in the drop-down list, select the name of the storage server.
Service Name	Default is xxx-Storage, and it can be modified.
AE Title	Application Entity title, here, it should be consistent with that of the storage server.
Port	DICOM communication port, 104 by default. Here, the port should be consistent with that of the storage server port.
Maximum Retries	Refers to times that the system performs retrying connection, the adjusting range is 0-9.
Interval Time(s)	Reserved feature.
Timeout	Refers to time after which the system will stop trying to establish a connection to the service. Value: 5–60s.
Allow Multiframe	If SCP supports this function, then select it.
Max Framerate	Set the frame range of transferring cin file into DCM multi-frame file.
SR Storage Option	To enable or disable structured reporting sending.
Cine Zoom Mode	Select the cine zoom mode during image file storage.
Compression Mode	Select the compression mode: uncompressed, RLE, JPEG and JPEG2000.

Name	Description
Compression Ratio	Select the compression ratio of JPEG: lossless, low, medium and high.
Color Mode	Select the color mode.
Cancel	Click to cancel the parameter setting.
Update	Select an item in the service list, change the parameters in the above area, and click [Update] to update the item in the service list.
Delete	Click to delete the selected service in the service list.
Default	Select an item in the service list, click [Default] and you can see “Y” in the Default column.
Verify	Click to verify if the two DICOM application entities are normally connected.
Exit	Click to exit the screen.

Tips: RLE, JPEG and JPEG2000 are not supported by all SCPs. Please refer to the electronic file *DICOM CONFORMANCE STATEMENT* of the SCP to check whether SCP supports or not. Do not select these compression modes if the storage server doesn't support them.

12.1.4.2 Print Service Setting

1. Enter the “Print” page: “[Setup]→[Network Preset]→[DICOM Service]→Print.
 - Select device, enter the information. For device setting, please refer to “12.1.3 DICOM Server Setting”.
 - Click [Add] to add the service to the Service list.
 - Select an item in the service list, change the parameters in the above area, and click [Update] to update the item in the service list.
 - Select an item in the service list, and click [Delete] to delete the service.
 - Select an item in the service list, and click [Default] to set the server to be the default service.
2. Select an item in the service list, and click [Verify] to verify the connection.
3. Click [Exit] to confirm the setting and exit the page.



DICOM print setting items are described as follows:

Name	Description
Device	After you set the server (s) in DICOM Server Setting, the name(s) will appear in the drop-down list, select the name of the print server.
Service Name	Default is xxx-Print, and it can be modified.
AE Title	Application Entity title, here, it should be consistent with that of the print server.
Port	DICOM communication port, 104 by default. Here, the port should be consistent with that of the print server port.
Maximum Retries	Refers to times that the system performs retrying connection, the adjusting range is 0-9.
Interval Time(s)	Reserved feature.
Timeout	Refers to time after which the system will stop trying to establish a connection to the service. Value: 5—60s, in increments of 5s, and 15 by default.
Copies	Refer to copies of printed files. You can select among 1 through 5, or directly enter the number.
Settings	The system supports RGB (color printing) and MONOCHROME2 (black and white printing). Please select the type the printer supports.
Film Orientation	Select between LANDSCAPE and PORTRAIT.
Priority	Specify printing task priority among HIGH, MED and LOW.

Name	Description
Film Size	Select film size among the selections listed in the drop-down list.
Display Format	Specify quantity of printed files, e.g. STANDARD\2, 3 indicates 6 images are printed for each page.
Configuration Info	Enter configuration information in the field.
Medium Type	Specify print medium: Paper, Clear Film, and Blue Film. Select Blue Film or Clear Film for black and white printing, select Paper for color printing may provide better effects.
Destination	Specify where the file is exposed: MAGAZINE (stored in the magazine), or PROCESSOR (exposed in the processor).
Min Density	Enter the minimum density of the film
Max Density	Enter the maximum density of the film.
Magnification Type	Select how the printer magnifies an image to fit the film. Replicate: interpolated pixels belong to duplicate of adjacent pixels. Bilinear: interpolated pixels are generated from bilinear interpolations between adjacent pixels. Cubic: interpolated pixels are generated from cubic interpolations between adjacent pixels; None: without interpolation.
Trim	Specify whether you want a trim box to be printed around each image on the film: Yes or No.
Add	Add the DICOM service to the service list.
Cancel	Click to cancel the parameter setting.
Update	Select an item in the service list, change the parameters in the above area, and click [Update] to update the item in the service list.
Delete	Click to delete the selected service in the service list.
Default	Select an item in the service list, click [Default] and you can see “Y” in the Default column.
Verify	Click to verify if the two DICOM application entities are normally connected.
Exit	Click to exit the screen.

12.1.4.3 DICOM Worklist Setting

1. Enter the “Worklist” page: [Setup]→[Network Preset]→[DICOM Service]→ Worklist.
 - Select device, enter the information. For device setting, please refer to “12.1.3 DICOM Server Setting”.
 - Click [Add] to add the service to the Service list.
 - Select an item in the service list, change the parameters in the above area, and click [Update] to update the item in the service list.
 - Select an item in the service list, and click [Delete] to delete the service.

- Select an item in the service list, and click [Default] to set the server to be the default service.
2. Select an item in the service list, and click [Verify] to verify the connection.
 3. Click [Exit] to confirm the setting and exit the page.



DICOM service setting for Worklist is described as follows:

Name	Description
Device	After you set the server(s) in DICOM Server Setting screen, the name(s) will appear in the drop-down list, select the name of the Worklist server.
Service Name	Default is xxx-Worklist, and it can be modified.
AE Title	Application Entity title, Here, it should be consistent with that of the Worklist server.
Port	DICOM communication port, 104 by default. Here, the port should be consistent with that of the Worklist server port.
Maximum Retries	Reserved feature
Interval Time(Sec)	Reserved feature.
Timeout(Sec)	Refers to time after which the system will stop trying to establish a connection to the service. Value: 5–60s, in increments of 5s, and 15 by default.
Scheduled Station AE Title	To set the AE Title of the scheduled station. For example, if the AE Title of the Worklist server is M7, then the scheduled station AE Title here should be M7.

Name	Description
Add	Click to add the Worklist service to the service list.
Cancel	Click to cancel the parameter setting.
Update	Select an item in the service list, change the parameters in the above area, and click [Update] to update the item in the service list.
Delete	Click to delete the selected service in the service list.
Default	Select an item in the service list, click [Default] and you can see “Y” in the Default column.
Verify	Click to verify if the two DICOM application entities are normally connected.
Exit	Click to exit the screen.

Tips:

In terms of “Scheduled Station AE Title”, if you set this item in the Worklist server, then “Scheduled Station AE Title” configured here should be consistent with the one set in the server.

For example, when you set “Scheduled Station AE Title” in the Worklist server as M7 (this means you assigned the scheduled exam to M7), then both “Scheduled Station AE Title” and “AE Title” in the ultrasound system configuration should be M7.

12.1.4.4 MPPS Setting

1. Enter the “MPPS” page: “[Setup] → [Network Preset] → [DICOM Service] → MPPS.
 - Select device, enter the information. For device setting, please refer to “12.1.3 DICOM Server Setting”.
 - Click [Add] to add the service to the Service list.
 - Select an item in the service list, change the parameters in the above area, and click [Update] to update the item in the service list.
 - Select an item in the service list, and click [Delete] to delete the service.
 - Select an item in the service list, and click [Default] to set the server to be the default service.
2. Select an item in the service list, and click [Verify] to verify the connection.
3. Click [Exit] to confirm the setting and exit the page.



DICOM MPPS setting items are described as follows:

Name	Description
Device	After you set the server(s) in DICOM Server Setting, the name(s) will appear in the drop-down list, select the name of the MPPS server.
Service Name	Default is xxx-MPPS, and it can be modified.
AE Title	Application Entity title, here, it should be consistent with that of the MPPS server.
Port	DICOM communication port, 104 by default. Here, the port should be consistent with that of the MPPS server.
Maximum Retries	Reserved feature.
Interval Time(s)	Reserved feature.
Timeout	Value: 5–60s, in increments of 5s, and 15 by default.
Add	Add the DICOM service to the service list.
Cancel	Click to cancel the parameter setting.
Update	Select an item in the service list, change the parameters in the above area, and click [Update] to update the item in the service list.
Delete	Click to delete the selected service in the service list
Default	Select an item in the service list, click [Default] and you can see “Y” in the Default column.

Name	Description
Verify	Click to verify if the two DICOM application entities are normally connected.
Exit	Click to exit the screen.

12.1.4.5 Storage Commitment Setting

- Enter the “Storage Commitment” page: “[Setup] → [Network Preset] → [DICOM Service]→Storage Commitment.
 - Select device, enter the information. For device setting, please refer to “12.1.3 DICOM Server Setting”.
 - Click [Add] to add the service to the Service list.
 - Select an item in the service list, change the parameters in the above area, and click [Update] to update the item in the service list.
 - Select an item in the service list, and click [Delete] to delete the service.
 - Select an item in the service list, and click [Default] to set the server to be the default service.
- Select an item in the service list, and click [Verify] to verify the connection.
- Click [Exit] to confirm the setting and exit the page.



DICOM storage commitment setting items are described as follows:

Name	Description
Device	After you set the server(s) in DICOM Server Setting, the name(s) will appear in the drop-down list, select the name of the storage commitment server.
Service Name	Default is xxx-SC, and it can be modified.

Name	Description
AE Title	Application Entity title, Here, it should be consistent with that of the storage commitment server.
Port	DICOM communication port, 104 by default. Here, the port should be consistent with that of the storage commitment server port.
Maximum Retries	Reserved feature.
Interval Time(Sec)	Reserved feature.
Timeout(Sec)	Value: 5—60s, in increments of 5s, and 15 by default.
Associated Storage Service	The associated storage server is preset before storage commitment, only after the exam is sent out, can storage commitment be created.
Add	Add the DICOM service to the service list.
Cancel	Click to cancel the parameter setting.
Update	Select an item in the service list, change the parameters in the above area, and click [Update] to update the item in the service list.
Delete	Click to delete the selected service in the service list
Default	Select an item in the service list, click [Default] and you can see “Y” in the Default column.
Verify	Click to verify if the two DICOM application entities are normally connected.
Exit	Click to exit the screen.

12.1.4.6 Query/ Retrieve Setting

1. Enter the “Query/ Retrieve” page: “[Setup] → [Network Preset] → [DICOM Service] → Query/ Retrieve.
2. Select device, enter the information. For device setting, please refer to “12.1.3 DICOM Server Setting”.
 - Click [Add] to add the service to the Service list.
 - Select an item in the service list, change the parameters in the above area, and click [Update] to update the item in the service list.
 - Select an item in the service list, and click [Delete] to delete the service.
 - Select an item in the service list, and click [Default] to set the server to be the default service.
3. Select an item in the service list, and click [Verify] to verify the connection.
4. Click [Exit] to confirm the setting and exit the page.

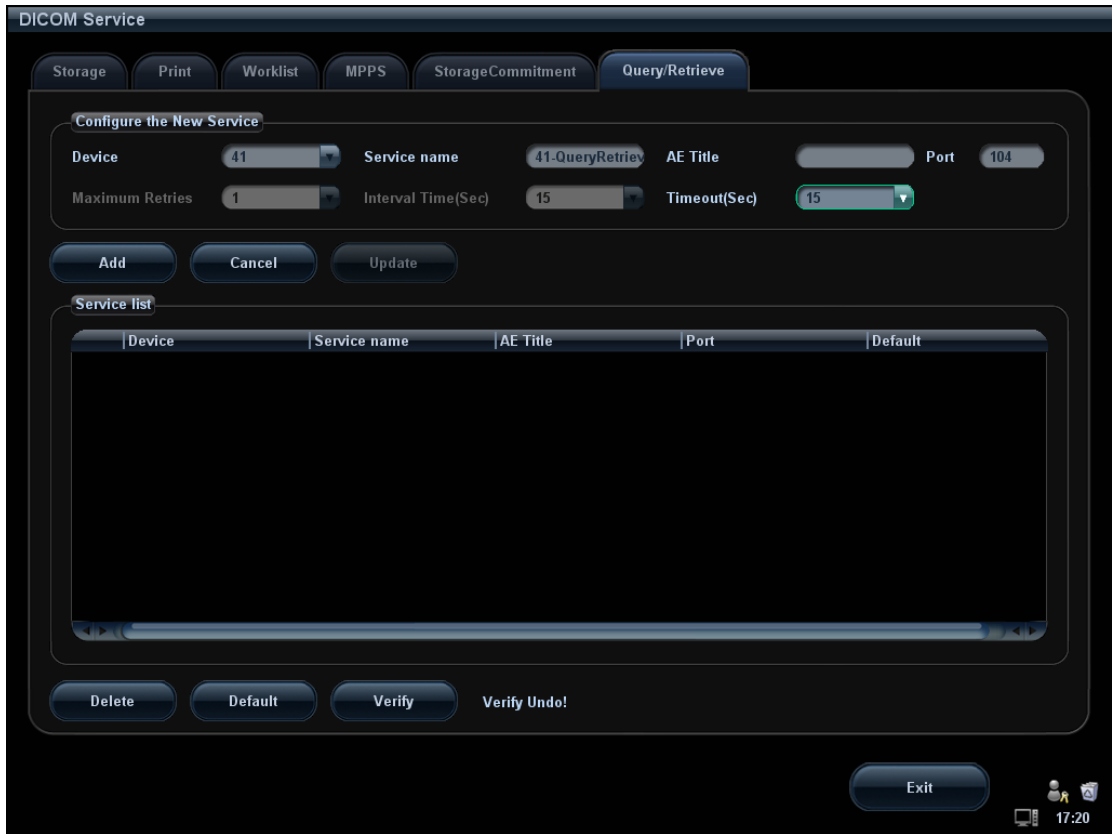

DICOM query/retrieve setting items are described as follows:

Name	Description
Device	After you set the server (s) in DICOM Server Preset screen, the name (s) will appear in the drop-down list, select the name of the server.
Service Name	Default: xxx-Store, and it can be modified
AE Title	Application Entity title
Port	DICOM communication port, 104 is default. Here, the port should be consistent with that of the query/retrieve server port.
Maximum Retries	Reserved feature.
Interval Time(s)	Reserved feature.
Timeout	Value: 5–60s, in increments of 5s, and 15 by default.
Add	Add the DICOM service to the service list
Cancel	Click to cancel parameter setting
Delete	Click to delete the selected service in the service list
Update	Select an item in the service list, change the parameters in the above area, and click [Update] to update the item in the service list.
Verify	Click to verify if the two DICOM application entities are normally connected.
Default	Select an item in the service list, click [Default] and you can see “Y” in the Default column.

Name	Description
Exit	Click to exit the screen.

12.2 Verify Connectivity

If you want to verify connectivity (it is not a must), you can click [Verify] button on the pages of DICOM Service screen respectively.

- If the verification succeeds, it will prompt “xxx Verify Succeed”.
- Otherwise, it prompts “xxx Verify Failed”.

If verification failed, the possible causes may be:

- The ultrasound machine can't communicate normally with the server. Please check if the cable is properly connected; or, Check if the IP of the server is configured in the same segment with that of the ultrasound machine; or, Check if the network adapter, the router, the exchanger and the HUB are normally working.
- The server does not support the verification. If the connection is normal, it can be concluded that the server does not support the verification.
- The server supports the verification, but this function is not activated. Please check if the verification function is activated.

Tips:

Not all the SCPs can support verification; please consult SCP belongings to confirm whether SCP can support this service. If not, the verification won't pass.

12.3 DICOM Service

If the system is configured with DICOM modules, and connected to the relevant DICOM servers, after verifying connection, you can perform storage, print, Worklist, storage commitment, structured report and query/ retrieve applications.

12.3.1 DICOM Storage

DICOM Storage is used to send image(s) to DICOM storage server for storage.

■ Send image in iStation/Review/main screens:

(1) Select image(s)

- Press <iStation> to enter the iStation screen, click to select an exam record in the list, where thumbnails are displayed in the thumbnail area in the lower part of the screen, and then click to select a thumbnail or several thumbnails. Or,
- Press <Review> to enter the Review screen, click to select an image or several images. Or,
- On the main screen, select a thumbnail or several thumbnails.

(2) On the iStation/Review screen, click the corresponding [Send To] button, or, on the main screen, click  at the right side of Thumbnail area. The following dialogue box pops up:

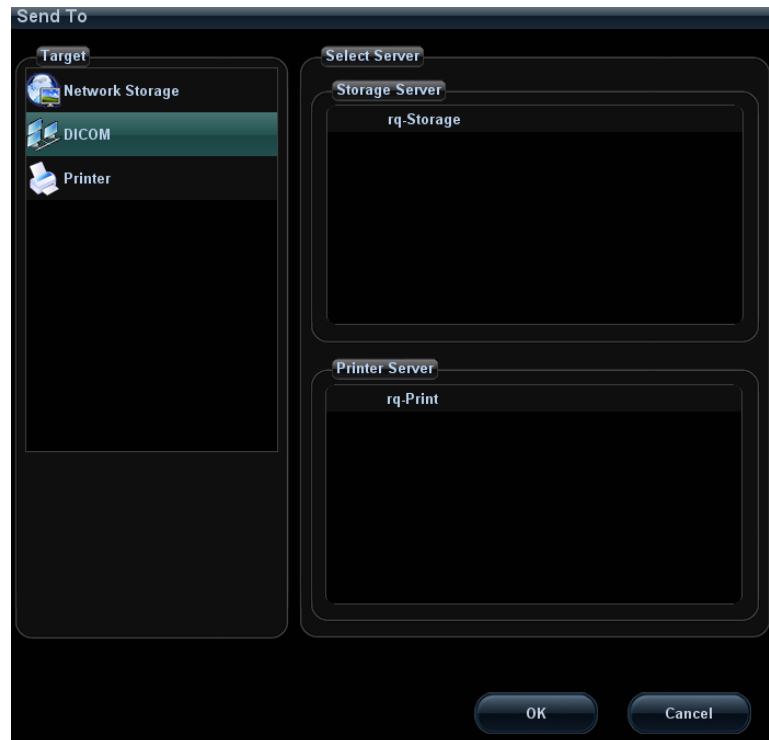

- (3) Select DICOM in the “Target” list; select a server in the “Storage Server” list.
 - (4) Click [OK] to start the sending.
- To send images by shortcut key
- (1) You can save single frame image or multi-frame images to DICOM server by shortcut key:
 - Save Image to DICOM Storage.
 - Save Clip to DICOM Storage.
 You can select <Save>, <F1>, <F2>, <F3>, <F4>, <F5>, <F6> on the control panel, or footswitch keys as user-defined keys.
 - (2) Define the shortcut key.
 - a) Enter the key configuration page: “[Setup]→[System Preset]→[Key Config]”.
 - b) Assign functions to the desired keys.
 - c) Click [OK] to confirm.
 - d) Select [Return] in the Setup menu to take effect.
 - (3) To set default server
 - a) Enter the “Storage” page: “[Setup]→[Network Preset]→[DICOM Service Setting]→Storage”.
 - b) Select the desired server in the server list, and click [Default.]
 - c) Click [Exit] to confirm the settings, and click [Return] in Setup menu to take effect.
 - (4) Press XX key on the control panel (which has been assigned as the shortcut key for “Save Image to DICOM Storage”), the image is frozen. The system captures the current screen image and sends it to the storage server as the single-frame file. Or,

Press XX on the control panel (assigned as shortcut key for “Send Clip to DICOM Storage”), the system will freeze the image and save it as multi-frame file and send it to the storage server.

- To send images for storage after an exam ends:
 - (1) Open [Setup] → [System Preset] → [General], and then check **Send/print Image after End Exam** in the Patient Management area.
 - (2) Set a default storage server as described before.
 - (3) After finishing the setting, you can perform image scanning, and each time you press <End Exam>, the system will send images to the default DICOM storage server.
- Send image/ clip to DICOM storage while storing image/ clip to hard disk
 - (1) Open [Setup] → [System Preset] → [General], then check **Send Image to DICOM Storage** or **Send Clip to DICOM Storage** in the Image/ clip Storage area.
 - (2) Set a default storage server as described before.
 - (3) After the setting, every time you save images or clips, the system will send images or clip to DICOM storage automatically.

12.3.2 DICOM Print

DICOM Print is used to send image(s) to DICOM print server to print images.

- Print image in iStation/Review/main screens
 - (1) Select image(s), operations are the same with DICOM storage.
 - (2) In the Send To dialogue box, select a DICOM print server. (Procedures are the same with those in DICOM Storage).
 - (3) Click [OK] to send print task.
- To send images by shortcut key

You can send single frame image to DICOM server by shortcut key.

 - (1) Define the shortcut key for “Send Image to DICOM Server” in the path: [Setup] → [System Preset] → [Key Config].
 - (2) Set a default print server. For details, please refer to “12.1.4.2 Print Service Setting”.
 - (3) Press XX on the control panel (assigned as the shortcut key), then the system sends the image to the print server.
- To print image after an exam ends
 - (1) Open [Setup] → [System Preset] → [General], then check **Send/print Image after End Exam** in the Patient Management area.
 - (2) Set a default print server. For details, please refer to “12.1.4.2 Print Service Setting”.
 - (3) After finishing the setting, you can perform image scanning, and each time you press <End Exam>, the system will send images to the default DICOM print server.
- Send image to DICOM printer while storing image to hard disk
 - (1) Open [Setup] → [System Preset] → [General], then check **Send Image to DICOM Printer** in the Image/ clip Storage area.
 - (2) Set a default storage server as described before.
 - (3) After the setting, every time you save images or clips, the system will send images to DICOM printer to print the image automatically.

12.3.3 DICOM Worklist

After successfully connected DICOM Worklist server with ultrasound system, you can query patient records from Worklist server, and then import the desired information to your system.

- To query patient information via Worklist server:
 - (1) Press <Patient> to enter Patient Info screen.
 - (2) Click [WorkList] to enter the WorkList page.

The screenshot shows the DICOM Worklist application interface. The window title is "WorkList". The interface is divided into several sections:

- Query Section:** Contains input fields for Patient ID, Patient Name, Accession #, Search Key (set to "Requested Procedure ID"), WorkList Server, and Exam Date (02/11/2009). There are "Query" and "Clear" buttons.
- Records Section:** Displays "0 records are listed" above a table with columns: Patient ID, Name, Accession #, Exam Description, Exam Date, Gender, and DOB. The table is currently empty.
- Bottom Section:** Contains buttons for "Start Exam", "Transfer", "Show Detail", and "Exit".
- System Tray:** Shows the time 16:57.

- (3) Query patient information:
 - a) Set query criteria among Patient ID, Patient Name, Accession #, Search Key, Worklist Server or Exam Date. The default exam date is the current date.
 - b) Click [Query].
 - c) The scheduled patients, which meet the criteria, are displayed in the lower part of the screen.
 - d) After the first query, you can perform the second query based on the previous results. The scheduled patients in the list will update in real time.
- (4) Select the desired patient record in the displayed patient list, and
 - Select the desired patient and click [Start Exam], the patient information is imported into the system and then an exam is started.
 - Click [Transfer], the patient information is imported into the Patient Info screen. Edit the patient information in the Patient Info screen, and select [OK] to start a new exam.
- (5) To show patient information in details:
 - a) Click to select a patient record.
 - b) Click [Show Detail] to view the detailed patient information and properties.

- Use the automatic query function via Worklist server
 - (1) Enter DICOM Service Preset screen, and open the Worklist page: [Setup]→[Network Preset]→[DICOM Service]→Worklist.
 - (2) Select an item in the service list, and click [Default] to set the server to be the default service.
 - (3) Click [Exit] and click [Return] in the Setup menu.
 - (4) Press <Patient> to enter Patient Info screen.
 - (5) Click [WorkList] to enter the WorkList page.
 - (6) The system queries intraday patients via Worklist server automatically and the patient records will appear in the list.

In the off-line status, you can:

- Perform a second query; or,
- Click [Show Detail] to view the patient information in details.

12.3.4 MPPS

MPPS is used to send exam status information to the configured DICOM server. This can acquaint other medical devices with the current exam progress and facilitate better arrangements for patients.

- After you preset the Worklist server and MPPS server, if the system retrieves patient information from Worklist server to begin exam, it will send exam status information to MPPS server of whether the exam is undergoing or ended. If the sending fails, the system resend automatically.

The status information is described as follows:

- When you begin an exam, the system sends status information “In Progress” to MPPS server.
- When the exam is ended, the system sends status information “Completed” to MPPS server.
- When a paused exam is continued, the system sends status information “In Progress” to MPPS server.
- When an exam is cancelled, the system sends status information “Discontinued” to MPPS server.
- When an ended exam is activated, the system sends status information “In Progress” to MPPS server.

12.3.5 Storage Commitment

Storage commitment is used to confirm whether images or structured reports are successfully stored to the DICOM server.

Before storage commitment, you should set a default storage commitment server.

- Storage commitment after sending images on iStation screen
 - (1) Press <iStation> to enter iStation screen.
 - (2) Select an exam record (the exam is suspended or inactive and image(s) is/are stored in the exam record), click [Send To] button at the right side of patient list to open the Send To dialogue box.
 - (3) Click to select “DICOM” in the “Target” box on the left side, and then select the DICOM storage server in the “Storage Server” box on the right side.

(4) Click [OK] to start sending. The system will send all the images stored in the exam record to the storage server, meanwhile, it will send storage commitment to the storage commitment server.

- To send storage commitment after an exam ends
 1. Open [Setup] → [System Preset] → [General], then check  in the Patient Management area.
 2. Set the default storage server and storage commitment server (refer to “12.1 DICOM Preset”).
 3. After finish the above settings, every time you press <End Exam>, the system will send images to the default DICOM storage server for storage and storage commitment to default DICOM storage commitment server.

If images are successfully send to the storage server, the storage commitment server will return information about the successful image storage. In the iStation screen, you will see a tick “√” marked on in the list below .

Storage commitment is confined to the whole exam, while each image sending will not be indicated.

NOTE: Multi-frame storage is not allowed if “Allow Multiframe” is not selected([Setup]→[Network Preset]→[DICOM Service Setting]→Storage). For example, if there is multi-frame file in the exam to be sent, then only single-frame image storage will be performed, and after the storage is completed, there is no “√” marked in the list below  in the iStation screen.

12.3.6 Query/ Retrieve

The query/ retrieve function is employed to query and retrieve the patient exam records in a designated server.

After setting the DICOM query/ retrieve server, you can perform the query/ retrieve function in iStation screen.

1. Open iStation screen: press <iStation> or press <Patient> and click [iStation].
2. Click [Query/ Retrieve] to enter the following screen.

3. Select the server in “Server and Service” area for the source and the destination.
4. Enter the query information, such as patient name, patient ID, accession number, exam time, and select keyword for searching.
Click [Clear] to empty the entered query information.
5. Click [Query], the system performs the query to the server and lists out the result into the patient (source) list.
You can perform a second query based on the preview results.
6. Select one or more patient records according to the actual situation.
Click [Select All] to select all the patient records listed.
Click [Deselect All] to deselect all the patient records listed.
7. Click [Retrieve] to retrieve the patient records in the DICOM query/ retrieve server into the system.
8. Click [Exit], you can see the retrieved patient records listed in the iStation screen.

12.4 DICOM Media Storage

The system supports to save patient data to the external media in DCM format. Meanwhile, in the system, you can view the saved DCM files from external media.

■ Media storage:

1. Select patient record(s) in the iStation screen.
2. Click [Backup] to enter the following dialogue box:



3. Select destination in the drop-down list (CD/DVD/USB disk) and select “DICOM Format”.
4. Set whether to remove patient exam data or only images from the local hard disk.
5. Click [Backup] to begin storage.

If the backup succeeded, there will be a tick marked in the Backup list in iStation screen; otherwise, no tick is marked.

Tips:

There should be no DICOMDIR/ DCMIMG/IHE_PDI files in the external storage media of the same name with the one being backed up, otherwise, the backup can't proceed. Please make sure there is enough storage space; otherwise, backup may fail due to space shortage.

■ **Media review:**

1. Connect the external media with DCM files to the system.
2. Select the data source in iStation screen, and the visible data will be shown.

If there are several kinds of data on the media, the system will ask you to select the format, as shown in the following:



Data Restore:

1. If the DICOM format data is backed up to external media, you can restore the data to the system from the media.
2. Review the data stored in the external media.
3. Select the data to be restored in iStation.
4. Click [Restore] in the iStation screen. If the data to be restored already existed in the system, it asks whether to overwrite the data or not.

NOTE: Only the system accessible media can be selected.

12.5 Structured Report (SR)

The system supports DICOM OB/ GYN structured report, Cardiac structured report and Vascular structured report, and for OB, GYN, Vascular and Cardiac exams, structured report functions are included in DICOM storage, DICOM storage commitment and DICOM media storage.

■ Storage and storage commitment of structured report

1. Open “[Setup]→[Network Preset]→[DICOM Service Setting]” to enter the screen.
Select from drop-down list of “SR storage” option.
2. After finish the settings above, the structured report will be sent when sending DICOM storage.
3. After successful storage of both image and structured report, you can see the storage commitment mark “ ✓ ” in the list below  in the iStation screen.

■ Back up structured report (SR)

When record or store the exam that has a structured report to the external media (DICOMDIR), the structured report can be backed up together.

12.6 Showcase Recording

Showcase software can be employed for DICOM image file viewing.

When record DICOM files (both files backed up as DICOMDIR format and files transformed into DICOM files by clicking [Send To]) and structured reports, the showcase can be recorded to the CDs together. Insert a CD containing showcase software, the showcase runs automatically.

<p>NOTE: To view the DCM files successfully, it is suggested to install NET Framework (Visual Studio.Net) of a version later than 2.0, if your computer was installed with TortoiseSVN.</p>
--

12.7 DICOM Task Management

DICOM Task Management is used to view task progress or manage tasks after sending images for storage, print, or media storage.

Please refer to “11.8 Patient Task Management” for details.

13 Probes and Biopsy

13.1 Probe

NOTE: For details of storage time and condition for disinfected probes or sterilized probes and brackets, please refer to Technical standard for Disinfection of Medical and Health Structures.

The system supports the following probes:

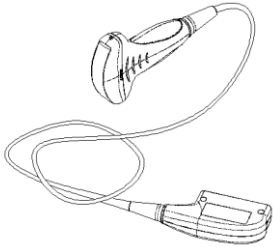
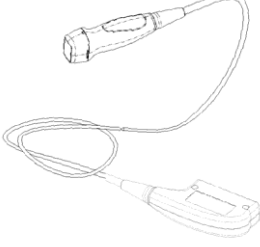
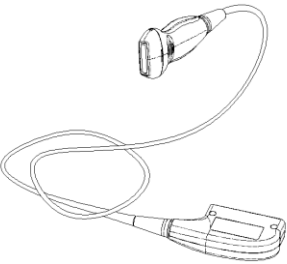
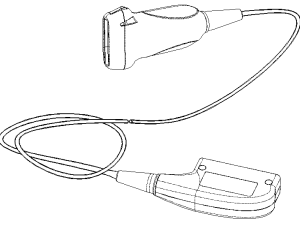
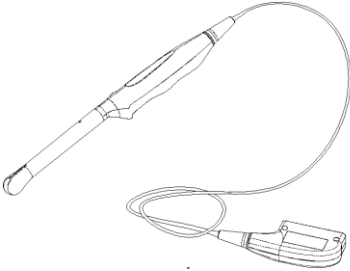
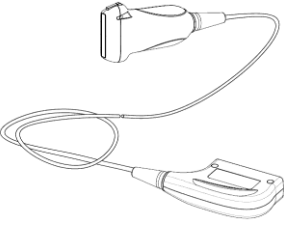
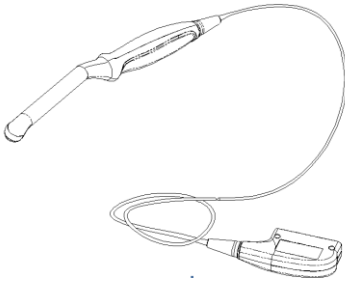
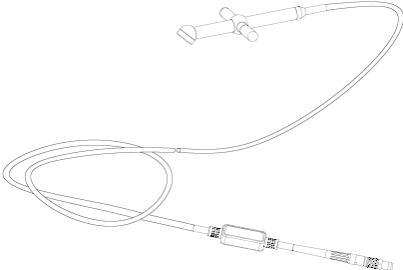
Probe Model	Illustration	Probe Model	Illustration
C5-2s		P12-4s	
L14-6s		L12-4s	
V10-4s		L14-6Ns	
V10-4Bs		CW2s	

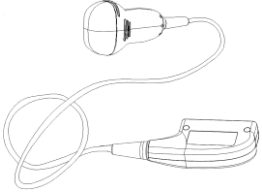
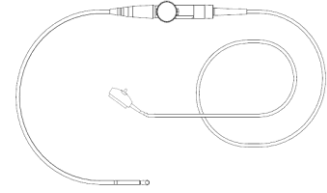
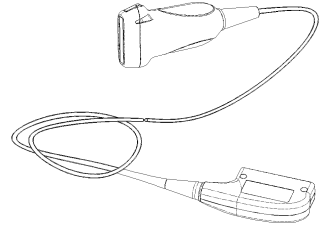
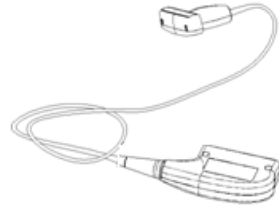
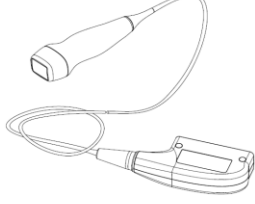
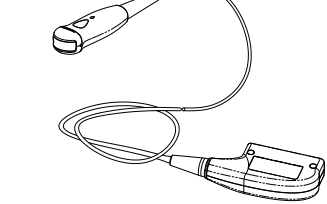
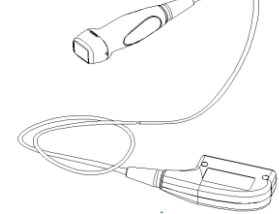
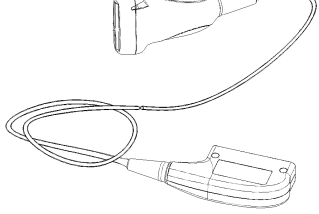
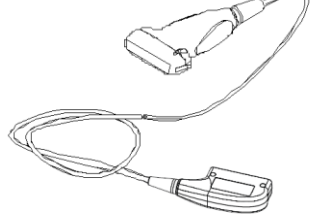
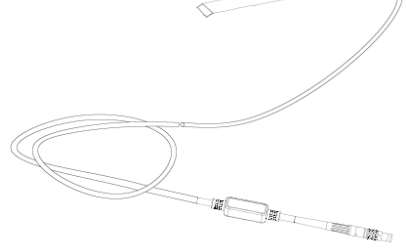
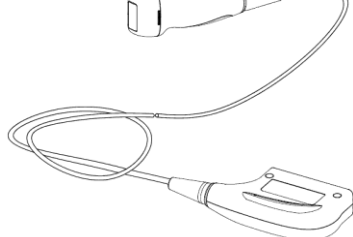
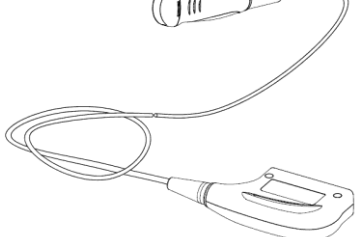
Probe Model	Illustration	Probe Model	Illustration
4CD4s		P7-3Ts	
7L4s		7LT4s	
P7-3s		6C2s	
P4-2s		L7-3s	
7L5s		CW5s	
SP5-1s		C11-3s	

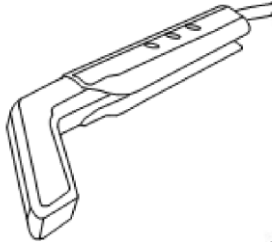
Probe Model	Illustration	Probe Model	Illustration
L16-4Hs			

For details of probe P7-3Ts, please refer to P7-3Ts Ultrasonic Transducer Operator's Manual.

13.1.1 Name and Function of Each Part of the Probe

The basic structures and corresponding functions of probes are basically the same. The following will take probe 7L4s as an example to illustrate.

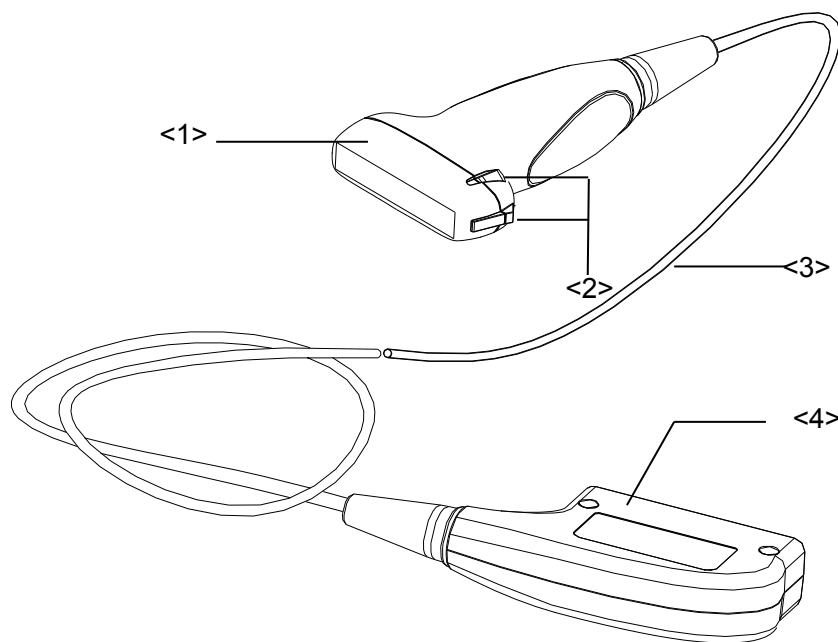

No.	Name	Function
<1>	Probe head	It converts the electrical signal into ultrasound signal, making the sound beams focus in the given direction; meanwhile, it will receive the ultrasound signal and then convert the received signal into electrical signal. The lens on the surface is the acoustic lens. Apply ultrasound gel on the acoustic lens.
<2>	Needle-guided bracket fix tabs and grooves	Used to mount the needle-guided bracket.

No.	Name	Function
<3>	Probe cable	Used to transmit electrical signals between the probe body and connector.
<4>	Probe connector	Used to connect the probe to the ultrasonic diagnostic system.

Tips:

The probes' structure marked <2> in the figure above may vary with the matched needle-guided brackets.

13.1.2 Orientation of the Ultrasound Image and the Probe Head

The orientation of the ultrasound image and the probe are shown as below. The "Mark" side of the ultrasound image on the monitor corresponds to the mark side of the probe. Check the orientation before the examination (Here takes linear probe as an example).

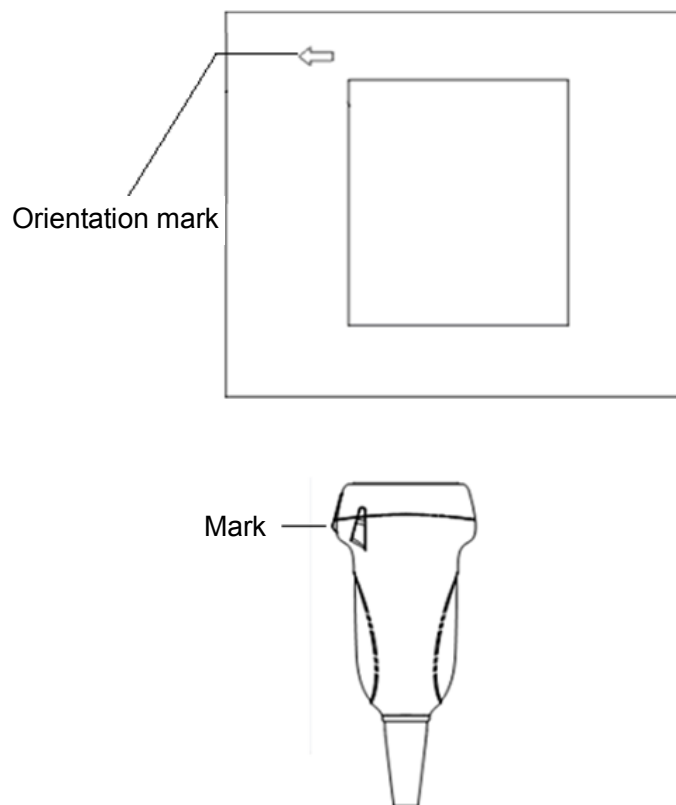

13.1.3 Procedures for Operating

This section describes general procedures for operating the probe. The proper clinical technique to be used for operating the probe should be selected on the basis of specialized training and clinical experience.

■ Procedures for operating (with biopsy function):

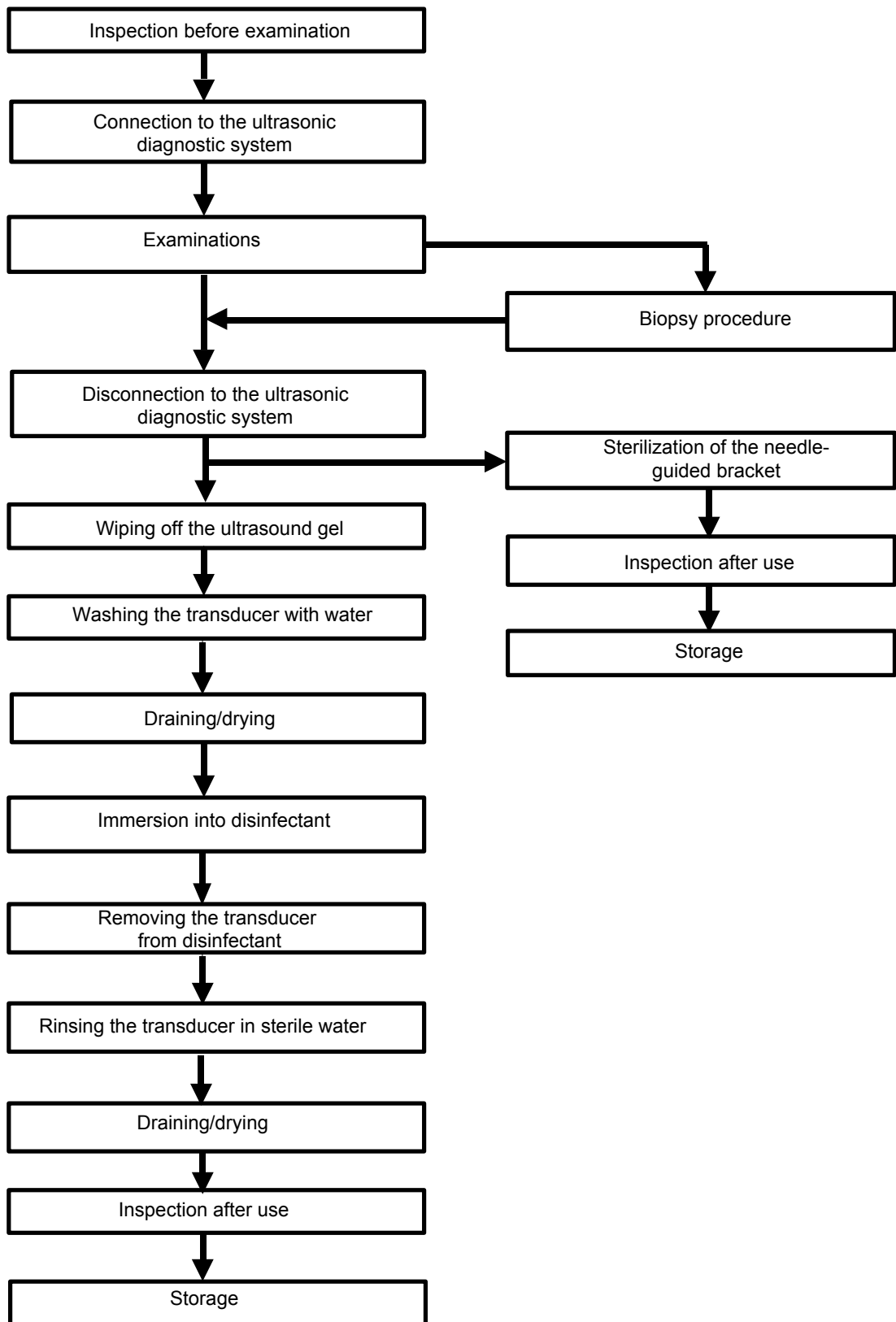

■ Procedures for operating (with no biopsy function):

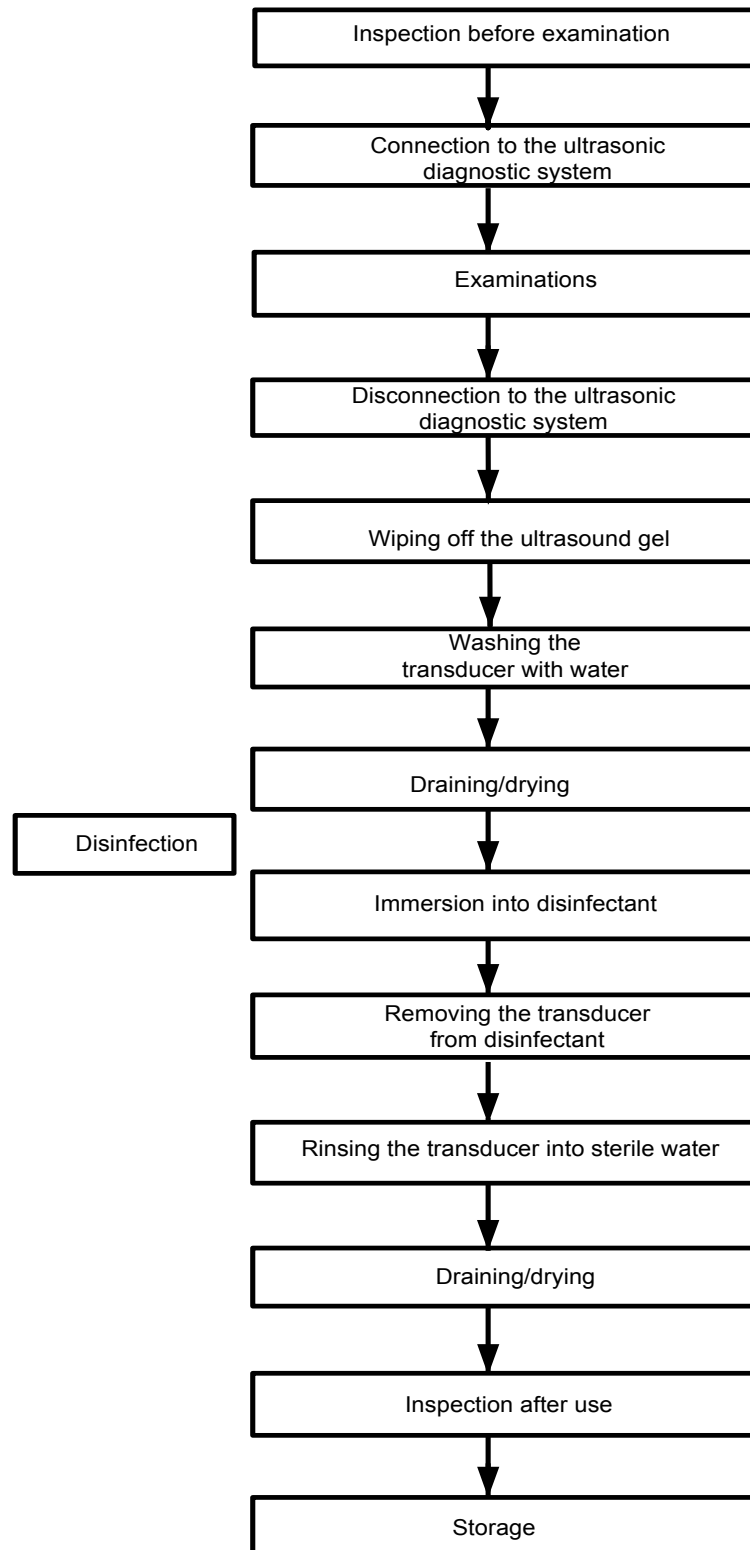

 **WARNING:** Disinfect the probe and sterilize the needle-guided bracket before and after an ultrasound-guided biopsy procedure is performed. Failure to do so may cause the probe and the needle-guided bracket become source of infection.

13.1.4 Wearing the Probe Sheath

A legally marketed probe sheath must be installed over the probe before performing intra-cavitary and biopsy examination. Protective barriers may be required to minimize disease transmission. Probe sheaths are available for use with all clinical situations where infection is a concern.

To order probe sheath, contact:

CIVCO Medical Instruments Co.

102 First Street South, Kalona, IA 52247-9589 USA Tel: 1-319-656-4447

E-mail: info@civco.com

<http://www.civco.com>

 CAUTION:	<ol style="list-style-type: none">1. Be sure to cover the probe with a new (unused) probe sheath to prevent infection during examination. If the package of a probe sheath is open or broken, the sterilization of the probe sheath may not be sufficient. DO NOT use such a probe sheath.2. The cover contains natural rubber latex and talc that can cause allergic reactions in some individuals.3. DO NOT use an expired probe sheath. Before using probe sheaths, verify whether the term of validity has expired.
---	---

Method (for reference only):

1. Place an appropriate amount of gel inside the sheath or on probe face. Poor imaging may result if no gel is used.
2. Insert the probe into the sheath; make sure to use proper sterile technique. Pull cover tightly over probe face to remove wrinkles and air bubbles, taking care to avoid puncturing cover.

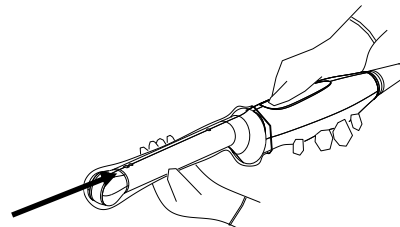
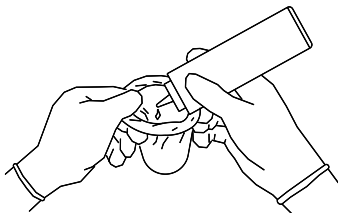

3. Secure the sheath with enclosed elastic bands.
4. Inspect the sheath to ensure there are no holes or tears.

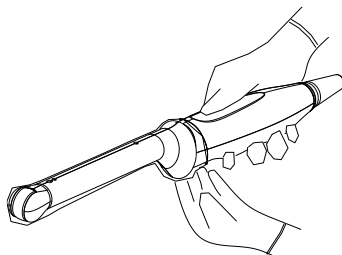

Refer to the following dimension table of all probes to choose the necessary probe sheath type.

Model	Length(mm)	Width(mm)	Height(mm)	Cable Length(mm)
6C2s	95	33.5	24.8	2260±50
C5-2s	112.4	76.3	25.6	2260±50
7L4s	101.6	61	25.7	2260±50
L14-6s	91.4	47.1	22.8	2260±50
7L5s	102.4	69.7	25.9	2260±50
P4-2s	102.7	38.1	27.8	2260±50
L12-4s	101.6	61	25.7	2260±50
P7-3s	79	34	25	2260±50
P12-4s	67	22	22	2260±50
V10-4s	315.84	40.95	32.5	2260±50
V10-4Bs	323	40.95	32.5	2260±50
4CD4s	122.74	73	51.6	2260±50
L14-6Ns	101.6	61	25.7	2260±50
CW2s	120	80	18	2260±50
L7-3s	101.6	61	25.7	2260±50
7LT4s	50	49.1	20.4	2260±50
CW5s	123	11	11	2050±50
L16-4Hs	108	52	29	2000±200
SP5-1s	102	38	30	2260±50
C11-3s	94	33	25	2260±50

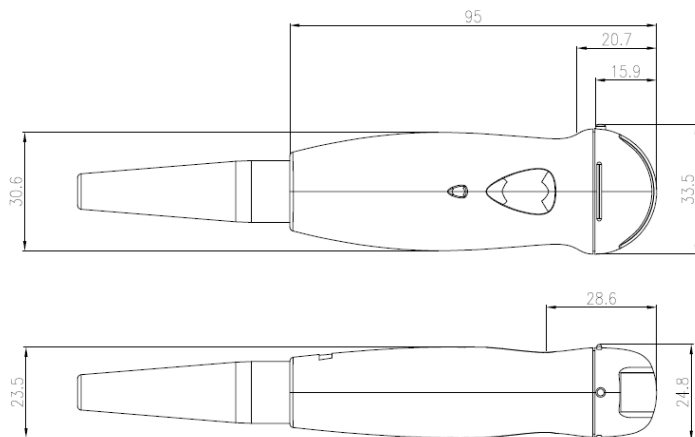

The above is a dimension illustration of the 6C2s probe.

You can select the probe sheath according to the actual application situation.

13.1.5 Probes Cleaning and Disinfection

After completing each examination, clean and disinfect (or sterilize) the probes as required. When biopsy procedures have been performed, be sure to sterilize the needle-guided bracket. Failure to do so may result in the probe and the needle-guided bracket becoming sources of infection.

Please follow the instructions in the manual for cleaning.



WARNING:

Never immerse the probe connector into liquid such as water or disinfectant. Immersion may cause electrical shock or malfunction.



CAUTION:

1. **When performing cleaning and disinfection of the probe to prevent infection, wear sterile gloves.**



2. **After disinfection, rinse the probe thoroughly with sterile water to remove all chemical residues. Chemical residues on the probe may be harmful to the human body.**

3. **No cleaning and disinfecting may result in the probe becoming a source of infection.**

NOTE:

1. After the examination, wipe off the ultrasound gel thoroughly. Otherwise, the ultrasound gel may solidify and degrade the image quality of the transducer.
2. **DO NOT** make the probe become overheated (more than 55°C) during cleaning and disinfections. High temperature may cause the probe to become deformed or damaged.

Cleaning

Please refer to the instructions in the manual and follow your hospital policy and procedures for cleaning.

1. Disconnect the probe from the system.
2. Wear sterile gloves to prevent infection.
3. Wash the transducer with clean water or soapy water to remove all the foreign matters, or, wipe the transducer with a soft ethyl carbamate sponge. Avoid using a brush, because it may damage the transducer.
4. Dry the transducer using a sterile cloth or gauze after rinsing. Do not dry the transducer by heating it.

Disinfecting with Sprays



CAUTION:

Use protective eyewear when disinfecting using sprays.

1. Wear sterile gloves to prevent infection.

2. After you have finished cleaning, spray the transducer with a disinfectant. Follow the disinfectant manufacturer's recommended contact time and mode.
3. Remove any residue with a water-moistened soft cloth on the transducer.
4. Wipe off water on the transducer using sterile cloth or gauze after washing.

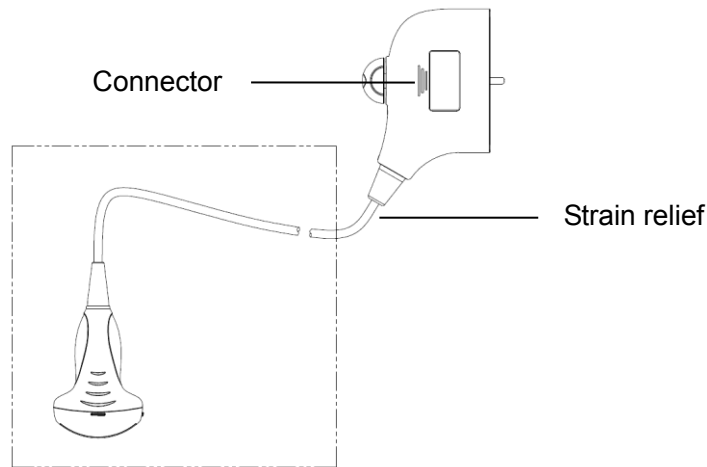

NOTE: Observe the graph here carefully to perform disinfection. Do not spray the strain relief on the connector end or the connector.

Disinfecting by Immersion

1. Wear sterile gloves to prevent infection.
2. Clean the transducer before disinfecting it. MINDRAY recommends the following solutions to disinfect the transducer.
 - Refer to the instructions provided by the chemical manufacturer concerning concentration of the disinfectant solution, method of disinfection and dilution and cautions during use. Do not soak the transducer connector or the cable near it into water or any solution.
 - Soak the transducer into the disinfectant solution for the shortest time the manufacturer recommends (for example, the shortest time recommended by the manufacturer for soaking Cidex OPA is 12 minutes).
 - Follow local regulations when selecting and using the disinfectant.
3. Rinse the transducer with plenty of sterile water (about 2 gallons) for at least 1 minute to remove all chemical residues on it. Or, follow the rinsing method recommended by the disinfectant manufacturer to rinse the transducer.
4. Wipe off the water on the transducer with sterile cloth or gauze after rinsing it. Do not dry the transducer by heating.

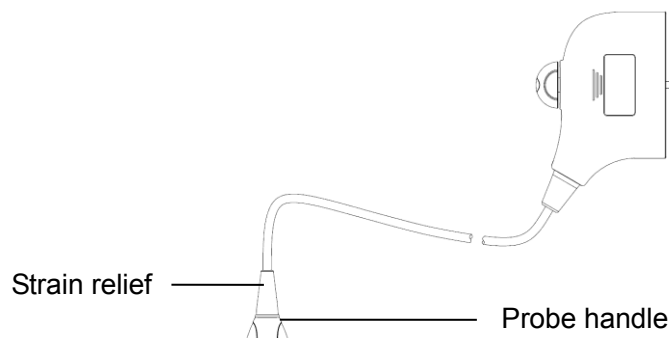

NOTE: 1. Observe the graph here carefully to immerse the transducer. Only soak parts of the transducer below the strain relief.

Compatible Disinfectants

For the disinfectants information, please refer to Disinfectant Compatible Chart.

For details about P7-3Ts disinfection, please refer to the P7-3Ts accompanying manual. Sterilization

For intra-operative probes (7LT4s), they have to be sterilized after completing each examination.

1. Wear sterile gloves to prevent infection.
2. Clean the probe before sterilizing it. MINDRAY recommends the following solutions to sterilize the probe.

Hydrogen Peroxide and Peroxyacetic Acid -based sterilization solution

Trade Name	Chemical Name	Procedures
MinnCare® Cold Sterilant	22% Hydrogen Peroxide 4.5% Peroxyacetic Acid	Dilute the sterilant with sterilized purified water (1:20). Immersed time: 11 hours. Temperature: 20°C-25°C. Please refer to the instructions provided by the manufacturer of the solution for details.

Before safety and performance is affected, probe 7LT4s can be sterilized by Minncare COLD STERILANT for at least 135 times (11 hours for one time).

Glutaraldehyde-based sterilization solution

Trade Name	Chemical Name	Procedures
Cidex Activated Dialdehyde Solution	2.4% Glutaraldehyde	Soak the transducer into the activated solution for 10 hours (20-25°C) Please refer to the instructions provided by the manufacturer of the solution for details.

Before safety and performance is affected, probe 7LT4s can be sterilized by Cidex Activated Glutaraldehyde Solution for at least 217 times (10 hours for one time).

- Refer to the instructions provided by the chemical manufacturer concerning concentration of the sterilization solution, method of sterilization and dilution and cautions during use.
 - Do not soak the probe connector or the cable near it into water or any solution.
 - Follow local regulations when selecting and using the sterilization solution.
3. Rinse the probe with plenty of sterile water (about 2 gallons) for at least 1 minute to remove all chemical residues on it. Or, follow the rinsing method recommended by the sterilization solution manufacturer to rinse the probe.
 4. Wipe off the water on the probe with sterile cloth or gauze after rinsing it. Do not dry the probe by heating.

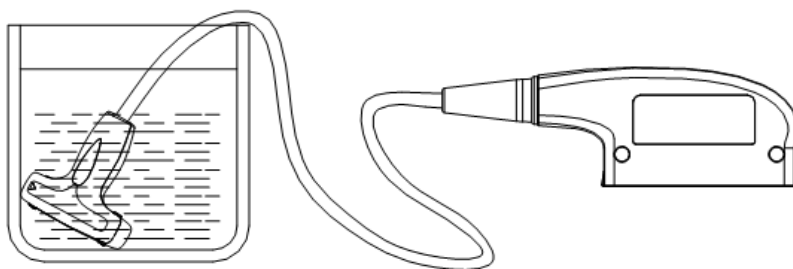

Immerse the probe in the solution (take 7LT4s as an illustration)

NOTE: Repeated disinfection may degrade the performance and safety of the probe.

13.1.6 Storage and Transportation

When all examinations for the day have been completed, confirm that the probe is in good condition. After disinfecting the probe, confirm that the probe is in good condition and store it in a suitable place so that the next examination can be conducted smoothly.

1. To prevent the probe from being damaged, DO NOT store it in locations where it may be exposed to:

- Direct sunlight or X-rays
- Sudden changes in temperature
- Dust
- Excessive vibration
- Heat generators

2. Store and transport the probe under the following ambient conditions:

- Ambient temperature: $-20^{\circ}\text{C} \sim 55^{\circ}\text{C}$
- Relative humidity: 30% \sim 95% (no condensation)
- Atmospheric pressure: 700 hPa \sim 1060 hPa

Store and transport the 4CD4s probe under the following ambient conditions:

- Ambient temperature: $-10^{\circ}\text{C} \sim 60^{\circ}\text{C}$
- Relative humidity: 30% \sim 95% (no condensation)
- Atmospheric pressure: 700 hPa \sim 1060 hPa

Store and transport the SP5-1s probe under the following ambient conditions:

- Ambient temperature: $-20^{\circ}\text{C} \sim 55^{\circ}\text{C}$
- Relative humidity: 20% \sim 95% (no condensation)
- Atmospheric pressure: 700 hPa \sim 1060 hPa

3. When the probe is sent to MINDRAY Customer Service Department or sales representative for repair, be sure to disinfect it and keep it in the carrying case to prevent infection.
4. Sterilize the carrying case as necessary.

13.2 Biopsy Guide



WARNING:

1. The person performing biopsy procedures must understand diagnostic ultrasound thoroughly and have been trained adequately, otherwise, side effects may be caused to the patient.
2. In situations listed below, the biopsy needle may fail to penetrate the target. The incorrect biopsy may cause various side effects in the patient.
Use a needle-guided bracket other than that provided.
Mount the needle-guided bracket incorrectly.
Use a biopsy needle that is unsuitable for the type of biopsy being performed.
Use a biopsy needle or guiding block that is unsuitable for the needle guide.
3. Before and after a biopsy procedure is performed, confirm that the needle-guided bracket is normal. Manually confirm that the parts of the needle-guided bracket do not slip off or move from their proper positions. If the needle-guided bracket is used when parts are not securely and correctly installed, the patient may be injured. If an abnormality is found on the needle-guided bracket, immediately stop using it and contact MINDRAY Customer Service Department or sales representative.
4. **DO NOT** use a needle-guided bracket when scanning is performed. The needle may advance in an incorrect direction and possibly injure the patient.
Never perform a biopsy during image scanning.
5. **DO NOT** freeze an image while performing biopsy procedure.
6. During biopsy procedures, the needle may deviate from the desired course due to the tissue characteristics or the type of needle. In particular, needles of small diameters may deviate to a greater degree.
7. Disinfect the probe and sterilize needle-guided bracket before and after each ultrasound-guided biopsy procedure is performed. Fail to do so may cause the probe and the needle-guided bracket become sources of infection.
8. The needle mark displayed on the ultrasound image does not indicate the actual position of the biopsy needle. Therefore, it should only be used as a reference. Always monitor the relative positions of the biopsy needle during the procedures.
9. Adjust the needle mark before the biopsy procedure is performed.

10. When performing biopsy procedures, use only sterile ultrasound gel that is certified to be safe. And manage the ultrasound gel properly to ensure that it does not become a source of infection.
11. When performing the operation concerning biopsy, wear sterile gloves.
12. Image of the biopsy target and the actual position of the biopsy needle:

Diagnostic ultrasound systems produce tomographic plane images with information of a certain thickness in the thickness direction of the probe. (That is to say, the information shown in the images consist all the information scanned in the thickness direction of the probe.) So, even though the biopsy needle appears to have penetrated the target object in the image, it may not actually have done so. When the target for biopsy is small, dispersion of the ultrasound beam may lead to image deviate from the actual position. Pay attention to this.

If the target object and the biopsy needle appear in the image as shown in the figures below (For reference only):

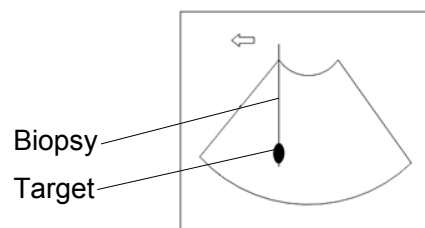

The biopsy needle appears to reach the target object in the image

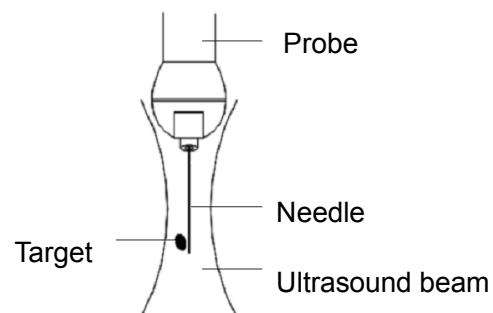

Dispersion of the ultrasound beam

The biopsy needle may not have actually entered the target object even though it appears to have done so on the image. To avoid this problem, note points below:

Do not rely only on the needle tip on the image. Pay careful attention to that, when the biopsy needle comes into the target object or contacts with it, the object should shift slightly.

Before you perform the biopsy, please evaluate the size of the object and confirm if the biopsy can be carried out.



CAUTION: When using the needle-guided bracket wear sterile gloves to prevent infection.

13.2.1 Basic Procedures for Biopsy Guiding

1. Select the appropriate needle-guided bracket and needle, and install them properly. For details, please refer to “13.2.4 Needle-guided Bracket Inspection and Installation”.
- Before biopsy guiding, you can preset bracket model, biopsy display and guide line dot type. For details, please refer to “ NGB-018

Biopsy Preset”.

2. Verify the biopsy guide line.
3. Move the cursor onto the image menu; navigate the cursor to [Other] item and press <Set> or the multifunctional knob. Click [Biopsy] to enter biopsy.
Tips:
 - If the current probe has no matched bracket; or, the image is frozen and the guide line is hidden before image frozen, then you can't enter Biopsy menu.
 - Before entering Biopsy menu, the system will prompt you “Please verify guidelines before biopsy”.
4. Set [Display] as “On” to display the guide line, select the bracket and guide line according to actual situation. For details, please refer to “13.2.5 Biopsy Menu”.
5. On the Biopsy menu, click [Verify] to enter the Verify menu to verify the guide line. After the verification, click [Save] on the menu to save the parameter setting. And then click [Exit] to return to Biopsy menu.
Tips:
 - If you switch the probe or needle-guided bracket during the biopsy, please verify the guide line again.
 - When exit the Biopsy Verify menu without saving the setting, system will confirm with you “Data have changed. Do you want to save the changes?” Click [OK] to save the setting and return to Biopsy menu.
6. Scan to locate the target. Center the target in the electronic guidezone path.

7. Direct the needle into the area of interest for specimen.
8. After extraction of the biopsy sample is completed, gently remove the probe from the body. To exit Biopsy menu: press <Esc>; or, navigate the cursor onto the Other menu.
9. Disassemble the items and properly dispose of these items as required.

 DANGER:	<p>Fail to match the guidezone displayed to the guide may cause the needle to track a path outside the zone.</p> <p>It is extremely important that when using the adjustable angle biopsy guides, the angle displayed on the screen matches the angle set on the guide, otherwise the needle will not follow the displayed guidezone which could result in repeated biopsies or patient injury.</p>
--	---

13.2.2 Needle-guided Brackets

A needle-guided bracket is available for purchase as an optional accessory; it is used in combination with the probe. Some of the probes have matched needle-guided bracket and needles. To order needle-guided brackets, contact MINDRAY Customer Service Department or sales representative.

For biopsy or treatment, ultrasound-guided biopsy procedures can be performed using the probe in combination with a needle-guided bracket (optional accessory) and a biopsy needle (provided by the user).

Note: NGB-010 bracket is not available with 03.02.00 version software.

Names of Parts

This section describes the parts and corresponding functions of each needle-guided bracket.

■ NGB-004:

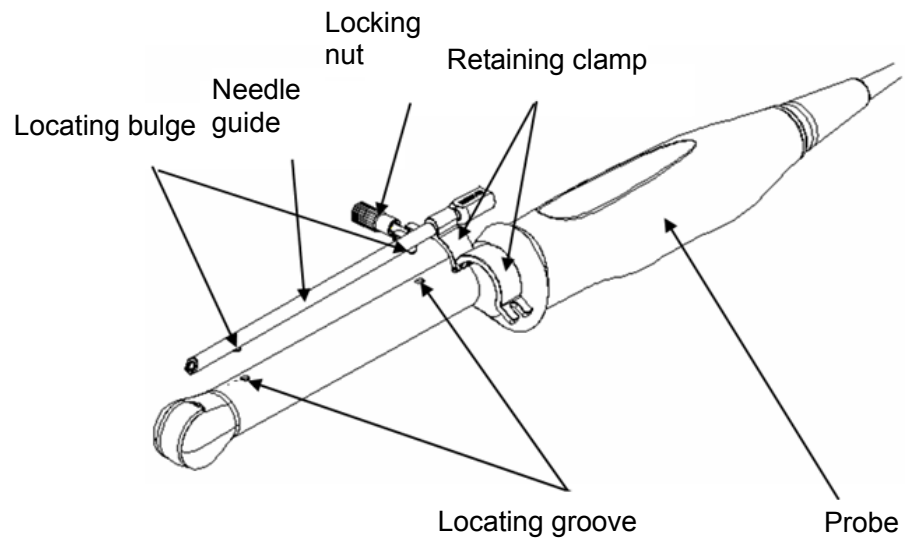

■ NGB-005

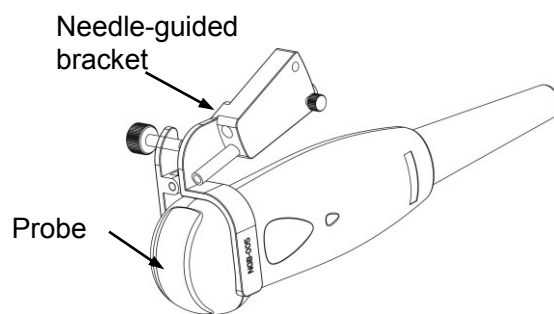
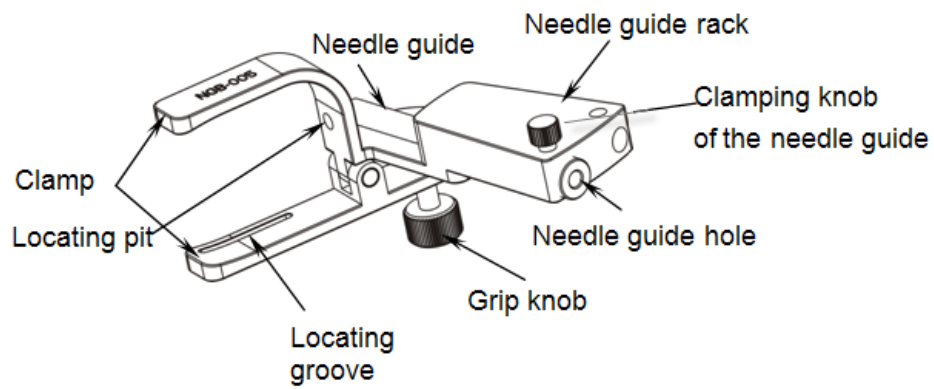

■ NGB-007

- Metal needle-guided bracket:

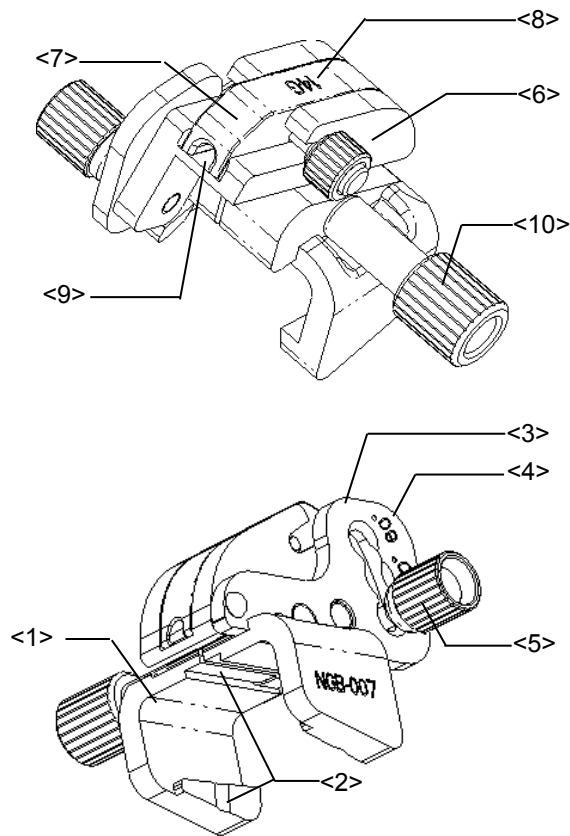

No.	Name	Description
<1>	Support of needle-guided bracket	Used for installing the needle-guided bracket on the probe.
<2>	Groove and tab of the needle-guided bracket	Respectively matches with the tab and groove of the probe
<3>	Angle adjusting base	There are 3 types of angles available to be adjusted.
<4>	Angle shift sign(40°, 50°, 60°)	Matched with the biopsy angle (40°, 50°, and 60°).
<5>	Angle pinch nut	Used for fixing the angle lock at a chosen angle.
<6>	Angle block	Used for determining the angle of the biopsy; different specifications of blocks can be used.
<7>	Guiding block	Used for installing biopsy needle; there are five specifications of guiding blocks for different biopsy needles.
<8>	Specification of guiding block (14G)	Matched with the corresponding biopsy needle (14G).
<9>	Needle guide hole	Used for installing the biopsy needle.
<10>	Pinch nut of needle-guided bracket	Used for locking the needle-guided bracket and the probe

- Plastic needle-guided bracket:

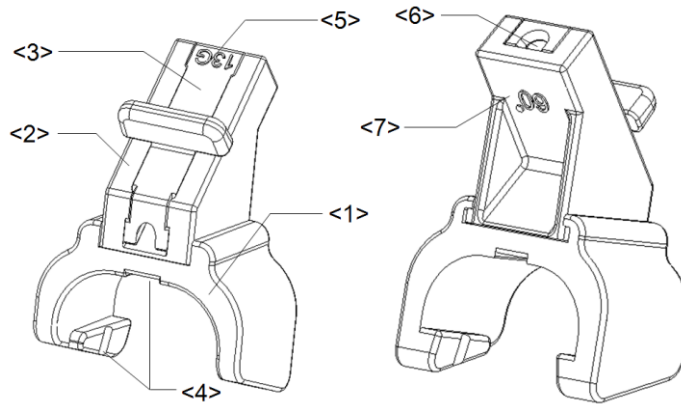

No.	Name	Description
<1>	Support of needle-guided bracket	Used for installing the needle-guided bracket on the probe.
<2>	Angle block	Used for determining the angle of the biopsy; there are three specifications of blocks of angle.
<3>	Guiding block	Used for installing biopsy needle; there are five specifications of guiding blocks for different biopsy needles.
<4>	Groove and tab of the needle-guided bracket	Respectively matched with the tab and groove of the probe.
<5>	Specification of guiding block (13G)	Matched with the corresponding biopsy needle (13G).
<6>	Needle guide hole	Used for installing the biopsy needle.
<7>	Specification of angle block (60°)	Corresponding to the size of the biopsy angle (60°).

■ NGB-010

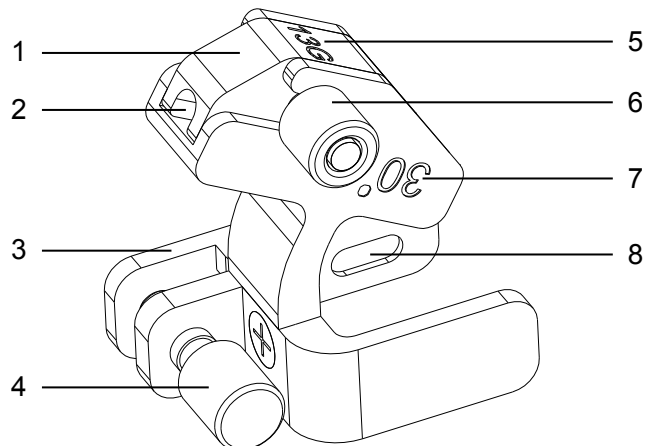

No.	Name	Description
1	Guiding block	Used for installing biopsy needle; there are five specifications of guiding blocks for different biopsy needles.
2	Guiding hole of the biopsy needle	Used for installing the biopsy needle.
3	Support of needle-guided bracket	Used for installing the needle-guided bracket on the probe.
4	Knob of fixing needle-guided bracket	Used for fixing the needle-guided bracket on the probe.
5	Specification of guiding block (13G)	Matched with the corresponding biopsy needle (13G).
6	Knob of fixing the guiding block	Used for fixing the guiding block.
7	Needle guide angle	The needle guide angle of this needle-guided bracket.
8	Grooves of the needle-guided bracket	Matched with the tabs of the probe.

■ NGB-011

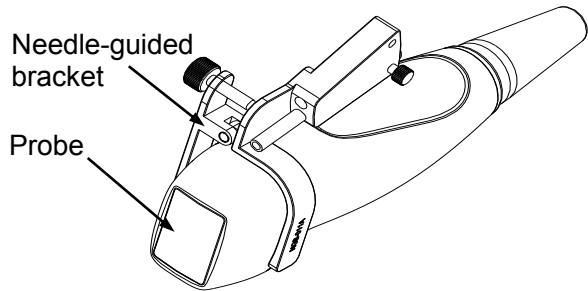
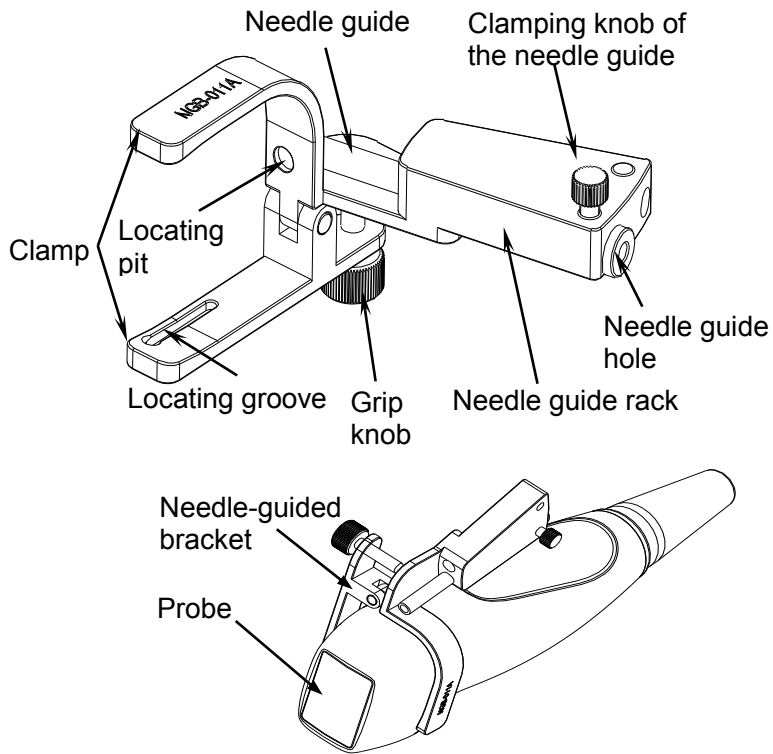

■ NGB-015

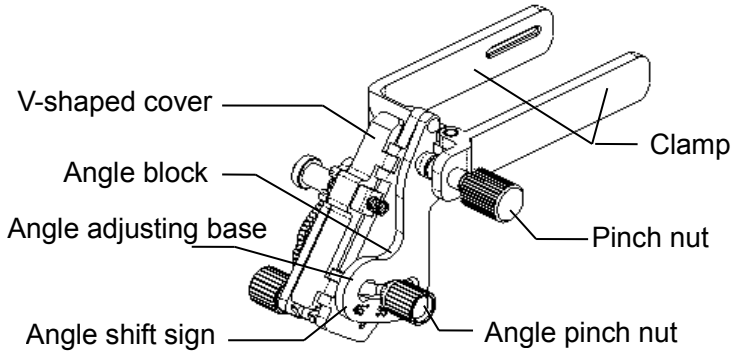
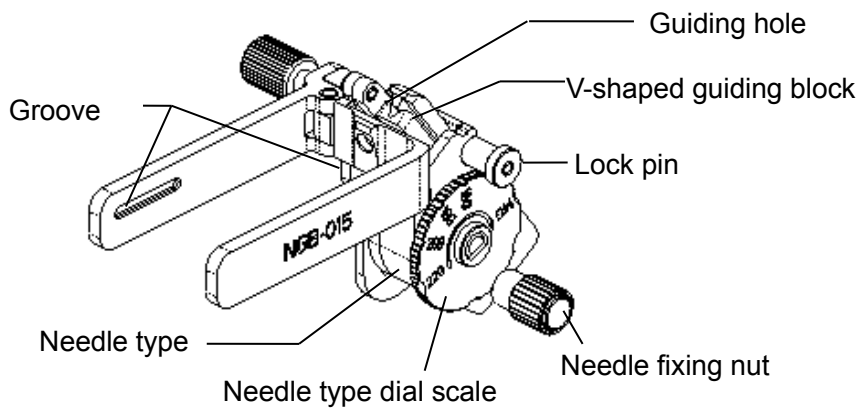

■ NGB-016

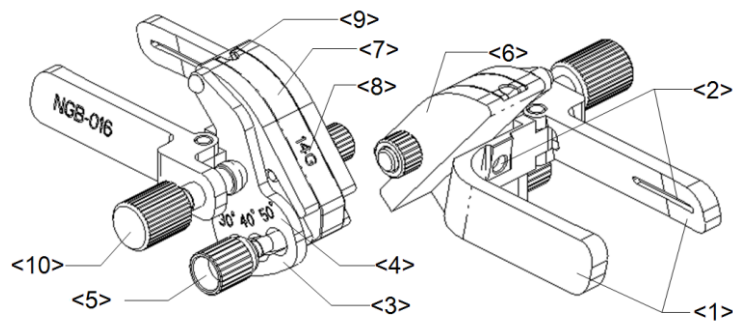

No.	Name	Description
<1>	Clamp of needle-guided bracket	Used for installing the needle-guided bracket on the probe.
<2>	Groove of the needle-guided bracket	Matches with the tab of the probe.
<3>	Angle adjusting base	There are 3 types of angles available to be adjusted.
<4>	Angle shift sign (30°, 40°, 50°)	Matches with the biopsy angle. (30°, 40°, 50°).
<5>	Angle pinch nut	Used for fixing the angle lock at a chosen angle.
<6>	Angle block	Determines the angle of the biopsy; different specifications of blocks can be used.
<7>	Guiding block	Used for installing the needles of different specifications, 5 types of needles are available.
<8>	Specification of guiding block (14G)	Matched with the corresponding biopsy needle (14G).
<9>	Guiding hole of biopsy needle	Used for installing the needles.
<10>	Pinch nut of needle-guided bracket	Used for locking the needle-guided bracket and the probe.

■ NGB-018

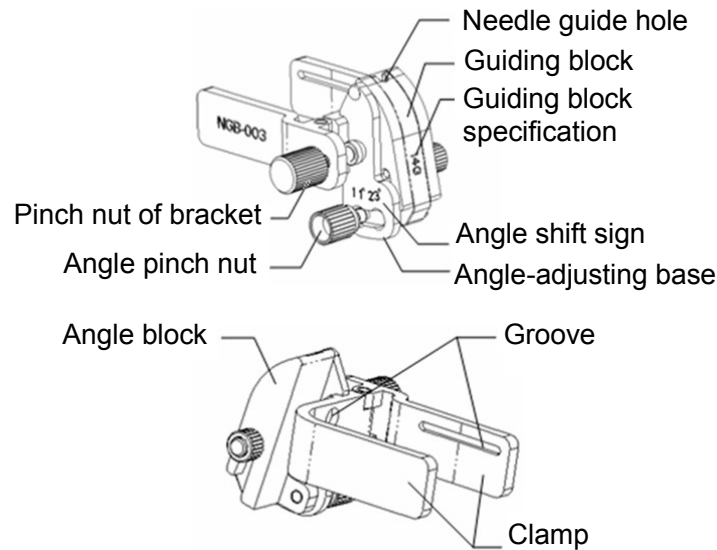

13.2.3 Biopsy Preset

Enter the biopsy preset page: [Setup]→[System Preset]→“Biopsy”.

■ Bracket preset

To set the default bracket for a probe:

1. Select a probe model in the Probe Model list, all the supported bracket models will be displayed in the “Bracket Model” list on the right side. (If the selected probe has no bracket matched, no model is displayed.)
2. Click to select a bracket model on the Bracket Model list.
3. Click [OK] to confirm the setting and return to Setup menu.

■ Parameter preset

To set if to display/hide guide line and dot type.

1. Check [Guide Line Display] to set the guide line display, otherwise, the guide line is hidden when enters biopsy status.
2. On “Guide Line Dot Type” column, select a dot type among Small, Medium and Big.
3. Click [OK] to confirm the setting and return to Setup menu.

13.2.4 Needle-guided Bracket Inspection and Installation

Inspection of the Needle-guided Bracket

Be sure to perform inspections before and after use of the needle-guided bracket. If an abnormality is found on the needle-guided bracket, immediately stop using it and contact MINDRAY Customer Service Department or sales representative.

1. Sterilize the needle-guided bracket before and after use.
2. Confirm that the needle-guided bracket is free of damage, deformation, stripping, and malfunction, loose or missing parts.

3. Confirm that the needle-guided bracket is securely mounted in the correct position.

Installing the Needle-guided Bracket

■ NGB-004

1. Put on the sterile probe sheath.

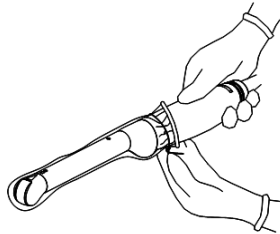

2. Open the retaining clamp, align the needle-guided bracket with the probe to locate the locating bulge on the needle guide to the locating grooves on the probe, and then turn the retaining clamp to match it with the probe (See the figure below).

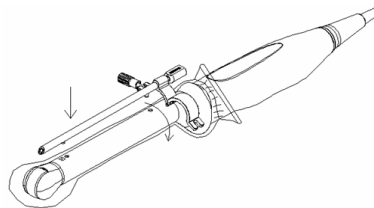

3. When the retaining clamp is turned to the right position, the locking nut will lock the retaining clamp and the needle-guided bracket is then mounted to the right position.

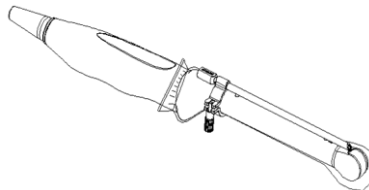

■ NGB-005

- (1) Put on the sterile probe sheath.
- (2) Inosculate the locating groove on the clamp with the two raised edges on the probe head and aligning the locating pit of the clamp to the convex point on the probe head.
- (3) Turn the grip knob at the tail of the needle-guided bracket tightly.

■ NGB-007

- Metal needle-guided bracket
 - a) Put on the sterile probe sheath.
 - b) Select a proper needle-guided bracket, and match the groove and tab with the tab and groove of the probe respectively. Mount the bracket onto the probe.

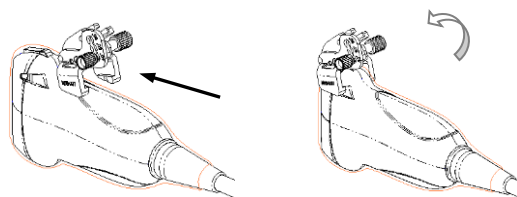

- c) Screw the pinch nut of the needle-guided bracket to confirm that the needle-guided bracket is properly installed on the probe.
- d) Select a proper guiding block and push it into the groove above the angle block, and clamp it tightly.



- e) Screw the nut of the block to secure the block.
- f) Insert a biopsy needle with the same specification as that of the guiding block into the hole of the guiding block.

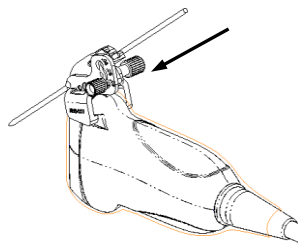

- Plastic needle-guided bracket

- a) Put on the sterile probe sheath.
- b) Hold the probe by one hand, select the proper needle-guided bracket, and hold it with the other hand. Align the narrow end tab of the needle-guided bracket with the groove of the probe, then push the needle-guided bracket forward, making the tabs and the grooves of the needle-guided bracket to match with the grooves and tabs of the probe.

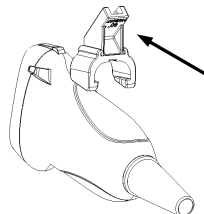

- c) Check manually to confirm that the needle-guided bracket is securely installed on the probe.
- d) Select a proper guiding block and push it into the groove above the angle block, and clamp it tightly.

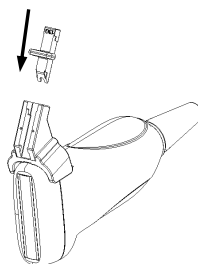

- e) Insert a biopsy needle with the same specification as that of the guiding block into the hole of the guiding block.

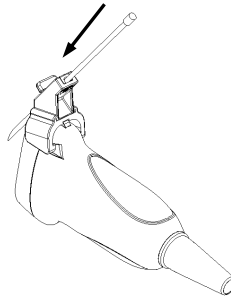

■ NGB-010 metal/needle detachable needle-guided bracket

- (1) Put on the sterile probe sheath.
- (2) Hold the probe by one hand, select proper needle-guided bracket, and hold it with the other hand, and align the grooves of the needle-guided bracket with the tabs of the probe, then push the needle-guided bracket forward, making the grooves of the needle-guided bracket to match with the tabs of the probe. Set the needle-guided bracket at the desired position, turn tightly the knob of fixing needle-guided bracket to fix the needle-guided bracket.

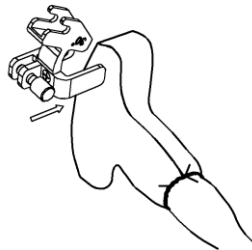

- (3) Check manually to confirm the needle-guided bracket is securely installed on the probe.
- (4) Select a proper guiding block and push it into the groove above the support of needle-guided bracket, then turn tightly the knob of fixing the guiding block to fix the guiding block on the support of needle-guided bracket.



- (5) Insert a biopsy needle with the same specification as that of the guiding block into the hole of the guiding block.

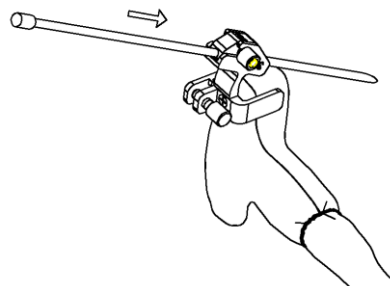

■ NGB-011

1. Put on the sterile probe sheath.
2. Inosculate the locating groove on the clamp with the two raised edges on the probe head and align the locating pit of the clamp to the convex point on the probe head.
3. Turn the grip knob at the tail of the needle-guided bracket tightly.

■ NGB-015

1. Put on the sterile probe sheath.
2. Hold the transducer by one hand, select the proper needle-guided bracket, and hold it with the other hand. Match the groove of the bracket with the tab of the transducer. Amount the bracket onto the transducer.

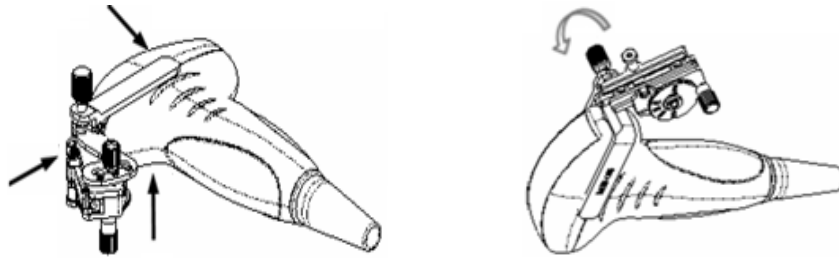

3. Screw the pinch nut of the needle-guided bracket to confirm that the needle-guided bracket is properly installed on the transducer.
4. Adjust the dial scale to the required needle type shift, and then screw the needle fixing nut to lock the dial scale. (To adjust the dial scale you have to loose the needle fixing nut first.)
5. Pull the lock pin and close the V-shaped cover to fix the lock pin in the groove of the needle type adjusting base, so as to install the needle into the guiding hole.

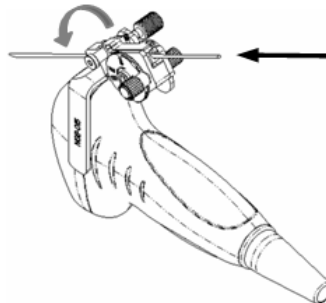

■ NGB-016

1. Put on the sterile probe sheath.
2. Select a proper needle-guided bracket, and match the groove with the tab of the probe. Mount the bracket onto the probe.

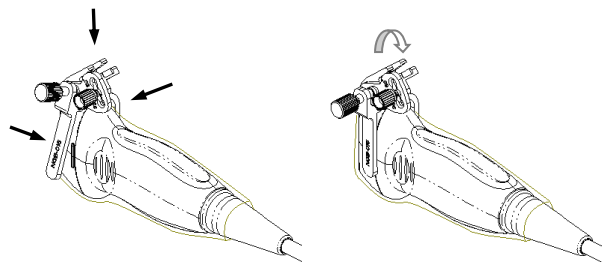

3. Screw the pinch nut of the needle-guided bracket to confirm that the needle-guided bracket is properly installed on the probe.

4. Select the appropriate guiding block, and fit it into the groove on the angle block.

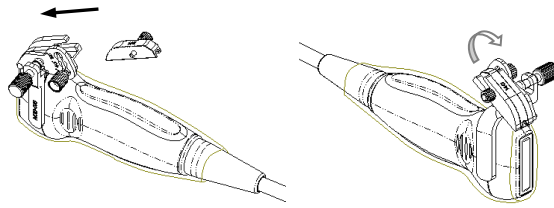

5. Screw the nut on the guiding block to secure the guiding block with the needle-guided bracket.
6. Insert the needle of the same specification with that of the guiding block into the guiding hole.

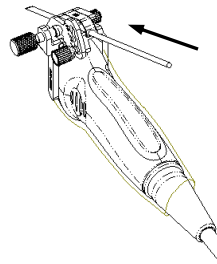

■ NGB-018

- (1) Put the sterile probe sheath on.
- (2) Select a suitable needle-guided bracket and match the groove to the tab of the transducer. Mount the bracket onto the transducer. The needle-guided brackets may be different from each other, but the methods are the same.

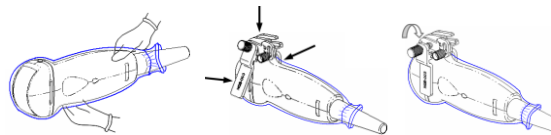

- (3) Screw the pinch nut of the needle-guided bracket to ensure that the needle-guided bracket is properly installed on the transducer.
- (4) Select a suitable guiding block and push it into the groove above the angle block.

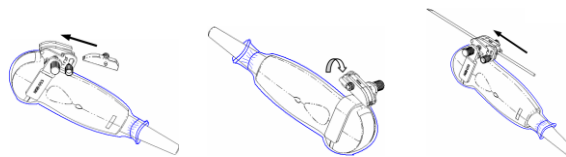

- (5) Screw the block's nut to secure the block.
- (6) Insert a biopsy needle with the same specification as that of the guiding block into the guiding block hole.

⚠ CAUTION: Ensure that all guide parts are seated properly prior to performing a biopsy.

13.2.5 Biopsy Menu

Move the cursor onto the image menu; navigate the cursor to [Other] item and press <Set> or the multifunctional knob. Click [Biopsy] to enter the biopsy menu.



- Select biopsy bracket angle

If the needle-guided bracket supports more than one biopsy angle, you can select the angle from the drop-down list (the last two numerals).
- Select Guide Line

If a bracket has more than one guide lines, then you can see the [Guide Line] item, and click to display the guide lines, whether one line or all.
- Display or hide the guide line

To display the guide line, set [Display] as “On”; to hide the guide line, set [Display] as “Off”.

Or, press <Biopsy> on the control panel to display or hide the guide line.
- Select guide line dot size

Move the cursor onto [Dot Size], press <Set> to select the dot size among Small, Medium and Big.

Tips:

 - The guide line is a dot line which consists of two kinds of dots, the distance between two dots is depth dependent. Move the cursor onto the big dot, a numeral, which represents the biopsy depth, is displayed.
 - The biopsy guidezone adjusts along with image adjustments, such as image inversion/rotations, zoom and depth changes.
 - When the imaging depth and scan range are changed, the guide line will be adjusted.
- Select through B mode image menu:
 - [Biopsy]: to display or hide the guide line.
 - [Biopsy Kit]: to select bracket angle.

Preset the two items through: [Setup]→[Image Preset]→[Menu Preset].

13.2.6 iNeedle

Note: NGB-010 bracket is not available with 03.02.00 version software.

In the course of biopsy, the metal needle attached to the probe is punctured into the tissue with a certain angle; because of the needle acoustic impedance, the ultrasonic beam cannot penetrate the metal needle, a reflecting boundary is formed. As in figure 1, if the deflection angle is very large, the needle display is not clear.

In the condition of deflected ultrasonic transmission, the beam direction is perpendicular to the needle direction, and the reflection direction will be the same with the needle, as shown in figure 2, when the needle display in the ultrasound image is very clear. The system provides an additional deflection transmission that is approximately perpendicular to the metal needle, as the normal transmission (perpendicular to the transducer surface) is contained as well. And the deflection angel can be chosen by users.

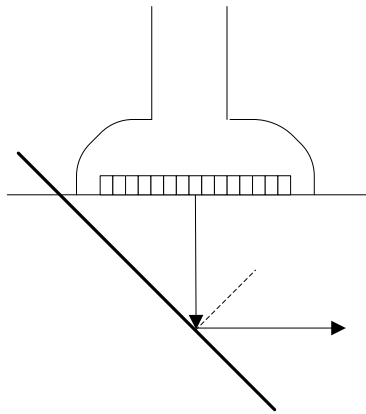

Figure 1

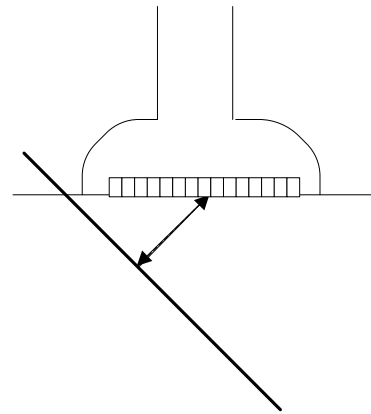
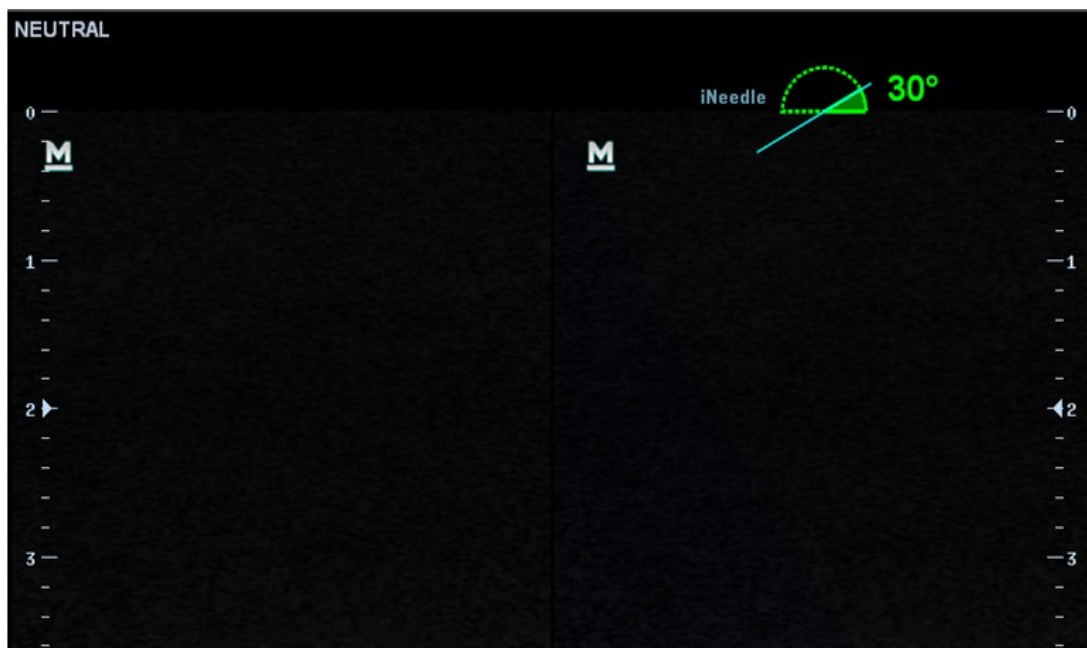

Figure 2

Best angle indication

This feature is only applied to 05.00.00 version software or higher versions.



In iNeedle mode, recommended needle angle is given on the top of the screen. As shown in the above figure, the current recommended angle is 30° to the horizontal plane.

To enter/exit iNeedle

■ To enter iNeedle

Click [iNeedle] item in B soft menu.

Or, you can assign a user-defined key for entering iNeedle.

■ Open iNeedle in Biopsy status

1. Perform scanning and locate the target, press <Biopsy> to enter the screen.
2. Click [iNeedle] to enter the status, available adjusting parameters are displayed on the menu.

■ To exit iNeedle

Press the user-defined key or click [iNeedle] to exit the status and enter B mode.

Needle Steer

Description This function adjusts the biopsy needle angle via changing the steer angle of the scan line. The iNeedle affecting region changes correspondingly.

Operation Adjust through the [Needle Steer] item on the menu.

B/iNeedle

Description This function is used to display B image and iNeedle image synchronously.

Operation Adjust through [B/iNeedle] on the menu.

Tips: iZoom (full-screen magnification) is available on iNeedle status.

13.2.7 Verifying the Biopsy Guide Line

 WARNING: <ol style="list-style-type: none">1. Prior to each biopsy procedure, be sure to verify the guide line.2. If the needle is not consistent with the guide line, DO NOT perform the biopsy procedure.

NOTE: You can perform guide line verification on a single live B/C image only, and all biopsy-irrelevant operations are forbidden.

1. Confirm that the needle-guided bracket has been installed securely in the correct position.
2. Prepare a container filled with sterile water.
3. Place the head of the probe in the sterile water, and get a biopsy needle into the needle guide.

When the biopsy needle appears on the image, please adjust the parameters of the menu on the screen to make sure that the biopsy needle is displayed at almost the same position as the selected needle mark.

- Adjust guide line position
Move the cursor onto [Position], press <Set> key to move it linearly, or press and rotate the multifunctional-knob. This is operative when there is only one guide line displayed.
- Adjust angle
Move the cursor onto [Angle], press <Set> key to change the guide line angle, or press and rotate the multifunctional-knob. This is operative when there is only one guide line displayed.
- Save verified settings
After the position and angle of the guide line are adjusted, click [Save], and the system will save the current settings of the guide line. When enter biopsy again, the displayed Position and Angle are the verified value.
- Restore the factory default settings
Click [Load Factory], and the position and angle of the guide line will be restored to the factory default settings.
- Exit the biopsy verify status
Click [Exit], and the system will exit the verification status of the guide line.

13.2.8 Removing the Needle-guided Bracket

■ NGB-004

Hold the probe in the left hand, unscrew the locking nut with the right hand to open the retaining clamp, and then raise the needle-guided bracket to separate the locating bulge from the locating grooves.

■ NGB-005

Hold the probe and the needle-guided bracket, open the grip knob of the needle-guided bracket.

■ NGB-007

● Metal needle-guided bracket:

- (1) Screw the nut of the guiding block and remove the guiding block slightly along the direction of the needle's tail.

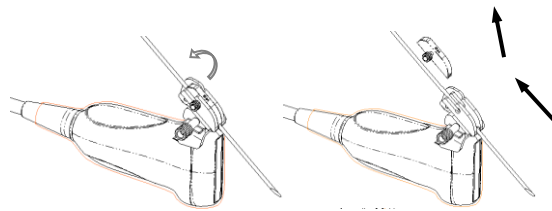

- (2) Separate the residual part of the needle-guided bracket and the probe from the needle.
- (3) Screw the pinch nut of the bracket, and remove the needle-guided bracket from the probe.

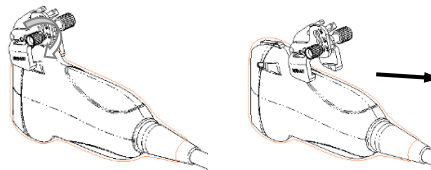

● Plastic needle-guided bracket:

- (1) Remove the guiding block slightly along the direction of the needle's tail.
- (2) Separate the residual part of the needle-guide bracket and the probe from the needle.
- (3) Remove the support of needle-guided bracket from the probe.

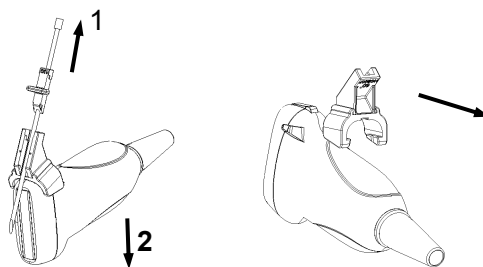

■ NGB-010

- (1) Remove the guiding block slightly along the direction of the needle's tail, and separate the residual part of the needle-guide bracket and the probe from the needle.
- (2) Remove the support of needle-guided bracket from the probe.

■ NGB-011

Hold the probe and the needle-guided bracket, and then open the grip knob of the needle-guided bracket.

■ NGB-015

(1) Pull the lock pin and open up the V-shaped cover to expose the needle.

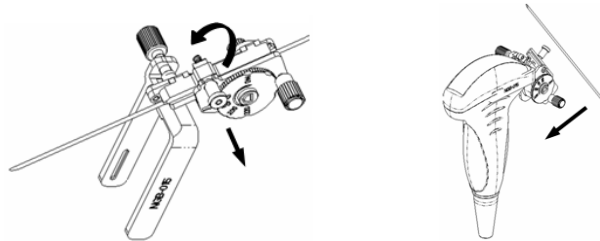

(2) Separate the bracket and the transducer from the needle.

(3) Screw the pinch nut to release the needle-guided bracket.

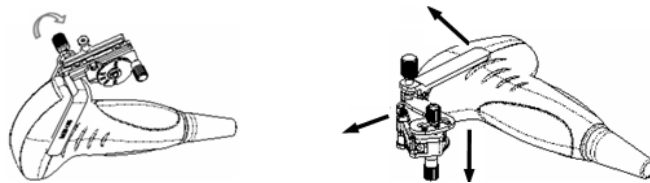

(4) Separate the bracket and the transducer.

■ NGB-016

(1) Screw out the nut on the guiding block to release the biopsy needle.

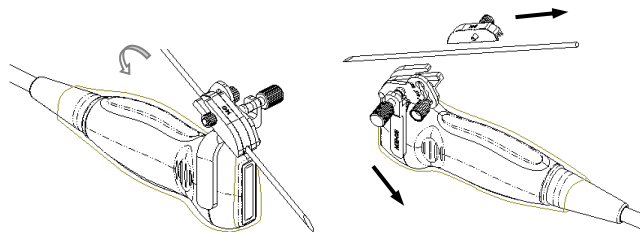

(2) Remove the guiding block in the direction of the needle tail, and then remove the needle.

(3) Screw the pinch nut of the bracket to release the needle-guided bracket.

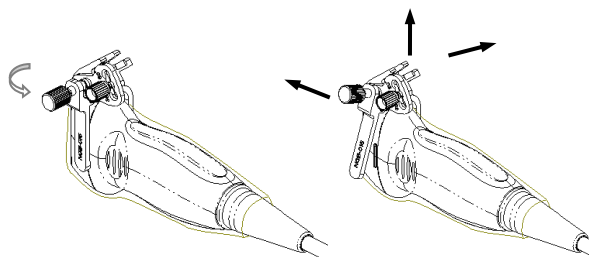

(4) Separate the probe and the needle-guided bracket.

■ NGB-018

(1) Loosen the guiding block's nut and slightly move the guiding block in the direction of the needle's tail.

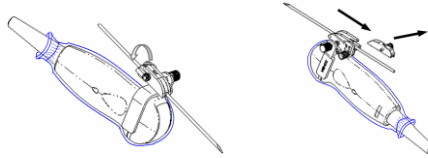

- (2) Separate the residual part of the needle-guide bracket and the transducer from the needle.
- (3) Loosen the bracket's pinch nut and remove the needle-guided bracket from the transducer.

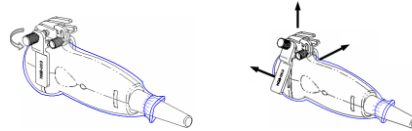

13.2.9 Clean and Sterilize the Needle-guided Bracket

Cleaning

Please follow the instructions in the manual for cleaning.

1. Wear sterile gloves to prevent infection.
2. Wash the needle-guided bracket with water or soap water to remove all the external matters. Or, clean the needle-guided bracket with urethane sponge.
3. Wipe off the water on the needle-guided bracket using sterile cloth or gauze after washing it.

Sterilization

1. Wear sterile gloves to prevent infection.
 2. Clean the needle-guided bracket before sterilizing it. MINDRAY recommends the following solution or sterilizing system to sterilize the needle-guided bracket.
 3. Follow local regulations when selecting and using the disinfectant.
- Glutaraldehyde-based sterilant:

Chemical name	Trade name	Procedures
Cidex Activated Dialdehyde Solution	2.4% Glutaraldehyde	Soak the transducer into the activated solution for 10 hours (20-25°C) Please refer to the instructions provided by the manufacturer of the solution for details.

Before safety and performance is affected, plastic bracket NGB-007 can be sterilized by Cidex Activated Glutaraldehyde Solution for at least 233 times (10 hours for one time).

- Refer to the instructions provided by the chemical manufacturer concerning concentration of the solution, and method of disinfections and dilution. Note that the glutaraldehyde disinfectant solution needs an activating solution.
- Rinse the needle-guided bracket thoroughly with sterile water to remove all chemical residues on it.
- Wipe off the water on the needle-guided bracket with sterile cloth or gauze after rinsing it.

- STERRAD 100S low-temperature hydrogen peroxide gas plasma sterilization system

Chemical name	Trade name	Procedures

Chemical name	Trade name	Procedures
Hydrogen peroxide gas plasma	Hydrogen peroxide vapor	Please refer to the instructions provided by the producer of the solution for details.

- Refer to the instruction of STERRAD 100S sterilizing system provided by the manufacturer for operation instructions and cautions.
 - The STERRAD 100S low-temperature hydrogen peroxide gas plasma sterilization system is available for metal needle-guided brackets.
 - High-pressure steam sterilization (only applicable for metal guided-bracket)
- Autoclaving (moist heat) 121° C for 20 minutes.

NOTE: The high-pressure steam/ immersion sterilization do not affect the bracket duration life, and the duration life is affected by the daily application of the bracket. Please check the appearance of the bracket before using.

13.2.10 Storage and Transportation

1. Don't use the carrying case for storing the needle-guided bracket. If the carrying case is used for storage, it may become a source of infection.
2. Between examinations, keep the needle-guided bracket in a sterile environment.
3. When the needle-guided bracket is sent to your MINDRAY representative for repair, be sure to disinfect or sterilize it and keep it in the carrying case to prevent infection.
4. Sterilize the carrying case as necessary.
5. Store or transport the needle-guided bracket under the following ambient conditions:
 - Ambient temperature: -20°C to 55°C
 - Relative humidity: 30% to 85% (no condensation)

13.2.11 Disposal

Be sure to dispose the needle-guided bracket only after sterilizing it.
Contact your MINDRAY representative when disposing of this device.

13.3 Middle Line

Middle Line helps to locate and observe the focus point of lithotripsy wave during lithotripsy treatment. By means of providing information for the lithotripsy machine as well as a tool for watching the procedure of lithotripsy in real-time, you can adjust the intension and frequency of the lithotripsy wave through lithotripsy machine.

NOTE: This function in the ultrasound system is for lesion (stone) location and observation only. For details, please refer to lithotripsy machine accompanying manuals.

- To enter the mode: Click [Other] → [Biopsy] → [Middle Line] in the image menu to turn on the function.



- The middle line is a vertical dotted line located in the middle of the screen, the position and direction of which cannot be changed.
- There is a mark icon of “x” located on the middle line which can be moved up and down along the line by rolling the track ball.
- To use the Middle Line function of the ultrasound system:
 - a) Use the trackball to change the mark position and by adjusting lithotripsy machine tools or patient posture to locate the stone center at the mark.
 - b) Read the depth of the mark by observing the depth caliper on the right of the image.
 - c) By getting the depth information of the stone, refer to lithotripsy machine manuals to perform the lithotripsy.
- The depth of the mark is displayed in the image parameter area of the screen.

14 Recording

- NOTE:**
1. Strictly observe the procedures described here to perform the recording and replaying operations; otherwise it may result in data loss or system malfunction.
 2. Set the PAL or NTSC in the setup and this shall be consistent with that in the DVR.
 3. Accidental exposure to strong electromagnetic fields may result in image and data loss, so check if the recording is successful as soon as possible. Mindray is not responsible for any data loss.

14.1 DVR

You can use the DVR device to record and replay videos and audios that can be stored in DVD disc or hard disc. For the detailed operation, please refer to the DVR accompanying operation manual.

14.1.1 DVR Recording

Recording is to record videos/audios arise from the examination and store them into DVD or hard disc of the DVR device.

Recording procedures with DVR:

1. Connect the DVR recorder to the ultrasound system and insert an available DVD disc or make sure there is memory in the hard disc.
2. Enter "[Setup]→[Peripheral Preset]→[Input& Display]", preset the output setting. For details, please refer to "15.7 Peripheral Preset".
3. Start the ultrasound exam and acquire images.
 - Record: press begin recording related keys on the DVR to begin recording.
 - Stop: press stop recording related keys on the DVR to stop recording.

14.1.2 DVR Video Replay

You can replay the video and audio record.

Replay the recorded images using DVR:

1. Connect the DVR recorder to the system and place the media with recorded data.
2. Enter "[Setup]→[Peripheral Preset]→[Input& Display]", preset the input setting.
3. Assign a key as user-defined Video: the setting path is "[Setup]→[System Preset]→[Key Config]". Please refer to "15.1.7 Key Config" for details. Press the user-defined key to enter the video replay screen in the ultrasound system.
4. Select the record to be replayed.
 - Press the begin replaying related keys on the DVR to begin the replaying.

- Press stop replaying related keys to stop the replaying, and press the user-defined key Video to exit.

15 Setup

The Setup function is designed to set the configuration parameters of operating the system and maintain user workflow preferences. The setup data of the user and system are stored to the hard drive, and should be backed up to CD/DVD or USB memory devices.

 **CAUTION:** When the setup data is changed, be sure to save the preferences according to the methods described in this chapter. Mindray is not responsible for the loss of the setup data.

- To enter Setup:
 - Press the <Setup> to enter Setup; or
 - On image menu, select [Setup] in the [Other] menu to enter the Setup.
 - On “Probe & Exam” selection page, click [Exam Preset] to enter Exam Preset page.
- To exit Setup:

Select [Return] on the Setup menu or press <ESC> to close the Setup menu with parameter settings saved.

If you change the system language and click [Return] on the Setup menu or press <ESC>, the system will automatically restart to make the changing effective.
- Basic operations

The commonly-used setting types are:

 - Text box: posit the cursor into the corresponding box; enter the desired value through keyboard.
 - Radio button: click the button to select an item.
 - Check box: click the check box to select one or several options.
 - Drop-down list: click the arrow beside the list to select an item.
- General buttons
 - [OK]: click to confirm the setting, exit the current page and then return to the previous page.
 - [Cancel]: click to give up the setting, exit the current page and then return to the previous page.
 - [Load Factory]: click [Load Factory], and all parameter settings will be restored to the original factory default.

15.1 System Preset

Click [System Preset] on the Setup menu to open the following page:



Page	Description
Region	To set the hospital name, language, time zone, time format, system date/time, logo and so on.
General	To set patient information, exam setup, patient management, storage, system dormancy, operation log and so on.
Image Preset	To set some general parameters in imaging modes.
Meas	To set the measure ruler, measure result, units and so on.
OB	To set the relevant information about fetal gestational age, fetal growth formula and fetal weight.
Comment	To set general information about comment.
Key Config	To assign functions to footswitch and <Print>, <Save>, <F1> ~<F6>.
Biopsy	To set the needle-guided bracket model and biopsy guide line relevant parameters.
Option	Displays the installation of system supported options. You can install or uninstall the options through the page.
Admin	To set the user account control relevant information.

15.1.1 Region

Open the Region page via “[Setup] → [General] → [Region]”.

Items	Description
Hospital Information	To set the hospital relevant information like name, address, telephone and so on.
Language	To select a language for the system, the available languages are Chinese, English, French, German, Italian, Portuguese, Russian, Spanish, Polish, Czech, Turkish, Finnish, Danish, Icelandic, Norwegian, and Swedish. The system will restart automatically after you change the language.
Time Zone	To select the time zone.
Time Format	To select the time format between 12 Hour and 24 Hour.
Date Format	To set the date format among DD/MM/YYYY, MM/DD/YYYY and YYYY/MM/DD.
System Date	To set the system date. Posit the cursor into the corresponding field, and enter the data through the keyboard; or, click the calendar icon  , and then select the date.
System Time	Move the cursor onto the corresponding field, enter the time manually through the keyboard; or, move the cursor onto the time segment and press <Set>, then increase or decrease the certain value by rotating the multifunctional knob or clicking the icons at the right side.

15.1.2 General

Open the General page via “[Setup] → [System Preset] → [General]”, items are introduced as follows:

Region	Items	Description
Patient Info	Info displays in image banner	To select if to display the following patient information on the image banner: Gender, Age, Operator, ID, Name, Hospital, DOB.
	H&W Unit	To set the unit for patient height and weight.
	Surface Formula	To set the surface formula.
Exam Setup	Status after exam ends	To set the system status when exam ends among Scan, Register, Worklist.
	Confirmation when exam ends	To set if the system pops up prompts “Do you want to end the current/active exam” when end an exam.
Patient Management	Save image without patient info	For an anonymous patient exam, you can save images without entering any patient information. If you check “Auto generated ID” ([Setup]→[System Preset]→ [General]), the system will save the images using the auto generated ID.
	Auto generated ID	Check the item to generate an ID automatically when begins an exam for a new patient.
	Send/print Image after print after End Exam	Select if to automatically archive the exam data.

Region	Items	Description
Storage	Image Size	To set the size for a stored image : 640*480. 800*600. 1024*768.
	Clip length/ Time (s)	To set the cine length when no ECG loop is included. Value: 1~60s.
	Clip length/ Beat(heart cycle)	To set the number of ECG loops in a saved cine. Value: 1~16.
	JPG Compress	To set the compression ratio: H, M, L.
	File system type	To set the file system type when record data to a CD: UDF, ISO.
	Prospective Cine Length	To set the cine length for prospective live capture. Value: 1-480s, or 1-120 cycles.
	Retrospective Cine Length	To set the cine length for retrospective live capture. Value: 1-120s, or 1-120 cycles.
Image/ clip storage	While storing image to hard disk	Select the accompanying image sending destination: local default printer; DICOM Storage; DICOM Printer.
	While Storing Clip to hard disk	Select the accompanying clip sending destination: DICOM Storage.
Screen Saver	Enable Screen Saver	To enable screen saver function, and select the waiting time until screen saver.
	Enable Standby	To enable the standby function, you can select the waiting time for entering standby after screen saver.
Operation Log	Enable logging	To set if to enable logging the operation log.
	Auto Upload	To set if to automatically upload the operation log.

15.1.3 Image Preset

Open the Image Preset page via “[Setup] → [System Preset] → [Image Preset]”.

Region	Items	Description
Reset Config	Probe	To set the default probe model for the system.
	Reload Preset on New Patient	Check to set if to reload setup data when begins a new patient exam.
Freeze Config	Status after Freeze	To set the system status after image is frozen.

Region	Items	Description
Image	Steer Mode	To set the steer mode in B+ Color +PW imaging mode. C& PW: select to adjust the sample volume in color mode and sample line in PW mode together. C/ PW: select to adjust the sample volume in color mode and sample line in PW mode individually.
	Auto invert	The spectrum can automatically invert when the color flow is steered to a certain angle, thus accommodating operator's habit of distinguishing flow direction.
	Cine Memory	To set the cine memory splitting type: Auto, Split.
	iScape Ruler Display	To set if to display the iScape ruler on iScape imaging mode.

15.1.4 Meas

Open the Meas page via "[Setup] → [System Preset] → [Meas]". Through the page, you can set the measure ruler, measure result and unit relevant information. For details, please refer to the Operator's Manual [Advanced Volume]

15.1.5 OB

Open the OB page via "[Setup] → [System Preset] → [OB]". Through the page, you can set the gestational age formula, fetal growth formula, fetal weight formula and the relevant information. For details, please refer to the Operator's Manual [Advanced Volume].

15.1.6 Comment

Open the Comment page via "[Setup] → [System Preset] → [Comment]". Through the page, you can set the font size and arrow size for comment.

Preset whether to clear the comments when unfreezing the image or change the probe or the exam.

Preset whether to erase the body mark when the image is unfrozen.

15.1.7 Key Config

Open the page via "[Setup] → [System Preset] → [Key Config]".

■ Key function setting

You can set the functions for <Print>, <Save>, and F-key (F1-F6).

To assign a function to a key:

- a) Click to select the desired key in the Key Function column at the left side of the page.
- b) Click to select a function in Function area. You can see the function selected is displayed at the right side of the selected key.
- c) Click [OK] to complete function setting.

The following introduces an example as setting <F4> as “Save AVI Cine to USB disk”:

- a) Select F4 in the “Key Function” list at the left side of the page.
- b) Select “Save AVI Cine to USB disk” in “Function” at the right side of the page.
- c) Click [OK] to complete the setting.

In Function area, the functions of user-defined keys can be divided into five categories: Output, Print, Advanced Features, Measurement and Other. Functions are described as follows:

Type	Function	Description
Output	Save Image to hard drive	To save an image to the system in the system-relevant format
	Save Image to USB disk	To store single-frame image to USB flash drive
	Save Clip (Prospective) to hard drive	To active live capture (Prospective)
	Save Clip (Retrospective) to hard drive	To active live capture (Retrospective)
	Save AVI Cine to USB disk	To save AVI cine to USB disk
	Save Full Screen Image to hard drive	To save a full screen image to the system in the format of JPG or BMP
	Send Image to DICOM Storage	To save single frame image to DICOM server
	Send Clip to DICOM Storage	To save multi frame Image to DICOM server
	Send Image to Network Storage	To save single frame Image to network server
	Send AVI Cine to Network Storage	To save multi-frame Image to network server in AVI format
	None	To assign no function for a key
Print	Send Image to DICOM Printer	Send Image to DICOM Printer to print
	Print Service List	The connected or the configured printers are displayed here: Digital B&W Print; Digital Color Print. Use the user-defined key to print after preset.
Advanced Features	Physio	To enter ECG
	3D/4D	To enter/ exit 3D/4D imaging mode
	Trapezoid	To enter trapezoid mode
	ExFOV	To enter/exit wide scan.
	iScape	To enter/exit iScape imaging mode
	Auto Calc	To enter/exit auto calculation
	TDI	To enter/exit TDI imaging mode
Free Xros M	To enter/ exit Free Xros mode	

Type	Function	Description
	Free Xros CM	To enter/exit Free Xros CM imaging mode.
	Frame Compare	To enter/exit image compare function
	Colorize	To turn on the colorize function
	Save Image Para	To save image parameters
	Dual Probe	To switch between the dual probes
Measurement	Trend Dig	To open the obstetric growth curve
	SD	To display/ hide the standard deviation
	Caliper	To enter/ exit general measurement
Other	Biopsy Display	To show or hide the biopsy guide line
	Video	To enter or exit the video status
	Set Home	To set home of comments
	Home	To make the cursor return to the home position
	ABC Display	To display/hide the comments
	Erase All Text	To delete all comments on the screen
	Delete Word	To delete a word in a comment
	iZoom	To enter/ exit full-screen zoom status
	iVision	To enter/ exit iVision

■ Footswitch function setting

Type	Function	Description
Output	Save Image to hard drive	To save an image to the system in the system-relevant format
	Save Image to USB disk	To store single-frame image to USB flash drive
	Save Clip (Prospective) to hard drive	To active live capture (Prospective)
	Save Clip (Retrospective) to hard drive	To active live capture (Retrospective)
	Save AVI Cine to USB disk	To save AVI cine to USB disk
	Save Full Screen Image to hard drive	To save a full screen image to the system in the format of JPG or BMP
	Send Image to DICOM Storage	To save single frame image to DICOM Server
	Send Clip to DICOM Storage	To save multi frame image to DICOM Server
	Send Image to Network Storage	To save single frame image to network server

Type	Function	Description
	Send AVI Cine to Network Storage	To save multi-frame image to network server in AVI format.
Print	Send Image to DICOM Printer	Send Image to DICOM Printer
	Print Service List	The connected or the configured printers display here: Digital B&W Print; Digital Color Print. Use the user-defined key to print after preset.
Advanced Features	Physio	To enter ECG
	3D/4D	To enter/ exit 3D/4D imaging mode
	Trapezoid	To turn on the trapezoid function
	ExFOV	To enter or exit wide scan.
	iScape	To enter/exit iScape imaging mode
	Auto Calc	To perform auto calculation
	TDI	To enter/exit TDI imaging mode
	Free Xros M	To enter/ exit Free Xros M mode
	Free Xros CM	To enter/exit Free Xros CM mode.
	Frame Compare	To enter/exit frame compare function
	Colorize	To turn on colorize function
	Save Image Para.	To save image parameters
	Dual Probe	To enter dual probe state
	B	Enter/ exit B mode
	M	Enter/ exit M mode
	Color	Enter/ exit C mode
	Power	Press to enter Power mode
	PW	Enter/ exit PW mode
	CW	Enter/ exit CW mode
	Update	The same function as <Update>
Dual	Enter/ exit Dual mode	
iTouch	Turn on or off iTouch function	
Measurement	Trend Dlg	To open the obstetric growth curve
	SD	To display/ hide the standard deviation
	General Measurements	To enter/ exit general measurement
Other	Biopsy Display	To show or hide the biopsy guide line
	Video	To enter or exit the video status
	Set Home	To set home of comments
	Home	To make the cursor return to the home position

Type	Function	Description
	ABC Display	To display/hide the comments
	Erase All Text	To clear all text on the screen
	iZoom	To enter/ exit full-screen zoom status
	iVision	iVision
	Cine	To enter cine status
	Exit	To exit from the current screen

■ Other Settings

Item	Description
Key Lightness	To set the lightness for the keys: 0, 1, 2, 3
Key Volume	To set the key volume: 0-3, 0 means no sound
Trackball Speed	To set the trackball speed when move the trackball: Slow, Medium, Fast
Trackball Lightness	To set the color for the trackball: A, B, C, D, E, F

15.1.8 Biopsy

Open the Biopsy page via “[Setup] → [System Preset] → [Biopsy]”, as shown in the figure below.

■ Bracket model

To select the default needle-guided bracket for the probe.

- (1) Select the probe model in the left-hand list, the matched bracket model will be shown in the right-hand area.
- (2) Select the bracket model in the right-hand list.
- (3) Click [OK] to confirm the setting.

■ Parameter setting

Guide Line Display: to set if to display the biopsy.

Guide Line Dot Type: Small, Medium, Big.

15.1.9 Option

Open the Option page via “[Setup] → [System Preset] → [Option]”.

In Option list, the system lists out all the system supported options and the installation status (Disabled or Installed).

- Click [Install] to begin the installation of a disabled option.
- Click [Uninstall] to begin the un-installation of an already installed option.

■ Trial

Select the option item in the list to see the information on the Comment region on the right.

For functions that are not configured, you can use the function for free for 3 months.

- Click to select the function(s) and click [Trial].

Tips: every trial option can be used only once.

Please contact Mindray Customer Service Department or sales representative for details.

15.1.10 Admin

Open the Admin page via “[Setup] → [System Preset] → [Admin]”.

For details of access control, please refer to “11.9 Administration”.

15.2 Exam Preset



Open “[Setup][Exam Preset]” or click [Exam Preset] in the “Probe & Exam” selection screen to enter Exam Preset screen.

15.2.1 Exam Selection

After the Exam Preset screen is entered, the screen will display the Exam Selection page. This page is used to assign an exam type to a specific probe.

1. To select a probe: move the cursor onto the column , and select the probe model through the drop-down menu.
2. Selecting/delete exam modes

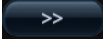
On the right side of the screen, you can view the exam types supported by the current probe. On the left side, you can view all the exam modes supported by the system, i.e., Exam Library.

- Select the exam from the Exam Library on the left and click  to add it to the Exam Selected.
 - Click  to add the exams, which Exam Library has but Exam Selected doesn't have, from Exam Library to Exam Selected.
 - To delete an exam supported by the current probe, select the exam first, and then click  to delete it.
 - Click [Up] and [Down] to adjust the sequence of the items in Selected Items.
 - Click [Default] to set a selected exam mode as the default exam mode.
3. Click [OK] to confirm the modified setup; or click [Cancel] to cancel the modified setting.

15.2.2 Exam Configuration

In the Exam Preset screen, click “Exam Config” page tab to enter Exam Config page.

After an exam mode is selected,

- Click a selection in Application list, you can select a new application for the exam mode in the popped up drop-down list.
- Click [Up] and [Down] to adjust the sequence of the items in Selected Items.
- Click [Rename] to change the name of the user-defined exam mode.[Rename]
- Click [Copy] to copy the parameters of the selected exam mode. Select a second exam mode and, click [Paste] to paste the copied parameters to the secondly-selected exam mode.
- Click [Export] to open the screen to store the parameters of the selected exam modes.

- Click [Load] to open the screen to load the parameters of the exam mode.
- Click [Export All] to open the screen to store the parameters of all exam modes for the current probe.
- In addition, you can preset measurements, comments, body marks and image parameters for the exam modes by clicking [Measure Preset], [Comment Preset], [Body Mark Preset], [Image Preset] respectively.

Tips: loading or pasting exam setup data will overwrite previous presets and can't be reverted. Exercise caution for this operation.

15.2.3 User-defined Exam Modes

To define exam modes for a probe:

1. Click to select a user-defined item in the [Exam Mode] list in Exam Config page, such as [User-defined 1].

Click a selection in Application list, and select an application for the exam mode in the popped up drop-down list (see the figure below).

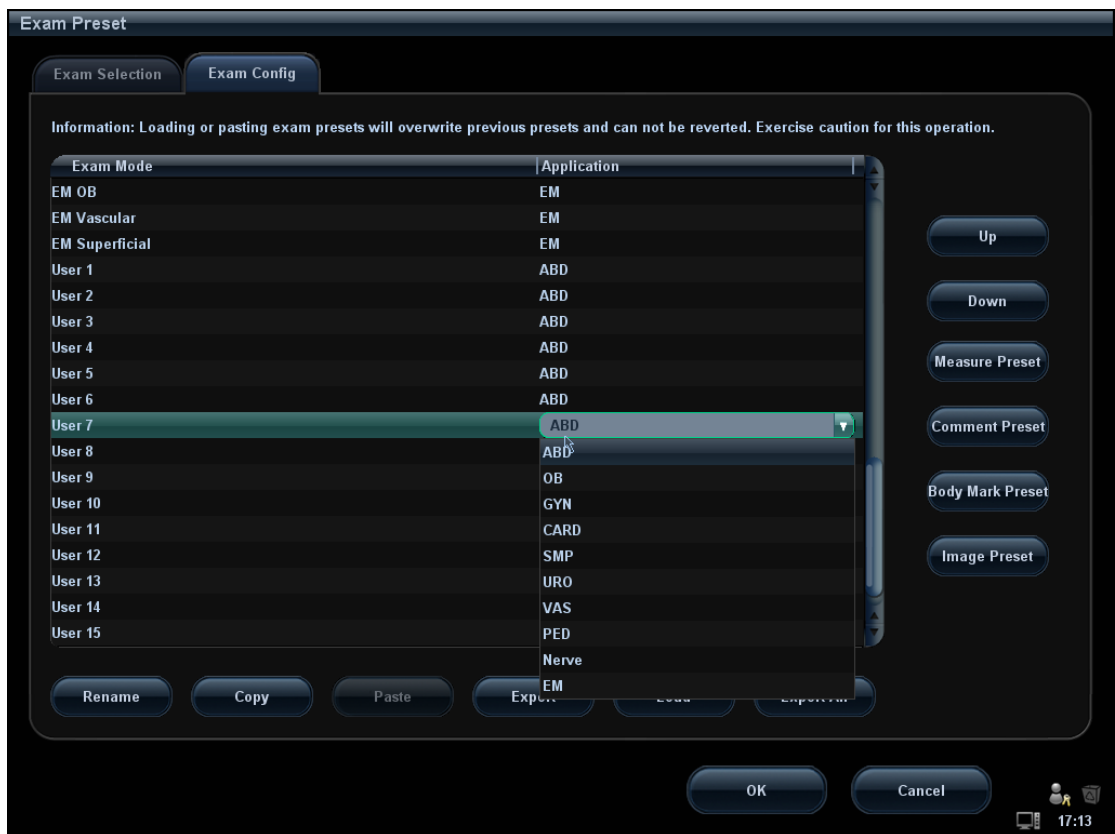

2. Click functional buttons to perform relevant operations:
 - Click [Rename] button to open the screen. You can enter a new name to your preference.
 - Click [Measure Preset] to set measurement package and attributes.
 - Click [Comment Preset] to set comments.
 - Click [Body Mark Preset] to set body marks.
 - Click [Image Preset] to set image parameters.
3. Click [OK] to complete the body mark setting.

15.3 Image Preset

To enter Image Preset screen:

- In the Setup menu, select the [Image Preset] item to enter the image preset screen.
- Or, Click [Image Preset] button in the Exam Config page ([Setup]→[Exam Preset] → Exam Config) to open the Image Preset screen.

Image preset is used to set the image parameters for each imaging mode.

Image parameters can be divided into the following three categories:

- Imaging mode relevant parameters.
- Parameters pertinent to both exam mode and probe.
- Other image specific parameters.

For details, please refer to the relevant imaging modes chapters.





15.4 Measure Preset

For measurements details, please refer to the [Advanced Volume].

15.5 Body Mark Preset

In order to accommodate your workflow – numerous preferential settings can be captured in Body Mark Preset. This function is to preset, body marks in each exam type, or user-defined body marks.

15.5.1 Preset Body Mark for Exam Mode

1. To enter Body Mark Preset screen:
 - In the Setup menu, select [Body Mark Preset] item to enter the Body Mark Preset screen. Or,
 - Click [Body Mark Preset] button in the Exam Config page ([Setup] → [Exam Preset] → Exam Config) to open the Body Mark Preset screen.
2. Select the body mark applied exam mode: select the exam mode in the drop-down list, the current exam mode is by default.
3. Set library: enter the library name of custom body marks.
4. Add or delete body mark(s)
 - Click  to add the item in Available Items on the left into Selected Items on the right.
 - Click  to add all items in Available Items on the left into Selected Items on the right.
 - Click  to delete the selected item in Selected Items.
 - Click  to clear the content in Selected Item.
5. Click [Up] and [Down] to adjust the sequence of the items in Selected Items.
6. Preset the probe mark of the selected body mark in Selected Items.

Move the cursor onto the probe mark of the body mark in Probe area and press <Set> to make the cursor turn green. Roll the trackball to change the position of the probe,

rotate the multifunctional knob to change the angle, and press <Set> to confirm the orientation of the probe.

7. Select the body mark in Selected Items and click [Default], and then the body mark will be prior to be displayed.
8. Click [OK] to complete the body mark setting.

15.5.2 User-defined Body Marks

If there is no body mark pictogram from the body mark library, you can create a graphic of your own.

In the Body Mark Preset screen above, click [User-defined] to enter the user-defined body mark screen.

You can edit, delete, or export a user-defined graphic. In addition, you can create a Body Mark graphic with a draw tool or add it from loading. The file format is *.Bin.

■ Adding new body mark

Click [Add] to enter the following page.

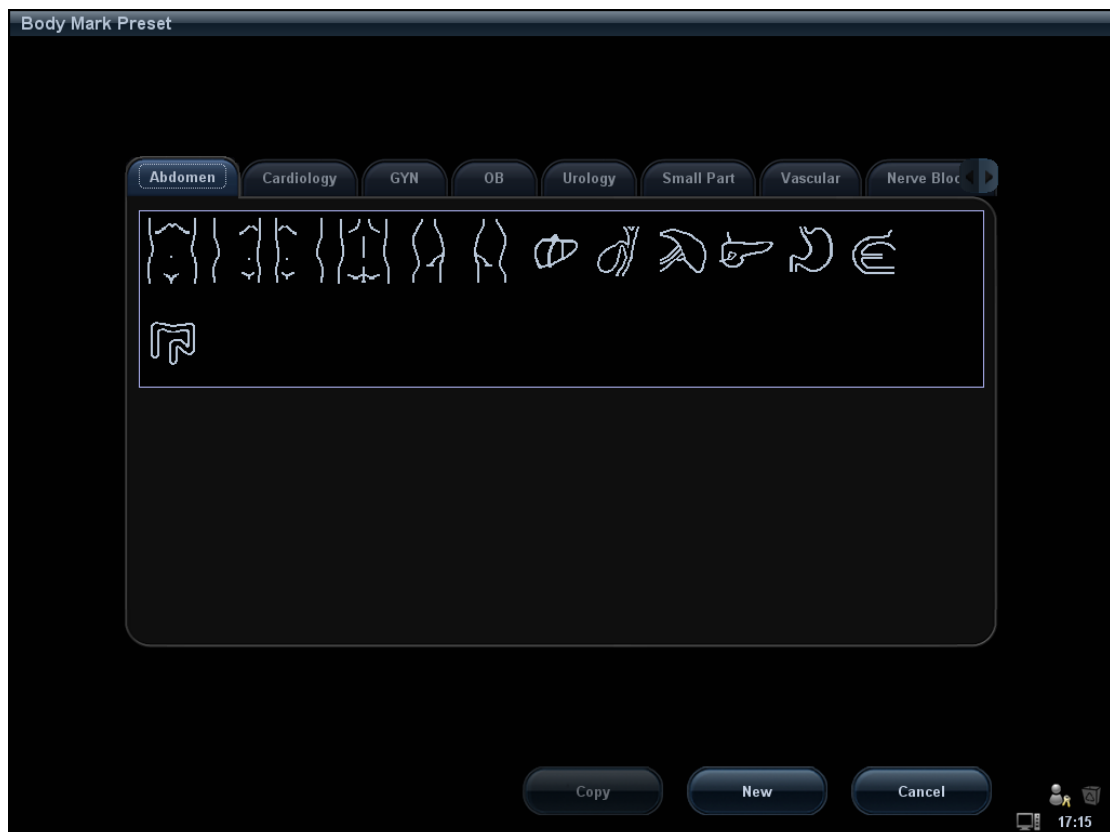

- Copy a body mark
 - a) Select a body mark of a certain application area.
 - b) Click [Copy] to enter the “Body Mark Preset - Add Picto” screen, thus you can edit the copied body mark.
- Add new body mark
 - a) Click [New] to enter the “Body Mark Preset - Add Picto” screen; here you can draw a body mark to your preference.

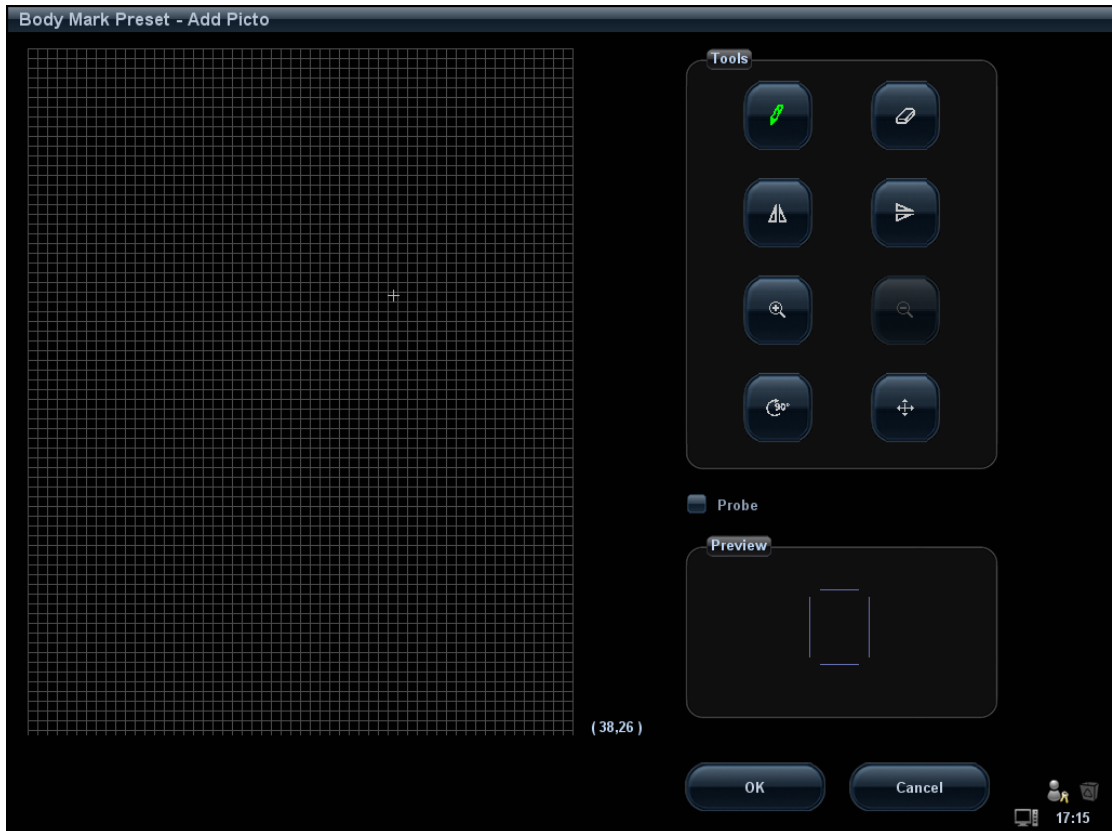

Available tools are described as follows:



- b) Check **Probe** on the screen, move the cursor onto the probe mark and press <Set>, adjust the position with the trackball and direction with the multifunctional knob.
 - c) After the drawing of a body mark is completed, click [OK] to save it and exit the user-defined body mark status.
- **Edit/ delete a user-defined body mark**
After selecting a user-defined body mark, click the [Edit] button to edit it.
 - **Delete**
After selecting a user-defined body mark, click [Delete] to delete the selected image.
 - **Load:**
Click [Load] to load user-defined body mark from external media.
 - **Export**
Click [Export] to export user-defined body mark to external media.

■ Return

Click [Return] to exit the current screen.

15.5.3 Body Mark Softkey Preset

Click [Softkey Preset] on the Body Mark Preset screen to open the body mark softkey preset dialogue box.

Exam mode: displays the exam mode selected in the Body Mark Preset screen, not editable.

Apply to All Exam Modes: set whether to apply the softkey preset to all exam modes.

: to add the softkey in Available Items on the left into Selected Items on the right.

: to add all the softkey in Available Items on the left into Selected Items on the right.

: to withdraw the selected item in Selected Items.

: to withdraw all the selected items in Selected Items.

[Left]: to move the selected item to the left by one step.

[Right]: to move the selected item to the right by one step.

[Up]: to move the selected item upwards by one step.

[Down]: to move the selected item downwards by one step.

Position interchange: select an item on the selected items area, and then click a blank button to interchange the position.





15.6 Comment Preset

You can preset the custom comments library for each exam mode to your preference.

15.6.1 Custom Comments

You can preset the custom comments library for each exam mode to your preference. The comments in the library are provided by the system or user-defined ones. The name of the library, which can be set, will appear on the first page of the library.

1. To enter Comment Preset:
 - In the Setup menu, click [Body Mark Preset] item. Or,
 - Click [Comment Preset] in the Exam Config page ([Setup] → [Exam Preset] → Exam Config).
2. Select exam mode.
3. Enter Library Name: you can enter characters for the library name, or accept the default name (the same as that for the exam mode).
4. Add user-defined comments: directly enter comment texts, or select comment texts for the comment library.
 - Directly enter comment texts: posit the cursor in the field box above [Add Comment], enter the text comment through the keyboard, and then click [Add Comment]. Then the directly-entered comment will be added to the Available Items and Selected Items.
 - Select available items: First select a comment library in the drop-down list beside "Available Items", all items will be displayed below "Available Items".

- Click  to add the item in Available Items on the left into Selected Items on the right.
 - Click  to add all items in Available Items on the left into Selected Items on the right.
5. Change position of the selected items: select an item on the right side box and click [Up], [Down], [Left] or [Right] button to change the position of the item.
 6. Withdraw or delete a user-defined comment:
 - Withdraw an item (from the library or user-defined) in the Selected Items list:
Select an item in Selected Items list, and click  to withdraw it to the Available Items list.
Click  to withdraw all items in Selected Items.
 - Delete a user-defined item in the Available Items box:
Select a user-defined item in the Available Items box, and click [Delete]. After the user-defined item in the Available Items box is deleted, the same item in the Selected Items box on the right will disappear as well.
You can only delete the user-defined items rather than the items in the system library. After a user-defined item is deleted, it will not be available.
 7. After you customize comments, click [OK] to confirm and exit the [Comment Preset] screen.

15.6.2 Comment Softkey Preset

Click [Softkey Preset] on the Comment Preset screen to open the comment softkey preset dialogue box.

Exam mode: displays the exam mode selected in the Comment Preset screen, not editable.

Apply to All Exam Modes: set whether to apply the softkey preset to all exam modes.

: to add the softkey in Available Items on the left into Selected Items on the right.

: to add all the softkey in Available Items on the left into Selected Items on the right.

: to withdraw all the selected items in Selected Items.

[Left]: to move the selected item to the left by one step.

[Right]: to move the selected item to the right by one step.

[Up]: to move the selected item upwards by one step.

[Down]: to move the selected item downwards by one step.

Position interchange: select an item on the selected items area, and then click a blank button to interchange the position.

Tips:

- The softkey preset are applied for both text comment and arrow comment.

15.7 Peripheral Preset

The Peripheral Config screen is used to set up printer and Input& Display.

■ Printer setting

The settings of a printer include print service and print driver.

For the printers aforementioned in “2.5 System Configuration”, you do not need to install them. For printers that need to install the driver, please refer to “3.7 Graph /Text printer 3.8 Video Printer” for details.

NOTE: If you use the user-defined key to print, the user-defined printer type shall be consistent with that of the default printer.

● Print Service Setting

- Add Service: click to begin print service adding.
- Remove Service: click to delete the selected print service.
- Rename Service: click to rename the selected print service.
- Default print service: click to set the selected print service as the default one.
- Property: to preset the property of print services.

Tips: please set the proper page margin, otherwise, only part of the contents can be printed.

● Printer Driver Setting

Printers listed in the operator’s manual are all supported by the system, no drive is required.

Click [Print Driver] page to enter printer driver setting screen:

- View the printer name as well as print status.
- You can add printer including network printer.
- Check the printer attribute. The attributes vary with the print services.

■ Input& Display

In this page, you can set the input setting, output setting, and display parameters.

15.8 Network Preset

- Please refer to DICOM chapter for details about DICOM setting.
- The Network Storage screen is as follows:

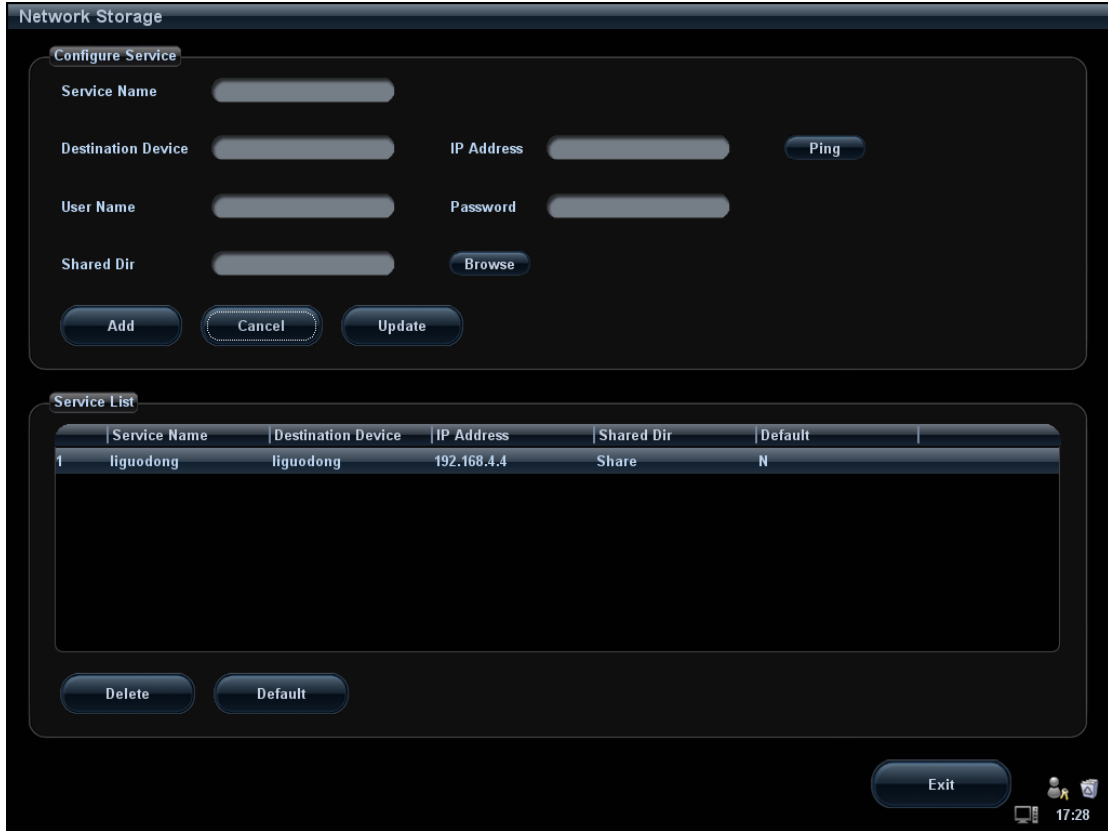

Name	Description
Service Name	The name of the network service, cannot be empty
Destination Device	Name of the device, cannot be empty
IP Address	IP address of the network service device, cannot be empty
Ping	Press Ping to confirm that a device is connected
User Name	User name for entering the shared PC server, which is decided by the server
Password	Password for entering the shared PC server, which is decided by the server
Shared Dir	Shared folder directory, cannot be empty
Browse	To enter the Net Disk Browse screen to set the shared folder directory. And if the user name or the password is incorrect, the server cannot be entered.
Add	Click it to add the Network service to the service list.
Cancel	Click to cancel parameter setting
Update	To save the changed parameters.

Name	Description
Default	To set as the default server for network storage
Delete	Click to delete the selected service in the service list.
Exit	Click to exit the screen.

■ Add a network service:

1. Set the network server properties as described above.
2. Click [Add] to add the service to the Service list.
3. Select the added service in the service list, you can set it as default or delete it.

■ Modify a network service:

1. Select the service to be updated in the service list.
2. You can see properties in the Configure Service area.
3. Modify the parameters and click [Update] to update setting.

Tips: in order to make network storage function normally, setting of the sharing folder of the PC server in advance is a must, e.g. destination, user name and password should be confirmed at first.

15.9 Manage Settings

The Manage Settings page is used to import or export the setup data or restore factory setup data.

15.9.1 Exporting Setup Data

This function is used to write all setup data of the system into a disk for backup. The format of the data file is .DTA.

Procedures:

1. Select some or all items in the “Export” field on the left side of the “Manage Settings” screen.
2. Click [Export] to open the [Export Data] screen.
3. Select the path to save the data.
4. Select the exported file and type as DTA and click [OK].

15.9.2 Importing Setup Data

This function is used to import the existing setup data to the setup data memory of the system. The system will reset and operate according to the setup preferences that were imported.

Procedures:

1. Select an item in the Import field on the right side of the Manage Settings screen.
2. Click Import to open the Load Data screen.
3. Select the imported file and type as DTA.
4. Click [OK], a progress bar will appear and the setup data in DTA format is imported to the specified path.

5. To restore the factory setup data, click [Restore Factory] on the right side of the screen.

You can use [Export All], [Import All], or [Load Factory] at the bottom of the screen to export/import all setup data of the system or restore all factory setup data of the system. The operating methods are the same as those mentioned above.

15.10 Maintenance

The [Maintenance] function is designed for you to update the system software or other special functions. If you require these functions, please contact Mindray Customer Service Department or sales representative.

Through the menu, you can perform net update, remote desktop, system test, log operation, etc.

15.11 System Information

Click [About] in the Setup menu to enter the system information screen.

This screen displays the system software version and versions of other devices. You cannot edit the information but only view them. The information varies depending upon the system configurations and version.

To export the system information, click [Save] in the System Information page, specify the file name and path, then you can save the information as a .txt file.

16 Batteries

 WARNING:	<ol style="list-style-type: none">1. The batteries have protective mechanism and circuit. DO NOT disassemble or alter the battery.2. DO NOT short-circuit the batteries by directly connecting the negative terminals with metal objects.3. DO NOT heat the battery or discard it in a fire.4. Keep the batteries away from fire and other heat sources.5. DO NOT immerse the batteries in water or allow them to get wet.6. DO NOT charge the batteries near a heat source or in direct sunlight.7. DO NOT pierce the batteries with a sharp object, hit or step on them.8. DO NOT use the batteries mixed with other battery models.9. DO NOT put the batteries into a microwave oven or pressurized container.10. If the batteries emit an odor or heat, are deformed or discolored, or in a way appear abnormal during use, charging or storage, immediately remove them and stop using them.
---	--

16.1 Overview

The battery charges when the system is connected to the AC power supply.

- Generally, if the system is turned off, a completely discharged battery will fully charge in 2 to 3 hours; or generally a battery has been charged for 2 hours (With the system power off).

NOTE: It is recommended to charge the batteries when the system is turned off, thus you can quickly charge the batteries and save time.
--

When the external power supply is not connected, two lithium-ion batteries will provide the power.

The model of the chargeable lithium-ion batteries (hereinafter called batteries for short) is LI231001A.

NOTE: <ol style="list-style-type: none">1. Only use the specified batteries.2. If there is only one battery in the system, it cannot supply power and cannot be charged.
--

3. Replace both batteries at the same time.
4. Charge the batteries periodically if they have not been used for a long period of time. Otherwise, the performance of the batteries is degraded.

16.2 Precautions

1. Before using the batteries, carefully read the description in the label on the surface of the batteries.
2. When you use the batteries at the first time and find that they are dirty or emit an odor, do not use them.
3. Do not expose the batteries to heat sources or high pressure.
4. Do not leave the batteries in direct sunlight.
5. Store the batteries out of the reach of children.
6. The batteries are designed to be charged only in this system; charge the batteries only when the ambient temperature is between 0 and 40°C.
7. When the batteries are out of power, please charge them immediately.
8. For storage longer than three months, charge a battery to a level no more than 45%.
9. Do not knock the batteries.

16.3 Installing and Removing the Batteries

⚠ WARNING: Turn off the system and disconnect the adapter from the main unit before installing or removing batteries. DO NOT install or remove batteries when the system is turned on or the system is turned off but the adapter is connected with the system.

The batteries are put in the battery bays under the system bottom. You need two batteries. You can install or remove them when the system is turned off and the adapter is disconnected from the main unit.

To install the batteries:

1. Turn off the system, and disconnect the adapter from the main unit.
2. Close the monitor, turn the system upside down and put it on the table.
3. You can see two battery bays at the bottom of the system (Note that the batteries shall be put in correct direction; if not, the batteries do not fit). Press the batteries gently until they click. Now the batteries are clocked in the bays.

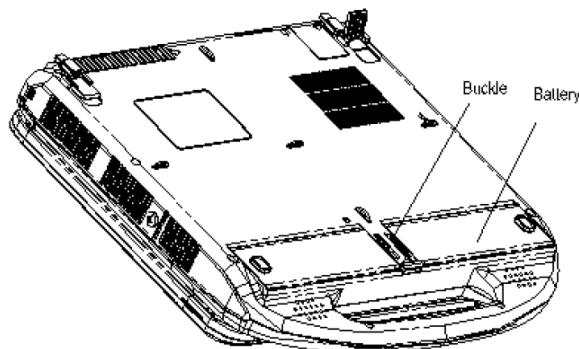



To remove the batteries:

1. Turn off the system, and disconnect the adapter from the main unit.
2. Close the monitor, turn the system upside down and put it on the table.
3. Push the buckles located between the two bays to unlock the batteries.
4. Take out the batteries from the bays.

16.4 Battery Status Indicator

The battery status indicator is located in the lower right corner of the screen, indicating the battery capacity.

- : Indicates the battery capacity is empty.
- : Indicates the battery capacity is full.
- The battery icons other than the two icons above-mentioned indicate the capacity is between empty and full.

When the power capacity is not enough, the system will pop up a prompt:

“Warning! Battery is out of power! Please insert the Adapter or system will be shut down in one minute.” Connect the power adapter to afford normal work.

16.5 Checking Battery Performance

The battery performance may be degraded over time, so you need to check the battery performance periodically. The checking procedures are shown as follows:

1. Stop the ultrasound exam.
2. Connect the system to the AC power supply to charge the batteries until current capacity is full.
3. Disconnect the system from the AC power supply to power the system by the batteries until the system automatically shuts down.
4. The powering time of the batteries indicates the battery performance.

If the powering time of the battery is much shorter than that specified, you may replace the battery or contact the service personnel.

NOTE: The usage life of the battery is 300 charge / discharge cycles. If the battery is improperly used, its life may be shortened.

16.6 Battery Disposal

You need to dispose of the battery when it is damages or severely degraded.

NOTE: You should observe the local regulations when disposing of the battery.

17 Acoustic Output

This section of the operator's manual applies to the overall system including the main unit, probes, accessories and peripherals. This section contains important safety information for operators of the device, pertaining to acoustic output and how to control patient exposure through use of the ALARA (as low as reasonably achievable) principle. Also this section contains information regarding the acoustic output testing and the real-time output display.

Read this information carefully before using the system.

17.1 Concerns with Bioeffects

Diagnostic ultrasound is recognized as being safe. In fact, there have been no reports of injuries to patients caused by diagnostic ultrasound.

It cannot be stated categorically that ultrasound is 100% safe. Studies have revealed that ultrasound with extremely high intensity is harmful to body tissues.

Diagnostic ultrasound technology has made a great leap forward during the last several years. This rapid advance has generated concerns about the potential risk of bioeffects when new applications or diagnostic technologies become available.

17.2 Prudent Use Statement

Although there are no confirmed biological effects on patients caused by exposures from present diagnostic ultrasound instruments, the possibility exists that such biological effects may be identified in the future. Thus ultrasound should be used in a prudent manner to provide medical benefit to the patient. High exposure levels and long exposure times should be avoided while acquiring necessary clinical information.

17.3 ALARA Principle (As Low As Reasonably Achievable)

It is required to practice ALARA when using ultrasound energy. Practicing ALARA ensures that the total energy level is controlled below a low enough level at which bioeffects are not generated while diagnostic information is being accumulated. The total energy is controlled by output intensity and total radiation time. The output intensity necessary for examinations differs depending on the patient and the clinical case.

Not all examinations can be performed with an extremely low level of acoustic energy. Controlling the acoustic level at an extremely low level leads to low-quality images or insufficient Doppler signals, adversely affecting the reliability of the diagnosis. However, increasing the acoustic power more than necessary does not always contribute to an increase in quality of information required for diagnosis, rather increasing the risk of generating bioeffects.

Users must take responsibility for the safety of patients and utilize ultrasound deliberately. Deliberate use of ultrasound means that output power of ultrasound must be selected based on ALARA.

Additional information regarding the concept of ALARA and the possible bioeffects of Ultrasound is available in a document from the AIUM (American Institute of Ultrasound Medicine) title "*Medical Ultrasound Safety*".

17.4 MI/TI Explanation

17.4.1 Basic Knowledge of MI and TI

The relationship of various ultrasound output parameters (frequency, acoustic pressure and intensity, etc) to bioeffects is not fully understood presently. It is recognized that two fundamental mechanisms may induce bioeffects. One is a thermal bioeffect with tissue absorption of ultrasound, and another one is a mechanical bioeffect based on cavitations. Thermal Index (TI) gives the relative index of temperature increase by thermal bioeffect, and Mechanical Index (MI) gives the relative index of mechanical bioeffect. TI and MI indices reflect instantaneous output conditions, so they DO NOT consider the cumulative effects of the total examination time. TI and MI models contain practical simplifications to complex bioeffects interaction. Then the operator should be aware that the actual worst case temperature rise may be up to several times higher than the displayed TI value.

■ MI (Mechanical Index):

The mechanical bioeffects are the result of compression and decompression of insonated tissues with the formation of micro bubbles that may be referred to as cavitations.

MI is an index that shows the possibility of the cavitations generation based on acoustic pressure, and the value in which the peak-rarefactional acoustic pressure is divided by the square root of the frequency. Therefore MI value becomes smaller when the frequency is higher or the peak-rarefactional acoustic pressure is lower, it becomes difficult to generate the cavitations.

$$MI = \frac{P_{r, \alpha}}{\sqrt{f_{\text{amf}}} \times C_{MI}}$$

$$C_{MI} = 1 \text{ (MPa} / \sqrt{\text{MHz}} \text{)}$$

For the frequency 1 MHz and the peak-rarefactional acoustic pressure 1 MPa, MI becomes 1. It is possible to think MI to be one threshold of the cavitations generation. Especially, it is important to keep MI value to be low when both gases and the soft tissues exist together, for such as lung exposure in cardiac scanning and bowel gas in abdominal scanning.

■ TI (Thermal Index):

TI is determined by the ratio of the total acoustic power to the acoustic power required to raise the tissue temperature by 1 degree C. In addition, because the temperature rises is greatly different according to tissue structures, TI is divided three kinds: TIS (Soft-tissue Thermal Index), TIB (Bone Thermal Index) and TIC (Cranial-bone Thermal Index).

- TIS: Thermal index related to soft tissues, such as abdominal and cardiac applications.

- TIB: Thermal index for applications, such as fetal (second and third trimester) or neonatal cephalic (through the fontanel), in which the ultrasound beam passes through soft tissue and a focal region is in the immediate vicinity of bone.
- TIC: Thermal index for applications, such as pediatric and adult cranial applications, in which the ultrasound beam passes through bone near the beam entrance into the body.

Although the output power is automatically controlled for the selected applications, high TI values should be kept to a minimum or avoided in obstetric applications. WFUMB (World Federation for Ultrasound in Medicine and Biology) guidelines: state that temperature increase of 4 degree C for 5 min or more should be considered as potentially hazardous to embryonic and fetal tissue.

The smaller the MI/TI values, the lower the bioeffects.

17.4.2 MI/TI Display

TI and MI values are displayed in the upper part of the screen in real-time. The operator should monitor these index values during examinations and ensure that exposure time and output values are maintained at the minimum amounts needed for effective diagnosis.

NOTE: If there is a value of MI or TI exceeds 1.0, you must be careful to practice the ALARA principle.

The display precision is 0.1.

Display accuracy of MI is $\pm 18.1\%$, and TI is $\pm 34.27\%$.

17.5 Acoustic Power Setting

■ Acoustic power adjustment

Click [A. power] in the soft menu or the menu to adjust the acoustic power percentage, and its value is displayed on the corresponding item as well as at the top of the screen. The greater the acoustic power percentage, the greater the current acoustic output.

When the image is frozen, the system stops transmitting acoustic power.

■ Default setting of acoustic power

Selection of diagnostic applications is the most important factor for controlling ultrasound output.

The permissible level of intensity of ultrasound differs depending on the region of interest. For fetal examinations, in particular, much care must be exercised.

User can perform image settings through preset function in the system. **Once you perform preset settings, default setting of the system may be changed and invalid. It is the user's responsibility for any change to the default settings.**

Adjusting Range

Initial power	7% to 100%*
---------------	-------------

* Definition of 100%: The maximum acoustic power of a transducer determined by the increase in transducer surface temperature in the selected mode and the acoustic power restrictions specified by the FDA.

The default setting is set to 94% in OB1, OB2/3 and Fetal-Cardiac exam modes and 97% in other modes. The user can make adjustments according to the imaging effect in practical use.

Default settings of these two levels are to obtain optimum images for applications under the requirements of safety and ALARA principle.

NOTE: This system automatically returns to the settings whenever changes are made to the values (when you turn on the power, switch between probes, press <End Exam>, or select Return in the Setup menu). In the factory default settings, the Acoustic Output is limited below 100%. Following the ALARA restriction, you are allowed to increase the acoustic power under FDA 510(k) Guidance-Track3 limits and to set it in the image preset screen.

The acoustic output of the system has been measured and calculated in accordance with IEC60601-2-37, FDA 510(K) GUIDANCE, Acoustic Output Measurement Standard for Diagnostic Ultrasound Equipment (NEMA UD-2 2004) and the "Standard for Real-Time Display of Thermal and Mechanical Acoustic Output Indices on Diagnostic Ultrasound Equipment (AIUM and NEMA UD-3 2004).

17.6 Acoustic Power Control

The qualified operator may use the system controls to limit the ultrasound output and to adjust the quality of the images. There are three categories of system controls relative to output. They are controls that have direct effect on the output, controls that indirectly control output and controls that are receiver controls.

■ Direct Controls

It is possible to control, if necessary, the acoustic output with the soft menu control on the control panel. In this case, the maximum value of the acoustic output never exceeds an MI of 1.9, TI of 6 and an $I_{SPTA,3}$ of 720 mW/cm² in any mode of operation.

■ Indirect Controls

The controls that indirectly affect output are many imaging parameters. These are operating modes, frequency, focal point positions, image depth and pulse repetition frequency (PRF).

The operating mode determines whether the ultrasound beam is scanning or non-scanning. Thermal bioeffect is closely connected to M mode, Doppler and Color mode.

Acoustic attenuation of tissue is directly related to transducer frequency.

The focal point is related to active aperture of transducer and beam width.

For the higher PRF (pulse repetition frequency), the more output pulses occur over a period of time.

■ Receiver Controls

The receiver controls (for example, gain, dynamic range, and image post-processing, etc.) do not affect output. These controls should be used, when possible, to improve the image quality before using controls that directly or indirectly affect output.

17.7 Acoustic Output

17.7.1 Derated Ultrasonic Output Parameters

In order to determine the relevant Ultrasonic Output Parameters, a method is used which allows for the comparison of ultrasound systems which operate at different frequencies and are focused at different depths. This approach, called "derating" or "attenuating", adjusts the acoustic output as measured in a water tank to account for the effect of ultrasound propagation through tissue. By convention, a specific average intensity attenuation value is used, which corresponds to a loss of 0.3 dB/cm/MHz. That is, the intensity of ultrasound will be reduced by 0.3 dB/MHz for every centimeter of travel from the transducer. This can be expressed by the following equation:

$$I_{atten} = I_{water} \times 10^{(-0.3/10 \times f_c \times z)}$$

Where I_{atten} is the attenuated intensity, I_{water} is the intensity measured in a water tank (at distance z), f_c is the center frequency of the ultrasound wave (as measured in water), and z is the distance from the transducer. The equation for attenuating pressure values is similar except that the attenuation coefficient is 0.15 dB/cm/MHz, or one-half the intensity coefficient. The intensity coefficient is double the pressure coefficient because intensity is proportional to the square of pressure.

Although the attenuation coefficient chosen, 0.3 dB/cm/MHz, is significantly lower than any specific solid tissue in the body, this value was chosen to account for fetal examinations. In early trimester ultrasound fetal examinations, there may be a significant fluid path between the transducer and the fetus, and the attenuation of fluid is very small. Therefore the attenuation coefficient was lowered to account for this case.

17.7.2 Limits of Acoustic Output

In accordance with the FDA Track 3 requirements, the derating (or attenuated) approach was incorporated into the FDA Acoustic Output Limits, as listed below. The maximum acoustic output level from any transducer in any operating mode is expected to fall below these limits.

FDA Maximum Acoustic Output Limits for Track 3 (Attenuated Values)

Application	$I_{spta.3}$ (mW/cm ²)	$I_{sppa.3}$ (W/cm ²)	MI
Regions (except eyes)	720	≤ 190	≤ 1.9

17.7.3 Differences between Actual and Displayed MI and TI

In operation, the system will display to the operator the Acoustic Output Parameters Thermal Index, TI, or Mechanical Index, MI (or sometimes both parameters simultaneously). These parameters were developed as general indicators of risk from either thermal or mechanical action of the ultrasound wave. They serve to indicate to the operator whether a particular setting of the system increases or decreases the possibility

of Thermal or Mechanical effect. More specifically, they were designed to assist in the implementation of the ALARA principle. As an operator changes a given system control, the potential effect of the change in output will be indicated. However, the Thermal Index is not the same as temperature rise in the body, for several reasons. First of all, in order to provide a single display index to you, a number of simplifying assumptions had to be made. The biggest assumption was the use of the attenuating formula described above, which is much lower than the actual value for most tissues within the body. Scanning through muscle or organ tissue, for example, will produce much higher attenuation than 0.3 dB/cm/MHz. There were also significant simplifications made for the thermal properties of tissue. Therefore, scanning through highly perfused tissue, such as the heart or vasculature, will produce significantly less thermal effect than that suggested by the Thermal Index.

Similarly, the Mechanical Index was derived to indicate the relative possibility of mechanical (cavitation) effects. The MI is based on the derated peak-rarefactional pressure and the center frequency of the ultrasound wave. The actual peak-rarefactional pressure is affected by the actual attenuation caused by tissue in the path between the transducer and the focal point. Again, all solid tissues within the body have higher attenuation than the proscribed 0.3 dB/cm/MHz value, and therefore, the actual peak-rarefactional pressure will be lower. Further, the actual peak-rarefactional pressure will change depending upon the region of the body being scanned.

For these reasons, the TI and MI displays should only be used to assist the operator in implementing ALARA at the time of the patient examination.

17.8 Measurement Uncertainty

I_{spta}	28.5 %
I_{sppa}	28.5 %
Center frequency (f_c)	2%
Total power (W)	28.5 % (5.1% for Scan-mode and Combined-mode)
Peak-rarefactional pressure	14.7 %

17.9 References for Acoustic Power and Safety

1. "Bioeffects and Safety of Diagnostic Ultrasound" issued by AIUM in 1993
2. "Medical Ultrasound Safety" issued by AIUM in 1994
3. "Acoustic Output Measurement Standard for Diagnostic Ultrasound Equipment, Revision 3" issued by AIUM/NEMA in 2004
4. "Standard for real-time display of thermal and mechanical acoustic output indices on diagnostic ultrasound equipment, Revision 2" issued by AIUM/NEMA in 2004
5. "Information for Manufacturers Seeking Marketing Clearance of Diagnostic Ultrasound Systems and Transducers" issued by FDA in 2008.
6. "Medical electrical equipment – Part 2-37: Particular requirements for the safety of ultrasonic medical diagnostic and monitoring equipment" issued by IEC in 2005.

18 Guidance and Manufacturer's Declaration

The system complies with the EMC standard IEC 60601-1-2: 2007.



WARNING:

1. The use of unapproved accessories may diminish system performance.
2. Use of components, accessories, probes, and cables other than those specified may result in increased emission or decreased immunity of system.
3. The system or its components should not be used adjacent to or stacked with other equipment. If adjacent or stacked use is necessary, the system or its components should be observed to verify normal operation in the configuration in which it will be used.
4. Operation of system, in the case that the patient physiological signal is lower than the minimum amplitude or value specified in the product specifications, results may be inaccurate (results can be obtained when the HR is in the range of 30-250 bmp or when the QRS wave amplitude is between 0.5-5 mV.)
5. Wireless LAN communication specifications:
Communication protocol: 802.11 b/ g/n
Communication frequency: 2.4-2.4835GHz
Modulation mode: BPSK/QPSK/16QAM/64QAM
DBPSK/DQPSK/CCCK
Transmission power: $\leq 20\text{dBm(EIRP)}$
Other devices may interfere with this system even though they meet the requirements of CISPR in the corresponding standards.

NOTE:

1. The system needs special precautions regarding EMC and needs to be installed and put into service according to the EMC information provided below.
2. Other devices may interfere with this system even though they meet the requirements of **CISPR** in the corresponding standards.
3. Preventing conducted RF immunity. Due to technological limitations, the conducted RF immunity level are limited to 3 Vrms level, conducted RF interference above 3Vrms may cause wrong diagnosis and measurements. We suggest that you position system further from sources of conducted RF noise.

4. Portable and mobile RF communications equipment can affect system.
See tables 1, 2, 3, and 4 below.

If the system is operated within the electromagnetic environment listed in Table 2 and Table 3, the system will remain safe and will provide the following basic performances:

- Imaging;
- Doppler acoustic spectral displaying;
- Taking measurements;
- Patient information;
- Date/time information.

TABLE 1

GUIDANCE AND MINDRAY DECLARATION—ELECTROMAGNETIC EMISSIONS		
The system is intended for use in the electromagnetic environment specified below. The customer or the user of system should assure that it is used in such an environment.		
EMISSIONS TEST	COMPLIANCE	ELECTROMAGNETIC ENVIRONMENT— GUIDANCE
RF emissions CISPR 11	Group 1	The system uses RF energy only for its internal function. Therefore, its RF emissions are very low and are not likely to cause any interference in nearby electronic equipment.
RF emissions CISPR 11	Class B	The system is suitable for use in all establishments including domestic establishments and those directly connected to the public low-voltage power supply network that supplies buildings used for domestic purposes
Harmonic Emissions IEC 61000-3-2	Class A	
Voltage Fluctuations/ Flicker Emissions IEC 61000-3-3	Compliance	

TABLE 2

GUIDANCE AND MINDRAY DECLARATION—ELECTROMAGNETIC IMMUNITY			
The system is intended for use in the electromagnetic environment specified below. The customer or the user of system should assure that it is used in such an environment.			
IMMUNITY TEST	IEC 60601 TEST LEVEL	COMPLIANCE LEVEL	ELECTROMAGNETIC ENVIRONMENT-GUIDANCE
Electrostatic Discharge(ESD) IEC 61000-4-2	±6 kV contact; ±8 kV air	±6 kV contact; ±8 kV air	Floors should be wood, concrete or ceramic tile. If floors are covered with synthetic material, the relative humidity should be at least 30%.
Electrical fast Transient / burst IEC 61000-4-4	±2 kV for power supply lines;	±2 kV for power supply lines;	Mains power quality should be that of a typical commercial or hospital environment.
Surge IEC 61000-4-5	±1 kV line(s) to line(s); ±2 kV line(s) to earth	±1 kV line(s) to line(s); ±2 kV line(s) to earth	Mains power quality should be that of a typical commercial or hospital environment.
Voltage dips, Short interruptions and voltage variation on power supply input voltage IEC 61000-4-11	<5% U_T (>95% dip in U_T) for 0.5 cycle 40% U_T (60% dip in U_T) for 5 cycle 70% U_T (30% dip in U_T) for 25 cycle <5% U_T (>95% dip in U_T) for 5 sec	<5% U_T (>95% dip in U_T) for 0.5 cycle 40% U_T (60% dip in U_T) for 5 cycle 70% U_T (30% dip in U_T) for 25 cycle <5% U_T (>95% dip in U_T) for 5 sec	Mains power quality should be that of a typical commercial or hospital environment. If you require continued operation during power mains interruptions, it is recommended that our product be powered from an uninterruptible power supply or a battery.
Power frequency (50/60 HZ) magnetic field IEC 61000-4-8	3 A/m	3 A/m	Power frequency magnetic fields should be at levels characteristic of a typical location in a typical commercial or hospital environment.
NOTE: U_T is the A.C. mains voltage prior to application of the test level.			

TABLE 3

GUIDANCE AND MINDRAY DECLARATION—ELECTROMAGNETIC IMMUNITY			
The system is intended for use in the electromagnetic environment specified below. The customer or the user of system should assure that it is used in such an environment.			
IMMUNITY TEST	IEC 60601 TEST LEVEL	COMPLIANCE LEVEL	ELECTROMAGNETIC ENVIRONMENT-GUIDANCE
Conducted RF IEC 61000-4-6	3 Vrms 150 kHz - 80 MHz	3 Vrms	Portable and mobile RF communications equipment should be used no closer to any part of system, including cables, than the recommended separation distance calculated from the equation applicable to the frequency of the transmitter. Recommended separation distance $d = 1.2 \times \sqrt{P}$
Radiated RF IEC 61000-4-3	3 V/m 80MHz - 2.5GHz	3 V/m	$d = 1.2 \times \sqrt{P}$ 80 MHz to 800 MHz $d = 2.3 \times \sqrt{P}$ 800 MHz to 2.5GHz Where, P is the maximum output power rating of the transmitter in watts (W) according to the transmitter manufacturer and d is the recommended separation distance in meters (m). Field strengths from fixed RF transmitters, as determined by an electromagnetic site survey, should be less than the compliance level in each frequency range. Interference may occur in the vicinity of equipment marked with the following symbol: 
<p>Note 1 At 80 MHz and 800 MHz, the higher frequency range applies.</p> <p>Note 2 These guidelines may not apply in all situations. Electromagnetic propagation is affected by absorption and reflection from structures, objects and human body.</p> <p>■ Field strengths from fixed transmitters, such as base stations for radio (cellular /cordless) telephones and land mobile radios, amateur radio, AM and FM radio broadcast and TV broadcast cannot be predicted theoretically with accuracy. To assess the electromagnetic environment due to fixed RF transmitters, an electromagnetic site survey should be considered. If the measured field strength in the location in which system is used exceeds the applicable RF compliance level above, system should be observed to verify normal operation. If abnormal performance is observed, additional measures may be necessary, such as reorienting or relocating system.</p> <p>■ Over the frequency ranges 150kHz to 80MHz, field strengths should be less than 3V/m.</p>			

TABLE 4

RECOMMENDED SEPARATION DISTANCES BETWEEN PORTABLE AND MOBILE RF COMMUNICATION DEVICE AND SYSTEM			
The system is intended for use in an electromagnetic environment in which radiated RF disturbance are controlled. The customer or the user of system can help prevent electromagnetic interference by maintaining a minimum distance between portable and mobile RF communication equipment (transmitters) and system as recommended below, according to the maximum output power of the communication equipment.			
Rated Maximum Output power of Transmitter (W)	Separation Distance According to Frequency of Transmitter (m)		
	150kHz -80MHz $d=1.2\sqrt{P}$	80MHz-800MHz $d=1.2\sqrt{P}$	800MHz-2.5GHz $d=2.3\sqrt{P}$
0.01	0.12	0.12	0.23
0.1	0.38	0.38	0.73
1	1.2	1.2	2.3
10	3.8	3.8	7.3
100	12	12	23
For transmitters at a maximum output power not listed above, the recommended separation distanced in meters (m) can be determined using the formula applicable to the frequency of the transmitter, where P is the maximum output power rating of the transmitter in watts (W) according to the transmitter manufacturer.			
If system image distortion occurs, it may be necessary to position system further from sources of conducted RF noise or to install external power source filter to minimize RF noise to an acceptable level.			
Note 1 At 80 MHz and 800 MHz, the separation distance for the higher frequency range applies.			
Note 2 These guidelines may not apply in all situations. Electromagnetic propagation is affected by absorption and reflection from structures, objects and human body.			

Cable sample

No.	Name	Cable length (m)	Shield or not	Remarks
1.	AC inlet cable for the main unit	2.5	No	/
2.	Cable for power adapter	2.5	No	/
3.	ECG Lead	2.9	Yes	/
4.	ECG Module connecting cable	2.0	Yes	/
5.	Foot-switch control cable	2.8	Yes	/
6.	Probe cable	2.2	Yes	All probe cables
7.	External DVD recorder connecting cable	1.5	Yes	/
8.	Video module cable	2.0	Yes	/

19 System Maintenance

Routine system maintenance shall be carried out by the user. System maintenance after the warranty has expired is the full responsibility of the owner /operator. The responsibility for maintenance and management of the product after delivery resides with the customer who has purchased the product.

If you have any questions, please contact Mindray Customer Service Department or sales representative.

- | | |
|---|--|
|  WARNING: | <ol style="list-style-type: none">1. Only an authorized Mindray service engineer can perform maintenance not specified in this operator's manual.2. For the sake of the system performance and safety, you should perform periodical checks for the system. |
|---|--|

19.1 Daily Maintenance

You are responsible for daily maintenance.

19.1.1 Cleaning the System

- | | |
|---|--|
|  WARNING: | Before cleaning the system, be sure to turn off the power and disconnect the power cord from the outlet. If you clean the system while the power is "On", it may result in electric shock. |
|---|--|

- | | |
|---|--|
|  CAUTION: | Do not spill water or other liquid into the system while you perform the cleaning. Otherwise it may result in malfunction or electric shock. |
|---|--|

■ Cleaning the probe

Please refer to the operator's manual of the corresponding transducer or "12 Probe and Biopsy" chapter to perform cleaning and disinfection.

- Cleaning the probe enclosure and connector:
 - Tools: mild soapy water , dry soft cloth , soft brush
 - Method:
 - a) Use dry soft cloth to wipe out the dust attached to surface of probe, acoustic head of the probe, connector and probe cable;
 - b) Remained stain or dust attached to surface of probe cable or connector should be washed out by cloth with clear water or soapy water, and then air-dry the probe cable or connector;
 - c) Use a soft brush to clean the connector, removing dust simultaneously.

Note: DO NOT use cloth with water to clean the connector.

- Cleaning the probe cable
 - a) Use soft dry cloth to wipe off stains from the probe cable.
 - b) If it is difficult to clean the stains thoroughly, use soft cloth dipped with mild detergent, and then let the cable air dry.

■ Cleaning the monitor

- Tool: soft dry cloth ,clear water or mild soapy water
- Method:

Surface of display should be cleaned with soft dry cloth. Remained stain should be washed out by cloth with clear water or soapy water, and then air-dry the surface.

NOTE: 1. Do not use hydrocarbon glass cleaner or cleaner for OA (Office Automation) equipment to clean the monitor. These substances may cause deterioration of the monitor.

2. Please clean the control panel periodically, otherwise the button may be blocked by dirt and the system will be buzzing while the button makes no response.

■ Cleaning the control panel

- Tools: dry soft cloth, mild soapy water
- Method:

Use dry soft cloth to clean the surface of the system. If the system is dirty, moisten the soft cloth with mild soapy water and wipe off any stains. Use dry soft cloth to remove any moisture and allow all hard surfaces to completely air-dry. If it is difficult to clean the control panel, disassemble the keys first and then use mild soapy water to clean it.

■ Cleaning cover

- Tools: dry soft cloth, soapy water
- Method:

Use dry soft cloth to clean the cover of the system. If the system is dirty, moisten the soft cloth with mild soapy water and wipe off any stains, then air-dry.

Note: Be sure to use soft brush to brush the dust attached to all the sockets or interfaces which can be seen (such as probe sockets, sockets or interfaces in IO panel and power supply panel),not the cloth with water.

■ Cleaning the trackball

- Tools: Paper, dry cloth or mild soapy water
- Method:

For the stable performance of the system, you should perform periodical cleaning for the trackball. A dumb cursor may be resulted from dirt inside the trackball.

a) Disassembling:

Rotate the trackball clamp ring 35 degrees anticlockwise. When the clamping ring lifts, remove the clamping ring and trackball. You can draw out the ball with the help of adhesive tape. See the figures below.

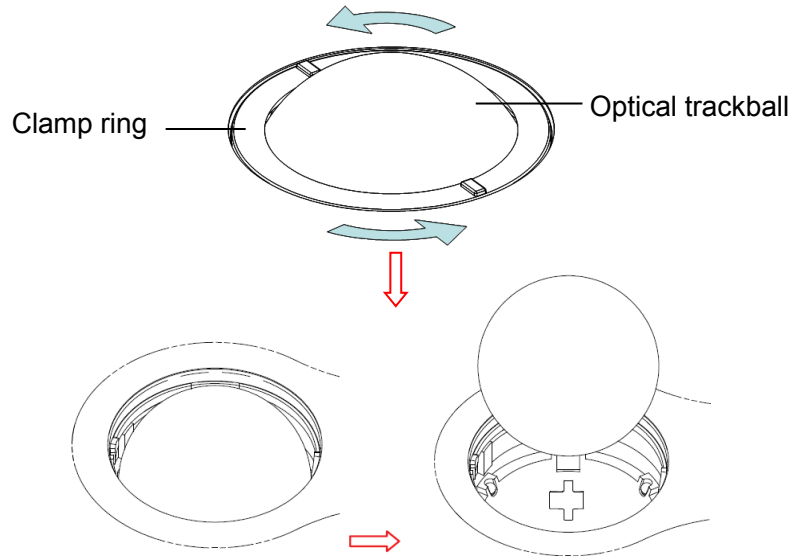

b) Cleaning:

Clean the lens slightly using the tissue until there is no foreign matter. Then clean the other parts and the dust excluder. Make sure to exert force properly when clean the small ball, otherwise, the small ball may drop down. See the figure below.

No system shutdown is required during the whole clean. Reinstall the ball and clamp ring after the clean is finished.

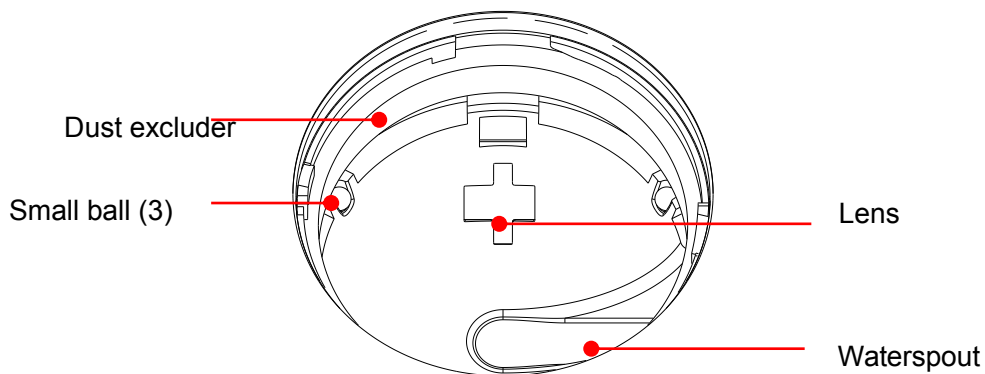

When liquid is spray onto the trackball area, most of the liquid can be discharged through the waterspout, besides, you can dry the leaving water using the tissue or cloth.

c) Installing

Put back the ball, align the buckle with gap of the front cover, press the clamp ring with both hands and rotate it 35 degrees clockwise to click the buckle. At this moment, the clamp ring cannot be moved any further, it indicates that the clamp ring clicks in position. See the figure below.

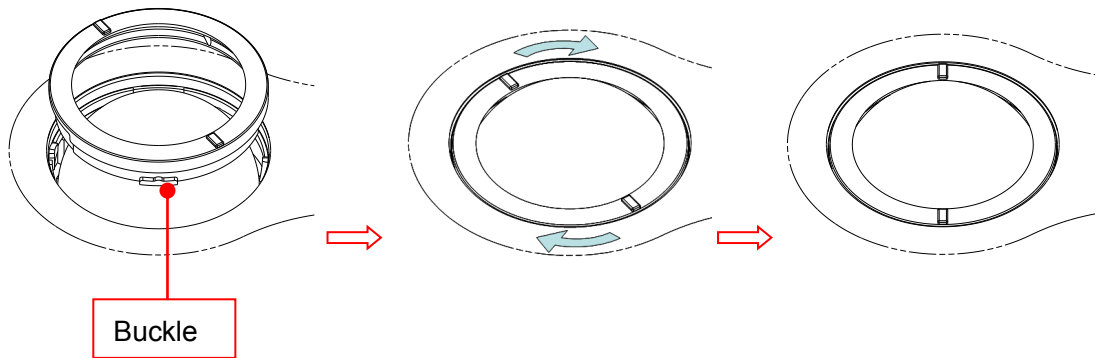

■ Cleaning the peripherals

Do the cleaning maintenance according to your actual peripheral configuration; items which are not configured can be skipped.

Content	Description
Color and B/W video printer	First wipe off dust or stain attached to the cover of printer with soft dry cloth, then clean the inside of printer. Be sure to do the cleaning maintenance according to the operation manual if is necessary.
Graph / text printer	First wipe off dust or stain attached to the cover of printer with soft dry cloth, then clean the inside of printer. Be sure to do the cleaning maintenance according to the operation manual if is necessary.
Foot switch	Use soft dry cloth with a little mild soap water to wipe off the dust or stain attached to the pedals or cable of foot switch.

19.1.2 Checking the Probe

- Visually check to confirm that there is no crack and expansion to probe head.
- Visually check to confirm that there is no deterioration or desquamation to probe cable.
- Visually check to confirm that there is no bend, destroyed or falling off pins to the connector.

19.1.3 Checking the Power Cable and Plug

- Visually check to confirm that there is no wrinkles, crack or deterioration; No crack and expansion to the surface of adapter.
- Manually check to confirm that there is no looseness or rupture. The connection of plug is reliable.

19.1.4 Checking Appearance

Check if there is any crack in the covers:

- Ultrasound system covers
- Probe appearance
- External appearance of ECG lead

19.1.5 Backup of the System Hard Drive

To prevent deterioration or loss of data stored in the system hard drive, create a backup copy of the hard drive data (including patient info data, preset data and etc.) at regular intervals.

19.2 Troubleshooting

If any persistent system malfunction is experienced, e.g. an onscreen error message, blank imaging screen, absent menus, please refer to the following table below. If the failure cannot be eliminated, please contact Mindray Customer Service Department or sales representative.

■ Troubleshooting Table

No.	Failure	Cause	Measure
1	After the AC power input is connected,, the AC power status indicator does not light on.	Abnormal power system or incorrect connection of the power cord.	Verify that the plug has not become loosened or dislodged from the back of the system.
2	When the power indicator of the monitor is on and image is blank.	<ul style="list-style-type: none"> ■ The interval between turnoff and restart is too short – wait a minimum time of 20 seconds. ■ The monitor brightness or contrast may be improperly set (use <Fn>+ Direction key to adjust). 	<ul style="list-style-type: none"> ■ Turn off the system and wait a minimum time of 1 minute, and then restart the system. ■ Adjust the monitor brightness and contrast back to factory defaults.
3	The monitor displays the characters but no images.	<ul style="list-style-type: none"> ■ The transmission power, overall gain or TGC controls are improperly set. ■ Verify that a probe is connected and / or fully connected. ■ The system is in the frozen status. 	<ul style="list-style-type: none"> ■ Adjust the transmission power, gain or TGC control. ■ Ensure proper probe connection. ■ Unfreeze the image.
4	The image quality is degraded	<ul style="list-style-type: none"> ■ The exam mode is not correct. ■ The settings of the image post processing are not correct. ■ The image presets are inappropriate 	<ul style="list-style-type: none"> ■ Select an appropriate exam mode. ■ Adjust the settings of the image via post processing or reset the post processing to the default values. ■ Reset the factory default setups.
5	The button is responseless with the system buzzing	<ul style="list-style-type: none"> ■ There is too much dirt blocking the button 	<ul style="list-style-type: none"> ■ Check the control panel for the button being blocked and press it several times to release it. ■ Clean the button.

Appendix A Wireless LAN



WARNING

1. It is prohibited to use the wireless LAN function in airplane, as it may violate the relevant provisions in the aviation regulations.
2. Use the wireless LAN function prudently in the emergency ambulance (or other vehicles) as other devices or communication signals may be interfered with.
3. Be prudent to use the wireless LAN function in OR/ ICU/ CCU as it may interfere with other devices.
4. When wireless LAN function is turned on, the ultrasound system may be interfered with by other equipment, even if that other equipment complies with CISPR EMISSION requirements.

A.1 To Use the W-LAN Function

The system can be configured with wireless net adapter, so as to assist information communication.

1. Connect the wireless LAN adapter using the USB port.
2. Local TCP/IP setting in preset:
 - a) Press <Setup> to enter the Setup menu.
 - b) Move the cursor onto [Network Preset], select [Local TCP/IP] to open the screen, as shown in the figure below:

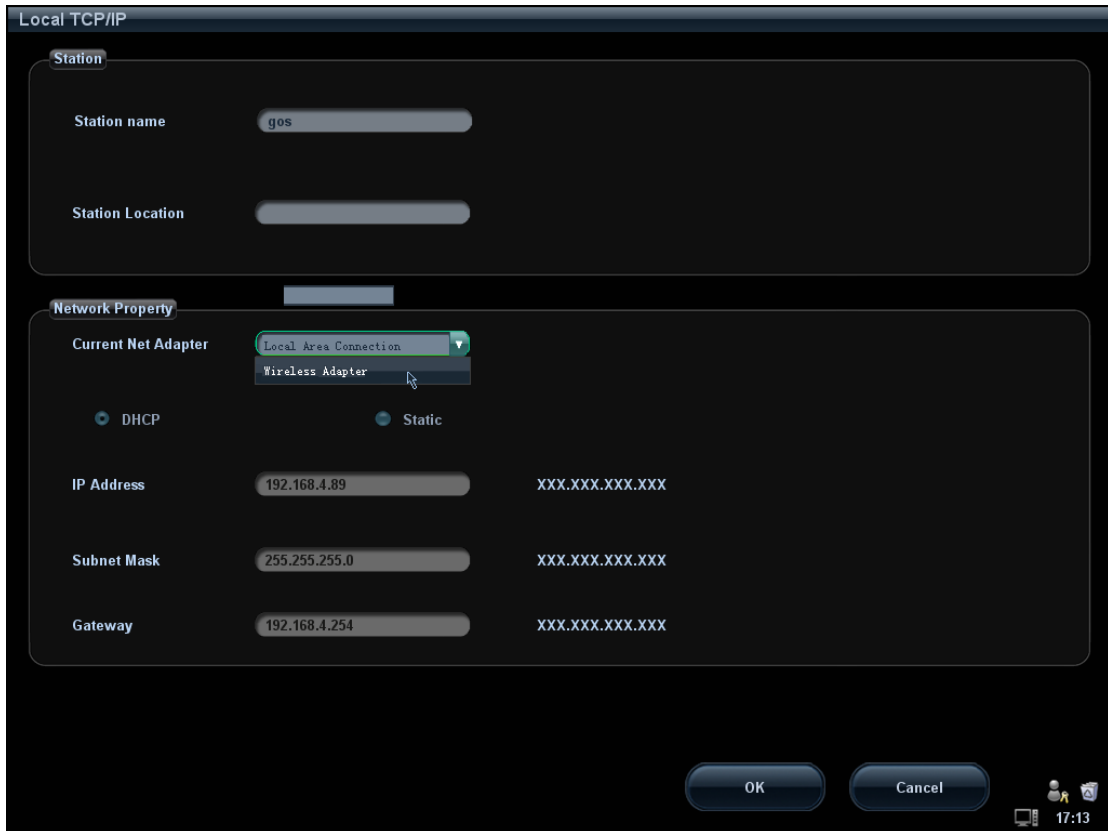



c) Local TCP/ IP preset items are described as follows:

Name	Description
Station Name	Name of the ultrasound system.
Station Location	Location or department where the system is placed.
Current Net Adapter	To select net adapter type.
DHCP/ Static	If “DHCP” is selected, IP address will be automatically obtained from DNS server; if “Static” is selected (using static IP address), you need to enter the IP address.
IP Address	IP address of the system.
Subnet Mask	Used to set different network segment.
Gateway	Used to set the gateway IP.
OK	Click to confirm parameter setting.
Cancel	Click to cancel parameter preset.

The IP address of the system should not be occupied by other devices in the LAN, or failure may result.

NOTE DO Not edit IP address in Network Preset page as the network task is executed, otherwise it fails. View if there is any undergoing task in task manager of the system.

3. Click the wireless LAN manager icon  in the lower right corner of the toolbar region, and the manager dialogue box pops up:
 - [Connect]: select the target network and click to connect, and the manager icon turns  after connected.

- [Disconnect]: select the target network and click to disconnect.
- [Refresh]: click to update the wireless network list.
- [Configure]: click to enter the “Local TCP/IP Setting” screen.
- [Show Detail]: click to view the connection information of the wireless network, and select [Export] in the prompted dialogue box to save the information.
- [Set Preferred Network]: click to set the selected network to be a default connecting network, and the system will automatically connect to this network after detecting it.
- [Delete Profile]: click to delete the preferred network setting and password that has been entered.

NOTE:

1. When connecting an encrypted network, entered password will be remembered.
2. When there is more than one wireless router in the LAN, DO NOT disable the DHCP function of the current router.
3. If error password has been entered when connecting an encrypted network, click [Delete Profile] and reconnect the network.

Tips: if abnormal network performance is detected, e.g. wireless network list is not updated in time; you may take the following measures:

1. Connect/disconnect the network adapter again.
2. Restart the router and ultrasound system if the problem is not fixed.
3. Restart the router again and wait for 5-10 min and reconnect the network again if the problem is not fixed.

A.2 To Install Drive for Wireless Adapter

You can install drive for wireless adapters through the following path:

- a) Acquire the License file from the service engineer.
- b) Press <Setup> to enter the Setup menu.
- c) Move the cursor onto [Network Preset], select [Setup Wireless Driver] to open the screen, as shown in the figure below:

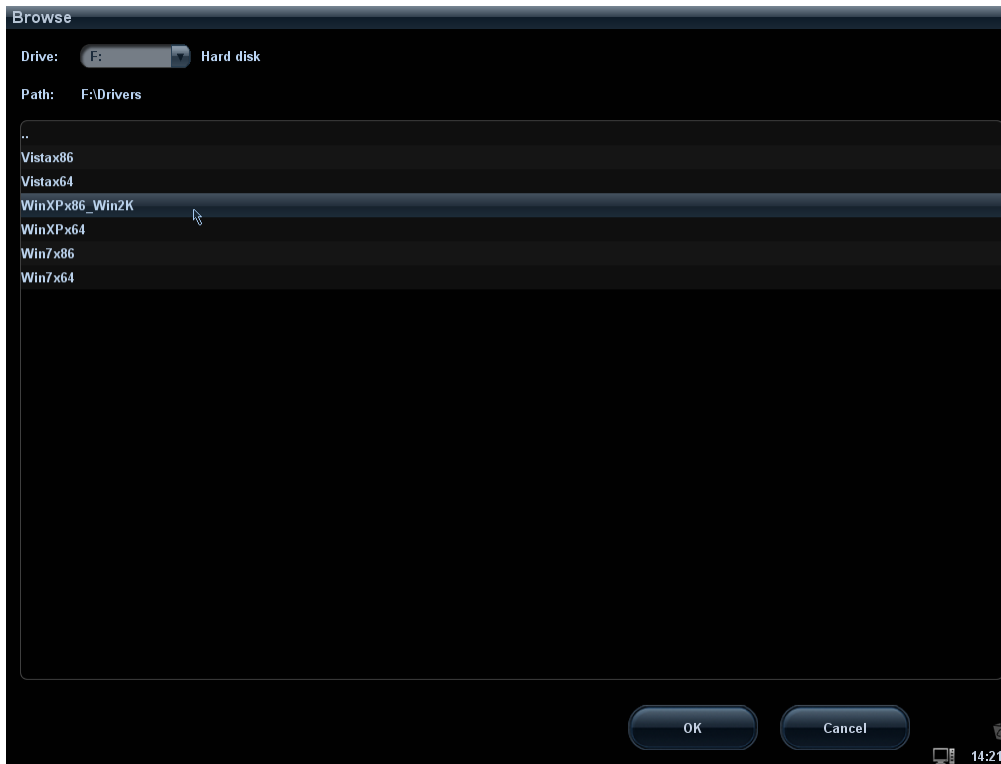

- d) Select the path for installing the drive and click [OK] to pop up the driver install dialogue box.

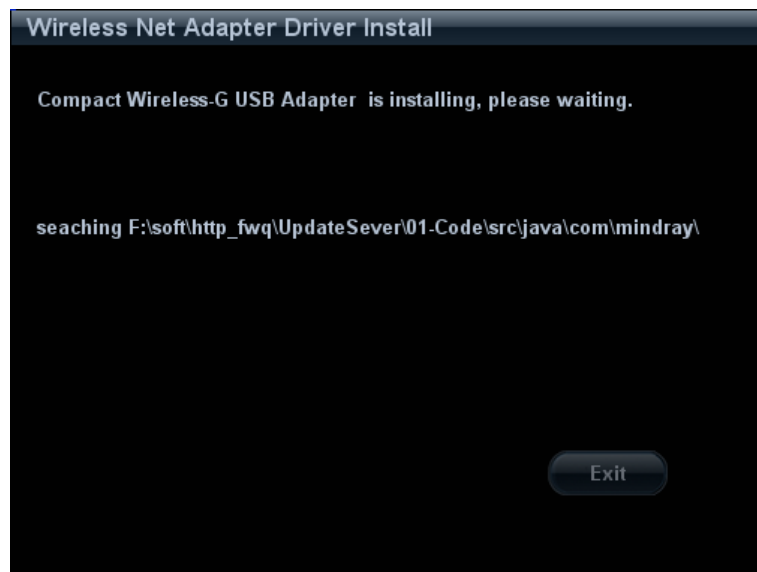

- e) The wireless LAN manager icon will display in the lower right corner of the toolbar region after the installation succeeds.

Appendix B Barcode Reader

The product supports two kinds of readers for logging data as patient ID: 1-D barcode reader (SYMBOL LS2208) and 2-D barcode reader (SYMBOL DS4308).

The laser transmitted by SYMBOL LS2208 is Class 2 laser.

SYMBOL DS4308 is classified as “EXEMPT RISK GROUP” according to IEC 62471:2006 and EN 62471:2008.

 WARNING: Class 2 laser adopts low power, visible LED. DO NOT stare into beam because of unknown hazards of transient radiation provided by class 2 laser. DO NOT stare into beam emitted by SYMBOL DS4308 for more than 10s.
--

 CAUTION: Ensure the information acquired by barcode reader is consistent with the actual information.

Note: the reader does not support decoding of Multilanguage.

B.1 1-D Barcode Reader

There are 2 operation modes:

Hand-held mode: press the trigger to decode.

Hands-free mode: seat the reader in the stand to enter the mode, the reader decodes automatically.

B.1.1 Overview



1.	LED	Green: A barcode was successfully decoded. Red: A data transmission error or reader malfunction occurred.
2.	Scan window	Scan the barcode.
3.	Trigger	Press to decode

B.1.2 Setting Up the Reader (Take LS2208 as an example)

1. Plug the interface cable modular connector into the cable interface port on the bottom of the reader handle, and ensure the connector is properly secured.
2. Connect the other end of the interface cable to the host.

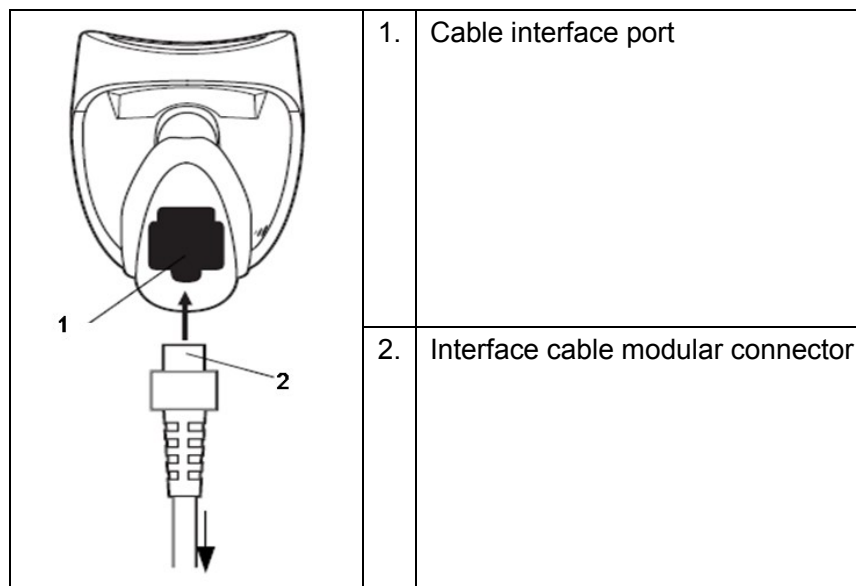

B.1.3 Setting

The reader has factory settings; please refer to A.4 for details.

The reader supports some user-defined functions as introduced below.

For more details, please contact the SYMBOL reader agents or Mindray Customer Service Department.

■ Volume setting:

Scan the following barcode to set the volume parameter.



Low Volume



Medium Volume



High Volume

■ code 93 and codebar scanning:

To enable or disable Code 93, scan the appropriate barcode below.



Enable Code 93

To enable Codebar, scan the appropriate barcode below.



Enable Codabar

■ code 39 full ASCII scanning:

Code 39 Full ASCII is a variant of Code 39 which pairs characters to encode the full ASCII character set. To enable or disable Code 39 Full ASCII, scan the appropriate barcode below.



Enable Code 39 Full ASCII



Disable Code 39 Full ASCII

- 1 2 of 5 symbols setting:



1 2 of 5 - One Discrete Length

Select this option to decode only 1 2 of 5 symbols containing a selected length. Select the length using the numeric barcodes below. For example, to decode only 1 2 of 5 symbols with 8 characters, scan **1 2 of 5 - One Discrete Length**, then scan **0** followed by **8**.



0



1



2



3



4



5



6



7



8



9

B.1.4 Scanning in Hand-Held Mode

1. Ensure all connections are secure.
2. Aim the reader at the barcode. Press the trigger.

Note: Ensure the scan line crosses every bar and space of the symbol, see the figure below.

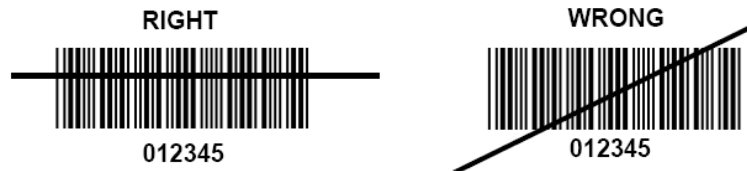

3. Upon successful decode, the reader beeps and the LED turns green.

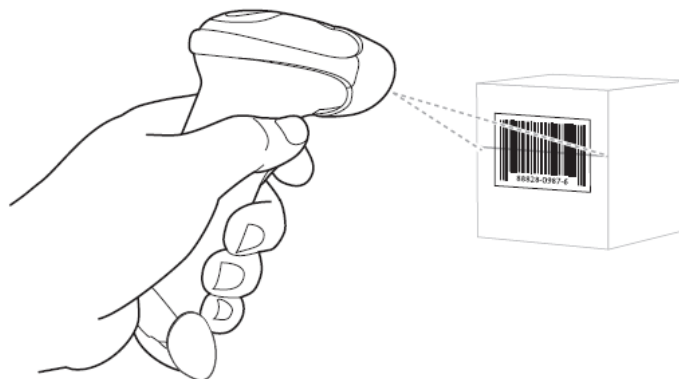

Tips: Do not hold the reader directly over the barcode. Laser light reflecting *directly* back into the reader from the barcode is known as specular reflection. This specular reflection can make decoding difficult. You can tilt the reader up to 55° forward or back and achieve a successful decode

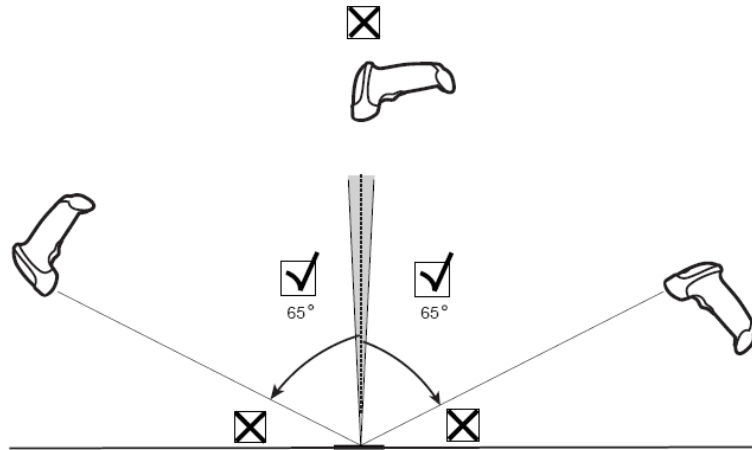

B.1.5 Scanning in Hands-Free Mode

B.1.5.1 Assembling the Intellistand

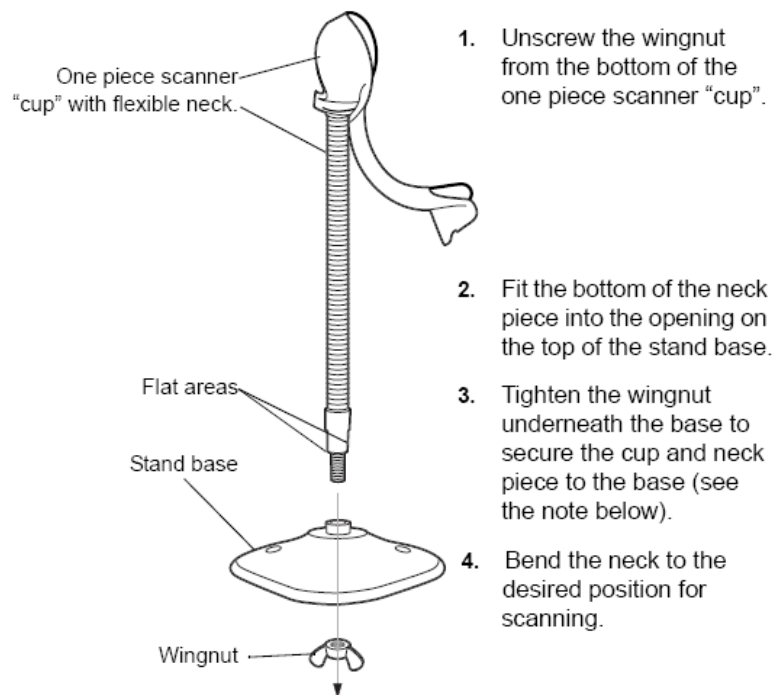

NOTE Before tightening the wingnut under the base, ensure that the flat areas on the flexible neck fit securely in the grooves in the base.

B.1.5.2 Mounting the Stand (optional)

You can attach the base of the reader's stand to a flat surface using two screws or double-sided tape (not provided).

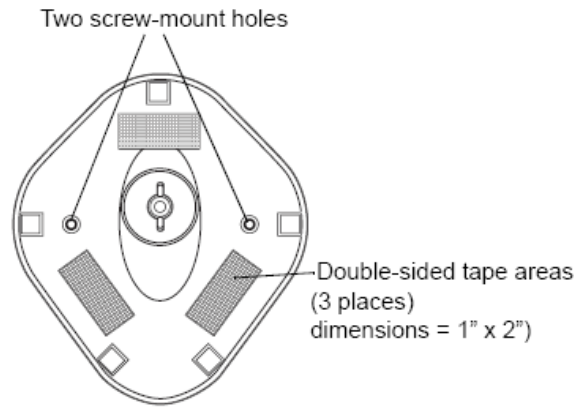

■ Screw Mount

1. Position the assembled base on a flat surface.
2. Screw one #10 wood screw into each screw-mount hole until the base of the stand is secure

■ Tape Mount

1. Peel the paper liner off one side of each piece of tape and place the sticky surface over each of the three rectangular tape holders.
2. Peel the paper liner off the exposed sides of each piece of tape and press the stand on a flat surface until it is secure.

B.1.5.3 Scanning in Hands-Free Mode

When the reader is seated in the stand's "cup", the reader's built-in sensor places the reader in hands-free mode. When you remove the reader from the stand it operates in its normal hand-held mode.

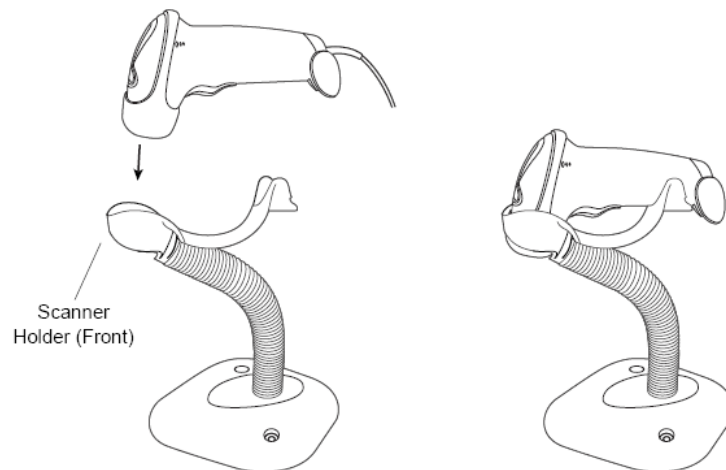

B.2 2-D Barcode Reader (Take DS4308 as an example)

The 2-D barcode reader supports hand-held operation mode.

Hand-held mode: press the trigger to decode.

B-8 Barcode Reader

B.2.1 Overview

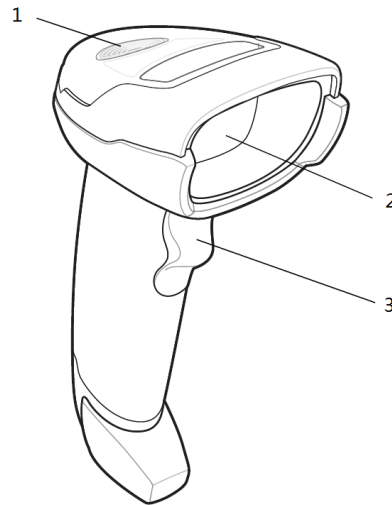

1.	LED	Green: A barcode was successfully decoded. Red: A data transmission error or reader malfunction occurred.
2.	Scan window	Scan the barcode.
3.	Trigger	Press to decode

B.2.2 Setting Up the Digital Imager Reader

B.2.2.1 Installing the Interface Cable

1. Plug the interface cable modular connector into the cable interface port on the bottom of the reader handle and ensure the connector is properly secure.
2. Connect the other end of the interface cable to the host.

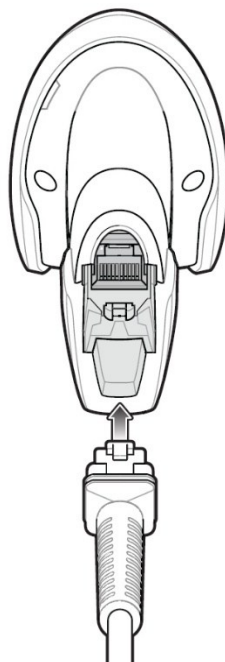

B.2.2.2 Removing the Interface Cable

1. Using the tip of a screwdriver or some other tools with a sharp head, depress the cable's modular connector clip.

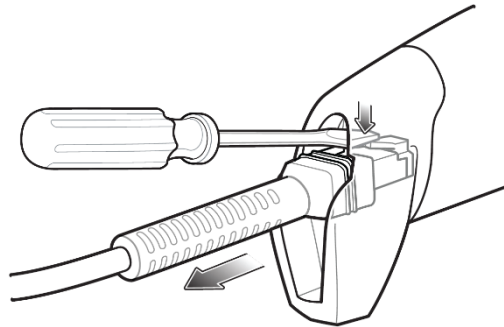

2. Carefully slide out the cable.

B.2.3 Setting

The reader has factory settings; please refer to A.4 for details.

The reader supports some user-defined functions as introduced below.

For more details, please contact the SYMBOL reader agents or Mindray Customer Service Department.

Volume setting:

Scan the following barcode to set the volume parameter.



Low Volume
(2)



Medium Volume
(1)



***High Volume**
(0)

code 93 and codabar setting

To enable Code 93, scan the appropriate barcode below.



***Enable Code 93**
(1)

To enable Codabar, scan the appropriate barcode below.



***Enable Codabar
(1)**

code 39 full ASCII setting

Code 39 Full ASCII is a variant of Code 39 which pairs characters to encode the full ASCII character set. To enable or disable Code 39 Full ASCII, scan the appropriate barcode below.



**Enable Code 39 Full ASCII
(1)**



***Disable Code 39 Full ASCII
(0)**

1 2 of 5 symbols setting



1 2 of 5 - One Discrete Length

Select this option to decode only 1 2 of 5 symbols containing a selected length. Select the length using the numeric barcodes below. For example, to decode only 1 2 of 5 symbols with 8 characters, scan **1 2 of 5 - One Discrete Length**, then scan **0** followed by **8**.



0



1



2



3



4



5



6



7



B.2.4 Scanning in Hand-Held Mode

1. Ensure all connections are secure (see the appropriate host chapter.)
2. Aim the digital imager reader at the barcode.

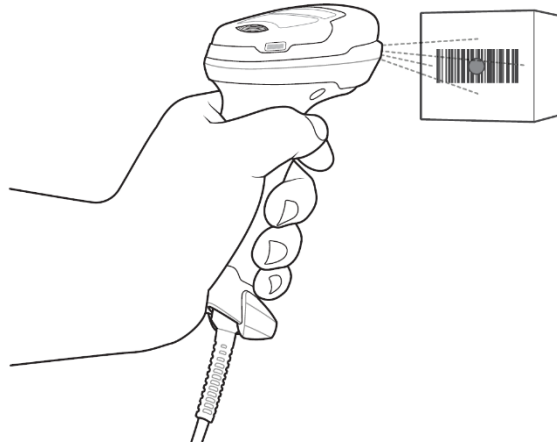

3. When the digital imager reader senses movement, in its default **Auto Aim** trigger mode, it projects a red LED dot which allows positioning the barcode within the field of view.

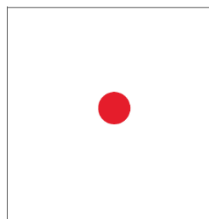

If necessary, the digital imager reader turns on its red LEDs to illuminate the target barcode.

4. Center the symbol. Be sure the entire symbol is within the rectangular area formed by the illumination LEDs.

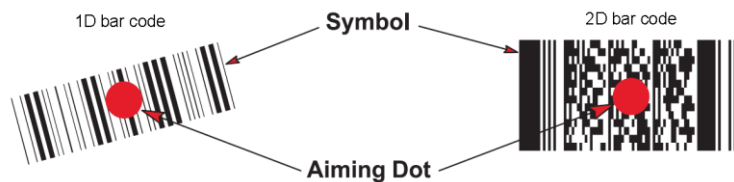

5. Hold the trigger until the digital imager reader beeps, indicating the barcode is successfully decoded.

NOTE: Steps 2 - 4 may be required to repeat on poor quality or difficult barcodes.

The aiming pattern is smaller when the digital imager reader is closer to the symbol and larger when it is farther from the symbol. Scan symbols with smaller bars or

elements (mil size) closer to the digital imager reader, and those with larger bars or elements (mil size) farther from the digital imager reader.

The digital imager reader can also read a barcode presented within the aiming dot not centered. The top examples in show acceptable aiming options, while the bottom examples cannot be decoded.

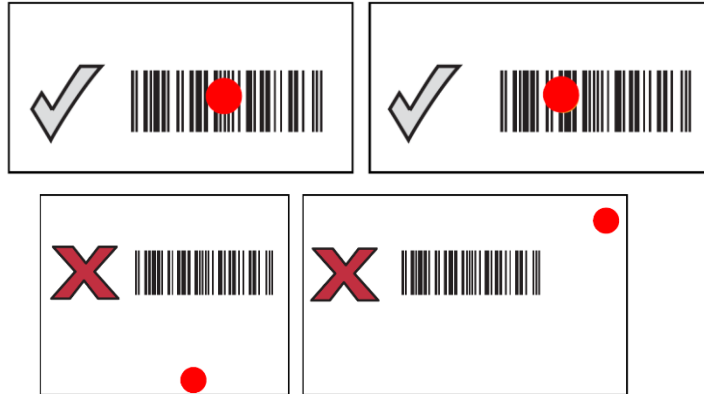

B.3 Setting in Ultrasound System

1. Press <Setup> to enter the Setup menu.
2. Select [System Preset]- “General”, if “Scan Code” tab is invisible, click .

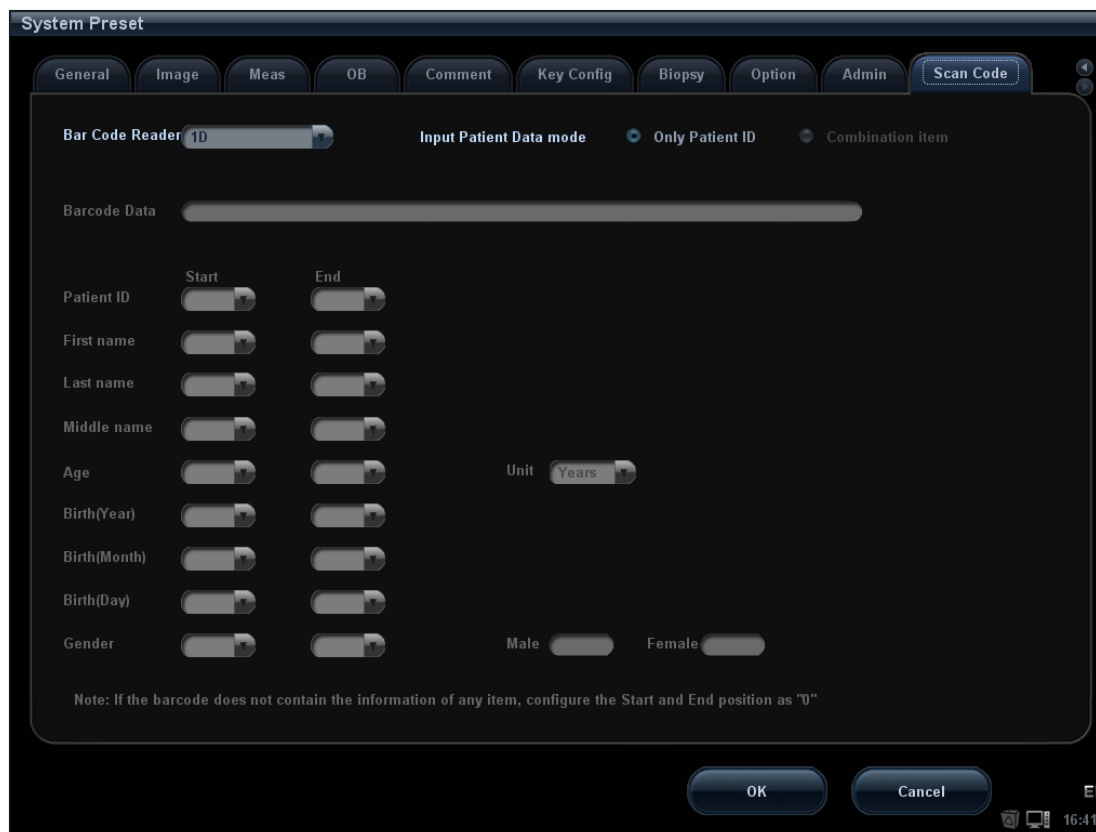

Setting items are described as follows:

Parameter	Description
Bar Code Reader	Select type: 1D or 2D.
Input Patient Data mode	Select the mode for inputting patient data. Only Patient ID: only patient ID is acquired from barcode reader. If this function is selected, patient ID can be acquired via barcode reading in Patient, Worklist or QR screen. Combination Item: patient ID, patient name and other information can be acquired from barcode.(available only in 2-D reader)
Barcode Data	When 2-D reader is adopted, you should first scan a sample barcode here and then set the parts definition for the information.
Patient ID Patient Name Age Birth Gender	Set the start and end position of each item. Note: 1. Length of birth month and data are of 2 letters. 2. If one item of information is not included in the barcode, set the start and end position of the item to be 0 respectively.

B.4 Parameter Defaults

Refer to the following table for parameter defaults of LS2208 and DS4308.

Parameter	Defaults
1-D Symbologies	
UPC/EAN	
UPC-A	Enable
UPC-E	Enable
UPC-E1	Disable
EAN-8/JAN 8	Enable
EAN-13/JAN 13	Enable
Bookland EAN	Disable
Decode UPC/EAN/JAN Supplementals (2and 5 digits)	Ignore
UPC/EAN/JAN Supplemental Redundancy	10
Transmit UPC-A Check Digit	Enable
Transmit UPC-E Check Digit	Enable
Transmit UPC-E1 Check Digit	Enable
UPC-A Preamble	System Character
UPC-E Preamble	System Character
UPC-E1 Preamble	System Character
Convert UPC-E to A	Disable
Convert UPC-E1 to A	Disable
EAN-8/JAN-8 Extend	Disable
UCC Coupon Extended Code	Disable
Code 128	
Code 128	Enable
UCC/EAN-128	Enable
ISBT 128	Enable
Code 39	
Code 39	Enable
Trioptic Code 39	Disable
Convert Code 39 to Code 32 (Italian Pharmacy Code)	Disable
Code 32 Prefix	Disable
Set Length(s) for Code 39	2 to 55
Code 39 Check Digit Verification	Disable
Transmit Code 39 Check Digit	Disable
Code 39 Full ASCII Conversion	Disable
Buffer Code 39	Disable
Code 93	
Code 93	Enable
Set Length(s) for Code 93	4 to 55
Interleaved 2 of 5 (ITF)	
Interleaved 2 of 5 (ITF) Enable	Enable
Set Lengths for I 2 of 5	14
I 2 of 5 Check Digit Verification	Disable
Transmit I 2 of 5 Check Digit	Disable
Convert I 2 of 5 to EAN 13	Disable
Codabar (NW - 7)	
Codabar	Enable
Set Lengths for Codabar	5 to 55
CLSI Editing	Disable
NOTIS Editing	Disable
2-D Symbologies	
PDF417	Enable
MicroPDF417	Disable
Code 128 Emulation	Disable
Data Matrix	Enable

Parameter	Defaults
Maxicode	Enable
QR Code	Enable

B.5 Maintenance

Cleaning the exit window is the only maintenance required. A dirty window can affect scanning accuracy.

- Do not allow any abrasive material to touch the window.
- Remove any dirt particles with a damp cloth.
- Wipe the window using a tissue moistened with ammonia/water.
- Do not spray water or other cleaning liquids directly into the window.

Appendix C iScanHelper

By providing the referential information, such as, the ultrasonic image, the anatomic graphic, scanning pictures/other scanning tips or diagnosis comments, the system helps the doctors to operate the scanning by iScanHelper. Furthermore, it is a good platform for the self-learning and training of ultrasound scanning technique for doctors. The system also plays a role in the assistant software system in fulfilling training and education.

Tips: iScanHelper feature is available in abdominal, gynecological, urological, obstetrical and small parts area.

NOTE: THIS “iScanHelper” IS FOR REFERENCE OR TUTORIAL PURPOSES ONLY, AND THE MANUFACTURER WILL NOT BE LIABLE FOR DAMAGES AND/OR OTHER UNDESIRABLE CONSEQUENCE IN ANY KIND THAT MAY OCCUR TO THE PATIENT OR THE USERS BY USING THE SOFTWARE.

C.1 Enter/ Exit

■ Enter

Press the user-defined key for entering iScanHelper (setting path: [Setup] -> [System] -> [Key Config.]).

■ Exit

Press the user-defined key again to exit iScanHelper.

C.2 Use iScanHelper for Reference

1. Perform ordinary scanning procedure.
2. Press the user-defined key for entering iScanHelper to enter iScanHelper status.
3. Rotate the trackball to move the cursor onto the target view name in the view selecting box and then press <Set>.
4. Perform scanning according to information displayed on the help information area.
You can zoom in a single window in the help information area to see the window more clearly. For details, please refer to “C.4.3 Single/quad-window Display”.
5. Press the user-defined key for entering iScanHelper again to exit.

C.3 Use iScanHelper for Learning or Training

1. Switch to the exam modes that support iScanHelper.
2. Press the user-defined key for entering iScanHelper to enter iScanHelper status.
3. Learn and practise views by system defaulted sequence according to the information displayed on help information area; or select unfamiliar views to practise.
You can zoom in a single window in the help information area to see the information. For details, please refer to “C.4.3 Single/quad-window Display”.
4. Press the user-defined key for entering iScanHelper again to exit iScanHelper.

C.4 Basic Screen and Operation

iScanHelper information area is displayed on the right part of the screen.

C.4.1 View Selecting Area

Rotate the trackball to move the cursor onto the target view and press <Set>, related information will be displayed on the help information area.

C.4.2 Help Information Area

Help information area displays on the lower right corner of the screen, providing ultrasonic image, anatomic graphic, scanning picture and scanning tips.

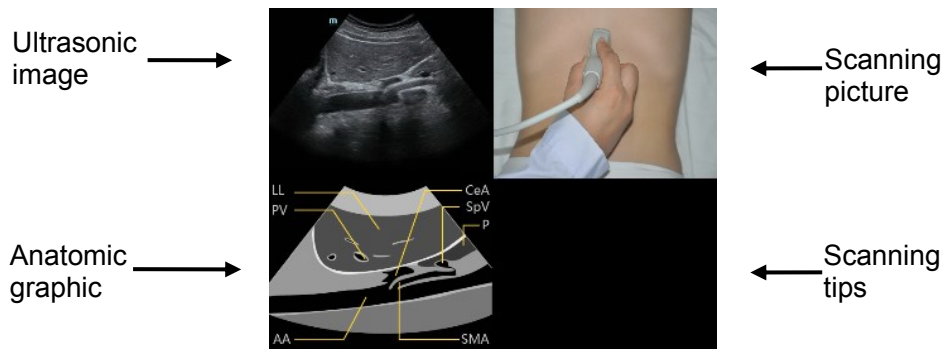

- Ultrasonic image
It is used to compare with images scanned by the operator.
- Anatomic graphic
Related anatomical tissue information are provided here.
- Scanning picture
Ordinary scanning tips can be observed here, including posture, probe mark, probe swing/sweep techniques.
- Scanning tips
You can read tissue related anatomical information and adjacent tissue information here.

C.4.3 Single/quad-window Display

You can zoom in the anatomic graphic, ultrasonic image as well as scanning picture to view those information more conveniently.

Press <Cursor> to obtain the cursor. Move the cursor on the anatomic graphic, the ultrasonic image or scanning tips. Double-click <Set> to go to the single window of each of them. Double-click single window again to return to quad-window display.

C.5 Measurement, Comments, and Body Mark

Switching probe or exam, measurement, comments and the body mark are unavailable under iScanHelper status.

Appendix D Electrical Safety

Inspection

The following electrical safety tests are recommended as part of a comprehensive preventive maintenance program. They are a proven means of detecting abnormalities that, if undetected, could prove dangerous to either the patient or the operator. Additional tests may be required according to local regulations.

All tests can be performed using commercially available safety analyzer test equipment. These procedures assume the use of a 601PROXL International Safety Analyzer or equivalent safety analyzer. Other popular testers complying with IEC 60601-1 used in Europe such as Fluke, Metron, or Gerb may require modifications to the procedure. Follow the instructions of the analyzer manufacturer.

The electrical safety inspection should be periodically performed every two years. The safety analyzer also proves to be an excellent troubleshooting tool to detect abnormalities of line voltage and grounding, as well as total current loads.

D.1 Power Cord Plug

D.1.1 The Power Plug

Test Item		Acceptance Criteria
The power plug	The power plug pins	No broken or bent pin. No discolored pins.
	The plug body	No physical damage to the plug body.
	The strain relief	No physical damage to the strain relief. No plug warmth for device in use.
	The power plug	No loose connections.
The power cord		No physical damage to the cord. No deterioration to the cord.
		For devices with detachable power cords, inspect the connection at the device.
		For devices with non-detachable power cords, inspect the strain relief at the device.

D.2 Device Enclosure and Accessories

D.2.1 Visual Inspection

Test Item	Acceptance Criteria
The enclosure and accessories	No physical damage to the enclosure and accessories.
	No physical damage to meters, switches, connectors, etc.
	No residue of fluid spillage (e.g., water, coffee, chemicals, etc.).
	No loose or missing parts (e.g., knobs, dials, terminals, etc.).

D.2.2 Contextual Inspection

Test Item	Acceptance Criteria
The enclosure and accessories	No unusual noises (e.g., a rattle inside the case).
	No unusual smells (e.g., burning or smoky smells, particularly from ventilation holes).
	No taped notes that may suggest device deficiencies or operator concerns.

D.3 Device Labeling

Check the labels provided by the manufacturer or the healthcare facility are present and legible.

- Main unit label
- Integrated warning labels

D.4 Protective Earth Resistance

- Plug the probes of the analyzer into the device's protective earth terminal and protective earth terminal of the AC power cord.
- Test the earth resistance with a current of 25 A.
- Verify the resistance is less than limits.

■ LIMITS

ALL COUNTRIES R = 0.2 Ω Maximum

D.5 Earth Leakage Test

Run an Earth Leakage test on the device being tested before performing any other leakage tests.

The following outlet conditions apply when performing the Earth Leakage test.

- normal polarity(Normal Condition);
- reverse polarity(Normal Condition);
- normal polarity with open neutral(Single Fault Condition);
- reverse polarity with open neutral(Single Fault Condition).

■ LIMITS

For UL60601-1,

- 300 μ A in Normal Condition.
- 1000 μ A in Single Fault Condition.

For IEC60601-1,

- 500 μ A in Normal Condition.
- 1000 μ A in Single Fault Condition.

D.6 Enclosure Leakage Test

The following outlet conditions apply when performing the Enclosure Leakage test.

- normal polarity(Normal Condition);
- reverse polarity(Normal Condition);
- normal polarity with open neutral(Single Fault Condition);
- reverse polarity with open neutral(Single Fault Condition);
- normal polarity with open earth(Single Fault Condition);
- reverse polarity with open earth(Single Fault Condition).

■ LIMITS

For UL60601-1,

- 100 μ A in Normal Condition.
- 300 μ A in Single Fault Condition.

For IEC60601-1:

- 100 μ A in Normal Condition.
- 500 μ A in Single Fault Condition.

D.7 Patient Leakage Current

Patient leakage currents are measured between a selected applied part and mains earth. All measurements have a true RMS only.

The following outlet conditions apply when performing the Patient Leakage Current test.

- normal polarity(Normal Condition);
- reverse polarity(Normal Condition),
- normal polarity with open neutral(Single Fault Condition);
- reverse polarity with open neutral(Single Fault Condition).
- normal polarity with open earth(Single Fault Condition);
- reverse polarity with open earth(Single Fault Condition).

■ LIMITS

For BF  applied parts,

- 100 μ A in Normal Condition.
- 500 μ A in Single Fault Condition.

D.8 Mains on Applied Part Leakage

The Mains on Applied Part test applies a test voltage, which is 110% of the mains voltage, through a limiting resistance, to selected applied part terminals. Current measurements are then taken between the selected applied part and earth. Measurements are taken with the test voltage (110% of mains) to applied parts in the normal and reverse polarity conditions.

The following outlet conditions apply when performing the Mains on Applied Part test.

- Normal Polarity;
- Reversed Polarity.

■ LIMITS

- For BF  applied parts: 5000 μ A.

D.9 Patient Auxiliary Current

Patient Auxiliary currents are measured between any selected Applied Part connector and the remaining Applied Part connectors. All measurements may have a true RMS only response.

The following outlet conditions apply when performing the Patient Auxiliary Current test.

- normal polarity(Normal Condition);
- reverse polarity(Normal Condition);
- normal polarity with open neutral(Single Fault Condition);
- reverse polarity with open neutral(Single Fault Condition);
- normal polarity with open earth(Single Fault Condition);
- reverse polarity with open earth(Single Fault Condition).

■ LIMITS

For BF  applied parts,

- 100 μ A in Normal Condition.
- 500 μ A in Single Fault Condition.

Note: Make sure the safety analyzer is authorized comply with requirement of IEC61010-1.
Follow the instructions of the analyzer manufacturer.

