

iMEC8 Vet

Portable Multi-Parameter Veterinary

Monitor

Operator's Manual



© Copyright 2015-2019 Shenzhen Mindray Bio-Medical Electronics Co., Ltd. All rights reserved.

- Release date: 2019-01
- Revision: 3.0

Intellectual Property Statement

SHENZHEN MINDRAY BIO-MEDICAL ELECTRONICS CO., LTD. (hereinafter called Mindray) owns the intellectual property rights to this Mindray product and this manual. This manual may refer to information protected by copyrights or patents and does not convey any license under the patent rights of Mindray, nor the rights of others.

Mindray intends to maintain the contents of this manual as confidential information. Disclosure of the information in this manual in any manner whatsoever without the written permission of Mindray is strictly forbidden.

Release, amendment, reproduction, distribution, rental, adaption and translation of this manual in any manner whatsoever without the written permission of Mindray is strictly forbidden.

mindray ,  **MINDRAY** are the registered trademarks or trademarks owned by Mindray in China and other countries. All other trademarks that appear in this manual are used only for editorial purposes without the intention of improperly using them. They are the property of their respective owners.

This posting serves as notice under 35 U.S.C.§287(a) for Mindray patents: <http://www.mindrayna.com/patents>.

Manufacturer's Responsibility

Contents of this manual are subject to changes without prior notice.

All information contained in this manual is believed to be correct. Mindray shall not be liable for errors contained herein nor for incidental or consequential damages in connection with the furnishing, performance, or use of this manual.

Mindray is responsible for the effects on safety, reliability and performance of this product, only if:

- all installation operations, expansions, changes, modifications and repairs of this product are conducted by Mindray authorized personnel;
- the electrical installation of the relevant room complies with the applicable national and local requirements;
- the product is used in accordance with the instructions for use.



WARNING

-
- **This equipment must be operated by skilled/trained clinical professionals.**
 - **It is important for the hospital or organization that employs this equipment to carry out a reasonable service/maintenance plan. Neglect of this may result in machine breakdown or personal injury.**
-

Service

Mindray maintains a network of service representatives and factory-trained distributors. Prior to requesting service, perform a complete operational check of the instrument to verify proper control settings. If operational problems continue to exist, contact the Service Department at (800) 288-2121, ext: 8116 for Technical Support or (201) 995-8000 for assistance in determining the nearest field service location.

Please include the instrument model number, the serial number, and a description of the problem with all requests for service.

Any questions regarding the warranty should be directed to your local sales or service representative.

NOTE

-
- **Upon request, Mindray provides circuit diagrams, component part lists, descriptions, calibration instructions, or other information which assist the user's appropriately qualified technical personnel to repair those parts of the equipment which are designated by Mindray DS USA, Inc. as repairable.**
-

Company Contact

Manufacturer: Shenzhen Mindray Bio-Medical Electronics Co., Ltd.
Address: Mindray Building, Keji 12th Road South, Hi-tech industrial park,
Nanshan,Shenzhen 518057,P.R.China
Website: www.mindray.com
E-mail Address: service@mindray.com
Tel: +86 755 81888998
Fax: +86 755 26582680

Distributor: Mindray DS USA, Inc.
Address: 800 MacArthur Boulevard, Mahwah, New Jersey, 07430 USA
Tel: 1.800.288.2121, 1.201.995.8000
Website: www.mindray.com

Preface

Manual Purpose

This manual contains the instructions necessary to operate the product safely and in accordance with its function and intended use. Observance of this manual is a prerequisite for proper product performance and correct operation and ensures patient and operator safety.

This manual is based on the maximum configuration and therefore some contents may not apply to your product. If you have any question, please contact Mindray.

This manual is an integral part of the product. It should always be kept close to the equipment so that it can be obtained conveniently when needed.

Intended Audience

This manual is geared for clinical professionals who are expected to have a working knowledge of medical procedures, practices and terminology as required for monitoring of critically ill patients.

Illustrations

All illustrations in this manual serve as examples only. They may not necessarily reflect the setup or data displayed on your monitor.

Conventions

- ***Italic text*** is used in this manual to quote the referenced chapters or sections.
- [] is used to enclose screen texts.
- → is used to indicate operational procedures.

Contents

- 1 Safety.....1-1**
 - 1.1 Safety Information..... 1-1
 - 1.1.1 Dangers 1-2
 - 1.1.2 Warnings 1-2
 - 1.1.3 Cautions 1-3
 - 1.1.4 Notes 1-3
 - 1.2 Equipment Symbols..... 1-3

- 2 The Basics2-1**
 - 2.1 Monitor Description..... 2-1
 - 2.1.1 Intended Use 2-1
 - 2.2 Front View 2-1
 - 2.3 Side View 2-3
 - 2.4 Rear View 2-4
 - 2.5 Display Screen 2-5
 - 2.6 QuickKeys..... 2-7

- 3 Basic Operations3-1**
 - 3.1 Installation 3-1
 - 3.1.1 Unpacking and Checking 3-1
 - 3.1.2 Environmental Requirements 3-2
 - 3.2 Getting Started..... 3-2
 - 3.2.1 Turning Power On 3-2
 - 3.2.2 Starting Monitoring..... 3-3
 - 3.3 Turning the Monitor Off..... 3-3
 - 3.4 Using Keys..... 3-3
 - 3.5 Using the Touchscreen..... 3-3
 - 3.6 Setting the Screen 3-4
 - 3.7 Using the On-screen Keyboard 3-5
 - 3.8 Using the Timer 3-5
 - 3.9 Using the Main Menu 3-6
 - 3.10 Changing General Settings 3-6
 - 3.10.1 Setting up a Monitor..... 3-6
 - 3.10.2 Changing Language 3-7
 - 3.10.3 Adjusting the Screen Brightness..... 3-7
 - 3.10.4 Showing/Hiding Online Help Information..... 3-7
 - 3.10.5 Setting the Date and Time 3-7
 - 3.10.6 Adjusting Volume 3-7
 - 3.11 Setting Parameters 3-8
 - 3.11.1 Switching the Parameters On/Off..... 3-8
 - 3.11.2 Accessing the Parameters Menu..... 3-8
 - 3.12 Operating Modes 3-9

3.12.1 Monitoring Mode	3-9
3.12.2 Night Mode	3-9
3.12.3 Privacy Mode	3-9
3.12.4 Demo Mode	3-10
3.12.5 Standby Mode.....	3-10
4 Managing Patients.....	4-1
4.1 Admitting a Patient	4-1
4.2 Quick Admitting a Patient	4-2
4.3 Querying and Obtaining Patient Information.....	4-2
4.4 Associating Patient Information	4-3
4.5 Editing Patient Information.....	4-3
4.6 Discharging a Patient.....	4-3
4.7 Transferring a Patient.....	4-4
4.7.1 Transferring Data from the Monitor to a USB Drive	4-4
4.7.2 Transferring Data from a USB Drive to the Monitor	4-5
4.8 Connecting to a Central Monitoring System.....	4-6
5 Managing Configurations	5-1
5.1 Introduction.....	5-1
5.2 Entering the [Manage Configuration] Menu	5-1
5.3 Setting Default Configuration.....	5-2
5.4 Saving Current Settings	5-2
5.5 Editing a Configuration	5-2
5.6 Deleting a Configuration	5-3
5.7 Transferring a Configuration.....	5-3
5.8 Loading a Configuration	5-3
5.9 Restoring the Latest Configuration Automatically	5-4
5.10 Modifying Password	5-4
6 User Screens	6-1
6.1 Tailoring Your Screens.....	6-1
6.1.1 Changing the Wave Line Size.....	6-1
6.1.2 Changing Measurement Colors	6-1
6.1.3 Changing Screen Layout	6-1
6.2 Viewing Minitrends.....	6-1
6.2.1 Having a Split-Screen View of Minitrends.....	6-1
6.2.2 Setting Minitrends.....	6-2
6.3 Viewing OxyCRG.....	6-2
6.4 Viewing Other Patients.....	6-3
6.4.1 Care Group.....	6-3
6.4.2 Viewing the Care Group Overview Bar.....	6-4
6.4.3 Understanding the [View Other Patient] Window	6-4
6.5 Understanding the Big Numerics Screen	6-5
7 Alarms	7-1

7.1 Alarm Categories	7-1
7.2 Alarm Levels	7-2
7.3 Alarm Indicators.....	7-2
7.3.1 Alarm Lamp.....	7-2
7.3.2 Alarm Message.....	7-2
7.3.3 Flashing Numeric	7-3
7.3.4 Audible Alarm Tones	7-3
7.3.5 Alarm Status Symbols.....	7-3
7.4 Alarm Tone Configuration.....	7-4
7.4.1 Setting the Minimum Alarm Volume	7-4
7.4.2 Changing the Alarm Volume	7-4
7.4.3 Setting the Interval between Alarm Sounds	7-4
7.4.4 Changing the Alarm Tone Pattern.....	7-5
7.4.5 Setting the Reminder Tones.....	7-5
7.5 Understanding the Alarm Setup Menu.....	7-5
7.5.1 Setting Alarm Properties for All Parameters	7-6
7.5.2 Adjusting Alarm Limits Automatically	7-6
7.5.3 Setting Alarm Delay Time	7-8
7.5.4 Setting SpO ₂ Technical Alarm Delay	7-8
7.5.5 Setting Recording Length	7-8
7.5.6 Intubation Mode	7-8
7.6 Pausing Alarms	7-9
7.7 Switching Off All Alarms.....	7-9
7.8 Silencing the Alarm Sound	7-10
7.9 Latching Alarms	7-10
7.10 Silencing Technical Alarms	7-10
7.11 Testing Alarms.....	7-11
7.12 When an Alarm Occurs	7-11
7.13 Using Care Group Alarms.....	7-11
7.13.1 Care Group Auto Alarms.....	7-11
7.13.2 Setting Care Group Alert Tone.....	7-12
7.13.3 Silencing Care Group Alarms	7-12
8 Monitoring ECG.....	8-1
8.1 Introduction	8-1
8.2 Safety.....	8-1
8.3 Preparing to Monitor ECG	8-1
8.3.1 Preparing the Patient and Placing the Electrodes	8-1
8.3.2 Choosing AHA or IEC Lead Placement.....	8-2
8.3.3 ECG Lead Placements	8-2
8.3.4 Checking Paced Status	8-4
8.4 Understanding the ECG Display.....	8-5
8.5 Changing ECG Settings.....	8-5
8.5.1 Accessing ECG Menus.....	8-5
8.5.2 Choosing the Alarm Source	8-5
8.5.3 Setting the ECG Lead Set.....	8-6

8.5.4	Choosing an ECG Display Screen.....	8-6
8.5.5	Changing the ECG Filter Settings	8-6
8.5.6	Setting the Notch Filter.....	8-7
8.5.7	Changing the Pacer Reject Settings.....	8-7
8.5.8	Changing ECG Wave Settings	8-7
8.5.9	Enabling Smart Lead Off	8-8
8.5.10	Setting the Alarm Level for ECG Lead Off Alarms.....	8-8
8.5.11	Adjusting QRS Volume.....	8-8
8.5.12	About the Defibrillator Synchronization.....	8-8
8.6	About ST Monitoring	8-8
8.6.1	Switching ST On and Off	8-9
8.6.2	Changing ST Filter Settings	8-9
8.6.3	Understanding the ST Display	8-9
8.6.4	Saving the Current ST Segment as Reference.....	8-10
8.6.5	Changing the Reference Segment	8-10
8.6.6	Deleting a Reference Segment.....	8-10
8.6.7	Recording the ST Segment	8-10
8.6.8	Changing the ST Alarm Limits	8-10
8.6.9	Setting the ST Alarm Delay Time	8-10
8.6.10	Adjusting ST Measurement Points.....	8-11
8.7	About Arrhythmia Monitoring	8-12
8.7.1	Understanding the Arrhythmia Events.....	8-12
8.7.2	Changing Arrhythmia Alarm Settings.....	8-13
8.7.3	Changing Arrhythmia Threshold Settings	8-13
8.7.4	Setting the Extended Arrhythmia	8-13
8.7.5	Reviewing Arrhythmia Events	8-14
8.8	ECG Relearning	8-14
8.8.1	Initiating an ECG Relearning Manually	8-14
8.8.2	Automatic ECG Relearning	8-14
9	Monitoring Respiration (Resp)	9-1
9.1	Introduction.....	9-1
9.2	Safety Information	9-1
9.3	Understanding the Resp Display	9-1
9.4	Placing Resp Electrodes	9-2
9.4.1	Optimizing Lead Placement for Resp	9-2
9.4.2	Cardiac Overlay	9-2
9.4.3	Abdominal Breathing	9-2
9.4.4	Lateral Chest Expansion	9-3
9.5	Choosing the Respiration Lead.....	9-3
9.6	Changing the Apnea Alarm Delay	9-3
9.7	Changing Resp Detection Mode	9-3
9.8	Changing Resp Wave Settings	9-4
9.9	Setting RR Source.....	9-4
9.10	Setting alarm properties	9-4
9.11	Switching Resp Measurement On/Off.....	9-4

10 Monitoring PR	10-1
10.1 Introduction.....	10-1
10.2 Setting the PR Source.....	10-1
10.3 Selecting the Active Alarm Source.....	10-2
10.4 QRS Tone.....	10-2
11 Monitoring SpO₂	11-1
11.1 Introduction.....	11-1
11.2 Safety.....	11-2
11.3 Identifying SpO ₂ Modules.....	11-2
11.4 Applying the Sensor.....	11-3
11.5 Changing SpO ₂ Settings.....	11-3
11.5.1 Accessing SpO ₂ Menus.....	11-3
11.5.2 Adjusting the Desat Alarm.....	11-3
11.5.3 Setting SpO ₂ Sensitivity.....	11-4
11.5.4 Changing Averaging Time.....	11-4
11.5.5 Monitoring SpO ₂ and NIBP Simultaneously.....	11-4
11.5.6 Sat-Seconds Alarm Management.....	11-4
11.5.7 Changing the Speed of the Pleth Wave.....	11-5
11.5.8 Setting the Alarm Level for SpO ₂ Sensor Off Alarm.....	11-5
11.5.9 Setting the SpO ₂ Tone Mode.....	11-6
11.6 Measurement Limitations.....	11-6
11.7 Masimo Information.....	11-6
11.8 Nellcor Information.....	11-7
12 Monitoring NIBP	12-1
12.1 Introduction.....	12-1
12.2 Safety.....	12-2
12.3 Measurement Limitations.....	12-2
12.4 Measurement Methods.....	12-2
12.5 Setting Up the NIBP Measurement.....	12-3
12.5.1 Preparing to Measure NIBP.....	12-3
12.5.2 Starting and Stopping Measurements.....	12-4
12.5.3 Correcting the Measurement if Limb is not at Heart Level.....	12-4
12.5.4 Enabling NIBP Auto Cycling and Setting the Interval.....	12-4
12.5.5 Starting a STAT Measurement.....	12-5
12.6 Understanding the NIBP Numerics.....	12-5
12.7 Changing NIBP Settings.....	12-6
12.7.1 Setting the Initial Cuff Inflation Pressure.....	12-6
12.7.2 Setting NIBP Alarm Properties.....	12-6
12.7.3 Displaying NIBP List.....	12-6
12.7.4 Setting the Pressure Unit.....	12-6
12.7.5 Switching On NIBP End Tone.....	12-6
12.8 Assisting Venous Puncture.....	12-6
13 Monitoring Temp	13-1

13.1 Introduction	13-1
13.2 Safety	13-1
13.3 Making a Temp Measurement	13-1
13.4 Understanding the Temp Display	13-2
13.5 Setting the Temperature Unit	13-2
14 Monitoring IBP.....	14-1
14.1 Introduction	14-1
14.2 Safety	14-1
14.3 Zeroing the Transducer.....	14-1
14.4 Setting Up the Pressure Measurement	14-2
14.5 Understanding the IBP Display.....	14-3
14.6 Changing IBP Settings.....	14-4
14.6.1 Changing a Pressure for Monitoring	14-4
14.6.2 Setting the Pressure Label Order.....	14-4
14.6.3 Setting Alarm Properties.....	14-4
14.6.4 Changing Averaging Time.....	14-4
14.6.5 Setting Up the IBP Wave	14-5
14.6.6 Enabling PPV Measurement and Setting PPV Source.....	14-5
14.6.7 Setting the Pressure Unit	14-5
14.7 Overlapping IBP Waveforms.....	14-6
14.8 Measuring PAWP	14-7
14.8.1 Preparing to Measure PAWP	14-7
14.8.2 Setting Up the PAWP Measurement.....	14-7
14.8.3 Understanding the PAWP Setup Menu	14-8
15 Monitoring Carbon Dioxide (CO₂)	15-1
15.1 Introduction	15-1
15.2 Measuring CO ₂	15-2
15.2.1 Making a Sidestream CO ₂ Measurement	15-2
15.2.2 Making a Microstream CO ₂ Measurement.....	15-3
15.3 Changing CO ₂ Settings.....	15-3
15.3.1 Accessing CO ₂ Menus.....	15-3
15.3.2 Entering the Standby Mode.....	15-3
15.3.3 Setting the CO ₂ Unit	15-4
15.3.4 Setting up Gas Compensations	15-4
15.3.5 Setting up Humidity Compensation	15-4
15.3.6 Setting the Apnea Alarm Delay	15-5
15.3.7 Choosing a Time Interval for Peak-Picking	15-5
15.3.8 Setting the Flow Rate.....	15-5
15.3.9 Setting up the CO ₂ Wave.....	15-5
15.4 Setting RR Source	15-6
15.5 Setting Barometric Pressure Compensation	15-6
15.6 Measurement Limitations	15-6
15.7 Leakage Test	15-6
15.8 Troubleshooting the Sidestream CO ₂ Sampling System	15-7

15.9 Removing Exhaust Gases from the System	15-7
15.10 Zeroing the Sensor	15-7
15.10.1 For Sidestream and Microstream CO ₂ Modules	15-7
15.11 Calibrating the Sensor	15-7
15.12 Oridion Information	15-8
16 Freezing Waveforms	16-1
16.1 Freezing Waveforms	16-1
16.2 Viewing Frozen Waveforms	16-1
16.3 Unfreezing Waveforms	16-1
16.4 Recording Frozen Waveforms.....	16-2
17 Review	17-1
17.1 Accessing Respective Review Windows	17-1
17.2 Reviewing Graphic Trends	17-1
17.3 Reviewing Tabular Trends	17-2
17.4 Events.....	17-2
17.4.1 Marking Events.....	17-2
17.4.2 Reviewing Events.....	17-3
17.5 Reviewing Waveforms.....	17-4
18 Calculations.....	18-1
18.1 Introduction.....	18-1
18.2 Dose Calculations.....	18-1
18.2.1 Performing Calculations	18-1
18.2.2 Selecting the Proper Drug Unit	18-2
18.2.3 Titration Table	18-2
18.2.4 Drug Calculation Formulas	18-3
18.3 Oxygenation Calculations	18-3
18.3.1 Performing Calculations	18-3
18.3.2 Entered Parameters.....	18-3
18.3.3 Calculated Parameters and Formulas.....	18-4
18.4 Ventilation Calculations.....	18-4
18.4.1 Performing Calculations	18-4
18.4.2 Entered Parameters.....	18-5
18.4.3 Calculated Parameters and Formulas.....	18-5
18.5 Hemodynamic Calculations.....	18-5
18.5.1 Performing Calculations	18-5
18.5.2 Entered Parameters.....	18-6
18.5.3 Calculated Parameters and Formulas.....	18-6
18.6 Renal Calculations.....	18-7
18.6.1 Performing Calculations	18-7
18.6.2 Entered Parameters.....	18-7
18.6.3 Calculated Parameters and Formulas.....	18-8
18.7 Understanding the Review Window	18-8

19 Recording	19-1
19.1 Using a Recorder.....	19-1
19.2 Overview of Recording Types	19-1
19.3 Starting and Stopping Recordings.....	19-2
19.4 Setting up the Recorder.....	19-2
19.4.1 Accessing the Record Setup Menu	19-2
19.4.2 Selecting Waveforms for Recording	19-2
19.4.3 Setting the Realtime Recording Length.....	19-2
19.4.4 Setting the Interval between Timed Recordings.....	19-3
19.4.5 Changing the Recording Speed	19-3
19.4.6 Clearing Recording Tasks	19-3
19.5 Loading Paper.....	19-3
19.6 Removing Paper Jam.....	19-4
19.7 Cleaning the Recorder Printhead	19-4
20 Other Functions	20-1
20.1 Analog Output.....	20-1
20.2 Exporting the Log.....	20-1
20.3 Transferring Data.....	20-1
20.3.1 Data Export System	20-1
20.3.2 Transferring Data by Different Means	20-2
20.4 Nurse Call	20-2
20.5 Network Connection	20-3
20.5.1 Setting the Network Type.....	20-3
20.5.2 Wireless Network.....	20-3
20.5.3 Setting the IP Address, Subnet Mask and Gateway.....	20-4
21 Batteries	21-1
21.1 Overview	21-1
21.2 Replacing a Battery	21-1
21.3 Battery Guidelines.....	21-2
21.4 Battery Maintenance	21-2
21.5 Battery Recycling.....	21-3
22 Care and Cleaning	22-1
22.1 General Points.....	22-1
22.2 Cleaning.....	22-1
22.3 Disinfecting	22-2
23 Maintenance	23-1
23.1 Regular Inspection	23-1
23.2 Maintenance and Testing Schedule.....	23-2
23.3 Checking Monitor and Module Information	23-3
23.4 ECG Verification	23-3
23.5 NIBP Leakage Test	23-3
23.6 NIBP Accuracy Test	23-3

23.7 CO ₂ Test.....	23-3
23.8 Calibrating the Touchscreen	23-4
23.9 Electrical Safety Tests	23-4
24 Accessories.....	24-1
24.1 ECG Accessories.....	24-1
24.2 SpO ₂ Accessories	24-2
24.3 NIBP Accessories.....	24-3
24.4 Temp Accessories	24-3
24.5 IBP/ICP Accessories.....	24-4
24.6 CO ₂ Accessories.....	24-5
24.7 Others	24-6
A Product Specifications	A-1
A.1 Monitor Safety Specifications.....	A-1
A.2 Power Supply Specifications.....	A-2
A.3 Physical Specifications.....	A-2
A.4 Hardware Specifications	A-3
A.5 Data Storage	A-4
A.6 Wireless Network.....	A-5
A.7 Measurement Specifications	A-5
B EMC and Radio Regulatory Compliance	B-1
B.1 EMC.....	B-1
B.2 Radio Regulatory Compliance	B-4
C Default Configurations.....	C-1
C.1 Parameters Configuration.....	C-1
C.2 Routine Configuration	C-7
C.3 User Maintenance Items.....	C-9
D Alarm Messages.....	D-1
D.1 Physiological Alarm Messages	D-1
D.2 Technical Alarm Messages.....	D-2
E Electrical Safety Inspection	E-1
E.1 Power Cord Plug.....	E-1
E.2 Device Enclosure and Accessories.....	E-1
E.3 Device Labelling.....	E-2
E.4 Protective Earth Resistance	E-2
E.5 Earth Leakage Test.....	E-2
E.6 Patient Leakage Current	E-3
E.7 Mains on Applied Part Leakage.....	E-3
E.8 Patient Auxiliary Current.....	E-4
F Symbols and Abbreviations	F-1

F.1 Symbols F-1
F.2 Abbreviations..... F-2

1 Safety

1.1 Safety Information

DANGER

- Indicates an imminent hazard that, if not avoided, will result in death or serious injury.
-
-

WARNING

- Indicates a potential hazard or unsafe practice that, if not avoided, could result in death or serious injury.
-
-

CAUTION

- Indicates a potential hazard or unsafe practice that, if not avoided, could result in minor personal injury or product/property damage.
-
-

NOTE

- Provides application tips or other useful information to ensure that you get the most from your product.
-
-

1.1.1 Dangers

There are no dangers that refer to the product in general. Specific “Danger” statements may be given in the respective sections of this manual.

1.1.2 Warnings



WARNING

- **The device is intended for animal monitoring by trained personnel in the specified places.**
 - **This equipment is used for one patient at a time.**
 - **Before putting the system into operation, the operator must verify that the equipment, connecting cables and accessories are in correct working order and operating condition.**
 - **The equipment must be connected to a properly installed power outlet with protective earth contacts only. If the installation does not provide for a protective earth conductor, disconnect it from the power line and operate it on battery power, if possible.**
 - **To avoid explosion hazard, do not use the equipment in the presence of oxygen-rich atmospheres, flammable anesthetics, or other flammable agents (such as gasoline).**
 - **Do not open the equipment housings. All servicing and future upgrades must be carried out by the personnel trained and authorized by our company only.**
 - **Do not come into contact with patients during defibrillation, otherwise serious injury or death could result.**
 - **Do not touch the equipment’s metal parts or connectors when in contact with the patient, otherwise patient injury may result.**
 - **Before connecting the equipment to the power line, check that the voltage and frequency ratings of the power line are the same as those indicated on the equipment’s label or in this manual.**
 - **Do not rely exclusively on the audible alarm system for monitoring. Adjustment of alarm volume to a low level or off may result in a hazard to the patient. Remember that alarm settings should be customized according to different patient situations and always keeping the patient under close surveillance is the most reliable way for safe monitoring.**
 - **The physiological data and alarm messages displayed on the equipment should be reviewed by a clinician before being used for diagnostic interpretation and treatment.**
 - **To avoid inadvertent disconnection, route all cables in a way to prevent a stumbling hazard. Wrap and secure excess cabling to reduce risk of entanglement or strangulation by patients or personnel.**
 - **Ensure that the monitor is supplied with continuous electric power during work. Sudden power failure may lead to the loss of patient data.**
 - **Never mix patient electrode types or brands. Dissimilar metals or other incompatibilities may cause considerable baseline drift and may increase trace recovery time after defibrillation.**
-

1.1.3 Cautions



CAUTION

- To ensure patient safety, use only parts and accessories specified in this manual.
- At the end of its service life, the equipment, as well as its accessories, must be disposed of in compliance with the guidelines regulating the disposal of such products. If you have any questions concerning disposal of the equipment, please contact Mindray.
- Magnetic and electrical fields are capable of interfering with the proper performance of the equipment. For this reason make sure that all external devices operated in the vicinity of the equipment comply with the relevant EMC requirements. Mobile phones, X-ray equipment or MRI devices are a possible source of interference as they may emit higher levels of electromagnetic radiation.
- Before connecting the equipment to the power line, check that the voltage and frequency ratings of the power line are the same as those indicated on the equipment's label or in this manual.
- Always install or carry the equipment properly to avoid damage caused by drop, impact, strong vibration or other mechanical force.
- Dry the equipment immediately in case of rain or water spray.

1.1.4 Notes

NOTE





















- Put the equipment in a location where you can easily see the screen and access the operating controls.
- Keep this manual in the vicinity of the equipment so that it can be obtained conveniently when needed.
- The software was developed in compliance with IEC 60601-1-4. The possibility of hazards arising from software errors is minimized.
- When disposing of the packaging material, be sure to observe the applicable waste control regulations and keep it out of children's reach.
- This manual describes all features and options. Your equipment may not have all of them.

1.2 Equipment Symbols

NOTE

- Some symbols may not appear on your equipment.

	Caution, consult accompanying documents		
	Power ON/OFF (for a part of the equipment)		Battery indicator
	Alternating current		ALARM PAUSED

	AUDIO PAUSED		Graphical recorder
	Freeze/unfreeze waveforms		Main menu
	NIBP start/stop key		Output
	Equipotentiality		VGA output
	USB connector		Network connector
	Gas outlet		Serial number
	Inserted direction		DATE OF MANUFACTURE
	This mark means that this device is fully in conformance with the Council Directive Concerning Medical Devices 84/539/EEC and 2004/108/EC.		
	AUTHORISED REPRESENTATIVE IN THE EUROPEAN COMMUNITY		
	Electrostatic sensitive devices		
	DEFIBRILLATION-PROOF TYPE CF APPLIED PART		
	DEFIBRILLATION-PROOF TYPE BF APPLIED PART		
	<p>The following definition of the WEEE label applies to EU member states only.</p> <p>This symbol indicates that this product should not be treated as household waste. By ensuring that this product is disposed of correctly, you will help prevent bringing potential negative consequences to the environment and human health. For more detailed information with regard to returning and recycling this product, please consult the distributor from whom you purchased it.</p> <p>* For system products, this label may be attached to the main unit only.</p>		
<p>ETL CLASSIFIED</p>  <p>Intertek 3179617</p>	<p>The presence of this label indicates the machine was certified by ETL with the statement: Conforms to AAMI ES60601-1, IEC60601-1-6, IEC60601-1-8, IEC60601-2-27, IEC80601-2-30, IEC60601-2-34, IEC60601-2-49, ISO80601-2-55, ISO80601-2-56, ISO80601-2-61 Certified to CSA Std C22.2 No. 601.1, No.60601-1-6, No. 60601-1-8, No. 60601-2-27, No. 80601-2-30, No. 60601-2-34, No.60601-2-49, No. 80601-2-55, No. 80601-2-56, No. ISO80601-2-61</p>		

2 The Basics

2.1 Monitor Description

2.1.1 Intended Use

The iMEC8 Vet monitor is intended to be used for monitoring, displaying, reviewing, storing and transferring of multiple physiological parameters including ECG, heart rate (HR), respiration (Resp), temperature (Temp), SpO₂, pulse rate (PR), non-invasive blood pressure (NIBP), invasive blood pressure (IBP), and carbon dioxide (CO₂).

WARNING

- This monitor is intended for use only by clinical professionals or under their guidance. It must only be used by persons who have received adequate training in its use. Anyone unauthorized or untrained must not perform any operation on it.

2.2 Front View

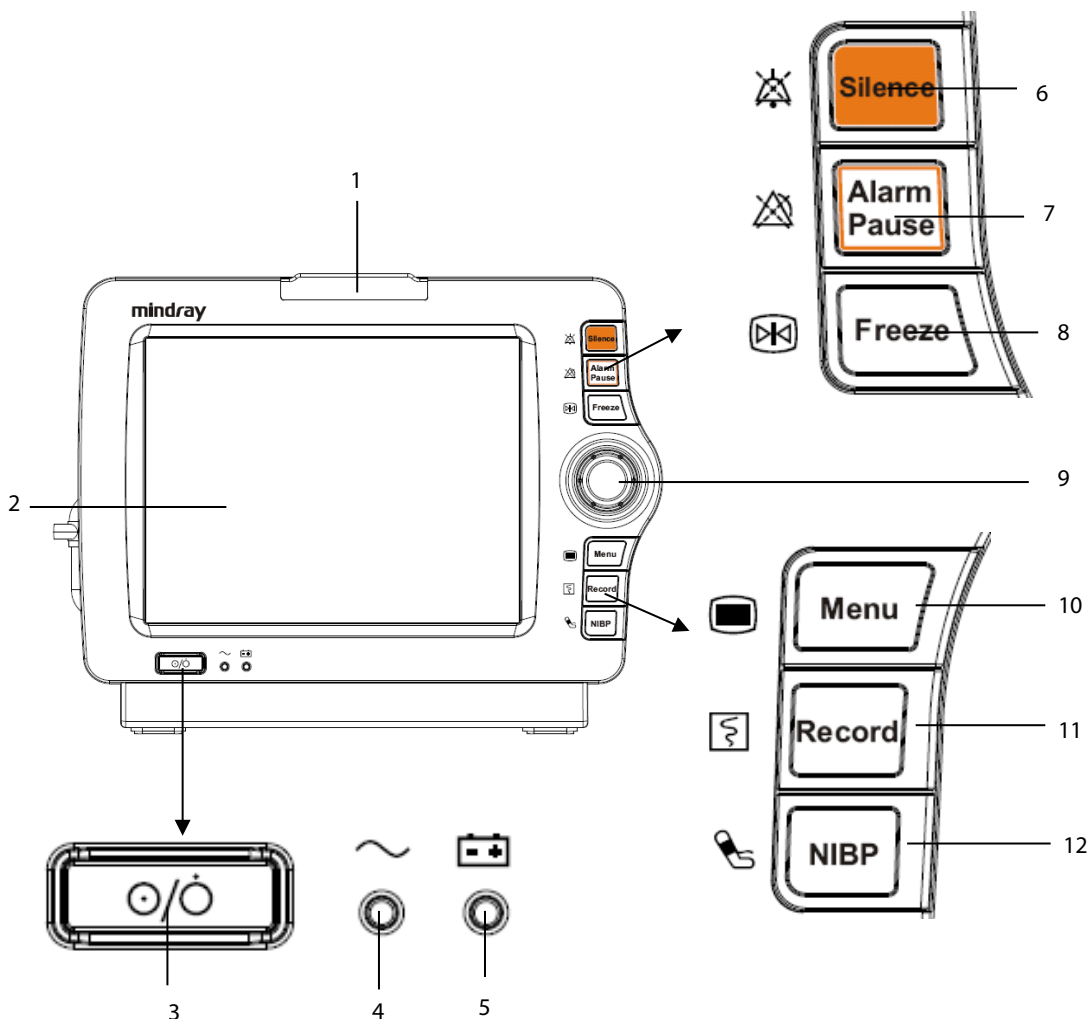

1. Alarm lamp

When a physiological alarm or technical alarm occurs, this lamp will flash as defined below.

- ◆ High level alarms: the lamp quickly flashes red.
- ◆ Medium level alarms: the lamp slowly flashes yellow.
- ◆ Low level alarms: the lamp lights yellow without flashing.

2. Display Screen

3. Power On/Off button

- ◆ Pressing this button turns the monitor on.
- ◆ When the monitor is on, pressing and holding this button turns the monitor off.

An indicator is built in this switch. It turns on when the monitor is on and turns off when the monitor is off.

4. AC power LED

It turns on when AC power is connected.

5. Battery LED

- ◆ On: when the battery is installed and the AC source is connected.
- ◆ Off: when no battery is installed or the installed battery has a malfunction, or no AC source is connected when the monitor is powered off.
- ◆ Flash: when the monitor is operating on battery power.

6.  Press to silence all alarm sounds.

7.  Press to pause or restore alarms.

8.  Press to freeze or unfreeze waveforms.

9. Knob

Rotate the Knob clockwise or counter-clockwise. With each click, the highlight jumps to the neighboring item. When you reach your desired item, press the Knob to select it.

10. 

If no menu is displayed on the screen, pressing it will enter the main menu. If there is a menu displayed on the screen, pressing it will close that menu.

11.  Press to start or stop recordings.

12.  Press to start or stop NIBP measurements.

2.3 Side View

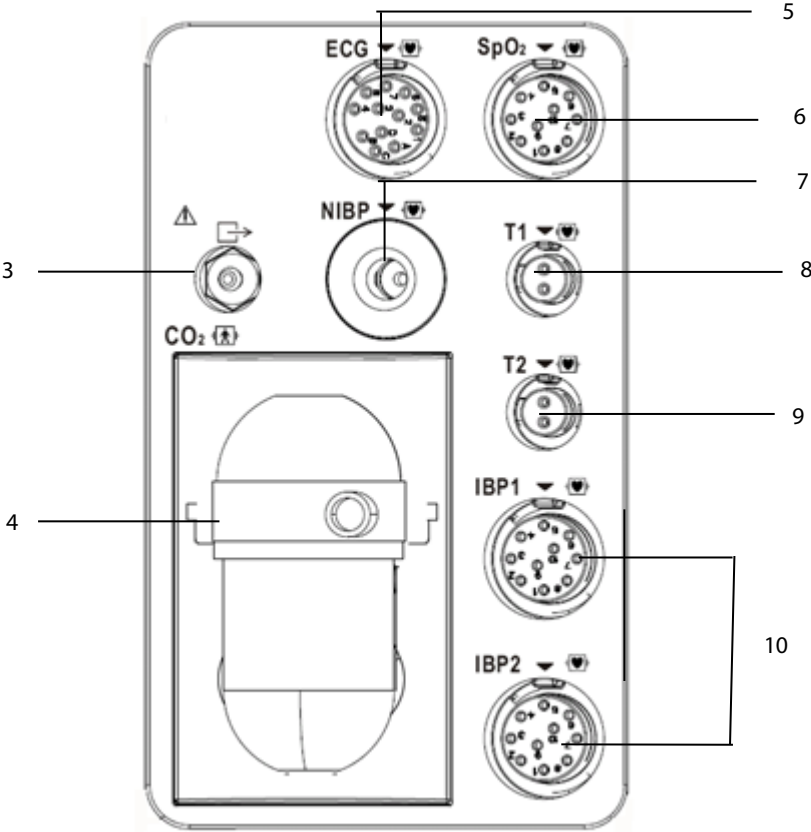
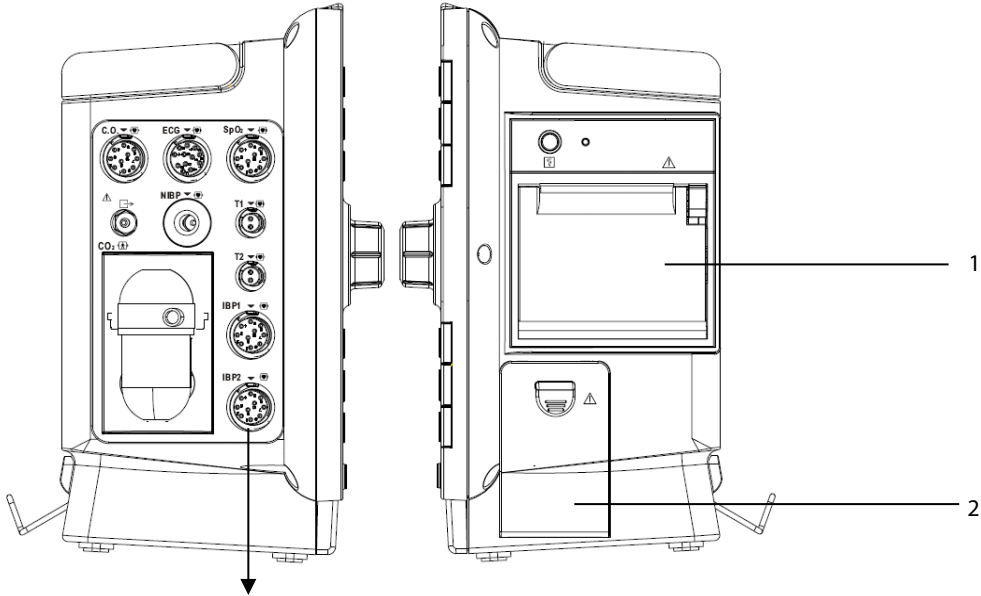

- 1. Recorder
- 2. Battery compartment
- 3. CO₂ gas outlet
- 4. Slot for CO₂ watertrap (sidestream)
- 5. Connector for ECG cable
- 6. Connector for SpO₂ cable
- 7. Connector for NIBP cuff
- 8. Connector for Temp probe 1
- 9. Connector for Temp probe 2
- 10. Connector for IBP cable

2.4 Rear View

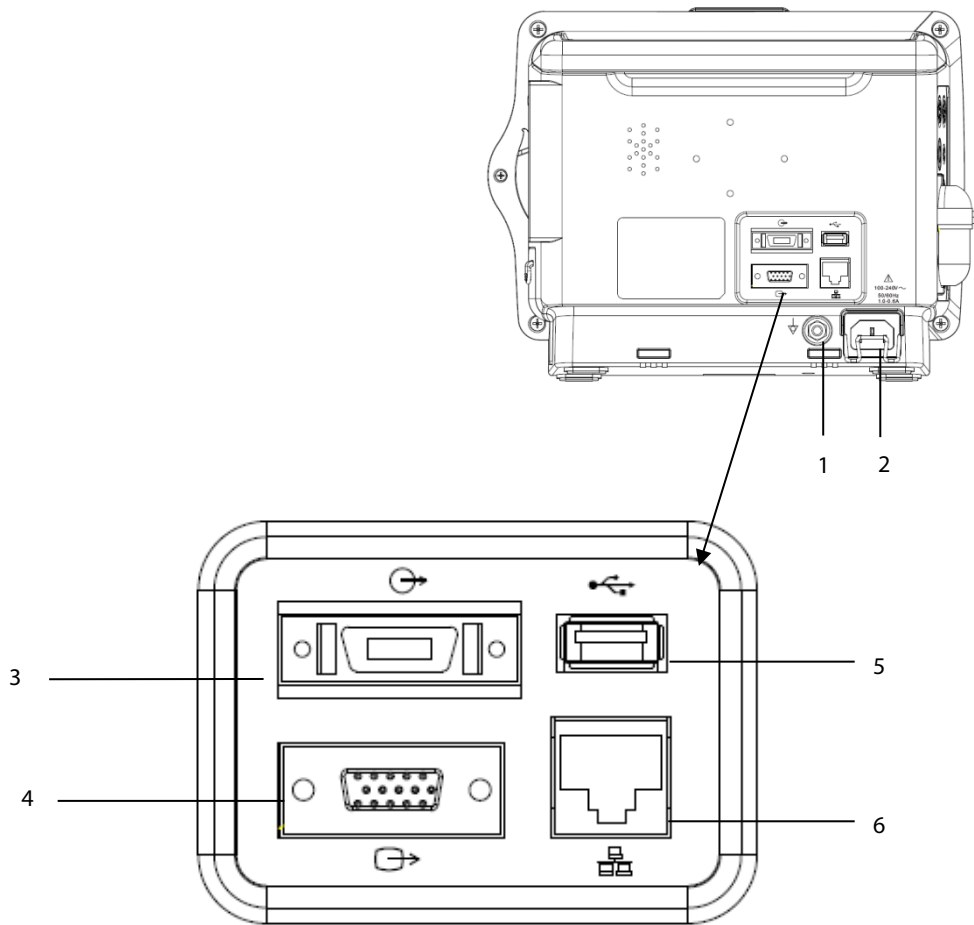

1. Equipotential Grounding Terminal

When the monitor and other devices are to be used together, their equipotential grounding terminals should be connected together, eliminating the potential difference between them.

2. AC Power Input

3. Multifunctional Connector

It outputs defibrillator synchronization signals, nurse call signals and analogy output signals.

4. VGA Connector

It connects a secondary display, which extends the display capability of your monitor. The contents displayed on the secondary display screen accords with those displayed on the monitor screen.

5. USB Connector

It connects a USB drive for data or configuration transfer.

6. Network Connector

It is a standard RJ45 connector which connects the monitor to a CMS or other monitor for remote view. It also connects the monitor to a PC for system upgrade.

2.5 Display Screen

This monitor adopts a high-resolution TFT LCD to display patient parameters and waveforms. A typical display screen is shown below.

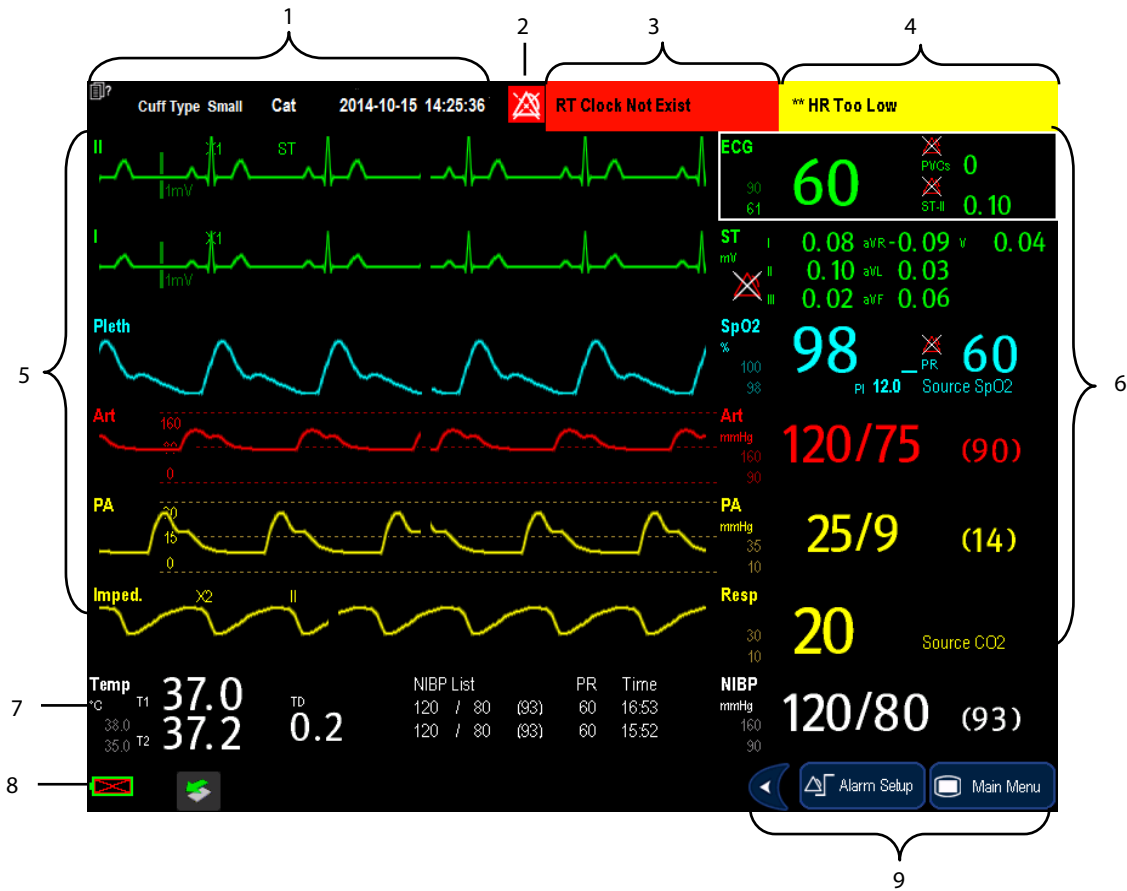

1. Patient Information Area

This area shows the patient information such as bed number, patient name and patient category, indicates that no patient is admitted or the patient information is incomplete. If no patient is admitted, selecting this area will enter the **[Patient Setup]** menu. If a patient has been admitted, selecting this area will enter the **[Patient Demographics]** menu.

2. Alarm Symbols

- ◆ indicates alarms are paused.
- ◆ indicates alarm sounds are paused.
- ◆ indicates alarm sounds are turned off.
- ◆ indicates the system is in alarm off status.

3. Technical Alarm Area

This area shows technical alarm messages and prompt messages. When multiple messages appear, they will be displayed circularly. Select this area and the technical alarm list will be displayed.

4. Physiological Alarm Area

This area shows physiological alarm messages. When multiple alarms occur, they will be displayed circularly. Select this area and the physiological alarm list will be displayed.

5. Waveform Area

This area shows measurement waveforms. The waveform name is displayed at the left upper corner of the waveform. Select this area and the corresponding measurement setup menu will be displayed.

6. Parameter Area A

This area shows measurement parameters. Each monitored parameter has a parameter window and the parameter name is displayed at the upper left corner. The corresponding waveform of each parameter is displayed in the same row in the waveform area. Select this area and the corresponding measurement setup menu will be displayed.

7. Parameter Area B

For the parameters displayed in this area, their corresponding waveforms are not displayed.

8. Prompt Message Area

This area shows the current configuration name, prompt messages, network status icons, battery status icons, date and time, etc. For details about battery status symbols, refer to the chapter **21 Batteries**.



indicates the monitor is connected to a wired network successfully.



indicates the monitor has failed to connect to a wired network.



indicates the wireless function is working.



indicates the wireless function is not working.



indicates a USB drive is inserted.

9. QuickKeys Area

This area contains QuickKeys that give you fast access to functions.

2.6 QuickKeys

A QuickKey is a configurable graphical key, located at the bottom of the main screen. They give you fast access to functions. Their availability and the order in which they appear on your screen depend on how your monitor is configured.

The following QuickKeys can be displayed on the screen:



Scroll left to display more QuickKeys.



Scroll right to display more QuickKeys.



Enter the main menu



Enter standby mode



Change alarm settings



Review the patient's data



Enter the NIBP measurement menu



Stop all NIBP measurement



Zero IBP



Silence all alarm sounds



Pause or restore alarms



Change screen



Enter the patient setup menu



Trigger a manual event



Have a split-screen view of minitrends













Enter the volume setup menu



Default configurations



Start cardiac output procedure

	Perform calculations
	Have a split-screen view of another patient's data
	Have a split-screen view of OxyCRG trends
	Enter the full-screen 7-lead ECG screen
	Enter the [Parameters] menu
	Start NIBP STAT measurement
	Enter the [Unit Setup] menu
	Enter the PAWP measurement screen
	Enter the privacy mode
	Enter the night mode
	Enter the intubation mode

You can also select your desired QuickKeys to display on the screen.

1. Select **[Main Menu]**→**[Maintenance >>]**→**[Manage Configuration >>]**→enter the required password→**[Ok]**.
2. In the **[Manage Configuration]** menu, select **[Edit Config.>>]**.
3. In the pop-up menu, select the desired configuration and then select **[Edit]**.
4. In the pop-up menu, select **[Screen Setup >>]**.
5. In the **[Select QuickKeys]** screen, select your desired QuickKeys and the order of them.

3 Basic Operations

3.1 Installation

WARNING

- **Devices connected to the equipment must meet the requirements of the applicable IEC standards (e.g. IEC 60950 safety standards for information technology equipment and IEC 60601-1 safety standards for medical electrical equipment). The system configuration must meet the requirements of the IEC 60601-1-1 medical electrical systems standard. Any personnel who connect devices to the equipment's signal input/output port are responsible for providing evidence that the safety certification of the devices has been performed in accordance with IEC 60601-1-1. If you have any question, please contact Mindray.**
 - **If it is not evident from the equipment specifications whether a particular combination with other devices is hazardous, for example, due to summation of leakage currents, please consult the manufacturers or else an expert in the field, to ensure the necessary safety of patients and all devices concerned will not be impaired by the proposed combination.**
-

CAUTION

- **The equipment shall be installed by personnel authorized by Mindray.**
-

NOTE

- **The software copyright of the equipment is solely owned by Mindray. No organization or individual shall resort to modifying, copying, or exchanging it or to any other infringement on it in any form or by any means without due permission.**
-

3.1.1 Unpacking and Checking

Before unpacking, examine the packing case carefully for signs of damage. If any damage is detected, contact the carrier or Mindray.

If the packing case is intact, open the package and remove the equipment and accessories carefully. Check all materials against the packing list and check for any mechanical damage. Contact Mindray in case of any problem.

NOTE

- **Save the packing case and packaging material as they can be used if the equipment must be reshipped.**
-



WARNING

- **When disposing of the packaging material, be sure to observe the applicable waste control regulations and keep it out of children's reach.**
 - **Before use, please verify that the packages are intact, especially the packages of single use accessories. In case of any damage, do not apply it to patients.**
-

3.1.2 Environmental Requirements

The operating environment of the equipment must meet the requirements specified in this manual.

The environment where the equipment is used shall be reasonably free from noises, vibration, dust, corrosive, flammable and explosive substances. If the equipment is installed in a cabinet, sufficient space in front and behind shall be left for convenient operation, maintenance and repair. Moreover, to maintain good ventilation, the equipment shall be at least 2 inches (5cm) away from around the cabinet.

When the equipment is moved from one place to another, condensation may occur as a result of temperature or humidity difference. In this case, never start the system before the condensation disappears.



CAUTION

- **Make sure that the operating environment of the equipment meets the specific requirements. Otherwise unexpected consequences, e.g. damage to the equipment, could result.**
 - **Put the equipment in a location where you can easily see the screen, access the operating controls, and disconnect the equipment from AC power.**
-

3.2 Getting Started

3.2.1 Turning Power On

Once the monitor is installed, you can get ready for monitoring:

1. Before you start to make measurements, check the monitor for any mechanical damage and make sure that all external cables, plug-ins and accessories are properly connected.
 2. Plug the power cord into the AC power source. If you run the monitor on battery power, ensure that the battery is sufficiently charged.
 3. Press the power on/off button on the monitor's front.
-



WARNING

- **Do not use the monitor for any monitoring procedure on a patient if you suspect it is not working properly, or if it is mechanically damaged. Contact your service personnel or Mindray.**
-

3.2.2 Starting Monitoring

1. Decide which measurements you want to make.
2. Connect the required patient cables and sensors.
3. Check that the patient cables and sensors are correctly connected.
4. Check that the patient settings such as **[Patient Cat.]**, **[Paced]**, etc, are appropriate for your patient.
5. Refer to the appropriate measurement section for details of how to perform the measurements you require.

3.3 Turning the Monitor Off

To disconnect the monitor from the AC power source, follow this procedure:

1. Confirm that patient monitoring is complete.
2. Disconnect patient cables and sensors from the patient.
3. Make sure to save or clear the monitoring data as required.
4. Press and hold the power on/off button. The monitor shuts down and you can unplug the power cable.



CAUTION

- **Although not recommended, you can press and hold the power on/off button for 10 seconds to forcibly shut down the monitor when it can not be shut down normally or under some special situations. This may cause loss of data of the monitor.**
-

3.4 Using Keys

The monitor has three types of keys:

- **Softkey:** A softkey is a graphic key on the screen, giving you fast access to certain menus or functions. The monitor has two types of softkeys:
 - ◆ **Parameter keys:** Each parameter area or waveform area can be seen as a softkey. You can enter a parameter setup menu by selecting its corresponding parameter area or waveform area.
 - ◆ **QuickKeys:** QuickKeys are configurable graphical keys, located at the bottom of the main screen. For details, refer to the section **QuickKeys**.
- **Hardkeys:** A hardkey is a physical key on a monitoring device, such as the main menu hardkey on the monitor's front.
- **Pop-Up Keys:** Pop-up keys are task-related keys that appear automatically on the monitor screen when required. For example, the confirm pop-up key appears only when you need to confirm a change.

3.5 Using the Touchscreen

Select screen items by pressing them directly on the monitor's screen. You can enable or disable touchscreen

operation by pressing and holding the **[Main Menu]** QuickKey for 3 seconds. A padlock symbol  is displayed if

touchscreen operation is disabled.

3.6 Setting the Screen

You can enter the [Screen Setup] window as shown below by selecting [Main Menu]→[Screen Setup]→[Screen Layout >>]. In this window, you can allocate the positions of the parameters and waveforms. The parameters or waveforms whose positions are not allocated will not be displayed.

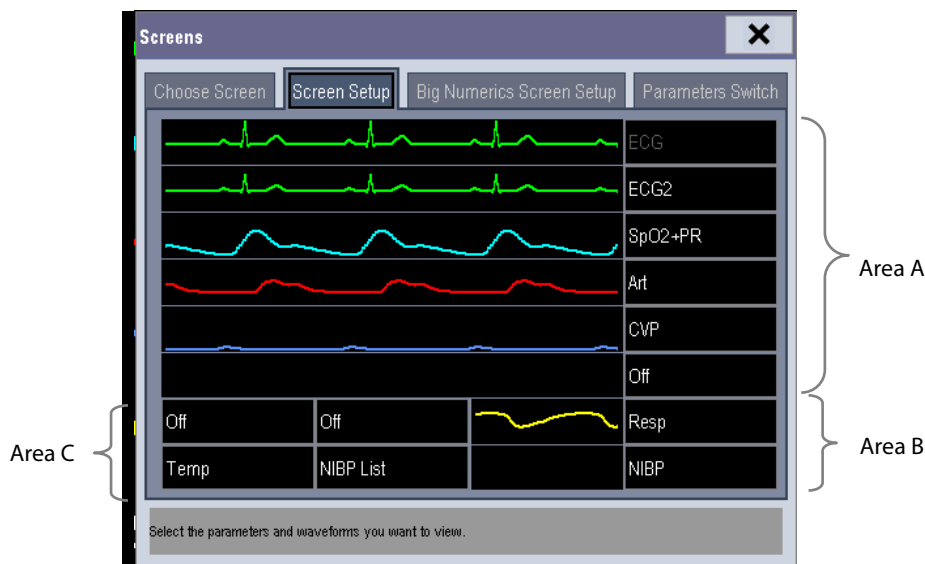

The ECG parameter and the first ECG waveform are always displayed in the first row. The configurable areas can be classified as Area A, Area B, and Area C.

- In Area A, you can choose to display the parameters (having waveforms) and their waveforms. Each parameter and the associated waveform are displayed in the same row.
- In Area B, you can choose to display the parameters and their waveforms. When there is no parameter displayed in area C, both the parameters and their waveforms will be displayed in area B. Otherwise, only the parameters will be displayed.
- In Area C, you can choose to display Timer and all the parameters whose associated waveforms will not be displayed.

The screen can automatically adjust to ensure the best view based on your screen setup.

If no corresponding parameter or waveform is displayed on the monitor screen, you should perform the following inspections:





- Check the connection of the lead, cable, or sensor.
- Enter the [Screen Setup] window for the desired display configuration.
- Check that the parameter is switched on in [Parameters Switch] window.

WARNING

- **The parameters whose positions are not allocated in the [Screen Setup] window will not be displayed. However, the monitor can still give alarms of these parameters.**
-

3.7 Using the On-screen Keyboard

The onscreen keyboard enables you to enter information.

- Use the  key to delete the previously entered character.
- Use the  key to toggle between uppercase and lowercase letters.
- Select the  key to confirm what you have entered and close the onscreen keyboard.
- Select the  to access the symbol keyboard.
- Select the  to exit the symbol keyboard.

3.8 Using the Timer

To display the timer in the main screen, follow this procedure:

1. Select **[Main Menu]**→**[Screen Setup>>]**→**[Screen Layout >>]** to access the **[Screens]** window.
2. Select **[Screen Setup]** tab.
3. In Area C, select **[Timer]** from the drop-down list of the desired parameter area. Refer to **3.6 Setting the Screen** for Area C.
4. Select  to exit the window. The main screen will display the timer.
 - Select **[Start]** or **[Pause]** to start or pause the timing.
 - Select **[Clear]** to clear current timing result.
 - Select **[Setup]** to access the **[Timer Setup]** window, in which you can set the **[Direction]** to **[Up]** or **[Down]**. If you select **[Down]**, you should set:
 - ◆ **[Run Time(h:min:s)]**: The available time range is 0 to 100 hours, and the default time is 5 minutes.
 - ◆ **[Reminder Vol]**: During the last 10 seconds of the countdown, the system issues a reminder tone. The available volume range is 0 to 10. 0 means off, and 10 is the maximum volume.

3.9 Using the Main Menu

To enter the main menu, select the **[Main Menu]** QuickKey or the  hardkey on the monitor's front. Most of the monitor's operations and settings can be performed through the main menu.

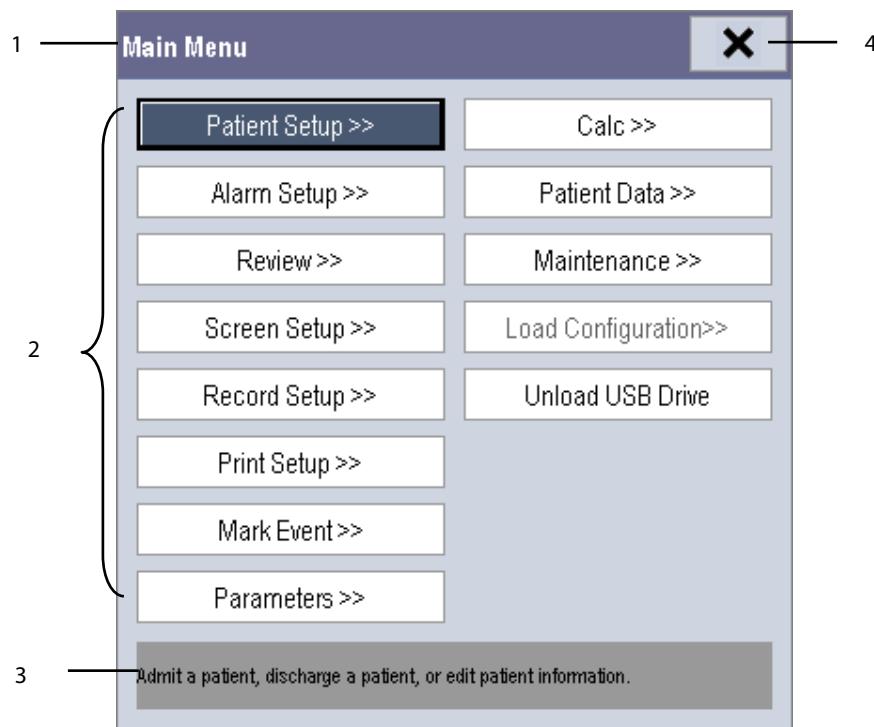

Other menus are similar to the main menu and contain the following parts:

1. Heading: gives a sum-up for the current menu.
2. Main body: displays options, buttons, prompt messages, etc. The menu button with ">>" enlarges a secondary window to reveal more options or information.
3. Online help area: displays help information for the highlighted menu item.
4. : select to exit the current menu.

3.10 Changing General Settings

This chapter covers only general settings such as language, brightness, date and time, etc. Measurement settings and other settings can be referred to in respective sections.

3.10.1 Setting up a Monitor

In situations where you install a monitor or change the monitor's application site, you need to setup the monitor as follows:

1. Select **[Main Menu]** → **[Maintenance >>]** → **[User Maintenance >>]** → enter the required password.
2. In the **[User Maintenance]** menu, select, in turn, **[Monitor Name]**, **[Department]** and **[Bed No.]**, and then change their settings.

3.10.2 Changing Language

1. Select [**Main Menu**]→[**Maintenance >>**]→[**User Maintenance >>**]→enter the required password.
2. In the [**User Maintenance**] menu, select [**Language**] and then select the desired language.
3. Restart the monitor.

3.10.3 Adjusting the Screen Brightness

1. Select the [**Main Menu**]→[**Screen Setup >>**]→[**Brightness**].
2. Select the appropriate setting for the screen brightness. 10 is the brightest, and 1 is the least bright.

If the monitor operates on battery power, using a less bright setting will prolong the battery operating time. When the monitor enters standby mode, the screen will change to the least bright setting automatically.

3.10.4 Showing/Hiding Online Help Information

The monitor provides online help information. The user can display or hide the help as required.

1. Select [**Main Menu**]→[**Screen Setup >>**].
2. Select [**Help**] and toggle between [**On**] and [**Off**].

3.10.5 Setting the Date and Time

1. Select [**Main Menu**] →[**Maintenance >>**]→[**System Time >>**].
2. Set the date and time.
3. Select [**Date Format**] and toggle between [**yyyy-mm-dd**], [**mm-dd-yyyy**] and [**dd-mm-yyyy**].
4. Select [**Time Format**] and toggle between [**24h**] and [**12h**].

If your monitor is connected to a central monitoring system (CMS), the date and time are automatically taken from that CMS. In that case, you cannot change the date and time settings on your monitor.



CAUTION

- If you change the date and time, the display time of stored trends and events will be changed accordingly.
-

3.10.6 Adjusting Volume

Alarm Volume

1. Select the [**Alarm Setup**] QuickKey→[**Others**], or [**Main Menu**]→[**Alarm Setup >>**]→[**Others**].
2. Select [**Alm Volume**] and then select the appropriate volume: X-10, in which X is the minimum volume, depending on the set minimum alarm volume (refer to the **Alarms** chapter), and 10 is the maximum volume.

Key Volume

When you press the navigation knob or the touchscreen, or the hardkeys on the panel, the monitor prompts you by making a sound of the key volume you have set.

1. Select the **[Volume Setup]** QuickKey, or **[Main Menu]**→**[Screen Setup >>]**.
2. Select **[Key Volume]** and then select the appropriate volume. 0 means off, and 10 is the maximum volume.

QRS Volume

The QRS tone is derived from either the HR or PR, depending on which is currently selected as the alarm source in **[ECG Setup]** or **[SpO2 Setup]**. When monitoring SpO₂, there is a variable pitch tone which changes as the patient's saturation level changes. The pitch of the tone rises as the saturation level increases and falls as the saturation level decreases. The volume of this tone is user adjustable.

1. Select the **[Volume Setup]** QuickKey, or the ECG parameter window→**[Others >>]**, or the SpO₂ parameter window.
2. Select **[QRS Volume]** or **[Beat Vol]** and then select the appropriate volume. 0 means off, and 10 is the maximum volume.

3.11 Setting Parameters

3.11.1 Switching the Parameters On/Off

To switch the parameters on or off,

1. Select **[Main Menu]**→**[Maintenance >>]**→**[User Maintenance >>]**→enter the required password→**[Others]**.
2. Configure the **[Para Switch Authority]** to **[Unprotected]** or **[Protected]**.
 - ◆ If **[Para Switch Authority]** is configured to **[Unprotected]**, select **[Main Menu]**→**[Screen Setup>>]**→**[Screen Layout >>]**→**[Parameters Switch]** to switch the parameters on or off.
 - ◆ If **[Para Switch Authority]** is configured to **[Protected]**, the parameter switch is password protected. To switch the parameters on or off, select **[Main Menu]**→**[Maintenance >>]**→**[User Maintenance >>]**→enter the required password→**[Others >>]**→**[Parameters Switch Setup >>]**.

NOTE

-
- **ECG is always selected, and you cannot switch it off.**
-

3.11.2 Accessing the Parameters Menu

Select **[Parameters >>]** from the main menu or select the corresponding parameter area or waveform area to access a parameter setup menu.

3.12 Operating Modes

Your monitor has different operating modes. Some are password protected. This section lists the major operating modes.

3.12.1 Monitoring Mode

This is the normal, everyday working mode that you use for monitoring patients. Your monitor automatically enters the monitoring mode after being turned on.

3.12.2 Night Mode

To avoid disturbing the patient, night mode may be used.

To activate the night mode:

1. Select [**Main Menu**]→[**Screen Setup >>**]→[**Night Mode >>**].
2. In the pop-up menu, set the desired brightness, alarm volume, QRS volume, key volume, NIBP end tone, or whether to stop NIBP measurement or not. When [**Stop NIBP**] is selected, all the NIBP measurements terminate after entering the night mode.
3. Select the [**Enter Night Mode**] button.

To cancel the night mode:

1. Select [**Main Menu**]→[**Screen Setup >>**]→[**Night Mode >>**].
2. Select [**OK**] in the popup.

WARNING

- **Before entering night mode, confirm the settings of brightness, alarm volume, QRS volume, and key volume. Pay attention to the potential risk when the setting value is a bit low.**
-
-

3.12.3 Privacy Mode

Privacy mode is only available when a patient who is admitted at a monitor is also monitored by the central station.

To activate the privacy mode, select [**Main Menu**]→[**Screen Setup >>**]→[**Privacy Mode**].

The monitor behaves as follows as soon as the privacy mode is activated:

- The screen turns blank and [**Under monitoring. Press any key to exit the privacy mode.**] is displayed.
- Monitoring and data storing continue but patient data is only visible at the central station.
- Alarms can still be triggered. But all audible alarms are suppressed and the alarm light is deactivated at the monitor.
- All system sounds are suppressed, including heart beat tone, pulse tone, all prompt tones, etc.

To cancel the privacy mode, press any key.

The monitor exits the privacy mode automatically in one of the following situations:

- The monitor disconnects from the central station.
- The alarm [**Battery Too Low**] or [**System will shut down soon. Please replace the batteries or use the external power.**] is presented.

The touchscreen is locked automatically in the privacy mode.

 **WARNING**

-
- **During privacy mode, all audible alarms are suppressed and the alarm light is deactivated at the monitor. Alarms sound only at the central station.**
-

3.12.4 Demo Mode

In Demo mode, the monitor can demonstrate its major functions when a patient or patient simulator is not connected.

The Demo mode is password protected.

To enter the Demo mode:

1. Select [**Main Menu**]→[**Maintenance >>**].
2. Select [**Demo >>**]. Enter the required password and then select [**Ok**].

To exit the Demo mode, select [**Main Menu**]→[**Maintenance >>**]→[**Exit Demo**].

 **WARNING**

-
- **The Demo mode is for demonstration purposes only. To avoid simulated data being mistaken for a monitored patient's data, you must not change into Demo mode during monitoring. Otherwise, improper monitoring and delayed treatment could result.**
-

3.12.5 Standby Mode

In standby mode, you can temporarily stop monitoring without turning off the monitor. To enter the standby mode,

select the Standby QuickKey .

4 Managing Patients

4.1 Admitting a Patient

The monitor displays physiological data and stores it in the trends as soon as a patient is connected. This allows you to monitor a patient that is not admitted yet. However, it is recommended that you fully admit a patient so that you can clearly identify your patient, on recordings, reports and networking devices.

To admit a patient:

1. Select the **[Patient Setup]** QuickKey, or **[Main Menu]→[Patient Setup >>]**.
2. Select **[Discharge Patient]** to clear any previous patient data. If you do not erase data from the previous patient, the new patient's data will be saved into the data of the previous patient. The monitor makes no distinction between the old and the new patient data.
3. If the **[Discharge Patient]** button appears dimmed, directly select **[Admit Patient]** and then select:
 - ◆ **[Yes]** to apply the data saved in the monitor to the new patient, or
 - ◆ **[No]** to clear the data saved in the monitor.
4. In the **[Patient Demographics]** menu, enter the demographic details, of which:
 - ◆ **[Patient Cat.]** determines the way your monitor processes and calculates some measurements, and what safety and alarm limits are applied for your patient.
 - ◆ **[Paced]** determines whether to show pace pulse marks on the ECG waveform. When the **[Paced]** is set to **[No]**, pace pulse marks are not shown in the ECG waveform.
5. Select **[Ok]**.

WARNING

- **[Patient Cat.] and [Paced] will always contain a value, regardless of whether the patient is fully admitted or not. If you do not specify settings for these fields, the monitor uses the default settings from the current configuration, which might not be correct for your patient.**
 - **For paced patients, you must set [Paced] to [Yes]. If it is incorrectly set to [No], the monitor could mistake a pace pulse for a QRS and fail to alarm when the ECG signal is too weak.**
 - **For non-paced patients, you must set [Paced] to [No].**
-

4.2 Quick Admitting a Patient

Use **[Quick Admit]** only if you do not have the time or information to fully admit a patient. Complete the rest of the patient demographic details later. Otherwise, the  symbol will always be displayed in the patient information area.

1. Select the **[Patient Setup]** QuickKey, or **[Main Menu]→[Patient Setup >>]**.
2. Select **[Quick Admit]**. If a patient has been admitted at present, select **[Ok]** to discharge the current patient. If no patient is admitted, you can choose either:
 - ◆ **[Yes]** to apply the data in your monitor to the new patient, or
 - ◆ **[No]** to clear any previous patient data.
3. Enter the patient category and paced status for the new patient, and then select **[Ok]**.

4.3 Querying and Obtaining Patient Information

The monitor can obtain patient information from HIS through eGateway. To query or obtain patient information from HIS,

1. Select **[Main Menu]→[Maintenance >>]→[User Maintenance >>]**→enter the required password→**[Gateway Comm Setting >>]**, and set **[IP Address]** and **[Port]**. Set **[ADT Query]** to **[On]**.
2. Click the patient information area to enter the **[Patient Demographics]** menu.
3. Select **[Obtain Patient Info. >>]** to enter the **[Obtain Patient Information]** menu.
4. Input the query condition and then select **[Query]**. The monitor will display the obtained patient information.
5. Select a patient and then click **[Import]**. The monitor will update the information of the corresponding patient.
6. Select  to exit the **[Obtain Patient Information]** menu.

NOTE

-
- **The option [Obtain Patient Information] is available in the [Patient Setup] menu only when [ADT Query] is set to [On].**
 - **When obtaining patient information from HIS, the monitor will only update patient information. The patient's monitoring data is not changed and the patient is not discharged.**
-

4.4 Associating Patient Information

After associating patient information with HIS, the monitor will automatically update patient information if corresponding information in HIS has been changed. The monitor can associate a patient's MRN, first name, last name, date of birth, and gender with HIS.

NOTE

- **A keyword takes effect only when being defined in eGateway. Refer to *eGateway Integration Manager Installation Guide* for details.**
 - **The monitor displays corresponding patient information only when all the keywords have been inputted.**
-

4.5 Editing Patient Information

To edit the patient information after a patient has been admitted, or when the patient information is incomplete, or when you want to change the patient information:

1. Select the [**Patient Setup**] QuickKey, or [**Main Menu**]→[**Patient Setup >>**].
2. Select [**Patient Demographics**] and then make the required changes.
3. Select [**Ok**].

4.6 Discharging a Patient

To discharge a patient:

1. Select the [**Patient Setup**] QuickKey, or [**Main Menu**]→[**Patient Setup >>**].
2. Select [**Discharge Patient**]. In the popup menu, you can either:
 - ◆ Directly select [**Ok**] to discharge the current patient, or
 - ◆ Select [**Standby**] then [**Ok**]. The monitor enters the standby mode after discharging the current patient, or
 - ◆ Select [**Cancel**] to exit without discharging the patient.

NOTE

- **Discharging a patient clears all data history in the monitor.**
-

4.7 Transferring a Patient

You can transfer patient data between monitors with a USB drive without re-entering the patient demographic information. Transferring of patient data enables you to understand the patient's historical condition. The patient data that can be transferred includes: patient demographics, trend data, alarm events and parameters alarm limits.

Select [**Others >>**] from [**User Maintenance**] menu. In the popup menu, you can set [**Transferred Data Length**]. The default is [**4 h**]. You can also set [**Data Transfer Method**]. The default is [**Off**].

WARNING

- **Do not discharge a patient before the patient is successfully transferred.**
- **After a patient is successfully transferred, check if the patient settings (especially patient category, paced status and alarm limits settings, etc) on the monitor are appropriate for this patient.**

NOTE

- **The system automatically switches on the HR alarm and lethal arrhythmia alarm after transferring the patient data.**

4.7.1 Transferring Data from the Monitor to a USB Drive

1. Select [**Main Menu**]→[**Patient Setup >>**].
2. Select [**Transfer to Storage Medium**]. In the popup menu, select [**Ok**].
3. Wait until the following message appears: [**Transfer to storage medium successful. Please remove the USB drive.**].
4. Remove the USB drive from the monitor.

4.7.2 Transferring Data from a USB Drive to the Monitor

1. Connect the USB drive to the destination monitor.
2. In the popup menu, you can:
 - ◆ Select [**Transfer**] to transfer the patient data to the monitor, or
 - ◆ Select [**Cancel Transfer**] to cancel the operation of transferring patient data.
 - ◆ Select [**Unload USB Drive**] to not transfer the patient data and to unload the USB drive.
3. After you select [**Transfer**], in the popup menu you can further select the patient data contents that need to be transferred. [**Patient Demographics**] must be selected. After [**Ok**] is selected, the monitor compares the patient information stored in both the storage medium and monitor and deals with the patient data based on the following.
 - ◆ **Different Patients:** The monitor erases all the current patient data, transfers the patient data from the storage medium, and loads the configuration according to the patient category.
 - ◆ **Same Patient:** In the popup dialog box, you can:
 - ◆ Select [**Yes**] to merge the patient data in the monitor and storage medium.
 - ◆ Select [**No**] to erase all the current patient data in the monitor and to transfer the patient data from the storage medium.
4. Wait until the following message appears: [**Transfer from storage medium successful.**].



WARNING

- **The USB drive you use may have a write-protect function. In this case, please make sure the USB drive for data transfer is in read/write mode.**
- **Do not discharge a patient before the patient is successfully transferred.**
- **Do not remove the storage medium during the data transfer process. Otherwise, data files may be damaged.**
- **After a patient is successfully transferred, check if the patient settings (especially patient category, paced status and alarm limits settings, etc) on the monitor are appropriate for this patient.**

NOTE

- **The system automatically switches on the HR alarm and lethal arrhythmia alarm after transferring the patient data.**
-

4.8 Connecting to a Central Monitoring System

If your monitor is connected to a central monitoring system (CMS):

- All patient information, measurement data and settings on the monitor can be transferred to the CMS.
- All patient information, measurement data and settings can be displayed simultaneously on the monitor and CMS.
For some functions such as editing patient information, admitting a patient, discharging a patient, starting/stopping NIBP measurements, etc., bi-directional control can be achieved between your monitor and the CMS.

For details, refer to the CMS's instructions for use.

5 Managing Configurations

5.1 Introduction

When performing continuous monitoring on a patient, the clinical professional often needs to adjust the monitor's settings according to the patient's condition. The collection of all these settings is called a configuration. Allowing you to configure the monitor more efficiently, the monitor offers different sets of configuration to suit different patient categories. You can change some settings from a certain set of configuration and then save the changed configuration as a user configuration.

WARNING

- **The configuration management function is password protected. The configuration management tasks must be performed by clinical professionals.**
-

The system configuration items can be classified as:

- Parameter configuration items

These items relate to parameters, e.g., waveform gain, alarm switch, alarm limits.

- Conventional configuration items

These items define how the monitor works, e.g., screen layout, record, print and alarm settings.

- User maintenance items

These items relate to user maintenance settings, e.g., unit setup, time format and data format.

For the important configuration items and their default values and user maintenance items, see appendix **Configuration Default Information**.

5.2 Entering the [Manage Configuration] Menu

1. Press the  hardkey on the monitor's front to enter the main menu.
2. Select [**Maintenance >>**]→[**Manage Configuration >>**]. Enter the required password and then select [**Ok**].

5.3 Setting Default Configuration

The monitor will load the pre-set default configuration in the following cases.

- The monitor restarts 120 seconds later after the power failure.
- A patient is admitted.
- A patient is discharged.
- Patient data is cleared.
- Patient category is changed.

To set default configuration:

1. Select [**Select Default Config. >>**] in the [**Manage Configuration**] menu.
2. In the [**Select Default Config.**] menu, select [**Load the Latest Config.**] or [**Load Specified Config.**].

When you select [**Load Specified Config.**], the configuration (Canine, Feline and Other (short for other animals));to be restored is subject to the patient category. This configuration can be either a factory configuration or a saved user configuration. Take canine as an example, select [**Default Canine Config.**] and toggle between [**Defaults**] or user configuration(s).

NOTE

- **To see which configuration is restored when the monitor starts, enter the main screen to check the prompt information at the lower part of the screen (displayed for about 10 seconds).**
-

5.4 Saving Current Settings

Current settings can be saved as a user configuration. Up to 3 user configurations can be saved.

To save current settings:

1. Select [**Save Current Settings As >>**] in the [**Manage Configuration**] menu.
2. In the popup dialog box, enter the configuration name and then select [**Ok**].

5.5 Editing a Configuration

1. Select [**Edit Config. >>**] in the [**Manage Configuration**] menu.
2. The popup menu shows the existing configurations on the monitor. Selecting [**Config. on USB drive >>**] will show the existing configurations on the USB drive. Select the desired configuration and then select the [**Edit**] button.
3. Select [**Alarm Setup >>**], [**Screen Setup >>**] or [**Parameter >>**] to enter the corresponding menu in which settings can be changed. The changed items of alarm setup will be marked in red.
4. You can select [**Save**] or [**Save as**] to save the changed configuration. Select [**Save**] to overwrite the original configuration. Select [**Save as**] to save the changed configuration in another name.

5.6 Deleting a Configuration

1. Select [**Delete Config. >>**] in the [**Manage Configuration**] menu.
2. The popup menu shows the existing user configurations on the monitor. Selecting [**Config. on USB drive >>**] will show the existing user configurations on the USB drive. Select the user configurations you want to delete and then select [**Delete**].
3. Select [**Yes**] in the popup.

5.7 Transferring a Configuration

When installing several monitors with identical user configurations, it is not necessary to set each unit separately. A USB drive may be used to transfer the configuration from monitor to monitor.

To export the current monitor's configuration:

1. Connect the USB drive to the monitor's USB port.
2. Select [**Export Config. >>**] in the [**Manage Configuration**] menu.
3. In the [**Export Config.**] menu, select the configurations and [**User Maintenance Settings**] to export. Then select the [**Export**] button. A status message will report completion of the transfer.

To import the configuration on the USB drive to the monitor:

1. Connect the USB drive to the monitor's USB port.
2. Select [**Import Config. >>**] in the [**Manage Configuration**] menu.
3. In the [**Import Config.**] menu, select the configurations and [**User Maintenance Settings**] to import. Then select the [**Import**] button. A status message will report completion of the transfer.

5.8 Loading a Configuration

You may make changes to some settings during operation. However, these changes or the pre-selected configuration may not be appropriate for the newly admitted patient. Therefore, the monitor allows you to load a desired configuration so as to ensure that all the settings are appropriate for your patient.

To load a configuration,

1. Select [**Load Configuration >>**] from the main menu.
2. The popup menu shows the existing configurations on the monitor. Selecting [**Config. on USB drive >>**] will show the existing configurations on the USB drive.
3. Select a desired configuration.
4. Select [**View**] to view the configuration details. In the popup menu, you can select [**Alarm Setup >>**], [**Screen Setup >>**] or [**Parameter >>**] to view the corresponding contents. The alarm setup items which are different than those currently used are marked in red.
5. Select [**Load**] to load this configuration.

5.9 Restoring the Latest Configuration Automatically

During operation, you may make changes to some settings. However, these changes may not be saved as user configuration. To prevent the changes from being lost in case of a sudden power failure, the monitor stores the configuration in real time. The saved configuration is the latest configuration.

The monitor restores the latest configuration if it restarts within 60 seconds after the power failure. It will restore the default configuration rather than the latest configuration if it restarts 120 seconds later after the power failure. The monitor may load either the latest configuration or the default configuration if it restarts between 60-120 seconds after the power failure.

5.10 Modifying Password

To modify the password for accessing the **[Manage Configuration]** menu,

1. Select **[Modify Password >>]** in the **[Manage Configuration]** menu.
2. Input a new password in the popup menu.
3. Select **[Ok]**.

6 User Screens

6.1 Tailoring Your Screens

You can tailor your monitor's screens by setting:

- Wave line size
- The color in which each measurement's numerics and waveform are displayed
- The parameter to be monitored.

Changing some settings may be hazardous. Therefore, those settings are password-protected and can be modified by authorized personnel only. Once a change is made, those who use the monitor should be notified.

6.1.1 Changing the Wave Line Size

1. Select [**Main Menu**]→[**Maintenance >>**]→[**User Maintenance >>**]→enter the required password.
2. Select [**Others >>**].
3. Select [**Wave Line**] and toggle between [**Thick**], [**Mediate**] and [**Thin**].

6.1.2 Changing Measurement Colors

1. Select [**Main Menu**]→[**Screen Setup >>**]→[**Measurement Color Setup >>**].
2. Select the color box next to your desired measurement and then select a color from the popup menu.

6.1.3 Changing Screen Layout

Select the [**Screens**] QuickKey, or [**Main Menu**]→[**Screen Setup >>**]→[**Screen Layout >>**] to enter the [**Screens**] menu.

- You can choose the desired screen type in the [**Choose Screen**] window.
- You can select the parameters and waveforms you want to view in the [**Screen Setup**] window. For details, please refer to the section **Setting the Screen**.
- You can select the parameters you want to view on the big numerics screen in the [**Big Numerics Screen Setup**] window.
- You can switch on or off the connected parameter modules in the [**Parameters Switch**] window. If a parameter module is switched off, parameter values and waveforms will not display on the screen.

6.2 Viewing Minitrends

6.2.1 Having a Split-Screen View of Minitrends

You can split the normal screen so that one part of the screen, on the left hand side, continuously shows graphic minitrends beside waveforms as shown in the figure below.

To have a split-screen view of minitrends, you can:

- Select the **[Minitrends]** QuickKey, or
- Select the **[Screens]** QuickKey→**[Choose Screen]**→**[Minitrends Screen]**→**X**, or
- Select **[Main Menu]**→**[Screen Setup >>]**→**[Screen Layout >>]**→**[Choose Screen]**→**[Minitrends Screen]**→**X**.

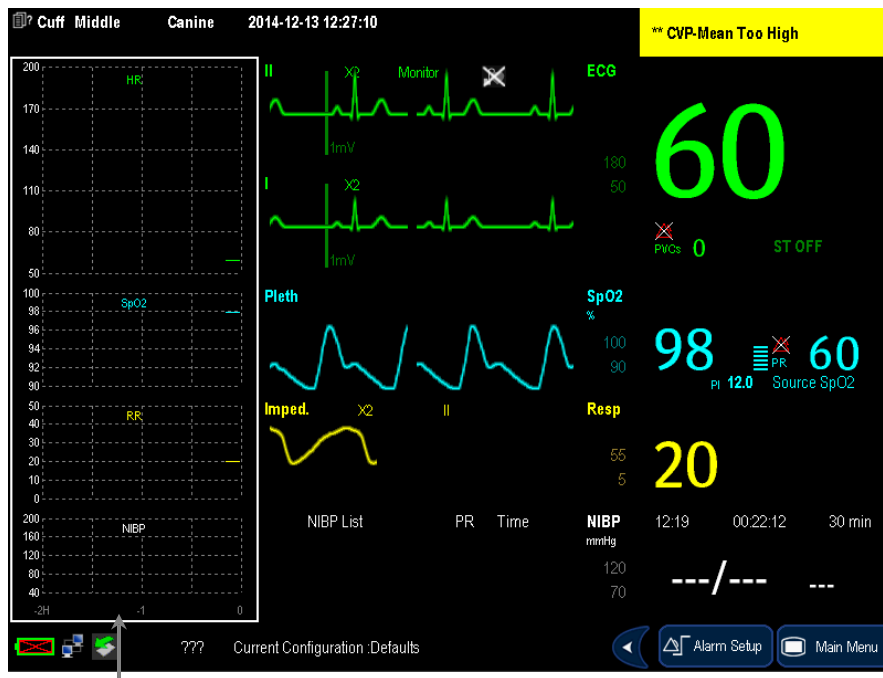

Minitrend View

The split-screen view provides minitrends for multiple parameters. In each field, the label and scale are respectively displayed at the top and left. The time is displayed at the bottom of the minitrends shown view.



6.2.2 Setting Minitrends

Select the minitrends area. From the pop-up **[Minitrend Setup]** menu, you can:

- Select the parameters to be displayed, or
- Select **[Minitrend Length]** and then select the appropriate setting.

6.3 Viewing OxyCRG

To have a split screen view of OxyCRG, you can:

- Select the **[OxyCRG]** QuickKey, or
- Select the **[Screens]** QuickKey→**[Choose Screen]**→**[OxyCRG Screen]**→**X**, or.
- Select **[Main Menu]**→**[Screen Setup >>]**→**[Screen Layout >>]**→**[Choose Screen]**→**[OxyCRG Screen]**→**X**.

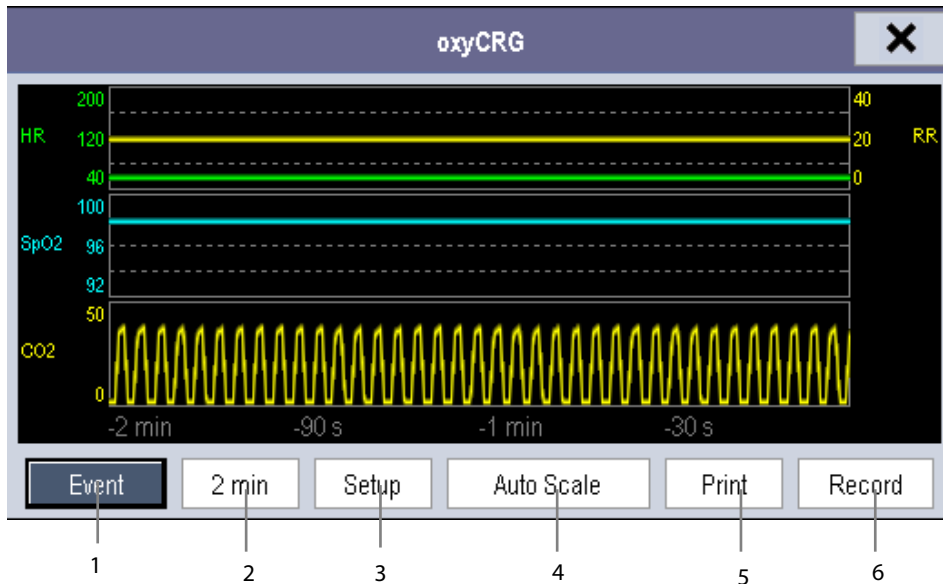

The split-screen view covers the lower part of the waveform area and shows HR trend, SpO₂ trend, RR trend, and a compressed wave (Resp wave or CO₂ wave). At the bottom, there are the following controls:

1. OxyCRG Event

You can enter the **[Review]** menu by selecting the **[OxyCRG Event]** button.

2. Trend length list box

In the trend length list box, you can select **[1 min]**, **[2 min]**, **[4 min]**, or **[8 min]**.

3. Setup

Select the **[Setup]** button to enter the **[Setup]** menu, in which you can select the parameters for display, the time length to be saved before and after an event, and the scale of the graphic trends and waveform. The trend area can display two parameter trends, e.g. HR trend and RR trend, simultaneously.

4. Auto Scale

Select the **[Auto Scale]** button, and the system automatically adjusts the scaling.

5. Print

Select **[Print]** to print out the realtime OxyCRG.

6. Record

With this button, you can print out the currently displayed OxyCRG trends by the recorder.

6.4 Viewing Other Patients

6.4.1 Care Group

You can place up to 10 monitors (including telemetry) connected to the same LAN into a Care Group. This lets you:

- View information on the monitor screen from another bed in the same Care Group.
- Be notified of physiological and technical alarm conditions at the other beds in the same Care Group.

To have a Care Group:

1. Open the **[View Other Patient]** window by:
 - ◆ Selecting the **[Others]** QuickKey, or

- ◆ Selecting the [Screens] QuickKey→[Choose Screen]→[View Others Screen]→**X**, or
 - ◆ Selecting [Main Menu]→[Screen Setup >>]→[Screen Layout >>]→[Choose Screen >>]→[View Others Screen]→**X**.
2. Select [Setup] in the [View Other Patient] window.
 3. Select the desired monitors from the [Connected Monitor List], and then select the **X** button. The selected monitors constitute a Care Group.

6.4.2 Viewing the Care Group Overview Bar

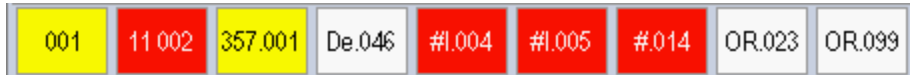

The Care Group overview bar is located at the bottom of the [View Other Patient] window. In the overview bar, the department and bed label for any Care Group beds are displayed. For telemetry, # is displayed before the department label. The color in which a Care Group bed appears matches its status:

- Red: indicates the bed is giving high-level physiological alarms or the telemetry is giving alarm, such as nurse call or event.
- Yellow: indicates the bed is giving medium- or low-level physiological alarms, or medium-level technical alarms.
- Blue: indicates the bed is giving low-level technical alarms.
- Grey: indicates the bed fails to be networked or is in the standby mode.

You can view a Care Group bed's alarms by selecting it from the care group, or you can select the [View This Patient] button to view this bed in the [View Other Patient] window.

For more details about Care Group alarms, refer to the **Alarms** chapter.

6.4.3 Understanding the [View Other Patient] Window

When you first open the [View Other Patient] window, the monitor automatically selects a monitor from the network to display in the [View Other Patient] window.

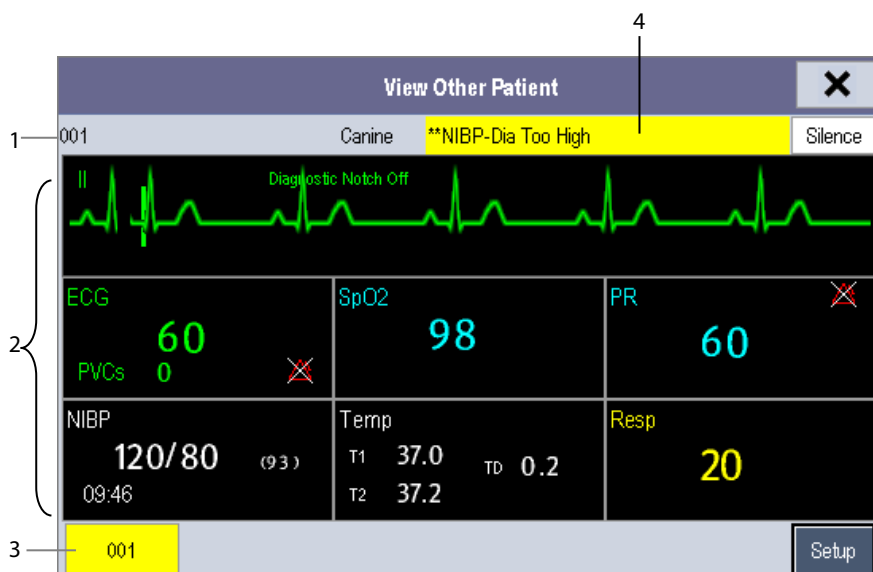

The **[View Other Patient]** window covers the lower part of the waveform area and consists of:

1. Information Area: shows the patient information, network status symbol.
2. View Area: shows physiological waveforms and parameters. You can switch a waveform area to a parameter area by selecting your desired waveform area and then selecting **[Switch to Parameter Area]**, or switch a parameter area to a waveform area by selecting your desired parameter area and then selecting **[Switch to Waveform Area]**.
3. Care Group Overview Bar.
4. Message Area: shows physiological, technical and prompt messages from the currently viewed monitor. It also shows the alarm given by the telemetry such as nurse call or event. By selecting this area, you can enter the **[Alarm Information List]** to view all physiological, technical and prompt messages coming from the currently viewed patient.

Additionally, you can change a waveform or parameter for viewing:

- To change a waveform for viewing, select the waveform segment where you want a new waveform to appear and then select the waveform you want from the popup menu.
- To change a parameter for viewing, select the parameter window where you want a new parameter to appear and then select the parameter you want from the popup menu.



WARNING

- **The data presented in the [View Other Patient] window may have a delay. Do not rely on this window for realtime data.**
-
-

6.5 Understanding the Big Numerics Screen

To enter the big numerics screen:

1. Select the **[Screens]** QuickKey, or **[Main Menu]**→**[Screen Setup >>]**→**[Screen Layout >>]**→**[Choose Screen]**.
2. Select **[Big Numerics]**→**X**.

You can select your desired parameters to display in this screen: select the **[Screens]** QuickKey→**[Big Numerics Screen Setup]** and then select the parameters you want. For parameters having a waveform, the waveform will also be displayed.

FOR YOUR NOTES

7 Alarms

Alarms, triggered by a vital sign that appears abnormal or by technical problems of the monitor, are indicated to the user by visual and audible alarm indications.

WARNING

- **A potential hazard can exist if different alarm presets are used for the same or similar equipment in any single area, e.g. an intensive care unit or cardiac operating room.**
 - **If your monitor is connected to the central monitoring system (CMS) or other monitors, alarms can be displayed and controlled remotely. Remote suspension, inhibition, or silence of monitor alarms via the CMS or other monitors may cause a potential hazard. For details, refer to the operator's manual of the CMS and the other monitors.**
-

7.1 Alarm Categories

By nature, the monitor's alarms can be classified into three categories: physiological alarms, technical alarms and prompt messages.

1. Physiological alarms

Physiological alarms, also called patient status alarms, are triggered by a monitored parameter value that violates set alarm limits or an abnormal patient condition. Physiological alarm messages are displayed in the physiological alarm area.

2. Technical alarms

Technical alarms, also called system status alarms, are triggered by a device malfunction or a patient data distortion due to improper operation or mechanical problems. Technical alarm messages are displayed in the technical alarm area.

Apart from the physiological and technical alarm messages, the monitor shows some messages telling the system status or patient status. Messages of this kind are included in the prompt message category and usually displayed in the prompt information area. Some prompt messages that indicate arrhythmia events are displayed in the physiological alarm area. For some measurements, their related prompt messages are displayed in their respective parameter windows.

7.2 Alarm Levels

By severity, the monitor's alarms can be classified into three categories: high level, medium level and low level.

	Physiological alarms	Technical alarms
High level	Indicate that your patient is in a life threatening situation, such as Asystole, Vfib/Vtac and so forth, and an emergency treatment is demanded.	Indicate a severe device malfunction or an improper operation, which could make it possible that the monitor cannot detect critical patient status and thus threaten the patient's life, such as low battery.
Medium level	Indicate that your patient's vital signs appear abnormal and an immediate treatment is required.	Indicate a device malfunction or an improper operation, which may not threaten the patient's life but may compromise the monitoring of vital physiological parameters.
Low level	Indicate that your patient's vital signs appear abnormal and an immediate treatment may be required.	Indicate a device malfunction or an improper operation, which may compromise a certain monitoring function but will not threaten the patient's life.

7.3 Alarm Indicators

When an alarm occurs, the monitor will indicate it to the user through visual or audible alarm indications.

- Alarm lamp
- Alarm message
- Flashing numeric
- Audible alarm tones

7.3.1 Alarm Lamp

If a technical alarm or physiological alarm occurs, the alarm lamp will flash. The flashing color and frequency match the alarm level as follows:

- High level alarms: the lamp quickly flashes red.
- Medium level alarms: the lamp slowly flashes yellow.
- Low level alarms: the lamp turns yellow without flashing.

7.3.2 Alarm Message

When an alarm occurs, an alarm message will appear in the technical or physiological alarm area. For physiological alarms, the asterisk symbols (*) before the alarm message match the alarm level as follows:

- High level alarms: ***
- Medium level alarms: **
- Low level alarms: *

Additionally, the alarm message uses different background colors to match the alarm level:

- High level alarms: red
- Medium level alarms: yellow
- Low level alarms: yellow

You can view the alarm messages by selecting the physiological or technical alarm area.

7.3.3 Flashing Numeric

If an alarm triggered by an alarm limit violation occurs, the numeric of the measurement in alarm will flash every second, and the corresponding alarm limit will also flash at the same frequency indicating the high or low alarm limit is violated.

7.3.4 Audible Alarm Tones

The alarm tone is distinct from the heart beat tone, keystroke tone and pulse tone in frequency. This monitor has three choices of alarm tones and patterns: ISO, Mode 1 and Mode 2. For each pattern, the alarm tones identify the alarm levels as follows:





- ISO pattern:
 - ◆ High level alarms: triple+double+triple+double beep.
 - ◆ Medium level alarms: triple beep.
 - ◆ Low level alarms: single beep.
- Mode 1:
 - ◆ High level alarms: high-pitched single beep.
 - ◆ Medium level alarms: double beep.
 - ◆ Low level alarms: low-pitched single beep.
- Mode 2:
 - ◆ High level alarms: high-pitched triple beep.
 - ◆ Medium level alarms: double beep.
 - ◆ Low level alarms: low-pitched single beep.

NOTE

- **When multiple alarms of different levels occur simultaneously, the monitor will select the alarm of the highest level and give visual and audible alarm indications accordingly.**
-

7.3.5 Alarm Status Symbols

Apart from the aforementioned alarm indicators, the monitor still uses the following symbols telling the alarm status:

-  indicates alarms are paused.
-  indicates alarm sound is silenced.
-  indicates the alarm sound is turned off.
-  indicates individual measurement alarms are turned off or the system is in alarm off status.

7.4 Alarm Tone Configuration

7.4.1 Setting the Minimum Alarm Volume

1. Select **[Main Menu]**→**[Maintenance >>]**→**[User Maintenance >>]**→enter the required password.
2. Select **[Alarm Setup >>]** to enter the **[Alarm Setup]** menu.
3. Select **[Minimum Alarm Volume]** and toggle between 0 and 10.

The minimum alarm volume refers to the minimum value you can set for the alarm volume, which is not affected by user or factory default configurations. The setting of minimum alarm volume remains unchanged when the monitor shuts down and restarts.

7.4.2 Changing the Alarm Volume

1. Select the **[Volume Setup]** QuickKey or the **[Alarm Setup]** QuickKey→**[Others]**, or **[Main Menu]**→**[Alarm Setup >>]**→**[Others]**.
2. Select the appropriate volume from **[Alm Volume]: X-10**, in which X is the minimum volume, depending on the set minimum alarm volume, and 10 is the maximum volume.
3. Select **[High Alarm Volume]** to set the volume of the high priority alarm as **[Alm Volume+0]**, **[Alm Volume+1]** or **[Alm Volume+2]**.
4. Select **[Reminder Vol]** to set the volume of the reminder tone as **[High]**, **[Med]** or **[Low]**.

When alarm volume is set to 0, the alarm sound is turned off and a  symbol appears on the screen.

7.4.3 Setting the Interval between Alarm Sounds

You cannot change the interval between alarm tones if you choose mode 1 or 2 as your desired alarm tone pattern. For these two patterns, the interval between alarm tones identifies the alarm levels as follows:

- Mode 1:
 - ◆ Interval between high level alarm tones: continuous
 - ◆ Interval between medium level alarm tones: 5 s.
 - ◆ Interval between low level alarm tones: 20 s.
- Mode 2:
 - ◆ Interval between high level alarm tones: 1 s.
 - ◆ Interval between medium level alarm tones: 5 s.
 - ◆ Interval between low level alarm tones: 20 s.

If you choose the ISO pattern, you can change the interval between alarm tones. To change the interval between alarm tones:

1. Select **[Main Menu]**→**[Maintenance >>]**→**[User Maintenance >>]**→enter the required password.
2. Select **[Alarm Setup >>]** to enter the **[Alarm Setup]** menu.
3. Select **[High Alarm Interval (s)]**, **[Med Alarm Interval (s)]** and **[Low Alarm Interval (s)]** in turn and then select the appropriate settings.

 **WARNING**

- **When the alarm sound is switched off, the monitor will give no audible alarm tones even if a new alarm occurs. Therefore the user should be very careful about whether to switch off the alarm sound or not.**
 - **Do not rely exclusively on the audible alarm system for monitoring. Adjustment of alarm volume to a low level may result in a hazard to the patient. Always keep the patient under close surveillance.**
-

7.4.4 Changing the Alarm Tone Pattern

To change the alarm tone pattern:

1. Select **[Main Menu]**→**[Maintenance >>]**→**[User Maintenance >>]**→enter the required password.
2. Select **[Alarm Setup >>]** to enter the **[Alarm Setup]** menu.
3. Select **[Alarm Sound]** and toggle between **[ISO]**, **[Mode 1]** and **[Mode 2]**.

User or factory default configurations exert no impact on the setup of the alarm tone pattern. The alarm tone pattern remains unchanged after the monitor restarts.

7.4.5 Setting the Reminder Tones

When the alarm volume is set to zero, or the alarm tone is silenced or turned off, the monitor issues a periodical reminder tone. To set the reminder tones:

1. Select **[Main Menu]**→**[Maintenance >>]**→**[User Maintenance >>]**→enter the required password.
2. Select **[Alarm Setup >>]** to enter the **[Alarm Setup]** menu.
3. Set the **[Reminder Tones]** to **[On]**, **[Off]** or **[Re-alarm]**. When **[Re-alarm]** is selected, the current physiological alarms and technical alarms marked with “√” will be re-generated after the **[Reminder Interval]**.

To set the interval between reminder tones, select **[Reminder Interval]** and toggle between **[1 min]**, **[2 min]** and **[3 min]**.

In addition, you can set the volume of alarm reminder tones. To set the volume of alarm reminder tones, select **[Main Menu]**→**[Alarm Setup >>]**→**[Others]** or the **[Alarm Setup]** QuickKey→**[Others]**. Then, select **[Reminder Vol]** and toggle between **[High]**, **[Medium]** and **[Low]**.

7.5 Understanding the Alarm Setup Menu

Select the **[Alarm Setup]** QuickKey or **[Main Menu]**→**[Alarm Setup >>]** to enter the **[Alarm Setup]**, where you can:

- Set alarm properties for all parameters.
- Change ST alarm settings.
- Change arrhythmia alarm settings.
- Set the threshold for some arrhythmia alarms.
- Change other settings.

Please refer to the **ECG** section for how to change ST alarm settings, how to change arrhythmia alarm settings and how

to set the threshold for some arrhythmia alarms.

7.5.1 Setting Alarm Properties for All Parameters

In the main menu, select **[Alarm Setup >>]** → **[Parameters]**. You can review and set alarm limits, alarm switches, alarm level and alarm recordings for all parameters.

When a measurement alarm occurs, automatic recording of all the measurement numerics and related waveforms is possible when the measurement's **[On/Off]** and **[Record]** are set on.

WARNING

- **Make sure that the alarm limits settings are appropriate for your patient before monitoring.**
- **Setting alarm limits to extreme values may cause the alarm system to become ineffective.**

7.5.2 Adjusting Alarm Limits Automatically

The monitor can automatically adjust alarm limits according to the measured vital signs, using the auto limits function. When auto limits are selected, the monitor calculates safe auto limits based on the latest measured values.

To get accurate auto alarm limits, you need to collect a set of measured vital signs as a baseline. Then, in the main menu, select **[Alarm Setup >>]** → **[Parameters]** → **[Auto Limits]** → **[Ok]**. The monitor will create new alarm limits based on the measured values.

Before applying these automatically created alarm limits, confirm if they are appropriate for your patient in the mass alarm setup menu. If not, you can adjust them manually. These alarm limits will remain unchanged until you select auto limits again or adjust them manually.

The monitor calculates the auto limits based on the following rules.

Module	Parameter	Low alarm limit	High alarm limit	Auto alarm limits range
ECG	HR/PR	(HR – 30) or 90bpm (whichever is greater)	(HR + 40) or 200bpm (whichever is smaller)	55 to 225
Resp	RR	(RR – 10) or 30 rpm (whichever is greater)	(RR + 25) or 85 rpm (whichever is smaller)	10 to 90
SpO ₂	SpO ₂	Same as the default alarm limit	Same as the default alarm limit	Same as the measurement range
NIBP (Cuff Type: Small)	NIBP-S	(SYS – 15) or 45mmHg (whichever is greater)	(SYS + 15) or 105mmHg (whichever is smaller)	40 to 115
	NIBP-D	(Dia – 15) or 20mmHg (whichever is greater)	(Dia + 15) or 80mmHg (whichever is smaller)	20 to 90
	NIBP-M	Mean – 15) or 35mmHg (whichever is greater)	(Mean + 15) or 95 mmHg (whichever is smaller)	25 to 105
NIBP (Cuff Type: Medium)	NIBP-S	SYS×0.68 + 10mmHg	SYS×0.86 + 38mmHg	45 to 185
	NIBP-D	Dia×0.68 + 6mmHg	Dia×0.86 + 32mmHg	25 to 150
	NIBP-M	Mean×0.68 + 8mmHg	Mean×0.86 + 35mmHg	30 to 165
NIBP	NIBP-S	SYS×0.68 + 10mmHg	SYS×0.86 + 38mmHg	45 to 270

Module	Parameter	Low alarm limit	High alarm limit	Auto alarm limits range
(Cuff Type: Big)	NIBP-D	Dia×0.68 + 6mmHg	Dia×0.86 + 32mmHg	25 to 210
	NIBP-M	Mean×0.68 + 8mmHg	Mean×0.86 + 35mmHg	30 to 230
Temp	T1	(T1 – 0.5) °C	(T1 + 0.5) °C	1 to 49 °C
	T2	(T2 – 0.5) °C	(T2 + 0.5) °C	1 to 49 °C
	TD	Same as the default alarm limit	Same as the default alarm limit	Same as the measurement range
IBP: ART/ Ao/ UAP/ BAP/ FAP/ LV/ P1-P4 (Arterial pressure)	IBP-S	(SYS – 15) or 45mmHg (whichever is greater)	(SYS + 15) or 105mmHg (whichever is smaller)	35 to 115
	IBP-D	(Dia – 15) or 20mmHg (whichever is greater)	(Dia + 15) or 80mmHg (whichever is smaller)	20 to 90
	IBP-M	(Mean – 15) or 35mmHg (whichever is greater)	(Mean + 15) or 95mmHg (whichever is smaller)	25 to 105
PA	IBP-S	SYS × 0.75	SYS × 1.25	3 to 120mmHg
	IBP-D	Dia × 0.75	Dia × 1.25	
	IBP-M	Mean × 0.75	Mean × 1.25	
IBP: CVP/ ICP/ LAP/ RAP/ UVP/ P1-P4 (Venous pressure)	IBP-M	Mean × 0.75	Mean × 1.25	3 to 40mmHg
CO ₂	EtCO ₂	0 to 32mmHg: remains the same	0 to 32mmHg: remains the same	Same as the measurement range
		32 to 35mmHg: 29mmHg	32 to 35mmHg: 41mmHg	
		35 to 45mmHg: (etCO ₂ -6) mmHg	35 to 45mmHg: (etCO ₂ +6) mmHg	
		45 to 48mmHg:39 mmHg	45 to 48mmHg:51 mmHg	
		>48mmHg: remains the same	>48mmHg: remains the same	
	FiCO ₂	N/A	Same as the default alarm limit	Same as the measurement range
	awRR	(awRR – 10) or 30 rpm (whichever is greater)	(awRR+25) or 85 rpm (whichever is smaller)	10 to 90

7.5.3 Setting Alarm Delay Time

You can set the alarm delay time for over-limit alarms of continuously measured parameters. If the alarm-triggered condition disappears within the delay time, the monitor will not give the alarm. You can set the **[Alarm Delay]** in the **[Others]** window of the **[Alarm Setup]** menu.

Alarm delay is not applied to the following physiological alarms:

- Apnea
- ST alarms
- Arrhythmia alarms
- ECG Weak Signal
- Resp Artifact
- No Pulse
- Nellcor SpO₂ over alarm limits
- Measurements of noncontinuous parameters over alarm limits
- HR over alarm limits

You can set **[Apnea Delay]** and **[ST Alarm Delay]** separately in the **[Others]** window of the **[Alarm Setup]** menu.

7.5.4 Setting SpO₂ Technical Alarm Delay

You can set **[Tech. Alarm Delay]** in the **[Others]** tab of the **[Alarm Setup]** menu. The options are **[Off]**, **[5 s]**, **[10 s]** and **[15 s]**. The delay is effective to the following technical alarms: SpO₂ Sensor Off, SpO₂ Too Much Light, SpO₂ Low Signal and SpO₂ Interference.

7.5.5 Setting Recording Length

You can change the length of the recorded waveforms. In the **[Others]** window of the **[Alarm Setup]** menu, select **[Recording Length]** and toggle between **[8 s]**, **[16 s]** and **[32 s]**:

- **[8s]**: 4 seconds respectively before and after the alarm or manual event trigger moment.
- **[16s]**: 8 seconds respectively before and after the alarm or manual event trigger moment.
- **[32s]**: 16 seconds respectively before and after the alarm or manual event trigger moment.

7.5.6 Intubation Mode

When performing intubation during general anesthesia, you can set the monitor to enter intubation mode in order to reduce unnecessary alarms. Intubation mode is available for Resp and CO₂ parameters. In the setup menu of these parameters, you can choose the **[Intubation Mode]** button to disable respective physiological alarms.

The default intubation time is 2 minutes. You can also change the time by following this procedure:

1. Select **[Main Menu]**→**[Maintenance >>]**→**[User Maintenance >>]**→enter the required password.
2. Select **[Alarm Setup >>]**, and set the **[Intubation Mode Period]** to **[1 min]**, **[2 min]**, **[3 min]**, or **[5 min]**.

7.6 Pausing Alarms

If you want to temporarily prevent alarms from sounding, you can pause alarms by pressing the  hardkey on the monitor's front. When alarms are paused:

- No alarm lamps flash and no alarms are sounded.
- No numeric and alarm limit flash.
- No alarm messages are shown.
- The remaining pause time is displayed in the physiological alarm area.
- The  alarms paused symbol is displayed in the sound symbol area.

If the time interval of the monitor's last shutdown from this starting-up is greater than 2 minutes, the monitor enters into the alarm paused status as soon as it is turned on. The alarm pause time is fixed to be 2 minutes.

When the alarm pause time expires, the alarm paused status is automatically cancelled and the alarm tone will sound.

You can also cancel the alarm paused status by pressing the  hardkey.

You can set the alarm pause time to [1 min], [2 min], [3 min], [5 min], [10 min], [15 min], or [Permanent]. The default alarm pause time is 2 minutes.

1. Select [Main Menu]→[Maintenance >>]→[User Maintenance >>]→enter the required password.
2. Select [Alarm Setup >>]→[Alarm Pause Time] and then select the appropriate setting from the popup list.

7.7 Switching Off All Alarms

If [Alarm Pause Time] is set to [Permanent], the monitor enters into the alarm off status after the  hardkey is pressed. During the alarm off status,



- As for physiological alarms, no alarm lamps flash and no alarms are sounded.
- As for physiological alarms, no numeric and alarm limit flash.
- No physiological alarm messages are shown.
- [Alarm Off] is displayed in the physiological alarm area with a red background.
- As for technical alarms, no alarms are sounded.
- The  alarm off symbol is displayed in the sound symbol area.

You can cancel the alarm off status by pressing the  hardkey.

WARNING

- Pausing or switching off alarms may result in a hazard to the patient. Please be very careful.
-

7.8 Silencing the Alarm Sound

You can silence all alarm sounds by pressing the  hardkey on the monitor's front. In that case, the alarm lamp flashing and alarm tones are cleared and  appears in the sound symbol area. After the physiological alarm is silenced, "✓" appears before the alarm message and the numeric and alarm limit still flash. For the performance after the technical alarm is silenced, please refer to the **Silencing Technical Alarms** section.

The alarm silenced status will be automatically cancelled if you switch the monitor to other alarm statuses or when a new physiological or technical alarm occurs.

7.9 Latching Alarms

The alarm latching setting for your monitor defines how the alarm indicators behave when you do not acknowledge them. When alarms are set to non-latching, their alarm indications end when the alarm condition ends. If you switch alarm latching on, all visual and audible alarm indications last until you acknowledge the alarms, except that the measurement numeric and violated alarm limit stop flashing as soon as the initial alarm condition goes away.

To set alarms to latching or non-latching:

1. Select [Main Menu]→[Maintenance >>]→[User Maintenance >>]→enter the required password.
2. Select [Alarm Setup >>].
3. Select [Latching Alarms] and toggle between [High only], [Hi&Med], [All] and [Off]. If you select [High only], only high priority alarms are latched; if you select [Hi&Med], both high priority alarms and medium priority alarms are latched; if you select [All], all alarms are latched; if you select [Off], the alarm latching is turned off.

NOTE

- **Changing of alarm priority may affect the latching status of corresponding alarms. Please determine if you need to reset the latching status for the specific alarm when you have changed its alarm priority.**
-

7.10 Silencing Technical Alarms

For some technical alarms, their alarm lamp flashing and alarm tones are cleared and the alarm messages change to prompt messages after the  hardkey is pressed. After the monitor restores the normal status, the monitor can give alarm indications correctly when these alarms are triggered again.

For some technical alarms, all their alarm indications are cleared after the  hardkey is pressed. After the monitor restores the normal status, the monitor can give alarm indications correctly when these alarms are triggered again.

For some other technical alarms, their alarm lamp flashing and alarm tones are cleared and "✓" appears before the alarm message after the  hardkey is pressed. After the monitor restores the normal status, the monitor can give alarm indications correctly when these alarms are triggered again.

7.11 Testing Alarms

When the monitor starts up, a self-test is performed. In this case the alarm lamp is lit in yellow and red respectively, and the system gives a beep. This indicates that the visible and audible alarm indicators are functioning correctly.

For further testing of individual measurement alarms, perform the measurement on yourself (for example SpO₂ or CO₂) or use a simulator. Adjust alarm limits and check that appropriate alarm behavior is observed.

7.12 When an Alarm Occurs

When an alarm occurs, observe the following steps and take proper actions:

1. Check the patient's condition.
2. Confirm the alarming parameter or alarm category.
3. Identify the source of the alarm.
4. Take proper action to eliminate the alarm condition.
5. Make sure the alarm condition is corrected.

For troubleshooting specific alarms, see appendix *Alarm Messages*.

7.13 Using Care Group Alarms

7.13.1 Care Group Auto Alarms

When a Care Group is set up on your monitor, a flashing symbol will appear beside the QuickKeys area if any monitor in your Care Group, which is not currently viewed by your monitor, is alarming. The alarm symbol is shown as below.



The background colors of the alarm symbols indicate alarm levels, and are the same as those of the corresponding alarm messages. If multiple alarms are active in the Care Group, the background color is the same as that of the highest-level alarm message. For more information about the alarm message and background color, see *7.3.2 Alarm Message*.

When a monitor in the Care Group is disconnected, the flashing symbol is shown as below.



The department and bed label of the alarming monitor appear on the symbol. You can enter the **[View Other Patient]** window by pressing this symbol.

7.13.2 Setting Care Group Alert Tone

When a monitor in the Care Group issues an alarm, your monitor prompts you by giving an alert tone. To set the alert tone,

1. In the main menu, select **[Screen Setup >>]**→**[Screen Layout >>]**→**[Choose Screen]**.
2. In the **[Choose Screen]** window, select **[View Others Screen]**.
3. In the **[View Other Patient]** window, select **[Setup>>]**, and set **[Alert Tone]** to **[Repeat]**, **[Once]** or **[Off]**.

7.13.3 Silencing Care Group Alarms

You can silence the alarm sound of the currently viewed bed in the **[View Other Patient]** window. This function can be set in the **[Alarm Setup]** menu from the **[User Maintenance]** menu only.

When the alarm silence function for other patients is active and the currently viewed bed is in normal alarm status or alarm sound off status, press the **[Silence]** button in the **[View Other Patient]** window. The currently viewed bed will then enter into the alarm silenced status.

Note that this button is disabled when the currently viewed bed is in alarms off or paused status.

 **WARNING**

-
- **Silencing care group alarms may cause a potential hazard. Please act with caution.**
-
-

8 Monitoring ECG

8.1 Introduction

The electrocardiogram (ECG) measures the electrical activity of the heart and displays it on the monitor as a waveform and a numeric. This section also tells you about ST monitoring and arrhythmia monitoring.

8.2 Safety

WARNING

- Use only ECG electrodes and cables specified by the manufacturer.
 - When connecting electrodes and/or patient cables, make sure that the connectors never come into contact with other conductive parts, or with earth. In particular, make sure that all of the ECG electrodes are attached to the patient, to prevent them from contacting conductive parts or earth.
 - Periodically inspect the electrode application site to ensure skin quality. If the skin quality changes, replace the electrodes or change the application site.
 - Use defibrillator-proof ECG cables during defibrillation.
 - Do not touch the patient, or table, or instruments during defibrillation.
-
-

NOTE

- After defibrillation, the screen display recovers within 10 seconds if the correct electrodes are used and applied in accordance with the manufacturer's instructions for use.
 - Interference from a non-grounded instrument near the patient and electrosurgery interference can cause problems with the waveform.
-

8.3 Preparing to Monitor ECG

8.3.1 Preparing the Patient and Placing the Electrodes

1. Skin preparation

The quality of ECG waveform displayed on the monitor is a direct result of the quality of the electrical signal received at the crocodile clip. Proper skin preparation is necessary for good signal quality at the crocodile clip. A good signal at the crocodile clip provides the monitor with valid information for processing the ECG data. To ensure enough electrolyte material on the skin of patients, you need to moisten the lead sites with 70% isopropyl alcohol. This will usually be sufficient for ECG monitoring for a short time (30 to 60 minutes).

2. Attach the ECG leadwires to the crocodile clips prior to placement.
 3. Place the crocodile clips to the patient in accordance with **8.3.3 ECG Lead Placements**.
 4. Connect the ECG leadwires to the patient cable.
 5. Make sure the monitor is turned on and is ready for monitoring.
-

8.3.2 Choosing AHA or IEC Lead Placement

1. Select the ECG parameter window or waveform area to enter the [ECG Setup] menu.
2. Select [Others]→[Lead Set] and then select [3-lead], [5-lead], or [Auto] according to the applied electrodes.
3. Select [Main Menu]→[Maintenance >>]→[User Maintenance >>]→enter the required password.
4. Select [Others >>]→[ECG Standard] and then select [AHA] or [IEC] according to the standard that is applied for your hospital.

8.3.3 ECG Lead Placements

The electrode placement illustrations in this chapter adopt the AHA standard.

3-Leadwire Electrode Placement

Following is the configuration per the European standard when using three leadwires:

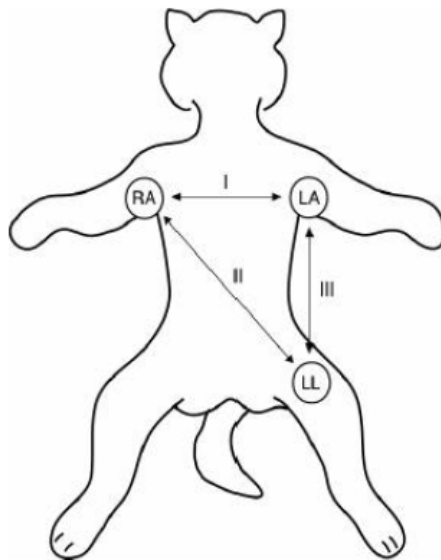

- RA(right arm) lead: on the right foreleg.
- LA(left arm) lead: on the left foreleg.
- LL(left leg) lead: on the left hind leg.

The chart below shows the label used to identify each leadwire. Included also is its associated color code per American (AHA) and European (IEC) standards.

American Standard		European Standard	
Label	Color	Label	Color
RA	White	R	Red
LA	Black	L	Yellow
LL	Red	F	Green

5-Leadwire Electrode Placement

Following is the configuration per the American standard when using five leadwires:

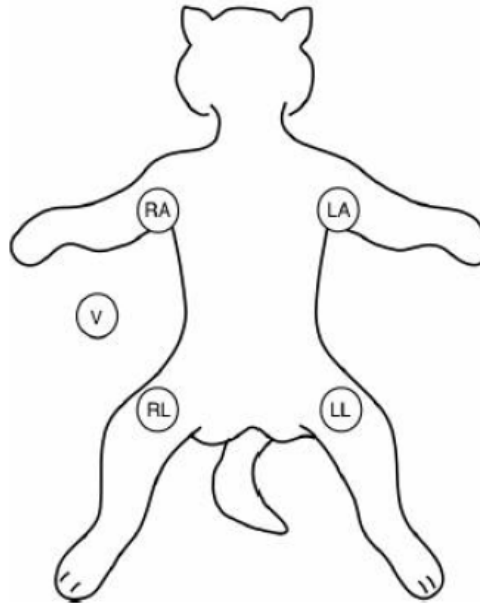

- RA (right arm) lead: on the right foreleg.
- LA (left arm) lead: on the left foreleg.
- RL (right leg) lead: on the right hind leg.
- LL (left leg) lead: on the left hind leg.
- V (precordial) lead: exploring lead.

NOTE

- The exploring lead is used for diagnostic purposes as needed. Otherwise, it may be left unplugged.

The chart below shows the label used to identify each leadwire. Included also is its associated color code per American (AHA) and European (IEC) standards.

American Standard		European Standard	
Label	Color	Label	Color
RA	White	R	Red
LA	Black	L	Yellow
LL	Red	F	Green
RL	Green	N	Black
V	Brown	C	White

Lead Placement for Surgical Patients

The surgical site should be taken into consideration when placing electrodes on a surgical patient. e.g. for open-chest surgery, the chest electrodes can be placed on the lateral chest or back. To reduce artifacts and interference from electrosurgical units, you can place the limb electrodes close to the shoulders and lower abdomen and the chest electrodes on the left side of the mid-chest. Do not place the electrodes on the upper arm. Otherwise, the ECG waveform will be very small.

 **WARNING**

- **When using electrosurgical units (ESU), patient leads should be placed in a position that is equidistant from the Electrosurgery electrotome and the grounding plate to avoid burns to the patient. Never entangle the ESU cable and the ECG cable together.**
 - **When using electrosurgical units (ESU), never place ECG electrodes near to the grounding plate of the ESU, as this can cause a lot of interference on the ECG signal.**
-
-

8.3.4 Checking Paced Status

It is important to set the paced status correctly when you start monitoring ECG. The paced symbol  is displayed in the ECG waveform area when the [**Paced**] status is set to [**Yes**]. The pace pulse markers “|” are shown on the ECG wave when the patient has a paced signal. If [**Paced**] is set to [**No**] or the patient’s paced status is not selected, the symbol



will be shown in the ECG waveform area.

To change the paced status, you can select either:

- the patient information area, or
- [**Main Menu**] → [**Patient Setup**] → [**Patient Demographics**], or,
- the ECG parameter window or waveform area → [**Others >>**], and then, select [**Paced**] from the popup menu and toggle between [**Yes**] and [**No**].

If you do not set the paced status, the monitor issues a prompt tone when pace pulse is detected. At the same time, the paced symbol flashes and the message [**Please confirm the pace of patient**] appears in the ECG waveform area. Then, please check and set the paced status of the patient.

 **Warning**

- **For paced patients, you must set [Paced] to [Yes]. If it is incorrectly set to [No], the monitor could mistake a pace pulse for a QRS and fail to alarm when the ECG signal is too weak. Do not rely entirely on rate meter alarms when monitoring patients with pacemakers. Always keep these patients under close surveillance.**
 - **For non-paced patients, you must set [Paced] to [No].**
 - **The auto pacer recognition function is not applicable to pediatric and neonatal patients.**
-
-

8.4 Understanding the ECG Display

Your display may be configured to look slightly different.

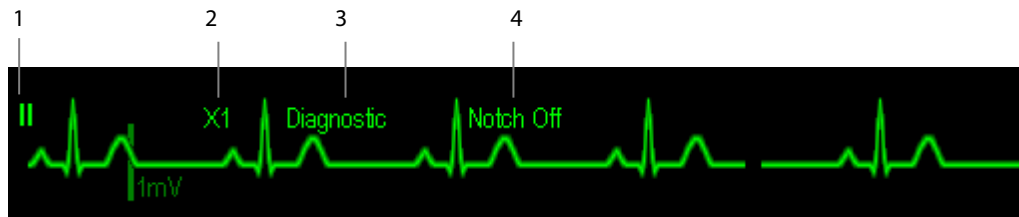

1. Lead label of the displayed wave
2. ECG gain
3. ECG filter label
4. Notch filter status

Besides, when a paced signal has been detected, the pace pulse marks “|” are shown on the ECG wave if the **[Paced]** has been set to **[Yes]**.



1. Current heart rate alarm limits
2. Current heart rate
3. Heart beat symbol

8.5 Changing ECG Settings

8.5.1 Accessing ECG Menus

By selecting the ECG parameter window or waveform area, you can access the **[ECG Setup]** menu.

8.5.2 Choosing the Alarm Source

In most cases the HR and PR numerics are identical. In order to avoid simultaneous alarms on HR and PR, the monitor uses either HR or PR as its active alarm source. To change the alarm source, select **[Alm Source]** in the **[ECG Setup]** menu and then select either:

- **[HR]**: if you want the HR to be the alarm source for HR/PR.
- **[PR]**: if you want the PR to be the alarm source for HR/PR.

- **[Auto]:** If the **[Alm Source]** is set to **[Auto]**, the monitor will use the heart rate from the ECG measurements as the alarm source whenever a valid heart rate is available. If the heart rate becomes unavailable, for example the ECG module is turned off or becomes disconnected, the monitor will automatically switch to PR as the alarm source.

8.5.3 Setting the ECG Lead Set

You can set the **[Lead Set]** by selecting **[ECG Setup]**→**[Others>>]**. You can set the **[Lead Set]** as **[Auto]** if the auto lead detection function is available.

8.5.4 Choosing an ECG Display Screen

When monitoring with a 5-lead set, you can select the **[Screens]** Quickkey. In the **[Choose Screen]** window, choose the screen type as:

- **[Normal Screen]:** The ECG waveform area shows 2 ECG waveforms.
- **[ECG 7-Lead Full-Screen]:** The whole waveform area shows 7 ECG waveforms only.
- **[ECG 7-Lead Half-Screen]:** The upper half part of the whole waveform area displays 7 ECG waveforms.

When the screen type is set to **[Normal Screen]**, cascaded ECG waveforms can be displayed. To cascade ECG waveforms:

1. Select the **[Screens]** Quickkey→**[Screen Setup]**.
2. Select **[ECG1 Casc.]** in the second row. A cascaded waveform is displayed in two waveform positions.

8.5.5 Changing the ECG Filter Settings

The ECG filter setting defines how ECG waves are smoothed. To change the filter setting, select **[Filter]** from **[ECG Setup]** and then select the appropriate setting.

- **[Monitor]:** Use under normal measurement conditions.
- **[Diagnostic]:** Use when diagnostic quality is required. The unfiltered ECG wave is displayed so that changes such as R-wave notching or discrete elevation or depression of the ST segment are visible.
- **[Surgery]:** Use when the signal is distorted by high frequency or low frequency interference. High frequency interference usually results in large amplitude spikes making the ECG signal look irregular. Low frequency interference usually leads to wandering or rough baseline. In the operating room, the surgery filter reduces artifacts and interference from electrosurgical units. Under normal measurement conditions, selecting **[Surgery]** may suppress the QRS complexes too much and then interfere with ECG analysis.
- **[ST]:** Use when ST monitoring is applied.

 **Warning**

- **The [Diagnostic] filter is recommended when monitoring a patient in an environment with slight interference only.**
-

8.5.6 Setting the Notch Filter

The notch filter removes the line frequency interference. Only when **[Filter]** is set to **[Diagnostic]**, the **[Notch Filter]** is adjustable. The notch filter removes the line frequency interference. When **[Filter]** is not set to **[Diagnostic]**, the notch filter always stays on. When **[Filter]** is set to **[Diagnostic]**, you can switch the notch filter on or off as required.

1. Select the ECG parameter window or waveform area to enter its setup menu. Then select **[Others >>]**.
2. Set **[Notch Filter]** to
 - ◆ **[Strong]** when there is strong interference (such as spikes) with the waveform.
 - ◆ **[Weak]** when there is weak interference with the waveform.
 - ◆ **[Off]** to turn the notch filter off.

Set notch frequency according to the electric power frequency of your country. Follow this procedure:

1. When **[Notch Filter]** is set on, select **[Main Menu]** → **[Maintenance >>]** → **[User Maintenance >>]** → enter the required password.
2. Select **[Others >>]** → **[Notch Freq.]** and then select **[50Hz]** or **[60Hz]** according to the power line frequency.

8.5.7 Changing the Pacer Reject Settings

Select **[ECG Setup]** → **[Others >>]** → **[Pacer Reject]**, and toggle between **[On]** and **[Off]**.

When **[Paced]** is set to **[Yes]**:

- When **[Pacer Reject]** is switched on, the pace pulses are not counted as extra QRS complexes.
- The pace pulse marks “|” are shown on the ECG wave when pace pulses are detected.

When **[Paced]** is set to **[No]**, the pace markers are not shown on the ECG wave, and the options of **[Pacer Reject]** are invalid.

8.5.8 Changing ECG Wave Settings

In the **[ECG Setup]** menu:

- You can select **[ECG]**, **[ECG1]**, or **[ECG2]** to select a lead to view. The waveform of the selected lead should have the following characteristics:
 - ◆ The QRS should be either completely above or below the baseline and it should not be biphasic.
 - ◆ The QRS should be tall and narrow.
 - ◆ The P-waves and T-waves should be less than 0.2mV.
- If the wave is too small or clipped, you can change its size by selecting an appropriate **[Gain]** setting. If you select **[Auto]** from **[Gain]**, the monitor will automatically adjust the size of the ECG waves. In normal screen, only the selected ECG wave's size is adjusted. In other screens, all ECG wave sizes are adjusted simultaneously.
- You can change the wave sweep speed by selecting **[Sweep]** and then selecting the appropriate setting.

8.5.9 Enabling Smart Lead Off

When the smart lead off function is set on and there is a “lead off” in the lead that has an ECG waveform in filter mode and notch status, if another lead is available, this available lead automatically becomes that lead. The system will re-calculate HR and analyze and detect arrhythmia. When the “lead off” condition is corrected, the leads are automatically switched back.

To switch on/off the smart lead off function, select **[Others >>]** from the **[ECG Setup]** menu; select **[Smart Lead Off]** and toggle between **[On]** and **[Off]** from the popup menu.

8.5.10 Setting the Alarm Level for ECG Lead Off Alarms

Select **[Alarm Setup >>]** from the **[User Maintenance]** menu. You can set **[ECGLeadOff Lev.]** from the popup menu.

8.5.11 Adjusting QRS Volume

QRS sounds are produced based on the alarm source. To adjust the QRS volume, select **[Others >>]** from the **[ECG Setup]** menu; select **[QRS Volume]** from the popup menu and select the appropriate setting. When a valid SpO₂ measured value is available, the system will adjust the pitch tone of QRS sound based on the SpO₂ value.

8.5.12 About the Defibrillator Synchronization

If a defibrillator is connected, a defibrillator synchronization pulse (100 ms, +5V) is outputted through the Multifunctional Connector every time the monitor detects an R-wave.

WARNING

- **Improper use of a defibrillator may cause injury to the patient. The user should determine whether to perform defibrillation or not according to the patient’s condition.**
 - **Before defibrillation, the user must ensure both defibrillator and monitor have passed the system test and can be safely used jointly.**
 - **Before defibrillation, make sure that the [Filter] is set to [Diagnostic].**
 - **After defibrillation is finished, select the filter mode as required.**
-

8.6 About ST Monitoring

- ST segment analysis calculates ST segment elevations and depressions for individual leads and then displays them as numerics in the ST1 and ST2 areas.
- A positive value indicates ST segment elevation; a negative value indicates ST segment depression.
- Measurement unit of the ST segment: mV or mm. You can set the unit in the **[Unit Setup]** menu from the **[User Maintenance]** menu.
- Measurement range of the ST segment: -2.0 mV to +2.0 mV.

 **WARNING**

- **The ST algorithm has been tested for accuracy of the ST segment data. The significance of the ST segment changes need to be determined by a clinician.**
-

8.6.1 Switching ST On and Off

To switch ST monitoring on or off:

1. In the [ECG Setup] menu, select [ST Analysis >>].
2. Select [ST Analysis] to toggle between [On] and [Off].

Reliable ST monitoring can hardly be ensured if:

- You are unable to get a lead that is not noisy.
- Arrhythmias such as atrial fib/flutter cause irregular baseline.
- The patient is continuously ventricularly paced.
- The patient has left bundle branch block.

In these cases, you may consider switching ST monitoring off.

8.6.2 Changing ST Filter Settings

ST segment analysis can be carried out only when the filter mode is set to [Diagnostic] or [ST]. When ST segment analysis is switched on, [Filter] will automatically switch to [ST] if it is not [Diagnostic] or [ST]. When ST segment analysis is switched off, the filter mode automatically switches to the previous manual setting.

However, if you switch [Filter] to [Monitor] or [Surgery], ST segment analysis will turn off automatically. In case that you change [Monitor] or [Surgery] to [Diagnostic] or [ST], ST segment analysis keeps off, you can turn it on manually.

NOTE

- **When the filter mode is switched to [Diagnostic], the notch filter automatically switches to [Off]. In this case, you can still set the notch filter to [On] manually.**
 - **When the filter mode is [Monitor], [Surgery] or [ST], the notch filter is fixed to [On], and can not be changed.**
-

8.6.3 Understanding the ST Display

8.6.3.1 ST Segment

ST segment shows a QRS complex segment for each measured ST lead. The current ST segment is drawn in the same color as the ECG wave, usually green, superimposed over the stored reference segment, drawn in a different color. The information is updated once every ten seconds.

To display the ST segment on normal screen:

1. Enter the [ST Analysis] menu. Set [ST Analysis] to [On].
2. Enter the [Screen Setup] window of the [Screens] menu. Set [ST Segment] to be displayed.

Select the ST parameter window or ST segment area and you can enter the **[ST Analysis]** menu.

8.6.4 Saving the Current ST Segment as Reference

Select **[Save Ref.]** in the **[ST Analysis]** menu to save the current segment as reference. Up to 20 reference segment groups can be saved.

NOTE

- **If the memory is full and you do not delete a group before saving a new one, the oldest saved group is deleted automatically.**
-

8.6.5 Changing the Reference Segment

Select the  and  arrow keys beside the **[Change Ref.]** to switch between different reference segment groups.

8.6.6 Deleting a Reference Segment

To delete the current ST reference segment, select **[Delete Ref.]** in the **[ST Analysis]** menu and then select **[Ok]** in the popup.

8.6.7 Recording the ST Segment

To record the current ST segment and reference segment, select **[Record]** in the **[ST Analysis]** menu.

8.6.8 Changing the ST Alarm Limits

High and low ST alarm limits can be set individually for each ECG lead. Alarm limits can also be set separately for single-lead and multi-lead ST monitoring. You can select **[ST Alarm Setup >>]** from the **[ST Analysis]** menu and then change the ST alarm settings for each lead.

8.6.9 Setting the ST Alarm Delay Time

You can set the ST alarm delay time from the **[Others]** window of the **[Alarm Setup]** menu.

8.6.10 Adjusting ST Measurement Points

As shown in the figure below, the ST measured for each beat complex is the vertical difference between two measurement points with the R-wave peak as the baseline for the measurement.

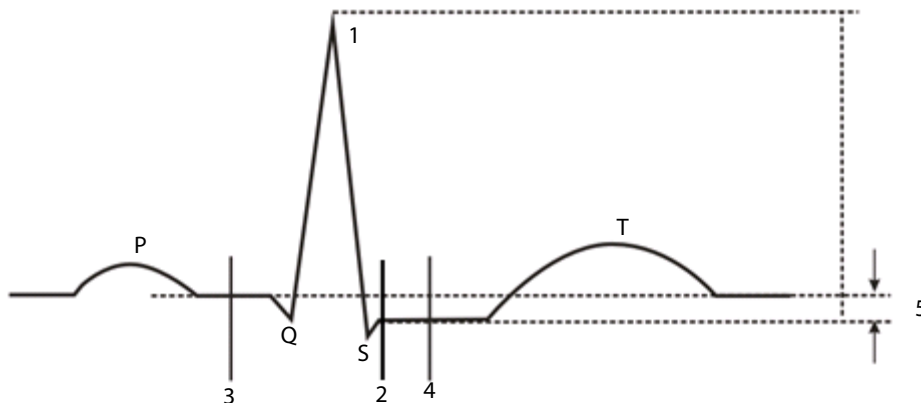

1. R-wave peak
2. J point
3. Isoelectric point
4. ST measurement point
5. Difference=ST value

The ISO and ST points need to be adjusted when you start monitoring or if the patient's heart rate or ECG morphology changes significantly. Exceptional QRS complexes are not considered for ST segment analysis.

WARNING

- **Always make sure that the positions of ST measurement points are appropriate for your patient.**
-

To adjust the ST measurement points:

1. In the [**ST Analysis**] menu, select [**Adjust ST Point >>**]. In the [**Adjust ST Point**] window, three vertical lines represent the ISO, J and ST point positions respectively.
2. Select [**View Leads**] and use the Knob to select an ECG lead with obvious J point and R wave.
3. Select [**ISO**], [**J**] or [**ST Point**] and then use the Knob to adjust the position of each point.
 - ◆ The ISO-point (isoelectric) position is given relative to the R-wave peak. Position the ISO-point in the middle of the flattest part of the baseline (between the P and Q waves).
 - ◆ The J-point position is given relative to the R-wave peak and helps in locating the ST-point. Position the J-point at the end of the QRS complex and the beginning of the ST segment.
 - ◆ The ST-point is positioned a fixed distance from the J-point. Move the J-point to position the ST-point at the midpoint of the ST segment. Position the ST-point relative to the J-point at either [**J+60/80ms**], [**J+40ms**], [**J+60ms**] or [**J+80ms**]. When [**J+60/80ms**] is selected, the ST-point will be positioned 80 ms (heart rate 120 bpm or less) or 60 ms (heart rate more than 120 bpm) from the J-point.

8.7 About Arrhythmia Monitoring

Arrhythmia analysis provides information about your patient's condition, including heart rate, PVC rate, rhythm and ectopics.



WARNING

- **The arrhythmia analysis program is intended to detect ventricular arrhythmias. It is not designed to detect atrial or supraventricular arrhythmias. It may incorrectly identify the presence or absence of an arrhythmia. Therefore, a physician must analyze the arrhythmia information with other clinical findings.**

8.7.1 Understanding the Arrhythmia Events

Arrhythmia message	Description	Category
Asystole	No QRS detected within the set time threshold in absence of ventricular fibrillation or chaotic signal.	Lethal arrhythmia
Vfib/Vtac	A fibrillatory wave for 6 consecutive seconds. A dominant rhythm of adjacent Vs and a HR > the V-Tac HR limit.	
Vtac	The consecutive PVCs \geq Vtac PVCs limit, and the HR \geq the Vtac rate limit.	
Vent. Brady	The consecutive PVCs \geq the Vbrd threshold and the ventricular HR < the Vbrd Rate threshold.	
Extreme Tachy	The heart rate is equal to or greater than the extreme tachycardia limit.	
Extreme Brady	The heart rate is equal to or less than the extreme bradycardia limit.	
PVCs	PVCs/min exceeds high limit	Nonlethal arrhythmia
Pacer not paced	No pace pulse detected for 1.75 x average R-to-R intervals following a QRS complex (for paced patients only).	
Pacer not capture	No QRS complex detected for 300 milliseconds following a pace pulse (for paced patients only).	
PVC	One PVC detected in normal heartbeats.	
Couplet	Paired PVCs detected in normal heartbeats.	
VT > 2	More than 2 consecutive PVCs.	
Bigeminy	A dominant rhythm of N, V, N, V, N, V.	
Trigeminy	A dominant rhythm of N, N, V, N, N, V, N, V.	
R on T	R on T detected in normal heartbeats.	
Missed Beats	No beat detected for 1.75 x average R-R interval for HR < 120, or No beat for 1 second with HR > 120 (for non-paced patients only), or No beat detected for more than the set pause threshold.	
Brady	The average heart rate is equal to or less than the bradycardia limit.	
Tachy	The average heart rate is equal to or greater than the tachycardia limit.	
Vent. Rhythm	The consecutive PVCs \geq the Vbrd PVCs limit, and the HR \geq Vbrd Rate limit but < the Vtac Rate limit.	
Multif. PVC	Multiform PVCs detected in Multif. PVC's Window (which is adjustable).	
Nonsus. Vtac	The consecutive PVCs < the Vtac PVCs limit but > 2, and HR \geq the Vtac Rate limit.	
Pause	No QRS detected within the set time threshold of pause.	
Irr. Rhythm	Consistently irregular rhythm.	

8.7.2 Changing Arrhythmia Alarm Settings

To change arrhythmia alarm settings, select the ECG parameter area or waveform area → [ECG Setup] → [Arrh. Analysis >>]. In the pop-up menu, you can set the [Alm Lev] to [High], [Med], [Low] or [Message], or switch on lethal arrhythmia analysis alarms only or switch on/off all arrhythmia analysis alarms. In the [Alarm Setup] menu from the [User Maintenance] menu, you can enable/disable turning off lethal arrhythmia analysis alarms.

 **WARNING**

- **If you switch off all arrhythmia analysis alarms, the monitor cannot give any arrhythmia analysis alarm. Always keep the patient under close surveillance.**
-

8.7.3 Changing Arrhythmia Threshold Settings

Select the ECG parameter window or waveform area → [Arrh. Analysis >>] → [Arrh. Threshold], and you can then change threshold settings for some arrhythmia alarms. In case an arrhythmia violates its threshold, an alarm will be triggered. The asystole delay time relates to ECG relearning. When HR is less than 30 bpm, it is recommended to set the asystole delay time to 10 seconds.

Arrh. event	Range	Default	Step	Unit
PVCs High	1 to 100	10	1	/min
Asys. Delay	3 to 10	5	1	s
Tachy High	60 to 300	180	5	bpm
Brady Low	15 to 120	90	5	bpm
Extreme Tachy	120 to 300	200	5	bpm
Extreme Brady	15 to 60	60	5	bpm
Multif. PVC's Window	3 to 31	15	1	/min
Vtac Rate	100 to 200	160	5	bpm
Vtac PVCs	3 to 99	6	1	/min
Pause Time	1.5, 2.0, 2.5	2	/	s
Vbrd PVCs	3 to 99	5	1	/min
Vbrd Rate	15 to 60	40	5	bpm

8.7.4 Setting the Extended Arrhythmia

The following arrhythmia events are defined as extended arrhythmia:

- Extreme Tachy
- Extreme Brady
- Vent. Brady
- Nonsus. Vtac
- Multif. PVC
- Irr. Rhythm
- Pause

You can select [Main Menu] → [Maintenance >>] → [User Maintenance >>] → enter the required password → select [Alarm Setup >>], and set [Extended Arrh.] to [Enable] or [Disable]. When [Extended Arrh.] is set to [Disable], the monitor does not analyze the extended arrhythmia events and corresponding alarms are not given.

 **CAUTION**

- **Set [Extended Arrh.] to [Disable] when the monitor is connected to the Central Monitoring System of version prior to 06.01.00. Failure to do so may cause the Central Monitoring System to be unable to display extended arrhythmia related alarms normally when extended arrhythmia occurs.**
-

8.7.5 Reviewing Arrhythmia Events

Please refer to the *Review* chapter.

8.8 ECG Relearning

8.8.1 Initiating an ECG Relearning Manually

During ECG monitoring, you may need to initiate an ECG relearning when the patient's ECG template changes dramatically. A change in the ECG template could result in:

- incorrect arrhythmia alarms
- loss of ST measurement, and/or
- inaccurate heart rate

ECG relearning allows the monitor to learn the new ECG template so as to correct arrhythmia alarms and HR value, and restore ST measurements. To initiate relearning manually, select the ECG parameter window or waveform area → **[Relearn]**. When the monitor is learning, the message **[ECG Learning]** is displayed in the technical alarm area.

 **CAUTION**

- **Take care to initiate ECG relearning only during periods of normal rhythm and when the ECG signal is relatively noise-free. If ECG learning takes place during ventricular rhythm, the ectopics may be incorrectly learned as the normal QRS complex. This may result in missed detection of subsequent events of V-Tach and V-Fib.**
-

8.8.2 Automatic ECG Relearning

ECG relearning is initiated automatically whenever:

- The ECG lead or lead label is changed
- The ECG lead is re-connected
- A new patient is admitted
- After ECG calibration is completed and the ECG module switches to normal measurement mode by selecting **[Stop Calibrating ECG]**
- A switch happens between the options of screen type during 5-lead ECG monitoring.
- The paced status of the patient is changed.

9 Monitoring Respiration (Resp)

9.1 Introduction

Impedance respiration is measured across the thorax. When the patient is breathing or ventilated, the volume of air changes in the lungs, resulting in impedance changes between the electrodes. Respiration rate (RR) is calculated from these impedance changes, and a respiration waveform appears on the monitor screen.

9.2 Safety Information

Warning

- When monitoring the patient's respiration, do not use ESU-proof ECG cables.
 - If you do not set the detection level for the respiration correctly in manual detection mode, it may not be possible for the monitor to detect apnea. If you set the detection level too low, the monitor is more likely to detect cardiac activity, and to falsely interpret cardiac activity as respiratory activity in the case of apnea.
 - The respiration measurement does not recognize the cause of apneas. It only indicates an alarm if no breath is detected when a pre-adjusted time has elapsed since the last detected breath. Therefore, it cannot be used for diagnostic purpose.
 - If operating under conditions according to the EMC Standard EN 60601-1-2 (Radiated Immunity 3V/m), field strengths above 1V/m may cause erroneous measurements at various frequencies. Therefore it is recommended to avoid the use of electrically radiating equipment in close proximity to the respiration measurement unit.
-

9.3 Understanding the Resp Display

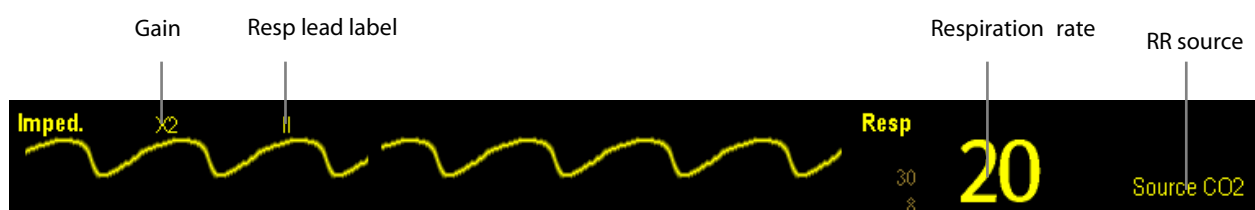

By selecting the waveform area or parameter area, you can enter the [Resp Waveform] menu. By selecting the Resp parameter window, you can enter the [Resp Setup] menu.

NOTE

- Respiration monitoring is not for use on patients who are very active, as this will cause false alarms.
-

9.4 Placing Resp Electrodes

Since the same leads are used for ECG and respiration monitoring, the lead placement is very important. Some patients, due to their clinical condition, expand their chest laterally, causing a negative intrathoracic pressure. In these cases it is better to place the two crocodile clips used for respiration monitoring laterally in the right axillary and left lateral chest areas, at the maximum point of the breathing movement, to optimize the respiratory waveform.

NOTE

- Please select the ECG cable with no resistance for RESP monitoring.
 - To optimize the respiration waveform, place the RA and LA electrodes horizontally when monitoring respiration with ECG Lead I; place the RA and LL electrodes diagonally when monitoring respiration with ECG Lead II.
 - Place the electrodes to try to avoid crossing the liver area and the ventricles of the heart with the electrodes line.
-

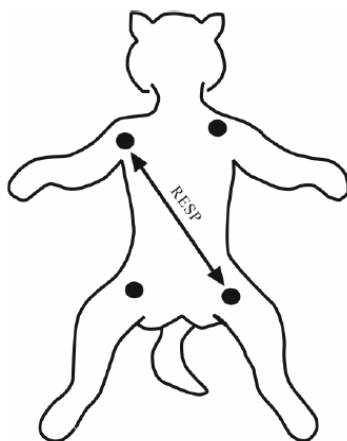

Lead placement (5-lead)

9.4.1 Optimizing Lead Placement for Resp

If you want to measure Resp and you are already measuring ECG, you may need to optimize the placement of the two electrodes between which Resp will be measured. Repositioning ECG electrodes from standard positions results in changes in the ECG waveform and may influence ST and arrhythmia interpretation.

9.4.2 Cardiac Overlay

Cardiac activity that affects the Resp waveform is called cardiac overlay. It happens when the Resp electrodes pick up impedance changes caused by the rhythmic blood flow. Correct electrodes placement can help to reduce cardiac overlay: avoid the liver area and the ventricles of the heart in the line between the respiratory electrodes.

9.4.3 Abdominal Breathing

Some patients with restricted movement breathe mainly abdominally. In these cases, you may need to place the left leg electrode on the left abdomen at the point of maximum abdominal expansion to optimise the respiratory wave.

9.4.4 Lateral Chest Expansion

In clinical applications, some patients expand their chests laterally, causing a negative intrathoracic pressure. In these cases, it is better to place the two respiration electrodes in the right midaxillary and the left lateral chest areas at the patient's maximum point of the breathing movement to optimize the respiratory waveform.

9.5 Choosing the Respiration Lead

In the **[Resp Setup]** menu, set **[Resp Lead]** to **[I]**, **[II]** or **[Auto]**.

9.6 Changing the Apnea Alarm Delay

The apnea alarm is a high-level alarm used to detect apneas. You can set the apnea alarm delay time after which the monitor alarms if the patient stops breathing. In the **[Resp Setup]** menu, select **[Apnea Delay]** and then select the appropriate setting. The **[Apnea Delay]** of Resp and CO₂ module keeps consistent with each other.



9.7 Changing Resp Detection Mode

In the **[Resp Setup]** menu, select **[Detection Mode]** and toggle between **[Auto]** and **[Manual]**.

- In auto detection mode, the monitor adjusts the detection level automatically, depending on the wave height and the presence of cardiac artifact. Note that in auto detection mode, the detection level (a dotted line) is not displayed on the waveform.

Use auto detection mode for situations where:

- ◆ The respiration rate is not close to the heart rate.
- ◆ Breathing is spontaneous, with or without continuous positive airway pressure (CPAP).
- ◆ Patients are ventilated, except patients with intermittent mandatory ventilation (IMV).

- In manual detection mode, you adjust the dotted detection level line to the desired level by selecting **[Upper Line]** or **[Lower Line]** and then selecting  or  beside them. Once set, the detection level will not adapt automatically to different respiration depths. It is important to remember that if the depth of breathing changes, you may need to change the detection level.

Use manual detection mode for situations where:

- ◆ The respiration rate and the heart rate are close.
- ◆ Patients have intermittent mandatory ventilation.
- ◆ Respiration is weak. Try repositioning the electrodes to improve the signal.

In Auto Detection Mode, if you are monitoring Resp and ECG is switched off, the monitor cannot compare the ECG and Resp rates to detect cardiac overlay. The respiration detection level is automatically set higher to prevent the detection of cardiac overlay as respiration.

In Manual Detection Mode, cardiac overlay can in certain situations trigger the respiration counter. This may lead to a false indication of a high respiration or an undetected apnea condition. If you suspect that cardiac overlay is being registered as breathing activity, raise the detection level above the zone of cardiac overlay. If the Resp wave is so small that raising the detection level is not possible, you may need to optimize the electrode placement as described in the section "Lateral Chest Expansion".

9.8 Changing Resp Wave Settings



- **When monitoring in manual detection mode, make sure to check the respiration detection level after you have increased or decreased the size of the respiration wave.**
-

In the **[Resp Setup]** menu, you can:

- Select **[Gain]** and then select an appropriate setting. The bigger the gain is, the larger the wave amplitude is.
- Select **[Sweep]** and then select an appropriate setting. The faster the wave sweeps, the wider the wave is.

9.9 Setting RR Source

To set RR source:

1. Enter the **[Resp Setup]** menu.
2. Select **[RR Source]** and then select a source or **[Auto]** from the dropdown list.

The dropdown list displays the currently available RR source. When you select **[Auto]**, the system will automatically select the RR source according to the priority. When the current RR source does not have valid measurement, the system will automatically switch the **[RR Source]** to **[Auto]**. RR source switches back to the valid source if you press the  silence hardkey on the monitor's front during an apnea alarm.

The priority of RR source is (from high to low): CO₂ measurement and impedance respiration measurement. The **[RR Source]** settings of Resp and CO₂, are linked.

The RR source options and description are shown in the table below.

Option	Description
Auto	RR source is automatically selected according to the priority.
CO ₂	RR source is from CO ₂ measurement.
ECG	RR source is from impedance respiration measurement.

9.10 Setting alarm properties

Select **[Alarm Setup >>]** from the **[Resp Setup]** menu. In the popup menu, you can set alarm properties for this parameter.

9.11 Switching Resp Measurement On/Off

To switch Resp measurement on, select **[Imped. Resp Measure. ON]** from the **[Resp Setup]** menu. To switch Resp measurement off, select **[Imped. Resp Measure. OFF]** from the **[Resp Setup]** menu and then select **[Yes]** from the popup dialog box. A line is displayed in the waveform area and no numeric but the **[Measurement OFF]** message is displayed in the parameter area.

10 Monitoring PR

10.1 Introduction

The pulse numeric counts the arterial pulsations that result from the mechanical activity of the heart. You can display a pulse from any measured SpO₂ or any arterial pressure (see the IBP section). The displayed pulse numeric is color-coded to match its source.



1. PR Source
2. PR: detected beats per minute.

10.2 Setting the PR Source

The current pulse source is displayed in the PR parameter area. The pulse rate chosen as pulse source:

- is monitored as system pulse and generates alarms when you select PR as the active alarm source;
- is stored in the monitor's database and reviewed in the graphic/tabular trends; in trend graphs, as the PR curve is in the same color with the PR source, it is unlikely to distinguish the PR source;
- is sent via the network to the central monitoring system, if available.

To set which pulse rate as PR source:

1. Enter the **[SpO₂ Setup]** menu.
2. Select **[PR Source]** and then select a label or **[Auto]** from the popup menu.

The popup menu displays the currently available PR sources from top to bottom by priority. When you select **[Auto]**, the system will automatically select the first option as the PR source from the popup menu. When the current PR source is unavailable, the system will automatically switch **[PR Source]** to **[Auto]**. When you select **[IBP]**, the system will automatically select the first pressure label as the PR source from the popup menu.

10.3 Selecting the Active Alarm Source

In most cases the HR and pulse numerics are identical. In order to avoid simultaneous alarms on HR and Pulse, the monitor uses either HR or Pulse as its active alarm source. To change the alarm source, select **[Alm Source]** in the **[ECG Setup]** or **[SpO₂ Setup]** menu and then select either:

- **[HR]**: The monitor will use the HR as the alarm source for HR/pulse.
- **[PR]**: The monitor will use the PR as the alarm source for HR/pulse.
- **[Auto]**: If the **[Alm Source]** is set to **[Auto]**, the monitor will use the heart rate from the ECG measurement as the alarm source whenever the ECG measurement is switched on and a valid heart rate is available. If the heart rate becomes unavailable, for example if leads become disconnected, and a pulse source is switched on and available, the monitor will automatically switch to Pulse as the alarm source. When the Leads Off condition is corrected, the monitor will automatically switch back to the heart rate as the alarm source.

10.4 QRS Tone

When PR is used as the alarm source, the PR source will be used as a source for the QRS tone. You can change the QRS volume by adjusting **[Beat Vol]** in the **[SpO₂ Setup]** menu. When a valid SpO₂ value exists, the system will adjust the pitch tone of QRS volume according to the SpO₂ value.

11 Monitoring SpO₂

11.1 Introduction

SpO₂ monitoring is a non-invasive technique used to measure the amount of oxygenated hemoglobin and pulse rate by measuring the absorption of selected wavelengths of light. The light generated in the probe passes through the tissue and is converted into electrical signals by the photodetector in the probe. The SpO₂ module processes the electrical signal and displays a waveform and digital values for SpO₂ and pulse rate.

This device is calibrated to display functional oxygen saturation. It provides four measurements:

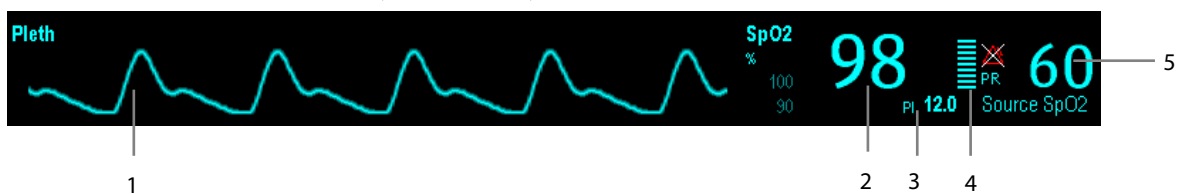

1. Pleth waveform (Pleth): visual indication of patient's pulse. The waveform is not normalized.
2. Oxygen saturation of arterial blood (SpO₂): percentage of oxygenated hemoglobin in relation to the sum of oxyhemoglobin and deoxyhemoglobin.
3. Perfusion index (PI): gives the numerical value for the pulsatile portion of the measured signal caused by arterial pulsation. PI is an indicator of the pulsatile strength. You can also use it to assess the quality of SpO₂ measurement. Above 1 is optimal, between 0.3 and 1 is acceptable. Below 0.3 indicates low perfusion; reposition the SpO₂ sensor or find a better site. If low perfusion persists, choose another method to measure oxygen saturation if possible. PI is available for the Mindray SpO₂ module or the Masimo SpO₂ module.
4. Perfusion indicator: the pulsatile portion of the measured signal caused by arterial pulsation.
5. Pulse rate (derived from pleth wave): detected pulsations per minute.

11.2 Safety



WARNING

- **Use only SpO₂ sensors specified in this manual. Follow the SpO₂ sensor's instructions for use and adhere to all warnings and cautions.**
 - **When a trend toward patient deoxygenation is indicated, blood samples should be analyzed by a laboratory co-oximeter to completely understand the patient's condition.**
 - **Do not use SpO₂ sensors during magnetic resonance imaging (MRI). Induced current could potentially cause burns. The sensor may affect the MRI image, and the MRI unit may affect the accuracy of the oximetry measurements.**
 - **Prolonged continuous monitoring may increase the risk of undesirable changes in skin characteristics, such as irritation, reddening, blistering or burns. Inspect the sensor site every two hours and move the sensor if the skin quality changes. Change the application site every four hours. For patients with poor peripheral blood circulation or sensitive skin, inspect the sensor site more frequently.**
-

11.3 Identifying SpO₂ Modules

To identify which SpO₂ module is incorporated into your monitor, see the color of the SpO₂ connector and the company logo located at the monitor. The color of the cable connector matches the company as shown below:

- Mindray SpO₂ module: a blue connector without logo.
- Masimo SpO₂ module: a purple connector with a logo of Masimo SET.
- Nellcor SpO₂ module: a grey connector with a logo of Nellcor.

The connectors for these three SpO₂ sensors are mutually exclusive.

NOTE

- **The Mindray SpO₂ module is not available in North America. The Masimo SpO₂ module is available in North America only.**
-

11.4 Applying the Sensor

1. Select an appropriate sensor according to the module type, patient category and weight.
2. Remove colored nail polish from the application site.
3. Apply the sensor to the patient.
4. Select an appropriate adapter cable according to the connector type and plug this cable into the SpO₂ connector.
5. Connect the sensor cable to the adapter cable.

Tongue Sensor Placement

You can easily place the tongue sensor as shown below.

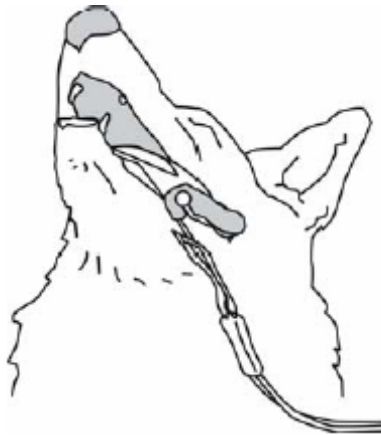

NOTE

-
- **Be sure that the sensor cable is positioned along the side of the animal's face and body to avoid entanglement with the animal.**
-

11.5 Changing SpO₂ Settings

11.5.1 Accessing SpO₂ Menus

By selecting the SpO₂ parameter window or waveform area, you can access the **[SpO₂ Setup]** menu.

11.5.2 Adjusting the Desat Alarm

The desat alarm is a high level alarm notifying you of potentially life threatening drops in oxygen saturation. Select **[Alarm Setup >>]** from the **[SpO₂ Setup]** menu. From the popup menu, you can set low alarm limit, alarm switch, and alarm recording for **[Desat]**. When the SpO₂ value is below the desat alarm limit and the desat alarm switch is set on, the message **[SpO₂ Desat]** is displayed.

11.5.3 Setting SpO₂ Sensitivity

For the Masimo SpO₂ module, you can set **[Sensitivity]** to **[Normal]** or **[Maximum]** in the **[SpO₂ Setup]** menu. When the **[Sensitivity]** is set to **[Maximum]**, the monitor is more sensitive to minor signals. When monitoring critically ill patients whose pulsations are very weak, it is strongly recommended that the sensitivity is set to **[Maximum]**. When monitoring neonatal or non-critically ill patients who tend to move a lot, noise or invalid signals may be caused. In this case, it is recommended that the sensitivity is set to **[Normal]** so that the interference caused by motion can be filtered and therefore the measurement stability can be ensured.

11.5.4 Changing Averaging Time

The SpO₂ value displayed on the monitor screen is the average of data collected within a specific time. The shorter the averaging time is, the quicker the monitor responds to changes in the patient's oxygen saturation level. Conversely, the longer the averaging time is, the slower the monitor responds to changes in the patient's oxygen saturation level, but the measurement accuracy will be improved. For critically ill patients, selecting a shorter averaging time will help in understanding the patient's state.

To set the averaging time:

- For the Mindray SpO₂ module, select **[Sensitivity]** in the **[SpO₂ Setup]** menu and then toggle between **[High]**, **[Med]** and **[Low]**, which respectively correspond to 7 s, 9 s and 11 s.
- For the Masimo SpO₂ module, select **[Averaging]** in the **[SpO₂ Setup]** menu and then toggle between **[2-4 s]**, **[4-6 s]**, **[8 s]**, **[10 s]**, **[12 s]**, **[14 s]** and **[16 s]**.

11.5.5 Monitoring SpO₂ and NIBP Simultaneously

When monitoring SpO₂ and NIBP on the same limb simultaneously, you can switch **[NIBP Simul]** on in the **[SpO₂ Setup]** menu to lock the SpO₂ alarm status until the NIBP measurement ends. If you switch **[NIBP Simul]** off, low perfusion caused by NIBP measurement may lead to inaccurate SpO₂ readings and therefore cause false physiological alarms.

11.5.6 Sat-Seconds Alarm Management

With traditional alarm management, high and low alarm limits are set for monitoring oxygen saturation. During monitoring, as soon as an alarm limit is violated, an audible alarm immediately sounds. When the patient % SpO₂ fluctuates near an alarm limit, the alarm sounds each time the limit is violated. Such frequent alarms can be distracting. Nellcor's Sat-Seconds alarm management technique is used to reduce these nuisance alarms.

The Sat-Seconds feature is available with the Nellcor SpO₂ module to decrease the likelihood of false alarms caused by motion artifacts. To set the Sat-Seconds limit, select **[Sat-Seconds]** in the **[SpO₂ Setup]** menu and then select the appropriate setting.

With Sat-Seconds alarm management, high and low alarm limits are set in the same way as traditional alarm management. A Sat-Seconds limit is also set. The Sat-Seconds limit controls the amount of time that SpO₂ saturation may be outside the set limits before an alarm sounds. The method of calculation is as follows: the number of percentage points that the SpO₂ saturation falls outside the alarm limit is multiplied by the number of seconds that it remains outside the limit. This can be stated as the equation:

Sat-Seconds= Points × Seconds

Only when the Sat-Seconds limit is reached, the monitor gives a Sat-Seconds alarm. For example, the figure below demonstrates the alarm response time with a Sat-Seconds limit set at 50 and a low SpO₂ limit set at 90%. In this example, the patient % SpO₂ drops to 88% (2 points) and remains there for 2 seconds. Then it drops to 86% (4 points) for 3 seconds, and then to 84% (6 points) for 6 seconds. The resulting Sat-Seconds are:

% SpO ₂	Seconds	Sat-Seconds
2×	2=	4
4×	3=	12
6×	6=	36
Total Sat-Seconds=		52

After approximately 10.9 seconds, a Sat-Second alarm would sound, because the limit of 50 Sat-Seconds would have been exceeded.

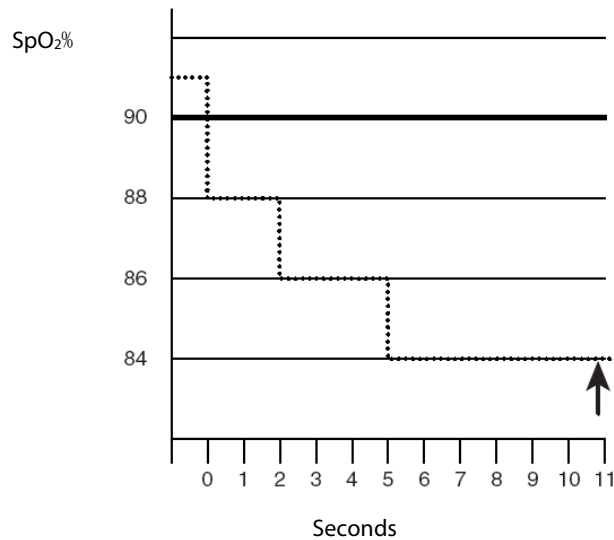

Saturation levels may fluctuate rather than remaining steady for a period of several seconds. Often, the patient % SpO₂ may fluctuate above and below an alarm limit, re-entering the non-alarm range several times. During such fluctuation, the monitor integrates the number of % SpO₂ points, both positive and negative, until either the Sat-Seconds limit is reached, or the patient % SpO₂ re-enters the non-alarm range and remains there.

11.5.7 Changing the Speed of the Pleth Wave

In the **[SpO₂ Setup]** menu, select **[Sweep]** and then select the appropriate setting. The faster the waveform sweeps, the wider the waveform is.

11.5.8 Setting the Alarm Level for SpO₂ Sensor Off Alarm

Select **[Alarm Setup >>]** from the **[User Maintenance]** menu. You can set the **[SpO₂SensorOff Lev.]** in the popup menu.

11.5.9 Setting the SpO₂ Tone Mode

Select [Others >>] from the [User Maintenance] menu. In the popup menu, you can set [SpO₂ Tone] as [Mode 1] or [Mode 2].

 **WARNING**

-
- **The same SpO₂ tone mode shall be used for the same monitors in a single area.**
-

11.6 Measurement Limitations

If you doubt the measured SpO₂, check patient vital signs first. Then check the monitor and SpO₂ sensor. The following factors may influence the accuracy of measurement:

- Ambient light
- Physical movement (patient and imposed motion)
- Diagnostic testing
- Low perfusion
- Electromagnetic interference, such as MRI environment
- Electrosurgical units
- Dysfunctional hemoglobin, such as carboxyhemoglobin (COHb) and methemoglobin (MetHb)
- Presence of certain dyes, such as methylene and indigo carmine
- Inappropriate positioning of the SpO₂ sensor, or use of incorrect SpO₂ sensor
- Drop of arterial blood flow to immeasurable level caused by shock, anemia, low temperature or vasoconstrictor.

11.7 Masimo Information



- Masimo Patents

This posting serves as notice under 35 U.S.C. §287(a) for Masimo patents: <http://www.masimo.com/patents.htm>.

- No Implied License

Possession or purchase of this device does not convey any express or implied license to use the device with unauthorized sensors or cables which would, alone, or in combination with this device, fall within the scope of one or more of the patents relating to this device.

11.8 Nellcor Information



- Nellcor Patents

This posting serves as notice under 35 U.S.C. § 287(a) for Covidien patents: <http://www.covidien.com/patents>.

- No Implied License

Possession or purchase of this device does not convey any express or implied license to use the device with unauthorized replacement parts which would, alone, or in combination with this device, fall within the scope of one or more of the patents relating to this device.

FOR YOUR NOTES

12 Monitoring NIBP

12.1 Introduction

The monitor uses the oscillometric method for measuring non-invasive blood pressure (NIBP).

Automatic non-invasive blood pressure monitoring uses the oscillometric method of measurement. To understand how this method works, we'll compare it to the auscultative method. With auscultation, the clinician listens to the blood pressure and determines the systolic and diastolic pressures. The mean pressure can then be calculated with reference to these pressures as long as the arterial pressure curve is normal.

Since the monitor cannot hear blood pressure, it measures cuff pressure oscillation amplitudes. Oscillations are caused by blood pressure pulses against the cuff. The oscillation with the greatest amplitude is the mean pressure. This is the most accurate parameter measured by the oscillometric method. Once the mean pressure is determined, the systolic and diastolic pressures are calculated with reference to the mean.

Simply stated, auscultation measures systolic and diastolic pressures and the mean pressure is calculated. The oscillometric method measures the mean pressure and determines the systolic and diastolic pressures.

As specified by IEC 60601-2-30/EN60601-2-30, NIBP measurement can be performed during electro-surgery and discharge of defibrillator.

NIBP diagnostic significance must be decided by the doctor who performs the measurement.

NOTE

-
- **Blood pressure measurements determined with this device are equivalent to those obtained by a trained observer using the cuff/stethoscope auscultatory method or an intra-arterial blood pressure measurement device, within the limits prescribed by the American National Standard, Manual, electronic, or automated sphygmomanometers.**
-

12.2 Safety



WARNING

- **Be sure to select the correct patient category setting for your patient before measurement. Do not measure NIBP on patients with sickle-cell disease or any condition where skin damage has occurred or is expected.**
 - **Use clinical judgement to determine whether to perform frequent unattended blood pressure measurements on patients with severe blood clotting disorders because of the risk of hematoma in the limb fitted with the cuff.**
 - **Do not use the NIBP cuff on a limb with an intravenous infusion or arterial catheter in place. This could cause tissue damage around the catheter when the infusion is slowed or blocked during cuff inflation.**
 - **If you doubt the NIBP readings, determine the patient's vital signs by alternative means and then verify that the monitor is working correctly.**
-

12.3 Measurement Limitations

Measurements are impossible with heart rate extremes of less than 40bpm or greater than 240bpm, or if the patient is on a heart-lung machine.

The measurement may be inaccurate or impossible:

- If a regular arterial pressure pulse is hard to detect
- With excessive and continuous patient movement such as shivering or convulsions
- With cardiac arrhythmias
- With rapid blood pressure changes
- With severe shock or hypothermia that reduces blood flow to the peripheries
- With obesity, where a thick layer of fat surrounding a limb dampens the oscillations coming from the artery

12.4 Measurement Methods

There are three methods of measuring NIBP:

- Manual: measurement on demand.
- Auto: continually repeated measurements at set intervals.
- STAT: continually rapid series of measurements over a five minute period, then return to the previous mode.

12.5 Setting Up the NIBP Measurement

12.5.1 Preparing to Measure NIBP

1. Power on the monitor.
2. Verify that the patient category is correct. Change it if necessary.
3. Plug the air tubing into the NIBP connector on the monitor.
4. Select a correct sized cuff and then apply it as follows:
 - ◆ Determine the patient's limb circumference.
 - ◆ Select an appropriate cuff by referring to the limb circumference marked on the cuff. The width of the cuff should be 50% of the limb circumference, or 2/3 of the upper arm's length. The inflatable part of the cuff should be long enough to encircle at least 50% to 80% of the limb.
 - ◆ Apply the cuff to an upper arm or leg of the patient and make sure the Φ marking on the cuff matches the artery location. Do not wrap the cuff too tightly around the limb. It may cause discoloration, and ischemia of the extremities. Make sure that the cuff edge falls within the marked range. If it does not, use a larger or smaller cuff that will fit better.
5. Connect the cuff to the air tubing and make sure that the air tubing is not compressed and twisted.

NOTE

-
- **The use of the equipment is restricted to one patient at a time.**
-

Details about the cuff sites on different animals are as follows.

■ For a FELINE

For conscious patients, measurements from the coccygeal artery can be taken by wrapping the cuff around the base of the tail. For anesthetized patients, measurements from the median artery on the foreleg can be used by wrapping the cuff around the forelimb, between the elbow and carpus. For felines less than five pounds or when measurements are difficult to obtain, place the cuff around the leg above the elbow to obtain measurements from the brachial artery. Hair need not be clipped except when heavily matted.

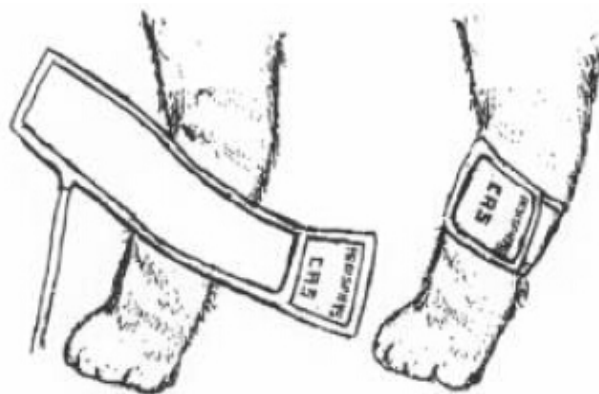

Feline cuff placement

■ For a CANINE

For measurements in canines, it is preferable to use the right lateral, sternal or dorsal recumbent position. If the canine is in a sitting position, place the front paw on the operator's knee and take measurements from the metacarpus.

The metacarpus, metatarsus and anterior tibial are recommended for the cuff placement. For anesthetized patients, most surgeries are done on the posterior part of the body so the metacarpal area of the forelimb is most convenient. In situations where this is not possible, place the cuff around the metatarsus just proximal to the tarsal pad or around the hind leg next to the hock. For conscious patients, measurements from the coccygeal artery can be used over the tail site.



Canine cuff placement

- For larger animals

It is preferable for a large animal, such as a horse or a cow, to be in a stock, standing still. Measurements from the coccygeal artery on the ventral surface may be used by placing the cuff around the base of the tail.

NOTE

-
- **The limb chosen for taking the measurement should be placed at the same level as the patient's heart**
 - **If the animal's hair over the artery site is too thick or matted for good contact, it should be clipped.**
-

12.5.2 Starting and Stopping Measurements

Select the **[NIBP Measure]** QuickKey and you can start the desired measurement from the popup menu. You can select the **[Stop All]** QuickKey to stop all NIBP measurements. You can also start and stop measurements by using the  hardkey on the monitor's front panel.

12.5.3 Correcting the Measurement if Limb is not at Heart Level

The cuff should be applied to a limb at the same level as the patient's heart. If the limb is not at the heart level, to the displayed value:

- Add 0.75 mmHg (0.10 kPa) for each centimeter higher, or
- Deduct 0.75 mmHg (0.10 kPa) for each centimeter lower.

12.5.4 Enabling NIBP Auto Cycling and Setting the Interval

1. Select the NIBP parameter window to enter the **[NIBP Setup]** menu.
2. Select **[Interval]** and then select a desired time interval. Selecting **[Manual]** switches to manual mode.
3. Start a measurement manually. The monitor will then automatically repeat NIBP measurements at the set time interval.

In auto mode, you can enable the clock function to synchronize the NIBP automatic measurements with the real time clock.

For example, when the clock is enabled, if [Interval] is set to [20min], and then you start NIBP auto measurement at 14:03, the next measurement will be taken at 14:20, and the following measurement time will be 14:40, 15:00, and so on.

To enable the clock, in the [NIBP Setup] menu, set [Clock] to [On].

NOTE

- The clock function is available only when the auto measurement interval is 5 minutes or more.

12.5.5 Starting a STAT Measurement

1. Select the NIBP parameter window to enter the [NIBP Setup] menu.
2. Select [NIBP STAT]. The STAT mode initiates 5 minutes of continuous, sequential, automatic NIBP measurements.

WARNING

- Continuous non-invasive blood pressure measurements may cause purpura, ischemia and neuropathy in the limb with the cuff. Inspect the application site regularly to ensure skin quality and inspect the extremity of the cuffed limb for normal color, warmth and sensitivity. If any abnormality occurs, move the cuff to another site or stop the blood pressure measurements immediately.

12.6 Understanding the NIBP Numerics

The NIBP display shows numerics only as below. Your display may be configured to look slightly different.

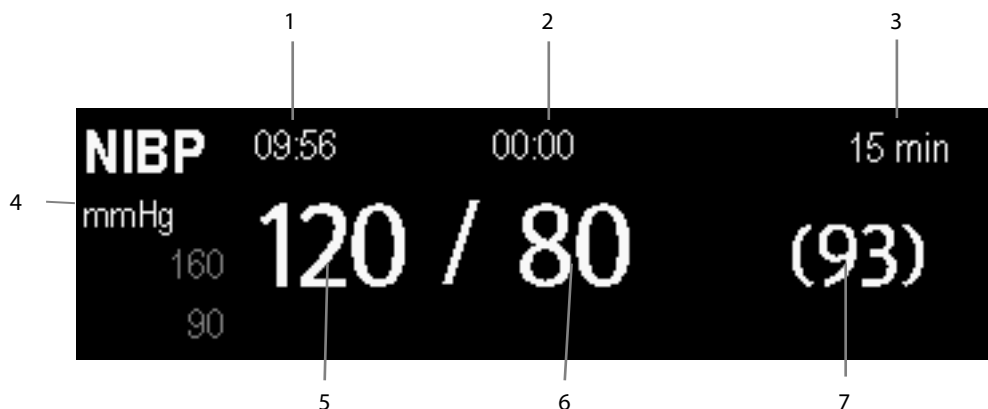

1. Time of last measurement
2. Time remaining to next measurement
3. Measurement mode
4. Unit of pressure: mmHg or kPa
5. Systolic pressure
6. Diastolic pressure
7. Mean pressure obtained after the measurement and cuff pressure obtained during the measurement

12.7 Changing NIBP Settings

By selecting the NIBP parameter window, you can enter the **[NIBP Setup]** menu.

12.7.1 Setting the Initial Cuff Inflation Pressure

You can set the initial cuff inflation pressure manually. In the **[NIBP Setup]** menu, select **[Initial Pressure]** and then select the appropriate setting.

12.7.2 Setting NIBP Alarm Properties

Select **[Alarm Setup >>]** from the **[NIBP Setup]** menu. You can set the alarm properties for this parameter in the popup menu.

12.7.3 Displaying NIBP List

Select the **[Screens]** QuickKey→**[Screen Setup]**. You can set **[NIBP List]** to be displayed at the bottom area of the screen. Then, multiple sets of the most recent NIBP measurements will be displayed. PR displayed is derived from NIBP.

You cannot display **[NIBP List]** in some screens such as the big numerics screen.

12.7.4 Setting the Pressure Unit

Select **[Unit Setup >>]** from the **[User Maintenance]** menu. In the popup menu, select **[Press. Unit]** and toggle between **[mmHg]** and **[kPa]**.

12.7.5 Switching On NIBP End Tone

The monitor can issue a reminder tone at the completion of NIBP measurement. The NIBP End Tone is off by default. You can switch it on by accessing the **[NIBP Setup]** menu.

12.8 Assisting Venous Puncture

You can use the NIBP cuff to cause sub-diastolic pressure to block the venous blood vessel and therefore help venous puncture.

1. Select **[VeniPuncture >>]** from the **[NIBP Setup]** menu. In the popup menu, verify that the **[Cuff Press.]** value is appropriate. Change it if necessary.
2. Select **[VeniPuncture]**.
3. Puncture vein and draw blood sample.
4. Select the  hardkey on the monitor's front, or the **[Stop All]** QuickKey to deflate the cuff. The cuff deflates automatically after a set time if you do not deflate it.

During measurement, the NIBP display shows the inflation pressure of the cuff and the remaining time in venous puncture mode.

13 Monitoring Temp

13.1 Introduction

You can simultaneously monitor two temperature sites using the iMEC monitors.

13.2 Safety



- **Verify that the probe detection program works correctly before monitoring. Unplug the temperature probe cable from the T1 or T2 connector, and the monitor can display the message [T1 Sensor Off] or [T2 Sensor Off] and give alarm tones correctly.**
-

13.3 Making a Temp Measurement

1. Select an appropriate probe for your patient.
2. If you are using a disposable probe, connect the probe to the temperature cable.
3. Plug the probe or temperature cable to the temperature connector.
4. Attach the probe to the patient correctly.
5. Check that the alarm settings are appropriate for this patient.

13.4 Understanding the Temp Display

Temperature monitoring is displayed on the monitor as three numerics: T1, T2 and TD. By selecting this area, you can enter the **[Alarm Setup]** menu.



1. TEMP label: Selecting this label opens the **[Temp Setup]** menu.
2. Temperature unit: °C or °F.
3. T1: Temperature channel 1. Displays the temperature measured at temperature channel 1.
4. T2: Temperature channel 2. Displays the temperature measured at temperature channel 2.
5. TD: Temperature difference, namely the difference between temperature 1 and temperature 2.

13.5 Setting the Temperature Unit

Select **[Unit Setup >>]** from the **[User Maintenance]** menu. In the popup menu, select **[Temp Unit]** and toggle between **[°C]** and **[°F]**

14 Monitoring IBP

14.1 Introduction

The monitor can monitor up to 2 invasive blood pressures and displays the systolic, diastolic and mean pressures and a waveform for each pressure.

14.2 Safety



WARNING

- **Use only pressure transducers specified in this manual. Never reuse disposable pressure transducers.**
 - **Make sure that the applied parts never contact other conductive parts.**
 - **To reduce the hazard of burns during high-frequency surgical procedures, ensure that the monitor's cables and transducers never come into contact with the high-frequency surgical units.**
 - **When using accessories, their operating temperature should be taken into consideration. For details, refer to instructions for use of accessories.**
-

14.3 Zeroing the Transducer

To avoid inaccurate pressure readings, the monitor requires a valid zero. Zero the transducer in accordance with your hospital policy (at least once per day). Zero whenever:

- A new transducer or adapter cable is used.
- You reconnect the transducer cable to the monitor.
- The monitor restarts.
- You doubt the readings.

1. Turn off the stopcock to the patient.

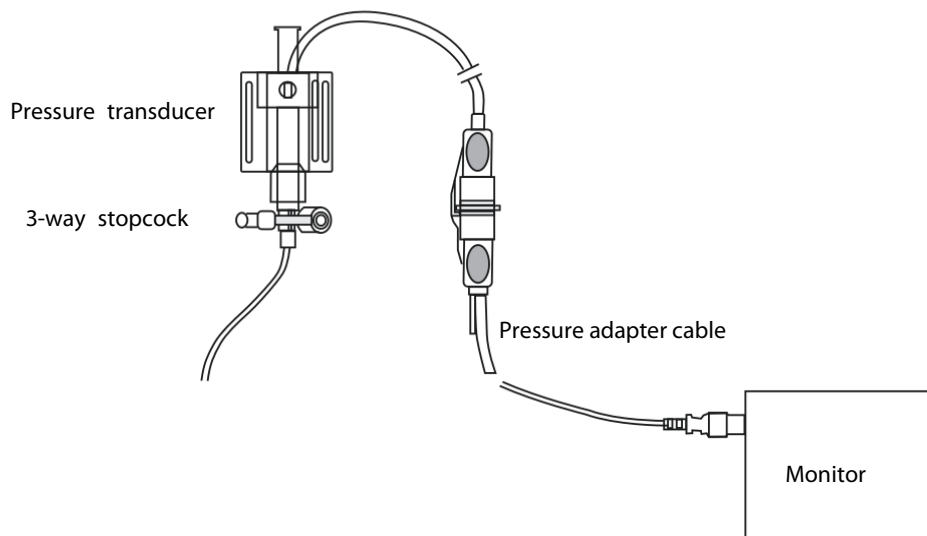

2. Vent the transducer to the atmospheric pressure by turning on the stopcock to the air.
3. In the setup menu for the pressure (e.g. Art), select [**Art Zero >>**]→[**Zero**]. During zero calibration, the [**Zero**] button appears dimmed. It recovers after the zero calibration is completed. To zero all IBP channels, select the [**Zero IBP**] hotkey, and then select [**Zero All Channels**] in the popup menu.
4. After the zero calibration is completed, close the stopcock to the air and open the stopcock to the patient.

NOTE

-
- **Your hospital policy may recommend that the ICP transducer is zeroed less frequently than other transducers.**
-

14.4 Setting Up the Pressure Measurement

1. Plug the pressure cable into the IBP connector.
2. Prepare the flush solution.
3. Flush the system to exhaust all air from the tubing. Ensure that the transducer and stopcocks are free of air bubbles.

WARNING

- **If air bubbles appear in the tubing system, flush the system with the infusion solution again. Air bubbles may lead to inaccurate pressure readings.**
-

4. Connect the pressure line to the patient catheter.
5. Position the transducer so that it is level with the heart, approximately at the level of the midaxillary line.
6. Select the appropriate label.

- Zero the transducer. After a successful zeroing, turn off the stopcock to the atmosphere and turn on the stopcock to the patient.

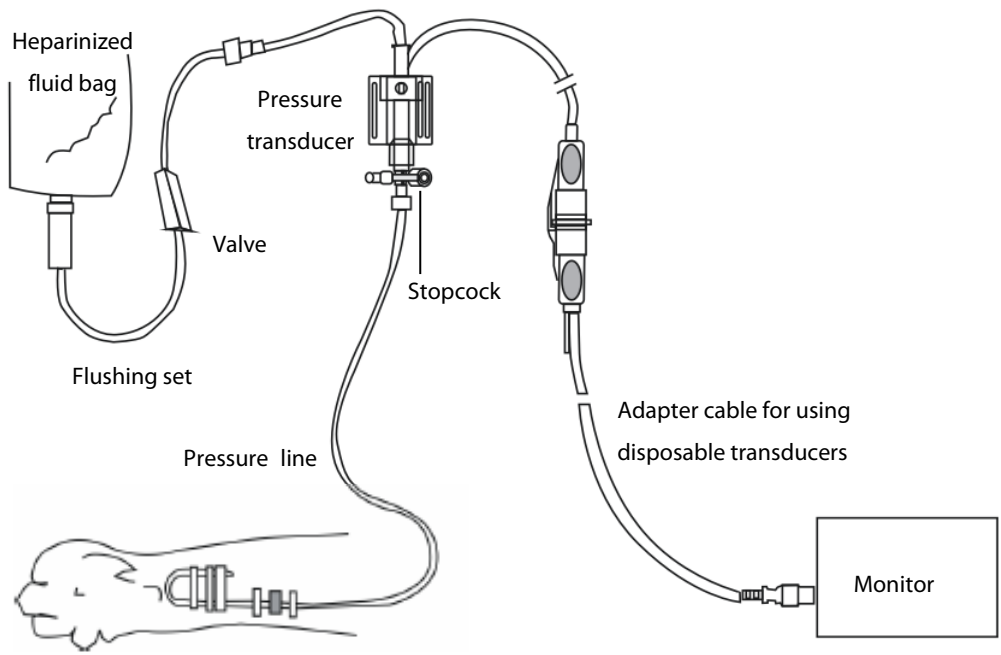

⚠ WARNING

- If measuring intracranial pressure (ICP) with a sitting patient, level the transducer with the top of the patient's ear. Incorrect leveling may give incorrect values.

14.5 Understanding the IBP Display

The IBP measurement is displayed on the monitor as a waveform and numeric pressures. The figure below shows the waveform and numerics for the Art pressure. For different pressures, this display may be slightly different.

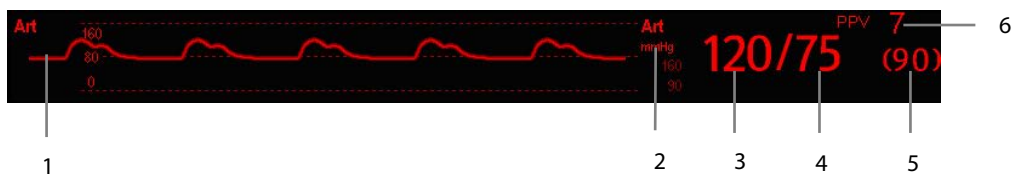

1. Waveform
2. Pressure unit
3. Systolic pressure
4. Diastolic pressure
5. Mean pressure
6. PPV measurement

For some pressures, the parameter window may show the mean pressure only. For different pressures, their default unit may be different. If the Art and ICP pressures are measured simultaneously, the ICP parameter area will display numeric CPP, which is obtained by subtracting ICP from the Art mean.

14.6 Changing IBP Settings

14.6.1 Changing a Pressure for Monitoring

1. Select the pressure you want to change to enter its setup menu. In the menu, there is a figure showing the current IBP measurement connector.
2. Select [**Label**] and then select your desired label from the list. The already displayed labels cannot be selected.

Label	Description	Label	Description
PA	Pulmonary artery pressure	CVP	Central venous pressure
Ao	Aortic pressure	LAP	Left atrial pressure
UAP	Umbilical arterial pressure	RAP	Right atrial pressure
BAP	Brachial arterial pressure	ICP	Intracranial pressure
FAP	Femoral arterial pressure	UVP	Umbilical venous pressure
Art	Arterial blood pressure	LV	Left ventricular pressure
P1 to P4	Non-specific pressure label		

NOTE

- When two pressures are detected having the same label, the monitor changes one pressure label to a currently unused one.

14.6.2 Setting the Pressure Label Order

Select [**IBP Label Order Setup >>**] from the parameter setup menu to set the display order of the pressure labels. The default display order is: Art, pArt, CVP, pCVP, ICP, PA, AO, UAP, FAP, BAP, LV, LAP, RAP, UVP, P1, P2, P3, P4. To restore the default setting, you can select [**Defaults**] from the [**IBP Label Order Setup**] window.

14.6.3 Setting Alarm Properties

Select [**Alarm Setup >>**] from the parameter setup menu. You can set alarm properties for this parameter in the popup menu.

14.6.4 Changing Averaging Time

The IBP value displayed on the monitor screen is the average of data collected within a specific time. The shorter the averaging time is, the quicker the monitor responds to changes in the patient's blood pressure. Conversely, the longer the averaging time is, the slower the monitor responds to changes in the patient's blood pressure, but the measurement accuracy will be improved. For critically ill patients, selecting shorter averaging time will help in understanding the patient's state.

To set the averaging time, in the parameter setup menu, select **[Sensitivity]** and toggle between **[High]**, **[Med]** and **[Low]**. The corresponding averaging time is about 1 s, 8 s and 12 s respectively.

14.6.5 Setting Up the IBP Wave

In the setup menu for the pressure, you can:

- Select **[Sweep]** and then select the appropriate setting. The faster the wave sweeps, the wider the wave is.
- Select **[Scale]** and then select the appropriate setting. If **[Auto]** is selected, the size of the pressure's waveform will be adjusted automatically.
- Select **[Filter]** and then select the desired option.

14.6.6 Enabling PPV Measurement and Setting PPV Source

PPV indicates pulse pressure variation. To enable PPV measurement, set **[PPV Measurement]** to **[On]**.

You can select the PPV source when PPV measurement is enabled.



-
- **This monitor can calculate PPV from beat-to-beat values of any arterial pulsatile pressure. The circumstances under which the calculation of a PPV value is clinically meaningful, appropriate and reliable must be determined by a physician.**
 - **The clinical value of the derived PPV information must be determined by a physician. According to recent scientific literature, the clinical relevance of PPV information is restricted to sedated patients receiving controlled mechanical ventilation and mainly free from cardiac arrhythmia.**
 - **PPV calculation may lead to inaccurate values in the following situations:**
 - ◆ **at respiration rates below 8 rpm**
 - ◆ **during ventilation with tidal volumes lower than 8 ml/kg**
 - **for patients with acute right ventricular dysfunction ("cor pulmonale").**
-

14.6.7 Setting the Pressure Unit

Select **[Unit Setup >>]** from the **[User Maintenance]** menu. In the popup menu, select **[Press. Unit]** and toggle between **[mmHg]** and **[kPa]**. Select **[CVP Unit]** and toggle between **[mmHg]**, **[cmH₂O]** and **[kPa]**.

14.7 Overlapping IBP Waveforms

The IBP waveforms can be displayed together. To combine IBP waveforms,

1. Select **[Main Menu]**→**[Screen Setup>>]**→**[Screen Layout>>]** to access the **[Screens]** window.
2. Select the **[Screen Setup]** tab.
3. In Area A, select **[IBP Overlap]** from the drop-down list, and then select the IBP waves to be overlapped on the left side of the same line.

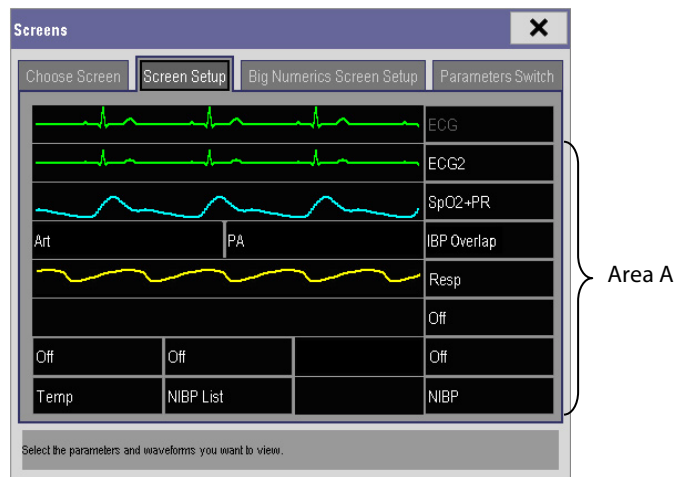

4. Select **✕** to save the setting and exit the window. The main screen will display the overlapped IBP waves.

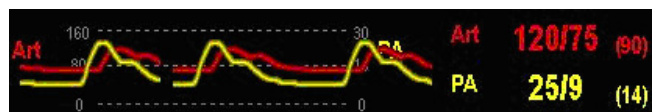

Selecting the overlapped IBP waveforms on the main screen pops up the **[Overlapping Waveform Setup]** menu, where you can:

- Set **[Left Scale]** and **[Right Scale]** and then set the scales for the overlapped waveforms. The left scale is for Art, LV, Ao, FAP, BAP, UAP, and the arterial waveforms of P1~P4; the right scale is for CVP, ICP, LAP, RAP, UVP, and the venous waveforms of P1~P4.
- Set **[CVP Scale]** individually if CVP waveform is combined and CVP unit is different from IBP unit.
- Set **[PA Scale]** individually if PA waveform is combined.
- Set **[Gridlines]** to **[On]** or **[Off]** to show gridlines or not in the overlapped waveform area.
- Select **[Sweep]** and then set the sweep speed for the overlapped waveforms.
- Select **[Filter]** and then set the filter for the overlapped waveforms.

You can also change the above settings from the corresponding IBP setup menu.

Note

- **CVP scale is changed together with right scale. The unit of CVP scale is consistent with CVP parameter unit.**

14.8 Measuring PAWP

Pulmonary Artery Wedge Pressure (PAWP) values, used to assess cardiac function, are affected by fluid status, myocardial contractility, and valve and pulmonary circulation integrity.

Obtain the measurement by introducing a balloon-tipped pulmonary artery flotation catheter into the pulmonary artery. When the catheter is in one of the smaller pulmonary arteries, the inflated balloon occludes the artery allowing the monitor to record changes in the intrathoracic pressures that occur throughout the respiration cycle.

The pulmonary wedge pressure is the left ventricular end diastolic pressure when the airway pressure and valve function are normal. The most accurate PAWP values are obtained at the end of the respiration cycle when the intrathoracic pressure is fairly constant and the artifact caused by respiration is minimal.



14.8.1 Preparing to Measure PAWP

1. Connect the parts such as catheter, syringe, etc. and use the balloon inflation port.
2. Connect the PAWP cable into the IBP connector on the monitor. Since PAWP is measured on PA, selecting **[PA]** as the IBP label is recommended.
3. Select the PA parameter window or waveform area to enter its setup menu. Then, select **[PAWP]** to enter the PAWP measurement window. You can also enter the PAWP measurement window from the P1-P4 parameter window.

NOTE

-
- **After entering the PAWP measurement window, the monitor will turn off the PA alarm automatically.**
-

14.8.2 Setting Up the PAWP Measurement

1. Wedge the flotation catheter into the pulmonary artery. Then inflate the balloon and pay attention to PA waveform changes on the screen.
2. After obtaining a stable PAWP waveform, press the **[Freeze]** key to freeze the waveform and deflate the balloon.
3. You can adjust the PAWP scale to an appropriate position by adjusting  or  beside the **[Adjust]** button. Press the **[Confirm]** key to save one PAWP measurement.
4. If you need to start a new measurement, select **[Next Measure]**.

WARNING

- **Prolonged inflation can cause pulmonary hemorrhage, infarction or both. Inflate the balloon for the minimum time necessary to get an accurate measurement.**
 - **If the PAWP is greater than the PA (systolic), deflate the balloon and report the incident in accordance with hospital policy. Because the pulmonary artery could be accidentally ruptured, and the PAWP value derived will not reflect the patient's hemodynamic state, but will merely reflect the pressure in the catheter or balloon.**
-

14.8.3 Understanding the PAWP Setup Menu

Select **[Setup]** to enter the **[PAWP Setup]** menu. In this menu, you can:

- Select a ECG lead wave as the first reference wave.
- Select a respiration wave as the second reference wave.
- Select a sweep speed for the displayed waveform.
- Change the size of the PA waveform by adjusting the scale height.

15 Monitoring Carbon Dioxide (CO₂)

15.1 Introduction

CO₂ monitoring is a continuous, non-invasive technique for determining the concentration of CO₂ in the patient's airway by measuring the absorption of infrared (IR) light of specific wavelengths. The CO₂ has its own absorption characteristic and the amount of light passing the gas probe depends on the concentration of the measured CO₂. When a specific band of IR light is passed through respiratory gas samples, some of the IR light will be absorbed by the CO₂ molecules. The amount of IR light transmitted after it has been passed through the respiratory gas sample is measured with a photodetector. From the amount of IR light measured, the concentration of CO₂ is calculated.

There are two methods for measuring CO₂ in the patient's airway:

1. Mainstream measurement uses a CO₂ sensor attached to an airway adapter directly inserted into the patient's breathing system.
2. Sidestream/Microstream measurement samples expired patient gas at a constant sample flow from the patient's airway and analyzes it with a CO₂ sensor built into the monitor.

The measurement provides:

1. A CO₂ waveform
2. End tidal CO₂ value (EtCO₂): the CO₂ value measured at the end of the expiration phase.
3. Fraction of inspired CO₂ (FiCO₂): the smallest CO₂ value measured during inspiration.
4. Airway respiration rate (awRR): the number of breaths per minute, calculated from the CO₂ waveform.

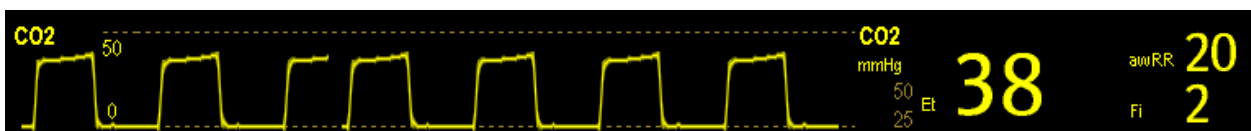

15.2 Measuring CO₂

15.2.1 Making a Sidestream CO₂ Measurement

1. Attach the watertrap to the monitor and then connect the CO₂ components as shown below.

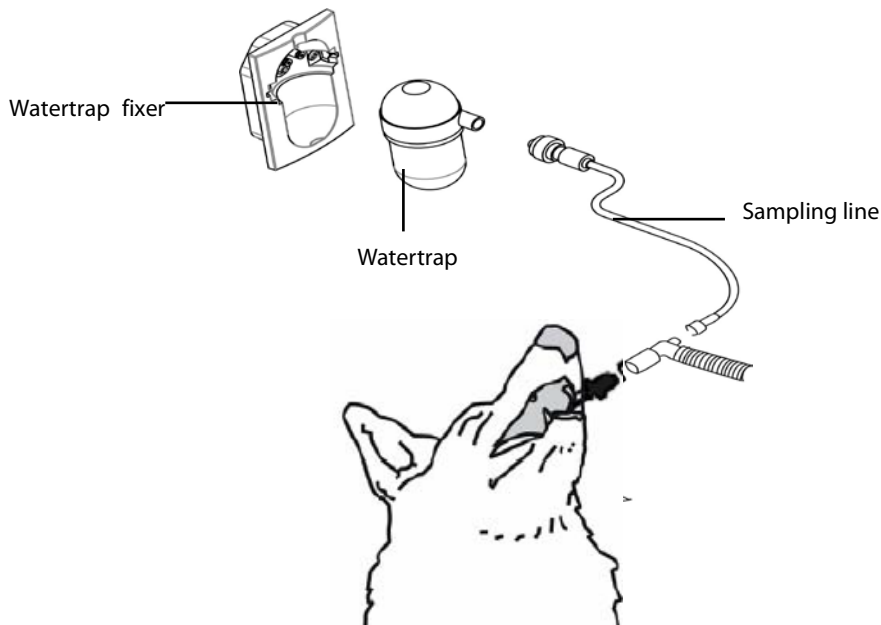

2. The CO₂ module needs time to warm up to reach the operating temperature. The message [CO₂ Sensor Warmup] is displayed during warm-up. If you perform CO₂ measurements during warm-up, the measurement accuracy may be compromised.
3. After warm-up is finished, you can perform CO₂ measurements.

CAUTION

- The watertrap collects water drops condensed in the sampling line and therefore prevents them from entering the module. If the collected water reaches a certain amount, you should drain it to avoid blocking the airway.
- The watertrap has a filter preventing bacterium, water and secretions from entering the module. After long-term use, dust or other substances may compromise the performance of the filter or even block the airway. In this case, replace the watertrap. It is recommended to replace the watertrap once a month, or when the watertrap is found leaky, damaged or contaminated.

NOTE

- To extend the lifetime of the watertrap and module, disconnect the watertrap and set the operating mode to standby mode when CO₂ monitoring is not required.
-

15.2.2 Making a Microstream CO₂ Measurement

Connect the sampling line to the monitor and then connect the CO₂ components as shown below. After warm-up is finished, you can perform CO₂ measurements

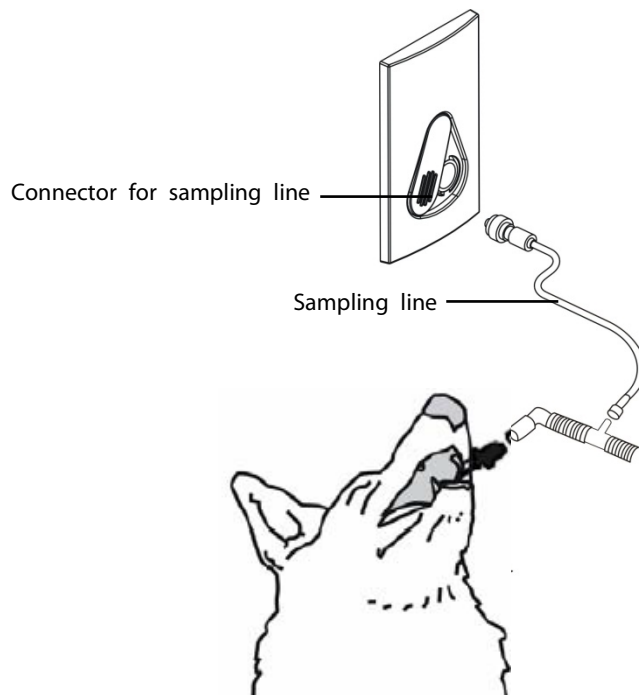

15.3 Changing CO₂ Settings

15.3.1 Accessing CO₂ Menus

By selecting the CO₂ parameter window, you can access the **[CO₂ Setup]** menu.

15.3.2 Entering the Standby Mode

The standby mode of the CO₂ module relates to the standby mode of the monitor as follows:

- If the monitor enters the standby mode, the CO₂ module will also enter the standby mode.
- If the monitor exits the standby mode, the CO₂ module will also exit the standby mode.
- If the CO₂ module enters or exits the standby mode, it will not affect the monitor.

To enter or exit the standby mode manually, select **[Operating Mode]** in the **[CO₂ Setup]** menu and then toggle between **[Standby]** and **[Measure]**.

When you set the sidestream CO₂ module to the standby mode, the CO₂ gas sample intake pump automatically sets the sample flow rate to zero. When exiting the standby mode, the CO₂ module continues to work at the preset sample flow rate.

For the sidestream CO₂ module, you can set the delay time. After the delay time the CO₂ module enters the standby mode if no breath is detected.

For the microstream CO₂ module, you can also set a period of time after which the CO₂ module enters the standby mode if no breath is detected since the CO₂ module is powered on or the CO₂ module switches to the measuring mode or the automatic standby time is re-set. To set the standby time, in the **[CO₂ Setup]** menu, select **[Auto Standby]** and then select the appropriate setting.

15.3.3 Setting the CO₂ Unit

Select **[Unit Setup >>]** from the **[User Maintenance]** menu. In the popup menu, select **[CO₂ Unit]** and toggle between **[mmHg]**, **[%]** and **[kPa]**.

15.3.4 Setting up Gas Compensations



-
- **Make sure that the appropriate compensations are used. Inappropriate compensations may cause inaccurate measurement values and result in misdiagnosis.**
-

For the sidestream CO₂ module:

1. Select **[CO₂ Setup]**.
2. According to the actual condition, set the concentration required for the following compensations:
 - ◆ **[O₂ Compen]**
 - ◆ **[N₂O Compen]**
 - ◆ **[Des Compen]**

For the microstream CO₂ module, gas compensations are not required.

15.3.5 Setting up Humidity Compensation

Sidestream and microstream CO₂ modules are configured to compensate CO₂ readings for either Body Temperature and Pressure, Saturated Gas (BTPS), to account for humidity in the patient's breath, or Ambient Temperature and Pressure, Dry Gas (ATPD).

1. ATPD: $P_{CO_2}(mmHg) = CO_2(vol\%) \times P_{amb} / 100$
2. BTPS: $P_{CO_2}(mmHg) = CO_2(vol\%) \times (P_{amb} - 47) / 100$

Where, P_{CO_2} = partial pressure, $vol\%$ = CO₂ concentration, P_{amb} = ambient pressure, and unit is mmHg.

For the sidestream and microstream CO₂ module, you can set the humidity compensation on or off according to the actual condition. To set the humidity compensation:

1. In the **[CO₂ Setup]** menu, select **[BTPS Compen]**.
2. Select either **[On]** for BTPS or **[Off]** for ATPD, depending on which compensation applies.

15.3.6 Setting the Apnea Alarm Delay

In the [CO₂ Setup] menu, select [Apnea Delay] and then select the appropriate setting. The monitor will alarm if the patient has stopped breathing for longer than the preset apnea time. The [Apnea Delay] of Resp and CO₂ module keeps consistent with each other.

WARNING

- **The respiration measurement does not recognize the cause of apneas. It only indicates an alarm if no breath is detected when a pre-adjusted time has elapsed since the last detected breath. Therefore, it cannot be used for diagnostic purpose.**
-

15.3.7 Choosing a Time Interval for Peak-Picking

For microstream CO₂ modules, you can select a time interval for picking the highest CO₂ as the EtCO₂ and the lowest as the FiCO₂.

In the [CO₂ Setup] menu, select [Max Hold] and toggle between [Single Breath], [10 s], [20 s] and [30 s] (for microstream CO₂ module only).

- [Single Breath]: EtCO₂ and FiCO₂ are calculated for every breath.
- [10 s] or [20 s], or [30 s]: EtCO₂ and FiCO₂ are calculated using 10, 20 or 30 seconds of data.

15.3.8 Setting the Flow Rate

For the sidestream CO₂ module, you can change the sampling rate of respiratory gas in the patient's airway by setting the flow rate. To set the flow rate, enter the [CO₂ Setup] menu and select an appropriate setting from [Flow Rate].

WARNING

- **Please consider the patient's actual bearing capability and select the appropriate flow rate when setting the flow rate.**
-

15.3.9 Setting up the CO₂ Wave

In the [CO₂ Setup] menu, you can:

- Select [Wave Type] and toggle between [Draw] and [Fill]:
 - ◆ [Draw]: The CO₂ wave is displayed as a curved line.
 - ◆ [Fill]: The CO₂ wave is displayed as a filled area.
- Select [Sweep] and then select the appropriate setting. The faster the wave sweeps, the wider the wave is.
- Change the size of the CO₂ waveform by adjusting the wave [Scale].

15.4 Setting RR Source

To set RR source:

1. Enter the [**CO2 Setup**] menu.
2. Select [**RR Source**] and then select a source or [**Auto**] from the dropdown list.

The [**RR Source**] settings of Resp and CO₂ module are linked. For details, please refer to the section **Setting RR Source** of chapter *Resp*.

15.5 Setting Barometric Pressure Compensation

Both sidestream and microstream CO₂ modules have the function of automatic barometric pressure compensation (the system automatically measures the barometric pressure which the monitor is exposed to). You must modify the barometric pressure based on the actual situation as follows:

1. Select [**Main Menu**]→[**Maintenance >>**]→[**User Maintenance >>**]→enter the required password→[**Maintain CO2 >>**]→[**Calibrate CO2 >>**].
2. Select [**Barometric Pressure**] and then enter the value of barometric pressure to which the monitor is exposed to.

15.6 Measurement Limitations

The following factors may influence the accuracy of measurement:

- Leaks or internal venting of sampled gas
- Mechanical shock
- Cyclic pressure up to 10 kPa (100 cmH₂O)
- Other sources of interference, if any

15.7 Leakage Test

When the sidestream CO₂ module needs maintenance, the monitor prompts on the CO₂ waveform area: [**Need maintenance. Enter CO₂ setup menu.**] Then, you can access [**User Maintenance >>**]→ [**Maintain CO₂>>**], and perform leakage test according to the prompt messages on the menu.

15.8 Troubleshooting the Sidestream CO₂ Sampling System

When the sampling system of the sidestream CO₂ module works incorrectly, check if the sampling line is kinked. If not, remove it from the watertrap. If the monitor gives a message indicating the airway still works incorrectly, it indicates that the watertrap must have been blocked, and you should replace with a new one. Otherwise, you can determine that the sampling line must have been blocked. Replace with a new sampling line.

15.9 Removing Exhaust Gases from the System



-
- **Anesthetics: When using the Sidestream or Microstream CO₂ measurement on patients who are receiving or have recently received anesthetics, connect the outlet to a scavenging system, or to the anesthesia machine/ventilator, to avoid exposing medical staff to anesthetics.**
-

To remove the sample gas to a scavenging system, connect an exhaust tube to the gas outlet connector of the module.

15.10 Zeroing the Sensor

The zero calibration eliminates the effect of baseline drift during CO₂ measurement exerted on the readings and therefore maintains the accuracy of the CO₂ measurements.

15.10.1 For Sidestream and Microstream CO₂ Modules

For sidestream and microstream CO₂ modules, a zero calibration is carried out automatically when necessary. You can also start a manual zero calibration if necessary.

To manually start a zero calibration:

1. Select [**Main Menu**] → [**Maintenance >>**] → [**User Maintenance >>**] → enter the required password → [**Maintain CO₂ >>**].
2. Select [**Calibrate CO₂ >>**] → [**Start Zero Cal.**].

Disconnecting the patient airway is not required when performing a zero calibration.

15.11 Calibrating the Sensor

For sidestream or microstream CO₂ modules, a calibration should be performed once every year or when the readings go far beyond the range. For details, refer to the chapter **23 Maintenance**.

15.12 Oridion Information

Microstream

This trademark is registered in Israel, Japan, German and America.

Oridion Patents

The capnography component of this product is covered by one or more of the following US patents: 6,428,483; 6,997,880; 6,437,316; 7,488,229; 7,726,954 and their foreign equivalents. Additional patent applications pending.

No Implied License

Possession or purchase of this device does not convey any express or implied license to use the device with unauthorized CO₂ sampling consumables which would, alone, or in combination with this device, fall within the scope of one or more of the patents relating to this device and/or CO₂ sampling consumable.

16 Freezing Waveforms

During monitoring, the freeze feature allows you to freeze the currently displayed waveforms on the screen so that you can have a close examination of the patient's status. Besides, you can select any frozen waveform for recording.



16.1 Freezing Waveforms

1. To freeze waveforms, select the  hardkey on the monitor's front.
2. The system closes the displayed menu (if any), and opens the **[Freeze]** menu.
3. All displayed waveforms are frozen, i.e. the waveforms stop being refreshed or scrolling.

The freeze feature exerts no effect on the split-screen view of minitrends, OxyCRG and other patients.

16.2 Viewing Frozen Waveforms



To view the frozen waveforms, you can either:

- Select the **[Scroll]** button and then rotate the Knob clockwise or counter-clockwise, or
- Directly select the  or  beside the **[Scroll]** button using a mouse or through the touchscreen.

The frozen waveforms will scroll left or right accordingly. And meanwhile, at the lower right corner of the bottommost waveform, there is an upward arrow. The freeze time is displayed below the arrow and the initial frozen time is **[0 s]**. With the waveforms scrolling, the freeze time changes at intervals of 1 second. This change will be applied for all waveforms on the screen.

16.3 Unfreezing Waveforms

To unfreeze the frozen waveforms, you can either:

- Select the  button at the upper right corner of the **[Freeze]** menu,
- Select the  hardkey on the monitor's front, or
- Perform any other action that causes the screen to be readjusted or opens a menu, such as plugging in or out a module, pressing the  hardkey, etc.

16.4 Recording Frozen Waveforms

1. In the [**Freeze**] menu, select, in turn, [**Wave 1**], [**Wave 2**] and [**Wave 3**] and then select your desired waveforms.
2. Select the [**Record**] button. The selected waveforms and all numerics at the frozen time are printed out by the recorder.

17 Review

17.1 Accessing Respective Review Windows

1. Select the **[Review]** QuickKey, or **[Main Menu]→[Review >>]**.
2. Select **[Graphic Trends]**, **[Tabular Trends]**, **[Events]**, or **[Full Disclosure]** to access their respective review windows.

17.2 Reviewing Graphic Trends

In the **[Review]** menu, select **[Graphic Trends]** to access the following window.

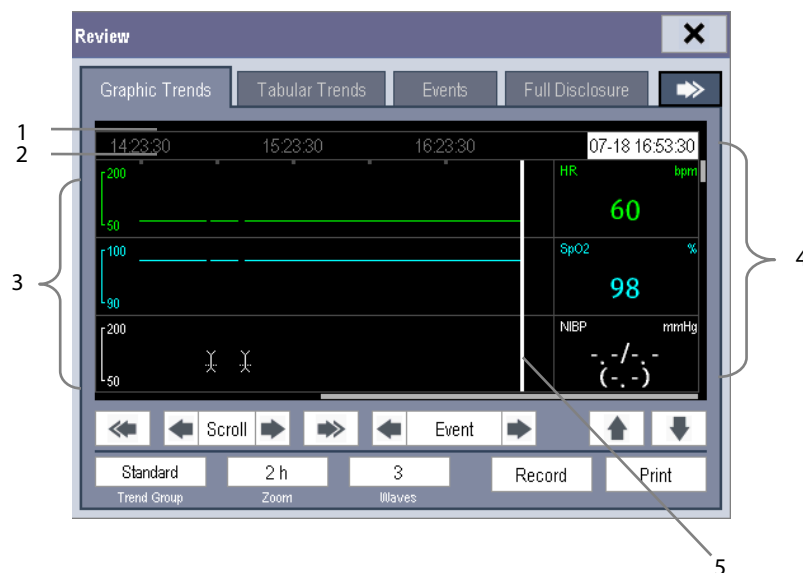



1. Event mark area
2. Time axis
3. Graphic trends area
4. Parameter area
5. Cursor

Events are marked with colors in the event mark area. Red represents high level alarm event. Yellow represents medium/low level alarm event. Green represents manual event.

In this review window:

- Select **[Trend Group]** and you can select a trend group for viewing in the popup menu. If **[Custom 1]** or **[Custom 2]** is selected, you can further select **[Define Trend Group]**. Then you can select the parameters for viewing in the popup menu.
- You can set the time length of the review window by selecting **[Zoom]**.
- You can set the number of waves displayed in one page by selecting **[Waves]**.
- To browse the graphic trends, you can either:
 - ◆ Select or beside **[Scroll]** to move the cursor one step to the left or right to navigate through the graphic trends, or
 - ◆ Select or to move the cursor one page to the left or right to navigate through the graphic trends.

A time indicating your current position is displayed above the parameter area. Numeric measurement values corresponding to the cursor location change as the cursor is moved. The measurement value that triggered high level alarm has red background. The one that triggered medium/low level alarm has yellow background.





- By selecting  or  beside **[Event]**, you can position the cursor to different event time.
- By selecting the **[Record]** button, you can print out the currently displayed graphic trends by the recorder.

17.3 Reviewing Tabular Trends



In the **[Review]** menu, select **[Tabular Trends]** to access the Tabular Trends window.

Events are marked with colors in window's top area. Red represents high level alarm event. Yellow represents medium/low level alarm event. Green represents manual event.

In this review window:

- Select **[Trend Group]** and you can select a trend group for viewing in the popup menu. If **[Custom 1]** or **[Custom 2]** is selected, you can further select **[Define Trend Group]**. Then you can select the parameters for viewing in the popup menu.
- You can change the resolution of the trend data by selecting **[Interval]** and then selecting the appropriate setting:
 - ◆ **[5 s]** or **[30 s]**: select to view up to 4 hours of tabular trends at 5- or 30-second resolution.
 - ◆ **[1 min]**, **[5 min]**, **[10 min]**, **[15 min]**, **[30 min]**, **[1 h]**, **[2 h]** or **[3 h]**: select to view up to 120 hours of tabular trends at your selected resolution.
 - ◆ **[NIBP]**: select to view the tabular trends when NIBP measurements were acquired.
- To browse the tabular trends, you can either:
 - ◆ Select  or  beside **[Scroll]** to drag the scrollbar left or right to navigate through the trend database, or
 - ◆ Select  or  to scroll left or right to navigate through the trend database.

The measurement value that triggered high level alarm has red background. The one that triggered medium/low level alarm has yellow background.

- By selecting  or  beside **[Event]**, you can position the cursor to different event time.
- By selecting the **[Record]** button, you can access the **[Record Setup]** menu and set the start and end time of the tabular trends you want to record. This feature is not available when reviewing a history patient. By further selecting **[Record]**, you can print out the currently displayed tabular trends by the recorder.

17.4 Events

17.4.1 Marking Events

During monitoring, some events may exert effects on the patient and as a result change the waveforms or numerics displayed on the monitor. To help analysing the waveforms or numerics at that time, you can mark these events.

Select **[Main Menu]**→**[Mark Event >>]**. In the popup menu, you can select the waves to be stored when a manual event is triggered. You can select **[Trigger Manual Event]** from the **[Mark Event]** menu or the **[Manual Event]** QuickKey to trigger a manual event and store it at the same time.

When you are reviewing graphic trends, tabular trends or full-disclosure waveforms, the manual event symbol is displayed at the time the event is triggered.

17.4.2 Reviewing Events

The monitor saves the events in real time. You can review these events.

In the **[Review]** menu, select **[Events]** to access the Events window.

The events that can be reviewed include parameter alarm events, arrhythmia alarm events and manual events. When an event occurs, all the measurement numerics at the event trigger time and related waveforms 4 seconds, 8 seconds, or 16 seconds, as per the setting of recording length, respectively before and after the event trigger time are stored.

In this window:

- You can view the desired events by selecting **[Event]**.
- You can view the desired events according to the level by selecting **[Level]**.

After selecting the desired event, you can select **[Details]** to access the following window. In this window, the waveform area displays the waveforms related to the event, and the parameter area displays the parameter values happened at the event trigger time.

NOTE

- **A total loss of power has no impact on the saved events.**

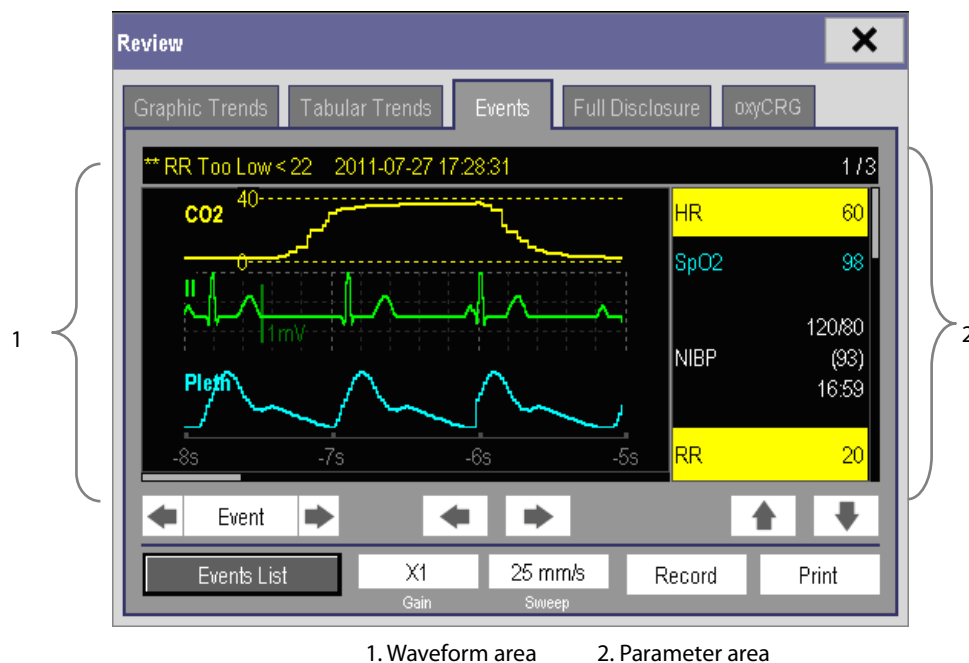

In this window:

- You can select or to navigate through the waveforms.
- You can select or beside the **[Event]** button to switch between events.
- You can set the desired **[Gain]** for ECG waveform.
- You can set the desired **[Sweep]**.

- By selecting the **[Record]** button, you can print out the currently displayed alarm events by the recorder.
- By selecting the **[Events List]** button, you can view the events list.

17.5 Reviewing Waveforms

In the **[Review]** menu, select **[Full Disclosure]** to access the following window.

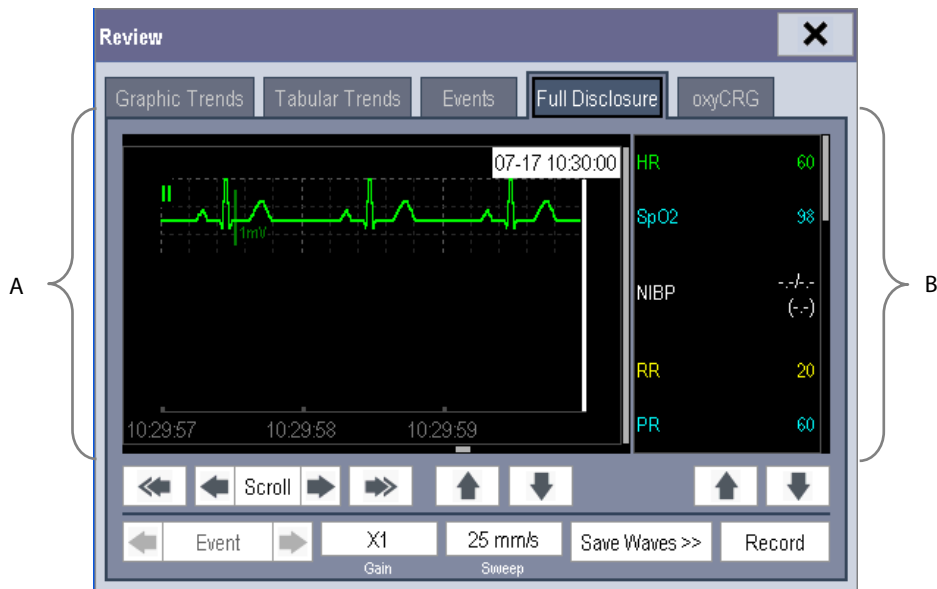

A. Waveform area

B. Parameter area

In this review window:

- To review full-disclosure waveforms, you need to save waveforms first. Select **[Save Waves >>]** and then select the parameters whose waveforms you want to view. To save full-disclosure waveform, your monitor must be equipped with a storage card.
- To view the waveforms, you can either:
 - ◆ Select or beside the **[Scroll]** button to move the cursor one step left or right to navigate through the waveforms, or
 - ◆ Select or to move the cursor one page left or right to navigate through the waveforms.

A time indicating your current position is displayed at the top of the waveform area. Numeric measurement values corresponding to the cursor location are displayed in the parameter area, and change as the cursor is moved.

- You can change the ECG wave gain by selecting **[Gain]** and then selecting the appropriate setting.
- You can change the waveform sweep speed by selecting **[Sweep]** and then selecting the appropriate setting.
- By selecting the **[Record]** button, you can print out the first three waveforms and measurement numerics by the recorder.
- By selecting or beside the **[Event]** button, you can position the cursor between events.

18 Calculations

18.1 Introduction

The calculation feature is available with your monitor. The calculated values, which are not directly measured, are computed based on the values you provide.

You can perform the following calculations:

- Dose calculations
- Oxygenation calculations
- Ventilation calculations
- Hemodynamic calculations
- Renal calculations

To perform a calculation, select **[Main Menu]** → **[Calc >>]**, or the **[Calculations]** QuickKey and then select the calculation you want to perform.

NOTE

- **The calculation feature is independent of other monitoring functions and can be therefore used for patients being monitored by other monitors. Any operation in a calculation window does not affect the monitoring by the local monitor.**



WARNING

- **After the calculation is finished, verify the entered values are correct and the calculated values are appropriate. We assume no responsibility for any consequences caused by wrong entries and improper operations.**
-

18.2 Dose Calculations

18.2.1 Performing Calculations

To perform a dose calculation:

1. Select **[Main Menu]** → **[Calculations >>]** → **[Dose >>]**, or select **[Calculations]** QuickKey → **[Dose >>]**.
2. Select, in turn, **[Patient Cat.]** and **[Drug Name]** and then select the appropriate settings. The dose calculation program has a library of commonly used drugs, of which Drug A through Drug E are for those not specified in this library.
 - ◆ Drug A, B, C, D, E
 - ◆ Aminophylline
 - ◆ Dobutamine
 - ◆ Isuprel
 - ◆ Lidocaine
 - ◆ Nipride

- ◆ Dopamine
- ◆ Epinephrine
- ◆ Heparin
- ◆ Nitroglycerin
- ◆ Pitocin

3. The system gives a set of default values when the above steps are finished. However, these values cannot be used as the calculated values. The user must enter values following the doctor's instructions, and then the calculated values can only be used
4. Enter the patient's weight.
5. Enter other values.
6. Verify if the calculated values are correct.

18.2.2 Selecting the Proper Drug Unit

Each drug has its fixed unit or unit series. Among a unit series, one unit may change to another automatically depending on the entered value.

The units for each drug are as follows:

- Drug A, B, C, Aminophylline, Dobutamine, Dopamine, Epinephrine, Isuprel, Lidocaine, Nipride and Nitroglycerin use the unit series: g, mg and mcg.
- Drug D, Heparin and Pitocin use the unit series: Unit, KU (kilo units) and MU (million units).
- Drug E uses the unit: mEq (milli-equivalents).

You must select the proper drug name (A, B, C, D or E) according to the units when you define a drug not listed in this library.

18.2.3 Titration Table





To open the titration table, select [**Titration Table >>**] in the [**Dose Calculation**] window after the dose calculation is finished.

In the titration table, when you change:

- [**Reference**]
- [**Interval**]
- [**Dose Type**]

The titrated values change accordingly.

You can also:

- Select  or , or  or  beside the vertical scrollbar to view more values.
- Select [**Record**] to print out the currently displayed titrated values by the recorder.

18.2.4 Drug Calculation Formulas

Abbreviation	Unit	Formula
Conc.	g/ml, unit/ml or mEq/ml	Amount / Volume
Dose	Dose/hr, Dose/kg/min	Rate × Conc.
Volume	ml	Rate × Duration
Amount	g, unit, mEq	Rate × Duration
Duration	h	Amount/Dose
Drip Rate	gtt/min	INF Rate × Drop Size / 60

18.3 Oxygenation Calculations

18.3.1 Performing Calculations

To perform an oxygenation calculation:

1. Select **[Main Menu]**→**[Calculations >>]**→**[Oxygenation >>]**, or select the **[Calculations]** QuickKey→**[Oxygenation >>]**.
2. Enter values for calculation.
3. Select the **[Calculate]** button. The system performs a calculation per the current settings and displays the calculated values.
 - ◆ If a calculated value is outside the range, its background will highlight in yellow. You can select **[Range]** to view its normal range in the unit field.
 - ◆ Invalid values are displayed as [---].

In the **[Oxygenation Calculation]** window, you can:

- Change the pressure unit, Hb unit and oxygen content unit by selecting **[Press. Unit]**, **[Hb Unit]** and **[OxyCont Unit]** and then selecting the appropriate settings. The changes take effect automatically.
- Trigger a recording by selecting the **[Record]** button. The currently displayed oxygenation calculations are printed out by the recorder.
- Review the previously performed calculations by selecting **[Review]**.

18.3.2 Entered Parameters

Abbreviation	Unit	Full spelling
FiO ₂	%	percentage fraction of inspired oxygen
PaO ₂	mmHg	partial pressure of oxygen in the arteries
PaCO ₂	mmHg	partial pressure of carbon dioxide in the arteries
SaO ₂	%	arterial oxygen saturation
PvO ₂	mmHg	partial pressure of oxygen in venous blood
SvO ₂	%	venous oxygen saturation
Hb	g/L	hemoglobin
CaO ₂	ml/L	arterial oxygen content

Abbreviation	Unit	Full spelling
CvO ₂	ml/L	venous oxygen content
VO ₂	ml/min	oxygen consumption
RQ	None	respiratory quotient
ATMP	mmHg	atmospheric pressure
Height	cm	height
Weight	kg	weight

18.3.3 Calculated Parameters and Formulas

Abbreviation	Unit	Full spelling	Formula
BSA	m ²	body surface area	$Wt^{0.425} \times Ht^{0.725} \times 0.007184$
C(a-v)O ₂	ml/L	arteriovenous oxygen content difference	$CaO_2 - CvO_2$
O ₂ ER	%	oxygen extraction ratio	$100 \times C(a-v)O_2 / CaO_2$
PAO ₂	mmHg	partial pressure of oxygen in the alveoli	$FiO_2 / 100 \times (ATMP - 47) - PaCO_2 \times [FiO_2 / 100 + (1 - FiO_2 / 100) / RQ]$
AaDO ₂	mmHg	alveolar-arterial oxygen difference	$PAO_2 - PaO_2$
CcO ₂	ml/L	capillary oxygen content	$Hb \times 1.34 + 0.031 \times PAO_2$
Qs/Qt	%	venous admixture	$100 \times [1.34 \times Hb \times (1 - SaO_2 / 100) + 0.031 \times (PAO_2 - PaO_2)] / [1.34 \times Hb \times (1 - SvO_2 / 100) + 0.031 \times (PAO_2 - PvO_2)]$

18.4 Ventilation Calculations

18.4.1 Performing Calculations

To perform a ventilation calculation:

1. Select **[Main Menu]** → **[Calculations >>]** → **[Ventilation >>]**, or select the **[Calculations]** QuickKey → **[Ventilation >>]**.
2. Enter values for calculation. If the monitor is connected to an anesthesia machine or a ventilator, the system automatically loads the supported parameter values to the **[Ventilation Calculation]** window.
3. Select the **[Calculate]** button. The system performs a calculation per the current settings and displays the calculated values.
 - ◆ If a calculated value is outside the range, its background will highlight in yellow. You can select **[Range]** to view its normal range in the unit field.
 - ◆ Invalid values are displayed as [---].

In the **[Ventilation Calculation]** window, you can:

- Change the pressure unit by selecting **[Press. Unit]** and then selecting the appropriate setting. Corresponding pressure values shall convert and update automatically.
- Trigger a recording by selecting the **[Record]** button. The currently displayed ventilation calculations are printed out by the recorder.
- Review the previously performed calculations by selecting **[Review]**.

18.4.2 Entered Parameters

Abbreviation	Unit	Full spelling
FiO ₂	%	percentage fraction of inspired oxygen
RR	rpm	respiration rate
PeCO ₂	mmHg	partial pressure of mixed expiratory CO ₂
PaCO ₂	mmHg	partial pressure of carbon dioxide in the arteries
PaO ₂	mmHg	partial pressure of oxygen in the arteries
TV	ml	tidal volume
RQ	None	respiratory quotient
ATMP	mmHg	atmospheric pressure

18.4.3 Calculated Parameters and Formulas

Abbreviation	Unit	Full spelling	Formula
PAO ₂	mmHg	partial pressure of oxygen in the alveoli	$(ATMP - 47) \times FiO_2 / 100 - PaCO_2 \times [FiO_2 / 100 + (1 - FiO_2 / 100) / RQ]$
AaDO ₂	mmHg	alveolar-arterial oxygen difference	$PAO_2 - PaO_2$
Pa/FiO ₂	mmHg	oxygenation ratio	$100 \times PaO_2 / FiO_2$
a/AO ₂	%	arterial to alveolar oxygen ratio	$100 \times PaO_2 / PAO_2$
MV	L/min	minute volume	$(TV \times RR) / 1000$
Vd	ml	volume of physiological dead space	$TV \times (1 - PeCO_2 / PaCO_2)$
Vd/Vt	%	physiologic dead space in percent of tidal volume	$100 \times Vd / TV$
VA	L/min	alveolar volume	$(TV - Vd) \times RR / 1000$

18.5 Hemodynamic Calculations

18.5.1 Performing Calculations

To perform a hemodynamic calculation:

1. Select **[Main Menu]** → **[Calculations >>]** → **[Hemodynamic >>]**, or select the **[Calculations]** QuickKey → **[Hemodynamic >>]**.
2. Enter values for calculation.
 - ◆ For a patient who is being monitored, **[HR]**, **[Art mean]**, **[PA mean]** and **[CVP]** are automatically taken from the currently measured values. If the monitor does not provide these values, their fields appear blank.

- ◆ For a patient who is not being monitored, confirm the values you have entered.
3. Select the **[Calculate]** button. The system performs a calculation per the current settings and displays the calculated values.
- ◆ If a calculated value is outside the range, its background will highlight in yellow. You can select **[Range]** to view its normal range in the unit field.
 - ◆ Invalid values are displayed as [---].

In the **[Hemodynamic Calculation]** window, you can:

- Trigger a recording by selecting the **[Record]** button. The currently displayed hemodynamic calculation are printed out by the recorder.
- Review the previously performed calculations by selecting **[Review]**.

18.5.2 Entered Parameters

Abbreviation	Unit	Full spelling
HR	bpm	heart rate
PAWP	mmHg	pulmonary artery wedge pressure
Art Mean	mmHg	artery mean pressure
PA Mean	mmHg	pulmonary artery mean pressure
CVP	mmHg	central venous pressure
EDV	ml	end-diastolic volume
Height	cm	height
Weight	kg	weight

18.5.3 Calculated Parameters and Formulas

Abbreviation	Unit	Full spelling	Formula
BSA	m ²	body surface area	$Wt^{0.425} \times Ht^{0.725} \times 0.007184$
SI	ml/m ²	stroke index	SV / BSA
SVRI	DS·m ² /cm ⁵	systemic vascular resistance index	SVR × BSA
PVRI	DS·m ² /cm ⁵	pulmonary vascular resistance index	PVR × BSA
LCWI	kg·m/m ²	left cardiac work index	LCW / BSA
LVSWS	g·m	left ventricular stroke work	$0.0136 \times APMAP \times SV$
LVSWSI	g·m/m ²	left ventricular stroke work index	LVSWS / BSA
RCWI	kg·m/m ²	right cardiac work index	RCW / BSA
RVSWS	g·m	right ventricular stroke work	$0.0136 \times PAMAP \times SV$
RVSWSI	g·m/m ²	right ventricular stroke work index	RVSWS / BSA
EF	%	ejection fraction	$100 \times SV / EDV$

18.6 Renal Calculations

18.6.1 Performing Calculations

To perform a renal calculation:

1. Selecting [**Main Menu**]→[**Calculations >>**]→[**Renal >>**], or select the [**Calculations**] QuickKey→[**Renal >>**].
2. Enter values for calculation.
3. Select the [**Calculate**] button. The system performs a calculation per the current settings and displays the calculated values.
 - ◆ If a calculated value is outside the range, its background will highlight in yellow. You can select [**Range**] to view its normal range in the unit field.
 - ◆ Invalid values are displayed as [---].

In the [**Renal Calculation**] window, you can:

- Trigger a recording by selecting the [**Record**] button. The currently displayed renal calculations are printed out by the recorder.
- Review the previously performed calculations by selecting [**Review**].

18.6.2 Entered Parameters

Abbreviation	Unit	Full spelling
URK	mmol/L	urine potassium
URNa	mmol/L	urinary sodium
Urine	ml/24h	urine
Posm	mOsm/ kgH ₂ O	plasm osmolality
Uosm	mOsm/ kgH ₂ O	urine osmolality
SerNa	mmol/L	serum sodium
Cr	μmol/L	creatinine
UCr	μmol/L	urine creatinine
BUN	mmol/L	blood urea nitrogen
Height	cm	height
Weight	kg	weight

18.6.3 Calculated Parameters and Formulas





Abbreviation	Unit	Full spelling	Formula
URNaEx	mmol/24h	urine sodium excretion	$\text{Urine} \times \text{URNa} / 1000$
URKEx	mmol/24h	urine potassium excretion	$\text{Urine} \times \text{URK} / 1000$
Na/K	%	sodium potassium ratio	$100 \times \text{URNa} / \text{URK}$
CNa	ml/24h	clearance of sodium	$\text{URNa} \times \text{Urine} / \text{SerNa}$
Clcr	ml/min	creatinine clearance rate	$\text{Ucr} \times \text{Urine} / \text{Cr} / (\text{BSA} / 1.73) / 1440$
FENa	%	fractional excretion of sodium	$100 \times (\text{URNa} \times \text{Cr}) / (\text{SerNa} \times \text{Ucr})$
Cosm	ml/min	osmolar clearance	$\text{Uosm} \times \text{Urine} / \text{Posm} / 1440$
CH ₂ O	ml/h	free water clearance	$\text{Urine} \times (1 - \text{Uosm} / \text{Posm}) / 24$
U/P osm	None	urine to plasma osmolality ratio	$\text{Uosm} / \text{Posm}$
BUN/Cr	None*	blood urea nitrogen creatinine ratio	$1000 \times \text{BUN} / \text{Cr}$
U/Cr	None	urine-serum creatinine ratio	Ucr / Cr

*: BUN/Cr is a ratio under the unit of mol.

18.7 Understanding the Review Window

With the review feature, you can review oxygenation, ventilation, hemodynamic and renal calculations. The review window for each calculation is similar. Take the hemodynamic calculations review window for example, you can access it by selecting **[Review]** in the **[Hemodynamic Calculation]** window.

In this review window:

- You can select , ,  or  to view more values.
- The values that exceed the range are displayed in yellow background. The **[Unit]** field displays parameter units. If some parameter values are outside of their normal ranges, you can view their normal range in the **[Unit]** field by selecting **[Range]**.
- You can review an individual calculation by selecting its corresponding column and then selecting **[Original Calc]**. You can record the currently displayed calculations or perform another calculation in this window.

19 Recording

19.1 Using a Recorder

The thermal recorder records patient information, measurement numerics, up to three waveforms, etc.

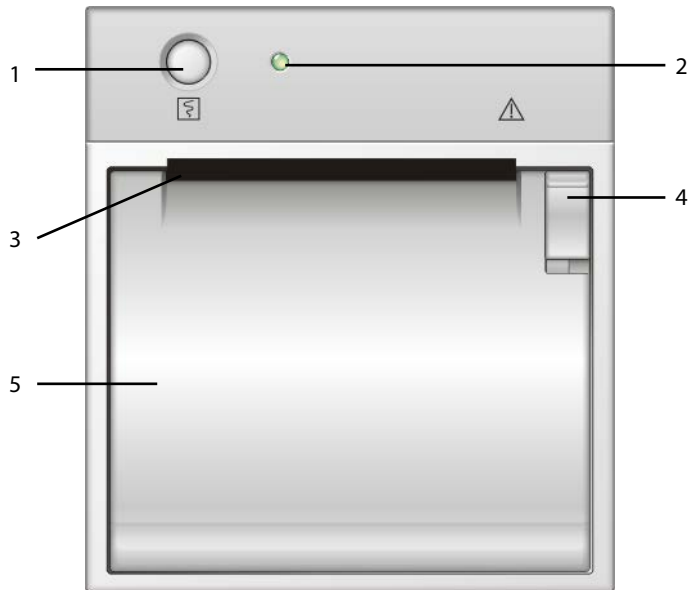

1. Start/Stop key: press to start a recording or stop the current recording.
2. Indicator
 - ◆ On: when the recorder works correctly.
 - ◆ Off: when the monitor is switched off.
 - ◆ Flashes: if an error occurred to the recorder, e.g., the recorder runs out of paper.
3. Paper outlet
4. Latch
5. Recorder door

19.2 Overview of Recording Types

By the way recordings are triggered, the recordings can be classified into the following categories:

- Manually-triggered realtime recordings.
- Timed recordings.
- Alarm recordings triggered by an alarm limit violation or an arrhythmia event.
- Manually-triggered, task-related recordings.

19.3 Starting and Stopping Recordings

To manually start a recording, you can either:

- Select the  hardkey on the front of either the monitor or the recorder module, or
- Select the **[Record]** button from the current menu or window.

Automatic recordings will be triggered in the following conditions:

- Timed recordings will start automatically at preset intervals.
- If both **[Alarm]** and **[Alm Rec]** for a measurement are set on, an alarm recording will be triggered automatically as alarms occur.

To manually stop a recording, you can either:

- Select the  hardkey again, or
- Select **[Clear All Tasks]** in the **[Record Setup]** menu.

Recordings stop automatically when:

- A recording is completed.
- The recorder runs out of paper.
- When the recorder has an alarm condition.

When a recording is stopped, the following markers will be added:

- Automatically stopped recording: print two columns of '*' at the end of the report.
- Manually or abnormally stopped recording: print one column of '*' at the end of the report.

19.4 Setting up the Recorder

19.4.1 Accessing the Record Setup Menu

By selecting **[Main Menu]**→**[Record Setup >>]**, you can access the **[Record Setup]** menu.

19.4.2 Selecting Waveforms for Recording

The recorder can record up to 3 waveforms at a time. You can select, in turn, **[Waveform 1]**, **[Waveform 2]** and **[Waveform 3]** in the **[Record Setup]** menu, and then select the waveforms you want. You can also turn off a waveform recording by selecting **[Off]**. These settings are intended for realtime and scheduled recordings.

19.4.3 Setting the Realtime Recording Length

After starting a realtime recording, the recording time depends on your monitor's settings. In the **[Record Setup]** menu, select **[Length]** and toggle between **[8 s]** and **[Continuous]**.

- **[8 s]**: record 4-second waveforms respectively before and after current moment.
- **[Continuous]**: record the waveforms from the current moment until stopped manually.

19.4.4 Setting the Interval between Timed Recordings

Timed recordings start automatically at preset intervals. Each recording lasts 8 seconds. To set the interval between timed recordings: in the [Record Setup] menu, select [Interval] and then select the appropriate setting.

19.4.5 Changing the Recording Speed

In the [Record Setup] menu, select [Paper Speed] and toggle between [25 mm/s] and [50 mm/s]. This setting is for all recordings containing waveforms.

19.4.6 Clearing Recording Tasks

In the [Record Setup] menu, select [Clear All Tasks]. All queued recording tasks are cleared and the current recording is stopped.

19.5 Loading Paper

1. Use the latch at the upper right of the recorder door to pull the door open.
2. Insert a new roll into the compartment as shown below.
3. Close the recorder door.
4. Check if paper is loaded correctly and the paper end is feeding from the top.

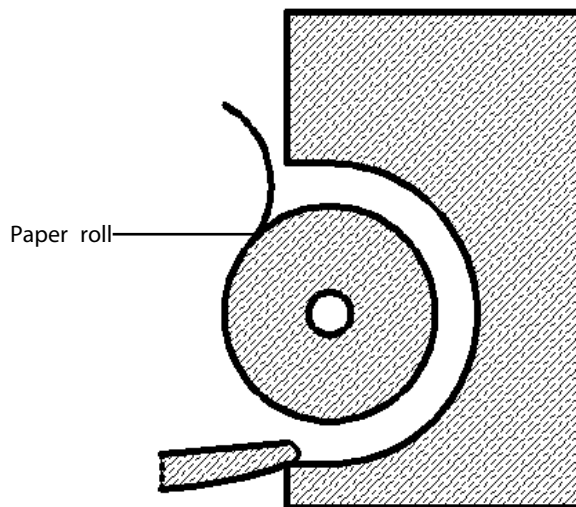

CAUTION

- Use only specified thermal paper. Otherwise, it may cause damage to the recorder's printhead, the recorder may be unable to print, or poor print quality may result.
 - Never pull the recorder paper with force when a recording is in process. Otherwise, it may cause damage to the recorder.
 - Do not leave the recorder door open unless you reload paper or remove troubles.
-

19.6 Removing Paper Jam

If the recorder works incorrectly or produces unusual sounds, check if there is a paper jam first. If a paper jam is detected, follow this procedure to remove it:

1. Open the recorder door.
2. Take out the paper and tear off the draped part.
3. Reload the paper and close the recorder door.

19.7 Cleaning the Recorder Printhead

If the recorder has been used for a long time, deposits of paper debris may collect on the printhead compromising the print quality and shortening the lifetime of the roller. Follow this procedure to clean the printhead:

1. Take measures against the static electricity such as Disposable Wrist Strap for the work.
2. Open the recorder door and take out the paper.
3. Gently wipe around the printhead using cotton swabs dampened with alcohol.
4. After the alcohol has completely been dried, reload the paper and close the recorder door.

 **CAUTION**

-
- **Do not use anything that may destroy the thermal element.**
 - **Do not add unnecessary force to the thermal head.**
-

20 Other Functions

20.1 Analog Output

The monitor provides analog output signals to accessory equipment via the multifunctional connector on the rear of the monitor. To obtain analog output signals, connect the accessory equipment such as an oscilloscope, etc. to the monitor.

NOTE

- **The analog output feature is seldom applied in clinical applications. You can contact your service personnel for more details.**
-

20.2 Exporting the Log

The monitor stores system status information, including failures, abnormality, and technical alarms, into the log. You can export the log to a USB drive.

To export the log,

1. Connect a USB drive to the monitor's USB connector.
2. Select [**Main Menu**]→[**Maintenance >>**]→[**User Maintenance >>**]→enter the required password→[**Others >>**].
3. Select [**Export Log**].

20.3 Transferring Data

You can transfer the patient data saved in the monitor to a PC via a crossover network cable or within a LAN for data management, review or print.

20.3.1 Data Export System

You must install the data export system on the intended PC before performing the data transfer operation. Refer to the document accompanying the installation CD-ROM for installation instructions.

The data transfer feature supports patient management, data review, data format conversion, print, etc. in addition to data transfer. Refer to the help file of the system software for more details.

20.3.2 Transferring Data by Different Means

NOTE

- **Never enter the data transfer mode when the monitor is in normal operation or performs monitoring. You must re-start the monitor to exit the data transfer mode.**
-

Transfer data via a crossover network cable

Before transferring data using a crossover network cable, do as follows:

1. Connect one end of the crossover network cable to the monitor and the other end to the PC.
2. Set the IP address of the PC. This IP address must be in the same network segment with that of the monitor.
3. Make sure that the data export system is active on the PC.

Then, follow this procedure to transfer data:

1. Select [**Main Menu**]→[**Patient Data >>**]→[**Transfer Data**].
2. Select [**Yes**] from the popup message box.
3. Input the IP address already set on the PC.
4. Select [**Start**] to start transferring data.

Transfer data within a LAN

Before transferring data within a LAN, do as follows:

1. Connect the monitor and the intended PC into the same LAN and acquire the PC's IP address.
2. Make sure that the data export system is active on the PC.

Follow the same procedure as via a crossover network cable to transfer data.

20.4 Nurse Call

The monitor provides a nurse call connector to output nurse call signal when a userdefined alarm occurs. To obtain nurse call signal, use the nurse call cable (**PN: 009-003116-00**) we supply to connect the hospital nurse call system to the nurse call connector of the monitor and then follow this procedure:

1. Select [**Main Menu**]→[**Maintenance >>**]→[**User Maintenance >>**]→enter the required password.
2. Select [**Others >>**] to access the [**Others**] menu.
3. Select [**Nurse Call Setup >>**] to change the nurse call settings as follows:
 - Select [**Signal Type**] and toggle between [**Pulse**] and [**Continuous**].
 - ◆ [**Pulse**]: the nurse call signals are pulse signals and each pulse lasts 1 second. When multiple alarms occur simultaneously, only one pulse signal is outputted. If an alarm occurs but the previous one is not cleared yet, a new pulse signal will also be outputted.
 - ◆ [**Continuous**]: the nurse call signal lasts until the alarm ends, i.e. the duration of a nurse call signal equals to that of the alarm condition.

- Select **[Contact Type]** and toggle between **[Normally Open]** and **[Normally Closed]**.
 - ◆ **[Normally Open]**: select if your hospital's nurse call relay contact is normally open.
 - ◆ **[Normally Closed]**: select if your hospital's nurse call relay contact is normally closed.
- Select **[Alm Lev]** and set the alarm level for nurse call-triggering alarms.
- Select **[Alarm Cat.]** and then select the category to which the nurse call-triggering alarms belong.

Alarm conditions are indicated to nurses only when:

- The nurse call system is enabled,
- An alarm that meets your preset requirements occurs, and
- The monitor is not in the alarm paused or silence status.

WARNING

- **To obtain the nurse call signal, use the nurse call cable (PN: 009-003116-00) we supply. Otherwise the nurse call function will not work and the monitor may be damaged.**
- **Do not rely exclusively on the nurse call system for alarm notification. Remember that the most reliable alarm notification combines audible and visual alarm indications with the patient's clinical condition.**

NOTE

- **If no setting is selected from [Alm Lev] or [Alarm Cat.], no nurse call signal will be triggered whatever alarms occur.**

20.5 Network Connection

20.5.1 Setting the Network Type

The monitor supports both wired and wireless network. To set the network type, you can select **[Main Menu]**→**[Maintenance>>]**→**[User Maintenance>>]**→enter the required password→**[Network Setup >>]**→**[Monitor Network Setup>>]**. In the **[Monitor Network Setup>>]** menu, set the **[Network Type]** to **[WLAN]** or **[LAN]**.

20.5.2 Wireless Network

The monitors can be connected to a wireless network via a built-in Wi-Fi module. To set the wireless network:

1. Select **[Main Menu]**→**[Maintenance>>]**→**[User Maintenance>>]**→enter the required password→**[Network Setup >>]**.
2. Set the **[Network Type]** to **[WLAN]**.
3. Select **[WLAN Setup >>]** to access the **[WLAN Setup]** menu.
4. Configure the **[Network Name (SSID)]**, **[Security Type]**, **[User Name]** and **[Password]**.
5. Click **[Ok]** to confirm the setting.

To test the availability of the wireless network, follow this procedure:

1. Select **[WLAN Test >>]** in the **[WLAN Setup]** menu.

2. Enter the [**IP Address**] of wireless AP in the [**WLAN Test >>**] menu.
3. Click [**Connection Test**].

The Wi-Fi device used in the monitor is in compliance with IEEE 802.11b/g/n.

20.5.3 Setting the IP Address, Subnet Mask and Gateway

In the [**Network Setup**] menu, you can set IP address, subnet mask and gateway. You should not change the monitor's IP address randomly. If you want to know details about IP address setup, contact the technical personnel in charge of the CMS.

NOTE





- **The design, installation, restruction and maintenance of the wireless network's distribution shall be performed by authorized service personnel of our company.**
 - **The existence of obstacles (such as wall) will exert impact on data transferring or even cause network interruption.**
 - **The Central Monitoring System is capable of connecting up to 32 bedside monitors via the wireless network.**
-



21 Batteries

21.1 Overview

This monitor is designed to operate on rechargeable Lithium-ion battery power during intra-hospital patient transfer or whenever the power supply is interrupted. The battery is charged automatically when the monitor is connected to AC power, no matter the monitor is powered on or not. Whenever the AC power is interrupted during monitoring, the monitor will automatically run power from the internal batteries.

On-screen battery symbols indicate the battery status as follows:

-  Indicates that the battery works correctly. The solid portion represents the current charge level of the battery in proportion to its maximum charge level.
-  Indicates that the battery has low charge level and needs to be charged. In this case, the monitor provides an alarm message.
-  Indicates that the battery is almost depleted and needs to be charged immediately. Otherwise, the monitor will shut down automatically.
-  Indicates that no battery is installed.

The capacity of the internal battery is limited. If the battery charge is too low, a technical alarm will be triggered and the message  or  displayed. At this moment, apply AC power to the monitor. Otherwise, the monitor will power off automatically before the battery is completely depleted.

21.2 Replacing a Battery

When the monitor operates on battery power, make sure the monitor is power off before replacing a battery. To replace a battery, follow this procedure:

1. Open the battery door.

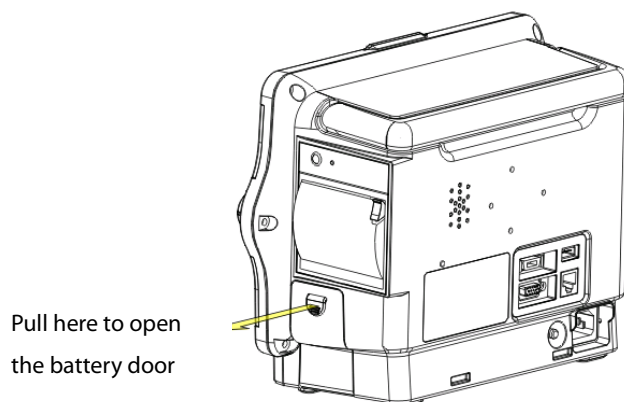

2. Push aside the latch fixing the battery to be replaced and remove the battery.
3. Insert a battery into the slot with its contact point inward.
4. Close the battery door.

21.3 Battery Guidelines

Life expectancy of a battery depends on how frequent and how long it is used. For a properly maintained and stored lithium ion battery, its life expectancy is about 3 years. For more aggressive use models, life expectancy can be less. We recommend replacing lithium ion batteries every 3 years.

To get the most out of the battery, observe the following guidelines:

- The battery performance test must be performed every two years, before monitor repairs, or whenever the battery is suspected as being the source of the problems.
- Condition a battery once when it is used or stored for 3 months, or when its operating time becomes noticeably shorter.
- Take out the battery before the monitor is transported or will not be used for more than 3 months.
- Remove the battery from the monitor if it is not being used regularly. (Leaving the battery in a monitor that is not in regular use will shorten the life of the battery).
- The shelf life of a Lithium Ion battery is about 6 months when the battery is stored with the battery power being 50% of the total power. In 6 months the battery power must be depleted before the Lithium Ion battery is fully charged. Then run the monitor on this fully charged battery. When its battery power becomes 50% of the total power, take out the battery from the monitor and store it.

WARNING

- **Keep the battery out of the reach of children.**
 - **Use only the battery specified by the manufacturer.**
 - **If the battery shows signs of damage or signs of leakage, replace it immediately. Do not use a faulty battery in the monitor.**
 - **Use only specified batteries.**
 - **Charge the batteries in this monitor.**
 - **High ambient temperature shortens battery run time.**
 - **Extremely high ambient temperature may cause battery overheat protection, resulting the monitor power off.**
 - **The Lithium-ion batteries have a service life of three years. Please replace your battery when it reaches the end of its service life. Failure to replace the battery may cause serious damage to your device from battery overheating.**
-

21.4 Battery Maintenance

Conditioning a Battery

A battery should be conditioned before it is used for the first time. A battery conditioning cycle is one uninterrupted charge of the battery, followed by an uninterrupted battery discharge and charge. Batteries should be conditioned regularly to maintain their useful life.

NOTE

- **The battery charge level indicator does not indicate the capacity or operating time of the battery. It only indicates the current battery charge level. The actual battery capacity decreases over time with the use of the battery. For an old battery, its capacity and operating time may not fulfill battery specifications even the battery charge level indicates the battery is in full charge. Please replace the battery if its operating time is significantly lower than the specified time.**
-

To condition a battery, follow this procedure:

1. Disconnect the monitor from the patient and stop all monitoring or measuring.
2. Insert the battery in need of conditioning in the battery slot of the monitor.
3. Apply AC power to the monitor and allow the battery to charge uninterrupted for 10 hours.
4. Remove AC power and allow the monitor to run from the battery until it shuts off.
5. Apply AC power again to the monitor and allow the battery to charge uninterrupted for 10 hours.
6. This battery is now conditioned and the monitor can be returned to service.

Checking a Battery

The battery performance test must be performed every two years, before monitor repairs, or whenever the battery is suspected as being the source of the problems. The performance of a rechargeable battery may deteriorate over time. To check the performance of a battery, follow this procedure:

1. Disconnect the monitor from the patient and stop all monitoring or measuring.
2. Apply AC power to the monitor and allow the battery to charge uninterrupted for 10 hours.
3. Remove AC power and allow the monitor to run from the battery until it shuts off.
4. The operating time of battery reflects its performance directly.

Please replace the battery or contact with the maintenance personnel if its operating time is significantly lower than the specified time.

NOTE

- **The battery might be damaged or malfunctioned if its operating time is too short after being fully charged. The operating time depends on the configuration and operation. For example, measuring NIBP more frequently will also shorten the operating time.**
 - **When a battery has visual signs of damage, or no longer holds a charge, it should be replaced. Remove the old battery from the monitor and recycle it properly.**
-

21.5 Battery Recycling

When a battery has visual signs of damage, or no longer holds a charge, it should be replaced. Remove the old battery from the monitor and recycle it properly. To dispose of the batteries, follow local laws for proper disposal.

 **WARNING**

- **Do not disassemble batteries, or dispose of them in fire, or cause them to short circuit. They may ignite, explode, leak or heat up, causing personal injury.**
-

22 Care and Cleaning

Use only the substances approved by Mindray and methods listed in this chapter to clean or disinfect your equipment.

Warranty does not cover damage caused by unapproved substances or methods.

We make no claims regarding the efficacy of the listed chemicals or methods as a means for controlling infection. For the method to control infection, consult your hospital's Infection Control Officer or Epidemiologist.

In this chapter we only describe cleaning and disinfection of the main unit. For the cleaning and disinfection of other reusable accessories, refer to instructions for use of corresponding accessories.

22.1 General Points

Keep your equipment and accessories free of dust and dirt. To avoid damage to the equipment, follow these rules:

- Always dilute according to the manufacturer's instructions or use the lowest possible concentration.
- Do not immerse part of the equipment into liquid.
- Do not pour liquid onto the equipment or accessories.
- Do not allow liquid to enter the case.
- Never use abrasive materials (such as steel wool or silver polish), or erosive cleaners (such as acetone or acetone-based cleaners).

WARNING

- **Be sure to shut down the system and disconnect all power cables from the outlets before cleaning the equipment.**
-
-

CAUTION

- **If you spill liquid on the equipment or accessories, contact Mindray or your service personnel.**
-
-

NOTE

- **To clean or disinfect reusable accessories, refer to the instructions delivered with the accessories.**
-
-

22.2 Cleaning

Your equipment should be cleaned on a regular basis. If there is heavy pollution or lots of dust and sand in your place, the equipment should be cleaned more frequently. Before cleaning the equipment, consult your hospital's regulations for cleaning the equipment.

Recommended cleaning agents are:

- sodium hypochlorite bleach (diluted)
- Hydrogen peroxide (3%)
- Ethanol (70%)
- Isopropanol (70%)

To clean your equipment, follow these rules:

1. Shut down the monitor and disconnect it from the power line.
2. Clean the display screen using a soft, clean cloth dampened with a glass cleaner.
3. Clean the exterior surface of the equipment using a soft cloth dampened with the cleaner.
4. Wipe off all the cleaning solution with a dry cloth after cleaning if necessary.
5. Dry your equipment in a ventilated, cool place.

22.3 Disinfecting

Disinfection may cause damage to the equipment and is therefore not recommended for this monitor unless otherwise indicated in your hospital's servicing schedule. Cleaning equipment before disinfecting is recommended.

The recommended disinfectants include: ethanol 70%, isopropanol 70%, Perform classic concentrate OXY (KHSO₄ solution).



-
- **Never use EtO or formaldehyde for disinfection.**
-

23 Maintenance

WARNING

- **Failure on the part of the responsible individual hospital or institution employing the use of this equipment to implement a satisfactory maintenance schedule may cause undue equipment failure and possible health hazards.**
 - **The safety checks or maintenance involving any disassembly of the equipment should be performed by professional servicing personnel. Otherwise, undue equipment failure and possible health hazards could result.**
 - **If you discover a problem with any of the equipment, contact your service personnel or Mindray.**
-

23.1 Regular Inspection

Before the first use, after your monitor has been used for 6 to 12 months, or whenever your monitor is repaired or upgraded, a thorough inspection should be performed by qualified service personnel to ensure the reliability.

Follow these guidelines when inspecting the equipment:

- Make sure that the environment and power supply meet the requirements.
- Inspect the equipment and its accessories for mechanical damage.
- Inspect all power cords for damage, and make sure that their insulation is in good condition.
- Make sure that only specified accessories are applied.
- Inspect if the alarm system functions correctly.
- Make sure that the recorder functions correctly and the recorder paper meets the requirements.
- Make sure that the batteries meet the performance requirements.
- Make sure that the monitor is in good working condition.

In case of any damage or abnormality, do not use the monitor. Contact the hospital's biomedical engineers or your service personnel immediately.

23.2 Maintenance and Testing Schedule

The following maintenance and tests, except for visual inspection, power on test, touchscreen calibration, battery check, and recorder check, shall be carried out by the service personnel only. Contact your service personnel if any maintenance is required. Make sure to clean and disinfect the equipment before any test and maintenance.

Check/Maintenance Item		Recommended Frequency
Preventative Maintenance Tests		
Visual inspection		When first installed or reinstalled.
NIBP test	Pressure check	1. If the user suspects that the measurement is incorrect. 2. Following any repairs or replacement of relevant module. 3. At least once a year.
	Leakage test	
Sidestream and Microstream CO ₂ tests	Leakage test	
	Performance test	
Performance Tests		
ECG verification	Performance test	1. If the user suspects that the measurement is incorrect. 2. Following any repairs or replacement of relevant module. 3. At least once every two years. Note: At least once a year is recommended for NIBP and CO ₂ .
Resp performance test		
SpO ₂ test		
NIBP test	Pressure check	
	Leakage test	
Temp test		
IBP test	Performance test	
Sidestream and Microstream CO ₂ tests	Leakage test	
	Performance test	
Nurse call function test		
Analog output performance test		
Electrical Safety Tests		
Electrical safety tests		At least once every two years.
Other Tests		
Power-on test		1. When first installed or reinstalled. 2. Following any repairs or replacement of any main unit parts.
Touchscreen calibration		1. When the touchscreen appears abnormal. 2. After the touchscreen is replaced.
Recorder check		Following any repair or replacement of the recorder.
Battery check	Functionality test	1. When first installed. 2. Whenever a battery is replaced.
	Performance test	Once every six months or if the battery run time reduced significantly.

23.3 Checking Monitor and Module Information

To view the information about system start time, self-test, etc., select **[Main Menu]→[Maintenance >>]→[Monitor Information >>]**. You can print out the information for the convenience of troubleshooting. The information will not be saved during shut down.

You can also view the information about the monitor configuration and system software version by selecting **[Main Menu]→[Maintenance >>]→[Software Version >>]**.

23.4 ECG Verification

The ECG signal may be inaccurate due to hardware or software problems. As a result, the ECG wave amplitude becomes greater or smaller.

You can print out the square wave and wave scale and then measure the difference between them if necessary. If the difference exceeds 5%, contact your service personnel.

23.5 NIBP Leakage Test

The NIBP leakage test checks the integrity of the system and of the valve. It is required at least once a year or when you doubt the measured NIBP. Contact your service personnel to perform NIBP leakage test.



23.6 NIBP Accuracy Test

The NIBP accuracy test is required at least once a year or when you doubt the measured NIBP. Contact your service personnel to perform NIBP accuracy test.

23.7 CO₂ Test

For sidestream and microstream CO₂ modules, a calibration is needed every year or when the measured values have a great deviation. For maintream CO₂ module, no calibration is needed. Contact your service personnel to calibrate CO₂.

23.8 Calibrating the Touchscreen

1. Select [**Main Menu**]→[**Maintenance >>**]→[**Cal. Touchscreen**].
2.  will, in turn, appear at different positions of the screen.
3. Select each  as it appears on the screen.
4. After the calibration is completed, the message [**Screen Calibration Completed!**] is displayed. Select [**Ok**] to confirm the completion of the calibration.

23.9 Electrical Safety Tests

Refer to *E Electrical Safety Inspection*.

24 Accessories

The accessories listed in this chapter comply with the requirements of IEC 60601-1-2 when in use with the monitor.

WARNING

- Use accessories specified in this chapter. Using other accessories may cause damage to the monitor or not meet the claimed specifications.
 - Single-use accessories are not designed to be reused. Reuse may cause a risk of contamination and affect the measurement accuracy.
 - Check the accessories and their packages for any sign of damage. Do not use them if any damage is detected.
-
-

24.1 ECG Accessories

ECG Electrodes

Model	Quantity	Patient Category	Part No.
/	Crocodile clip	/	9101-20-58104

12-Pin Separable Trunk Cables

Leadwire supported	Compatible with	Type	Part No.
3-leadwire	AHA	Defibrillation-proof	0010-30-42720
3-leadwire	AHA	ESU-proof	0010-30-42724
3-leadwire	/	Defibrillation-proof	040-000754-00
3/5-leadwire	AHA	Defibrillation-proof	0010-30-42719
3/5-leadwire	AHA	ESU-proof	0010-30-42723

Cable Sets

3-Electrode Cable Sets					
Type	Compatible with	Model	Part No.	Length	Remark
Clip	AHA	EL6303A	0010-30-42731	1m	Long
		EL6301A	0010-30-42726	0.6m	/
		EL6305A	0010-30-42896	1m	Long
Snap	AHA	EL6301B	0010-30-42734	1m	Long
		EL6311B	040-000146-00	1m	Long

5-Electrode Cable Sets					
Type	Compatible with	Model	Part No.	Length	Remark
Clip	AHA	EL6501A	0010-30-42727	0.6m	/
		EL6503A	0010-30-42729	1m to 1.4m	Long
Snap	AHA	EL6501B	0010-30-42735	1.4m for RL and LL; 1m for others	Long

24.2 SpO₂ Accessories

Extension Cable

Module type	Remarks	Part No.
Nellcor	8 pins	0010-20-42712

SpO₂ Sensors

The SpO₂ sensor material that patients or other staff will come into contact with has undertaken the bio-compatibility test and is verified to be in compliance with ISO 10993-1.

Nellcor SpO ₂ Module				
Reusable	VetSat(V-Sat)	1.1 m	clip	9101-10-58134

- The extension cable must be used with the matching SpO₂ sensor.
- Wavelength emitted by the sensors intended for Nellcor SpO₂ module: red light: 660 nm, infrared light: 890 nm.
- The maximum photic output consumption of the sensor is less than 18 mW.

The information about the wavelength range and maximum photic output consumption can be especially useful to clinicians, for example, clinicians performing photodynamic therapy.

24.3 NIBP Accessories

Tubing

Type	Length	Part No.
Reusable	3 m	6200-30-09688
Reusable	3 m	6200-30-11560

Reusable Cuff

Model	Limb Circumference (cm)	Bladder Width (cm)	Part No.
/	10 to 19	9.2	0683-15-0001-01
/	18 to 26	12.2	0683-15-0002-01
/	25 to 35	15.1	0683-15-0003-01
/	33 to 47	18.3	0683-15-0004-01
/	46 to 66	22.5	0683-15-0005-01
/	25 to 35	/	0683-15-0006-01
/	33 to 47	/	0683-15-0007-01

Single-Patient Cuff

Model	Limb Circumference (cm)	Bladder Width (cm)	Part No.
CM1500A	3.1 to 5.7	2.2	001B-30-70692 (20 pcs/box)
CM1500B	4.3 to 8.0	2.9	001B-30-70693 (20 pcs/box)
CM1500C	5.8 to 10.9	3.8	001B-30-70694 (20 pcs/box)
CM1500D	7.1 to 13.1	4.8	001B-30-70695 (20 pcs/box)
/	10 to 19	7.2	0683-14-0001-01
/	18 to 26	9.8	0683-14-0002-01
/	25 to 35	13.1	0683-14-0003-01
/	33 to 47	16.5	0683-14-0004-01
/	46 to 66	20.5	0683-14-0005-01
/	25 to 35	/	0683-14-0006-01
/	33 to 47	/	0683-14-0007-01 (10 pcs/box)

24.4 Temp Accessories

Temp Cable

Type	Model	Remark	Part No.
Extension cable (reusable)	MR420B	Applicable to sensor MR411 and MR412	0011-30-37391
TEMP adapter cable (2-pin to audio)	MR421	/	0010-30-43056

Temp Probes

Type	Model	Measurement Site	Part No.
Reusable	MR401B	Esophageal/Rectal	0011-30-37392
	MR403B	Skin	0011-30-37393
	MR402B	Esophageal/Rectal	0011-30-37394
	MR404B	Skin	0011-30-37395
Disposable	MR411	Esophageal/Rectal	0011-30-90446
	MR412	Skin	0011-30-90447

24.5 IBP/ICP Accessories

Material	Part No.	
IBP cable adapter (12 pin to 6 pin)	0010-20-42795	
Accessories Kit No.	Components	Part No.
Hospira	IM2201 12Pin IBP Cable	001C-30-70759
BD	IM2202 12Pin IBP Cable	001C-30-70757
ICP		
Model	Material	Part No.
Gaeltec TYPE.S13	12Pin ICP cable	0010-30-42742
Gaeltec ICT/B	Intracranial Pressure Transducer	0010-10-12151

It is proved through tests that the following accessories are compatible with the monitor. Only the accessories proceeded by "*" are available from our company. If you want to purchase other accessories, contact respective manufacturers and make sure if these accessories are approved for sale in local.

Manufacturer	Accessories
Smith Medical (Medex)	MX961Z14 Logical Cable, to be used in connection with the Adapter Cable (0010-20-42795) MX960 Reusable Transducer Kit MX261 Logical Clamp For Transducer Bracket MX262 Logical Clamp For 2 Transducer Mount Plates MX960E6441 Logical Transducer Mounting Plate (More Logical Clamps are available from Medex. For detailed information, contact Medex.)
Braun	IBP Reusable Cable (REF: 5203511), to be used in connection with the Adapter Cable (0010-20-42795) Combitrans Monitoring Set (contact Braun for detailed information) Combitrans Attachment Plate Holder (REF:5215800) Combitrans Attachment Plate (contact Braun for detailed information)
Memscap	*Truck cable (0010-21-43082) SP844 Physiological Pressure Transducer 844-26 Monitoring Line Set 84X-49 Mounting Bracket

Manufacturer	Accessories
Utah	Reusable Blood Pressure Monitor Interface Cable (REF: 650-206) Deltran Disposable Pressure Transducer System (More Deltran sensors are available from Utah. For detailed information, contact Utah.) Pole Mount Unit (ERF: 650-150) Deltran Three Slot Organizer, Attaches to I.V. Pole Mount (REF: 650-100) Deltran Four Slot Organizer, Attaches to I.V. Pole Mount (REF: 650-105)
Edwards	* IBP Truwave Reusable Cable (0010-21-12179) Pressure Monitoring Kit With Truwave Disposable Pressure Transducer. (More Truwave sensors are available from Edwards. For detailed information, contact Edwards.) DTSC IV Pole Clamp for Model DTH4 Backplate Holder DTH4 Disposable Holder for DPT

24.6 CO₂ Accessories

Sidestream CO₂ module

Material	Remark	Part No.
DRYLINE Watertrap	Reusable	9200-10-10530
DRYLINE Watertrap		9200-10-10574
Sampling Line 2.5m	Disposable	9200-10-10533
Sampling Line, 2.5m		9200-10-10555
Nasal CO ₂ Sample Cannula		M02A-10-25937
Nasal CO ₂ Sample Cannula		M02A-10-25938
Nasal CO ₂ Sample Cannula		M02B-10-64509
DRYLINE Airway Adapter		Straight, disposable

Mainstream CO₂ Module

Material	Model	Remark	Part No.
Airway adapter	6063	Disposable	0010-10-42662
	6421	Disposable, with mouthpiece	0010-10-42663
	7007	Reusable	0010-10-42665
	6312	Disposable	0010-10-42664
	7053	Reusable	0010-10-42666
Mask	9960STD	/	0010-10-42670
	9960LGE	large	0010-10-42669
	9960PED	/	0010-10-42671
Cable management straps	6934-00	/	0010-10-42667
Sensor holding clips	8751	/	0010-10-42668
Sensor	1022386	Reusable	6800-30-50760

24.7 Others

Material	Part No.
Lithium battery	022-000008-00
U.S. power cord	0012-25-0001
Grounding cable	1000-21-00122
Nurse call cable	009-003116-00
Analog output cable	009-003117-00
Synchronization cable	009-003118-00
LCD display, 17"	0000-10-11284
USB drive, 4G	023-000218-00
Recorder	TR6F-30-67306
Thermal paper	A30-000001---
Wall mount bracket for external display	045-000936-00
Transport stand for rolling stand	045-003428-00
Quick Release for wall mount	045-003424-00
M series wall mount with Quick Release	045-003427-00

A Product Specifications

A.1 Monitor Safety Specifications

A.1.1 Classifications

The monitor is classified, according to IEC60601-1:

Type of protection against electrical shock	Class I, equipment energized from an external and internal electrical power source.
Degree of protection against electrical shock	Type BF defibrillation proof for CO ₂ Type CF defibrillation proof for ECG, RESP, TEMP, SpO ₂ , NIBP, and IBP
Mode of operation	Continuous
Degree of protection against harmful ingress of water	IPX1

A.1.2 Environmental Specifications

Main unit		
Item	Operating conditions	Storage conditions
Temperature (°C)	0 to 40	-20 to 60
Relative humidity (noncondensing)	15% to 95%	10% to 95%
Barometric (mmHg)	427.5 to 805.5	120 to 805.5

Microstream CO₂ module		
Item	Operating conditions	Storage conditions
Temperature (°C)	0 to 40	-20 to 60
Relative humidity (noncondensing)	15% to 95%	10% to 95%
Barometric (mmHg)	430 to 790	430 to 790

Sidestream CO₂ module		
Item	Operating conditions	Storage conditions
Temperature (°C)	5 to 40	-20 to 60
Relative humidity (noncondensing)	15% to 95%	10% to 95%
Barometric (mmHg)	430 to 790	430 to 790

NOTE

- The environmental specifications of unspecified parameters are the same as those of the main unit.
-

A.2 Power Supply Specifications

AC power	
Line voltage	100 to 240 VAC ($\pm 10\%$)
Current	1.1 to 0.5 A
Frequency	50/60 Hz ($\pm 3\text{Hz}$)
Battery (standard configuration)	
Battery Type	Chargeable Lithium-Ion, 11.1DVC, 2.6 Ah
Run time	≥ 2 h when powered by a new fully-charged battery (25°C, SpO ₂ cable connected, ECG cable and Temp cable not connected, auto NIBP measurements at an interval of 15 minutes)
Charge time	Less than 4 hours to 90% Less than 4.5 hours to 100%
Shutdown delay	at least 5 min (after a low battery alarm first occurs)
Battery (optional configuration)	
Battery Type	Chargeable Lithium-Ion, 11.1DVC, 4.5 Ah
Run time	≥ 4 h when powered by a new fully-charged battery (25°C, SpO ₂ cable connected, ECG cable and Temp cable not connected, auto NIBP measurements at an interval of 15 minutes)
Charge time	Less than 7.5 hours to 90% Less than 8 hours to 100%
Shutdown delay	at least 5 min (after a low battery alarm first occurs)

A.3 Physical Specifications

Model	Size	Weight	Remark
iMEC8 Vet	210×270×112 mm	≤ 3.2 kg	Standard configuration, touchscreen, battery, recorder, without accessories

A.4 Hardware Specifications

A.4.1 Display

Host display			
	Screen Size (diagonal)	Screen type	Resolution
iMEC8 Vet	8.4	color LED backlight LCD	at least 800×600 pixels
External display			
Screen type	Medical-grade TFT LCD		

A.4.2 Recorder

Method	Thermal dot array
Paper width	50 mm±1 mm
Paper speed	25 mm/s, 50 mm/s with accuracy within ±5%
Number of waveform channels	Maximum 3

A.4.3 LEDs

Alarm lamp	1 (two color coded: yellow and red)
Power on LED	1 (green)
AC power LED	1 (green)
Battery LED	1 (green)

A.4.4 Audio Indicator

Speaker	Give alarm tones (45 to 85 dB), key tones, QRS tones; support PITCH TONE and multi-level tone modulation; alarm tones comply with IEC60601-1-8.
---------	---

A.4.5 Monitor Interface Specifications

Power	1 AC power input connector
Wired network	1 RJ45 connector, 100 Base-TX, IEEE 802.3
USB	1 connector, USB 2.0
Equipotential Grounding Terminal	1
Multifunctional connector	1
VGA connector	1

A.4.6 Outputs

Analog Output	
Standard	Meets the requirements of IEC60601-1 for short-circuit protection and leakage current
ECG Analog Output	
Bandwidth (-3dB; reference frequency: 10Hz)	Diagnostic mode: 0.05 to 150 Hz Monitor mode: 0.5 to 40 Hz Surgical mode: 1 to 20 Hz ST mode: 0.05 to 40 Hz
QRS delay	≤ 25 ms (in diagnostic mode, and with Paced off)
Sensitivity	1V/mV ±5%
PACE rejection/enhancement	Pace enhancement Signal amplitude: $V_{oh} \geq 2.5V$ Pulse width: 10ms±5% Signal rising and falling time: ≤100µs
IBP Analog Output	
Bandwidth (-3dB; reference frequency:1Hz)	DC to 40 Hz
Max transmission delay	30 ms (with Notch off)
Sensitivity	1 V/100 mmHg ±5%
Nurse Call Signal	
Amplitude	High level: 3.5 to 5 V, providing a maximum of 10 mA output current; Low level: < 0.5 V, receiving a maximum of 5 mA input current.
Rising and falling time	≤1 ms
Defib Sync Pulse	
Output impedance	≤100 Ω
Max time delay	35 ms (R-wave peak to leading edge of pulse)
Amplitude	High level: 3.5 to 5 V, providing a maximum of 10 mA output current; Low level: < 0.5 V, receiving a maximum of 5 mA input current.
Pulse width	100 ms ±10%
Rising and falling time	≤1 ms
Alarm output (Network connector)	
Alarm delay time from the monitor to remote equipment	The alarm delay time from the monitor to remote equipment is ≤2 seconds, measured at the monitor's signal output connector.

A.5 Data Storage

Trends	Trends: 120 hours, at 1 min resolution Mid-length trends: 4 hours, at 5 s resolution Minitrends: 1 hour, at 1 s resolution
Parameter alarms	100 physiological alarms and manual events and related parameter waveforms.
Arrh. events	100 arrhythmia events and relate waveforms and parameters.
NIBP measurements	1000 sets
Full-disclosure waveforms	48 hours at maximum. The specific storage time depends on the waveforms stored and the number of stored waveforms.

A.6 Wireless Network

Standards	IEEE 802.11b/g/n, support Wi-Fi
-----------	---------------------------------

A.7 Measurement Specifications

The adjustable range of alarm limits is the same with the measurement range of signals unless otherwise specified.

A.7.1 ECG

ECG	
Standards	Meet standards of EC11, EC13, EN60601-2-27/IEC60601-2-27 and IEC60601-2-25
Lead set	3-lead: I, II, III 5-lead: I, II, III, aVR, aVL, aVF, V
ECG standard	AHA, IEC
Display sensitivity	1.25 mm/mV (X0.125), 2.5 mm/mV (X0.25), 5 mm/mV (X0.5), 10 mm/mV (X1), 20 mm/mV (X2), 40 mm/mV (X4) Accuracy: $\pm 10\%$
Sweep speed	6.25 mm/s, 12.5 mm/s, 25 mm/s, 50 mm/s Accuracy: $\pm 10\%$
Bandwidth (-3dB)	Diagnostic mode: 0.05 to 150 Hz Monitor mode: 0.5 to 40 Hz Surgical mode: 1 to 20 Hz ST mode: 0.05 to 40 Hz
Common mode rejection ratio (with Notch off)	Diagnostic mode: ≥ 90 dB Monitor mode: ≥ 105 dB Surgical mode: ≥ 105 dB ST mode: > 105 dB(with Notch on)
Notch	50/60 Hz
Differential input impedance	≥ 5 M Ω
Input signal range	± 8 mV (peak-to-peak value)
Accuracy of reappearing input signal	Based on EC11 to determine system total error and frequency response.
Electrode offset potential tolerance	± 500 mV
Lead-off detection current	Measuring electrode: < 0.1 μ A Drive electrode: < 1 μ A
Input offset current	≤ 0.1 μ A
Baseline recovery time	< 5 s (after defibrillation)
Patient leakage current	< 10 μ A
Calibration signal	1mV (peak-to-peak value) Accuracy: $\pm 5\%$
ESU protection	Cut mode: 300 W Coagulate mode: 100 W Recovery time: ≤ 10 s

	In compliance with the requirements in clause 4.2.9.14 of ANSI/AAMI EC 13:2002	
ESU noise suppression	Based on the test method in clause 5.2.9.14 of EC 13, use ECG lead wires which are in compliance with AAMI. Compared with ECG baseline, the noise of peak to peak value ≤ 2 mV.	
Pace Pulse		
Pace pulse markers	Pace pulses meeting the following conditions are labelled with a PACE marker: Amplitude: ± 2 to ± 700 mV Width: 0.1 to 2 ms Rise time: 10 to 100 μ s	
Pace pulse rejection	When tested in accordance with the ANSI/AAMI EC13: Sections 4.1.4.1 and 4.1.4.3, the heart rate meter rejects all pulses meeting the following conditions. Amplitude: ± 2 to ± 700 mV Width: 0.1 to 2 ms Rise time: 10 to 100 μ s	
Pacer pulse detector rejection of fast ECG signals	2.9 V/s RTI when measured in accordance with ANSI/AAMI EC13: Section 4.1.4.3.	
HR		
Measurement range	3-, 5-lead ECG	15 to 350 bpm
Resolution	1 bpm	
Accuracy	± 1 bpm or $\pm 1\%$, whichever is greater.	
Sensitivity	200 μ V (lead II)	
HR averaging method	In compliance with the requirements in Clause 4.1.2.1 d) of ANSI/AAMI EC13, the following method is used: If the last 3 consecutive RR intervals are greater than 1200 ms, the 4 most recent RR intervals are averaged to compute the HR. Otherwise, heart rate is computed by subtracting the maximum and minimum ones from the most recent 12 RR intervals and then averaging them. The HR value displayed on the monitor screen is updated every second.	
Response to irregular rhythm	In compliance with the requirements in Clause 4.1.2.1 e) of ANSI/AAMI EC13, the heart rate after 20 seconds of stabilization is displayed as follows: Ventricular bigeminy (3a): 80 ± 1 bpm Slow alternating ventricular bigeminy (3b): 60 ± 1 bpm Rapid alternating ventricular bigeminy (3c): 120 ± 1 bpm Bidirectional systoles (3d): 90 ± 2 bpm	
Response time to heart rate change	Meets the requirements of ANSI/AAMI EC13: Section 4.1.2.1 f). From 80 to 120 bpm: less than 11 s From 80 to 40 bpm: less than 11 s	
Time to alarm for tachycardia	Meets the requirements of ANSI/AAMI EC13: section 4.1.2.1 g).	

(not available in USA)	Waveform 4ah - range: < 11 s 4a - range: < 11 s 4ad - range: < 11 s Waveform 4bh - range: < 11 s 4b - range: < 11 s 4bd - range: < 11 s
Tall T-wave rejection capability	When the test is performed based on part 4.1.2.1 c) of ANSI/AAMI EC 13-2002, the heart rate meter will reject all 100 ms QRS complexes with less than 1.2 mV of amplitude, and T waves with T-wave interval of 180 ms and those with Q-T interval of 350 ms.
Arrhythmia Analysis Classifications	Asystole, VFib/VTac, Vtac, Vent. Brady, Extreme Tachy, Extreme Brady, PVC, Couplet, Bigeminy, Trigeminy, R on T, VT>2, PVCs, Tachy, Brady, Missed Beats, Vent. Rhythm, PNP, PNC, Multif. PVC, Nonsus. Vtac, Pause, Irr. Rhythm
ST Segment Analysis (Not available in USA)	
Measurement range	-2.0 to 2.0 mV RTI
Accuracy	-0.8 to 0.8 mV: ±0.02 mV or ±10%, whichever is greater. Beyond this range: Not specified.
Refreshing rate	10 s
Resolution	0.01 mV

A.7.2 Resp

Technique	Trans-thoracic impedance	
Lead	Options are lead I and II. The default is lead II.	
Respiration excitation waveform	<300 µA RMS, 62.8 kHz (±10%)	
Baseline impedance range	200 to 2500Ω (using an ECG cable with 1kΩ resistance)	
Bandwidth	0.2 to 2 Hz (-3 dB)	
Sweep speed	3 mm/s, 6.25 mm/s, 12.5 mm/s, 25 mm/s, or 50 mm/s Accuracy: ±10%	
Respiration Rate		
Measurement range	0 to 150 rpm	
Resolution	1 rpm	
Accuracy	7 to 150 rpm: ±2 rpm or ±2%, whichever is greater 0 to 6 rpm: Not specified.	
Apnea alarm time	10 s, 15 s, 20 s, 25 s, 30 s, 35 s, 40 s	
Alarm limit	Range (rpm)	Step (rpm)
RR High	(low limit + 2) to 150	1
RR Low	0 to (high limit - 2)	

A.7.3 SpO₂

Alarm limit	Range (%)	Step (%)
SpO ₂ High	(low limit + 2) to 100	1
SpO ₂ Low	Mindray, Masimo: Desat to (high limit – 2) Nellcor: Desat or 20 (whichever is greater) to (high limit – 2)	
Desat	0 to (high limit – 2)	

Mindray SpO₂ Module

Standards	Meet standards of ISO9919
*Measurement accuracy verification: The SpO ₂ accuracy has been verified in human experiments by comparing with arterial blood sample reference measured with a CO-oximeter. Pulse oximeter measurement are statistically distributed and about two-thirds of the measurements are expected to come within the specified accuracy range compared to CO-oximeter measurements.	
SpO ₂ measurement range	0 to 100%
Resolution	1%
Accuracy	70 to 100%: ±3% 0% to 69%: Not specified.
Refreshing rate	1 s
PI measurement range	0.05% to 20%

Masimo SpO₂ Module

Standards	Meet standards of ISO9919
SpO ₂ measurement range	1 to 100%
Resolution	1%
Accuracy	70 to 100%: ±3% (measured without motion) 70 to 100%: ±3% (measured with motion) 1% to 69%: Not specified.
Refreshing rate	1 s
SpO ₂ averaging time	2-4 s, 4-6 s, 8 s, 10 s, 12 s, 14 s, 16 s
Low perfusion conditions	Pulse amplitude: >0.02% Light penetration: >5%
Low perfusion SpO ₂ accuracy	±2%
PI measurement range	0.02~20 %

Nellcor SpO₂ Module

Standards	Meet standards of ISO9919
Measurement range	0 to 100%
Resolution	1%
Accuracy	70 to 100%: ±3% 0% to 69%: Not specified.
*: When the SpO ₂ sensor is applied for neonatal patients as indicated, the specified accuracy range is increased by ±1%, to compensate for the theoretical effect on oximeter measurements of fetal hemoglobin in neonatal blood.	

A.7.4 PR

Alarm limit	Range (bpm)	Step (bpm)
PR High	(low limit +2) to 300	1
PR Low	15 to (high limit-2)	

PR from Mindray SpO₂ Module

Measurement range	20 to 254 bpm
Resolution	1 bpm
Accuracy	±3 bpm
Refreshing rate	1 s
SpO ₂ averaging time	7 s (when sensitivity is set to High) 9 s (when sensitivity is set to Medium) 11 s (when sensitivity is set to Low)

PR from Masimo SpO₂ Module

Measurement range	25 to 240 bpm
Resolution	1 bpm
Accuracy	±3 bpm (measured without motion) ±5 bpm (measured with motion)
Refreshing rate	1 s
SPO ₂ averaging time	2-4 s, 4-6 s, 8 s, 10 s, 12 s, 14 s, 16 s
Low perfusion conditions	Pulse amplitude: >0.02% Light penetration: >5%
Low perfusion PR accuracy	±3 bpm

PR from Nellcor SpO₂ Module

Measurement range	20 to 300 bpm
Resolution	1 bpm
Accuracy	20 to 250 bpm: ±3 bpm 251 to 300 bpm, not specified
Refreshing rate	1 s

PR from IBP Module

Measurement range	25 to 350 bpm
Resolution	1 bpm
Accuracy	±1 bpm or ±1%, whichever is greater
Refreshing rate	1 s

A.7.5 NIBP

Standards	Meet standards of EN60601-2-30/IEC60601-2-30, EN1060-1, EN1060-3,EN1060-4 and SP10			
Technique	Oscillometry			
Mode of operation	Manual, Auto and STAT			
Auto mode repetition intervals	1 min, 2 min, 2.5 min, 3 min, 5 min, 10 min, 15 min, 20 min, 30 min, 1 h, 1.5 h, 2 h, 3 h, 4 h, 8 h			
STAT mode cycle time	5 min			
Max measurement time	90 s			
Measurement ranges (mmHg)		Big	Medium	Small
	Systolic:	25 to 285	25 to 230	25 to 135
	Diastolic:	10 to 250	10 to 200	15 to 125
	Mean:	15 to 260	15 to 215	10 to 115
Accuracy	Max mean error: ± 5 mmHg Max standard deviation: 8 mmHg			
Resolution	1 mmHg			
Initial cuff inflation pressure range (mmHg)	Big	80 to 280	Medium:	80 to 210
	Small:	60 to 140		
Default initial cuff inflation pressure (mmHg)	Big	160	Medium:	140
	Small:	90		
Software overpressure protection	Big	297 \pm 3 mmHg	Medium:	240 \pm 3 mmHg
	Small:	147 \pm 3 mmHg		
PR				
Measurement range	40 to 240 bpm			
Resolution	1 bpm			
Accuracy	± 3 bpm or $\pm 3\%$, whichever is greater			
Alarm limit	Range (mmHg)			Step (mmHg)
Sys High	Big: (low limit+5) to 270 Medium: (low limit+5) to 200 Small: (low limit+5) to 135			5
Sys Low	40 to (high limit-5)			
Mean High	Big: (low limit+5) to 230 Medium: (low limit+5) to 165 Small: (low limit+5) to 110			
Mean Low	20 to (high limit-5)			
Dia High	Big: (low limit+5) to 210 Medium: (low limit+5) to 150 Small: (low limit+5) to 100			
Dia Low	10 to (high limit-5)			

*Measurement accuracy verification: the blood pressure measurements measured with this device are in compliance with the American National Standard for Electronic or Automated Sphygmomanometers (ANSI/AAMI SP10) in terms of mean error and standard deviation by comparing with intra-arterial measurements (depending on the configuration) in a typical patient population.

A.7.6 Temp

Standards	Meet standard of EN12470-4
Technique	Thermal resistance
Measurement range	0 to 50 °C (32 to 122 °F)
Resolution	0.1 °C
Accuracy	±0.1 °C(without probe)
Refreshing rate	1 s
Minimum time for accurate measurement	Body surface: <100 s Body cavity: <80 s

Alarm limit	Range	Step
T1/T2 High	(low limit +1) to 50 °C	0.1 °C
T1/T2 Low	0.1 to (high limit -1) °C	
TD High	0.1 to 50 °C	

A.7.7 IBP

Standards	Meet standard of EN60601-2-34/IEC60601-2-34.
Technique	Direct invasive measurement
IBP	
Measurement range	-50 to 300 mmHg
Resolution	1 mmHg
Accuracy	±2% or ±1 mmHg, whichever is greater (without sensor)
Refreshing rate	1 s
Pressure transducer	
Excitement voltage	5 VDC, ±2%
Sensitivity	5 µV/V/mmHg
Impedance range	300 to 3000Ω

Alarm limit	Range (mmHg)	Step (mmHg)
Sys High	(low limit + 2) to 300	1
Mean High		
Dia High		
Sys Low	-50 to (high limit – 2)	
Mean Low		
Dia Low		

A.7.8 CO₂

Measurement mode	Sidestream, microstream
Technique	Infrared absorption

Sidestream CO₂ Module

Standard	Meet standard of ISO 21647
CO ₂ Measurement range	0 to 99 mmHg
Accuracy*	0 to 40 mmHg: ±2 mmHg 41 to 76 mmHg: ±5% of the reading 77 to 99 mmHg: ±10% of the reading
Accuracy drift	Meet the requirement for measurement accuracy within 6 hours
Resolution	1 mmHg
Sample flowrate	70 ml/min, 100 ml/min
Sample flowrate tolerance	15% or 15 ml/min, whichever is greater.
Warm-up time	Iso accuracy mode: ≤45s Full accuracy mode: ≤10 min,
Rise time	Measured with a watertrap and a 2.5-meter sampling line <400 ms @ 70 ml/min <330 ms @ 100 ml/min <300 ms @ 120 ml/min <240 ms @ 150 ml/min
Gas sampling delay time	Measured with a watertrap and a 2.5-meter sampling line: <4 s @ 100 ml/min <4.5 s @ 70 ml/min
awRR measurement range	0 to 120 rpm
awRR measurement precision	±2 rpm
Apnea time	10 s, 15 s, 20 s, 25 s, 30 s, 35 s, 40 s

Note: The response time is the sum of the rise time and the delay time.

Effect of interference gases on CO ₂ measurements		
Gas	Concentration (%)	Quantitative effect*
N ₂ O	≤60	±1 mmHg
Hal	≤4	
Sev	≤5	
Iso	≤5	
Enf	≤5	
Des	≤15	±2 mmHg
*: means an extra error should be added in case of gas interference when CO ₂ measurements are performed between 0-40mmHg.		

Alarm limit	Range	Step
EtCO ₂ High	(low limit + 2) to 99 mmHg	1 mmHg
EtCO ₂ Low	1 to (high limit - 2) mmHg	
FiCO ₂ High	1 to 99 mmHg	

awRR High	(low limit + 2) to 150 rpm	1 rpm
awRR Low	0 to (high limit - 2) rpm	

Microstream CO₂ Module

Standard	Meet standard of ISO 21647	
CO ₂ Measurement range	0 to 99 mmHg	
Accuracy*	0 to 38 mmHg: ±2 mmHg	
	39 to 99 mmHg: ±5% of the reading+0.08% of (the reading-38)	
Accuracy drift	Meet the requirement for measurement accuracy within 6 hours	
* Accuracy applies for respiration rate up to 80 rpm. For respiration rate above 80 rpm, the accuracy is 4 mmHg or ±12% of the reading, whichever is greater. for EtCO ₂ exceeding 18 mmHg. In the presence of interfering gases, the above accuracy is maintained to within 4%.		
Resolution	1 mmHg	
Sample flow rate	50 ^{-7.5} ₊₁₅ ml/min	
Initialization time	30 s (typical)	
Response time	Measured with a FilterLine of standard length: 2.9 s (typical) 4.5 s (Maximum) (The response time is the sum of the rise time and the delay time) Rise time: <190 ms (10% to 90%) Delay time: 2.7 s (typical)	
awRR measurement range	0 to 150 rpm	
awRR measurement accuracy	0 to 70 rpm: ±1 rpm	
	71 to 120 rpm: ±2 rpm	
	121 to 150 rpm: ±3 rpm	
Apnea alarm time	10 s, 15 s, 20 s, 25 s, 30 s, 35 s, 40 s	
Alarm limit	Range	Step
EtCO ₂ High	(low limit + 2) to 99 mmHg	1 mmHg
EtCO ₂ Low	1 to (high limit - 2)mmHg	
FiCO ₂ High	1 to 99 mmHg	
awRR High	(low limit + 2) to 150 rpm	1 rpm
awRR Low	0 to (high limit - 2) rpm	

FOR YOUR NOTES

B EMC and Radio Regulatory Compliance

B.1 EMC

The device meets the requirements of IEC 60601-1-2. All the accessories listed in **Chapter 25** also meet the requirements of IEC 60601-1-2 when in use with this device.

Note

- **Using accessories, transducers and cables other than those specified may result in increased electromagnetic emission or decreased electromagnetic immunity of the device.**
 - **The device or its components should not be used adjacent to or stacked with other equipment. If adjacent or stacked use is necessary, the device or its components should be observed to verify normal operation in the configuration in which it will be used.**
 - **The device needs special precautions regarding EMC and needs to be installed and put into service according to the EMC information provided below.**
 - **Other devices may interfere with this device even though they meet the requirements of CISPR.**
 - **When the inputted signal is below the minimum amplitude provided in technical specifications, erroneous measurements could result.**
 - **Portable and mobile communication equipment may affect the performance of this device.**
 - **Other devices that have RF transmitter or source may affect this device (e.g. cell phones, PDAs, and PCs with wireless function).**
-

Guidance and Declaration - Electromagnetic Emissions		
The device is intended for use in the electromagnetic environment specified below. The customer or the user of the device should assure that it is used in such an environment.		
Emission tests	Compliance	Electromagnetic environment - guidance
Radio frequency (RF) emissions CISPR 11	Group 1	The device uses RF energy only for its internal function. Therefore, its RF emissions are very low and are not likely to cause any interference in nearby electronic equipment.
RF emissions CISPR 11	Class A	The device is suitable for use in all establishments other than domestic and those directly connected to the public low-voltage power supply network that supplies buildings used for domestic purposes
Harmonic emissions IEC61000-3-2	Class A	
Voltage Fluctuations/Flicker Emissions IEC 61000-3-3	Complies	

 **WARNING**

- **This equipment/system is intended for use by healthcare professionals only. This equipment/ system may cause radio interference or may disrupt the operation of nearby equipment. It may be necessary to take mitigation measures, such as re-orienting or relocating the [ME EQUIPMENT or ME SYSTEM] or shielding the location.**

Guidance and Declaration - Electromagnetic Immunity			
The device is intended for use in the electromagnetic environment specified below. The customer or the user of the device should assure that it is used in such an environment.			
Immunity test	IEC60601 test level	Compliance level	Electromagnetic environment - guidance
Electrostatic discharge (ESD) IEC 61000-4-2	±6 kV contact ±8 kV air	±6 kV contact ±8 kV air	Floors should be wood, concrete or ceramic tile. If floors are covered with synthetic material, the relative humidity should be at least 30%.
Electrical fast transient/burst IEC 61000-4-4	±2 kV for power supply lines ±1 kV for input/output lines	±2 kV for power supply lines ±1 kV for input/output lines	Mains power quality should be that of a typical commercial or hospital environment.
Surge IEC 61000-4-5	±1 kV line(s) to line(s) ±2 kV line(s) to earth	±1 kV line(s) to line(s) ±2 kV line(s) to earth	
Voltage dips, short interruptions and voltage variations on power supply input lines IEC 61000-4-11	<5 % U_T (>95 % dip in U_T) for 0.5 cycle 40 % U_T (60 % dip in U_T) for 5 cycles 70 % U_T (30 % dip in U_T) for 25 cycles <5 % U_T (>95 % dip in U_T) for 5 s	<5 % U_T (>95 % dip in U_T) for 0.5 cycle 40 % U_T (60 % dip in U_T) for 5 cycles 70 % U_T (30 % dip in U_T) for 25 cycles <5 % U_T (>95 % dip in U_T) for 5 s	Mains power quality should be that of a typical commercial or hospital environment. If the user of our product requires continued operation during power mains interruptions, it is recommended that our product be powered from an uninterruptible power supply or a battery.
Power frequency (50/60 HZ) magnetic field IEC 61000-4-8	3 A/m	3 A/m	Power frequency magnetic fields should be at levels characteristic of a typical location in a typical commercial or hospital environment.
Note: U_T is the AC mains voltage prior to application of the test level.			

Guidance and Declaration - Electromagnetic Immunity

The device is intended for use in the specified electromagnetic environment. The customer or the user of the device should assure that it is used in such an environment as described below.

Immunity test	IEC60601 test level	Compliance level	Electromagnetic environment - guidance
Conducted RF IEC61000-4-6	3 Vrms 150 kHz to 80 MHz	3Vrms	Portable and mobile RF communications equipment should be used no closer to any part of the system, including cables, than the recommended separation distance calculated from the equation appropriate for the frequency of the transmitter. Recommended separation distances: $d = 1.2\sqrt{P}$
Radiated RF IEC61000-4-3	3V/m 80MHz to 2.5GHz	3V/m (Resp: 1V/m)	Recommended separation distances: 80 MHz~800 MHz $d = 1.2\sqrt{P}$ (Resp: $d = 3.5\sqrt{P}$) 800MHz-2.5GHz $d = 2.3\sqrt{P}$ (Resp: $d = 7\sqrt{P}$) Where, P is the maximum output power rating of the transmitter in watts (W) according to the transmitter manufacturer and d is the recommended separation distance in meters (m). Field strengths from fixed RF transmitters, as determined by an electromagnetic site survey ^a , should be less than the compliance level in each frequency range ^b . Interference may occur in the vicinity of equipment marked  with the following symbol:

Note 1: At 80 MHz to 800 MHz, the separation distance for the higher frequency range applies.

Note 2: These guidelines may not apply in all situations. Electromagnetic propagation is affected by absorption and reflection from structures, objects and people.

Note 3: The device that intentionally receives RF electromagnetic energy at the exclusion band (2395.825MHz-2487.645MHz) is exempt from the essential performance requirements, but remains safe.

a Field strengths from fixed transmitters, such as base stations for radio (cellular/cordless) telephones and land mobile radios, amateur radio, AM and FM radio broadcast and TV broadcast cannot be predicted theoretically with accuracy. To assess the electromagnetic environment due to fixed RF transmitters, an electromagnetic site survey should be considered. If the measured field strength in the location in which the [ME EQUIPMENT or ME SYSTEM] is used exceeds the applicable RF compliance level above, the [ME EQUIPMENT or ME SYSTEM] should be observed to verify normal operation. If abnormal performance is observed, additional measures may be necessary, such as re-orienting or relocating the [ME EQUIPMENT or ME SYSTEM].

b For Resp field strength should be less than 1V/m.

 **WARNING**

- **The device is configured with a wireless network connector to receive wireless signal. Other devices may interfere with this device even though they meet the requirements of CISPR.**

Recommended separation distances between portable and mobile RF communications equipment and the device			
The device is intended for use in an electromagnetic environment in which radiated RF disturbances are controlled. The customer or the user of the device can help prevent electromagnetic interference by maintaining a minimum distance between portable and mobile RF communications equipment (transmitters) and the device as recommended below, according to the maximum output power of the communications equipment.			
Rated maximum output power of transmitter (W)	Separation distance in meters (m) according to frequency of the transmitter		
	150 kHz ~ 80 MHz $d = 1.2\sqrt{P}$	80 MHz ~ 800 MHz $d = 1.2\sqrt{P}$ (Resp: $d = 3.5\sqrt{P}$)	800 MHz ~ 2.5 GHz $d = 2.3\sqrt{P}$ (Resp: $d = 7\sqrt{P}$)
0.01	0.12	0.12 (0.35)	0.23 (0.70)
0.1	0.38	0.38 (1.11)	0.73 (2.22)
1	1.20	1.20 (3.50)	2.30 (7.00)
10	3.80	3.80 (11.07)	7.30 (22.14)
100	12.00	12.00 (35.00)	23.00 (70.00)
For transmitters rated at a maximum output power not listed above, the recommended separation distance d in metres (m) can be estimated using the equation applicable to the frequency of the transmitter, where P is the maximum output power rating of the transmitter in watts (W) according to the transmitter manufacturer.			
Note 1: At 80 MHz and 800 MHz, the separation distance for the higher frequency range applies.			
Note 2: These guidelines may not apply in all situations. Electromagnetic propagation is affected by absorption and reflection from structures, objects and people.			

B.2 Radio Regulatory Compliance

RF parameters

Item	Description		
	IEEE 802.11b	IEEE 802.11g	IEEE 802.11n
Operating Frequency Band (MHz)	2412 - 2472	2412 - 2472	2412 - 2472
Modulation	DSSS and CCK	OFDM	OFDM
Transmitter Output Power (dBm)	<20	<20	<20

The device configured with the WM1010BGN wireless module complies with part 15 of the FCC Rules. Operation is subject to the condition that this device does not cause harmful interference.

Operation of this equipment requires the prior coordination with a frequency coordinator designated by the FCC for the Wireless Medical Telemetry Service.

This Wi-Fi device complies with Canadian ICES-001. Cet appareil ISM est conforme a la norme NMB-001 du Canada.

FCC and Industry Canada Radio Compliance of the device configured with WM1010BGN wireless module: This device complies with Part 15 of the FCC Rules and RSS-210 of Industry Canada. Operation is subject to the following two conditions: (1) this device may not cause harmful interference, and (2) this device must accept any interference received, including interference that may cause undesired operation. Any changes or modifications to this equipment not expressly approved by Mindray may cause harmful radio frequency interference and void your authority to operate this equipment.

The maximum antenna gain permitted complies with the e.i.r.p. limits as stated in RSS-210.

The maximum antenna gain permitted complies with the e.i.r.p. limits specified for point-to-point operation, as stated in RSS-210.



The radio device used in this product is in compliance with the essential requirements and other relevant provisions of Directive 1999/5/EC (Radio Equipment and Telecommunications Terminal Equipment Directive).



WARNING

-
- **Keep a distance of at least 20cm away from the device when Wi-Fi function is in use.**
-
-

FOR YOUR NOTES

C Default Configurations

This chapter lists some of the most important factory default settings in configuration management. You cannot change the factory default configuration itself. However, you can make changes to the settings from the factory default configuration and then save the changed configuration as a user configuration. The last column of the following tables is for your notes and review.

Note: In this chapter, O.M means the monitor's operating mode. Column C refers to the settings that can be changed in configuration management. Column M refers to the settings that can be changed in monitoring mode.

C.1 Parameters Configuration

C.1.1 ECG

ECG Setup

Item Name	O.M		General	User Defaults
	C	M		
Lead Set	*	*	Auto	
Alm Source	*	*	HR	
Alarm	*	*	On	
Alm Lev	*	*	Med	
HR/PR High	*	*	200	
HR/PR Low	*	*	100	
Sweep	*	*	25 mm/s	
Beat Vol	*	*	2	
Paced		*	No	
Notch Filter	*	*	Weak	
Gain	*	*	X1	
Filter	*	*	Monitor	
ECG Display	*	*	Normal	

ST Analysis

Item Name	O.M		General	User Defaults
	C	M		
ST Analysis	*	*	Off	
Alarm	*	*	Off	
Alm Lev	*	*	Med	
ST-X High	*	*	when ST Unit is mV: 0.20 when ST Unit is mm: 2.0	
ST-X Low	*	*	when ST Unit is mV: -0.20 when ST Unit is mm: -2.0	

Item Name	O.M		General	User Defaults
ISO	*	*	-80 ms	
J			48 ms	
ST			J + 60 ms	

X represents I, II, III, aVR, aVL, aVF, V.

Arrh. Analysis

Item Name	O.M		General	User Defaults
	C	M		
Arrhythmia Threshold Settings				
PVCs High	*	*	10	
Tachy	*	*	120	
Brady	*	*	50	
Asys. Delay	*	*	5	
Vtac Rate	*	*	130	
Vtac PVCs	*	*	6	
Multif. PVC's Window	*	*	15	
Extreme Tachy	*	*	160	
Extreme Brady	*	*	35	
Vbrd Rate	*	*	40	
Vbrd PVCs	*	*	5	
Pause Time	*	*	2	
Arrhythmia Alarm Settings				
PVCs/min Alarm	*	*	Off	
R on T Alarm	*	*	Off	
Nonsus. Vtac Alarm	*	*	Off	
Vent. Rhythm Alarm	*	*	Off	
Bigeminy Alarm	*	*	Off	
Trigeminy Alarm	*	*	Off	
Asystole Alarm	*	*	On	
VFib/VTac Alarm	*	*	On	
Vtac Alarm	*	*	On	
Vent. Brady Alarm	*	*	On	
Extreme Tachy Alarm	*	*	On	
Extreme Brady Alarm	*	*	On	
X Alarm	*	*	Off	
Asystole Alm Lev	*	*	High	
VFib/VTac Alm Lev	*	*	High	
Vtac Alm Lev	*	*	High	
Vent. Brady Alm Lev	*	*	High	
Extreme Tachy Alm Lev	*	*	High	
Extreme Brady Alm Lev	*	*	High	
VT>2 Alm Lev	*	*	Low	

Item Name	O.M		General	User Defaults
	C	M		
Pause Alm Lev	*	*	Low	
Couplet Alm Lev	*	*	Prompt	
PVC Alm Lev	*	*	Prompt	
Irr. Rhythm Alm Lev	*	*	Prompt	
PNP Alm Lev	*	*	Prompt	
PNC Alm Lev	*	*	Prompt	
Missed Beats Alm Lev	*	*	Prompt	
X Alm Lev	*	*	Med	
X Alm Rec	*	*	Off	

X represents a certain arrhythmia event. Refer to the Specifications chapter for details. The X in "X Alm Lev" refers to all arrhythmia events except for those specially marked ones.

C.1.2 RESP

Item Name	O.M		General	User Defaults
	C	M		
Alarm	*	*	On	
Alm Lev	*	*	Med	
Sweep	*	*	6.25 mm/s	
Lead	*	*	II	
Gain	*	*	X2	
RR High	*	*	100	
RR Low	*	*	30	
Apnea Delay	*	*	15	
Detection Mode	*	*	Auto	
RR Source		*	Auto	

C.1.3 PR

Item Name	O.M		General	User Defaults
	C	M		
Alarm	*	*	On	
Alm Lev	*	*	Med	
HR/PR High	*	*	200	
HR/PR Low	*	*	100	
PR Source	*	*	SpO ₂	
Beat Vol	*	*	2	

C.1.4 SpO₂

Item Name	O.M		General	User Defaults
	C	M		
Alarm	*	*	On	
Alm Lev	*	*	Med	
SpO ₂ High	*	*	95	
SpO ₂ Low	*	*	90	
Desat Limit	*	*	80	
Sweep	*	*	25 mm/s	
NIBP Simul		*	Off	
Sensitivity (Mindray)	*	*	Med	
Sensitivity (Masimo)	*	*	Normal	
Averaging (Masimo)	*	*	8 s	
Sat-Seconds (Nellcor)	*	*	0 s	
PI Zoom	*	*	No	

C.1.5 Temp

Item Name	O.M		General	User Defaults
	C	M		
Alarm	*	*	On	
Alm Lev	*	*	Med	
T1/T2 High (°C)	*	*	38.0	
T1/T2 Low (°C)	*	*	35.0	
TD High (°C)	*	*	2.0	

C.1.6 NIBP

Item Name	O.M		General	User Defaults
	C	M		
Alarm	*	*	On	
Alm Lev	*	*	Med	
Interval	*	*	15 min	
NIBP End Tone	*	*	Off	
Clock	*	*	On	
Cuff Press. (mmHg)	Big	*	*	80
	Medium			60
	Small			40
Initial Pressure (mmHg)	Big	*	*	160
	Medium			140
	Small			90
Alarm Limits				
NIBP-S High	Big	*	*	160

Item Name		O.M		General	User Defaults
		C	M		
(mmHg)	Medium			120	
	Small			90	
NIBP-S Low (mmHg)	Big	*	*	90	
	Medium			70	
	Small			40	
NIBP-M High (mmHg)	Big	*	*	110	
	Medium			90	
	Small			70	
NIBP-M Low (mmHg)	Big	*	*	60	
	Medium			50	
	Small			25	
NIBP-D High (mmHg)	Big	*	*	90	
	Medium			70	
	Small			60	
NIBP-D Low (mmHg)	Big	*	*	50	
	Medium			40	
	Small			20	

C.1.7 IBP

Item Name		O.M		General	User Defaults
		C	M		
IBP 1 Label		*	*	Art	
IBP 2 Label		*	*	CVP	
Alarm		*	*	On	
Alm Lev		*	*	Med	
P1 Measure		*	*	All	
P2 Measure		*	*	All	
P3 Measure		*	*	Mean	
P4 Measure		*	*	Mean	
PPV Measurement		*	*	Off	
PPV Source		*	*	Auto	
Sensitivity		*	*	Med	
Sweep		*	*	25 mm/s	
Sweep (PAWP measurement window)		*	*	12.5 mm/s	
Filter		*		12.5 Hz	
Gridlines		*	*	Off	
IBP Label Order Setup		*	*	Art, pArt, CVP, pCVP, ICP, PA, AO, UAP, FAP, BAP, LV, LAP, RAP, UVP, P1, P2, P3, P4	
Art, Ao, UAP, BAP, FAP, LV, P1-P2 Arterial Pressure Alarm Limits					
IBP-S High (mmHg)		*	*	90	

Item Name	O.M		General	User Defaults
	C	M		
IBP-S Low (mmHg)	*	*	55	
IBP-M High (mmHg)	*	*	70	
IBP-M Low (mmHg)	*	*	35	
IBP-D High (mmHg)	*	*	60	
IBP-D Low (mmHg)	*	*	20	
PA Alarm Limits				
PA-S High (mmHg)	*	*	60	
PA-S Low (mmHg)	*	*	24	
PA-M High (mmHg)	*	*	26	
PA-M Low (mmHg)	*	*	12	
PA-D High (mmHg)	*	*	4	
PA-D Low (mmHg)	*	*	-4	
CVP, LAP, RAP, ICP, UVP, P3-P4 Venous Pressure Alarm Limits				
IBP-M High (mmHg)	*	*	4	
IBP-M Low (mmHg)	*	*	0	
Art, Ao, BAP, FAP, LV, P1-P2 Arterial Pressure Scale				
Scale (mmHg)	*	*	0-160	
PA Scale				
Scale (mmHg)	*	*	0-30	
CVP, LAP, RAP, ICP, UVP Scale				
Scale (mmHg)	*	*	0-20	
UAP, P3-P4 Venous Pressure Scale				
Scale (mmHg)	*	*	0-80	
IBP Overlapping Left Scale				
Scale (mmHg)	*	*	0-160	
IBP Overlapping Right Scale				
Scale (mmHg)	*	*	0-20	

C.1.8 CO₂

Item Name	O.M		General	User Defaults
	C	M		
Alarm	*	*	On	
Alm Lev	*	*	Med	
Operating Mode	*	*	Measure	
Sweep	*	*	6.25 mm/s	
Scale (mmHg)	*	*	50	
Apnea Delay	*	*	15	
RR Source		*	Auto	
Sidestream CO₂ Setup				
Flow Rate	*	*	70 ml/min	
BTPS Compen	*	*	Off	
N ₂ O Compen	*	*	0	
O ₂ Compen	*	*	21	
Des Compen	*	*	0	
Microstream CO₂ Setup				
BTPS Compen		*	Off	
Max Hold	*	*	20 s	
Auto Standby (min)	*	*	0	
Alarm Limits				
EtCO ₂ High (mmHg)	*	*	45	
EtCO ₂ Low (mmHg)	*	*	30	
FICO ₂ High (mmHg)	*	*	4	
RR High	*	*	100	
RR Low	*	*	30	

C.2 Routine Configuration

C.2.1 Alarm

Item Name	O.M		General	User Defaults
	C	M		
Alm Volume	*	*	2	
Reminder Vol	*	*	Low	
Recording Length	*	*	16 s	
Apnea Delay	*	*	15 s	
Alarm Delay	*	*	6 s	
ST Alarm Delay	*	*	30 s	

C.2.2 Screens

Item Name		O.M		General	User Defaults
		C	M		
Choose Screen		*	*	Normal Screen	
Display the ST segments on ECG screen		*	*	Unselected	
Select QuickKeys		*		NIBP Measure → Stop All → Review → Standby	
Select Wave Sequence for Normal Screen	1	*	*	ECG1	
	2			ECG2	
	3			SpO ₂ +PR	
	4			Any IBP	
	5			Any IBP	
	6			CO ₂	
	11			Resp	
Select Parameters for Big Numerics Screen	Parameter 1	*	*	ECG	
	Parameter 2			SpO ₂ +PR	
	Parameter 3			Resp	
	Parameter 4			NIBP	

C.2.3 Waveform

Item Name		O.M		General	User Defaults
		C	M		
Parameter/ Wave Colour	ECG	*		Green	
	NIBP			White	
	SpO ₂			Cyan	
	PR			Cyan	
	TEMP			White	
	Art/Ao/UAP/FAP /BAP/LV/P1~P4 (arterial pressure)			Red	
	PA			Yellow	
	CVP/ICP/P1~P4 (venous pressure)			Blue	
	LAP			Purple	
	RAP			Orange	
	UVP			Cyan	
	CO ₂			Yellow	
	RESP			Yellow	

C.2.4 Review

Item Name		O.M		General	User Defaults
		C	M		
Tabular Trends	Interval	*	*	30 min	
	Trend Group	*	*	Standard	
Graphic Trends	Trend Group	*	*	Standard	
Minitrend Length			*	2 h	
Full Disclosure	Save Waves	*	*	Save ECG1 by default.	

C.2.5 Event

Item Name		O.M		General	User Defaults
		C	M		
Waveform 1			*	II	
Waveform 2			*	I	
Waveform 3			*	Pleth	

C.2.6 Record

Item Name		O.M		General	User Defaults
		C	M		
Length			*	8 s	
Interval			*	Off	
Paper Speed			*	25 mm/s	
Alm Rec	X		*	Off	

X represents a parameter label.

C.2.7 Others

Item Name		O.M		General	User Defaults
		C	M		
Brightness			*	5	
Key Volume			*	2	
View Other Patient	Auto Alarm		*	On	

C.3 User Maintenance Items





Item Name		O.M		General	User Defaults
		C	M		
Changing Bed No.			*	Protected	
Atmospheric Pressure			*	760 mmHg	
Height Unit			*	cm	
Weight Unit			*	kg	
ST Unit			*	mV	
Press. Unit			*	mmHg	

Item Name	O.M		General	User Defaults
	C	M		
CVP Unit		*	cmH ₂ O	
CO ₂ Unit		*	mmHg	
Temp Unit		*	°C	
Network Type		*	LAN	
Latching Alarms	*	*	No	
Alarm Pause Time	*	*	2 min	
Minimum Alarm Volume	*	*	2	
Reminder Tone		*	Off	
Reminder Interval		*	3 min	
ECGLeadOff Lev.		*	Low	
SpO ₂ SensorOff Lev.		*	Low	
Alarm Tone Interval		*	High Level Alarm: 10 s Med/Low Level Alarm: 20 s	
Lethal Arrh. OFF		*	Disable	
Silence Other Bed		*	On	
Extended Arrh.		*	Enable	
Wave Line		*	Mediate	
ECG Standard		*	AHA	
Notch Freq.		*	50 Hz	
Data Transfer Method		*	USB Drive	
Transferred Data Length		*	4 h	
Para Switch Authority		*	Unprotected	
Parameter Switch	*	*	<ul style="list-style-type: none"> ■ When [Para Switch Authority] is set to [Protected]: Unselected ■ When [Para Switch Authority] is set to [Unprotected]: Selected 	
SpO ₂ Tone		*	Mode 1	
Signal Type		*	Continuous	
Contact Type		*	Normally Closed	
Nurse Call	Signal Type		**	Continuous
	Contact Type		*	Normally Closed
	Alm Lev	*	*	High, Med, Low
	Alarm Cat.	*	*	Phys., Tech.

D Alarm Messages

This chapter lists only the most important physiological and technical alarm messages. Some messages appearing on your monitor may not be included.

In this chapter:

The “I” field indicates how alarm indications are cleared: “A” means all alarm indications are cleared after the  hardkey is pressed, “B” indicates alarm lamp flashing and alarm tones are cleared and the alarm messages change to prompt messages after the  hardkey is pressed, and “C” indicates alarm lamp flashing and alarm tones are cleared and  appears before the alarm message after the  hardkey is pressed.

The “L” field indicates the alarm level: H means high, M means medium and L means low. “*” means the alarm level is user-adjustable.

XX represents a measurement or parameter label, such as ECG, NIBP, HR, ST-I, PVCs, RR, SpO₂, PR, etc.

In the “Cause and Solution” column, corresponding solutions are given instructing you to troubleshoot problems. If the problem persists, contact your service personnel.

D.1 Physiological Alarm Messages

Measurement	Alarm Messages	L	Cause and Solution
XX	XX Too High	M*	XX value has risen above the high alarm limit or fallen below the low alarm limit. Check the patient’s condition and check if the patient category and alarm limit settings are correct.
	XX Too Low	M*	
ECG	ECG Weak Signal	H	The ECG signal is so weak that the monitor can’t perform ECG analysis. Check the patient’s condition and the ECG connections.
	Asystole	H	Arrhythmia has occurred to the patient. Check the patient’s condition and the ECG connections.
	VFib/VTac	H	
	Vtac	H	
	Vent. Brady	H	
	Extreme Tachy	H	
	Extreme Brady	H	
	R on T	M*	
	VT>2	M*	
	Couplet	M*	
	PVCs/min	M*	
	Bigeminy	M*	
	Trigeminy	M*	
Tachy	M*		

Measurement	Alarm Messages	L	Cause and Solution
	Brady	M*	The pacer appears abnormal. Check the pacer.
	Missed Beats	M*	
	Irr. Rhythm	M*	
	Vent. Rhythm	M*	
	Multif. PVC	M*	
	Nonsus. Vtac	M*	
	Pause	M*	
	PNP	M*	
	PNC	M*	
Resp	Resp Apnea	H	The respiration signal was so weak that the monitor cannot perform respiration analysis. Check the patient's condition and the Resp connections.
	Resp Artifact	H	The patient's heartbeat has interfered with his respiration. Check the patient's condition and the Resp connections.
SpO ₂	SpO ₂ Desat	H	The SpO ₂ value has fallen below the desaturation alarm limit. Check the patient's condition and check if the alarm limit settings are correct.
	No Pulse	H	The pulse signal was so weak that the monitor cannot perform pulse analysis. Check the patient's condition, SpO ₂ sensor and measurement site.
CO ₂	CO ₂ Apnea	H	The patient stops breathing, or the respiration signal was so weak that the monitor cannot perform respiration analysis. Check the patient's condition and the RM connections.

D.2 Technical Alarm Messages

Measurement	Alarm Message	L	I	Cause and Solution
XX	XX SelfTest Err	H	C	An error occurred to the XX module, or there is a problem with the communications between the module and the monitor. Re-plug the module and restart the monitor, or plug the module into another monitor.
	XX Init Err	H	A	
	XX Init Err N	H	A	
	N is within 1 to 8			
	XX Comm Err	H	A	XX parameter limit is accidentally changed. Contact your service personnel.
	XX Comm Stop	H	C	
	XX Limit Err	L	C	
	XX Overrange	L	C	
ECG	ECG Lead Off	L*	B	The electrode has become detached from the patient or the lead wire has become disconnected from the adapter cable. Check the connections of the electrodes and leadwires.
	ECG YY Lead Off	L*	B	
	Note: YY represents the leadwires, V, LL, LA, RA, as per AHA standard, or C, F, L and R as per IEC standard.			

Measurement	Alarm Message	L	I	Cause and Solution
	ECG Noisy	L	A	The ECG signal is noisy. Check for any possible sources of signal noise around the cable and electrode, and check the patient for great motion.
	ECG Artifact	L	A	Artifacts are detected on the ECG analysis lead and as a result heart rate cannot be calculated and Asystole, Vfib and Vtac cannot be analyzed. Check the connections of the electrodes and leadwires and check for any possible source of interference around the cable and electrode. Check the patient's condition and check the patient for great motion.
	ECG High Freq. Noise	L	A	High frequency signals are detected on the ECG analysis lead. Check for any possible source of interference around the cable and electrode.
	ECG Low Freq. Noise	L	A	Low frequency signals are detected on the ECG analysis lead. Check for any possible source of interference around the cable and electrode.
	ECG Amplitude Too Small	L	C	The ECG amplitude didn't reach the detected threshold. Check for any possible source of interference around the cable and electrode.
	ECG Config. Err	L	C	ECG configuration is wrongly downloaded. Check the downloaded configuration and re-download the correct configuration.
Resp	Resp Disturbed	L	A	The respiration circuit is disturbed. Restart the monitor.
Temp	Temp Cal. Err	H	C	A calibration failed. Restart the monitor.
	T1 Sensor Off	L	A	The Temp sensor has become detached from the patient or the module. Check the sensor connections.
	T2 Sensor Off	L	A	
SpO ₂	SpO ₂ Sensor Off	L*	B	The SpO ₂ sensor has become detached from the patient or the module, or there is a fault with the SpO ₂ sensor, or an unspecified SpO ₂ sensor has been used. Check the sensor application site and the sensor type, and make sure if the sensor is damaged. Reconnect the sensor or use a new sensor.
	SpO ₂ Sensor Fault	L	C	
	SpO ₂ No Sensor	L	B	
	SpO ₂ Unknown Sensor	L	C	
	SpO ₂ Sensor Incompatible	L	C	
	SpO ₂ Too Much Light	L	C	There is too much light on the SpO ₂ sensor. Move the sensor to a place with lower level of ambient light or cover the sensor to minimize the ambient light.
	SpO ₂ Low Signal	L	C	The SpO ₂ signal is too low or too weak. Check the patient's condition and change the sensor application site. If the error persists, replace the sensor.
	SpO ₂ Weak Pulse	L	C	
	SpO ₂ Interference	L	C	The SpO ₂ signal has been interfered. Check for any possible sources of signal noise around the sensor and check the patient for great motion.
	SpO ₂ Board Fault	L	C	There is a problem with the SpO ₂ measurement board. Do not use the module and contact your service personnel.
NIBP	NIBP Loose Cuff	L	A	The NIBP cuff is not properly connected, or there is a leak in

Measurement	Alarm Message	L	I	Cause and Solution
	NIBP Air Leak	L	A	the airway.
	NIBP Pneumatic Leak	L	A	Check the NIBP cuff and pump for leakages.
	NIBP Cuff Type Wrong	L	A	The cuff type applied mismatches the patient category. Verify the patient category and replace the cuff.
	NIBP Air Pressure Err	L	A	An error occurred to the air pressure. Verify that the monitor application site meets the environmental requirements and check if there is any source that affects the air pressure.
	NIBP Weak Signal	L	A	The patient's pulse is weak or the cuff is loose. Check the patient's condition and change the cuff application site. If the error persists, replace the cuff.
	NIBP Signal Saturated	L	A	The NIBP signal is saturated due to excess motion or other sources.
	NIBP Overrange	L	A	The measured NIBP value is not within the specified range.
	NIBP Excessive Motion	L	A	Check the patient's condition and reduce the patient motion.
	NIBP Cuff Overpress.	L	A	The NIBP airway may be occluded. Check the airway and measure again.
	NIBP Equip Err	H	A	An error occurred during NIBP measurement and therefore the monitor cannot perform analysis correctly. Check the patient's condition and NIBP connections, or replace the cuff.
	NIBP Timeout	L	A	
		NIBP Measure Failed	L	A
NIBP Illegally Reset		L	A	
IBP	YY Sensor Off	L*	A	Check the sensor connection and reconnect the sensor.
	YY Disconnected	H	C	The liquid way is disconnected from the patient, or the three-way valve is open to the air. Check the connection of the liquid way, or check the valve is open to the patient. If the problem remains, contact the Customer Services Dept. for help.
	YY Non-Pulsatile	L	A	The catheter may be occluded. Please flush the catheter.
	YY represents an IBP label.			
CO ₂	CO ₂ Sensor High Temp	L	C	Check, stop using or replace the sensor.
	CO ₂ Sensor Low Temp	L	C	Check, stop using or replace the sensor.
	CO ₂ Temp Overrange	L	C	The operating temperature of the CO ₂ module goes beyond the specified range. After it restores within the specified range, the module will restart automatically.
	CO ₂ Airway High Press.	L	C	An error occurred in the airway pressure. Check the patient connection and patient circuit, and then restart the monitor.
	CO ₂ Airway Low Press.	L	C	
	CO ₂ High Barometric Press.	L	C	Check the CO ₂ connections, make sure that the monitor application site meets the requirements, and check for special

Measurement	Alarm Message	L	I	Cause and Solution
	CO ₂ Low Barometric Press.	L	C	sources that affect the ambient pressure. Restart the monitor.
	CO ₂ FilterLine Occluded	L	C	The airway or watertrap was occluded. Check the airway and remove the occlusion.
	CO ₂ No Watertrap	L	B	Check the watertrap connections.
	CO ₂ Check Adapter	L	A	There is a problem with the airway adapter. Check, clean or replace the adapter.
	CO ₂ FilterLine Err	L	C	Check if there is a leak in the CO ₂ sample line or the CO ₂ sample line has been occluded.
	CO ₂ Zero Failed	L	A	Check the CO ₂ connections. After the sensor's temperature becomes stabilized, perform a zero calibration again.
	CO ₂ System Err	L	A	Re-plug the module or restart the monitor.
	CO ₂ Check Cal.	L	C	Perform a calibration.
	CO ₂ Check Airway	L	C	An error occurred to the airway.
	CO ₂ No Filterline	L	A	Make sure that the filterline is connected.
	CO ₂ No Sensor	L	A	Make sure that the sensor is connected.
	CO ₂ Main Board Err	H	C	There is a problem with the CO ₂ module. Re-plug the module or restart the monitor.
	CO ₂ Checking Sensor	L	C	
	CO ₂ Replace Scrubber&Pump	L	C	
	CO ₂ 15V Overrange	H	C	
	CO ₂ Hardware Err	H	C	
Power	12V Too High	H	C	There is a problem with the system power supply. Restart the monitor.
	12V Too Low	H	C	
	5V Too High	H	C	
	5V Too Low	H	C	
	3.3V Too High	H	C	
	3.3V Too Low	H	C	
	Battery Too Low	H	C	Connect the monitor to an AC power source and allow the batteries to charge.
	Different Battery Voltages	M	C	The two batteries have different charge capacity, or the batteries unspecified have been used, or there is a problem with the batteries. Make sure that correct batteries are used and the batteries are not damaged, or replace the batteries.
	Battery Power Overload	H	C	The power consumption of the equipment is too high. Power the monitor using an AC power source.
	RT Clock Not Exist	H	C	Contact your service personnel.
Recorder	Recorder Init Err N	L	A	Restart the monitor.
	N is within 1 to 8.			
	Recorder SelfTest Err	L	A	Stop the recording and restart the monitor.
	Recorder Comm Err	L	A	
	Recorder S. Comm Err	L	A	

Measurement	Alarm Message	L	I	Cause and Solution
	Recorder Unavailable	L	A	
	Recorder Vlt High	L	C	An error occurred to the system power supply. Restart the monitor.
	Recorder Vlt Low	L	C	
	Recorder Head Hot	L	C	The recorder has been working for too long time. Stop the recording and resume the recording till the recorder's printhead cools down.
	Rec Paper Wrong Pos.	L	A	Re-load the recorder paper.
System	System Watchdog Err	H	C	An error occurred to the system. Restart the monitor.
	System Software Err	H	C	
	System CMOS Full	H	C	
	System CMOS Err	H	C	
	System FPGA Err	H	C	
	System Err N	H	C	
	N is within 2 to 12.			

E Electrical Safety Inspection

The following electrical safety tests are recommended as part of a comprehensive preventive maintenance program. They are a proven means of detecting abnormalities that, if undetected, could prove dangerous to either the patient or the operator. Additional tests may be required according to local regulations.

All tests can be performed by using commercially available safety analyzer test equipment. These procedures assume the use of a 601PROXL International Safety Analyzer or equivalent safety analyzer. Other popular testers complying with IEC 60601-1 used in Europe, such as Fluke, Metron, or Gerb, may require modifications to the procedure. Please follow the instructions of the analyzer manufacturer.

The electrical safety inspection should be periodically performed every two years. The safety analyzer also proves to be an excellent troubleshooting tool to detect abnormalities of line voltage and grounding, as well as total current loads.

E.1 Power Cord Plug

Test Item		Acceptance Criteria
The power plug	The power plug pins	No broken or bent pin. No discolored pins.
	The plug body	No physical damage to the plug body.
	The strain relief	No physical damage to the strain relief. No plug warmth for device in use.
	The power plug	No loose connections.
The power cord		No physical damage to the cord. No deterioration to the cord.
		For devices with detachable power cords, inspect the connection at the device.
		For devices with non-detachable power cords, inspect the strain relief at the device.

E.2 Device Enclosure and Accessories

E.2.1 Visual Inspection

Test Item	Acceptance Criteria
The enclosure and accessories	No physical damage to the enclosure and accessories.
	No physical damage to meters, switches, connectors, etc.
	No residue of fluid spillage (e.g., water, coffee, chemicals, etc.).
	No loose or missing parts (e.g., knobs, dials, terminals, etc.).

E.2.2 Contextual Inspection

Test Item	Acceptance criteria
The enclosure and accessories	No unusual noises (e.g., a rattle inside the case).
	No unusual smells (e.g., burning or smoky smells, particularly from ventilation holes).
	No taped notes that may suggest device deficiencies or operator concerns.

E.3 Device Labelling

Check the labels provided by the manufacturer or the healthcare facilities are present and legible.

- Main unit label
- Integrated warning labels

E.4 Protective Earth Resistance

1. Plug the probes of the analyzer into the device's protective earth terminal and protective earth terminal of the AC power cord.
2. Test the earth resistance with a current of 25 A.
3. Verify the resistance is less than limits.

LIMITS

For all countries, $R = 0.2 \Omega$ Maximum

E.5 Earth Leakage Test

Run an Earth Leakage test on the device being tested before performing any other leakage tests.

The following outlet conditions apply when performing the Earth Leakage test:

- normal polarity (Normal Condition)
- reverse polarity (Normal Condition)
- normal polarity with open neutral (Single Fault Condition)
- reverse polarity with open neutral (Single Fault Condition)

LIMITS

- For UL60601-1,
 - ◆ 300 μ A in Normal Condition
 - ◆ 1000 μ A in Single Fault Condition
- For IEC60601-1,
 - ◆ 500 μ A in Normal Condition
 - ◆ 1000 μ A in Single Fault Condition



E.6 Patient Leakage Current

Patient leakage currents are measured between a selected applied part and mains earth. All measurements have a true RMS only

The following outlet conditions apply when performing the Patient Leakage Current test.

- normal polarity (Normal Condition)
- reverse polarity (Normal Condition),
- normal polarity with open neutral (Single Fault Condition)
- reverse polarity with open neutral (Single Fault Condition)
- normal polarity with open earth (Single Fault Condition)
- reverse polarity with open earth (Single Fault Condition)

LIMITS

- For CF  applied parts
 - ◆ 10µA in Normal Condition
 - ◆ 50µA in Single Fault Condition
- For BF  applied parts
 - ◆ 100µA in Normal Condition
 - ◆ 500µA in Single Fault Condition

E.7 Mains on Applied Part Leakage

The Mains on Applied Part test applies a test voltage, which is 110% of the mains voltage, through a limiting resistance, to selected applied part terminals. Current measurements are then taken between the selected applied part and earth. Measurements are taken with the test voltage (110% of mains) to applied parts in the normal and reverse polarity conditions

The following outlet conditions apply when performing the Mains on Applied Part test.

- Normal Polarity
- Reversed Polarity

LIMITS

- For CF  applied parts: 50 µA
- For BF  applied parts: 5000 µA



E.8 Patient Auxiliary Current

Patient Auxiliary currents are measured between any selected Applied Part connector and the remaining Applied Part connectors. All measurements may have a true RMS only response.

The following outlet conditions apply when performing the Patient Auxiliary Current test.

- normal polarity (Normal Condition)
- reverse polarity (Normal Condition)
- normal polarity with open neutral (Single Fault Condition)
- reverse polarity with open neutral (Single Fault Condition)
- normal polarity with open earth (Single Fault Condition)
- reverse polarity with open earth (Single Fault Condition)

LIMITS

- For CF  applied parts,
 - ◆ 10µA in Normal Condition
 - ◆ 50µA in Single Fault Condition
- For BF  applied parts,
 - ◆ 100µA in Normal Condition
 - ◆ 500µA in Single Fault Condition

NOTE

-
- **Make sure the safety analyzer is authorized comply with requirement of IEC61010-1.**
 - **Follow the instructions of the analyzer manufacturer.**
-

F Symbols and Abbreviations

Symbols and abbreviations that you may encounter while reading this manual or using the monitor are listed below with their meanings.

F.1 Symbols

A	ampere
Ah	ampere hour
bpm	beats per minute
BrPM	breaths per minute
°C	centigrade
cc	cubic centimeter
cm	centimeter
dB	decibel
°F	fahrenheit
g	gram
GTT	gutta
hr	hour
hPa	hundred pascal
Hz	hertz
inch	inch
kg	kilogram
kPa	kilopascal
l	litre
lb	pound
m	meter
mcg	micrograms
mEq	milli-equivalents
mg	milligrams
min	minute
ml	milliliter
mm	millimeters
mmHg	millimeters of mercury
ms	millisecond
mV	millivolt
mW	milliwatt

nm	nanometer
ppm	part per million
s	second
V	volt
VA	volt ampere
Ω	ohm
μ A	microampere
μ m	micron
μ V	microvolt
W	watt
-	minus
%	percent
/	per; divide; or
^	power
+	plus
=	equal to
<	less than
>	greater than
\leq	less than or equal to
\geq	greater than or equal to
\pm	plus or minus
\times	multiply
©	copyright

F.2 Abbreviations

AAMI	Association for Advancement of Medical Instrumentation
AC	alternating current
AHA	American Heart Association
ANSI	American National Standard Institute
AP	access point
ARR	arrhythmia
ART	arterial
AUX	Auxiliary output
AwRR	Air way respiratory rate
BTPS	body temperature and pressure, saturated
CCU	critical care unit
CH	channel
CISPR	International Special Committee on Radio Interference
CMS	central monitoring system
cmos	Complementary Metal Oxide Semiconductor

CPU	central processing unit
CVP	central venous pressure
D	diastolic
DC	direct current
DIA	diastolic
e.g.	for example
ECG	electrocardiograph
EEC	European Economic Community
EMC	electromagnetic compatibility
ERR	error
ES	electrosuigical
ESU	electrosuigical unit
Et	end-tidal
EURO	European
Fi	fraction of inspired
FiCO ₂	fraction of inspired carbon oxygen
FiN ₂ O	fraction of inspired nitrous oxide
FiO ₂	fraction of inspired oxygen
fpga	Field Programmable Gate Array
Hb-CO	Carbonmono-xide hemoglobin
HR	heart rate
HT	height
IEC	International Electrotechnical Commission
ID	invasive diastolic brood pressure
IM	invasive mean brood pressure
IS	invasive systolic brood pressure
Ins, INS	Inspired Minimum
InsCO ₂	Inspired Minimum carbon dioxide
ISO	International organization for standardization
LA (L)	left arm
LAP	left artria pressure
LCD	liquid crystal display
LED	light emitting diode
LL (F)	left leg
Loop	loop read-write test fail
M	mean
MAC	minimal alveolar concentration
MAP	mean arterial pressure
MDD	Medical Device Directive
MEAN	mean pressure
MetHb	methemoglobin
Mii	initialize MII registers fail
MRI	magnetic resonance imaging
N/A	not applied
NIBP	noninvasive blood pressure
ND	non-invasive diastolic brood pressure

NM	non-invasive mean brood pressure
NS	non-invasive systolic brood pressure
O ₂	oxygen
OxyCRG	Oxygen Cardio-respirogram
P	power
PA	pulmonary artery
PD	photodetector
PLETH	plethysmogram
PPV	Pulse Pressure Variation
PR	pulse rate
PVC	premature ventricular complex
QRS	interval of ventricular depolarization
RA (R)	right arm
RAM	random access memory
RAP	right atrial pressure
Reg	test NE2000 registers fail
RESP	respiration
RL (N)	right leg
ROM	read-only memory
RR	respiration rate
S	systolic
SpO ₂	arterial oxygen saturation from pulse oximetry
SYNC	synchronization
SYS	systolic
TEMP	temperature
TFT	Thin-Film Technology
V (C)	precordial lead (chest)
VGA	Video Graphice Array

