

z.one pro Ultrasound System

(Including Special Procedures interface option)

Instructions for Use



mindray
ZONARE



©2023 Shenzhen Mindray Bio-Medical Electronics Co., Ltd. All rights reserved.

For this Instructions for use manual, the issue date is 2023-04.

ZONARE, the ZONARE logo, ZS3 and z.one pro are all trademarks of Shenzhen Mindray Bio-Medical Electronics Co., Ltd. All other trademarks are the property of their respective holders.

The z.one pro Ultrasound Platform and products derived there from (for example, but not limited to, the z.one pro and the z.one pro with and without the SP UI option) is covered by one or more of the following patents:
6,251,073; 6,569,102; 6,618,206; 6,663,567; 6,685,645; 6,733,455; 6,773,399; 6,866,631; 6,866,632; 6,896,658;
6,936,008; 6,980,419; 6,997,876; 7,022,075; 7,087,020; 7,226,416; 7,238,157; 7,352,570; 7,361,145; 7,510,529;
7,627,386; 7,382,309; 7,699,781; 8,002,705; 8,226,561; D461,814; D462,446; D467,002; D469,539; D469,877



SHENZHEN MINDRAY BIO-MEDICAL ELECTRONICS CO., LTD.
Mindray Building, Keji 12th Road South, High-Tech Industrial Park, Nanshan,
Shenzhen, 518057, P.R.China

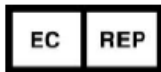

Shanghai international Holding Corp. GmbH(Europe)
Eiffestraße 80, 20537 Hamburg, Germany

Technical Support

North America and Asia:

Phone support: 1-877-913-9663 or 1-650-316-3199 option 7 (ultrasound)

Email: techsupport@mindray.com

Sales support: 1-877-966-2731,

Email: salesupport@mindray.com

www.mindraynorthamerica.com

Europe:

Phone support: +49 (913) 1974-9412

Email: info@mindray.com

www.mindray.de

Europe and Asia:

Address: Mindray Building, Keji 12th Road South, High-tech industrial park,

Nanshan, Shenzhen 518057, P.R.China

E-mail Address: service@mindray.com

www.mindray.com

Tel: +86 755 81888998

Fax: +86 755 26582680

CAUTION

United States Federal law restricts this device to sale by or on the order of a licensed healthcare practitioner (USA).

Contents



| | |
|---|-----|
| Contents | III |
| Intellectual Property Statement..... | IV |
| Responsibility on the Manufacturer Party | IV |
| Warranty | V |
| Exemptions | V |
| Notification of Adverse Events | V |
| Important Information..... | V |
| 1. Introduction | 1 |
| 2. Getting Started | 7 |
| 3. Imaging | 20 |
| 4. Transducers and Needle-Guided Brackets | 31 |
| Transducers | 31 |
| Needle-guided Bracket | 42 |
| TEE Transducers/Laparoscopic Transducers..... | 44 |
| Wearing the Probe Sheath..... | 50 |
| Transducer Tracking | 53 |
| 5. Measurements and Calculations | 55 |
| 6. Annotations, Arrows, and Body Markers | 63 |
| 7. Archiving, Review and Management | 66 |
| 8. Advanced Features and Options | 73 |
| Contrast Enhanced Ultrasound (CEUS)..... | 73 |
| Elastography..... | 76 |
| 9. 3D & 4D Imaging with Advanced Lighting (Option) | 81 |
| 10. Needle Optimization Mode (For Improved Needle Visualization)..... | 87 |
| 11. Protocols..... | 89 |
| 12. Stress Echo..... | 91 |
| 13. Setup | 95 |
| 14. System Security | 99 |
| 15. Maintenance | 104 |
| 16. Safety | 106 |
| 17. Acoustic Output | 117 |
| 18. Display Accuracy and Precision | 122 |
| 19. Guidance Documents | 124 |
| 20. Standards and Compliance | 125 |
| 21. Product Labeling..... | 131 |
| 22. Specifications | 132 |

Intellectual Property Statement

SHENZHEN MINDRAY BIO-MEDICAL ELECTRONICS CO., LTD. (hereinafter called Mindray) owns the intellectual property rights to this Mindray product and this manual. This manual may refer to information protected by copyright or patents and does not convey any license under the patent rights or copyright of Mindray, or of others.

Mindray intends to maintain the contents of this manual as confidential information. Disclosure of the information in this manual in any manner whatsoever without the written permission of Mindray is strictly forbidden.

Release, amendment, reproduction, distribution, rental, adaptation, translation or any other derivative work of this manual in any manner whatsoever without the written permission of Mindray is strictly forbidden.

 ,  and **MINDRAY** are the trademarks, registered or otherwise, of Mindray in China and other countries. All other trademarks that appear in this manual are used only for informational or editorial purposes. They are the property of their respective owners.

This posting serves as notice under 35 U.S.C. §287(a) for Mindray patents:
<http://www.mindrayna.com/patents>.

Responsibility on the Manufacturer Party

Contents of this manual are subject to change without prior notice.



All information contained in this manual is believed to be correct. Mindray shall not be liable for errors contained herein or for incidental or consequential damages in connection with the furnishing, performance, or use of this manual.

Mindray is responsible for the effects on safety, reliability and performance of this product, only if:

- all installation operations, expansions, changes, modifications and repairs of this product are conducted by Mindray authorized personnel;
- the electrical installation of the relevant room complies with the applicable national and local requirements; and
- the product is used in accordance with the instructions for use.

 **Note** 

This equipment must be operated by skilled/trained clinical professionals.

 **Warning** 

It is important for the hospital or organization that employs this equipment to carry out a reasonable service/maintenance plan. Neglect of this may result in machine breakdown or personal injury.

Warranty

THIS WARRANTY IS EXCLUSIVE AND IS IN LIEU OF ALL OTHER WARRANTIES, EXPRESSED OR IMPLIED, INCLUDING WARRANTIES OF MERCHANTABILITY OR FITNESS FOR ANY PARTICULAR PURPOSE.

Exemptions

Mindray's obligation or liability under this warranty does not include any transportation or other charges or liability for direct, indirect or consequential damages or delay resulting from the improper use or application of the product or the use of parts or accessories not approved by Mindray or repairs by people other than Mindray authorized personnel.

This warranty shall not extend to:

- **Malfunction or damage caused by improper use or man-made failure.**
- **Malfunction or damage caused by unstable or out-of-range power input.**
- **Malfunction or damage caused by force majeure such as fire and earthquake.**
- **Malfunction or damage caused by improper operation or repair by unqualified or unauthorized service people.**
- **Malfunction of the instrument or part whose serial number is not legible enough.**
- **Others not caused by instrument or part itself.**

Notification of Adverse Events

As a health care provider, you may report the occurrence of certain events to SHENZHEN MINDRAY BIO-MEDICAL ELECTRONICS CO., LTD., and possibly to the competent authority of the Member state in which the user and / or patient is established.

These events, include device-related death and serious injury or illness. In addition, as part of our Quality Assurance Program, SHENZHEN MINDRAY BIO-MEDICAL ELECTRONICS CO., LTD. requests to be notified of device failures or malfunctions. This information is required to ensure that SHENZHEN MINDRAY BIO-MEDICAL ELECTRONICS CO., LTD. provides only the highest quality products.

Important Information

According to the conclusion of clinical evaluation and residual risk evaluation, for the intended patients, there is no known side effects that can occur during or after the use of the medical device. And there is no need for the operator to make extra preparations. Besides, the residual risks are disclosed in the corresponding chapter of this manual as precautions or warnings.

1. Introduction



United States Federal Law restricts this device to sale by or on the order of a licensed healthcare practitioner, licensed by the law of the jurisdiction in which they practice, to use or order the use of this device.

Only qualified personnel should perform ultrasound scanning of human subjects for medical diagnostics.

This ultrasound system meets the acoustic output emission guidelines established by the U.S. Food and Drug Administration (FDA). Acoustic output quantities have been measured, and are displayed, in accordance with the standards listed under *Guidance Documents*.

Indications for Use

For FDA regions

The ultrasound system is intended for use by a qualified physician for ultrasound evaluation of Ophthalmic; Fetal; Abdominal (renal, GYN/Pelvic); Intra-operative (abdominal, thoracic(cardiac), and vascular); Intra-operative (Neuro); Laparoscopic; Pediatric; Small organ (thyroid, breast, testes, etc); Neonatal cephalic; Adult Cephalic/Transcranial; Trans-rectal; Trans-vaginal; Trans-esoph.(non-Card); Musculoskeletal (Conventional); Musculoskeletal (Superficial); Cardiac Adult; Cardiac Pediatric; Trans-esoph. (Cardiac); Intra-cardiac; Peripheral vessel.

For CE regions

It is intended for use in Ophthalmic, Abdominal (includes renal, GYN/Pelvic), Adult Cardiac, Fetal, Musculo-skel (conventional), Pediatric, Peripheral Vascular, Musculo-skel (Superficial), Adult Cephalic/ trans-cranial, Adult Cardiac, Pediatric Cardiac, Intra-operative (Neuro, abdominal, thoracic (cardiac) and vascular (PV)), Neonatal Cephalic, Trans-rectal, Trans-vaginal, Small Organ (Thyroid, Breast, Testes, etc), Transesophageal Echocardiography (non-cardiac and cardiac), Urology, Laparoscopic, Contrast, 3D/4D exam.

It is intended for clinical ultrasound diagnosis and examination

Intended users include doctor, nurse, clinical technologist, radio technologist and ultrasonographer proficient in medicine knowledge.

The diagnostic ultrasound system is applicable for adults, pregnant women, pediatric patients and neonates.

Intended medical conditions are hospital (e.g., imaging laboratory, emergency room, patient bedside, and operating room), medical clinic, physician's office or an imaging center

Note: The availability of application may be limited based on country or region of use.

Contraindication

None.

Device Description

The z.one pro Ultrasound Platform and products derived there from (for example, but not limited to, the ZS3 and the z.one pro with and without the SP UI option) is used for ultrasound evaluation of the following applications: Laparoscopic, Fetal, Abdominal, Intra-operative, Pediatric, Ophthalmic, Small Organ/Parts (breast/testes, thyroid, etc.), Transvaginal, Transrectal, Transcranial, OB/GYN, Cardiac, Pelvic, Neonatal/Adult Cephalic, Vascular, Tissue Elasticity, Contrast Imaging, Musculoskeletal, Superficial Musculoskeletal and Peripheral Vascular applications. Users include ultrasound imaging technicians (sonographers) and physicians. This ultrasound system may be used in a hospital (e.g. imaging laboratory, emergency room, patient bedside, and operating room), medical clinic, physician's office or a mobile imaging center.

The z.one pro Ultrasound Platform consists of two major components: 1) Cart; and, 2) Transducer(s). The Cart contains the software driven imaging electronics and user interfaces (keyboard, monitor, handles, etc.). It houses the microprocessor, memory, amplifiers and power supplies for the microprocessor. It sends electrical currents to and receives electrical pulses from the compatible transducers. The Cart performs the calculations involved in processing the data to produce the displayed ultrasound images.

Standard Configuration

- Main unit
- Storage bins
- System software
- Accessories:
 - Power cables
 - Operator's manual
 - Operator's manual in multi-language (disk)

Options

| No. | Item | Remarks |
|-----|---------------------|---|
| 1. | CW Enable | / |
| 2. | ECG Enable | |
| 3. | Strain Elastography | |
| 4. | ARFI | |
| 5. | Small Parts CEUS | Not applicable for the FDA region. |
| 6. | GYN CEUS | |
| 7. | Abdominal CEUS | Only applicable for liver in the FDA region |
| 8. | Cardiac CEUS | Only applicable for LVO in the FDA region |
| 9. | CEUS Sequence | Only applicable for liver and LVO in the FDA region |
| 10. | HD Scope | / |
| 11. | Advanced Cardiac | Including AutoEF and Expanded Echo Calcs. |

| No. | Item | Remarks |
|-----|---|--|
| 12. | Smart OB/NT | / |
| 13. | AutoIMT | |
| 14. | Stress Echo | |
| 15. | Total Recall | |
| 16. | Protocol | |
| 17. | Needle OPT | |
| 18. | Anat Mmode | |
| 19. | Battery Pack | |
| 20. | ECG cable | |
| 21. | Barcode Reader | |
| 22. | USB Foot Pedal | |
| 23. | Ultrasound gel warmer assembly | Including ultrasound gel warmer and bracket. |
| 24. | Intra-cavitary probe holder pack | Installed in the right side. Including intra-cavitary probe holder and bracket. Not applicable for the FDA region. |
| 25. | Printer bracket | / |
| 26. | SONY UP-D711MD black/white printer pack | |
| 27. | SONY UP-D711MD printer bracket pack | |
| 28. | Hook | |
| 29. | Keyboard protective cover | |
| 30. | Wireless Ethernet Routers and Bridges | |















Peripherals Supported





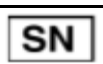





| Item | Model |
|-----------------------------------|----------------|
| Digital black/white video printer | SONY UP-D711MD |
| Digital color video printer | SONY UP-D25MD |

Note: The availability of options may be limited based on country or region of use.



Key to Symbols

The following symbols may be used in this document or elsewhere in product labeling.

| Symbol | Description |
|---|---|
|  | Information that may relate to safety of the patient, the operator, or the equipment |
|  | A type BF patient-applied part (B= body, F= floating applied part) |
|  | A type CF patient-applied part (C= cardiac, F= floating applied part) |
|  | Alternating current (AC) |
|  | Direct current (DC) |
|  | Date of manufacture |
|  | Manufacturer |
|  | Caution: ESD sensitive |
|  | Recyclable material |
|  | Waste Electrical & Electronic Equipment Standard Applies to EU Member States only: this system should not be treated as household waste. Mindray meets the WEEE Standard. For more information on returning or recycling this system, please contact Shenzhen Mindray Bio-Medical Electronics Co. or the distributor from whom you purchased the system. |
|  | Consult the Instructions for Use |
|  | Serial number |
|  | Authorized representative in the European Community |
|  | Catalog number |
|  | Shipping & Storage: Fragile |

| Symbol | Description |
|---|---|
|  | Shipping & Storage: Keep dry |
|  | Shipping & Storage: Temperature limits |
|  | Shipping & Storage: This side UP |
|  | Shipping & Storage: Do not stack above this container |
|  | Shipping & Storage: Humidity limits |
|  | Shipping & Storage: Pressure limits |
| Rx Only | Federal law restricts this device to sale by or on the order of a licensed healthcare practitioner (USA). |
| IPX7 | Protected against water immersion - Immersion for 30 minutes at a depth of 1 meter. |
|  | This product is provided with a CE marking in accordance with the regulations stated in the Regulation (EU) 2017/745 of the European parliament. The number adjacent to the CE marking (0123) is the number of the EU-notified body certified for meeting the requirements of the Regulation. |
|  | MR Unsafe – the system is not intended to be used within magnetic resonance (MR) environment. |
|  | Medical Device |
|  | Unique Device Identifier |

The general meaning assigned to geometric shapes, safety colors and contrast colors for safety signs are as follows:

| Geometric shape | Meaning | Safety color | Contrast color | Graphical symbol color |
|---|------------------|---------------------|-----------------------|-------------------------------|
|  | Prohibition | Red | White | Black |
|  | Mandatory action | Blue | White | White |
|  | Warning | Yellow | Black | Black |

2. Getting Started

Please read this document carefully before using the ultrasound system.

Overview of Console, System and Features

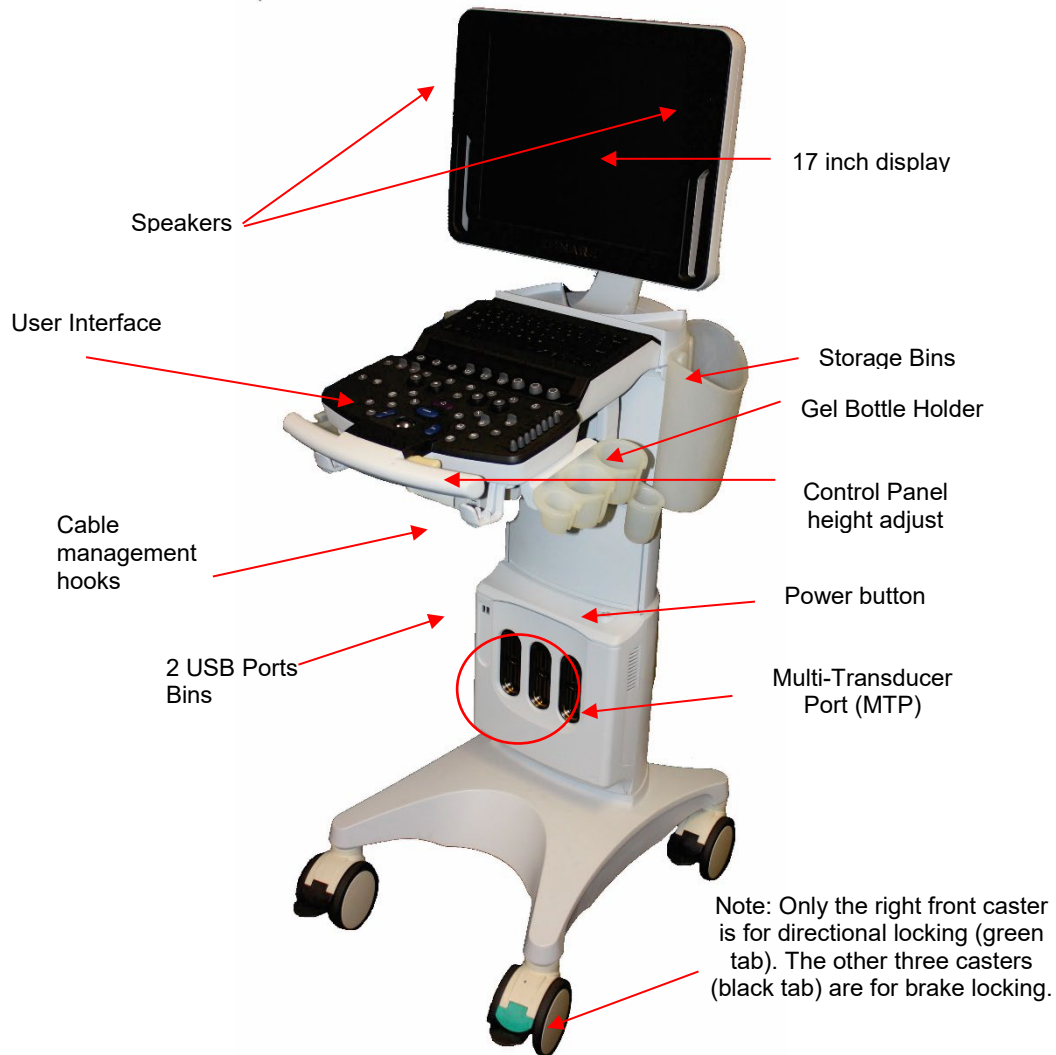

Figure 2.1: z.one pro System Components

LCD Display

The z.one pro full-sized 17-inch LCD Display shows the ultrasound image, plus patient and imaging information in designated areas of the screen.

- Overall screen display = 1280 x 1024 pixels

Full Screen Image Display (Figure 2.7)

The z.one pro allows you to enlarge the imaging portion of the monitor to (1152 X 864). You can easily go from the imaging portion display of (960 x 720) to (1152 X 864) with the push of a

Function Key which can be configured in Setup/Keys or alternately by using the Pointer to click on the **Full Image Display** ICON located in the lower left corner of the imaging screen.



Once in Full Image Display, the screen will display Thumbnails **or** F Keys/OLEDs and Small Thumbnails. Use the Pointer to click on the **Switch Button** ICON on the far right hand side of the screen to toggle between F Keys and OLEDs. Click on Thumbnail ICON to toggle between large and small thumbnails.



While Full Image Display is active, any Menus such as Calculations or Annotations will 'time out' and disappear from the screen after a short time to prevent image overlap. Pointing to the black margin to the left of the Menu area (yellow oval below) of the screen will bring the menu back.



Control Panel

The z.one pro has a full –featured control panel/ user interface (see Quick Start Guide below).

Multi-Transducer Port

The multi-transducer port (MTP) allows up to three imaging transducers simultaneously

connect to the system. You can easily activate any of the transducers connected to the cart.

Transducer Holders

The Safe storage for transducers is provided on both sides of the z.one pro System (Figure 2.1).

Internal Cart Solid State Drive (SSD)

All exam images are initially archived to the Cart SSD.

This data can be then be transferred to PACS, USB drives, networked or thermal printers, and FTP destinations. It can also be backed up and restored on other z.one pro systems.

See Chapter 7. Archiving, Review and Management for more details.

The standard size of the SSD is 128 GB.

NOTE: The internal hard drive is not intended for use as a long-term archive. Back up of exam data is recommended regularly.

USB Ports

Four USB ports (two in the front and two in the back) allow importing/ exporting of exams to/from the system as well as to install software and to backup/restore system and preset preferences.

Note: Before deleting any exam data from the cart hard drive, always verify that data was successfully transferred to the USB device by viewing it on an external computer.

When exams are exported onto the USB device, a DICOM viewer program (Showcase®) and its user's manual are simultaneously exported onto the USB, allowing the exams to be opened, annotated, and saved in several formats on any commercial PC.

Barcode Reader (Option)

Patient accession numbers, ID, name, age, DOB, gender, Operator ID etc. can be entered via a selection of Mindray-approved barcode readers that can connect to a system USB port (note: capability and content is dependent on type of scanner used).

Foot Pedal (Option)

A remote 2-pedal footswitch is optionally available for connection to the system via any available USB port. The left and right pedals may be individually configured to one of over forty possibilities including **Freeze** and **Store** using Setup/Keys.

Backup ZPak Battery (Option)

A backup battery may be ordered that can power the system for up to 1 ½ hours of normal use in the absence of a connection to an active AC power outlet, depending on usage. The battery allows the system to be operated in normal use without connection to an active AC Power outlet. The backup is mounted at the base of the system and is automatically kept charged (as needed) whenever the z.one pro system is connected to active AC power.

Printers and Other Peripherals

Mindray offers a number of optional medical-grade (IEC 60601 compliant) peripherals. Detailed instructions, for proper peripheral use, are covered in the manufacturer's instructions provided at the time of shipment.

Front I/O Panel

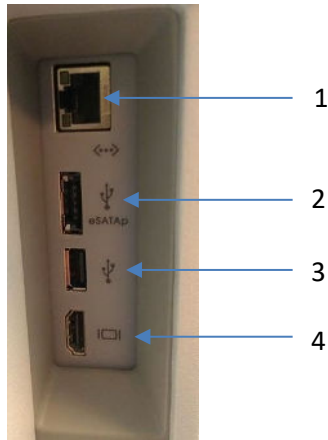

| No. | Name | Function |
|-----|---------------------------------------|--|
| 1. | Network port. | Used for connecting router, ultrasound workstation, server, etc. |
| 2. | Serial Port - eSATAp | Used for connecting storage device. |
| 3. | USB Port | Used for connecting storage device. |
| 4. | High definition multimedia interface. | Used for connecting TV, projector, ultrasound workstation video capture card, etc. |

Front I/O Panel

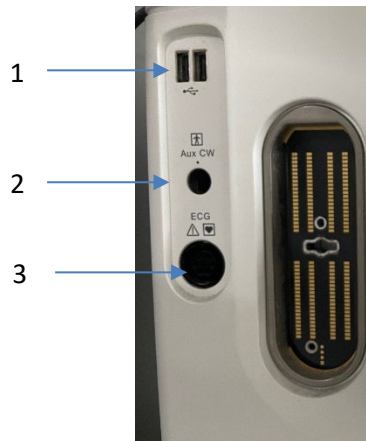

| No. | Name | Function |
|-----|----------|--|
| 1. | USB Port | Used for connecting storage device. |
| 2. | CW Port | Used for connecting a pencil probe. |
| 3. | ECG Port | Connects to ECG leads, to directly obtain the ECG signals of the patient. Connects the signal output port of ECG monitoring device. |

Moving the z.one pro system

Moving the System



1. Lower the adjustable height to MINIMUM using the height adjustment release lever.
2. Fold the monitor display down to a horizontal position and lock in place. The monitor arm will lock into a non-rotating position when the two parts of the articulating arm are in-line with each other AND centered with the system.
3. Ensure that the transducer cables are wrapped over the cable hooks.
4. Place wheel(s) in the non-swivel position.
5. Ensure that all wheels do not have the brakes set ON and push the cart from the front when transferring from location to location.
6. When moving the cart over obstacles, always pull from the front.

Before Scanning

1. Before scanning a patient, apply the brake by fully depressing any of the three brake pedals.
2. To disengage brakes, flip up the pedals.

Height Adjustment

The height of the user interface console can be adjusted by squeezing the release lever located inside the right-front handle. Refer to Figure 2.3: Height Adjustment.



Figure 2.3: Height Adjustment

User Interface and Onscreen Display

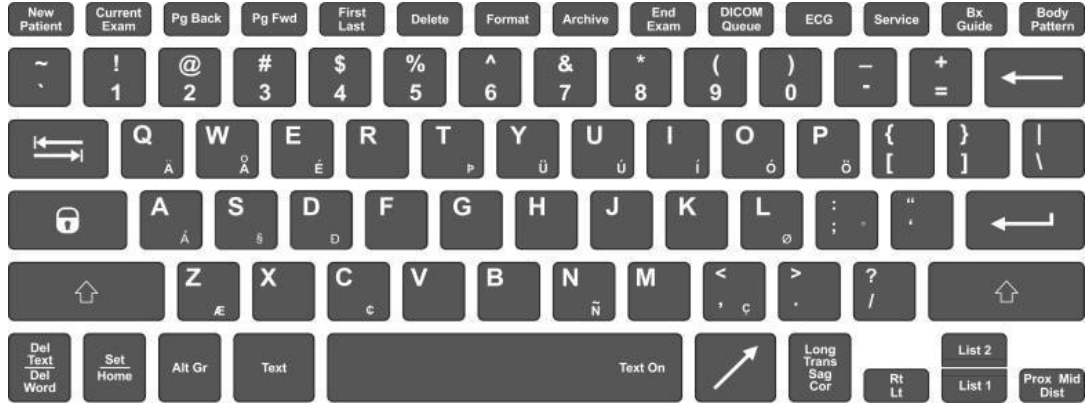

Figure 2.4: Keyboard



Figure 2.5: User Interface (See Section 3 Imaging for more details)



User Interface (Special Procedures interface)





Figure 2.7: Full Image Onscreen Display

Patient and Institution Information

Includes Manufacturer Logo and Institution Name: Configured in Setup/System/General.
Includes Patient Name, ID, Gender, and Age: Information entered on the Patient ID page. Also displays: Probe/Preset as selected with transducer, exam type, exam date/time, and Operator

Menus Includes annotation lists, measurement options, calculations menus, stress echo navigation, and protocol information.

Trackball and set keys are used to navigate this area.

Image Area

Displays the ultrasound images, Doppler spectral strip, M Mode strip, image depth markers, ECG and respirometer waveforms, probe indicator, and calculations/measurement results window.

Image Parameters

Displays the image parameter for the active window. If there is more than one imaging mode active, the parameters are displayed for each mode.

Trackball-Priority ICON

Displays:

- 2 Set Keys with labels indicating active state of keys
- 1 Select Key with labeling indicating active state of key
- 1 Pointer Key labeled
- Trackball with center graphic indicating active state of trackball

- 6 Priority States (Six squares with labels indicating states available to toggle. Active state displayed in green font).

Priority is changed as modes are turned on and off but can also be changed using the priority key on the user interface or by using the Pointer to point directly to the onscreen state desired.



Softkey OLEDs

Displays current functions of softkey OLED controls. Users can adjust using the softkey OLED controls on the user interface.

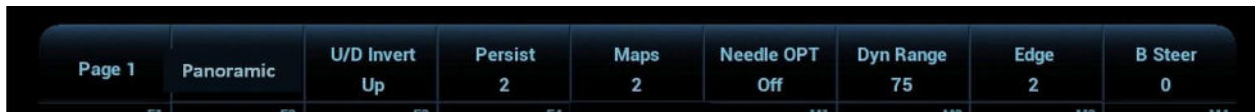

Function (F) Keys

Displays current function of programmable 'F' keys. Users can adjust using the function and mode keys on the user interface.

Function Keys can be configured by exam category in Setup/Keys, so that each exam category may display a different subset of controls



Thumbnails, Thumbnail Navigation Arrows and Thumbnail Sizing

Displays thumbnails of the images stored on the current patient.

Images can be viewed, edited, deleted, or sent to media by pressing the pointer key and then navigating the pointer to the desired thumbnail and clicking on them.

Large arrows on either end of the thumbnail strip can be clicked to navigate through the image collection.

Thumbnails can be displayed 7 (large) or 28 (small) at a time by clicking on the thumbnail sizing tool.

System ICONs

This area displays relevant icons such as USB Memory Device, Printer, Trash, Network, Location Manager, Full Image Display/Standard Screen toggle, Caps Lock Status, Task Manager, Session Manager, Setup, HD status, and Battery Status.



Help Bar

The Help Bar displays help information items such as which button or control to press next to advance a function. This Bar is located to the right of the System ICONs.



Quick Start Guide

1. Connect the Transducer/s (cable pointing up)
2. Press On Button (located above transducer ports)
3. Press New Patient key:
 - Enter Patient information
4. Press Freeze to access imaging screen
5. Press Transducer or Exam Type key:
 - Select transducer and preset from onscreen lists
6. Begin scanning
7. Adjust Depth as necessary
8. Press Optimize to provide for the best image
9. Press Freeze to stop live scanning.
10. Press Store 1, Store 2, or Print to capture images

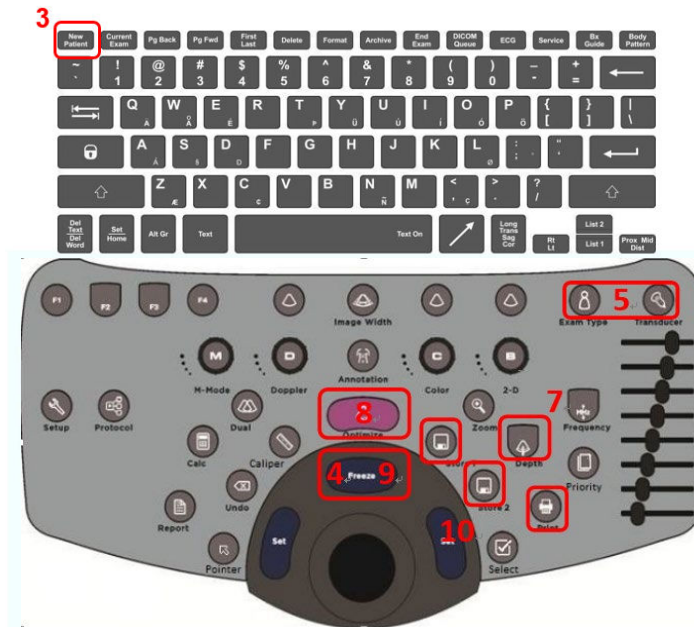

Figure 2.2: Control Panel

Powering On/Off

1. Press and release the **Power** button (located above the transducer connector) to turn the system on.
2. Check the z.one pro display to ensure the startup screen is shown. When initialization is complete, the system is ready for imaging.
3. To Power Off press and release the **Power** button.

NOTE: When servicing the z.one pro system, always be sure to turn the circuit breaker to the Off position.

Basic Measurements (Caliper Button)

1. Press **Caliper** while image is frozen.
2. Select desired measurement tool on menu & press a **Set** Key.
3. Position first caliper with **Trackball** & press a **Set** Key.
Position second caliper with **Trackball** & press a **Set** Key. (Note: Pressing the **Select** Key will toggle between active calipers in the set or series for fine tuning)

Basic Calculations (Calc Button)

1. Press **Calc** while image is frozen.
2. Select desired calc on menu & press a **Set** Key.
3. Position caliper with **Trackball** & press a **Set** Key. (Note: Pressing the **Select** Key will toggle between active calipers in the set or series for fine tuning).
4. Position additional caliper(s) with **Trackball** & press a **Set** Key. Calc will display on screen.
5. Press a Set or Store to store the result.
6. Press Report to display calcs you've recorded.

Send Exams to USB

1. Press **Archive** (back row of QWERTY keyboard).
2. Point to the exam to send to USB.
3. Select **Send Exam** from the drop down menu. This will launch a page to select the destination
4. Select the **Target Media** from the list.
5. Select file type (JPG/AVI, BMP/AVI, TIFF/AVI, DCM).
6. Select **OK** at bottom of screen.

Send Exams to USB or Disc in DICOM format with Showcase Viewer and Directory

1. Press **Archive** (back row of QWERTY keyboard).
2. Point to the exam to send to USB.
3. Select **Send Exam** from the drop down menu. This will launch a page to select the destination
4. Select **DICOM Media** from the list.
5. Select the Destination
6. Select **OK** at bottom of screen.

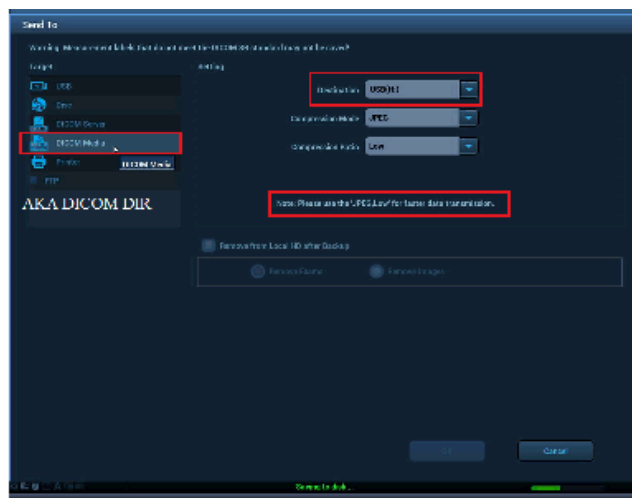
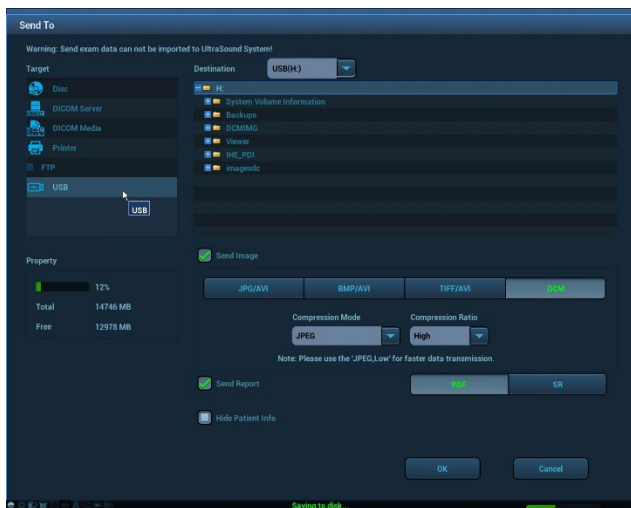

Review Images in Current Exam

1. Press **Current Exam** (back row of QWERTY keyboard).
2. All stored images for exam appear in a Multi-Image Format.
3. To view an image in Full Image with Thumbnails format, point with the cursor and Double Click a **Set** key.
4. To return to live imaging, press the **Exit Review** OLED or press **Current Exam** again.
5. To return to the Multi-Image Format of Image Review, press the **Format** button or OLED assigned to **Format**.
6. To page through current exam images, press **Page Forward, Page Backward or First/Last** on the QWERTY keyboard or OLEDs.

Review and Delete Images using Thumbnails

1. While in live scanning or Full Image with Thumbnail format, press the **Pointer** button.
 2. With Trackball, point to the thumbnail to be reviewed
 3. To delete the image, point to the trashcan graphic  and press **Set**. A prompt will ask to
- z.one pro Instructions

confirm. Click **OK**.

4. To view the image in the image area, (Double Click) **Set** key.
5. To return to live imaging, press **Exit Review OLED** or **Current Exam again**.



3. Imaging

Patient Information

Press the **New Patient** key on the Alphanumeric Keyboard to enter Patient Information

- **Select Transducer, Exam Type and Preset**
- **General Information:**
 - Patient Name, ID, Gender, DOB, Age
 - Access Modality Worklist
- **Diagnosis Information:**
 - Exam Type Specific Details entry
 - Access Modality Worklist
- **Access to**
 - **Restart** button to restart previously completed exams.
 - **Pause** button to pause the exam.
 - **Resume** button to resume a previously paused exam.
 - **Cancel Exam** button delete data for an exam that has been cancelled
 - **Archive** button which provides an alternate means of accessing the Archive.
- **Exit New Patient Page:**
 - **OK** button saves information entered and exits to live scanning
 - **Cancel** button exits page

Basic Operating Controls



| Control | Description/Use |
|---|--|
|  | Press the Transducer button to select one of three imaging or one non-imaging probes attached to the system using the softkey OLEDs. |
|  | Press the Exam Type button to select, create, modify and delete presets. <ul style="list-style-type: none"> • 11 presets per probe can be assigned to softkey OLEDs for easy access, using the Setup / Preset Mgt tab. • Presets can quickly be created or modified and saved with the Quick Save softkey OLED function or by assigning a programmable key to Quick Save • Presets can be deleted using the Delete Preset softkey OLED function. • An onscreen Probe/Preset page is launched when Exam Type is pressed. |



The **Trackball, Set Keys, Select Key, and Priority** are involved in many operations of the system.

Because of the dynamic nature of these controls, an **Onscreen Trackball – Priority ICON** is always available onscreen to alert the users of current functions.



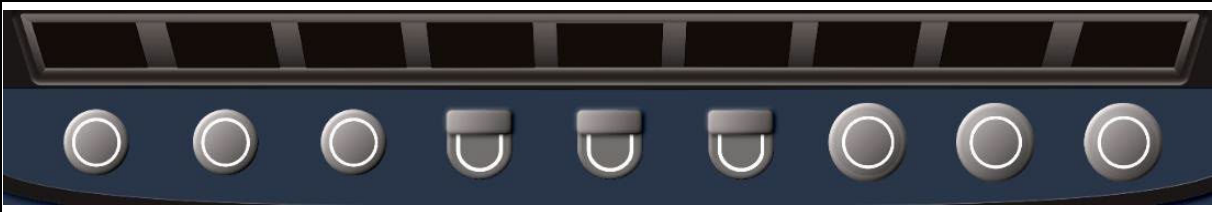







An **Onscreen Help Bar** will also include information to help the user navigate functions or features. (See User Interface / Onscreen Display for details).

| Control | Description/Use |
|--|---|
| <p>Set Buttons</p>  | <p>The Left and Right Set buttons provide primary functionality and navigation.</p> <p>For instance:</p> <ul style="list-style-type: none"> • Selecting calculations, • Setting, moving, or editing annotations • Sizing and changing position of color or zoom box when no other mode is ON. |
| <p>Select Button</p>  | <p>The Select button will provide secondary functions (to streamline workflow when multiple modes are active for instance). The Help Bar and Trackball-Priority ICON will provide guidance in these instances.</p> <p>For instance:</p> <ul style="list-style-type: none"> • When in Dual, Select will toggle between left and right pane, while Set will continue to navigate color box etc. • When in calculations or measure, Select will toggle between active calipers in a set to fine tune while Set will continue to launch calipers and complete/enter calculations. • When in color and spectral Doppler, Select will toggle through sizing and positioning the color ROI as well as moving the PW cursor while the image is live, while Set will continue to toggle between the 2D image and the spectral Doppler. • When Image Width and Color Doppler are both active, Select will toggle size and position of the Image Width and Set will toggle Color Size and Position to reduce keystrokes. • When Auto Trace is active during Spectral Doppler imaging, Select will send calculations data to the Report, while Set will provide users the means to manipulate position of Auto Trace delimiters. |
|  | |
| <p>Softkey OLED Controls (above)</p> | <p>Softkey OLEDs are dynamic controls that change with the state of the system. Each state of the system may include multiple pages of controls.</p> <p>OLED#1, or leftmost, selects which page of controls are displayed. Press the button to change the page.</p> <p>Control designations are duplicated onscreen for easy reference (See Getting Started/User Interface and Onscreen display)</p> |

| | |
|---|--|
| <p>Priority Button</p>  | <p>Press the Priority button to gain access to OLED controls assigned to modes that are 'ON' but do not have priority. Onscreen Trackball - Priority ICON reflects changes.</p> <p>For example, while PW Doppler is active, the OLED controls and Onscreen Trackball - Priority ICON will reflect PW Mode controls as the active mode.</p> <p>The user can press the Priority button to toggle to Color Doppler (if turned ON), for instance, which will change the OLEDs and Onscreen Trackball - Priority ICON to reflect Color Doppler controls without having to turn off PW Doppler.</p> |
| <p>Pointer Button</p>  | <p>Press the Pointer button to gain access to an onscreen pointer, which will allow users to point directly to Onscreen Trackball- Priority ICON Modes to change Priority.</p> <p>Once Pointer is activated, OLED controls, Mode Keys and Function Keys are also accessible onscreen to navigate using the trackball and Set Keys.</p> <p>Pointer can be used to navigate onscreen thumbnails, adjust annotations and arrows as well.</p> |

2D/B-Mode Controls

| Control | Description/Use |
|---|--|
| <p>Softkeys OLED controls</p> | <p>While B Mode is active, the Softkeys at the back of the console contain the optimization and navigation controls specific to 2D/ B-Mode Imaging.</p> <p>Pressing OLED #1 toggles through multiple pages of controls.</p> |
| <p>* Indicates this control is also available in retrospective processing.</p> | |
| <p>Gain*</p>  | <p>Adjust Gain by rotating the outer ring of the B-Mode (2D) button.</p> |
| <p>Depth</p>  | <p>Press the Depth button UP to decrease depth; press DOWN to increase depth.</p> |
| <p>Frequency</p>  | <p>Press the Frequency button UP to increase transmit frequency; press DOWN to decrease transmit frequency.</p> <p>NOTE: Press Frequency up or down when doing compound imaging to cycle through Frequency and Compounding choices.</p> |
| <p>Zoom</p>  | <p>Acoustic Zoom (live image).</p> <p>The first press displays a Region Of Interest (ROI) that can be positioned/size over the anatomy of interest.</p> <p>The second press zooms the ROI, reconfiguring the scanner to provide enhanced imaging in that region.</p> <p>Display Zoom (Frozen/Cine image) The first press zooms the image.</p> <p>The Depth key changes the magnification. The Trackball pans</p> |

| | |
|--|--|
| <p>Optimize*</p>  | <p>Overall/DGC gain: Press the Optimize button to automatically balance the overall/DGC gain. The B-Mode image adjusts the brightness of the image to the default target gain value.</p> <p>Sound speed compensation: Press and hold down Optimize to automatically compensate for the sound speed in tissue. The B-Mode image pauses momentarily, then adjusts for the detected sound speed.</p> <p>To exit optimize mode: Double-click Optimize to turn optimize functions off.</p> |
| <p>Dual: OFF/ON</p>  | <p>Press the Dual mode button to toggle the Dual imaging function on/off.</p> <p>NOTE: The Dual imaging function allows for displaying two separate images on the screen (at the same time) for concurrent comparison/analysis.</p> <ul style="list-style-type: none"> • Press the Select key to toggle between Right and Left Panes (or press the OLED for Rt/Lt Pane). • Press the OLED assigned to Simultaneous to toggle between two identical images (where user may apply color modes to one or both pane/s), and non- Simultaneous where different images may be displayed on each pane. |
| <p>Pointer</p>  | <p>Press the Pointer button to activate a Pointer for multiple functions</p> <ul style="list-style-type: none"> • Select and navigate thumbnails • Reactivate annotations, arrow, or calculations <p>Interact with onscreen controls such as System ICONS, Switch Mode when in full image display, Hide PT data, Stress Echo Controls, ARFI controls etc.</p> |
| <p>Priority</p>  | <p>Press the Priority button to gain access to OLED controls assigned to modes that are 'ON' but do not have priority.</p> <p>For example, while B-Mode is active, the OLED controls will reflect B-Mode controls as the active mode. The user can press the Priority button to toggle to CINE, for instance, which will change the OLEDs to CINE controls without having to freeze.</p> |

HD and pHD Scope

HD Scope is an image processing technique that optimizes image quality within a region of interest (ROI) specified by user while maintaining the general imaging appearance and setup outside the ROI. In order to achieve such local enhancement of image quality the system is allowed to adaptively allocate more imaging resources to the ROI. Therefore, doctors can gain more diagnostic confidence with better spatial and contrast resolution in the local area for various tissue types, especially small and complex lesions.

HD Scope imaging parameters can be adjusted while live imaging and a subset of post processing controls can be changed after the image has been frozen. In addition, pHD Scope can be added to a frozen image in which the ROI can be moved/sized and the post processing parameters within the ROI can be adjusted.

HD Scope is a Priority state, so the HD Scope OLED controls are launched; dedicated imaging controls are displayed onscreen in the HD Scope section of imaging parameters; and Trackball-Priority ICON is updated with HD Scope, when HD Scope is activated.

| HD Scope Control | Description/Use |
|--|--|
| HD Scope pHD Scope | Toggle the OLED up to turn HD Scope on and off and down to turn pHD Scope on and off. Alternately, a programmable key can be assigned to turn these functions on and off. |
| HDOff, HD0, HD1, HD2, HD3 | Turn the OLED dial to toggle HD 'Settings', which are predefined multi-imaging parameter combinations for faster optimization. Pushing the OLED shall reset the parameters to default. |
| HD Scope Magnify/Size | Turn the OLED dial to the desired Magnification Scale. <ul style="list-style-type: none"> • ROI size does not change. Contents of ROI are magnified. Push the OLED to reset the Magnification to No Magnification or preset value. |
| Display Format | This OLED toggles between image display types: <ul style="list-style-type: none"> • "Integrated": HD Scope within the main image. The HD Scope data replaces that portion of the main image. • "Windowed": HD Scope is presented as a window within a window. The main image within the HD Scope ROI remains unchanged. <ul style="list-style-type: none"> ○ Windowed ROI can be relocated onscreen by pointing with the trackball and pressing a Set Key. |
| HD Scope Frequency | Turn the OLED dial to change the frequency of the B Mode image within the HD Scope ROI only. The main B Mode image remains unchanged. |

M-Mode / Anatomic M-Mode Controls

■ Basic Procedures for M-Mode

1. Select a premium image during B mode scanning, placing the area of interest in the center of the B mode image.
2. Press <M> on the control panel to enter M mode, and move the trackball to adjust the sampling line.
 Tissue motion is displayed on the M-Mode strip, along with the B mode images.
3. Adjust the image parameters and M-Line position to obtain optimized images.
4. Perform other operations (e.g. measurement and calculation) if necessary.

Anatomic M-Mode

For an image in traditional M mode, the M Line follows the beams transmitted from the probe. It may, therefore, be difficult to obtain a good plane for difficult-to-image patients who cannot be moved easily.

However, in Anatomic M mode, the user can manipulate the M-Line and move it to any position or angle.

In Anatomic M-Mode, the cardiac movement trace occurring over time can be obtained by analyzing any part of the 2D image in any direction. After comparison and analysis of multiple sampling lines, the comprehensive information can be obtained, and the tissue can precisely be estimated.

The system supports Anatomic M Mode scanning in B mode.

| | |
|--|---|
| CAUTION:  | Anatomic M-Mode is provided for reference, not for confirming a diagnosis. Generally it should be compared with other devices or the diagnosis should be made using other imaging methods. |
|--|---|

Anatomic M-Mode can be configured to a Programmable Function key. These keys can be configured in **Setup/Keys**.

- Press Setup -> Keys.
- Select an 'F' key
- Click to select Anatomic M-Mode from the drop down menu.
- Click Save to complete the setting.

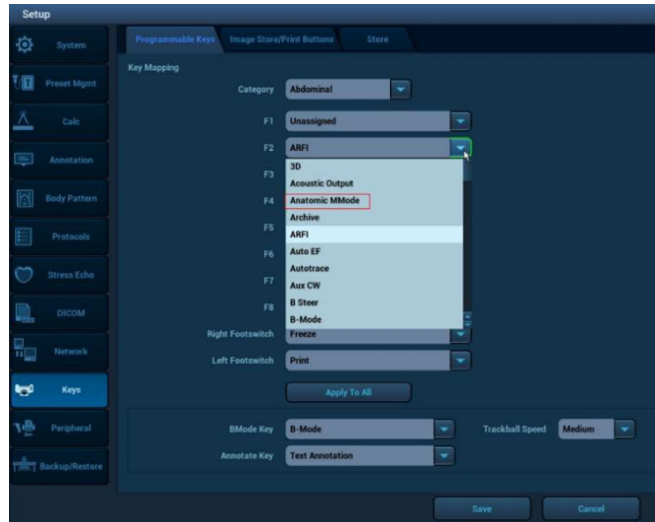

■ **Basic Procedures for Anatomic M-Mode**

1. Select a premium image during B mode scanning, and adjust to place the area of interest in the center of the B mode image.
2. Press the configured key (such as F2) to enter Anatomic M-Mode
3. Move the trackball to adjust the sampling line position.
4. Adjust the sampling line (1, 2, and/or 3 M Lines available simultaneously) angle by turning the OLED dial to obtain optimized images and necessary information.
[Note: M Line position and angle can be adjusted after image is frozen as well.]
5. Adjust the image parameters to obtain optimized images.
6. Perform other operations (e.g. measurement and calculation) if necessary.

Anatomic M-Mode is available any time traditional M-Mode is active using an OLED.

1. Turn on M-Mode
2. Press the OLED assigned to Anatomic M-Mode and continue as described above.
3. Anatomic M-Mode can be turned off by pressing the same OLED control or by pressing the B-Mode knob.

■ **Image Optimization: Grayscale M Mode and Anatomic M Mode**

| M Control | Description/Use |
|---|--|
| * Indicates this control is also available in retrospective processing. | |
| Softkeys OLED controls | While M-Mode is active the Softkeys at the back of the console contain the optimization and navigation controls specific to M-Mode Imaging. Pressing OLED #1 toggles through multiple pages of controls. |

| | |
|---|---|
| Gain*  | Rotate the outer ring of the M-Mode button to adjust the M-Mode strip gain. Increasing the gain will brighten the M-Mode strip, increasing received signals. However, noise may also be increased. |
| Priority | Press the Priority button to gain access to OLED controls assigned to modes that are 'ON' but do not have priority. <ul style="list-style-type: none"> For example, if M-Mode is ON, the OLED controls will reflect M-Mode controls as the active mode. The user can press the Priority button to toggle to B-Mode which will change the OLEDs to B-Mode without having to turn off M Mode. |

Color M Mode



Color Doppler strip is overlaid on the M Mode strip to provide blood flow and tissue movement information simultaneously. CM strip is available for Color Doppler Velocity (CDV), Power Doppler (PD) and Color Tissue Doppler (cTDI). All probes support Color M Mode.

■ Basic Procedures for Color M-Mode



- During regular B mode scanning there are two ways to enable Color M Mode:
 - turn on C-mode; optimize it; and then enter M Mode.
 - enter M Mode; optimize it; and then push the <C> knob to enable Color Doppler.
- During the scanning process, adjust the sampling line accordingly.
- Adjust the image parameters to obtain optimized images.
 - Dedicated Color M Mode controls are available on the OLEDs while CM Mode has priority
 - B Mode and M Mode controls can be accessed by pressing the Priority Key and toggling to the desired mode.
- Trackball and Set keys toggle B Mode/Color image live or B Mode/Color +M Strip live while using a cardiac preset and toggles B Mode/Color image live OR M Strip live when in a non-Cardiac preset.
- Perform other operations (e.g. measurement and calculation) if necessary.
- Exit Color M Mode
 - Press <C> or <M> knob on the control panel to exit Color M Mode
 - Press knob on the control panel to return to B Mode

■ Image Optimization: Color M Mode

| CM Control | Description/Use |
|-------------------------------|---|
| Softkeys OLED controls | While CM-Mode is active, and Priority is set to CM, the Softkeys at the back of the console contain the optimization and navigation controls specific to CM-Mode Imaging. Pressing OLED #1 toggles through multiple pages of controls. |

| | |
|---|---|
| <p>Frequency</p>  | <p>Press the Frequency button to cycle through the transmit frequency choices for CM Mode. The selected value is displayed in the Image Information area.</p> <p>Please select the frequency according to the detection depth and current tissue features.</p> |
| <p>Priority</p>  | <p>Press the Priority button to gain access to OLED controls assigned to modes that are 'ON' but do not have priority.</p> <ul style="list-style-type: none"> For example, if CM-Mode is ON, the OLED controls will reflect CM-Mode controls as the active mode. The user can press the Priority button to toggle to B-Mode which will change the OLEDs to B-Mode without having to turn off Color Doppler or M Mode. |

Color Doppler / Power Doppler / Color Tissue Doppler Modes Controls

| Color/Power Doppler Control | Description/Use |
|---|---|
| <p>Softkeys OLED controls</p> | <p>While Color Doppler is active the Softkeys at the back of the console contain the optimization and navigation controls specific to Color Doppler Imaging.</p> <p>Pressing OLED #1 toggles through multiple pages of controls.</p> |
| <p>* Indicates that this control is also available in retrospective processing</p> | |
| <p>Gain*</p>  | <p>Adjust Gain by rotating the outer ring of the C-Mode button.</p> |
| <p>Frequency</p>  | <p>Press the Frequency button to cycle through the transmit frequency choices.</p> |
| <p>Priority</p>  | <p>Press the Priority button to gain access to OLED controls assigned to modes that are 'ON' but do not have priority.</p> <p>(For example, if Color Doppler is ON, the OLED controls will reflect Color Doppler as the active mode. The user can press the Priority button to toggle to 2D which will reassign the OLEDs to 2D without requiring the user to turn off Color Doppler.)</p> |



There are two mechanisms to invoke Power Doppler (PDI), Directional Power Doppler (dPDI), and Color Tissue Doppler (cTDI):

- They can be assigned to Programmable Function Keys in Setup / Keys. When invoked this way the programmable keys act as PDI or cTDI hard keys and the "C" mode knob is dedicated to Color Doppler Velocity (CDV).
- They can have shared access with PDI, dPDI, and cTDI through the "C" mode knob. When invoked, the default Color mode is determined by preset. While Color Doppler is active a soft key (OLED) toggles between CDV, PDI, dPDI and cTDI (selections will vary depending on exam type). Subsequent invocations of Color Doppler invoke the last used Color Doppler mode.

The optimization controls available in PDI, dPDI, and cTDI are generally the same as in CDV.

Spectral Doppler Mode Controls (Pulsed Wave, Continuous Wave, and Tissue Doppler)

Note: Continuous Wave Doppler imaging is available only on z.one pro systems equipped with the Echocardiology or Advanced Vascular Options.

| Doppler Control | Description/Use |
|--|--|
| Softkeys OLED controls | While Pulsed Wave (PW), Continuous Wave (CW), or Tissue (TDI) Doppler are active, the Softkeys at the back of the console contain the optimization and navigation controls specific to Spectral Doppler Imaging. Pressing OLED #1 toggles through multiple pages of controls. |
| Priority  | Press the Priority button to gain access to OLED controls assigned to modes that are 'ON' but do not have priority. <ul style="list-style-type: none"> For example, if PW Doppler is ON, the OLED controls will reflect PW Doppler controls as the active mode. The user can press the Priority button to toggle to B-Mode which will change the OLEDs to B-Mode without having to turn off Color Doppler. |
| * Indicates that this control is also available in retrospective processing. | |
| Gain*  | Adjust Gain by rotating the outer ring of the D-Mode button. |

There are two mechanisms to invoke CW and TDI:

- They can be assigned to Programmable Function Keys in Setup / Keys. When invoked this way the programmable keys act as CW or TDI hard key and the "D" mode button is dedicated to PW.
- They can have shared access with PW through the "D" mode button. When invoked, the default Doppler mode is determined by preset. While Spectral Doppler is active, a soft key (OLED) toggles between PW, TDI, and CW. Subsequent invocations of Spectral Doppler invoke the last used Doppler mode.

The optimization controls available in CW and TDI are generally the same as in PW. See the Spectral Doppler section (above) for details.

CINE Controls

The z.one pro Ultrasound System contains an Extended Cine buffer which does not 'flush' with mode changes, providing the user with access to data typically lost from the cine buffer when the user freezes the image or changes modes.

The **CINE** controls are accessed via the **Priority Key** or by Pointing to and selecting CINE

on the onscreen Trackball Priority ICON with the Trackball and Set Keys.

| CINE Control | Description/Use |
|---------------------------------|---|
| Trim | Pressing this control allows user to trim a section of cine buffer or stored clips, to save as separate clips |
| Cine Flush | Pushing the dial flushes the CINE buffer resetting the frame counter to 0 |
| Retro On/Off | Toggle Retrospective Capture On and Off |
| Clip A/Peak Hold/ Clip B | Toggle Clip A, Peak Hold, and Clip B which may have different Clip Type selected |
| Clip Type Secs/Beats | <p>Allow user to assign Clip Type as Beats or Seconds.</p> <ul style="list-style-type: none"> • Pushing the dial toggles between Beats and Seconds. • Turning the Dial changing the number of beats or seconds. • “Max” selection allows for open-ended clips. Clips are not automatically terminated upon reaching beats or seconds, but rather are manually terminated by pressing the Store or Print key a second time while clip store is in progress. |
| Clip Pause/Resume | <p>Allows user to pause storing a clip.</p> <ul style="list-style-type: none"> • Press the button to toggle between Pause Clip Store and Resume • Still frames can be stored during the pause • Alternately, user can assign a Programmable key to Clip Pause/Resume |
| Capture Rate | <p>Allows user to manually set the Capture Rate. If the selected capture rate is greater than the imaging frame rate, the capture rate is automatically set to the Frame Rate.</p> <ul style="list-style-type: none"> • Turn the dial to select settings from 5Hz-MAX • Turn the dial to select Actual to maximize number of frames |
| Stopwatch Start/Stop | <p>Toggles between Start and Stop for timers</p> <ul style="list-style-type: none"> • Pushing the button starts and stops an onscreen timer |
| Stopwatch Phase/Reset | <p>Toggles between Phase and Reset</p> <ul style="list-style-type: none"> • Once a timer has been started, pushing the button starts additional phases (up to 4) of the timer. • After pressing Stopwatch Stop, pressing the button resets all timers. |
| Full Image On/Off | Toggle between Full Image and Standard Image Display |
| Hide Pt Bar | Remove the Patient Identifiers from the screen |
| Image Data On/Off | Toggle Image Parameters On/Off |
| Reset Cine | <p>Pressing “Reset Cine” Resets:</p> <ul style="list-style-type: none"> • The trim limits |

| | |
|----------------------------------|--|
| | <ul style="list-style-type: none"> • Cine Select Chapter and Frame to last in the buffer • Playback speed to 100%. |
| Cine Select Frame/Chapter | <p>Cine buffer is parsed into Chapters (modes) and Frames (frames within the chapters)</p> <ul style="list-style-type: none"> • Push the dial to toggle Chapter or Frames • Turn the dial to advance or go back in Chapters or Frame |
| Pause/Play | <p>Push the dial to toggle between CINE Pause and Play</p> <ul style="list-style-type: none"> • When in Pause, turn the Cine Select (Frame) to navigate frame by frame • When in Play, turning the dial increases or decreases speed of playback |

Physio Controls

A physio module that supports ECG and respiratory traces is available. The ECG must be active to enable respiratory. Presets determine if ECG or both traces are on by default. The physio traces can be enabled/disabled and controlled through the “ECG” key in the top row of the keyboard. When the ECG function is invoked the following softkeys are displayed:

| Physio Control | Description/Use |
|-----------------------|--|
| Exit | Exits the ECG control function without changing the traces. |
| ECG | Enables or disable the ECG trace |
| Resp | Enables or disables the Respiratory trace. ECG must be active for the Respiratory trace to be active. |
| Sweep Speed | Changes the Sweep speed of the ECG and Respiratory traces. |
| ECG Size/ Pos | Pressing this knob toggles between controlling the position and size of the ECG trace. Turning the knob changes the position or size. |
| Resp Size/ Pos | Pressing this knob toggles between controlling the position and size of the Resp trace. Turning the knob changes the position or size. |

NOTE: Mindray recommends the following ECG patient cables and lead wires from Advantage Medical Cables (AMC) (www.advantagemed.com):

4. Transducers and Needle-Guided Brackets









- Refer to Transducers Cleaning and Disinfection accompanied with the transducer, for directions, cautions and warnings associated with the care and maintenance of transducers.
- Always examine transducers for damage, such as cracks, splitting, holes, or fluid leaks. If damage is evident, discontinue use of the transducer and contact Mindray.



Transducers



NOTE (1): The z.one pro Ultrasound System is designed for compatibility with the following transducers. Because the availability of transducers is subject to government regulation and approval, some items included in the table may not be commercially marketed nor made available in your region of use.



NOTE (2): Once approved in accordance with local government regulation, access to transducers is further controlled by individual transducer licensing as determined by purchased system configuration.



| Transducer | Applications for the FDA Region | Applications for the Canada Region | Applications for Other Regions | Pictures |
|------------|---|---|--|--|
| A2CW | Pediatric, Cardiac Adult, Cardiac Pediatric | Pediatric, Cardiac Adult, Cardiac Pediatric | Adult Cardiac, Pediatric Cardiac, Pediatric |  |
| A5CW | Pediatric, Peripheral vessel | Pediatric, Peripheral vessel | Pediatric, Peripheral Vascular |  |
| C4-1 | Fetal, Abdominal (includes renal, GYN/Pelvic), Pediatric, Musculo-skeletal (Conventional), Cardiac Adult, Peripheral vessel | Fetal, Abdominal (includes renal, GYN/Pelvic), Pediatric, Musculo-skeletal (Conventional), Cardiac Adult, Peripheral vessel | Abdominal (includes renal, GYN/Pelvic), Adult Cardiac, Contrast, Fetal, Musculo-skel (conventional), Pediatric, Peripheral Vascular, Urology |  |
| C6-2 | Fetal, Abdominal (includes renal, GYN/Pelvic), Pediatric, Peripheral vessel | Fetal, Abdominal (includes renal, GYN/Pelvic), Pediatric, Peripheral vessel | Abdominal (includes renal, GYN/Pelvic), Contrast, Fetal, Pediatric, Peripheral Vascular, Urology |  |



| Transducer | Applications for the FDA Region | Applications for the Canada Region | Applications for Other Regions | Pictures |
|------------|---|---|--|--|
| C6-1 | Fetal, Abdominal (includes renal, GYN/Pelvic), Pediatric, Peripheral vessel | Fetal, Abdominal (includes renal, GYN/Pelvic), Pediatric, Peripheral vessel | Abdominal (includes renal, GYN/Pelvic), Contrast, Fetal, Pediatric, Peripheral Vascular, Urology |  |
| C8-3 3D | Fetal, Abdominal (includes renal, GYN/Pelvic), Pediatric, Peripheral vessel | Fetal, Abdominal (includes renal, GYN/Pelvic), Pediatric, Peripheral vessel | Abdominal (includes renal, GYN/Pelvic), Fetal, Pediatric, Peripheral Vascular, 3D/4D, Contrast, Urology |  |
| C9-3 | Fetal, Abdominal (includes renal, GYN/Pelvic), Intra-operative (abdominal, and vascular (PV)), Pediatric, Small Organ (Thyroid, Breast, Testes, etc.), Musculo-skeletal (Conventional), Musculo-skeletal (Superficial), Peripheral vessel | Fetal, Abdominal (includes renal, GYN/Pelvic), Pediatric, Small Organ (Thyroid, Breast, Testes, etc.), Musculo-skeletal (Conventional), Musculo-skeletal (Superficial), Peripheral vessel | Abdominal (includes renal, GYN/Pelvic), Contrast, Fetal, Intra-operative (abdominal), Intra-operative (vascular), Musculo-skel (conventional), Musculo-skel (Superficial), Pediatric, Peripheral Vascular, Small Organ (Thyroid, Breast, Testes, etc), Urology |  |



| Transducer | Applications for the FDA Region | Applications for the Canada Region | Applications for Other Regions | Pictures |
|------------|---|--|---|--|
| C9-3sp | Fetal, Abdominal (includes renal, GYN/Pelvic), Intra operative include (abdominal, and vascular (PV)), Pediatric, Musculo-skeletal (Conventional), Musculo-skeletal (Superficial), Peripheral vessel | Fetal, Abdominal (includes renal, GYN/Pelvic), Intra operative include (abdominal, and vascular (PV)), Pediatric, Musculo-skeletal (Conventional), Musculo-skeletal (Superficial), Peripheral vessel | Abdominal (includes renal, GYN/Pelvic), Contrast, Fetal, Intraoperative (Neuro, abdominal, thoracic (cardiac) and vascular (PV)), Musculo-skel (conventional), Musculo-skel (Superficial), Neonatal Cephalic, Pediatric, Peripheral Vascular, Small Organ (Thyroid, Breast, Testes, etc), Urology |  |
| C10-3 | Ophthalmic, Fetal, Abdominal (includes renal, GYN/Pelvic), Intra-operative (abdominal, thoracic (Cardiac) and vascular (PV)), Intra-operative (Neuro), Pediatric, Neonatal Cephalic, Adult Cephalic/Transcranial, Cardiac Adult, Cardiac Pediatric, Peripheral vessel | Ophthalmic, Fetal, Abdominal (includes renal, GYN/Pelvic), Pediatric, Neonatal Cephalic, Adult Cephalic/Transcranial, Cardiac Adult, Cardiac Pediatric, Peripheral vessel | Ophthalmic, Abdominal (includes renal, GYN/Pelvic), Adult Cephalic/ transcranial, Adult Cardiac, Pediatric Cardiac, Fetal, Intra-operative (Neuro, abdominal, thoracic (cardiac) and vascular (PV)), Neonatal Cephalic, Pediatric, Peripheral vascular, Contrast, Urology |  |





| Transducer | Applications for the FDA Region | Applications for the Canada Region | Applications for Other Regions | Pictures |
|------------|--|--|--|--|
| C18-5 | Ophthalmic, Fetal, Abdominal (includes renal, GYN/Pelvic), Intra-operative (abdominal, thoracic (Cardiac) and vascular (PV)), Intra-operative (Neuro), Pediatric, Small Organ (Thyroid, Breast, Testes, etc.), Neonatal Cephalic, Musculo-skeletal (Conventional), Musculo-skeletal (Superficial), Peripheral vessel | Ophthalmic, Fetal, Abdominal (includes renal, GYN/Pelvic), Pediatric, Small Organ (Thyroid, Breast, Testes, etc.), Neonatal Cephalic, Musculo-skeletal (Conventional), Musculo-skeletal (Superficial), Peripheral vessel | Ophthalmic, Abdominal (includes renal, GYN/Pelvic), Contrast, Fetal, Musculo-skel (conventional), Musculo-skel (superficial), Pediatric, Peripheral Vascular, Small Organ (Thyroid, Breast, Testes, etc), Intra-operative (Neuro, abdominal, thoracic (cardiac) and vascular (PV)), Neonatal Cephalic, Urology |  |
| E9-3 3D | Fetal, Abdominal (includes renal, GYN/Pelvic), Trans-rectal, Trans-vaginal | Fetal, Abdominal (includes renal, GYN/Pelvic), Trans-rectal, Trans-vaginal | Abdominal (includes renal, GYN/Pelvic), Fetal, Trans-rectal, Trans-vaginal, 3D/4D, Contrast |  |

| Transducer | Applications for the FDA Region | Applications for the Canada Region | Applications for Other Regions | Pictures |
|------------|--|--|--|--|
| E9-3 | Fetal, Abdominal (includes renal, GYN/Pelvic), Trans-rectal, Trans-vaginal | Fetal, Abdominal (includes renal, GYN/Pelvic), Trans-rectal, Trans-vaginal | Abdominal (includes renal, GYN/Pelvic), Fetal, Trans-rectal, Trans-vaginal, Contrast |  |
| E9-4 | Fetal, Abdominal (includes renal, GYN/Pelvic), Trans-rectal, Trans-vaginal | Fetal, Abdominal (includes renal, GYN/Pelvic), Trans-rectal, Trans-vaginal | Abdominal (includes renal, GYN/Pelvic), Fetal, Trans-rectal, Trans-vaginal, Contrast |  |

| Transducer | Applications for the FDA Region | Applications for the Canada Region | Applications for Other Regions | Pictures |
|------------|--|--|--|--|
| L8-3 | Fetal, Abdominal (includes renal, GYN/Pelvic), Intra-operative (abdominal, thoracic (Cardiac) and vascular (PV)), Intra-operative (Neuro), Pediatric, Small Organ (Thyroid, Breast, Testes, etc.), Neonatal Cephalic, Musculo-skeletal (Conventional), Musculo-skeletal (Superficial), Peripheral vessel | Fetal, Abdominal (includes renal, GYN/Pelvic), Pediatric, Small Organ (Thyroid, Breast, Testes, etc.), Neonatal Cephalic, Musculo-skeletal (Conventional), Musculo-skeletal (Superficial), Peripheral vessel | Fetal, Abdominal (includes renal, GYN/Pelvic), Intra-operative (Neuro, abdominal, thoracic (cardiac) and vascular (PV)), Pediatric, Small Organ (Thyroid, Breast, Testes, etc), Musculo-skel (Conventional), Musculo-skel (Superficial), Peripheral Vascular, Contrast |  |
| L14-5sp | Ophthalmic, Fetal, Abdominal (includes renal, GYN/Pelvic), Intra-operative (abdominal, thoracic (Cardiac) and vascular (PV)), Intra-operative (Neuro), Pediatric, Small Organ (Thyroid, Breast, Testes, etc.), Neonatal Cephalic, Musculo-skeletal (Conventional), Musculo-skeletal (Superficial), Peripheral vessel | Ophthalmic, Fetal, Abdominal (includes renal, GYN/Pelvic), Intra-operative (abdominal, and vascular (PV)), Pediatric, Small Organ (Thyroid, Breast, Testes, etc.), Neonatal Cephalic, Musculo-skeletal (Conventional), Musculo-skeletal (Superficial), Peripheral vessel | Ophthalmic, Abdominal (includes renal, GYN/Pelvic), Fetal, Intraoperative (Neuro, abdominal, thoracic (cardiac) and vascular (PV)), Musculo-skel (conventional), Musculo-skel (superficial), Neonatal Cephalic, Pediatric, Peripheral Vascular, Small Organ (Thyroid, Breast, Testes, etc), Contrast |  |

| Transducer | Applications for the FDA Region | Applications for the Canada Region | Applications for Other Regions | Pictures |
|------------|--|--|--|--|
| L14-5w | Ophthalmic, Fetal, Abdominal (includes renal, GYN/Pelvic), Intra-operative (abdominal, thoracic (Cardiac) and vascular (PV)), Intra-operative (Neuro), Pediatric, Small Organ (Thyroid, Breast, Testes, etc.), Neonatal Cephalic, Musculo-skeletal (Conventional), Musculo-skeletal (Superficial), Peripheral vessel | Ophthalmic, Fetal, Abdominal (includes renal, GYN/Pelvic), Pediatric, Small Organ (Thyroid, Breast, Testes, etc.), Neonatal Cephalic, Musculo-skeletal (Conventional), Musculo-skeletal (Superficial), Peripheral vessel | Ophthalmic, Abdominal (includes renal, GYN/Pelvic), Contrast, Fetal, Intraoperative (Neuro, abdominal, thoracic (cardiac) and vascular (PV)), Musculo-skel (conventional), Musculo-skel (superficial), Neonatal Cephalic, Pediatric, Peripheral Vascular, Small Organ (Thyroid, Breast, Testes, etc) |  |
| L10-5 | Ophthalmic, Fetal, Abdominal (includes renal, GYN/Pelvic), Intra-operative (abdominal, thoracic (Cardiac) and vascular (PV)), Intra-operative (Neuro), Pediatric, Small Organ (Thyroid, Breast, Testes, etc.), Neonatal Cephalic, Musculo-skeletal (Conventional), Musculo-skeletal (Superficial), Peripheral vessel | Ophthalmic, Fetal, Abdominal (includes renal, GYN/Pelvic), Pediatric, Small Organ (Thyroid, Breast, Testes, etc.), Neonatal Cephalic, Musculo-skeletal (Conventional), Musculo-skeletal (Superficial), Peripheral vessel | Ophthalmic, Abdominal (includes renal, GYN/Pelvic), Fetal, Intraoperative (Neuro, abdominal, thoracic (cardiac) and vascular (PV)), Musculo-skel (conventional), Musculo-skel (superficial), Neonatal Cephalic, Pediatric, Peripheral Vascular, Small Organ (Thyroid, Breast, Testes, etc), Contrast |  |

| Transducer | Applications for the FDA Region | Applications for the Canada Region | Applications for Other Regions | Pictures |
|------------|---|---|--|---|
| L20-5 | Ophthalmic, Fetal, Abdominal (includes renal, GYN/Pelvic, Intra-operative (abdominal, thoracic (Cardiac) and vascular (PV)), Intra-operative (Neuro), Pediatric, Small Organ (Thyroid, Breast, Testes, etc.), Neonatal Cephalic, Musculo-skeletal (Conventional), Musculo-skeletal (Superficial), Peripheral vessel | Ophthalmic, Fetal, Abdominal (includes renal, GYN/Pelvic, Pediatric, Small Organ (Thyroid, Breast, Testes, etc.), Neonatal Cephalic, Musculo-skeletal (Conventional), Musculo-skeletal (Superficial), Peripheral vessel | Ophthalmic, Abdominal (includes renal, GYN/Pelvic), Contrast, Fetal, Intraoperative (Neuro, abdominal, thoracic (cardiac) and vascular (PV)), Musculo-skel (conventional), Musculo-skel (superficial), Neonatal Cephalic, Pediatric, Peripheral Vascular, Small Organ (Thyroid, Breast, Testes, etc) |  |
| P4-1c | Fetal, Abdominal (includes renal, GYN/Pelvic), Pediatric, Neonatal Cephalic, Adult Cephalic/Transcranial, Cardiac Adult, Cardiac Pediatric, Peripheral vessel | Fetal, Abdominal (includes renal, GYN/Pelvic), Pediatric, Neonatal Cephalic, Adult Cephalic/Transcranial, Cardiac Adult, Cardiac Pediatric, Peripheral vessel | Adult Cephalic/ Trans-cranial, Abdominal (includes renal, GYN/Pelvic), Cardiac Adult, Cardiac Pediatric, Contrast, Fetal, Neonatal Cephalic, Pediatric, Peripheral Vascular, Urology |  |
| P8-3TEE | Trans-esoph. (non-Card.), Trans-esoph. (Cardiac) | Trans-esoph. (non-Card.), Trans-esoph. (Cardiac) | Transesophageal Echocardiography (non-cardiac and cardiac), Contrast |  |

| Transducer | Applications for the FDA Region | Applications for the Canada Region | Applications for Other Regions | Pictures |
|------------|--|--|---|---|
| P8-3mTEE | Trans-esoph. (non-Card.), Trans-esoph. (Cardiac) | Trans-esoph. (non-Card.), Trans-esoph. (Cardiac) | Transesophageal Echocardiography (non-cardiac and cardiac), Contrast |  |
| P9-3ic | Intra-cardiac | / | / |  |
| L30-8 | Ophthalmic, Small Organ (Thyroid, Breast, Testes, etc.), Neonatal Cephalic, Musculo-skeletal (Conventional), Musculo-skeletal (Superficial), Peripheral vessel | / | Ophthalmic, Small Parts, Vascular, Musculo-skeletal, Cephalic, Pediatric, Nerve |  |
| P7-3c | Fetal, Abdominal (includes renal, GYN/Pelvic), Pediatric, Neonatal Cephalic, Adult Cephalic/ Transcranial, Cardiac Adult, Cardiac Pediatric | / | Abdominal (includes renal, GYN/Pelvic), Cardiac, Cephalic, Pediatric, Urology |  |

| Transducer | Applications for the FDA Region | Applications for the Canada Region | Applications for Other Regions | Pictures |
|------------|---------------------------------|------------------------------------|--------------------------------|---|
| C12-4lp | Laparoscopic | / | / |  |

Notes: For details about the P8-3TEE and P8-3mTEE transducers, please refer to the TEE transducer manual. For details about the C12-4lp transducer, please refer to the laparoscopic transducer manual.

Needle-guided Bracket

Needle-guided brackets are available for purchase as optional accessories and are used in combination with the probe. Some probes have corresponding needle-guided brackets and needles. To order needle-guided brackets, contact the MINDRAY Customer Service Department or a sales representative.

For biopsy or treatment, ultrasound-guided biopsy procedures can be performed using the probe together with a needle-guided bracket (optional accessory) and a biopsy needle (provided by the user).

Some of the probes have corresponding needle-guided brackets for biopsy. The available probes and the corresponding needle-guided brackets are listed as follows:

| Transducer | Needle-guided Bracket | Biopsy angle/depth ($\pm 1^\circ$) | Applicable Biopsy Needle |
|------------|---------------------------------------|--------------------------------------|--------------------------|
| C6-1 | NGB-022 metal/needle detachable | 25°, 35°, 45° | 14G, 16G, 18G, 20G, 22G |

CIVCO Bracket

| Transducer | Needle-guided Bracket |
|------------|--|
| C4-1 | CIVCO 698-013; CIVCO 698-019 |
| C6-2 | CIVCO 698-003 |
| C9-3 | CIVCO 698-009 |
| E9-3 | CIVCO 698-002; CIVCO 698-014 |
| E9-4 | CIVCO 698-002; CIVCO 698-010 CIVCO 698-011; CIVCO 698-014 |
| L8-3 | CIVCO 698-005 |
| L14-5sp | CIVCO 698-006 |
| L14-5w | CIVCO 698-007; CIVCO 698-012 |
| L10-5 | CIVCO 698-004; CIVCO 698-008 CIVCO 698-015 |

Note: For details about the CIVCO needle-guided brackets, please refer to the accompanying manual or directly contact the CIVCO for obtaining information.

Names of Parts

This section describes the parts and corresponding functions of each needle-guided bracket. Here, we take a corresponding probe as an example.

NGB-022 Metal/needle undetachable needle-guided bracket

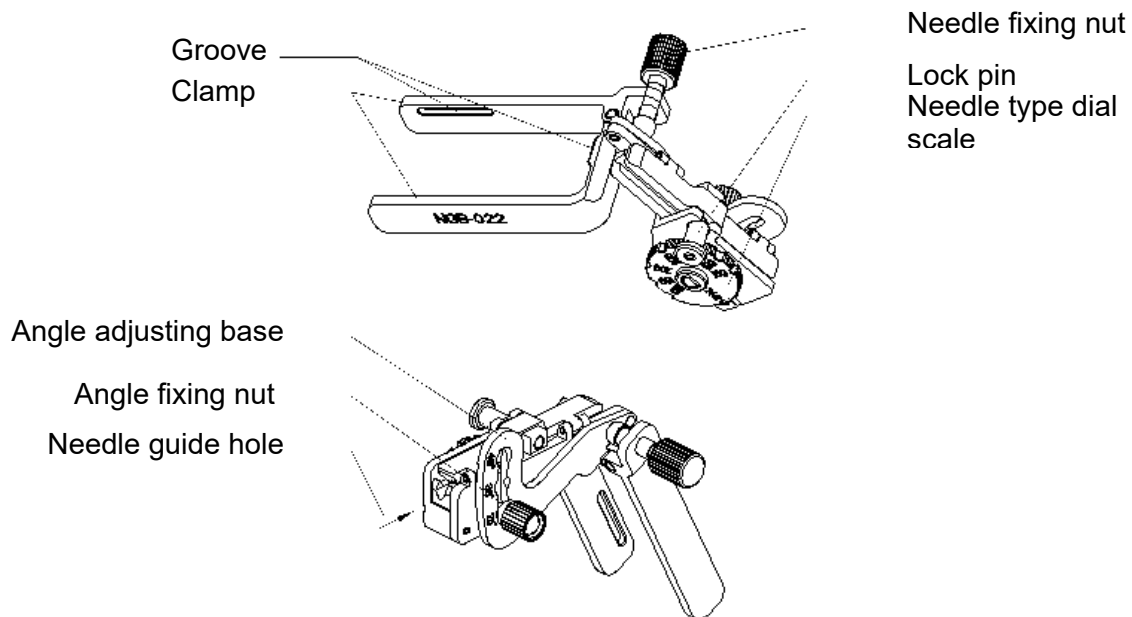

Installing the Needle-Guided Bracket

NGB-022

- (1) Put on the sterile transducer sheath.
- (2) Hold the transducer by one hand, select the proper needle-guided bracket, and hold it with the other hand. Match the groove of the bracket with the tab of the transducer. Amount the bracket onto the transducer.

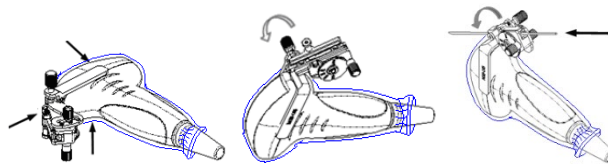

- (3) Screw the pinch nut of the needle-guided bracket to confirm that the needle-guided bracket is properly installed on the transducer.
- (4) Adjust the dial scale to the required needle type shift, and then screw the needle fixing nut to lock the dial scale. (To adjust the dial scale you have to loose the needle fixing nut first.)
- (5) Pull the lock pin and close the V-shaped cover to fix the lock pin in the groove of the needle type adjusting base, so as to install the needle into the guiding hole.

Removing the Needle-Guided Bracket

NGB-022

- (1) Pull the lock pin and open up the V-shaped cover to expose the needle.

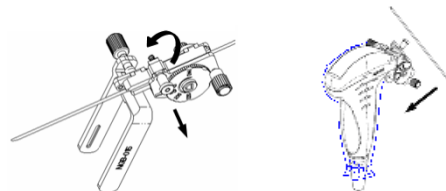

- (2) Separate the bracket and the transducer from the needle.
- (3) Screw the pinch nut to release the needle-guided bracket.

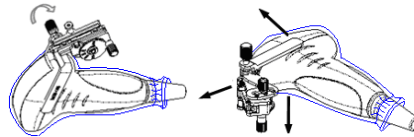

- (4) Separate the bracket and the transducer.

Biopsy Menu/Guideline Verification

Adjusting the needle mark is necessary before each biopsy procedure.

1. Confirm that the needle-guided bracket has been installed securely in the correct position.
2. Prepare a container filled with sterile water.
3. Place the head of the probe in the sterile water and place a biopsy needle in the needle guide.
4. When the biopsy needle appears on the image, confirm that the biopsy needle is displayed at almost the same position as the selected needle mark.

 **Prior to each biopsy procedure, be sure to verify the guide line.**
WARNING: If the needle is not consistent with the guide line, DO NOT perform the biopsy procedure.

Biopsy Guideline

Press the configured key assigned to Biopsy to enter Biopsy

- Press the OLED key assigned to Angle/guide Line to select the biopsy bracket angle/guide line
- Press the OLED key assigned to Guide Line Dot Size to select the guide line dot size
- Press the configured key assigned to Biopsy or the OLED key assigned to Exit to exit biopsy.

Verification

Press the OLED key assigned to Verify to enter Biopsy Verify mode

- Press the OLED key assigned to Position to adjust the guide line position
- Press the OLED key assigned to Angle to adjust the angle
- Press the OLED key assigned to Save to save the verified settings
- Press the OLED key assigned to Restore to restore the factory default settings
- Press the OLED key assigned to Verify or Exit to exit biopsy verify status

TEE Transducers/Laparoscopic Transducers

The z.one pro system will support laparoscopic imaging when used with the C12-4lp transducer, and TEE imaging when used with the P8-3 TEE and P8-3m TEE transducers.



Refer to TEE and laparoscopic Transducer for instructions on inspecting, cleaning, and maintaining the TEE and laparoscopic transducers.

C12-4lp

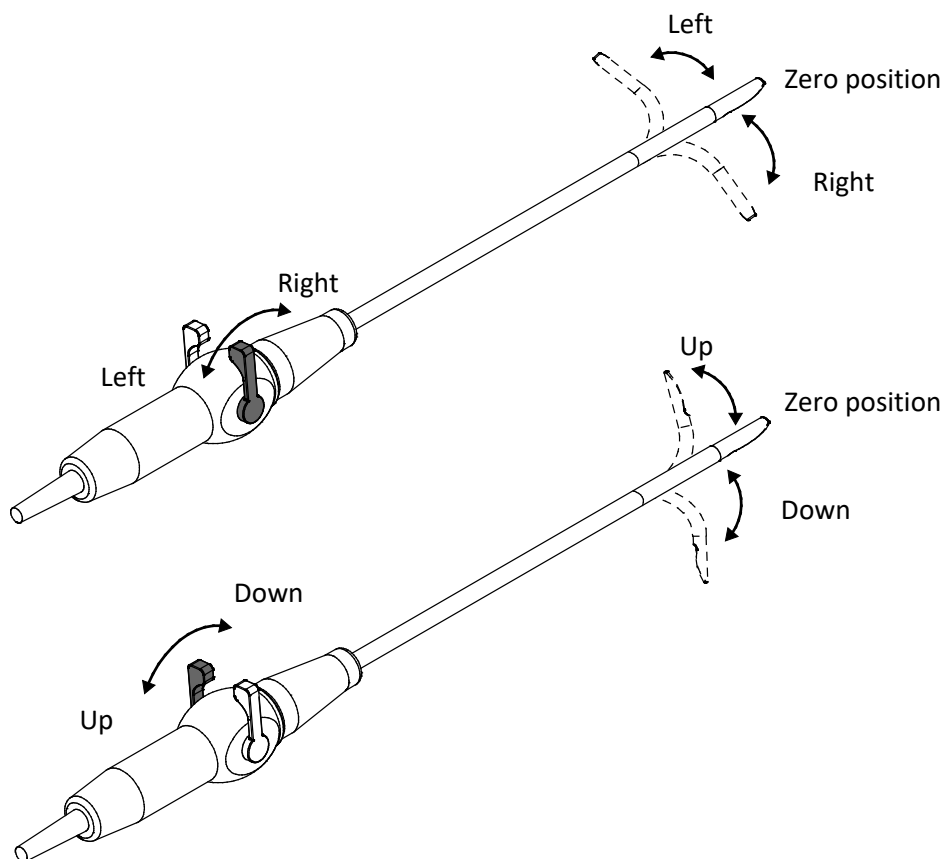

Figure 4-1: Laparoscopic Transducer Handle and Adjusting Levers

Scan plane rotation is controlled by two adjusting levers on the control handle and can be rotated from -90° to 90° . The adjusting levers control the deflection of the tip. The left adjusting lever is used to control the transducer Up/Down (both 90°). The right adjusting lever is used to control the transducer Left/Right (both 90°).

P8-3 TEE

Scan plane rotation is controlled by two push-buttons on the control handle and can be rotated from 0° to 180° . The wheels on the handle of the transducer control the deflection of the tip. The smaller lower wheel is used to control the transducer Left/Right tip deflection ($\geq 45^{\circ}$ left and $\geq 45^{\circ}$ right). The larger wheel on top of the handle is used to control the transducer Anterior/Posterior tip deflection ($\geq 120^{\circ}$ upwards and $\geq 90^{\circ}$ backwards). Both wheels have a friction lock and freely moving mode.

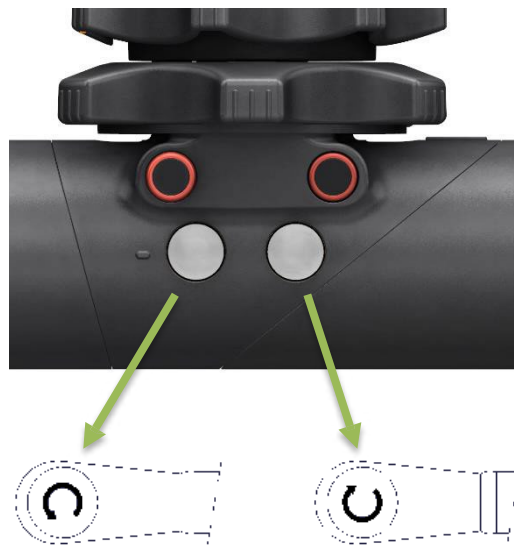

Figure 4-2: Adult TEE Transducer Handle and Scan Plane Adjustments

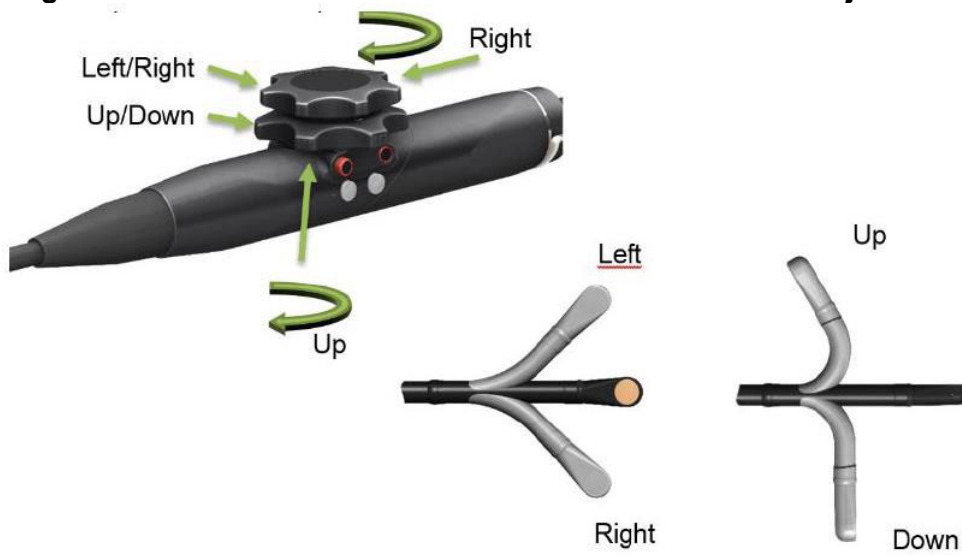

Figure 4-3: Adult TEE Transducer Tip Deflection Controls

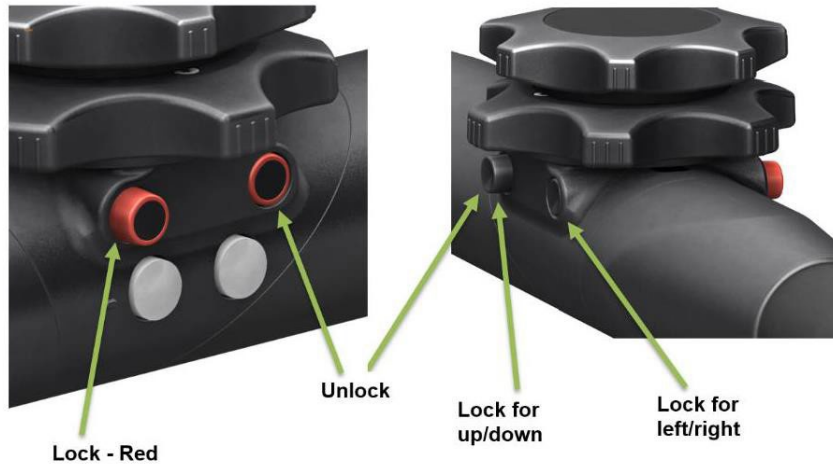

Figure 4-4: Adult TEE Transducer Lock Operation

P8-3m TEE

The smaller wheel on the handle of the transducer controls the scan plane. The transducer scan plane can be rotated from 0° (transversal plane) to 90° (longitudinal plane) to 180° (transversal plane, left/right inverted) All planes in between can also be chosen. This makes it possible to scan a conical imaging volume. The larger wheel on top of the handle is used to control the transducer Anterior/Posterior tip deflection (120° +10° up and 90° +10° down). Both wheels have a friction lock and freely moving mode.

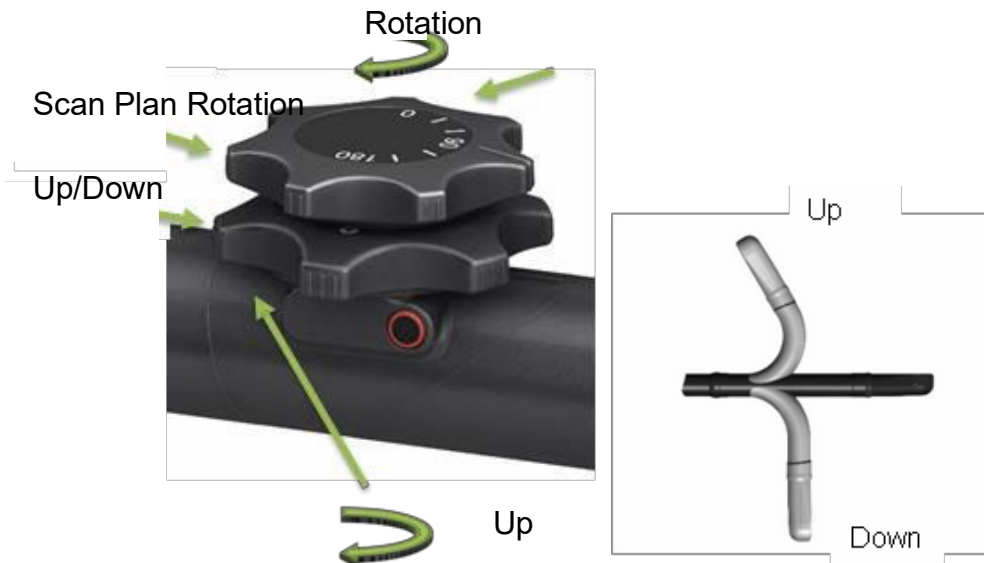

Figure 4-5: P8-3m Adult and Pediatric TEE Transducer Handle

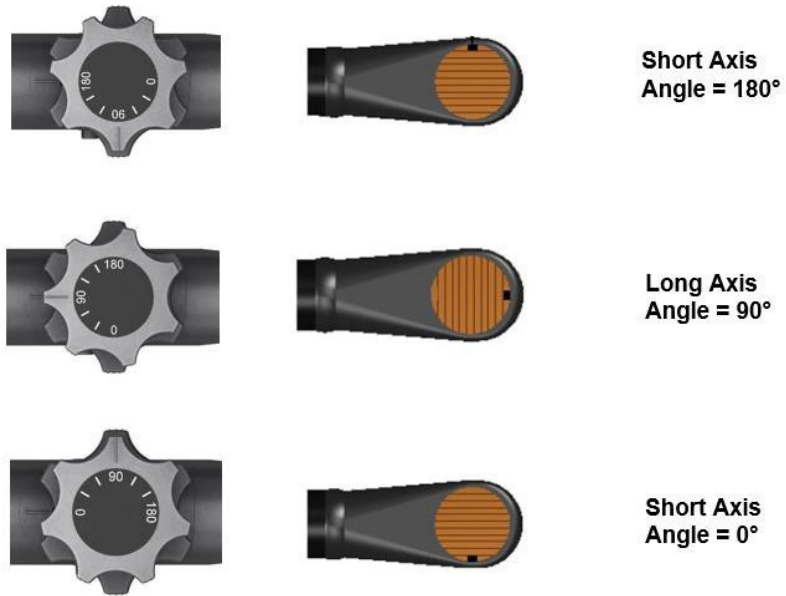

Figure 4-6: P8-3m Adult and Pediatric TEE Scan Plane adjustment

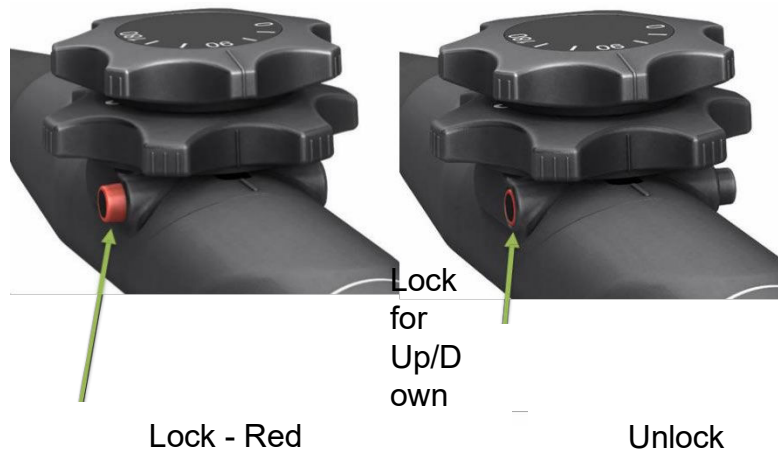
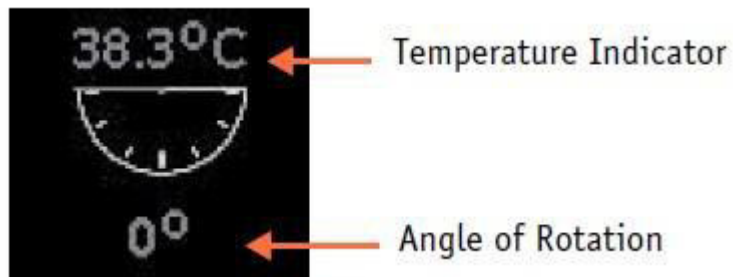

Figure 4-7: P8-3m Adult and Pediatric TEE Lock Operation

The TEE probes include sensors to monitor the temperature of the tip during use. While imaging the following on-screen indicator is shown:



The angle of rotation shows the scan plane rotation while the temperature indicator shows the temperature at the transducer face. This indicator can optionally be turned

off if the temperature is below 40.5°C. Above that temperature the indicator will always be displayed. In addition:

- If the temperature reaches 41.5°C the system will automatically freeze and display a warning message. This warning message can be dismissed and imaging can continue. While operating at this temperature is safe, close monitoring of the temperature is recommended. The temperature indicator will show in yellow to indicate this.
- If the temperature reaches 42.7°C the system will automatically freeze imaging. The transducer must be disconnected and allowed to cool off before additional imaging is supported.

The z.one pro organizes presets by transducer and by exam category. The exam type is a mechanism to filter the list of presets seen for any given transducer. The following table shows the exam categories supported for each transducer:

*(*Ophthalmic Imaging Note: Probes with an asterisk in the Small Parts column have been power adjusted [MI, TI, Ispta.3 limits] to provide for safe use during ophthalmic imaging. Care should be taken to limit ophthalmic use to those probes and presets.)*

| Transducer | Abdominal | Obstetrics | Gynecology | Vascular | Cardiac | Small Parts | Pediatric | Urology | POC |
|------------|-----------|------------|------------|----------|---------|----------------|-----------|---------|-----|
| A2CW | | | | | X | | | | |
| A5CW | | | | X | | | | | |
| C4-1 | X | X | X | X | X | | X | X | |
| C6-2 | X | X | X | X | | | X | X | |
| C6-1 | X | X | X | X | | | X | X | |
| C8-3 3D | X | X | X | X | | | X | X | |
| C9-3 | X | X | X | X | | X | X | X | |
| C9-3sp | X | | | X | | | X | X | |
| C10-3 | X | X | | X | X | X [*] | X | X | |
| C18-5 | X | | | X | | X [*] | X | X | |
| L14-5w | X | | | X | | X [*] | X | | X |
| L14-5sp | X | | | X | | X [*] | X | | X |
| L10-5 | X | | | X | | X [*] | X | | X |
| L20-5 | X | | | X | | X [*] | X | | X |
| L8-3 | X | | | X | | X | X | | X |

| Transducer | Abdominal | Obstetrics | Gynecology | Vascular | Cardiac | Small Parts | Pediatric | Urology | POC |
|------------|-----------|------------|------------|----------|---------|-------------|-----------|---------|-----|
| E9-3 3D | | X | X | | | | | X | |
| E9-3 | | X | X | | | | | X | |
| E9-4 | | X | X | | | | | X | |
| P4-1c | X | X | X | X | X | | X | X | |
| P8-3TEE | | | | | X | | | | |
| P8-3m TEE | | | | | X | | | | |
| P9-3ic | | | | | X | | | | |
| L30-8 | | | | X | X | X* | | | |
| P7-3c | X | X | X | X | X | | X | X | |
| C12-4lp | X | | X | | | | | X | |

Wearing the Probe Sheath

A legally marketed probe sheath must be installed over the probe before performing intracavitary and intra-operative examination. Protective barriers may be required to minimize disease transmission. Probe sheaths are available for use with all clinical situations where infection is a concern.

To order probe sheath, contact:

CIVCO Medical Instruments Co.

102 First Street South, Kalona, IA 52247-9589 USA Tel: 1-319-656-4447

E-mail: info@civco.com

<http://www.civco.com>



CAUTION:

1. Be sure to cover the probe with a new (unused) probe sheath to prevent infection during examination. If the package of a probe sheath is open or broken, the sterilization of the probe sheath may not be sufficient. DO NOT use such a probe sheath.
2. The cover contains natural rubber latex and talc that can cause allergic reactions in some individuals.
3. DO NOT use an expired probe sheath. Before using a probe sheath, verify whether the term of validity has expired.
4. For neurological intra-operative probes, users are recommended to use a sterile, non-pyrogenic sheaths.
5. For neurological intra-operative probes, user should be aware of the following potential problem in using the probe on patients with known or suspected Creutzfeldt Jakob disease (CJD). The probe sheath should not be relied upon to prevent contamination of the probe. A transducer exposed to central nervous system tissue from known or suspected CJD or variant CJD (vCJD) should be destroyed since it may not be possible to sterilize it.

Method (for reference only):

1. Place an appropriate amount of gel inside the sheath or on the probe acoustic lens. Poor imaging may result if no gel is used.

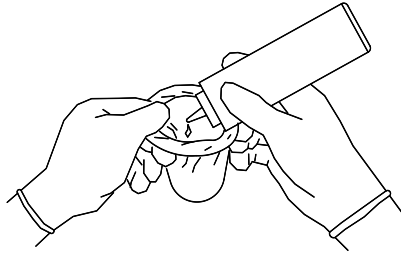

2. Insert the probe into the sheath; make sure to use proper sterile technique. Pull cover tightly over probe acoustic lens to remove wrinkles and air bubbles, and taking care to avoid puncturing the sheath.

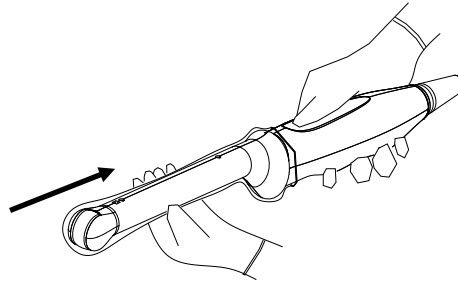

3. Secure the sheath with the enclosed elastic bands.

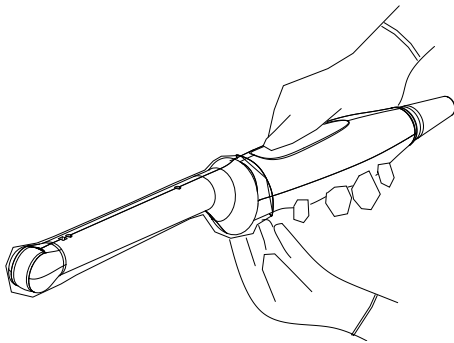

4. Inspect the sheath to ensure there is no hole or tear.

Refer to the following dimension table of all probes to choose the necessary probe sheath type.

| Probe | Length(mm) | Width(mm) | Height(mm) | Cable Length(mm) |
|---------|------------|-----------|------------|------------------|
| A2CW | 120 | 80 | 18 | 1750±50 |
| A5CW | 123 | 11.2 | 11.2 | 1750±50 |
| C4-1 | 98.1 | 45.8 | 25.4 | 1980±50 |
| C6-2 | 111.2 | 68.1 | 31 | 1950±50 |
| C6-1 | 112.4 | 76.5 | 28 | 1950±50 |
| C8-3 3D | 116.5 | 70 | 42.6 | 1950±50 |
| C9-3 | 107.8 | 49.3 | 25.8 | 1980±50 |
| C9-3sp | 44.5 | 46 | 37.5 | 2525±50 |
| C10-3 | 72.5 | 28.6 | 23 | 2000±50 |

| Probe | Length(mm) | Width(mm) | Height(mm) | Cable Length(mm) |
|-----------|------------|-----------|------------|------------------|
| C18-5 | 98 | 43 | 24.1 | 1980±50 |
| L14-5w | 98 | 66.5 | 25.6 | 1980±50 |
| L14-5sp | 95.1 | 70.8 | 25.4 | 2489±50 |
| L10-5 | 106.5 | 43.3 | 31 | 1950±50 |
| L20-5 | 98 | 43 | 24.1 | 1980±50 |
| L8-3 | 100.1 | 56.3 | 27.9 | 1950±50 |
| E9-3 3D | 297.1 | 39.6 | 32.2 | 1950±50 |
| E9-3 | 301 | 44.6 | 34.2 | 1950±50 |
| E9-4 | 301 | 44.6 | 34.2 | 1950±50 |
| P4-1c | 89 | 35.2 | 28.6 | 1980±50 |
| P8-3TEE | 1100 | 14.2 | 11.5 | 1750±50 |
| P8-3m TEE | 720 | 10.9 | 8.7 | 1830±50 |
| L30-8 | 30 | 18.2 | 15 | 2025±50 |
| P7-3c | 80 | 33.4 | 26.5 | 1980±50 |
| C12-4lp | 560 | 66.5 | 50 | 2525±50 |

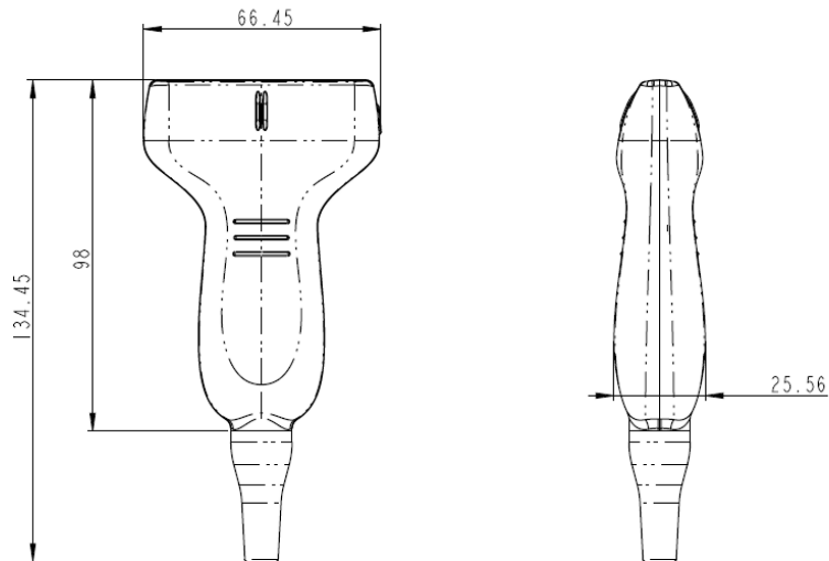

The above is a dimension illustration of the L14-5w probe.
 You can select the probe sheath according to the actual application situation.

Transducer Tracking

Transducer Tracking is a feature designed to track usage of transducers by serial number.

Press the **Service** key on the Alphanumeric Keyboard

- To Enable Transducer Tracking
- Check the desired Data Retention box to establish timeframe to maintain this data

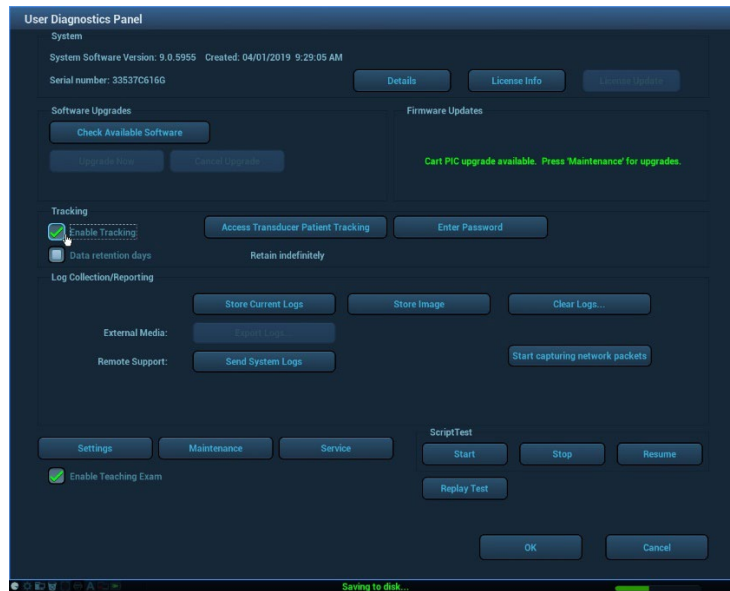

- Select the **Access Transducer Patient Tracking** onscreen button to display transducer specific data including Serial Number of Transducer, Transducer ID, Patient ID transducer was used on and Exam Date and Time the transducer was used.

The screenshot shows the 'Transducer Patient Database' with the following data:

| Serial NO. | XDCR ID | Patient ID | Exam Date | Exam Time |
|--------------|---------|----------------------|------------|-----------|
| 04332L5X113J | L9-3 | 20181112-163952-4028 | 2018-11-12 | 16:39:52 |
| 02535C4K113H | C4-1 | 20181119-160741-4028 | 2018-11-19 | 16:07:41 |
| 02535C4K113H | C4-1 | 20181128-095232-4028 | 2018-11-28 | 09:52:32 |
| 02535C4K113H | C4-1 | 20181128-110326-4028 | 2018-11-28 | 11:03:26 |
| 02535C4K113H | C4-1 | 20181128-111326-4028 | 2018-11-28 | 11:13:26 |

Buttons at the bottom: Configure, Export, Clear, Exit.

- Press the **Setup** key and select the **System** Button /**Image** Tab to display the Transducer Information on the image

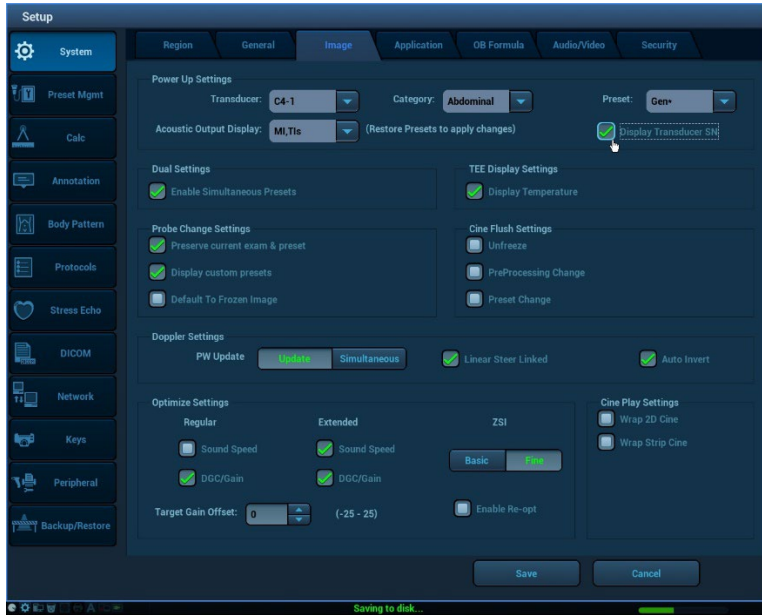

- Press the **Setup** key and select the **DICOM** and **Set DICOM Service** buttons to include the Transducer Information in the DICOM transfer.

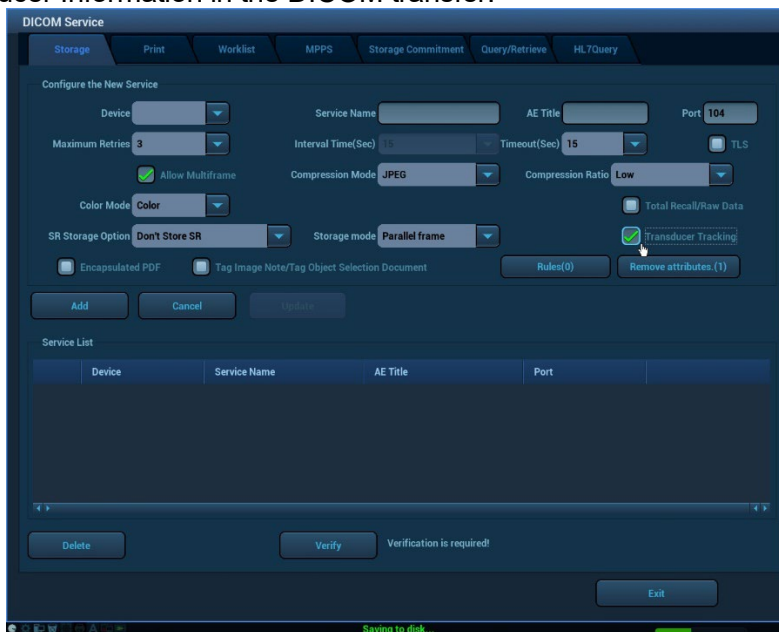





5. Measurements and Calculations

Basic Measurements Operation

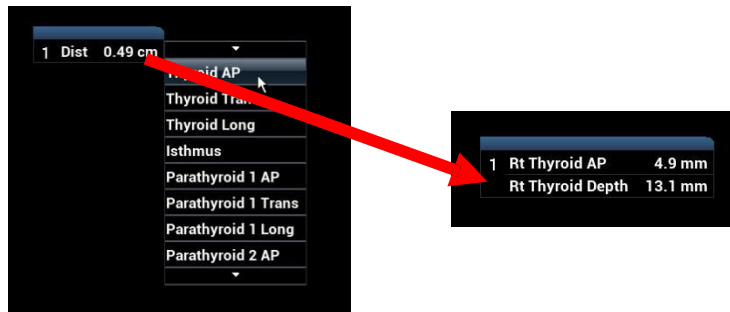
Measurements and calculations can be performed on zoomed images, stored images, real-time images or frozen images.

| Control | Description/Use |
|--|---|
| <p>Caliper Button</p>  | <p>Generic measurement tool are accessed in all imaging modes by pressing the Caliper button. A subset of measurements is available in live imaging.</p> <p>Users may 'assign' generic measurements to calculations after a measurement is complete.</p> <ul style="list-style-type: none"> For instance, if a user measures the AP dimension of a thyroid lobe, and then decides to include the measurement in the report, they can point to the measurement in the Results Window. This will launch another window with calculations to choose from. Point to the desired calculation and the system will enter the data into the calculations package. |



| | |
|---|--|
| <p>Calc Button</p>  | <p>Most presets have specific pre-defined measurements, calculations and reports associated with them. These are accessed by pressing the Calc button on a frozen/cine image.</p> <p>Note: Once the Calc button has been pressed, alternate calculation 'libraries' can be accessed using OLED assigned to toggle libraries without changing Exam Presets.</p> |
| <p>Undo Button</p>  | <p>The Undo button will generally undo the last measurement action.</p> <ul style="list-style-type: none"> It can be used to remove a caliper that had been accidentally invoked. It can be used to remove calipers that are part of a set (such as volume), removing the calipers in the opposite order they were placed (last placed will be first removed). |
| <p>Set Buttons</p>  | <p>The Set buttons will launch and finalize the currently active measurement.</p> <ul style="list-style-type: none"> For example, within the calc package they will launch the first caliper in the series and enter the current measurement into the report. Within generic measurements they will lock the current measurement in place so that an additional measurement can be invoked. |
| <p>Select Button</p>  | <p>The Select button will provide 'fine tuning' of caliper placement.</p> <ul style="list-style-type: none"> For example, if a 'set' of calipers is active while in Calcs or Caliper, pressing the Select button will 'switch' trackball control between the two calipers. |

The system displays and updates measurement and calculations results in the **Results Window**. Point to and press Set to move the Results Window around the imaging area as needed.



Help information concerning measurement and calculations is displayed in the **Help Bar** at the bottom of the screen.

AP:[Set] End point:[Select] Switch

Caliper (Generic measurements not entered in report) Options

B-Mode (2D)

The following 2D measurement tools are available in 2D or Color Doppler imaging modes by pressing the Caliper key. Additional tools may be available depending on exam type and preset.

Measurement Tools to be displayed in the menu area can be selected (by exam mode) in **Setup/Calcs**

| Measurement Tools Available using the | Function |
|---------------------------------------|--|
| Distance | Measures the distance between two points of interest. |
| Depth | Measures the distance between the probe surface and the caliper point placed on the image. |
| Depth + Distance | Measures the distance between the probe surface and the first caliper. Measures the distance between the first caliper and the second caliper. Displays both values. |
| Angle | Measures the angle between two intersecting planes. |
| Trace | Measures the area and perimeter of a closed region. |
| Ellipse | Measures the area, perimeter, minimum diameter, and maximum diameters of a closed region. |
| % Stenosis Diameter or Area | Measures two diameters (or two areas) and calculates the % stenosis. |
| Volume | Measures the volume of a target based on 3 diameters. |
| Curved Length | Measures the length of a curve. |

| | |
|----------------------|---|
| Distance (A/B) Ratio | Measures the lengths of any two lines and calculates the ratio. |
| Area Ratio | Measures the areas of any two regions and calculates the ratio. |

| Measurement Tools Available using the Caliper Button | Function |
|--|---|
| Volume (Bullet, Simpson) | Measures the volume of cardiac chambers |

M-Mode

The following M Mode measurement tools are available by pressing the Caliper key. Tools to be displayed in the menu area can be selected (by exam mode) in **Setup/Calcs**. Additional tools may be available by exam type.

| Measurement Tools | Function |
|-------------------|--|
| Depth | Measures the distance between the probe surface and the probing point along the ultrasound beam. |
| Distance | Measures the vertical distance between two points. |
| Time | Measures the time interval between any two points. |
| Slope | Measures the distance and time between two points and calculates the slope. |
| HR | Measures the time of n (n≤8) cardiac cycles and calculates the heart rate in M mode images. |

PW/CW/TDI Doppler

The following Doppler measurement tools are available on PW/CW/TDI mode images by pressing the Caliper key. Doppler measurements can be performed by manually tracing or placing calipers, or Auto-Trace. Measurement tools to be displayed in the menu area can be selected (by exam mode) in **Setup/Calcs**. Content may vary by Exam Type.

| Measurement Tools | Function |
|---------------------------------|--|
| Trace | On PW mode images, one or several Doppler waveforms are traced to obtain the velocity, PS, ED, PS/ED, RI, AT, HR, TAMX, PG, PI. Etc. Measurement methods available include 2PT (two points), manual, spline and auto. |
| Velocity or Velocity Max | On Doppler mode images, velocity of a point on the Doppler spectrum waveform are measured. |
| Velocity Pairs | On Doppler mode images, velocity of a pair of waveforms is measured. |
| RI | Measures the Resistive Index of a waveform |
| PI | Measures the Pulsatility Index of a waveform |
| Acceleration, Acceleration Time | The velocity and time interval between two points are measured to calculate the speed difference and acceleration or deceleration. |
| Time | Measures the time interval between any two points. |

| A/B | Velocity of two peaks on the Doppler spectrum are measured to calculate the ratio A/B. |
|---------------------------------|--|
| HR | N intervals (n≤8) are measured to calculate a PW mode derived HR value in Beats Per Minute (BPM). |
| Measurement | Function |
| PSV | Measures the Peak Systolic Velocity of a waveform; the highest velocity of red blood cells crossing the sample volume. |
| EDV | Measures the End Diastolic Velocity of a waveform; the blood velocity at the end of the cardiac cycle. |
| PS/ED | Velocity and PG between two peaks on the Doppler spectrum are measured to calculate the PS/ED (peak systolic/end diastolic). |
| Diast1/Diast2 , PSV1/PSV2 | Velocity between two points on the Doppler spectrum are measured to calculate Ratio |
| VTI | Measures Velocity Time Integral of a Doppler Waveform |
| Peak Gradient | Measures the peak pressure gradient of the traced Doppler waveform. |
| Mean Gradient | Measures the mean pressure gradient of the traced Doppler waveform. |
| ½ time | Measure pressure half time of a Doppler waveform. |
| Slope | Measures the distance and time between two points and calculates the slope. |
| Volume Flow | Measures the blood flow through a vascular cross section per unit time. |
| MV Slope | Under the cardiac exam mode, you can select the MV Slope to measure the MV E Vel, MV E Grad, MV Area (PHT), MV DecT, and MV PHT items. |

Auto-Trace

There are multiple ways of invoking Auto-Trace. Any of the following may be used:

- A function key can be configured for Auto-Trace in **Setup / Keys**.
- Double-clicking on the **Caliper** button while Doppler is active.
- Selecting Auto-Trace from the **Softkey OLED** controls (while Auto-Trace is active, a Volume Flow OLED will also be available for easy access).

Once Auto-Trace is active the onscreen results box will automatically update data based on the spectral display. Users may select which measurements are included in the results box by exam type using **Setup / System / Application / Auto-Trace**

The interval size, and envelope type can be configured in **Setup / System / Application / Auto-Trace** or by adjusting the OLEDs assigned to the functions when Auto-Trace is active.

Calculations Options

The following categories of calculations are launched with Presets. Users may select other categories to measure during the exam using the Softkey OLED controls or onscreen Menu lists.

- Abdomen - used for measuring abdominal organs (liver, gall bladder, pancreas and kidney, etc.) and large abdominal vessels.

- OB - used for measuring fetal growth indices (including EFW) as well as GA and EDD calculations. The fetus can be evaluated through growth graph analysis and the fetal biophysical profile.
- Cardiac - used for left ventricle function measurements and measuring chambers, main artery and vein parameters, etc.
- Gynecology - used for the uterus, ovary and follicles, etc.
- Urology – used for the prostate, bladder and kidneys
- Small Part - used for small parts such as the thyroid, scrotum or breast.
- Pediatrics - used for hip joint measurement, and abdominal and pelvic organs
- Vascular - used for carotid, cerebral, transcranial, upper and lower extremities vessels, etc.

Smart OB Measurement

There is an auto measurement method for commonly-used OB measurement items (HC/BPD/OFD/AC/FL/NT).

The system can fix the caliper of Smart OB measurements automatically according to the feature of the 2D or 3D/4D scanning image. Caliper position may be fine-tuned after system has provided data, according to the actual situation.

■ Configuration

Smart OB is a purchased license. Please confirm Smart OB has been configured before use.

Operations are as follows:

1. Press <Service> key to enter User Diagnostics Panel interface.
2. Click [License Info] to enter License Information interface, and check if Smart OB is displayed on Features list.

Once configured, Smart OB is measured by entering presets listed under the OB exam type. Smart OB is available on the convex transducer under OB exam mode.

■ Basic Procedures for Smart OB measurements

1. Press <New patient> key to start a new patient; input LMP information.
2. Select the proper probe and exam type. Perform 2D or 3D/4D scanning mode to locate the appropriate region.
3. Press <Calc> key to enter measurement mode, the image will be frozen.
4. Select Smart OB (HC/BPD/OFD/AC/FL/NT) measurements, the system fixes the measure caliper automatically. Caliper position may be modified after data is displayed according to the actual situation.
5. After Smart OB measurements are done, the result window will display the related data at the lower right corner of the screen.
6. Add annotation or text to the image if necessary.
7. Save the single-frame image.
8. Press <Calc> key to exit the measure mode.

Auto IMT

Function: IMT (Intima-Media Thickness) measures the distance between LI (Lumen-Intima) and MA (Media-Adventia).

The IMT calculation is available at 4 positions: CCA (Common Carotid Artery), ICA (Internal Carotid Artery), ECA (External Carotid Artery) and Bulb

■ Configuration

Auto IMT is a purchased license. Please confirm Auto IMT has been configured before use. Operations are as follows:

1. Press <Service> key to enter User Diagnostics Panel interface.
2. Click [License Info] to enter License Information interface, and check if Auto IMT is displayed on Features list.

Once configured, Auto IMT is measured by entering the Carotid exam preset. Auto IMT is available on the linear transducer under Carotid exam mode.

■ Basic Procedures for Auto IMT measurements

1. Press <New patient> key to start a new patient.
2. Select the proper probe and exam preset. Scan vessel
3. Press <Calc> key to enter measurement mode, the image will be frozen.
4. Select the side (Left/Right), angle and vessel wall (Near/Far).
5. Select an item such as [CCA/Bulb/ICA/ECA IMT], and the ROI box displays on the screen.

It appears as  when Near is selected

It appears as  when Far is selected

6. Move the ROI box to the desired position, then press <Set>. Two auto trace lines appear in the box.
7. Press <Set> outside the box to confirm the adjustment result after the manual trace is complete. The results are recorded in the IMT report.

Note:

- Size of the ROI can be adjusted by clicking on one border of the ROI, which will allow the trackball to then size the box.
- Trace can be adjusted after data is displayed by clicking on a segment of trace that is to be adjusted. Onscreen cursor will turn into a finger at which time the user can use the trackball to drag the trace to the desired position.

Smart NT (Nuchal Translucency)

If data onscreen needs to be adjusted, confirm the target profile manually and adjust the result. Select NT measurement and choose [Auto] method.

AutoEF

Function: Measure the diastole and systole planes automatically.

■ Configuration

AutoEF is a purchased license. Please confirm AutoEF has been configured before use. Operations are as follows:

1. Press <Service> key to enter User Diagnostics Panel interface.
2. Click [License Info] to enter License Information interface, and check if AutoEF is displayed on Features list.

Once configured, AutoEF is measured by entering Cardiac exam type.

■ Basic Procedures for AutoEF measurements

1. Press <New patient> key to start a new patient.
2. Select the proper probe and exam preset. Scan cardiac image.

- Acquire an apical two-chamber view to measure the EDV(A2C) and ESV(A2C) and/or
 - Acquire an apical four-chamber view to measure the EDV (A4C) and ESV (A4C).
3. Press Freeze.
 4. Press <Calc> key to enter measurement mode and select Auto EF or press the programmable key assigned to Auto EF.
 5. System will pause and then display traces on the ED and ES frames.
 - a) OLEDs are available to toggle between Systolic and Diastolic Frame by pressing the OLED. Turn the dial to adjust the frame to be used for calculation.
 - b) Traces can be modified by pointing to the segment of trace to be adjusted. Caliper points will become highlighted at which time the trackball can be used to drag the trace to the desired position.
 6. When data is acceptable, press ACCEPT OLED and data will be stored to the report.
 7. If the height and weight have already been entered, the SV, EF, SI, EDV Index and ESV Index are calculated. ECG obtains the HR automatically. If ECG is not connected, HR can be selected on the menu.

Note: Auto EF can also be launched using a programmable key when the image is live. When desired, press the Auto EF programmable key. The image will freeze and the above behavior will follow.

Measurement Accuracy

Table 1 2D image measurements

| Parameter | Range | Error |
|---|-------------|-------------------|
| Distance | Full Screen | Within $\pm 3\%$ |
| Area | Full Screen | Within $\pm 7\%$ |
| Circ | Full Screen | Within $\pm 10\%$ |
| Angle | Full Screen | Within $\pm 3\%$ |
| Volume | Full Screen | Within $\pm 10\%$ |
| iScape (for linear, and wide convex probes) | Full Screen | Within $\pm 5\%$ |

Table 2 3D/4D image measurements

| Parameter | Range | Error |
|-----------|---------------|---|
| Distance | Section A/B/C | Within $\pm 5\%$ (not including Smart 3D mode) |
| Area | Section A/B/C | Within $\pm 7\%$ (not including Smart 3D mode) |
| Circ | Section A/B/C | Within $\pm 10\%$ (not including Smart 3D mode) |
| Angle | Section A/B/C | Within $\pm 5\%$ (not including Smart 3D mode) |
| Volume | Section A/B/C | Within $\pm 20\%$ (not including Smart 3D mode) |

Table 3 1D image measurements

| Parameter | Range | Error |
|---------------|--|--|
| Distance | Full Screen | Within $\pm 3\%$ |
| Time | Timeline Display | Within $\pm 2\%$ |
| Heart Rate | Timeline Display | Within $\pm 4\%$ |
| Velocity (PW) | 10-200cm/s (for C4-1, C10-3, C6-2, C9-3, C8-3 3D, E9-3, E9-4, E9-3 3D, L10-5, L8-3, L14-5sp, L14-5w, L20-5, P8-3TEE, P9-3ic, C9-3sp, C6-1, C18-5, P8-3mTEE, L30-8, C12-4lp, P4-1c, and P7-3c probes) | When angle $\leq 60^\circ$, $\leq 5\%$. |
| Velocity (CW) | 10-200cm/s (for C10-3, C4-1, P8-3TEE, P9-3ic, A2CW, A5CW, and P8-3mTEE, P4-1c, and P7-3c probes) | When angle $\leq 60^\circ$, $\leq 5\%$. (not including pencil probe) |

6. Annotations, Arrows, and Body Markers

Annotations

Enter Annotation Text Manually

The annotation function may be invoked by pressing the **Spacebar**, the **Text** key on the keyboard, or the **Annotation** button on the console. The trackball is used to define where onscreen the text will be written. The QWERTY keyboard can be used to type text as desired.

Annotation Softkeys (OLEDs)

While the annotation function is active the **Softkeys (OLEDs)** contain User Defined lists.

- Three Softkey OLEDs support pre-defined lists (the contents of which can be modified using the Setup / Annotation /Define Lists Page). Pre-defined lists contain the following text on default:
 - **Left, Right**
 - **Long, Trans, Sag, Cor**
 - **Dist, Prox, Mid**
- Three additional OLED keys support lists that can be customized in Setup / Annotation.
- Each category/preset combination can, therefore, have 6 lists attached to it. The lists can be defined under the Setup / Annotation /Define Lists option.
- Softkey OLEDs support changing the 'Libraries' of annotations that are displayed as well as easy access to delete text, delete last, delete word, Home Set and Home.
- Pressing, toggling or turning OLED controls will briefly display the entire content of the list onscreen so users can quickly and easily find the text needed, even if out of order.



Editing Text:

- By default, annotation is in overwrite mode: text to the right of the cursor is replaced as you type. Pressing the Set keys switches to insert mode: text to the right of the cursor is shifted to the right as you type. Pressing the Set key again, switches back to overwrite mode.
- Annotation Font size onscreen can be changed by using the softkey OLED **Font Size**.

- Text can be temporarily removed from the screen by pressing the softkey OLED **Display Text** and can be replaced onscreen by pressing **Display Text** again.

Moving Text:

- A block of text can be moved around the screen by double-clicking the **Set** key while the edit cursor is in that block of text. Alternately, pressing the **Select** key will allow users to move that block of text.
- **Set Home** and **Home** functions are available on the keyboard or the softkey OLED.

Deleting Text:

- To delete the last word you typed, press the **Del Text/Del Word** key or use the Softkey OLED designated with the 'delete word' function.
- To delete all text displayed, press **Shift + Del Text/Del Word** or use the Softkey OLED designated with the 'delete all' function.
- To delete a specific word displayed, press the OLED designated for **Del Word**.
- Using the keyboard backspace key while the cursor is in text will remove one letter at a time.

Arrows

Arrows can be activated by pressing the Arrow key on the keyboard or by pressing the Softkey assigned to **Arrow** while Annotation or Body Marker is active.

Moving Arrows:

- Once active, the trackball will move the arrow around the screen (direction and location).
- Softkey OLED controls will be available to rotate arrows, change arrow size, and delete arrows.

Adding arrows:

- Arrows can be added by pressing the Set Key while Arrow is active
- Softkey OLED controls will be available while Annotation or Body Marker are active.

Deleting arrows:

- Arrows can be deleted by pointing to the arrow to be deleted and pressing the 'Delete Arrow' Sofkey OLED.
- Pressing the UNDO button while Arrow is active will delete arrow in a last added/first deleted manner.

Body Markers

Body Markers can be activated and deactivated by pressing the Body Marker key on the keyboard or by pressing the Softkey assigned to **Body Marker** while Annotation or Arrow is active.

Moving Body Markers:

- Once active, pointing to the body marker graphic and pressing **Select** will move the Body Marker around the screen. Pressing the **Select** Key again will set the position.

Moving transducer designator on Body Marker:

- When Body Marker is activated, the transducer is attached to the trackball, so moving the trackball will move the location of the transducer designator within the Body Marker.
- Rotate the transducer by:
 - Turning the Probe Rotate OLED
 - Scrolling the trackball to the left for counterclockwise rotation; scrolling the trackball to the right for clockwise rotation.

Changing Body Marker Library:

- Sofkey OLEDs are used to change the Body Marker Library (Body Marker selections will change).

7. Archiving, Review and Management

Image Print and Storage



There are three keys that can be configured to either print or store: **Store 1**, **Store 2**, and **Print**. These can be configured to send still images, clips, and screen shots to an optional printer, hard drive, USB device, DICOM networked device, or FTP site.

In addition, these keys can be assigned to store Total Recall (TRI) and 3D Volume Data by checking the desired box. Once the box is checked, pressing the designated store or print key will store 'Total Recall' (pre- scan converted data) or 3D Data.

These keys can be configured in **Setup/Keys/Image Store-Print Buttons**. Any of these keys can be configured for any subset of store/print destinations.

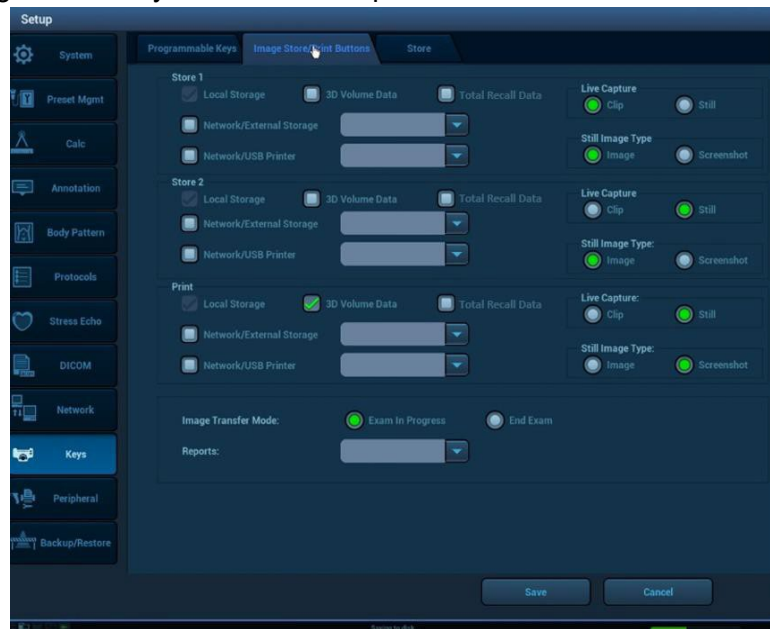

Figure 7-1: Setup; Keys; Image Store/Print Buttons





To avoid data loss, always use back up storage/archive devices. Do not delete patient data and images from the scanner until the backup has been completed and the ability to read transferred details is verified.

Image Review Options

Images can be reviewed during an active exam or after an exam has been ended.

- **Onscreen Thumbnails:** Point to and click on onscreen thumbnails to view, edit, send to media, Tag, or delete the selected image or clip.
- **Current Exam:** Press Keyboard control to display images and clips from the currently

active exam.

- **Archive:** Press Keyboard control to display a list of previous exams. By default this shows the list of exams present on the internal hard drive.
 - A drop-down menu on this screen (Data Source) will switch to a list from media inserted in the USB port.
- While a study is highlighted (from Archive or Current Exam), pointing to a thumbnail along the bottom displays the following tools, which indicate that individual images can be deleted, transferred to media, or Tagged etc. independent of the entire collection.
 - Delete  , Send To  , and Tag  options
- **New Patient:** This displays the patient demographic screen for new patients. This screen also
 - Has a **Restart** button to restart previously completed exams.
 - Has a **Pause** button to pause the exam.
 - Has a **Resume** button to resume a previously paused exam.
 - Has an **Archive** button which provides an alternate means of accessing the Archive.

Total Recall (TRI) Options

The Total Recall Imaging (TRI) feature allows the user to store pre-scan converted ultrasound data; review/manipulate that data during an active exam or after an exam has been ended; and re-save the manipulated data.

- The onscreen thumbnail shall include an ICON reflecting the availability of Total Recall data as indicated by TRI.
- When the Total Recall data has been loaded, the ICON onscreen will be updated with a checkmark.



Total Recall Review Methods: If Total Recall Data has been stored with an image or clip, the user can:

- **Automatically Load Total Recall Data:** Select the option 'automatically load Total Recall Data when images selected in Review or Archive' on the **Setup/ General** tab.
 - When this option has been selected, Total Recall data will automatically be loaded when images or clips are selected for Review
 - An OLED will then become available to 'Exit TRI' or 'Delete TRI'.

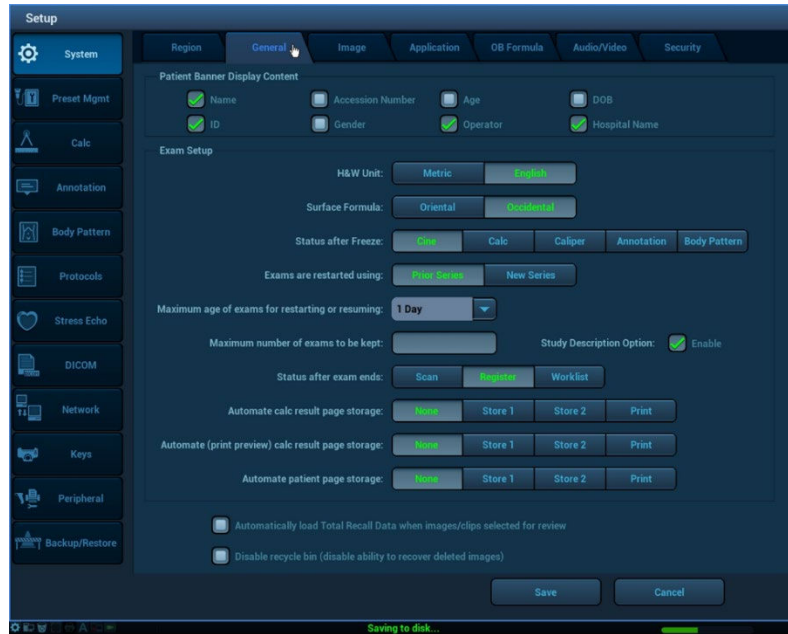

Figure 7-2: Setup; General; Auto Launch Total Recall Imaging

- **Selectively Load Total Recall Data:** No Setup is necessary.
 - Total Recall data will NOT automatically be loaded when an image or clip is selected for Review
 - An OLED will become available with options to 'Load TRI' or 'Delete TRI' data if an image with TRI data is selected for Review.
 - Once 'Load TRI' has been selected, OLED options will change to 'Exit TRI' or 'Delete TRI'.

When an image or clip is selected and TRI Data is loaded (during Review or from Archive), Total Recall becomes the Priority state of the system with the following OLED controls available:

| Total Recall Control | Description/Use |
|----------------------|---|
| Exit Review | Return to live imaging. |
| Trim | Define the start and end point of a clip to re-save. |
| Tag | Mark an image or clip to allow exporting or sending selective images. |
| Format | Toggle between multi image and full image with thumbnails format of Review. |

| Total Recall Control | Description/Use |
|----------------------|--|
| Delete | Delete an image or clip (Traditional as well as Total Recall Data) |

| | |
|-----------------------------|---|
| TRI Load/Delete/Exit | <ul style="list-style-type: none"> • If Total Recall Data is automatically loaded, turn the dial to toggle between Exit TRI and Delete TRI, then press the dial to select the action. • If Total Recall Data is not automatically loaded, turn the dial and then press the dial to Load TRI or Delete TRI <p>Note: Deleting or Exiting TRI will ONLY affect the TRI Data. Traditional image and clip information will be preserved.</p> <p>Note 2: Navigating away from an image or clip with TRI loaded will also 'Exit TRI' if the next image or clip does not have TRI data available.</p> |
| Cine Select | <p>Push to toggle between Chapter or Frame</p> <ul style="list-style-type: none"> • When Chapter is selected, turn dial to advance or go back chapter at a time • When Frame is selected, turn dial to advance or go back frame by frame within a chapter |
| Play/Pause | <p>Toggle between Play and Pause</p> <ul style="list-style-type: none"> • When clip is paused, turn dial to advance or go back frame by frame • When clip is playing, turn dial to increase or decrease the speed of playback |

Once an image or clip has been selected and TRI data becomes available, users have access to image optimization controls.

The following manipulations are available when an image/clip with TRI data is loaded. The Priority key can be used to gain access to modes that are 'on' but may not have Priority:

- Stripping modes if multiple modes are active and ability to manipulate image settings of each mode (ex. If Color and PW Doppler are 'on' users can press D or C Knob to turn off modes).
- Image optimization of 2D, Color, M-Mode, and Spectral Doppler such as baseline, sweep speed, map, TGC/Gain, DR, scale when in CW Doppler, display format, etc.
- Trimming clips and resaving
- Editing annotations
- Editing calculations including the addition of auto trace and volume flow.

Note: Archived Total Recall Data may not be compatible between system software releases

Image Management Options

Exams and associated images and clips, can be managed in a number of ways.

From the Archive page, upon selecting an exam, a drop down menu will list options including but not limited to:

- **Review Images:** Selecting this option loads the images for review
- **Patient Info:** System is directed back to the Patient Data page
- **Review Report:** System is directed to the Report Page for highlighted exam
- **Delete Exam :** Selecting this option deletes the highlighted exam
- **Backup Exam:** Selecting this option copies the highlighted exam to the selected

external media. Data can be restored to the ultrasound system if this method of copying is selected.

- **Restore Exam:** Exams that are backed up to external media can be restored to the ultrasound system using this option. Select the exam from the list of exams on the external media.
- **Send Exam:** Selecting this option allows users to send the exam to a number of targets (note: these exams CANNOT be restored to the ultrasound machine.).
 - **Targets include:** USB device, CD/DVD, DICOM Server (PACS), DICOM Media, Printers, FTP.
- **Restart Exam:** Selecting this option allows users to Restart (and add/delete images) exams that have been ended.
- **Resume Exam:** Selecting this option allows users to resume exams that have been paused.
- **Delete TRI Data:** Selecting this option allows a user to delete all TRI data associated with images or clips in the exam highlighted. All non-TRI data will be preserved.

Image Gallery

The **Image Gallery** function allows users to quickly and easily select and combine images and clips from multiple Exams into one anonymized collection.

- Collections can be used for teaching, credentialing, presentations, marketing etc.
- The Image Gallery Function can be enabled in the **Service** menu

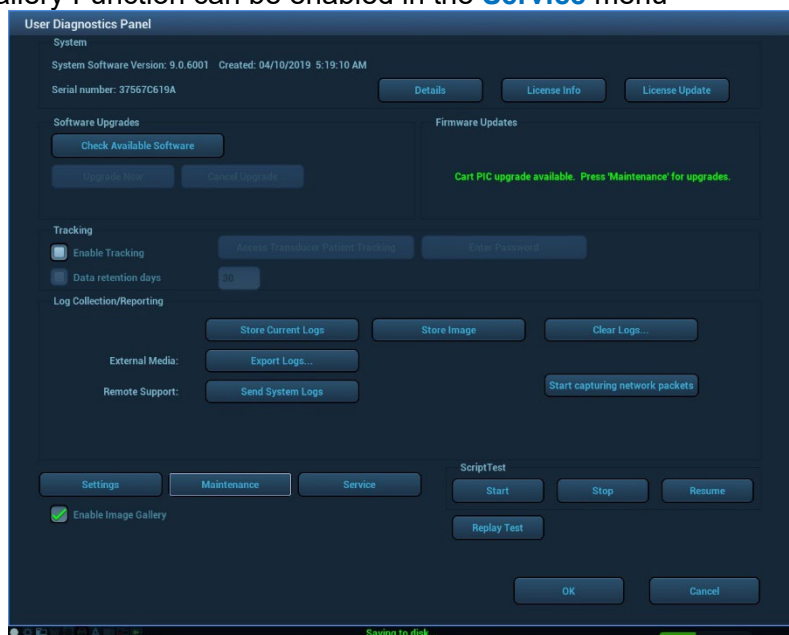

- To create or add images to an Image Gallery, select desired images from **Review** and click **Send to Image Gallery** onscreen button.
 - Select
 - Create a new Image Gallery or
 - Send to existing Image Gallery

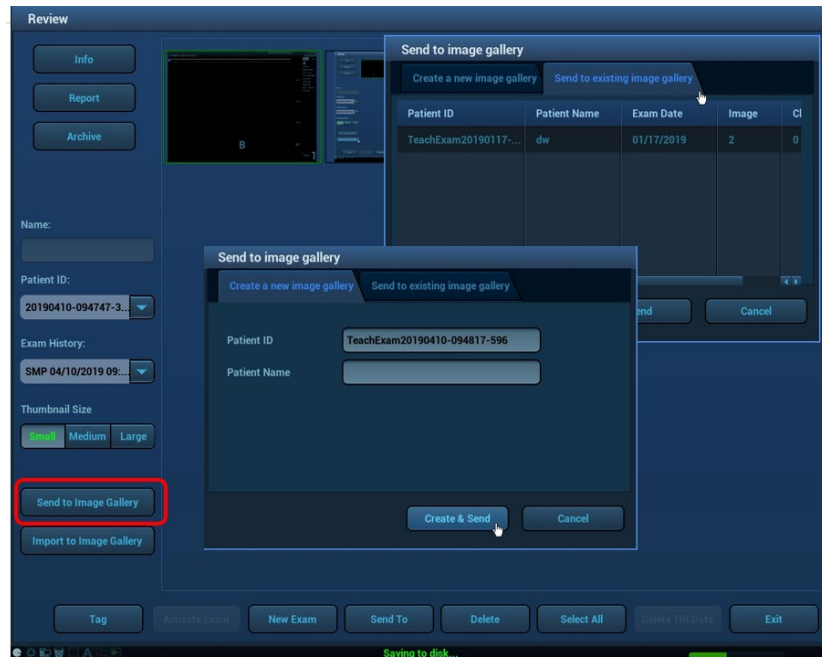

- Images can be imported from a USB device and added to existing collections using the **Import to Image Gallery** onscreen button.
- From the **Archive** Page
 - Check **Image Gallery** box to display and sort Image Gallery collections only for easy access
 - Image Gallery collections can be selected and then included in Slideshows on the ultrasound machine by checking the **SlideShow Play** onscreen button.

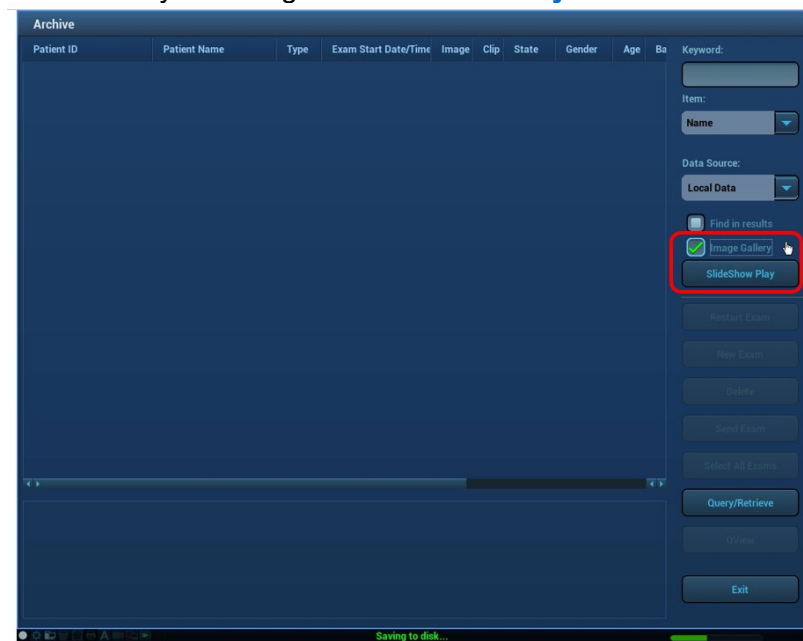

DICOM Connectivity

When activated and configured, DICOM connectivity enables the ultrasound system to exchange data – including ultrasound images and associated patient and exam data – with

DICOM-compliant archive devices, output devices and worklist applications over an institution's network. Each such device must be configured. Refer to *DICOM Conformance Statement*.

From the Archive page:

- **Send Exam:** Provides a means to transfer Exams to USB, CD/DVD, DICOM Server (PACS), DICOM Media (External media with DICOM Dir included), Printers and FTP sites.

Wireless (Option)

Mindray supports wireless connectivity using the Quatech Airborne Direct Wireless Ethernet Bridge. This is intended as a workflow enhancement to enable remote viewing and archival of data when a physical Ethernet connection is not available. It should not be relied upon however when time-critical diagnoses are required as multiple environmental factors may affect wireless connectivity performance.

The Quatech Airborne Direct Wireless Ethernet Bridge supports Wi-Fi 802.11b/g wireless standards and connects to the system through a 10-Base-T network interface. This device supports WEP (64/128bit) and WPA encryption standards, and LEAP for network authentication (LEAP required the Quatech device to be configured with a static 128 bit key; this is known as "migration mode" and is not recommended for long-term use due to the static WEP key requirement).

Before using it with the ultrasound system, the Quatech Airborne Direct device must be preconfigured for the user's networking environment – SSID, channel, encryption, and correct addressing scheme (DHCP/ static).

When power is applied to a correctly configured Quatech Airborne Direct device that is connected to the Ethernet port on the ultrasound system, it will require 30 to 60 seconds to detect and then to associated with the user's wireless network. Once a wireless network connection is established, the ultrasound system will reflect the connection state by showing the network icon in an uncrossed state.

8. Advanced Features and Options

Contrast Enhanced Ultrasound (CEUS)

Contrast imaging is a separately purchased option. It is a detection mode specifically designed to enhance ultrasound contrast agent signals. Similar to 2D (B-Mode), a suite of additional optimization controls are provided to further enhance contrast agent imaging performance.

The contrast imaging is used in conjunction with ultrasound contrast agents to enhance imaging of blood flow and microcirculation. Some injected contrast agents re-emit incident acoustic energy at a harmonic frequency much more efficiently than the surrounding tissue. Some agents re-emit non-linear, or subharmonic signals. Blood containing the contrast agent stands out brightly against a dark background of normal non-enhanced tissue.

The C4-1, C10-3, P4-1c, P8-3TEE, P9-3ic, P8-3mTEE, P7-3c probes support the CEUS (Contrast agent for LVO); The C4-1, C6-2, C9-3, C10-3, C8-3 3D, P4-1c, L10-5, L8-3, L14-5sp, L14-5w, L20-5, C9-3sp, C6-1, C18-5, P7-3c, C12-4lp probes support the CEUS (Contrast agent for Liver)

- | | |
|-----------------|---|
| Caution: | <ol style="list-style-type: none">1. Set MI index according to the instructions in the contrast agent user manual.2. Read contrast agent user manual carefully before using contrast function. |
|-----------------|---|

- | | |
|--------------|--|
| NOTE: | <ol style="list-style-type: none">1. Optimize the image before injecting the contrast agent into the patient to avoid affecting image consistency, as the effective time is limited and varies by contrast agent.2. Users should comply with relevant local regulations in terms of approved indications for use. |
|--------------|--|

NOTE: The z.one pro Ultrasound System is designed for compatibility with commercially available Ultrasound contrast agents. Because the availability of these agents is subject to government regulation and approval, product features intended for use with the agents may not be commercially marketed nor made available before the contrast agent is cleared for use. Contrast-related product features are enabled only on system for delivery to an authorized county or region of use.



Read and follow contrast agent instructions provided by the manufacturer.

Basic Contrast Enhanced Ultrasound (CEUS) Operation

Contrast must be configured to a programmable function key before use. These keys can be configured in **Setup / Keys**.

1. Press **Setup / Keys**.

2. Click to select CEUS to the desired key.
3. Click Save to complete the setting.

Once configured, CEUS is invoked by pressing the configured function key.

General Imaging - By default the image presents as a dual display, with the contrast image on the left and a reference image on the right (OLED control available to have contrast image on right and reference image on the left). Pressing the **Dual** key will toggle to a display showing the contrast image overlaid on the reference B-mode image (“mixed transparency”).

Cardiac Imaging - Left Ventricular Opacification (LVO) / Endocardial Border Definition (EBD): By default the image goes to a single contrast image display.

Basic Procedures for Contrast Enhanced Ultrasound (CEUS) Imaging in the abdomen

To perform successful contrast imaging, you should start with an optimized 2D image and have the target region in mind.

1. Select an appropriate probe, and perform 2D imaging to obtain the target image, and then maintain position of the probe.
2. Press the configured key to enter the CEUS imaging mode.
3. Adjust the acoustic power to obtain a good image. Observe the tissue image to fine tune the image.
4. Inject the contrast agent, and press [Stopwatch] to start the contrast timing. When the timer begins to work, the time will be displayed on the upper left corner of the screen.
5. Observe the image, press the **Store** (usually “Store 1” and “Store 2”) key to save the multi- frame images. Press **Freeze** to end the live capture.
6. At the end of contrast imaging, press [Stopwatch] to exit the timing function. Repeat procedures 3-5 if necessary.

If necessary, press the [Flash] OLED to destroy the micro-bubbles left by the last contrast imaging injection; or to observe the reinfusion effect while using a continuous injection rather than a bolus injection.

7. Exit contrast imaging. Press **B** button to return to B mode.



Figure 8-1: CEUS ABD imaging

While in Contrast (CEUS), the softkey OLEDs display options specific to contrast imaging.

| Contrast Control | Description/Use |
|--|--|
| Softkeys OLED controls | While CEUS is active, the Softkeys at the back of the console contain the optimization and navigation controls specific to CEUS Imaging and affecting the CEUS image only. Pressing OLED #1 toggles through multiple pages of controls. |
| CEUS Submodes | Similar in concept to Color Doppler (CD) Submodes, this control allows user to ONLY change the CEUS mode without resetting the preset or making any changes to other controls. Numeric value displayed onscreen is the 'received' frequency. NF: Nonlinear Fundamental H: Second Harmonic SUB: Sub Harmonic Turn dial to toggle to different selections. |
| CEUS Agent | Multi-parameter, Contrast Agent specific settings to make optimization easier and more efficient. |
| Resolution | Three selections provide a balance between frame rate and detail resolution. Only reference image is affected. HQ: High Quality Gen: General Fast: High Frame Rate |
| Stopwatch Start/Stop, Reset/Phase | Press to start or stop the stopwatch. When the stopwatch is in the stopped state the adjacent softkey will reset the timer to zero. When the stopwatch is in the running state the adjacent softkey has a "phase" function to support multiple phases of contrast. Up to 4 phases can be displayed with this control |
| Frame Rate | Reduces the imaging frame rate, allowing for increased contrast agent concentration between imaging frames. Frame rates down to 0.1Hz are supported. |
| Mix | On/Off control to display a mixed transparency of the contrast image overlaid on the reference B-mode image. |
| Power | Controls the acoustic output power of the contrast image. Raising or lowering the power will affect contrast agent destruction and therefore contrast agent effect. |
| Flash | Temporarily increases the delivered power, rupturing the contrast bubbles thereby clearing the contrast effect (not available in cardiac). Turning the dial adjusts the length of the flash and pressing the dial initiates the flash. |
| Flash Link | This control links the Flash and Clip Store functions. When set to ON, if the Flash OLED is pressed, the system will begin by storing the flash frame followed immediately by the clip duration set on the Clip Type OLED in the same clip. When set to OFF, the Flash OLED will behave independently from the Store function. If the Flash OLED is pressed, the system will increase power to the image for the predetermined time set on the Flash OLED. Store must be manually pressed. |

| | |
|---|---|
| Play/Pause | <p>When the image is frozen, this control provides a means to toggle between playing and pausing the contents of the Cine Buffer.</p> <p>When Paused, the same dial navigates frame by frame.</p> <p>When the image is playing, this control increases and/or decreases the playback speed.</p> |
| Trim | <p>Provides easy access to the Trim Function.</p> <p>Press this OLED and then use the Left and Right Set keys to establish the beginning and ending points of the desired clip.</p> |
| Acoustic Power | <p>When entering CEUS, this control allows user to adjust the Mechanical Index (MI) to ensure contrast bubbles are preserved or disrupted as necessary.</p> |
| Sequence Select | <p>Use this OLED to select which predefined Sequence will be started after the Sequence Start OLED is pressed.</p> |
| Sequence Start/Pause/Resume | <p>During a sequence, the system automatically adjusts multiple parameters including but not limited to number of steps, duration of steps, MI during the step, Frequency used during a step and Frame Rate applied, and stores the Sequence</p> <p>When completed.</p> <ul style="list-style-type: none"> • Press Up on this toggle to Start a Sequence. • System automatically ends the Sequence when the predetermined steps have been Completed. • Press Up on the toggle again before the Sequence has been completed, and the Sequence will pause. • While the Sequence is paused, pressing Up again on the toggle resumes the Sequence. • Press Down on the toggle at any time during the Sequence, and the Sequence will be ended. |
| Peak Hold | <p>Accessed via the Clip A/Peak Hold/Clip B OLED</p> <p>When selected, pressing the configured Store or Print key shall acquire a Peak Hold clip.</p> |
| L/R or R/L Image Swap | <p>Press this control to switch the display between CEUS image on left and reference image on right to CEUS image on right to reference image on the left</p> |
| <p>Frequency</p>  | <p>While CEUS Is active, pressing the Frequency button will change the frequency of the CEUS image.</p> |

Elastography



CAUTION:

It is provided for reference, not for confirming a diagnosis.

Strain Elastography

Strain Elastography is a separately purchased option. Elastography must be configured to a programmable function before use. These keys can be configured in Setup/Keys.

Once configured, elastography is invoked by pressing the configured function key. By default the image goes to a dual display, with the elastography image on the left and a reference image on the right. Pressing the **Dual** key will toggle to a display only showing the elastography image.

Elastography is available for the following transducers: L8-3, L10-5, L14-5w, L14-5sp, L20-5.

Elastography supports three types of strain acquisition. The softkey OLEDs can be used to choose between these:

- Relative (normalized) strain: This generally has similar sensitivity to hard and soft tissue.
- Absolute strain: Strain is displayed without normalization.
- Cross-correlation: This assesses the quality of the acquisition by comparing frame-to-frame correlations.

While in Elastography dual display, generic measurements can be done on either image. A measurement performed over the strain image will also display on the reference B-mode image.

ARFI (Acoustic Radiation Force Impulse Imaging)

■ Configuration

ARFI (Acoustic Radiation Force Impulse Imaging) is a separately purchased option. ARFI must be configured on a programmable function before use. These keys can be configured in **Setup/Keys**. Operations are as follows:

1. Press **Setup / Keys**.
2. Click to select ARFI to the desired key.
3. Click Save to complete the setting.

Once configured, ARFI is invoked by pressing the configured function key.

ARFI is available on the C4-1 transducer using a preset from the Abdominal Exam Category

● Basic Procedures for ARFI Imaging

1. Select the proper probe and exam preset. Begin scanning in 2D to locate the desired region.
2. Press the configured key (such as F2) to enter the ARFI mode.
When ARFI is invoked, the system will display a B Mode image with the ARFI region of interest (ROI) box superimposed and active.
Onscreen Help Bar will provide information on workflow.
3. Move the ROI with the trackball to the desired location
 - a) Avoid vessels, fluid filled structures, and ribs
 - b) Supine or shallow LPO patient position
 - c) Right hand elevated above the head improves intercostal access
 - d) No deep breaths or long breath holds. Shallow breathing is useful while telling patient to suspend breathing mid breath.
 - e) Position ROI deeper than liver capsule, and preferably not deeper than approximately 8cm.
4. Press the **Select** Key to start acquisition.

5. The image will pause momentarily while the ARFI is fired and then return to live imaging.
6. A results box will appear on the screen with the ARFI data, ROI size, ROI position, and Quality Factor in one of three forms as shown below:
 - a) If a site or segment was not selected before pressing **Select** to start ARFI, generic data will be displayed.
 - i. Users can assign this data to a Site or Segment using the OLED controls to be saved in the worksheet
 - ii. Users can store the image and data 'as is' onscreen without saving to the worksheet.
 - b) If a liver segment was selected using the OLED controls before the **Select** key was pressed, the results box will reflect the Segment
 - i. Users can delete the data point by clicking on the onscreen 'x'
 - ii. Users can assign to a different segment
 - iii. Users can 'Enter' the data point in the worksheet by pressing the "Enter Data" OLED.

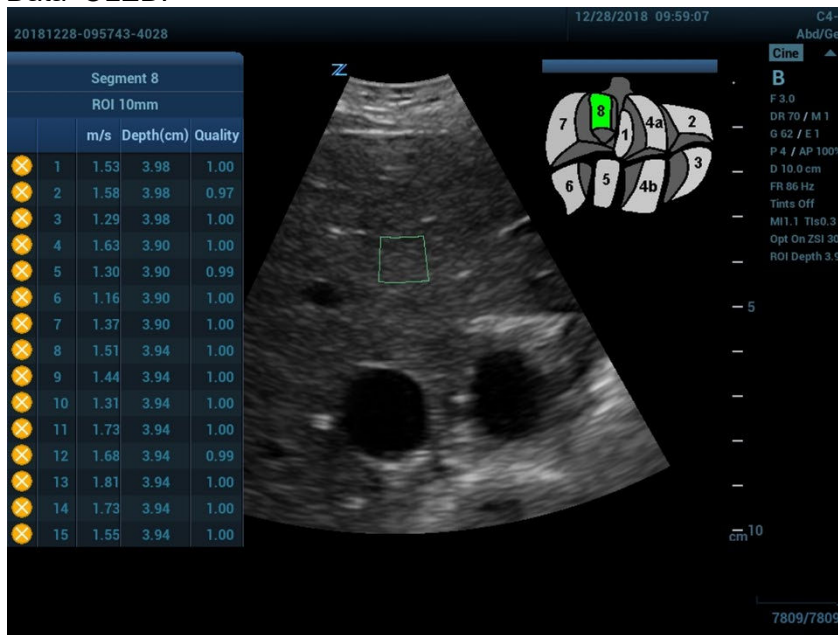

Figure 8-2: ARFI with Liver Segment Selected

- c) If a Site was selected using the OLED controls before **Select** was pressed, the results box will reflect the Site
 - i. Users can delete the data point by clicking on the onscreen 'x'
 - ii. Users can assign to a different Site or Segment
 - iii. Users can 'Enter' the data point in the worksheet by pressing the "Enter Data" OLED.
7. Freeze the image, and replay the image if necessary.
8. Perform other measurements or add annotations to the image if desired.
9. Store the single-frame or multi-frame image if desired.
10. Unfreeze, reposition the ROI if desired, and press the **Select** key to start another ARFI acquisition if desired and repeat the above steps.
 - a) 10 samples per site is typical
11. When all data has been collected, press B knob or the configured key to exit the ARFI mode, and return to B mode imaging.

■ ARFI Mode Image Optimization

While in ARFI, the softkey OLEDs display options specific to ARFI.

| ARFI Control | Description/Use |
|--------------------------|---|
| Liver Segment | Indicates which liver segment is being measured (values: 1, 2, 3, 4a, 4b, 5, 6, 7, 8) Push the dial to turn the onscreen graphic on and off. Turn the dial to change the segment and onscreen graphic display which will automatically label ARFI acquisitions by segment to be stored in the report If this control is off, users can assign ARFI measurement to a generic site or liver segment after it has been acquired as described in calculations section. |
| Site selection | Provides labeling and site selection for assignment into the worksheet when liver segment is not being used. (values= Site 1, Site 2, Site 3, Site 4, Site 5, Site 6)). Turn the dial to change the site and onscreen graphic display which will automatically label ARFI acquisitions by site or be stored in the report If this control is off, users can assign ARFI measurement to a generic site or liver segment after it has been acquired as described in calculations section. |
| Enter Data | If Liver Segment or Site Selection is 'On' and the data onscreen is acceptable, user may press this OLED to enter the data into the ARFI worksheet. |
| Enter All Data | If Liver Segment or Site Selection is 'On' and the data onscreen is acceptable, user may press this OLED to enter all the data onscreen into the ARFI worksheet. |
| Add Site | Add site to results box instead of adding to existing site results to allow multiple sites' results onscreen simultaneously |
| Clear Results | Clears all data onscreen (data already stored in report will remain) |
| m/s, kPa, m/s+kPa | Units of measure: Control switches between kPa and m/s during an active exam. |
| Delete Data | User points to and clicks on 'X' onscreen, which removes a data point. |

■ Measurement

While in ARFI display, generic measurements can be done on the image using the Calc and Caliper buttons, in addition to the ARFI calculations in kPa and m/s.

| | |
|--|--|
|  CAUTION: | <ol style="list-style-type: none"> 1. The values for ARFI velocity and stiffness are relative indices intended only for the purpose of comparison with other measurements performed using the z.one pro. Absolute values for these measurements may vary among different measurement devices. 2. This ARFI function is only used to measure objects larger than 10mm. If the object is smaller than 10mm, this function might not be reliable. |
|--|--|

➤ **ARFI Result Type: kPa, Velocity, or kPa+m/s**

You can measure the ARFI Velocity by following these following steps:

1. Select C4-1 probe under an Abdominal Category preset.
2. Press <ARFI> self-defined key to enter ARFI imaging mode.
3. Adjust the ROI based on the depth and the position.
4. Adjust [Unit Type] parameter to display desired unit/s.

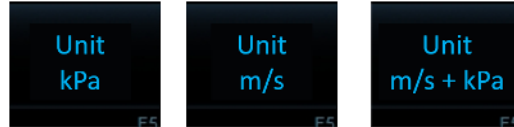

- Press the <Select> key to start an ARFI acquisition. The ARFI Velocity result window will display on the image area.

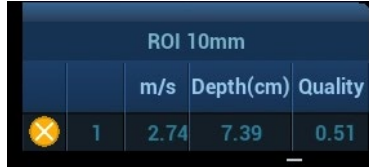

The stiffness is converted into a velocity value by the formula:

$$\text{ARFI velocity} = \sqrt{\frac{2 \cdot \text{stiffness}}{3 \cdot \rho}} = \frac{\sqrt{\text{stiffness}}}{3 \cdot \rho}, \rho = 1.03.$$

The measurement accuracy of the ARFI velocity is about 50%, and the measure repeatability of the ARFI velocity is about 20%

➤ Measurement Bias Information Table

The Measurement Bias Information table display the bias and precision of the ARFI measurement as a function of the object stiffness (Bias/Precision vs. Object Stiffness) and depth (Bias/Precision vs. Depth) for the C4-1 probe.

| Bias/Precision vs Stiffness, depth = 5.0 cm | | |
|---|------------|----------------------|
| Stiffness (kPa) | Bias, kPa | Precision (std), kPa |
| 4 | 5.32 (33%) | 0.40 (10%) |
| 12 | 16.7 (39%) | 0.36 (3%) |
| 25 | 32.5 (30%) | 2.25 (9%) |
| 48 | 60 (25%) | 1.92 (4%) |

| Bias/Precision vs Depth, stiffness = 25 kPa | | |
|---|------------|----------------------|
| Depth (cm) | Bias, kPa | Precision (std), kPa |
| 4.0 | 31.0 (24%) | 3.1 (10%) |
| 5.0 | 31.3 (25%) | 3.1 (10%) |
| 6.0 | 31.8 (27%) | 3.1 (10%) |
| 7.0 | 31.5 (26%) | 3.1 (10%) |

Note:

- ROI size is fixed to 10mm and not adjustable.
- The data in the above tables are gained from measurement on elastomer phantom CIRS 039.

9. 3D & 4D Imaging with Advanced Lighting (Option)

3D/4D imaging is available on z.one pro when used with the C8-3 3D or E9-3 3D transducers. A Programmable Function key must be assigned to 3D in order to invoke 3D/4D imaging. These keys can be configured in [Setup / Keys / Programmable Keys](#).

In addition '3D Volume Data' must be checked on Store 1, Store 2, or Print key if volumes are to be stored. This selection can be accessed in [Setup / Keys / Image Store / Print Buttons](#).

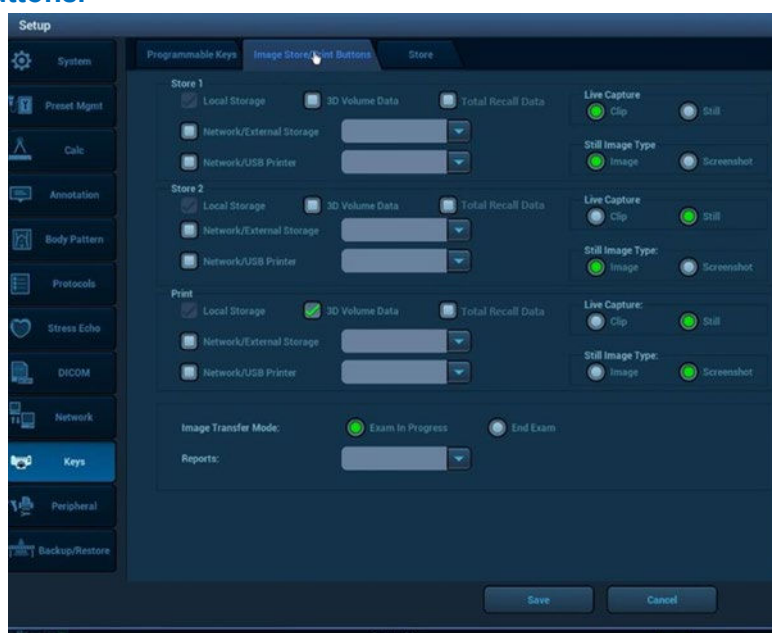

Softkeys (OLED)





When 3D/4D is invoked the following pre-acquisition softkeys are displayed:

| Control | Description/Use |
|--|---|
| Start / Stop Softkey Label: Start | Press to invoke the start of a 3D Volume Pressing again during acquisition will stop it Press the Freeze button to do the same thing |
| Postprocessing Mode Softkey Label: Render / Light / MPR / Tomo | Use to select the type of 3D Volume desired: Render [Surface] / Light (Surface Render with Light) / MPR / Tomo See "Postprocessing Modes" section for details |





| | |
|--|--|
| One-up / 4-up Toggle Softkey Label:  | Press to display Volume as a single, large image Press again to return to 4-up (A, B, C planes and Volume) |
| Acquisition Quality Softkey Label: Quality | Press to select the Quality factor of the Volume set: HIGH / BALanced / FAST Default is HIGH |
| Elevation Sweep Angle Softkey Label: Angle | Press to select the length of the Sweep: 75 / 60 / 45 / 30 / 20 Default is 60 degrees |
| 3D/4D Mode | Press to select Static (3D) or Real-Time (4D) mode |

Once a 3D volume has been acquired the following post acquisition softkeys are displayed:

| Control | Description/Use |
|---|--|
| Edit ROI (edit box appears) Softkey Label: Edit ROI | Only the A plane image has an adjustable curved outline Press to activate edit box for the selected plane Press Set to cycle box functionality: Position / Size / Outline |
| Postprocessing Mode Softkey Label: Render / MPR / Tomo | See the pre-acquisition softkeys. |

| Control | Description/Use |
|---|--|
| One-up / 4-up Toggle Softkey Label:  | See the pre-acquisition softkeys. |
| Slice Selection Softkey Label:  | Press to select a slice or volume: A / B / C / V Default slice is A |
| Cubic Dimension (6 sides) Softkey Label:  |  Press to select the viewing side for the active slice or volume Default is Top view |

When **Light** is selected, the following softkey is displayed:

| | |
|--|--|
| <p>Light (6 Directions) Softkey Label:</p>  | <p>Toggle up or down to select the light direction for the active volume. Default is front view. Trackball will also control direction of light while this softkey is active.</p> |
| <p>Volume Rotation Softkey Label:</p>  | <p>Press to rotate the volume to one of 4 discrete degrees: 0 / 90 / 180 / 270 Default is 270 degrees.</p> |
| <p>Volume Movement Softkey Label:</p>  | <p>Turn to move through the volume set: XYZ</p> |
| <p>Rotation (3 axes plus rotation) Default Softkey:</p>  | <p>Turn to rotate the selected plane or volume Press to switch the axes. Default is Volume with Z-axis Softkey options:</p>  <p>X-axis Y-axis Z-axis</p> <p>Can alternatively use these Major Mode buttons on the Control Panel: M = X-axis / D = Y-axis / C = Z-axis</p> |

| Control | Description/Use |
|---|--|
| <p>Threshold / Opacity / Brightness Softkey Label: Threshold / Opacity / Brightness</p> | <p>Selectable control with rotary action to adjust control parameters Turn softkey to increase or decrease the value of each parameter Press softkey to switch parameters Default is Brightness Can also use the B-Mode button to adjust Brightness</p> |

Additional 3D/4D optimization controls are available using the OLED controls:

| Control | Description/Use |
|---------------------|---|
| <p>Reset</p> | <p>Select to return volume back to original state</p> |
| <p>Mode</p> | <p>Press arrows to select an option: Surface / Max Int / X-Ray / Min Int Chosen option displays on Data Display</p> |

| | |
|-------------------------|--|
| Render Quality | Changes the resolution quality of the rendered image Press arrows to make selection: FAST / BALANCED / HIGH / MAX Chosen option displays on Data Display |
| Tint | Press arrows to select among 4 tints: 1 gray / 3 colorized |
| Render Smoothing | Press arrows to select the amount of smoothing desired: 0 / 1 / 2 / 3 / 4 / 5 Default is 3 Chosen option displays on Data Display |
| Invert | Toggles On / Off Inverts volume image to black on white |

Post-processing modes

z.one pro supports four post-processing modes: Render, Render with Light, MPR, and Tomo.

Render Mode

The imaging screen displays the surface volume image in a large format with the three orthogonal image planes in a small format. The volume image (**V**) is the active window by default.

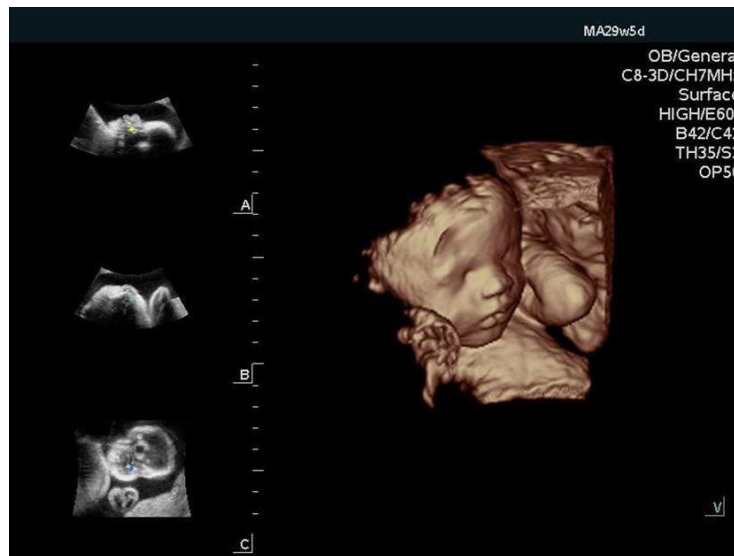

Figure 9-1: Render Mode

Render Mode with Light

Lighting provides surface enhancement to Rendered volumes.

The imaging screen displays the surface volume image in a large format with the three orthogonal image planes in a small format. The volume image (**V**) is the active window by default.

When the volume image is the active window and Light is activated using the Softkey,

an onscreen graphic is displayed with direction of the light.
The **Light** softkey controls the direction of the light.



Figure 9-2: Render Mode with Light



Figure 9-3: Light Direction Examples

MPR Mode

MPR mode displays orthogonal planes (**A**, **B** & **C**) vertically; larger image is blow up of active image

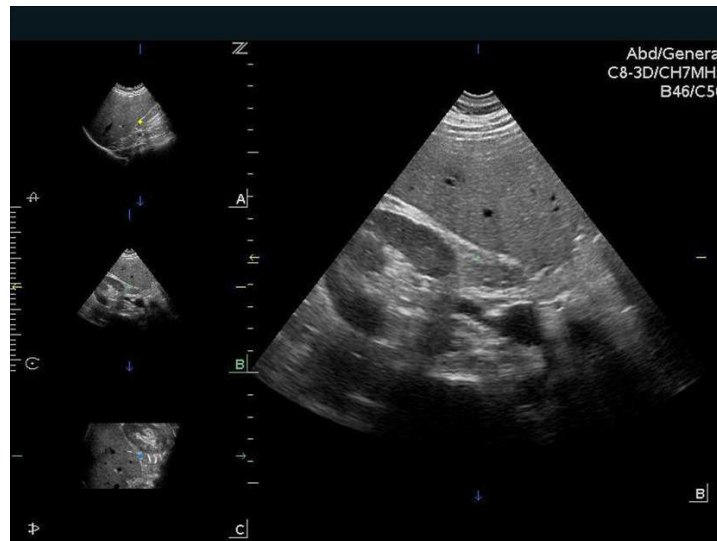

Figure 9-4: MPR Mode

Features include:

- Ability to cycle (forward & backwards) through different windows - **A**, **B**, & **C** planes
- Ability to measure off primary image using system **Measurement** and **OB Calcs** options
- **Thick Slice*** feature under **Menu/Tab** secondary controls

***Thick Slice Mode:** Integrates information along the z-axis to provide better contrast resolution. Maximum intensity and minimum intensity modes are supported.

Tomo Mode

In **Tomo** mode, 9 images are displayed (9-up) with one image as reference for slices.

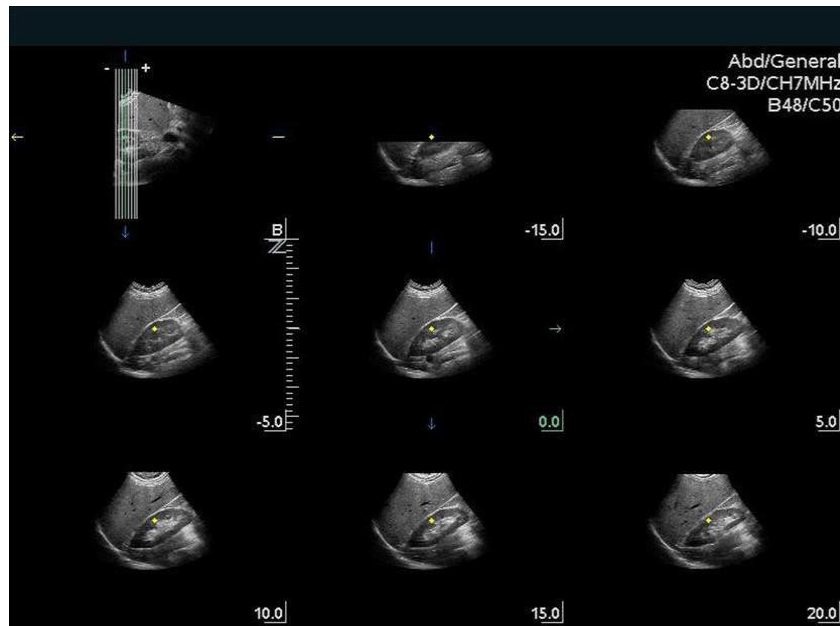

Figure 9-5: Tomo Mode

Features include the following abilities:

- Change line spacing between slices in mm and position of the set of lines using the **Trackball**
- Select reference image (one only) using softkey
- Toggle between **One-up** and **9-up**
- Perform measurements on **One-up** image
- Toggle slice lines' orientation from vertical to horizontal via softkey

10. Needle Optimization Mode (For Improved Needle Visualization)

Needle Opt Mode provides for improved needle visualization by adjusting system parameters to optimally receive echoes from needles.

Needle Opt Mode is available on the z.one pro when using the L14-5w, L20-5, L10-5 and L8-3 transducers during B-Mode Imaging.

Soft Keys (OLED)

Needle Opt Mode is invoked and controlled using the following softkeys:

| Needle Opt Control | Description/Use |
|--------------------------------|--|
| Needle Opt (On/Off) | Press the Needle Opt softkey to turn Needle Opt Mode On and Off. |
| Needle Overlay (On/Off) | Press the Needle Overlay softkey to turn off the shaded area onscreen representing the non-steered section of the image. If the anatomy of interest falls within the shaded area, the user should adjust the angle and/or offset controls and/or readjust the needle for optimum results. |
| L/R Invert | Press the L/R Invert softkey to invert the image L/R or R/L. |
| Needle Guide/Freehand | Turn the dial to toggle between Needle Guide and Freehand Selecting Needle Guide will display needle guide-specific onscreen guide lines and will automatically adjust Needle Angle and Needle Offset for each guide when available. Selecting Freehand will reset Needle Angle and Needle Offset to default and turn off onscreen needle guide lines. Press the dial when in Needle Guide to toggle onscreen guide line color |
| Needle Offset | Turn the Needle Offset dial to indicate the distance from the transducer face that the needle will be introduced into the skin |
| Needle Angle | Turn the Needle Angle dial to reflect the angle the needle will be inserted. Push the Needle Angle dial to invert needle direction L/R or R/L if the needle will be inserted on the opposite side of the probe. The needle should be inserted so as to intersect the dotted line of the shaded area at 90 degrees for optimum visualization. See Figure 10-1. |

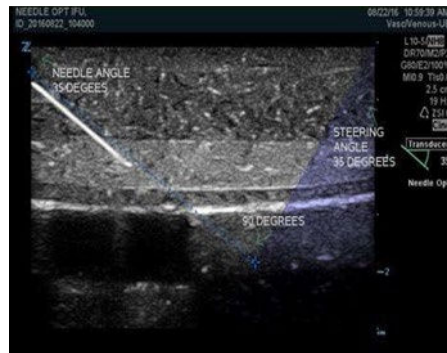

Figure 10-1
Optimum Needle Opt Setup
Needle and dotted line of the shaded area form a 90 degree angle

11. Protocols

Protocols Overview

The main objective of ultrasound workflow automation (Protocols) is to speed up exam times and reduce the excessive number of user interface manual key strokes that can lead to repetitive strain injuries over time.

Protocols automate clinical workflow in a logical “step by step” manner. They also prevent missing important parts of examinations as well as decreasing exam times.

A Protocol Event contains series of workflow events (annotations, body marks and calculations) and image modal commands to assist the user in routine ultrasound examinations.

Protocols are activated by pressing the **Protocol** key. The available protocols will be displayed on the screen. Select the appropriate protocol.

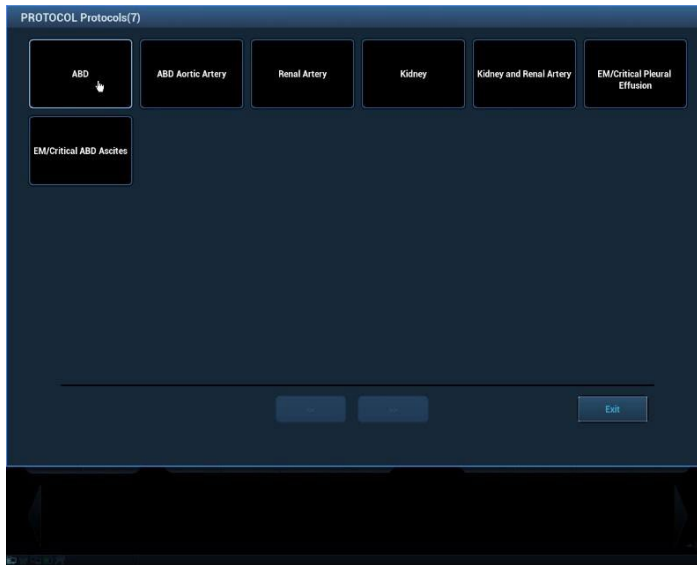

Follow the onscreen prompts in the **Help Bar** to navigate through pre-defined protocol steps.



The following Softkey (OLED) controls are available while Protocol is active.

| Soft Keys (OLED) | |
|---------------------------------------|--|
| Protocol Control | Description/Use |
| General Softkeys OLED controls | Repeat views, replace views, overwrite multiple views in sequence, delete views, and advance or go back views. |
| Suspend Protocol | Press the Softkey OLED to Suspend protocols to evaluate anatomy and pathology outside the order of a typical exam. If an exam is suspended, users can re-enter the protocol by pressing the Protocol key. |
| End Protocol | Press the Softkey OLED to End Protocols returning to live freeform imaging. |
| Insert | In the same manner as Suspend, users can also use the Softkey OLED to Insert predefined pathology images from the Insert Protocol to further accommodate individual clinical cases. |
| Incomplete | The Incomplete OLED offers flexibility in protocol order by providing a page to select an entry point out of the predefined order. For instance, in a renal study, a Sag Lt Kidney may be the 11 th protocol entry in the list. By pressing incomplete, the user can select that view to acquire and then continue the exam from there, or press incomplete again and enter the protocol at any view listed, including the beginning. |
| Continue | Press the Continue OLED to advances to the next view that has not been completed. This control may be used to quickly continue a protocol any time a user selects views out of sequence to Repeat, Replace, Overwrite, or Delete views for instance. |

Protocols can be customized using the **Setup/ Protocol** tab.

12. Stress Echo

Stress Echo Overview



CAUTION: Stress echo data are provided for reference only, not for confirming diagnoses.

Overview

Stress Echo is an option. The Stress Echo feature allows you to capture and review cardiac clips for multiple-phase (multiple-stage) Stress Echo protocols.

Stress Echo data consists of Stress Echo loops, wall motion scores, and all other information pertaining to the Stress Echo portion of a patient examination.

A loop is a clip that displays the motion of an entire heart cycle, or from the beginning systole to the end systole, as indicated by the R-wave of the ECG trace and determined by the QT – Time Table.

The loops in a given protocol are acquired by stages (phases), according to stage configuration (continuous (prospective) or retrospective (non-continuous)).

- Loops in non-continuous stages are limited to a specified loop-per-view maximum (such as four). View labels can only be selected in the configured order. Acquisition is retrospective - when you press <Store> on the control panel, the system saves the previously acquired images.
- Loops in continuous stages are limited by time rather than a maximum number of loops - the system stops acquisition after two minutes. Acquisition is prospective - when you select the stage label and then press <Store> on the control panel, the system starts saving newly acquired images. In some protocols, the system will jump to Select Mode after retrospective saving.

When images are saved, the system places a green checkmark to the right of the view or continuous stage and then shifts the red mark to the next view or next stage.

■ Configuration

A Programmable Function key may be assigned to Stress Echo (or users may press the Protocol Key) in order to invoke Stress Echo imaging. The key can be configured in [Setup / Keys](#).

Operations are as follows:

1. Press [Setup -> Keys](#).
2. Click to select Stress Echo to the desired key.
3. Click Save to complete the setting.

Once configured, pressing the key assigned to Stress Echo (or pressing the Protocol Key) will display a list of protocols to choose from. Select the desired protocol and select OK.

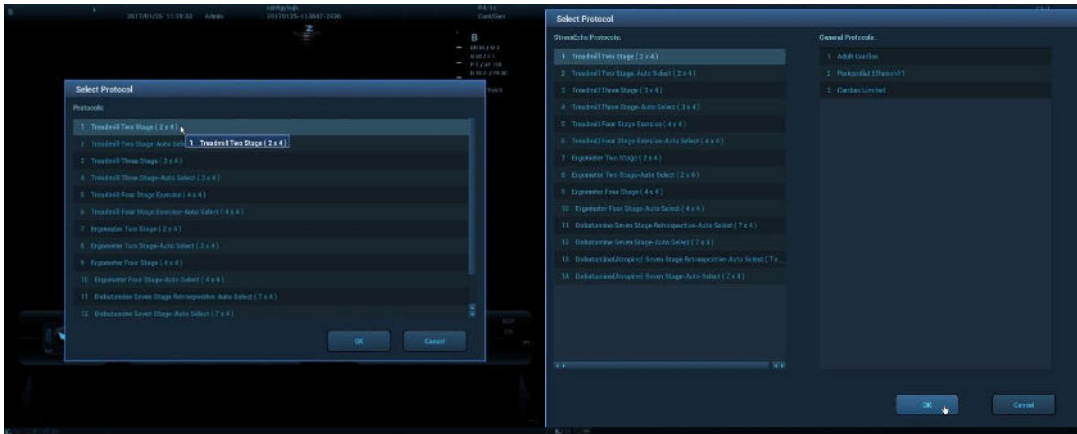

Programmable Key Pressed

Protocol Key Pressed

Onscreen prompts in the **Help Bar** will guide the user in terms of next keys to press to advance the Stress Echo protocol.

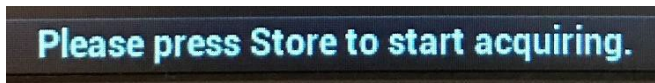

Where not labeled, pointing to onscreen controls will display a quick hint as to function of the control.

■ Basic Procedures for Stress Echo Imaging

To acquire Stress Echo loops, you must enable the ECG function.

1. Use the proper probe and cardiac-related exam preset.
2. Press the configured key or the <Protocol> Key to enter stress echo imaging.
3. The system displays the “Select Protocol” window with the protocol selections. Select the desired protocol and then click [OK].

The system displays the real-time imaging screen.

4. Press <Store> on the control panel to start acquisition.

The system displays the Protocol window on the left of the screen, listing the phases for the selected protocol along with the first phase views (phases are stages). The system selects the first view for acquisition by default, indicating the selected view by placing a red mark to the right of the view name.

5. Proceed through each view in each stage according to the following instructions:

Non-continuous stages:

- To save acquired images for the selected view, press <Store> on the control panel. The system goes to the next view for acquisition by default, saved views are marked with a green “√.”
- Rotate <Stages XXX> or <Views XXX> to select the stage and view for image acquisition (or reacquisition). Press <Save> key to start acquisition.

Tip: Views can be re-acquired until you click [End Acquisition].

If the protocol contains continuous stages (for alternative workflows), then proceed through each continuous stage according to the following instructions:

- To begin saving acquired images for the selected stage, press <Store> on the control panel.

The system displays a time marker below the selected stage indicating the progress of

the continuous capture.

- To halt saving acquired images for the selected stage, press <Freeze> directly. The time stops increasing.
- Press <Freeze> again to continue.
- To end the current acquisition, press <Store> on the control panel.
- To select another continuous stage, press <Stage XXX> key.
- Suspending is not allowed under continuous exam.

When acquisition is complete for each stage, the system advances to the next stage. If the stage is non-continuous, the system displays the stage views. When image acquisition is completed for all views and continuous stages, the system switches to Select Mode.

6. To start or restart the timer, press <Stage Timer>/<Exam Timer> on the soft menu to turn it on.

The Stage time is displayed to the right side of each stage in the protocol list, while the Exam time is displayed in the left side of the screen.

Each saved image will be marked with two times T1 and T2. T1 refers to the total time of the whole acquisition, while T2 indicates the time the acquisition lasted for a certain stage.

7. To end the acquisition and review the acquired images, click [End Acquisition].

NOTE: When the acquisition is ended, no additional stress echo image acquisition can be performed for the same exam.

The following stages and controls are available while Stress Echo is active.

| Soft Keys (OLED) | | | | |
|------------------|---|--------------------|--|--|
| Stage | Available Softkey (OLED) Controls | | Available Onscreen Controls | |
| Acquire | End acquisition | Delete Unselected | Resting images available for selection | Post images available for selection End Acquisition |
| | Suspend SE. If SE is suspended, pressing Protocol key or programmable key assigned to SE will re-enter exam | Acquisition pause | | |
| | Reference Image On/Off | Exam timer on/off | | |
| | End SE | Stage timer on/off | | |
| | Text On/Off | Mode | | |
| | Playback Speed +/- | Stages | | |
| | | Views | | |

| | | | | |
|------------------------|--|---|---|---|
| Select | <p>End SE</p> <p>Suspend SE. If SE is suspended, pressing Protocol key or programmable key assigned to SE will re-enter exam</p> <p>Bookmark</p> <p>First Page/Last Page</p> <p>Page X/X</p> | <p>Mode</p> <p>Stages</p> <p>Views</p> <p>Delete Unselected</p> <p>Text On/Off</p> <p>Playback Speed +/-</p> | <p>Mode</p> <p>Suspend exam: If SE is suspended, pressing programmable key assigned to SE will re-enter exam</p> <p>End SE exam</p> | <p>Stage and available views to choose from</p> <p>Navigation arrows for available images and pages</p> <p>Stage of protocol is duplicated onscreen for easy access.</p> |
| Review/ WMS | <p>Current Normal</p> <p>All Normal</p> <p>Prev Page/ Next Page</p> <p>First/Last</p> <p>Compare Mode On/Off (Stage, View, Shuffle)</p> <p>End SE</p> <p>Suspend SE. If SE is suspended, pressing Protocol key or programmable key assigned to SE will re-enter exam</p> <p>Select Clip Length (Full cycle, Systole, Diastole)</p> | <p>WMS model</p> <p>16 or 17 segment</p> <p>Scoring 4, 5, or 7 Mode</p> <p>Mode</p> <p>Stage</p> <p>Views</p> <p>Text On/Off</p> <p>Delete Unselected</p> | <p>Cine playback</p> <p>Cine navigation controls</p> <p>Text on/off</p> <p>Review mode</p> <p>Stages and views</p> | <p>Suspend exam: If SE is suspended, pressing programmable key assigned to SE will re-enter exam</p> <p>End SE exam</p> <p>Wall Motion Scoring</p> <p>Stage of protocol is duplicated onscreen for easy access.</p> |

Stress Echo protocols can be customized using the [Setup/ Stress Echo](#) tab.

13. Setup

The Setup function is designed to set the configuration parameters of operating the system and maintaining user workflow setup data. The setup data of the user and system are stored to the hard drive, and should be backed up to USB memory device.

To enter Setup, press the **Setup** key on the User Interface. The following tabs are available for customization.

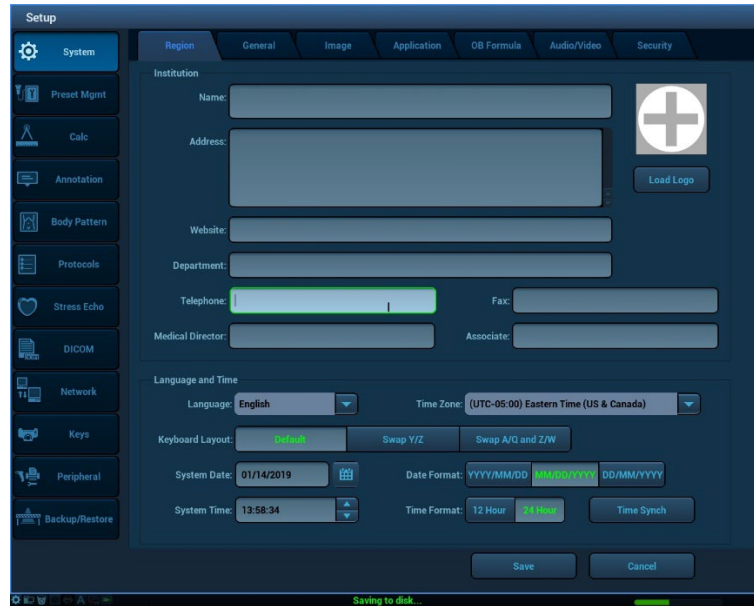

| System | Description of Control |
|-------------|--|
| Region | Enter the hospital name, language, time zone, time format, and system date/time |
| General | Enter patient information, exam setup, patient management, storage, system dormancy, auxiliary output settings etc. |
| Image | Enter general parameters in imaging modes (power up, dual, TEE, cine flush, probe change, Doppler, Optimize, cine play, target offset, display Transducer Tracking etc.) |
| Application | Enter the measurement settings (by exam type) and preferences including AutoTrace. |
| OB Formula | Enter relevant information regarding fetal gestational age, fetal growth formula and fetal weight |
| Audio/Video | Enter monitor, audio and external video settings |
| Security |  <p>Once enabled, users may Verify current location; or Change/Configure Locations by pointing to or clicking on the onscreen Location Management System ICON and following the onscreen prompts.</p> <p>Customize User Account access (Security)</p> <ul style="list-style-type: none"> • add/delete users • control passwords • edit privileges • LDAP configuration |

| Preset Management | Description of Control |
|--------------------------|---|
| Enable / Disable | Select transducer, category and preset combinations that will be available for selection. Exam Type can be disabled independent or transducer/preset. |
| Customization | Assign Exam Type and Preset to softkey OLED controls for easy access |
| Delete | Select User Presets for deletion by transducer and category. This page is also accessible by pressing the Delete softkey when Exam Type is active. |
| Create/Modify | Create or modify presets or define which preset is default by probe. These functions are also available on the softkey OLEDs when the user presses the Exam Type button. Select Quick Save and follow onscreen prompts. |

| Calc | Description of Control |
|----------------|--|
| Calc | Select calculations package, calculation menu content, and order of calculations in the display for 2D, M Mode and Doppler (by exam type). |
| Caliper | Select measurements, and order of menu items available for 2D, M Mode and Doppler (by exam type) |
| Report | Select, modify and create report template for each exam types. |

| Annotation | Description of Control |
|-----------------------------|--|
| Preset Configuration | Assign pre-defined annotations lists to softkey (OLEDs) by category and preset. Select arrow and annotation default color. Enable auto completion, dual imaging annotation, and smart override mode. |
| Define Lists | Define the name, contents and order of pre-defined annotation lists that will be available for assignment to softkeys (OLED). |

| Body Pattern | Description of Control |
|---------------------|---|
| Define | Create body pattern libraries and contents. Assign default libraries available by category and preset. |

| Protocols | Description of Control |
|------------------|---|
| Protocols | Link protocols to exam types so when an exam type is active and the user presses the Protocol key, specific protocols are available for selection. Create user defined protocols and assignments to presets. |

| Stress Echo | Description of Control |
|--------------------|---|
| Protocol | Create, edit, import, load, and delete SE protocols |
| Maintenance | Select and configure onscreen labels, ROI type, and default WMS type. Customize or reset clip triggers. |

| DICOM – Set DICOM Service | Description of Control |
|----------------------------------|---|
| Storage | Configure a DICOM destination including AE Title, port, transfer specifics and options, and image/clip specifics and options including Tissue Tracking. |
| Print | Configure a DICOM printer destination including AE Title, port, transfer specifics and options, image/clip specifics and options, and print specifics and options. |
| Worklist | Configure a MWL source including AE Title, port, and data transfer specifics. |
| MPPS | Configure Modality Performed Procedure Step which is used to send exam state information to the configured server. This facilitates the other systems in obtaining the exam progress in time. |
| Storage Commitment | Configure storage commitment parameters including AE Title, port, transfer specifics and options. |
| Query / Retrieve | Configure storage commitment parameters including AE Title, port, transfer specifics and options. |
| HL7 Query | <p>Configure network specifics relating to HL7</p> <p>HL7 refers to the medical information exchange protocol on the seventh layer (application layer) of the Model of the Open System Interconnection published by ISO. It is established by Health Level Seven International in 1987.</p> <p>HL7 is mainly used for standardizing the communication between HIS/RIS system and the other devices, reducing the information interconnection costs among hospitals, and improving the data usability for hospital information system.</p> |

| Network | Description of Control |
|----------------|---|
| Network | Configure network specifics including IP address, Gateway, Subnet Mask, MAC address Configure a wireless bridge. |

| | |
|--------------------------|---|
| FTP | Configure an FTP destination including IP Address, password, port, and data transfer mode. |
| QPath/ Q-View | <p>Configure (import, backup, restore, and delete) QPath worksheet linkages and passwords</p> <p>Configure Q-View, which is a client viewing tool for the server.</p> <p>The primary purpose of Q-View is to provide remote access to Q-Path from the ultrasound system, thereby, allowing the users to complete the exam report on the ultrasound system and submit.</p> |
| VPN | Configure a Virtual Private Network (VPN) connection including Server IP, Group, User Name and Password to allow for encrypted transfer. |

| Keys | Description of Control |
|------------------------------------|--|
| Programmable Keys | Configure exam category (Cardiac, Abdominal, Obstetrics, Gynecology, Vascular, Pediatrics, Urology, POC, and Small Parts) specific programmable keys including Function keys, and Footswitches. Selections are also available to configure the B Mode Knob (B Mode or B Mode Home) and trackball speed which are not category specific. |
| Image Store / Print Buttons | Configure capture type (cine/still, image/screenshot), storage destination of Store 1, Store 2, and Print Keys, Reports, and transfer type (exam in progress or end exam). |
| Store | Configure compression level/quality for image storage. Select clip configuration assignment (All Presets or Preset Specific) |

| Peripherals | Description of Control |
|-------------------------------------|---|
| Print Service | Setup a local printer. |
| Barcode Reader Configuration | Configure a barcode reader including fields to match, worklist options, and barcode reader device assignment. |
| Power Save | Configure sleep and shutdown behavior when on battery and external power. |

| Backup / Restore | Description of Control |
|-------------------------|---|
| Backup/Restore | To initiate a Backup or Restore of Presets and System data to and from a USB device. To restore factory defaults of Preset and System files. |

14. System Security

System security features available on the z.one pro platform include Anti-Virus Scan, Secure Data Deletion, Patient Data Encryption, Password Protected User Accounts, Secure Network Transfers, and Backup to external media with Encryption.

Anti-Virus

The Anti-Virus scan feature is accessed under the boot_app display (press Service Key/ select Maintenance / select Service Reboot softkey to access the boot_app display).

Once in the boot_app display, insert a USB 'thumb drive', with the latest virus definition file (which can be downloaded from <http://database.clamav.net/main.cvd>) into one of the available USB ports. Then select the "Virus Scan" option and follow the dialog prompts to initiate a Virus scan.

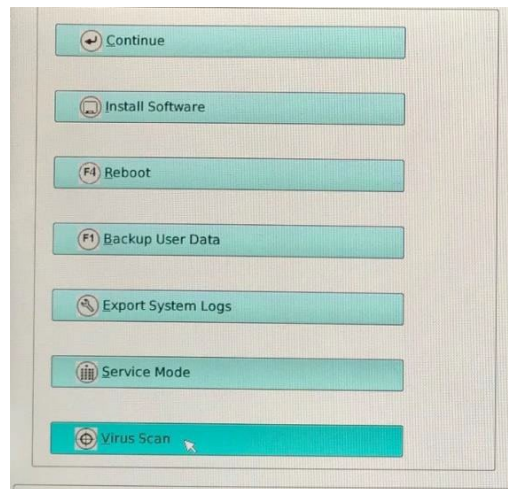

Secure Data Deletion

The secure data deletion option is initiated by pressing Service; Maintenance; Service Reboot; and selecting 'Service'. Point to and press a Set key to select the 'Sanitize and Reformat Cart HD menu item.

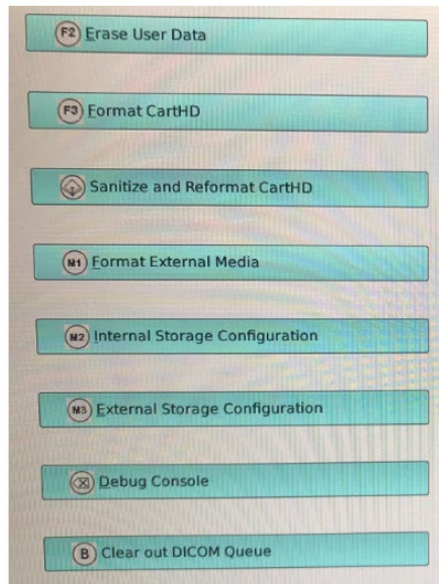

Patient exam data can be encrypted and then stored to the system hard drive in conformance with the Advanced Encryption Standard (AES).

(***Note: The archive must be empty to either enable or disable encryption.)

Configuration options are available through Setup; System; Security/ Exam Data Encryption

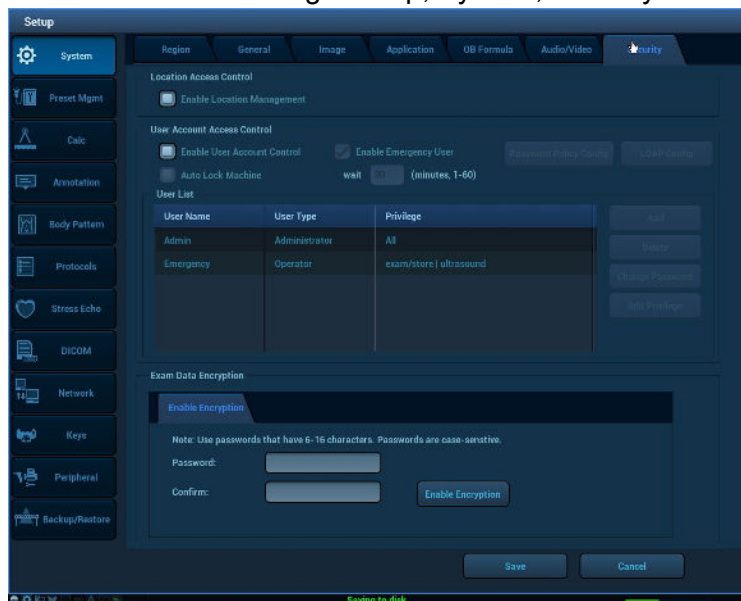

A password is required to enable and disable encryption.

- All new and pre-existing data stored to the Hard Drive is encrypted/decrypted once a password is entered and encryption is enabled/disabled.

Password Protected User Accounts

The z.one pro system supports password protected user login(s) which are cached on the system and unrecoverable if 'lost'. At least one user must be assigned to the "Admin" role. This user cannot be deleted. The Admin User can change/reset passwords

for any user login; whereas, other users can only change their own login passwords.

- Admin
- Operator
- Emergency

Passwords must include the following to be considered 'strong':

- 6-16 alpha-numeric characters
- At least two uppercase letters
- At least two lowercase letters
- At least two numbers

User Account Control

To configure, press the **Setup** key; and select the **Security** Tab; Enable User Account Control; Password Policy Config and follow onscreen prompts.

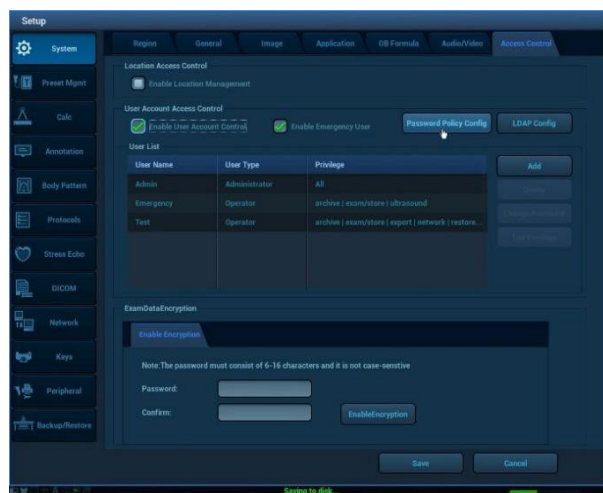

To add or delete users; change passwords; or edit privileges, point to and select the appropriate button (highlighted in yellow box below) and follow onscreen prompts.

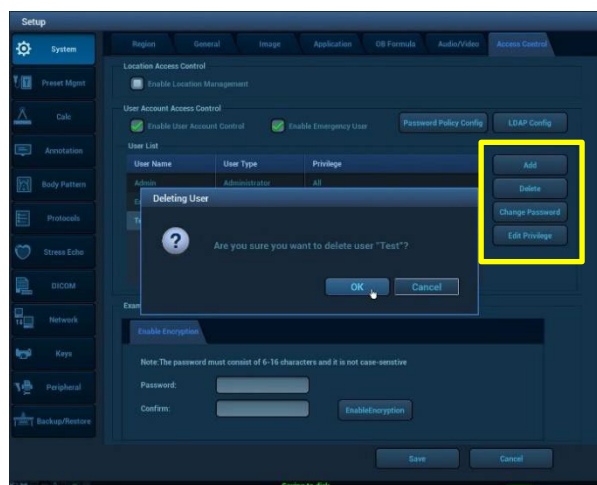

Lightweight Directory Access Protocol (LDAP) Configuration

z.one pro integrates with existing Lightweight Directory Access Protocol server on the customer premise for centralized user authentication.

To configure, press the **Setup** key; select the **Security** Tab; Enable User Account Control; LDAP Configuration and follow onscreen prompts.

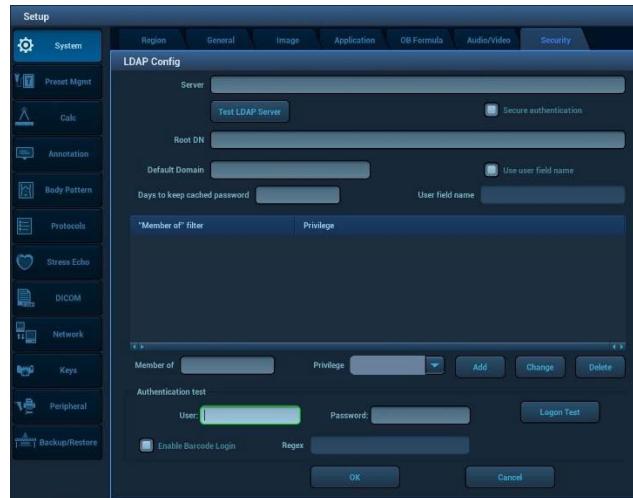

Secure Network Transfers

Patient data can be transferred over a network VPN connection using TLS/SSL encryption (TLS 1, 2 or above).

Transport Layer Security (TLS) can be configured to encrypt DICOM communications between the z.one pro and DICOM servers for added security. An alternative, less commonly used approach is to establish a Virtual Private Network (VPN) between the z.one pro and the DICOM server that do not offer TLS. Any communication between the two end points of a VPN is encrypted. Note that with TLS, z.one pro can communicate securely with multiple TLS-capable DICOM servers. z.one pro can only support one VPN connection to one other end point."

Press **Setup**; **Network**; and select the VPN tab to access the VPN configuration page.

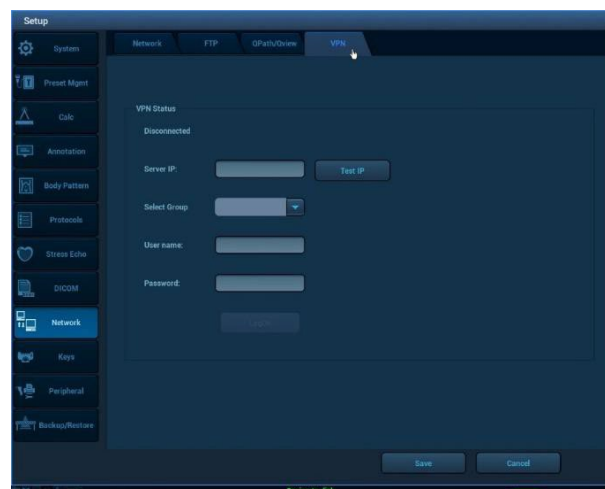

Backup Exam Data to USB with Encryption

The z.one pro system can be set up to encrypt patient exam data before backing up the data to removable media like USB.

Select a patient exam from the Archive. Choose Backup Exam and select the appropriate external media as the destination. Check 'Encrypt Selected Exam Data' and point to Backup with Trackball and press a Set Key to initiate the encrypted Backup.

Backup Patient Record

Destination: USB(6:)

Remove from Local HD after Backup

Remove Exams Remove Images

Encrypt Selected Exam Data

Password:

Note: Password must be 6-16 characters.

Confirm Password:

Hide Patient Info

Include TRI Images

Backup Cancel

15. Maintenance

User Diagnostic Panel

The user diagnostic panel is accessed through the **Service** key on the back row of the keyboard. A short press of that key activates the diagnostic panel. A long press of the key stores current logs; the system beeps as logs are stored.

The user diagnostic panel supports the following:

- Checking system software revision level
- Checking system serial number
- Checking for firmware updates
- Transducer tracking: enabling, accessing, defining duration and applying passwords
- Checking revision levels of major PC boards and components
- Maximum software level available for system
- Verifying which features, functions and transducers are licensed for the system
- Updating license file
- Capturing, clearing, exporting, and sending system log files
- Auto logging setup: Including encryption
- Capturing current image screen and storing as a BMP file
- Transferring the contents of the internal log directory (using an internet connection) to the MINDRAY/ZONARE FTP site
- Checking (over the Internet) for availability of software and firmware (cart) updates from the MINDRAY/ZONARE FTP site
- Transducer diagnostics
- Monitor setup
- Service Reboot

Transducer Diagnostics

This function enables users to check if a transducer element is in malfunction, so as to evaluate the transducer performance.

The diagnostic procedure is as follows:

1. Press the **Service** key to enter the user diagnostic panel.
2. Click [Maintenance]->[Transducer Diagnostics] to enter the transducer diagnostic screen.
3. If the number of a transducer's element is more than 64, press the right **Set** key to check other elements, and left **Set** key to return.
4. If the transducer element is in malfunction, the dark stripes are displayed, as shown in the following left figure. If the transducer element functions well, no dark strips are displayed, as shown in the following right figure.

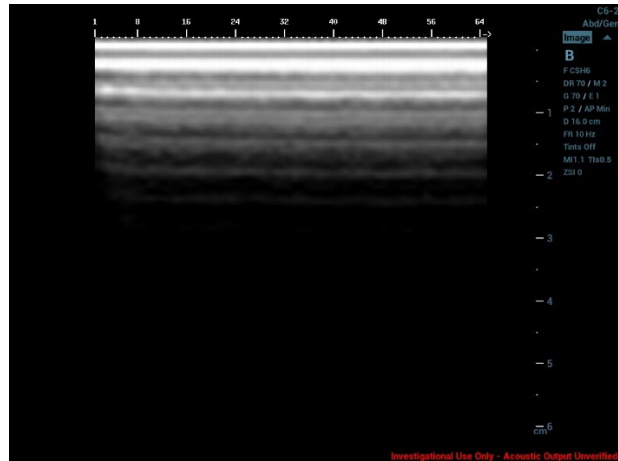
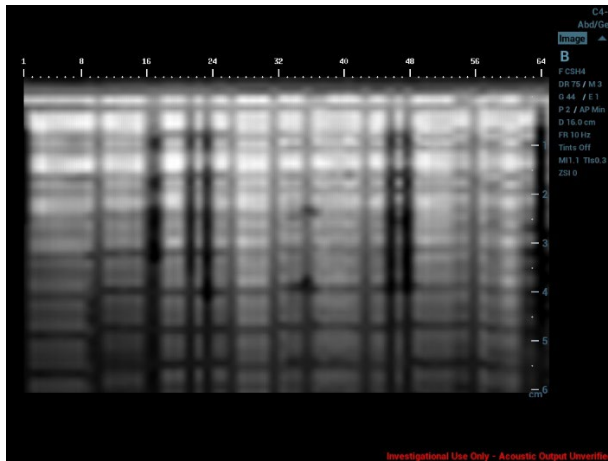

5. Press the **Undo** key to exit transducer diagnostics.

Notes: Probe check is provided for reference only, not for confirming a diagnosis.

Each time a transducer is connected to the main system or activated, the users are recommended to implement probe check of transducer performance.

System Care and Cleaning

Before cleaning, turn off the AC circuit breaker on the z.one pro system to remove all power from the unit.

To clean the LCD display:

- Clean the glass using a soft cotton cloth lightly moistened with a watery solution or a mild commercial glass-cleaning product suited for coated glass surfaces.
- Wipe dry with a clean, dry, soft, lint-free cloth.
- Take care not to damage or scratch the glass or LCD panel. Do not apply pressure on the glass or LCD panel. Do not apply or spray liquid directly to the glass, panel, or cabinet as excess liquid can cause damage to internal electronics. Apply the liquid to the cleaning cloth.

To clean the External Case:

- Do not use disinfectants (such as glutaraldehyde) or acetone to clean any surfaces on the z.one pro system or its accessories.
- Wipe the z.one pro surfaces with a safe disinfectant solution such as Sani-Cloth Plus or 50% isopropyl alcohol and follow the disinfectant label instructions for use.
- Do not spill or spray liquid directly on the control panel, LCD display or transducer connector.
- Using soap and water or a mild disinfectant, gently wipe the surfaces of the z.one pro system with a moistened cloth.
- After each use, remove and dispose of any used cover/sheath. Wipe off any excess gel from the transducer and clean it properly and air dry the z.one pro system.

16. Safety

It is not possible to anticipate every condition and situation in which ultrasound system will be used. The following warnings and cautions represent typical situations that require special attention. User knowledge and experience with a specific application and environment must also be taken into consideration in order to help ensure the safety of personnel and equipment.

Safety Standards

- According to the type of protection against electric shock: Externally powered CLASS I + Internally powered EQUIPMENT
- According to the degree of protection against electric shock: TYPE-BF APPLIED PART and TYPE-CF APPLIED PART
- According to the degree of protection against harmful ingress of water or particulate matter:
 - The main unit is classified as IPX0
 - The probe is classified as IPX7
 - The footswitch (can be used in the operating room) is classified as IPX8
- According to the disinfection and sterilization method(s) recommended by manufacturer: The devices recommended by the manufacturer.
- According to the degree of safety of application in the presence of a FLAMMABLE ANESTHETIC MIXTURE WITH AIR or WITH OXYGEN OR NITROUS OXIDE: EQUIPMENT not suitable for use in the presence of a FLAMMABLE ANESTHETIC MIXTURE WITH AIR or WITH OXYGEN OR NITROUS OXIDE.
- According to the mode of operation: CONTINUOUS OPERATION
- The device equipped with the applied part of defibrillation protection: The device is not equipped with the applied part of defibrillation protection.
- Permanently installed or non-permanently installed: Non-permanently installed

Safety Standards

All MINDRAY/ZONARE instruments, cables, and diagnostic ultrasound imaging transducers have been designed to meet the essential requirements contained in 93/42/EEC (Medical Device Directive), and all appropriate requirements contained within IEC 60601-1, AAMI STD ES 60601-1, CSA STD C22.2 NO. 60601-1 (Medical electrical equipment - Part 1: General requirements for basic safety and essential performance), IEC 60601 (Medical electrical equipment - Part 2-37: Particular requirements for the safety of ultrasonic medical diagnostic and monitoring equipment), IEC 60601-1-2 (Medical electrical equipment - Part 1-2: General requirements for basic safety and essential performance Collateral Standard: Electromagnetic Compatibility), and JIS-T-1501 (General Methods of Measuring the Performance of Ultrasonic Pulse-Echo Diagnostic Equipment), including limits for current leakage and isolation from a primary power line. Testing for compliance

with the essential requirements of the Medical Device Directive has been performed. The following is a comprehensive list of the Warnings & Precautions associated with the use of z.one pro Ultrasound System and compatible transducers.

Warnings



- Do not use an aftermarket probe other than those specified by Mindray. The probes may damage the system causing a profound failure, e.g. a fire in the worst case.
- Accessory equipment (analog or digital) connected to the ultrasound system must comply with the relevant IEC standards (e.g., IEC 60950 information technology equipment safety standard and IEC 60601-1 medical equipment standard). Furthermore, all configurations must comply with the standard IEC 60601-1. It is the responsibility of the person, who connects additional equipment to the signal input or output ports and configures a medical system, to verify that the system complies with the requirements of IEC 60601-1. If you have any questions regarding these requirements, please consult your sales representative.
- When the wireless LAN function is turned on, the ultrasound system may suffer interference from other equipment, even if that other equipment complies with CISPR EMISSION requirements.
- Keep at least 20 cm away from the ultrasound system when the wireless LAN function is in use.
- Do not connect or disconnect the system's power cord or its accessories (e.g., a printer or a recorder) without turning OFF the system power first. This may damage the system and its accessories or cause electric shock.
- If the system is powered off improperly during operation, it may result in data damage of the system hard disk or system failure.
- Please use the ultrasound gel compliant with the relevant local regulations.
- The cover contains natural rubber that can cause allergic reactions in some individuals.
- In normal diagnostic ultrasound mode, there is no danger of a normal-temperature burn; however, keeping the probe on the same region of the patient for a long time may cause such a burn.
- Do not use the system to examine a fetus for a long period of time.
- When using intra-cavity probes, do not activate the probe outside the patient's body.
- Power off the system if you will not use the system for a long period of time (including storage/ transportation condition), and you should not allow the system in standby status, otherwise the batteries will be out of power and permanently damaged.
- If you will not use the system for a long period of time, please periodically check the battery and ensure that the battery power is sufficient. Otherwise, the battery may permanently be damaged. If any fault is found during checking, please contact Mindray Customer Service Department or sales representative.
- To dispose of the system or any part, contact Mindray Customer Service Department or sales representative. Mindray is not responsible for any system content or accessories that have been discarded improperly.
- DO NOT touch the Signal I/O ports if in contact with the patient; otherwise patient injury may result.
- Do not allow the patient to contact the live parts of the ultrasound system or other

devices, e.g. signal I / O ports. Electric shock may occur.

- When faults occur during installing or leading the outside protective wire, the ultrasound system should be powered by the internal power supply.
- Do not remove any of the System covers other than the module cover. Other than the scan module there are no user-serviceable parts internal to the system. Only trained Mindray service personnel should access the system's internal electronics.
- The ultrasound system contains no operator-serviceable components within the enclosures. To avoid electrical shock, do not remove covers. As with any other electrical equipment, always observe care when operating this instrument. For service issues, contact Mindray Technical Support. Failure to follow these restrictions may void your warranty or service contract coverage.
- To reduce the risk of electric shock, DO NOT connect the z.one pro system input or output connections to equipment that is not properly connected to an Earth ground
- To achieve proper grounding reliability, the ultrasound system power plug must be fully inserted into a receptacle marked "hospital grade." Do not remove the grounding wire. If there is any question of power outlet or power cord integrity, do not proceed. Obtain qualified assistance
- To maintain proper grounding reliability, use only Mindray-recommended peripherals and accessories. Use of non-specified peripherals and accessories could result in risk of electrical shock or injury
- The ultrasound system and probe represent a potential explosion hazard if used in the presence of flammable anesthetics.
- The system does not contain a user-serviceable lithium ion battery.
- The optional ZPAK cart battery is not a user serviceable item. Contact Mindray Technical Support group for assistance with the ZPAK battery.
- Follow guidelines provided by relevant IEC standards when connecting peripherals.
- The USB thumb drive supplied by Mindray are the recommended brand, type, and sizes for use in z.one pro Systems. They have been verified for optimum reliability and performance
- No modification of the system is permitted. Modifying the system may subject the operator or patient to hazardous conditions.
- To reduce the risk of electric shock, do not connect the z.one pro input or output connections to equipment that is not properly connected to an Earth ground.
- The z.one pro ultrasound system and probe represent a potential explosion hazard if used in the presence of flammable gases or oxygen rich environment.
- Use only transducers that are specifically approved and licensed for the ultrasound system. If the proper identification of a connected transducer is not displayed on screen, do not proceed with its use.
- Transducers covers may be contaminated and must be handled accordingly.
- Inspect the transducer and z.one pro System before each use. Inspect the transducer face, housing, cable, connectors, and cases. Do not use the unit if damage is detected.
- Bent, broken, or missing pins on the transducer connector may cause poor image quality, including possible mirror image artifact. Be sure to check pins before connecting transducer to the ultrasound system. If pins are bent, broken, or missing, do not use the transducer and call Mindray Technical Support.
- To avoid electrical shock, always unplug the ultrasound system AC power cord from wall outlet before cleaning any part. Do not immerse the transducer past the specified

cleaning/disinfection level, as specified in Transducer Cleaning and Disinfection. Do not immerse the transducer for longer than the specified cleaning/disinfecting time. Do not use any transducer that has been immersed beyond the maximum limit or has been soaked longer than the maximum specified time.

- Do not allow disinfectant to contact metal surfaces. Always use protective eyewear and clothing when cleaning or disinfecting device
- Disinfectant wipes and topical spray products are not FDA cleared high-level disinfectants and do not provide adequate protection should the transducer become cross-contaminated.
- The transducer must be removed from patient contact before application of a high-voltage defibrillation.
- The system is not intended for use in conjunction with high frequency (HF) surgical equipment (tissue ablation devices). Do not use transducers connected to the ultrasound system on patients while HF surgical devices are in use.
- If using relevant IEC standards compliant equipment that was not provided by MINDRAY/ZONARE, it is required that total leakage currents be tested and validated to be below the IEC 60601-1 limits in chapter 21.
- This equipment must only be connected to a supply main with protective earth.
- Validate that measured and calculated results shown in Calc Package reports reflect the clinical observations.
- Auto-Dop Trace is intended to serve as an adjunct to the diagnostic process in evaluating blood flow during PW Doppler examinations. When using the Auto-Dop Trace feature, please
- Evaluate the results to verify that you are in agreement before committing the values to the Calc Report Package.
- Always examine transducers for damage, such as cracks, splitting, holes, or fluid leaks. If damage is evident, discontinue use of the transducer and contact Mindray.
- Prior to initiating any disinfection process, disconnect the transducer from the ultrasound system.
- Ensure that any connected external equipment, such as external monitors, printers and peripherals, comply with relevant standards such as IEC60601-1 and IEC60601- 1-2.
- If an external video monitor is connected to the z.one pro system, it is necessary to ensure that an RF ferrite is clamped to the cable as close to the z.one pro system as possible. Use a ferrite such as Fair- Rite Products Corp. 0431167281 (or an equivalent).
- The potential equalization terminal, located by the AC Mains connection, is connected to the system chassis. It can be connected to corresponding terminals on other equipment to eliminate potential differences. Do NOT use it for additional protective grounding
- Damage to the system may cause poor image quality, including possible imaging artifacts sometimes referred to as 'halo' or 'headlight' artifacts. Regularly inspect the system for damage and know how to recognize imaging artifacts.
- There are many types of system use and system error messages that might be displayed during the use of the z.one pro Ultrasound System. If a message is encountered that is not self- explanatory, contact Mindray service for assistance.
- Do not touch any of the connector contacts while performing a patient examination to prevent the possibility of a hazardous current path.
- Do not expose the device to a magnetic resonance (MR) environment.
- Do not disassemble the probe to avoid the possibility of electric shock.

Warnings – Ocular (Ophthalmic) Imaging

- To avoid injury to the patient, use only the Ocular Preset when imaging through the eye. The FDA has established lower acoustic energy limits for ophthalmic use. The system will not exceed these limits only if the Ocular Preset is selected.

Warnings - Battery

- To avoid electrical shock, do not touch the battery contact.
- To avoid risk of fire, explosion, or burns:

Do not disassemble or alter the battery.

Do not short-circuit the battery by directly connecting the positive and negative terminals with metal objects.

Do not heat or discard the battery in a fire.

Do not expose the battery to temperatures above 65° C (150° F).

Do not charge the battery near a heat source.

Do not leave the battery in direct sunlight.

Do not use a damaged battery.

Charge the battery at room temperature.

The battery should only be charged within the z.one pro System.

Inspect the battery for damage before charging or placing the battery in the z.one pro System.

Do not connect battery to an electrical power outlet.

Do not continue to recharge the battery if it does not recharge fully after 4 hours.

Warnings - ECG

- The ECG and the Respirometer functionality are not intended for ECG diagnosis. It must not be used for intraoperative applications of the heart. Use only the recommended patient cable supplied by Mindray. Make sure that bare parts of the electrodes and the patient do not come in contact with conductive parts, such as metal examination beds, trolleys, and similar items.
- Before defibrillation, always disconnect the ECG cable connector from the system and make sure the connector does not come in contact with other persons or conductive surfaces, such as metal examination beds, trolleys, and similar items.
- Operating your system with ECG signals below 0.25 mV may cause inaccurate results.

Warnings – TEE Transducer

- The multiplane TEE transducer should be used only by a qualified physician who has received appropriate training in proper operation of the probe and in endoscopic techniques as dictated by current relevant medical practices.
- Electrical Hazard: Any evidence of damage indicates the probe cannot be used and should be returned to Mindray for evaluation and repair.
- Biological Hazard: Adequate cleaning and, if necessary, disinfection are carried out to prevent disease transmission. It is the responsibility of the user to verify and maintain the effectiveness of the procedure used. A single-use, sterile disposable sheath for TEE purposes can be used.
- Inspect the transducer connector pins for contamination or damaged pins that might interrupt signal flow through the connection. Be sure to check pins before connecting transducer to the ultrasound system. If pins are bent, broken, or missing, do not use the transducer and call Mindray Technical Support.
- Immediately replace a transducer that exhibits any damage symptoms.

- Before introducing the probe, do not rub or spray the tip of the probe with an anesthetic agent.
- Avoid forceful manipulations and excessive force in using the probe that could result in patient injury.
- Withdraw the probe only with the deflection control in the unlock mode and with the distal end of the probe straight.
- The use of a bite guard is mandatory. Failure to use the bite guard may result in damage to the probe, which could result in a safety hazard. Damage to the probe due to biting is not covered by the probe's warranty.
- Check if the maximum deflection of the tip is 90° to 120° upward, 60° to 90° downwards and 30° to 45° left/right. If the deflection shows an unwanted amount of free play or exceeds the maximal deflection angles given above, do not use the probe. Contact the service organization to re-adjust the steering of the probe. In this way, the risk of "buckling" or "U- turning" of the probe in the esophagus is minimized.
- Avoid damage to the probe by allowing nothing to protrude beyond the case when closing the lid.
- Prior to cleaning any device, turn off the system and disconnect power cord from AC power source to avoid electrical shock.
- Always use protective eyewear and clothing when cleaning or disinfecting the transducers.
- Do not allow the disinfectant to come in contact with metal surfaces (transducer connector). Use a soft cloth and warm soapy water to remove any disinfectant that remains on metal surfaces.
- Keep the control handle and transducer connector out of any cleaning or disinfection solutions. The control handle and cable may be cleaned with a damp cloth, but only the distal end of the probe up to the 100cm marker on the shaft may be placed into a disinfection solution.
- Do not use other disinfection methods like Iodine, Steam, Heat or Ethylene Oxide.
- When servicing the z.one pro System, always be sure to turn the circuit breaker to the OFF position.

Precautions

- The A2CW and A5CW transducers are enabled if the system is configured with either the Echocardiography or the Advanced Vascular Imaging Feature Sets. Attempting to use any other transducers will result in an error message.
- Be aware of the potential hazards associated with the environment where the ultrasound systems will be used. The systems and/or the external equipment can be damaged if signal levels are not appropriate. If peripheral equipment not specifically authorized by Mindray is to be connected to the system, it must meet all applicable electrical safety standards that apply to the system in order to maintain safety integrity. Any equipment not supplied by Mindray must be approved by Mindray.
- Use of non-Mindray-approved equipment may result in an unsafe condition, impair operation of the ultrasound system, impair diagnostic capabilities, and void your warranty or service contract coverage.
- Compatible transducers have a specific range of acceptable application use. Users are advised to restrict each transducer's use to those applications. Excessive bending, twisting, pulling, dragging, or compression of transducer cables may cause failure or intermittent operation of the system.
- Avoid rolling the cart wheels over cables. Use of cable hooks is recommended to minimize chance of damage to cables.
- If a transducer that has not been approved and licensed for use with the ultrasound system to

which it is connected, or if a licensed transducer is not properly connected, the corresponding transducer identification data will not display on the LCD Display. Imaging will be disabled. Resolve this issue before continuing use.

- The ultrasound system and/or the transducer could be damaged if an unapproved transducer is connected.
- Improper cleaning or disinfection of patient applied parts may cause permanent damage.
- Carefully review the manufacturer's directions for any component used with the ultrasound system. Mindray assumes no liability with respect to single-use devices that are reused, reprocessed, or resterilized and makes no warranties, expressed or implied (including the warranties of merchantability or fitness for a particular use), with respect to such devices.
- Use of peripherals or other equipment not provided by Mindray may result in system damage or degraded performance. Carefully review the labeling of any such equipment before connecting to the ultrasound system.
- Improper setting of imaging controls may obscure diagnostically valuable information in the display. The factory default preset maps were preselected as appropriate for most imaging circumstances. Improper user configuration of custom presets may obscure diagnostically valuable information.
- Mindray ultrasound system is manufactured in compliance with existing electromagnetic immunity (EMI) and electromagnetic compatibility (EMC) requirements. Use of the systems in the presence of an electromagnetic field can cause degradation of the ultrasound image.
- Electrostatic discharge (ESD), or static shock, is a naturally occurring phenomenon. ESD is common in low humidity, which can be caused by heating or air conditioning. ESD shock occurs when electrical energy is discharged from one body, to a differently charged body. To lessen the occurrence of ESD, use antistatic spray on carpets and flooring, and antistatic mats.
- To minimize potential ESD damage and electrical contact contamination, avoid touching the metal contacts for the transducer connections, at both the z.one pro port and the transducer connector.
- If the z.one pro System has been moved between environments with extremes of temperature and/or humidity, allow the z.one pro System to rest for at least 30 minutes in a controlled environment before using.
- Do not use the ultrasound system if any error message displays on the screen.
- Do not block airflow to any ventilation holes on the system.
- Do not submerge the transducer past the points indicated in 'Transducers Cleaning and Disinfection' accompanied with the transducer.
- Do not spill liquid on the systems or transducers.
- Using a non-recommended cleaning or disinfectant solution, incorrect solution strength, or immersing the transducer deeper or longer than indicated can damage the transducer. Damages linked to the use of disapproved chemicals are not covered under product warranty or service contract.
- The use of non-shielded cables may result in increased emissions and decreased immunity to external signals
- Operating the systems in the presence of external electromagnetic fields can degrade the quality of the ultrasound image. High-frequency devices, such as electro-surgical devices, can produce image artifacts. If required, a review of the local electromagnetic environment may be required to minimize the sources of external noise generators.
- The use of non-Mindray approved cables and accessories may result in increased radiated emissions as well as decreased immunity to external signal fields.
- Before beginning to image a new patient, be sure to conclude any in-progress patient exam. Failure to do so will result in any subsequent storing of images being mistakenly written to the

previous patient exam directory.

- Some components or devices such as transducer covers used with systems are for single-patient use only. Reuse, reprocessing, or re-sterilization of these devices may compromise their structural integrity.
- Any image sets stored on the system that are not identified by patient name and number will be stored with a unique number based off of the system ID.
- Exercise care in adjusting all settings to avoid obscuring low-level signals that may have diagnostic value. Improper settings can seriously degrade image quality.
- Do not touch exposed metal of transducer connector.
- Validate all entries in the Measurement Summary.
- Ultrasound imaging capabilities can vary from patient to patient. Ultrasound should be used as one component in a comprehensive diagnostic plan.
- Never leave a probe in the disinfection solution for more than 45 minutes. Please refer to the instructions for use that came with the disinfectant for minimal required exposure times. Do not forget to rinse the probe directly after disinfection.
- Only use water-soluble acoustic coupling gel. Other coupling gels can cause probe damage.
- Long-term exposure to ultrasound should be minimized. Although there have been no confirmed adverse effects produced by diagnostic levels of ultrasound, unnecessary patient exposure to ultrasound energy should be avoided, especially in the Doppler mode.
- Use of a non-compatible USB thumb drive may result in file corruption or long file transfer times.
- Please confirm proper operation of any thumb drive prior to attempting to use for clinical data.
- Make sure the z.one pro System has fully completed downloading upgrades, importing/exporting, or collecting log data to the USB thumb drive before removing it from the z.one pro System. Failure to do so will result in loss of data.
- Before deleting any Exam data from the z.one pro System, always verify that data was successfully transferred to USB thumb drive by viewing it on an external reader/player. Review the user maintenance section of the instructions for use for proper technique and approved agents for cleaning the external surfaces of the system.
- Review the z.one pro DICOM conformance statement before integrating with any PACS system.
- Validate Structured Report export prior to clinical use.
- Use-time from the optional z.one pro battery pack will vary depending on the system usage and battery conditioning. Ensure the battery is adequately charged before starting a procedure without AC main power.
- Export patient studies in a timely manner. Do not use the system storage as the sole location of patient studies for an extended period of time.
- Total Recall data (TRI) should not be relied on for primary storage of diagnostic data. Use of Total Recall data across software versions is not guaranteed.
- The system is not indicated for differentiation between malignant and benign breast lesions.

Precautions – TEE Transducer

- TEE: Perform an electrical leakage test prior to each use of the transducer. See the TEE Maintenance Guide or the TEE Leakage Test Quick Reference Guide for details.
- TEE: Examine the transducer prior to each use. See the TEE Maintenance Guide or the

TEE Quick Reference Guide for details.

- TEE: Clean and disinfect after each use.
- TEE: Always use a bite guard.
- TEE: Always use single-use probe sheath.
- TEE: Ensure articulation locks are disengaged and straighten mechanism during device insertion or extraction from patient.
- TEE: Remove the transducer from the patient prior to defibrillation.
- TEE: Handle with care, very delicate instrument.
- TEE: Do not store the disinfected transducer in the carrying case. Only use the case for transportation.
- TEE transducer is a delicate medical instrument, handle with care.
- The multiplane TEE probe is a precision instrument, which must be handled with care. It may be damaged when dropped or abused. In particular, do not allow the ultrasonic window in the tip to come into contact with a sharp object. Do not touch this window unnecessarily. Never exert force onto the acoustic window.
- The transducer connector is not watertight, and should always be kept dry. The control handle, although spray-watertight, should not be immersed.
- This equipment contains no operator serviceable components. To prevent electric shock, do not remove any covers or panels.
- Never manually deflect the distal tip of the probe; use only the deflection control wheels.
- Do not kink, tightly coil, or apply excessive force on the probe cable or shaft. Insulation failure may result.
- Under normal conditions at full acoustic power the temperature of the tip does not exceed 43°C. Be sure to check at least monthly that the temperature increase of the tip is within limits:
- Connect the probe to the Ultrasound system. Adjust the acoustic power to the highest value possible.
- Select Color Doppler mode.
- Wait for 2 minutes.
- Feel at the distal end of the probe if there is a temperature increase that could be harmful for the patient.
- When a brush is used for cleaning the transducer, use only a soft brush; coarse/stiff- bristle brushes may cause transducer damage
- Keep the control handle and transducer connector out of any cleaning or disinfection solutions.
- The control handle and cable may be cleaned with a damp cloth, but only the distal end of the probe up to the 100cm marker on the shaft may be placed into a disinfection solution.
- During immersion disinfection, never immerse the transducers longer than 45 minutes. Damage may occur to the transducer housing and/or components if disinfection times exceed these recommended limits.

Precautions – Laparoscopic Transducer

- Under normal conditions at full acoustic power the temperature of the tip does not exceed 41°C. Do not use the laparoscopic transducer for a long time. Otherwise the tip temperature might exceed 41°C and could be harmful to the patient.
- If the laparoscopic transducer is in malfunction, press the Freeze key to stop the operation and slowly remove the transducer from the patient. Do not use the transducer until it has

been checked and repaired.

- Before each use, the outer surface of the portions of laparoscopic transducer which are intended to be inserted into a patient should be checked to ensure there are no unintended rough surfaces, sharp edges or protrusions which may cause harm.
- Before each use or after a change of viewing modes / settings, the operator should check to ensure the view observed through the laparoscopic transducer provides a live image (rather than a stored one) and has the correct image orientation.

Precautions – Panoramic (EFOV) Imaging

- Measurements on a panoramic image are limited in accuracy by the acquisition of the image by the user
- Measurements out of plane are potentially less accurate.
- A good B Mode/2D image is important for a high-quality panoramic image.

Precautions – 3D/4D Imaging

- 3D: Measurements out of plane are potentially less accurate due to movement of tissue.
- A good B Mode/2D image is important for a high-quality 3D/4D image.

Precautions - WIRELESS

- WIRELESS: The Mindray Wireless option device is an RF Receiver and Transmitter, operating using industry standard 802.11 b/g protocols. Use of the wireless option, in the presence of other high energy RF radiating devices may interfere with the transmission of data to the network interfaces.
- WIRELESS: The Mindray Wireless option device supports several industry standard security protocols and should be enabled to reduce the chance of patient data, transmitted over the wireless interface from the possible undesired interception of the data.
- WIRELESS: Data transmission and reception rates are limited to by the bandwidth of the user's network infrastructure. A Quality of Service (QOS) level is determined by the number of users on the network, the data being transferred by the users, distance of the ultrasound system to the wireless access point and other factors.

Electrical Safety

- MINDRAY/ZONARE systems meet IEC 60601-1, Class I powered equipment requirements.
- Mindray systems are rated for continuous mode of operation
- The z.one pro ultrasound system complies with the applicable medical equipment requirements published in the European Norm (EN) and International Electronics Consortium (IEC) Harmonized Standards.
- The transducers, when used with the z.one pro system, are certified to be in compliance with IEC 60601-1 as Type BF or Type CF applied patient parts. Each transducer or port is labeled accordingly.

Contrast Imaging

Cardiac rhythm disturbances during perfusion studies using gas ultrasound contrast agents have been observed in the diagnostic range of MI values. See the *Instructions for Use* that came with contrast agent being used for details.

Medical Ultrasound Safety - General

Anyone using the ultrasound system for human exams of any kind should thoroughly

understand the implications of such use. The American Institute of Ultrasound in Medicine (AIUM) has published a document titled Medical Ultrasound Safety (AIUM 1994). ALARA is an abbreviation for the principle of prudent use of diagnostic ultrasound by obtaining the diagnostic information at a power output that is as low as reasonably achievable.

Diagnostic ultrasound is a technique-dependent imaging modality. To obtain the best possible patient care from any ultrasound equipment, the system must be operated by personnel trained in ultrasound image acquisition and interpretation. Users must become familiar with each of their imaging systems.

- Always make sure appropriate transducer is used for study being performed
- Always make sure active preset is appropriate for study being performed
- Know how to recognize acoustic artifacts in image
- Consult AIUM recommended protocols & equipment specifications.

17. Acoustic Output

This section describes acoustic-output-related parameters and considers the relation between these parameters and user controls on the systems. The display accuracy and measurements precision of these parameters is also discussed.

Detailed information on acoustical power output for each transducer, in each operating modality, is in the dedicated table provided in Acoustic Power Manual.

Acoustical power output is dependent on both system control settings and the probe selected.

ALARA Principle

The prudent use of ultrasound requires a constant consideration of the risk-benefit ratio for the patient, along with employment of the ALARA principle. ALARA stands for as low as reasonably achievable. ALARA means that the sonographer uses only a much ultrasonic power for as long as needed to obtain the necessary clinical information. With training, education, and experience, the sonographer can systematically keep the patient risk for potential bioeffects of ultrasound to a minimum. ALARA is the guiding principle for the use of diagnostic ultrasound. Qualified sonographers, using good judgment and insight, determine the exposure that is as low as reasonably achievable. There are no rules to determine the correct response to every situation.

The sonographer keeps exposure low, bioeffects minimal, and images diagnostic. A thorough knowledge of the imaging modes, probes, system, and scanning techniques for this system is necessary.

The acoustic output of the ultrasound system has been measured and calculated per the Acoustic Output Measurement Standard for Acoustic Output Measurement Standard for Diagnostic Ultrasound Equipment, Revision 3 (NEMA, UD 2) and the Standard for Real-Time Display of Thermal and Mechanical Acoustic Output Indices on Diagnostic Ultrasound Equipment, Revision 2 (NEMA UD3).

Applying ALARA

The scanner-imaging mode is selected by the sonographer and is determined by what information is required. For example, 2D imaging provides anatomical information. Understanding the nature of the imaging mode being used allows a trained sonographer to apply the ALARA principle.

With training, education, and experience, the sonographer can systematically keep the patient risks for potential bioeffects of ultrasound down to a minimum. This means using ultrasound as an effective and often essential source of diagnostic information and not as a source of entertainment.

For information about ALARA and possible bioeffects, refer to the Medical Ultrasound Safety z.one pro Instructions

brochure developed by the American Institute of Ultrasound in Medicine (AIUM) and supplied with ultrasound systems.

Direct Controls

Per Track 3, the ultrasound system control acoustic output to not exceed a mechanical index (MI) level of 1.9, and $I_{SPTA,3}$ of 720 mW/cm² or a thermal index (TI) value of 6.0.

The systems' factory-set defaults, which are user adjustable, are such that when changing from one preset to another, one transducer to another, or a non-fetal to a fetal application, the system selects default MI & $I_{SPTA,3}$ values that are significantly lower than 60601-2-37, Medical Electrical Equipment Part 2-37: Particular Requirements for the Safety of Ultrasonic Medical Diagnostic and Monitoring Equipment and the United States Food and Drug Administration's Guidance Document, *"Information for Manufacturers Seeking Marketing Clearance of Diagnostic Ultrasound Systems and Transducers"* limits.

The thermal index that is displayed (TIS, TIB, TIC) is based on the selected application. The system acoustic output display and controls follow the *"Standard for Real-Time Display of Thermal and Mechanical Acoustic Output Indices on Diagnostic Ultrasound Equipment, Revision 2"* (NEMA UD3).

Indirect Controls

The controls that indirectly affect output are controls affecting the imaging mode, optimization, probe selection, and depth. The imaging mode determines the nature of the ultrasound beam. Tissue attenuation is directly related to transducer frequency. The higher the pulse repetition frequency (PRF), the more output pulses occur over a period of time.

Receiver Controls

The receiver controls (such as **Gain**, **Dynamic Range**, etc.) do not affect acoustic output. Use the receiver controls to improve the image quality before using controls that directly or indirectly affect output.

General Controls

Transducer: Each transducer has different physical characteristic and acoustic response to transmit voltages. Differences include size and shape, center frequency, piezo-electric efficiency, and focus properties of the lens. Changing from one transducer model to another will change the acoustic output and therefore the displayed mechanical index and thermal index values.

Mode: Changing from one mode to another will affect the acoustic output. Different modes use different transmit waveforms, focusing, duty cycles, and pulsing sequences. Doppler modes tend to have higher duty cycles, and therefore higher TI values, than B and M modes. Modes using the tightest focusing will tend to have higher MI values.

Defaults: Default settings exist and are accessed whenever a transducer and mode combination is selected. Although the acoustic output associated with these defaults may differ from combination to combination, the default acoustic output is lower than 60601-2-37, Medical Electrical Equipment Part 2-37: Particular Requirements for the Safety of Ultrasonic

Medical Diagnostic and Monitoring Equipment and the United States Food and Drug Administration's Guidance Document, "Information for Manufacturers Seeking Marketing Clearance of Diagnostic Ultrasound Systems and Transducers" limits..

Transmit Power: Transmit power controls the transmit voltage, and therefore the amplitude of the transmitted ultrasonic waves. Both the TI and the MI will change when Transmit power (A Output) is adjusted.

Automatic Limiting: For any adjustment described in the mode-specific section below, when a user adjustment of an ultrasound system control causes the MI, TI, or any other acoustic output or surface-temperature related parameter to reach a system control limit, the ultrasound system will automatically decrease the transmit voltage, causing a decrease in one or more of those parameters.

B-Mode Controls

Image Width: Narrowing the image width may increase the frame rate, which may increase the TI.

Depth: Decreasing the depth may increase the frame rate, which may increase the TI.
Operating Frequency: Changing the operating frequency will affect the displayed MI and TI values as the beam formation is affected and transducer efficiencies may differ between frequencies.

Frame Rate: A lower frame rate may decrease the TI; however, due to an increase in the Image Width, the TI stays roughly constant if the systems transmit pulse repetition stays constant.

Zoom: Increasing or decreasing the zoom may affect the frame rate, which may increase or decrease the TI.

Image Presets: Changing the image presets may indirectly change the acoustic line spacing or the frame rate, which could change the TI values. An increasing spacing may decrease the TI, and an increasing frame rate may increase the TI.

M-Mode Controls

Depth: Decreasing the depth may increase the frame rate, which may increase the TI.

Operating Frequency: Changing the operating frequency will affect the displayed MI and TI values as the beam formation is affected and transducer efficiencies may differ between frequencies.

Image Presets: Changing the image presets may indirectly change the acoustic line spacing or the frame rate, which could change the TI values. An increasing spacing may

decrease the TI, and an increasing frame rate may increase the TI.

Color Doppler Controls

Image Width: Narrowing the image width may increase the frame rate, which may increase the TI.

Velocity Scale: Increasing the Velocity scale may increase the TI by increasing the pulse repetition frequency.

Color ROI Size and Position: A narrower Color Region of Interest (ROI) may increase the frame rate, which may increase the TI. A longer Color ROI, or a deeper Color ROI, may decrease the pulse repetition frequency and decrease the TI.

Operating Frequency: Changing the operating frequency will affect both the displayed MI and TI values because the beam formation is affected and transducer efficiencies may differ between frequencies.

Combinational with B-Mode: Use of combination modes affects the TI and the MI through the combination of pulse types. Because the TI is additive, simultaneous pulsing of B and COLOR modes will cause larger TI values than sequential pulsing (e.g. auto-update). The displayed MI will be from the pulses with the largest peak pressure.

Image Presets: Changing the image presets may indirectly change the color sensitivity. Increasing the sensitivity could increase the TI values.

Color Doppler Triplex Controls

Image Width: Narrowing the image width may increase the frame rate, which may increase the TI.

Velocity Scale: Increasing the Velocity scale may increase the TI by increasing the pulse repetition frequency.

Color ROI Size and Position: A narrower Color Region of Interest (ROI) may increase the frame rate, which may increase the TI. A longer Color ROI, or a deeper Color ROI, may decrease the pulse repetition frequency and decrease TI.

PW Gate Size: A smaller PW Gate size may increase the allowable pulse repetition frequency and may increase TI.

PW Gate Position: A shallower PW Gate position may increase the allowable pulse repetition frequency and may increase the TI.

Operating Frequency: Changing the operating frequency will affect both the displayed MI and TI values because the beam formation is affected and transducer efficiencies may differ between frequencies.

Combinational with B, COLOR and PW: Use of combination modes affects the TI and MI through the combination of pulse types. Because the TI is additive, simultaneous pulsing of B, COLOR and PW modes may cause larger TI values than sequential pulsing (e.g. auto-update). The displayed MI will be from the pulses with the largest peak pressure.

Image Presets: Changing the image presets may indirectly change the PW and/or color sensitivity. Increasing the sensitivity could increase the TI values.

PW Doppler Controls

Velocity Scale: Increasing the Velocity scale may increase the TI by increasing the pulse repetition frequency.

PW Gate Size: A smaller PW Gate size may increase the allowable pulse repetition frequency which may increase TI.

PW Gate Position: A shallower PW Gate position may increase the allowable pulse repetition frequency and may increase TI.

Operating Frequency: Changing the operating frequency will affect both the displayed MI and TI values because the beam formation is affected and transducer efficiencies may differ between frequencies.

Combinational with B-Mode: Use of combination modes affects the TI and MI through the combination of pulse types. Because the TI is additive, simultaneous pulsing of B and PW modes may cause larger TI values than sequential pulsing (e.g. auto-update). The displayed MI will be from the pulses with the largest peak pressure.

Image Presets: Changing the image presets may indirectly change the PW sensitivity. Increasing the sensitivity could increase the TI values.

CW Doppler Controls

CW Gate Position: Changes in the CW Gate position may change the MI or TI.

Operating Frequency: Changing the operating frequency will affect both the displayed MI and TI values because the beam formation is affected and transducer efficiencies may differ between frequencies.

Image Presets: Changing the image presets may indirectly change the CW sensitivity. Increasing the sensitivity could change the TI values.

18. Display Accuracy and Precision

The output display indices are calculated with the accuracy described below. Also listed is the precision of the displays. A discussion of the accuracy statements follows their specification.

Thermal Index Display Accuracy and Precision

It is estimated that 90% of TI values will be $\pm 45\%$ of the displayed TI value or ± 0.15 of the displayed value, whichever value is larger. This is approximately ± 2 dB. The TI is displayed with a precision of 0.1. A displayed value of 0.0 for TI means that the calculated value is less than 0.05.

Mechanical Index Display Accuracy and Precision

It is estimated that 90% of MI values will be within $\pm 25\%$ of the displayed value, or ± 0.15 of the displayed MI value, whichever value is larger. This is approximately ± 2 dB. The MI is displayed with a precision of 0.1.

Discussion of Display Accuracy

The stated display accuracy values are determined relative to the MI and TI models, equations, and measurement methods specified in the *"Standard for Real-Time Display of Thermal and Mechanical Acoustic Output Indices on Diagnostic Ultrasound Equipment, Revision 2"* (NEMA UD3). The TI and MI are relative indicators for the likelihood of tissue thermal rise and mechanical bioeffects, respectively. The accuracy statements listed here are not bound on the deviation of the displayed indices from actual temperature rise or pressure levels in the body.

The TI and MI values are determined from measurements in water and derated for tissue attenuation using an assumed homogenous tissue model with attenuation of 0.3 dB/cm/MHz and the sound propagation properties of water. Most tissues attenuate ultrasound at a greater rate. Fluids such as amniotic fluid attenuate less. In addition, the propagation of ultrasound is a nonlinear one in most cases, to different degrees in water and various tissues, with varying resultant effects on actual MI or TI values. The MI is a relative indicator for the likelihood of a mechanical bioeffect, such as cavitation, and its model assumes the presence of nucleation sites needed for cavitation. The TI models assume a blood perfusion length of 1 cm. Tissue perfusion lengths and rates are dependent on vasculature and blood flow and the thermal properties of the surrounding tissue, which vary greatly. The bone TI derivation assumes all ultrasound energy is absorbed by the impinged bone.

The accuracy estimates stated are based on the variability in acoustic output of probes and systems, uncertainties in measurements made per the AIUM / NEMA standards, and uncertainties or approximations introduced in implementing the MI and TI algorithms in system software. They are not based on errors in the AIUM/NEMA MI or TI models, errors introduced by the measurement standards, differences between actual tissue paths and properties and those of water, or the effects of nonlinear propagation on the measured values.

Measurement Uncertainty of Acoustic Output Values

The measurement uncertainty of quantities are listed in the table below. They are measured as part of determining MI or TI values. Quantities are listed as one standard deviation, in

percentage.

Measurement Uncertainty

| Parameter | Description | Uncertainty |
|----------------------------------|---|------------------|
| Pulse Intensity Integral (PII) | Energy density (mJoules/cm ²) in an ultrasonic pressure wave. Used in TI, Ispta.0, and Ispta.3 determination. | +20.4% -26.5% |
| Peak Rarefactional Pressure (Pr) | Largest pressure amplitude (MPa) of the negative pressure. Used in MI determination. | +11.7% -13.2% |
| Acoustic Power (W) | Time-average acoustic power in an ultrasonic beam. Influenced by pressure wave amplitude and length, as well as pulse repetition frequency. Used in TI determination. | +/-10% |
| Center Frequency (Fc) | Center frequency (MHz) of an ultrasonic pressure wave. Used in TI and MI determination. | +/- 2% |

19. Guidance Documents

Medical Ultrasound Safety. American Institute of Ultrasound in Medical (AIUM), 1994.

NEMA UD 2, Acoustic Output Measurement Standard for Diagnostic Ultrasound Equipment, Revision 3. National Electrical Manufacturers Association, American Institute of Ultrasound in Medicine, 2004.

Acoustic Output Measurement and Labeling Standard for Diagnostic Ultrasound Equipment. American Institute of Ultrasound in Medical (AIUM), January 1998.

NEMA UD 3. Standard for Real-Time Display of Thermal and Mechanical Acoustic Output Indices on Diagnostic Ultrasound Equipment, Revision 2. National Electrical Manufacturers Association, American Institute of Ultrasound in Medicine, 2004.

20. Standards and Compliance

The z.one pro system has been designed, manufactured, tested, and certified to comply with the following internationally recognized standards:

IEC 60601-1: 2012: Medical electrical equipment part 1: General requirements for basic safety and essential performance.

IEC 60601-1-2: 2014: Medical electrical equipment part 1-2: General requirements for basic safety and essential performance. Collateral standard: Electromagnetic disturbances - Requirements and tests.

IEC 60601-2-37: 2015: Medical electrical equipment Part 2-37: Particular requirements for the basic safety and essential performance of ultrasonic medical diagnostic and monitoring equipment issued by IEC in 2015.

The system complies with the EMC standard IEC 60601-1-2: 2014.

Intended Environments:

Professional healthcare facility environment.

- WARNING:**
1. The use of unapproved accessories may diminish system performance.
 2. Use of components, accessories, probes, and cables other than those specified may result in increased emission or decreased immunity of system.
 3. Operation of system, in the case that the patient physiological signal is lower than the minimum amplitude or value specified in the product specifications, results may not be obtained (results can be obtained when the HR is in the range of 30-250 bmp or when the QRS wave amplitude is between 0.5-5 mV.)
 4. Use of this equipment adjacent to or stacked with other equipment should be avoided because it could result in improper operation. If such use is necessary, this equipment and the other equipment should be observed to verify that they are operating normally.
 5. Use of accessories, transducers and cables other than those specified or provided by the manufacturer of this equipment could result in increased electromagnetic emissions or decreased electromagnetic immunity of this equipment and result in improper operation.
 6. Portable RF communications equipment (including peripherals such as antenna cables and external antennas) should be used no closer than 30 cm (12 inches) to any part of the system, including cables specified by the manufacturer. Otherwise, degradation of the performance of this equipment could result.

- NOTE:**
- 1 The system needs special precautions regarding EMC and needs to be installed and put into service according to the EMC information provided below.
 - 2 Other devices may interfere with this system even though they meet the requirements of **CISPR**.
 - 3 Preventing conducted RF immunity. Due to technological limitations, the conducted RF immunity level are limited to 3Vrms level, conducted RF interference above 3Vrms may cause wrong diagnosis and measurements. We suggest that you position system further from sources of conducted RF noise.
 - 4 Portable and mobile RF communications equipment can affects system. See tables 1, 2, 3, and 4 below.
 - 5 The EMISSIONS characteristics of this equipment make it suitable for use in industrial areas and hospitals (CISPR 11 class A). If it is used in a residential environment (for which CISPR 11 class B is normally required) this equipment might not offer adequate protection to radio-frequency communication services. The user might need to take mitigation measures, such as relocating or re-orienting the equipment.

If the system is operated within the electromagnetic environment listed in Table 2 and Table 3, the system will remain safe and will provide the following basic performances:

- Imaging;
- Doppler acoustic spectral
- displaying; Taking measurements;
- Patient information;
- Date/time information.

TABLE 1

| GUIDANCE AND MINDRAY DECLARATION—ELECTROMAGNETIC | | |
|---|-------------------|---|
| The system is intended for use in the electromagnetic environment specified below. The | | |
| EMISSIONS TEST | COMPLIANCE | ELECTROMAGNETIC ENVIROMENT - GUIDANCE |
| RF emissions CISPR 11 | Group 1 | The system uses RF energy only for its internal function. Therefore, its RF emissions are very low and are not likely to cause any interference in nearby electronic equipment. |
| RF emissions CISPR 11 | Class A | The system is suitable for use in all establishments including domestic establishments and those directly connected to the public low-voltage power supply network that supplies buildings used for domestic purposes |
| Harmonic Emissions IEC | Class A | |
| Voltage Fluctuations/ Flicker Emissions IEC 61000-3-3 | Compliance | |

TABLE 2

| GUIDANCE AND MINDRAY DECLARATION—ELECTROMAGNETIC | | | |
|---|--|---|--|
| The system is intended for use in the electromagnetic environment specified below. The | | | |
| IMMUNITY TEST | IEC 60601 | COMPLIANCE | ELECTROMAGNETIC ENVIRONMENT- |
| Electrostatic Discharge(ESD) IEC 61000-4-2 | ±8 kV contact; ±15 kV air | ±8 kV contact; ±15kV air | Floors should be wood, concrete or ceramic tile. If floors are covered with synthetic material, the relative humidity should be at least 30%. |
| Electrical fast Transient / burst IEC 61000-4-4 | ±2 kV for power supply lines; ±1 kV for input/output | ±2 kV for power supply lines; ±1 kV for input/output lines | Mains power quality should be that of a typical commercial or hospital environment. |
| Surge IEC 61000-4-5 | ±1 kV line(s) to line(s); ±2 kV line(s) to earth | ±1 kV line(s) to line(s); ±2 kV line(s) to earth | Mains power quality should be that of a typical commercial or hospital environment. |
| Voltage dips, Short interruptions and voltage input voltage IEC 61000-4-11 | 0 % UT; 0,5 cycle At 0°, 45°, 90°, 135°, 180°, 225°, 270° and 0 % UT; 1 cycle 70% UT for 25/30 cycle at 0° 0 % UT; 250/300 | 0 % UT; 0,5 cycle At 0°, 45°, 90°, 135°, 180°, 225°, 270° and 315° 0 % UT; 1 cycle 70% UT for 25/30 cycle at 0° 0 % UT; 250/300 cycle | Mains power quality should be that of a typical commercial or hospital environment. If you continued operation during power mains interruptions, it is recommended that our product be powered from uninterruptible power supply or a battery. |
| Power frequency (50/60 HZ) magnetic field IEC 61000-4-8 | 30 A/m | 30 A/m | Power frequency magnetic fields should be at levels characteristic of a typical location in a typical commercial or hospital environment. |
| NOTE: U_T is the A.C. mains voltage prior to application of the test level. | | | |

TABLE 3

| GUIDANCE AND MINDRAY DECLARATION—ELECTROMAGNETIC | | | |
|---|--|--|---|
| The system is intended for use in the electromagnetic environment specified below. The customer | | | |
| IMMUNITY TEST | IEC 60601 TEST LEVEL | COMPLIANCE LEVEL | ELECTROMAGNETIC ENVIRONMENT-GUIDANCE |
| Conducted RF IEC 61000-4-6 | 3 Vrms 0,15 MHz – 80 MHz 6 Vrms in ISM and amateur radio bands between 0,15 MHz and 80 MHz | 3 Vrms 0,15 MHz – 80 MHz 6 Vrms in ISM and amateur radio bands between 0,15 MHz and 80 MHz | Portable and mobile RF communications equipment should be used no closer to any part of system, including cables, than the recommended separation distance calculated from the equation applicable to the frequency of the transmitter. Recommended separation distance \sqrt{P} $d = 1.2 \times \sqrt{P}$ $d = 1.2 \times \sqrt{P}$ 80 MHz to 800 MHz $d = 2.3 \times \sqrt{P}$ 800 MHz to 2.5GHz Where, P is the maximum output power rating of the transmitter in watts (W) according to the transmitter manufacturer and d is the recommended separation distance in meters (m). Field strengths from fixed RF transmitters, as determined by an electromagnetic site survey, should be less than the compliance level in each frequency range. Interference may occur in the vicinity of equipment marked with the following symbol:  |
| Radiated RF IEC 61000-4-3 | 10 V/m 80MHz - 2.7GHz | 10 V/m 80MHz - 2.7GHz | |
| Proximity fields from RF wireless communication s equipment IEC 61000-4-3 | 27 V/m 380–390 MHz | 27 V/m | |
| | 28 V/m 430–470 MHz, 800–960 MHz, 1700–1990 MHz, 2400–2570 | 28 V/m | |
| | 9 V/m 704–787 MHz, 5100–5800 MHz | 9 V/m | |
| <p>Note 1At 80 MHz and 800 MHz, the higher frequency range applies.</p> <p>Note 2These guidelines may not apply in all situations. Electromagnetic propagation is affected by absorption and reflection from structures, objects and people.</p> <p>a Field strengths from fixed transmitters, such as base stations for radio (cellular /cordless) telephones and land mobile radios, amateur radio, AM and FM radio broadcast and TV broadcast cannot be predicted theoretically with accuracy. To assess the electromagnetic environment due to fixed RF transmitters, an electromagnetic site survey should be considered. If the measured field strength in the location in which system is used exceeds the applicable RF compliance level above, system should be observed to verify normal operation. If abnormal performance is observed, additional measures may be necessary, such as reorienting or relocating the system.</p> <p>b Over the frequency range 150kHz to 80MHz, field strengths should be less than 3V/m.</p> | | | |

TABLE 4

| RECOMMENDED SEPARATION DISTANCES BETWEEN PORTABLE AND MOBILE RF | | | |
|--|--|-----------------------------------|------------------------------------|
| The system is intended for use in an electromagnetic environment in which radiated RF disturbance are controlled. The customer or the user of system can help prevent electromagnetic interference by maintaining a minimum distance between portable and mobile RF communication equipment (transmitters) and system as | | | |
| Rated Maximum Output power of Transmitter (W) | Separation Distance According to Frequency of Transmitter (m) | | |
| | 150kHz -80MHz $d = 1.2\sqrt{P}$ | 80MHz-800MHz $d = 1.2\sqrt{P}$ | 800MHz-2.5GHz $d = 2.3\sqrt{P}$ |
| 0.01 | 0.1 | 0.12 | 0.23 |
| 0.1 | 0.3 | 0.38 | 0.73 |
| 1 | 1.2 | 1.2 | 2.3 |
| 10 | 3.8 | 3.8 | 7.3 |
| 100 | 12 | 12 | 23 |
| <p>For transmitters at a maximum output power not listed above, the recommended separation distanced in meters (m) can be determined using the equation applicable to the frequency of the transmitter, where P is the maximum output power rating of the transmitter in watts (W) according to the transmitter manufacturer.</p> <p>If system image distortion occurs, it may be necessary to position system further from sources of conducted RF noise or to install external power source filter to minimize RF noise to an acceptable level.</p> <p>Note 1At 80 MHz and 800 MHz, the separation distance for the higher frequency range applies.</p> <p>Note 2These guidelines may not apply in all situations. Electromagnetic propagation is affected by absorption and reflection from structures, objects and people.</p> | | | |

Cable sample

| No. | Name | Cable length (m) | Shield or not | Remarks |
|-----|---------------------|------------------|---------------|-----------|
| 1 | Power cable | 2.5 | Not shielded | / |
| 2 | ECG Lead | 4.0 | Shielded | / |
| 3 | Foot-switch control | 2.8 | Shielded | / |
| 4 | Probe cable | <3.0 | Shielded | All probe |
| 5 | SIP/SOP cable | <3.0 | Shielded | / |

21. Product Labeling

Contact Mindray if any of the labels are missing or damaged beyond legibility.

With the ultrasound system, the L10-5 and L14-5sp transducers are classified as Type-CF (Cardiac Floating). All other transducer types are Type-BF (Body Floating). Earlier transducers labeled without these symbols are Type-BF. Type-CF is defined and regulated by International Medical Equipment Safety Standard IEC 60601 as having the most stringent of patient leakage current requirements. This classification is required for intra-operative applications that may contact the heart.

22. Specifications

| Type | Parameter | Value |
|--|--|---|
| Electrical | Power requirements | 100–240V~, 50–60Hz, 6A max |
| Battery | Battery power supply voltage | DC 15.6V (NiMH battery) |
| | Battery capacity | No less than 13000mAh for a single battery (NiMH battery) |
| | The main unit working time when powered by battery | At least 1.5 hours (NiMH battery) |
| | Battery charging time | Less than 6 hours (NiMH battery) |
| Environmental (operating) | Cooling requirements | See power consumption above. |
| | Air temperature | 0–35°C (32–95°F) |
| | Humidity | 15–80%, noncondensing |
| | Pressure | 700–1060 hPa |
| Environmental (storage and transportation) | Air temperature | -20–60°C (-4–140°F) |
| | Humidity | 15–90%, noncondensing |
| | Pressure | 500–1060 hPa |
| Physical (weight) | z.one pro system | ≤79.5Kg (not including probes) |
| Physical (dimensions) | Height, min (display lowered for transport) | 106 cm (42 in.) |
| | Width | 51 cm (20.1 in.) |
| | Depth | 72 cm (28.2 in.) |
| I/O connectors | Ethernet (1 port) | RJ-45 – 10/100BaseT |
| | USB 2.0 (3 ports) | USB-Type A (VBUS 5.0V, 0.5A max) |
| | External Video (1 port) | HDMI 1280x1024 |
| | Serial port | eSATAp |
| Wireless Option | Manufacturer | B&B Electronics / Quatech |

| Type | Parameter | Value |
|-----------------|---|---|
| Wireless Option | Manufacturer PN: | ABDN-ER-DP551U |
| | Wireless Technology | IEEE 802.11a/b/g/n, Wi-Fi compliant |
| | Wired Interface | 10/100 Ethernet port (Bridge, Router (NAT3) Modes) |
| | Frequency | DSSS, CCK, OFDM |
| | Modulation Technology | DSSS, CCK, OFDM |
| | Modulation Type | DBPSK, DQPSK, CCK, BPSK, QPSK, 16QAM, 64QAM |
| | Network Access Modes | Infrastructure, Ad Hoc |
| | Channels | US/Canada: 11 Channels 802.11b/g 13 Channels 802.11a Europe: 13 Channels 802.11b/g 19 Channels 802.11a France: 4 Channels |
| | Wireless Data Rate | 802.11b = 11, 5.5, 2, 1 Mbps 802.11a/g = 54, 48, 36, 24, 18, 12, 9, 6 Mbps 802.11n = 65, 58.5, 42, 39, 26, 19.5, 13, 6.5 Mbps |
| | MAC | CSMA/CA with ACK, RTS, CTS |
| | Network Protocols | TCP/IP, ARP, ICMP, DHCP, DHS, UDAP, TFTP, UDP, PING |
| | Receive Sensitivity 802.11b/g | 54Mb/s = -72 dBm 36Mb/s = -78 dBm 18Mb/s = -84 dBm 6Mb/s = -89 dBm 11Mb/s = -86 dBm 1Mb/s = -92 dBm |
| | Receive Sensitivity 802.11 a | 54Mb/s = -74 dBm 36Mb/s = -80 dBm 18Mb/s = -86 dBm 6Mb/s = -90 dBm |
| Transmit Power | 802.11b 15 dBm (31.6mW) 802.11g 12.6dBm (18.12mW) 802.11a 17 dBm (50.1mW) | |

| Type | Parameter | Value |
|--|------------------------|---|
| Wireless Option | Wireless Security | Disabled, WEP 64 & 128bit, WPA (TKIP), WPA (AES), WPA2 (AES), 802.1x (EAP) Supplicant 802.11i, WPA & WPA2 Enterprise supplicants (EAP-TLS, EAP-TTLS (MSCHAPv2), EAPTTLS (MDS5), EAP- PEAPv0 (MSCHAPv2, LEAP), EAP-FAST, LEAP) Supports Certificates and Private Key Upload and Storage (Multiple) |
| | Antenna | Integrated RP-SMA Omni-directional 2dBi 2.4/5 GHz AntennaABDG-BR-DP501, Client Bridge ABDG-ET-DP501, NAT 3 Router |
| | Regulatory Compliance | North America: FCC Title 47 Part 15 Class B Sub C Intentional Radiator, IOC RSS210 Europe: CE ETSI EN300 328 RoHS & WEEE compliant Worldwide Certificate Support- FCC Part 15 Class B Sub C Modular Approval, IOC, CE, ETSI EN300 328, ETSI 60950-1, ROHS and WEEE Compliant |
| Operating Environment (minimum requirements) | Hardware Configuration | CPU: MCU ARM-A9 1.2GHz; Hardware: 128G SSD; Display: Size: 17 Inches |
| | Software Environment | Operating System: Linux 4.9 Network Condition: 10M/100M adaption Wireless network: Protocol compatible with IEEE 802.11 a/b/g/n standard Working frequency: 2.4G/5G Data security/Encryption mode: WEP, WPA, WPA2 |
| Off-the-Shelf Software | Operating System | Linux Version/Kernel Version: 4.9 Supplier: Open Source Operating Environment: Linux |

| | | |
|--|----------------------|--|
| | Database | Sqlite Database Version/Kernel Version: 3.6.16 Supplier: Open Source Operating Environment: Linux |
| | Cyber Security | ClamAV Version/Kernel Version: 0.97 Supplier: Open Source Operating Environment: Linux |
| | Application Software | OpenConnect Version/Kernel Version: 3.2 Supplier: Open Source Operating Environment: Linux Supplier: Open Source |

