

Volume VIII, Feb 2024

mindfocus

Healthcare technology for a better tomorrow

Tele ICUs

Reducing cost burden for critical care

Guinness World Record

Mindray Teams Up with NH Hospital

Nuewa I9

Inspiring Women's Healthcare

Power of AI

The Potential of AI in Healthcare

IRIA Initiative

Future of Preventive Radiology

**Ultrasound
Today Is The New
Stethoscope**

mindray
healthcare within reach

Dr. Chander Lulla
Radiologist,
RIA Clinic, Mumbai
Ex-INSUOG Ambassador



Explore the Journey Empowered by M-Connect IT Solution

Mindray M-Connect IT solution offers a universally connected platform for real-time patient data integration, analysis, reporting, and storage. Drawing upon Mindray's vast product portfolios of patient monitoring and life support devices, the dedicated solution sets new standards of clinical information integration and systemic interoperability, allowing clinicians to have timely responses and informed decision-making from anywhere.

m-CONNECT

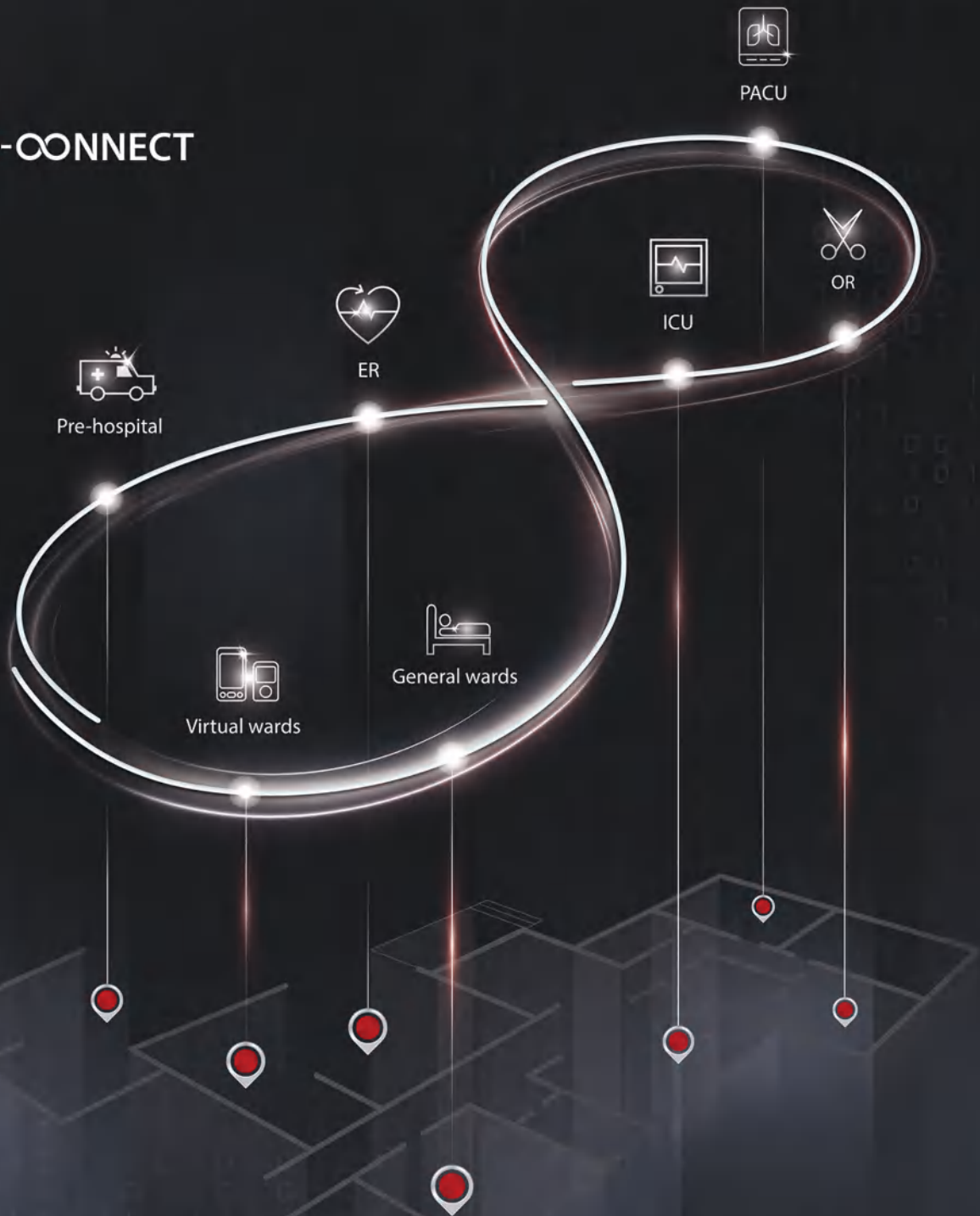

Content



06 **Mindray's advanced ultrasound solutions at Matrix Scan Centre**

10 **Cover Story:**
Ultrasound today is the new stethoscope
Dr. Chander Lulla

18 **Understanding the future of preventive radiology**

23 **Resona club meeting**

24 **Nuewa I9:**
Mindray's latest ultrasound system to inspire women's healthcare

28 **Reducing cost burden for critical care with Tele-ICU's**
Dr. Sandeep Deewan

32 **Power of artificial intelligence in hospitals and healthcare**
Mr. Abdullah Saleem

38 **Mindray india unveils cutting-edge uMEC series patient monitors at ISACON 2023**

40 **Making every heartbeat count!**
Mindray India and Narayana Health team up for a Guinness World Record

42 **CUBE-HDMI 2023**

44 **Parameters for females with primary hypothyroidism**
Dr. Pooja Devi

50 **Digital morphology: Revolutionising hematology**
Dr. Anil Handoo

53 **Mindray's commitment to a healthier Bharat: Advancing ultrasound technology in India**
Mr. Ashwani Raina



Steven Mou

Managing Director
Mindray Medical India Pvt. Ltd.

“

IN INDIA, MINDRAY CURRENTLY HOLDS MARKET SHARE LEADERSHIP POSITIONS IN SEVERAL SEGMENTS, INCLUDING ULTRASOUND IMAGING DEVICES, ANAESTHESIA WORKSTATIONS, HAEMATOLOGY, VENTILATORS, DEFIBRILLATORS, AND PATIENT MONITORING DEVICES

”

Mindray: Keeping our commitment to a Healthier Bharat

Dear Readers,

Let me start by expressing my gratitude to all of you for your incredible response to the previous editions of our **MindFocus** magazine. We are both grateful and fortunate to have such a large following of devoted readers who constantly motivate us to work more and achieve better in the healthcare industry.

With huge support and motivation, Mindray, in recent times, has been able to establish a significant presence in India. We are committed to advancements in the areas of in-vitro diagnostics, medical imaging systems, and patient monitoring and life support. The fact that many healthcare organisations in the country utilise our healthcare equipment and medical solutions, gives us greater confidence to keep on supporting healthcare providers in India to give quality care and help build a more reliable and sound healthcare infrastructure in the country.

With the unwavering confidence that many healthcare providers have placed in us, we continue to expand the Mindray brand in India with our well-thought-out concepts and top-notch solutions.

The road to exploration

Innovation has been rooted in Mindray's blood since the company was founded, as we believe that it is the key to make the best of healthcare accessible to all. In the era of medical transformation, we never stop exploring opportunities to advance new technology, adapt new management styles and exchange new thoughts. By doing this, we empower healthcare professionals to deliver better care to patients with ease.

Mindray, with its extensive experience spanning more than 30 years, is constantly supporting healthcare professionals in India as well.

In 2006, Mindray began to mark its direct presence in India. Today, we have significantly expanded our business, increased the size of our team by more than five times, established a vast distribution network, and earned the respect and trust of our customers.

Mindray possesses a sound global R&D, marketing and service network. Inspired by the needs of our customers, we adopt advanced technologies and transform them into accessible innovation, bringing healthcare within reach. While improving the quality of care, we help reduce its cost, making it more accessible to a larger part of humanity.

Assisting all the way

Mindray closely integrates innovation with clinical scenarios to assist medical establishments in providing high-quality medical services, assisting in the amelioration of medical conditions, and also lowering global medical costs. Since a number of leading Indian medical institutions have now partnered with Mindray for a long time, we hope to address the needs of the healthcare providers, so that they are able to provide better healthcare to their patients. As a total medical solution provider, Mindray will continue delivering products and services that really meet customer needs.

Our promise

We will continue to support Indian healthcare professionals by offering world-class solutions that is easy to use. At Mindray, our commitment, along with the seamless and genuine efforts, will surely help us to expand our growth in India at an incredible rate as a brand, and we will soon be able to become a top-notch partner for transforming the healthcare landscape in India and help the healthcare givers as their trusted partner for building a healthier Bharat.

Once again, I appreciate your unwavering support.

Be safe and healthy!

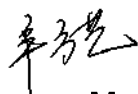

Steven Mou

Managing Director

Mindray Medical India Pvt. Ltd.

Mindray's Advanced Ultrasound Solutions at Matrix Scan Centre



In a pioneering move towards enhancing diagnostic capabilities, Matrix Scan Centre in Nashik has successfully integrated Mindray's cutting-edge ultrasound products – Resona I9, Nuewa I9, and MX7. This strategic installation under the visionary leadership of Dr. Lalesh Nahata, a seasoned radiologist with 20 years of experience, marks a significant milestone in the centre's commitment to delivering superior healthcare services.

The inauguration ceremony brought together senior radiologists across Nashik fostering an environment of knowledge exchange and collaboration. As the machines were unveiled, they garnered high praise from all attending doctors. The advanced features and innovative technologies of the ultrasound systems were particularly appreciated, setting an optimistic tone for the transformative impact they are expected to have on diagnostic capabilities at Matrix Scan Centre.



**WE BELIEVE THAT
THESE CUTTING-EDGE
ULTRASOUND
TECHNOLOGIES WILL
EMPOWER US TO PROVIDE
UNPARALLELED
DIAGNOSTIC PRECISION
AND DELIVER BETTER
PATIENT OUTCOMES.**



-Dr. Lalesh Nahata, Matrix Scan Centre



About Matrix Scan Centre

Matrix Scan Centre, a well-established diagnostic centre in Nashik, is renowned for offering a comprehensive range of services, including USG, CT, MRI, CBCT, Mammography, and BMD facilities, all under one roof. The centre has gained a reputation for providing high-quality services to patients, and the recent acquisition of Mindray's state-of-the-art ultrasound systems further solidifies its commitment to excellence.

Resona I9: Ultrasound Reimagined

The Resona I9, a general imaging ultrasound system, stands out for its revolutionary features designed to transform the conventional ultrasound experience. ZONE Sonography® Technology+ (ZST+) powers this system, ensuring a harmonious balance of spatial, temporal resolution and tissue uniformity further providing very advanced applications such as SWE & CEUS. What sets Resona I9 apart is its usability and ergonomics, providing a user experience that is unparalleled in the industry.

The Resona I9 system goes beyond traditional ultrasound capabilities, incorporating artificial intelligence (AI)-enhanced technologies. These advancements not only improve reproducibility but also optimize productivity and enhance consistency for end-users. Driven by innovation in every facet, the Resona I9 is poised to revolutionize diagnostic imaging at Matrix Scan Centre, offering accurate and timely answers to complex clinical scenarios.

Nuewa I9: Dedicated to Women and Neonatal Healthcare

Mindray's Nuewa I9 powered by ZST+ technology takes a dedicated approach to women and neonatal healthcare, offering an innovative experience that addresses the unique challenges in these clinical scenarios. Developed with insights into complex clinical situations, especially for anomaly study. Under "Full Stack & Smart solution", it



provides AI-based intelligent workflow for precise imaging at reduced scan time enabling high diagnostic confidence at better patient comfort. The Nuewa I9 provides accurate and timely answers, ensuring efficiency and a remarkable user experience.

The specialized features of Nuewa I9 make it an invaluable addition to Matrix Scan Centre's services. Dr. Lalesh Nahata and his team can now leverage the system's capabilities to enhance their diagnostic precision in women's health and neonatal care, contributing to improved patient outcomes.

MX7: Precision Diagnosis during Emergencies

The MX7 ultrasound system, with its leading-edge ZST+ platform, empowers Matrix Scan Centre with accurate diagnoses and efficient workflow. The customizable touch screen, ultra-light main unit, and an impressive 8-hour battery time make it suitable for any mobile clinical environment.

The Matrix Scan Centre in Nashik is strategically leveraging the MX7 ultrasound system to enhance its capabilities in handling emergencies. The heightened mobility and versatility of MX-7 will empower the healthcare professionals at Matrix Scan Centre to deliver prompt and effective care to patients in critical situations, further solidifying the MX7 as an invaluable asset for emergency diagnostics at the facility.

In conclusion, the successful installation of Mindray India's Resona I9, Nuewa I9, and MX7 ultrasound products at Matrix Scan Centre has not only marked the introduction of cutting-edge technology but also symbolized a commitment to deliver better patient outcomes.



Resona I9

Diagnostic Ultrasound System

mindray

Innovation, in every facet

Infinite imaging solutions



ABD

HIFR STE for liver stiffness quantification
Smart HRI for easy assessment of liver steatosis



Vascular

V Flow for complex hemodynamics evaluation
Precise hardness analysis of carotid wall



Small parts

Smart and accurate breast/thyroid lesion analysis
Complete elastography solution



Cardiology

Auto EF for easy cardiac function evaluation
Quantitative evaluation of myocardial movement



MSK

Elastography for tendon stiffness assessment
CPP for flow analysis of rheumatic arthritis



Urology

Superior image with bi-plane transducer
UWN[®] CEUS for prostate cancer diagnosis

23.8" bezel-less full screen
15.6" touchscreen with intuitive interaction

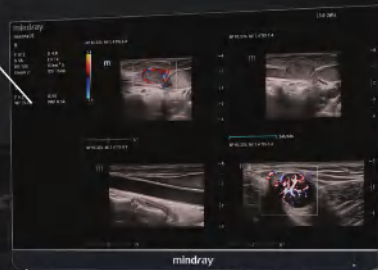

Powered by **ZST+**

iConsole: intelligent control panel
Full-space floating adjustment



26dB super-silent design
Long-life battery with auto indication
Just fold and go with min 1 meter height



“

ULTRASOUND
TODAY IS
**THE NEW
STETHOSCOPE**

”

- DR. CHANDER LULLA

Dr. Chander Lulla is one of the most prominent radiologists in Mumbai and has more than 35 years of experience in this field. Dr. Chander Lulla practices at Ria-Clinic in Gamdevi, Mumbai. He completed MBBS from the University Of Bombay in 1984 and MD - Radio Diagnosis/Radiology from the University Of Bombay in 1988. He also completed several trainings including colour doppler USG from Guys Hospital, UK, Foetal Interventions from Kings College, UK , 3D Ultrasonography in 1999 from Seoul, Korea, 3D VISUS course from Vienna, Austria, and Foetal Medicine Foundation course from Sydney, Australia.

In this interview with Mindray India, Dr. Chander Lulla discusses the evolution of the ultrasound field, his experience with the Resona I9 ultrasound system and much more.

1. You have more than 3 decades of experience as a radiologist. Can you please share the technological revolutions in the ultrasound field that you have witnessed?

In the last three decades of my experience, I have seen almost mind-boggling changes in ultrasound.

We started with basic portable small ultrasound machines, which used to be carried from one place to the other in the year 1987. Then, the mainframe machines were launched in the 1990s with colour, and doppler. It was one of the biggest game changers in ultrasound filed as blood flow was visible without placing the needle and injecting contrast. When I showed my first images of colour doppler at a conference during that period, people couldn't believe that we can see blood flow without doing an angiography.

There were a lot of questions raised regarding the efficacy of the technology vis-a-vis angiography and others. Today, we can see that no ultrasound machine is complete without a stellar doppler component. Then in the year 1998, 3-D ultrasound created a revolution wherein we could see the baby's face and the entire foetus in three dimensions.

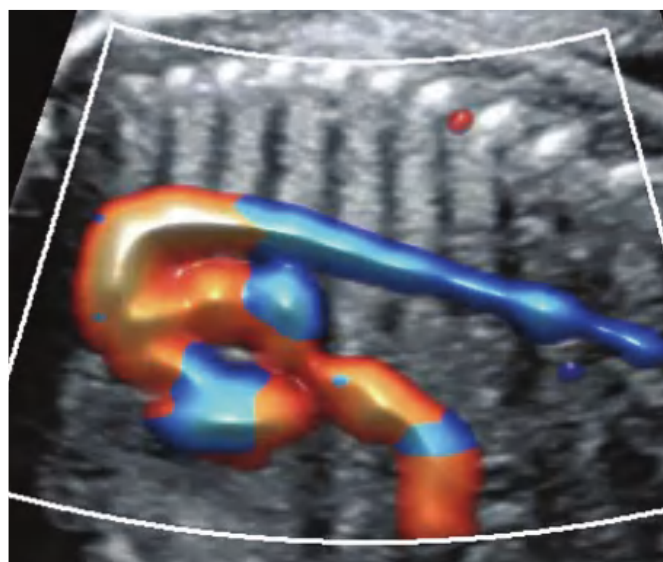

Apart from that, we had multiplanar imaging that allowed us a great spatial orientation of different pathologies in the foetus or in the uterus. We could plan our interventional procedures or other procedures in a multiplanar format or in any plane instead of X, Y, and Z planes, we could rotate the volume into any plane.



Then the other significant development was, of course, elastography, which has been there from time immemorial. But with 2D shear wave elastography, we could do simultaneous imaging of the pathology and get shear wave measurements. So, this was very targeted, focused, and accurate, and we had a lot of quality checks that were possible.

2. Which features of Resona I9 have helped you in your practice?

Resona I9 has been helping me in the clinical management of my patients.

Smart Pelvic use to diagnose Pelvic floor abnormalities:

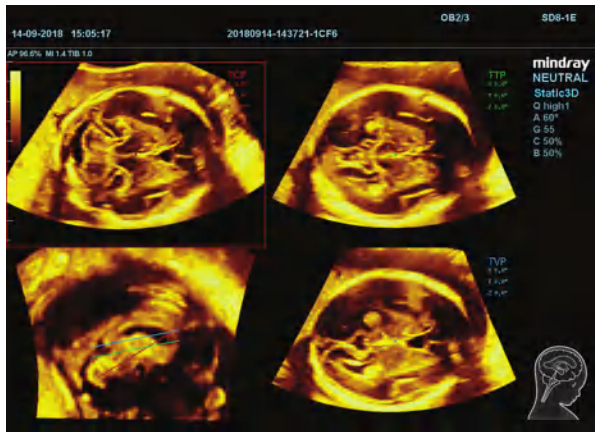

Smart ICV:

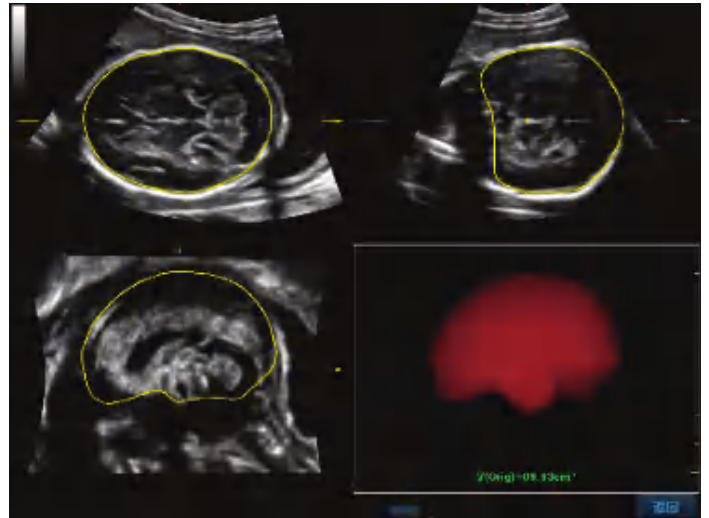

i) Resolution

The most important thing for any ultrasound solution machine is the resolution and Resona I9 provides excellent and rapid spatial and contrast resolution. It doesn't require focus zones and grants a complete harmonic and uniform image from the skin to a great depth.

We had a patient with a mass in his tongue and we performed sonography of the tongue using Resona I9. Because of the high resolution of Resona I9, we could see flow in the patient's mass lesions because of microvascular imaging. The advanced elastography techniques using Resona I9 revealed that it could be a cystic mass



and that the lesions had a small nodule. This degree of resolution was only possible due to the 23-megahertz transducer. Thanks to this new technology and high resolution, we can now obtain the same resolution for patients with high BMI as for patients with less BMI.

Without Resona I9, patients would need a CT scan or MRI for more clarity.

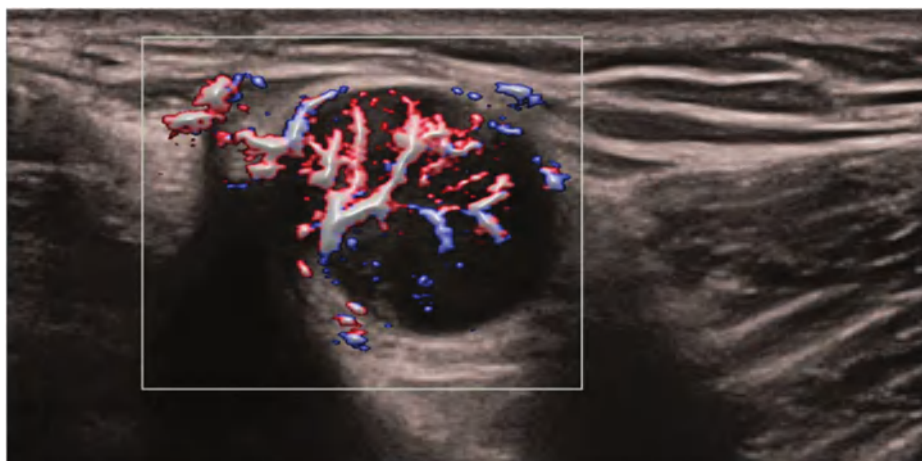

ii) Ergonomics

Musculoskeletal problems are very common in radiologists due to the high-volume work and ergonomics. Resona I9 has been designed keeping ergonomics in mind and has helped me easily perform interventional procedures. It has a full-space floating control panel that can be rotated in 360-degree fashion. The transducer connections are on the posterior side of the panel making it easy to be changed and the bottle warmer helps to make the patients feel more comfortable during the scan.

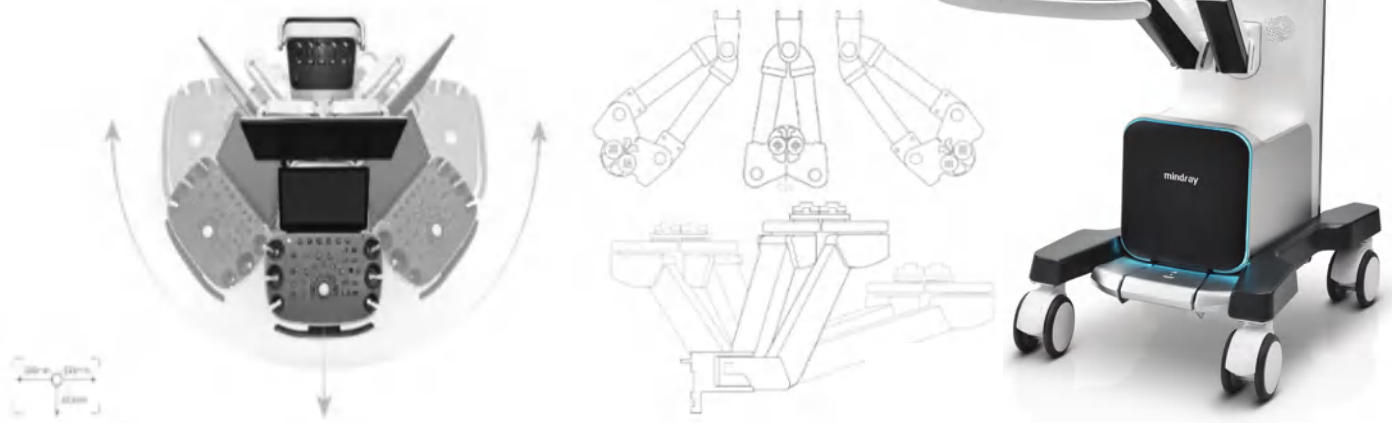

iii) Artificial intelligence

The artificial intelligence incorporated in Resona I9 enhances the workflow to a great extent and allows me to attend to my patients faster. Apart from that, it has innovative methods of calculation which is astounding as manual calculations are no longer required. For example, we can acquire the rapid volume of the brain in the foetus with ventriculomegaly. With just one touch of a button, we can get all the different planes and the measurements appear automatically. The BP, the head circumference around the cerebellar diameter, lateral ventricle diameter, brain volume, etc. can be seen very accurately.

I have been practising for the past 30 years and I have gone through all the changes in ultrasound from Basic B mode ultrasound in the 1990s. Then we started doing colour Doppler in 91, 3D technology in 98, and Elastography in 2010. And now we have excellent AI-based technology where I don't have to physically measure so many parameters and even the basic parameters as it is all done by the machine.

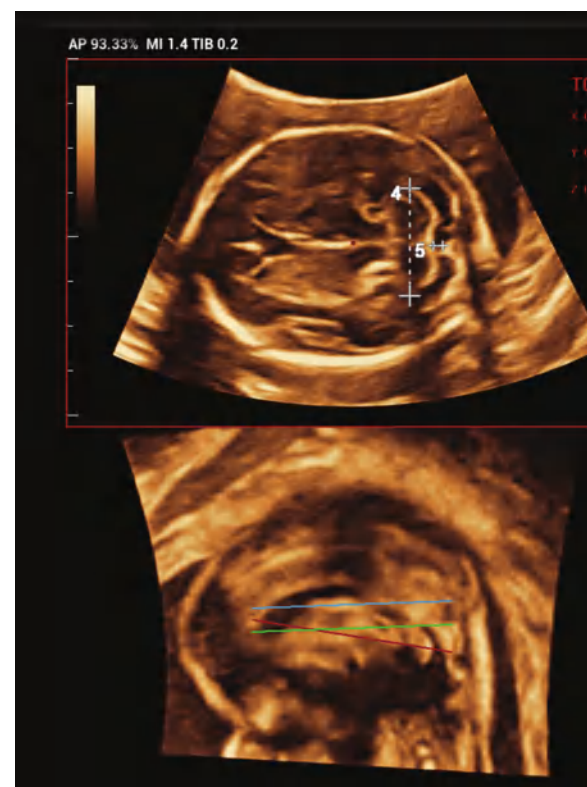

So, it can be used for follicle monitoring, dynamic endometrial volume monitoring, and prostate monitoring on the volume transducer. We also have the biplane transrectal transducer, which is extremely beneficial for visualizing the prostate in two planes and allows me to do a great fusion biopsy. Apart from that, we have



something called tissue tracking quantitative analysis for foetal echocardiography, where it give us a functional analysis of the foetal heart in terms of ejection fraction, and the fractional lung volume, fractional volumes of the different chambers of the heart, and the cardiac output. Smart Pelvic imaging gives us all the various dimensions of the pelvic floor at rest, and it will tell us to see pelvic floor pathologies. It is also very useful for us for the paediatric hip ultrasound to give us all the angles. So, wherever you need measurements, the machine will do it for you automatically.

The 3D rendering of this machine has a very advantageous feature like detecting the surface that is being scanned and switched to the appropriate pre-set without the need to change it manually. It saves a lot of time and is clinically beneficial.

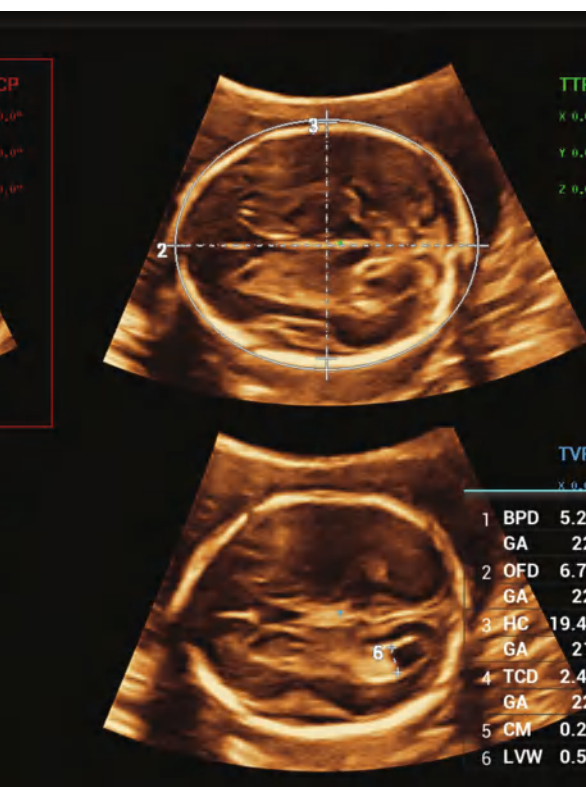

From the point of view of shear wave elastography, it has the highest frame rates and quality control features MSTB & Reliability Map & Index has improved accuracy & reliable values which are repeatable has made SWE very useful especially for liver imaging.

3. What are your views on the implementation of Artificial Intelligence in ultrasonography?

I think artificial intelligence is the final frontier of all imaging modalities. It is extremely beneficial for radiologists, and we welcome it with open arms.

The AI-based ultrasound machines can do multiple things with more precision than any human will ever do. The calculations are so accurate that it saves a lot of time.

Also, I think artificial intelligence is very useful in the future by fusing different technologies like CT and ultrasound because there are times when we need all three technologies together, especially when we're doing interventional procedures.



4. What is your message to the upcoming radiologists?

Radiology is at the forefront of clinical medicine today. As I said earlier, every patient management starts with a radiological procedure, and you need to be extremely proficient in these technologies. Because we are a very important beginning point of how pathologies are managed today, you need to focus on one aspect of radiology, either cross-sectional imaging or obstetric imaging or women's imaging, or neuroimaging.

So, the degree of specialization is very high today as compared to what we had in the earlier days. And we need to be very focused and keep learning all the new technologies and keep updating ourselves so that the patients can get extreme benefits. So very exciting times for radiologists and I think that's why also it is the most preferred super specialty today once the students pass out the MBBS, there are also a lot of people who do seek radiology, and for good reason.

“

ULTRASOUND IMAGING IS A FAST-ADVANCING MODALITY IN NEW SPECIALITIES SUCH AS

FETAL ECHOCARDIOGRAPHY, FETAL NEURO- SONOGRAPHY, AND IN-UTERO FETAL PROCEDURES.

”

”

5. Ultrasound has gained recognition as a valuable diagnostic tool in resource-limited settings like the remote parts of India where diagnostic tools are limited. Is it a sustainable method for clinical management and patient outcomes in such scenarios?

Yeah. So today I think the world over people called ultrasound and the new stethoscope.

There is no clinical management possible without an ultrasound. In fact, I'm surprised when I receive calls from doctors referring their patients with abdominal pain or other GI pathology for an ultrasound. Ultrasound has become the primary modality of diagnosis. Sometimes, even before the blood tests are done, doctors refer patients for an ultrasound. This has been a game changer for trauma patients, patients with acute pain, thrombosis, stroke patients, or patients with the embolic phenomenon in the extremities.

When a patient comes with sudden bleeding, ectopic pregnancy, or with loss of movement for the foetus, we need to see whether the baby is having good blood supply, is alive, and does not have any other problems. So, I think it's a complete revolution. Today, ultrasound is the new stethoscope, and no clinician can function today without the ultrasound.

Understanding the future of preventive radiology



mindray

National Launch of IRIA Preventive Radiology



What the
next 20 years
might have in store?

A unique initiative from IRIA for developing algorithms to diagnose diseases earlier using Imaging Biomarkers

India is witnessing Non-Alcoholic Fatty Liver Disease (NAFLD) and Non-Alcoholic Steato Hepatitis (NASH) as the two major problems, with NAFLD becoming endemic in the country. The disease is far more prevalent than one thinks it is. Being the most common form of fatty liver disease, it can happen without causing any symptoms. Hence, it is crucial to make people aware of the disease and its impact, diagnosis, treatment, and prevention.

Enhancing skills of Radiologists to diagnose fatty liver diseases at an early stage is the need of the hour. "If that does not happen, 20 years down the line, we will have to train our surgeons for more liver transplants, which will become a huge healthcare burden to the nation," opines Dr. Rijo Mathew, National Coordinator, Preventive Radiology, Indian Radiological and Imaging Association (IRIA).

IRIA, in this regard, has signed an agreement with Mindray India under the title "The diagnostic effectiveness of the new generation ZST Technology-based HFR SWE with M-STB & RLB Map on Resona series for liver elastography" – with its

motto "Building Healthier Bharat" – to transform the diagnosis and treatment for NAFLD and reduce its burden in India. The agreement is for two years with 10 multi-center studies on Mindray Resona Series and 12 workshops in different cities.

By the end of the collaboration period, a preventive radiology group headed by Dr Mathew, National Coordinator for Preventive Radiology, IRIA; and Dr. Rajas Chaubal, National Clinical lead and MD, PG Dip MUS-UCAM, Director, Thane Ultrasound Center, Mindray, with a team of radiologists will publish a research article, along with a policy document, that will be presented to the Government of India.

Dr Mathew states that preventive radiology is going to play a significant role, especially for the non-communicable diseases, which are increasing in great numbers in India.

"There are more than 20,000 radiologists in India in the IRIA. One of our primary aims is to enhance the skill of our radiologists. With the help of these radiological modalities, especially in case of fatty liver, we train them to do the live elastography, which helps them to quantify liver fibrosis



PREVENTIVE RADIOLOGY IS A NEW AREA THAT IRIA INTENDS TO EXPLORE IN THE CONTEMPORARY REALM OF PREVENTIVE MEDICINE – A FOCUS THAT WE WOULD LIKE TO GIVE ON THE EARLY DETECTION OF DISEASES WITH THE HELP OF IMAGING BIOMARKERS AND THE STRATEGY OF RISK STRATIFICATION.



Dr. Rijo Mathew
National Coordinator for
Preventive Radiology, IRIA

radiologists can help diagnose those high-risk groups, which can go in for fibrosis, help them to decrease the severity of their disease and bring them to a normal state. There is a reversible process at this point of time, that's why I always say 20 years down the line, radiologists, if you are not using this opportunity, the only way for the country, the medical system, or the healthcare system of this country is, to enhance the skills of surgeons to do as many liver transplants as possible. So, skill enhancement is an integral part of this programme. Further, we want to do a multi-centric research study with the help of industry. That is why Mindray has partnered with IRIA for this particular project. We want the data from our patient population (1.4 billion people from India) because the standardization has to come from this population rather from the Caucasian population or from the Chinese population. The Indian population data has to be collected, and we are looking into multi-centric studies. We have already initiated, and Mindray has supported IRIA in that initiative. We already have 20 participating centres across the country that have joined this study and the skill enhancement program."

For the research, Dr. Mathew's and Dr. Chaubal's teams look forward to collecting data and implementing it in such a fashion that it becomes relevant for India's local population, and this may even vary from north India to south India, from the east to the west, as the country has a whole lot of diversity. His current focus is to standardize the procedure in which measurements are taken. Mindray is playing a huge role in this regard by enhancing the skills of radiologists and training them.

Imaging – an integral part of the



Dr. Rajas Chaubal
National Clinical lead and MD,
PG Dip MUS-UCAM, Director,
Thane Ultrasound Centre



PEOPLE WHO ARE ACTUALLY WALKING INTO OUR OPD, PROBABLY DON'T KNOW THEY HAVE A FATTY LIVER, AND WE ARE THE FIRST ONES TO REALLY IDENTIFY IT AND FLAG IT TO THEM. THAT IS WHERE OUR ROLE INTENSIFIES BECAUSE IF YOU ARE THE FIRST ONE TO SEE THE PATIENT, YOU ARE ABLE TO DETECT IT AND COUNSEL THE PATIENTS. THAT WILL GO A LONG WAY AHEAD IN MANAGING THE PATIENTS AND PREVENT WORSENING OF ANY SITUATION.



screening and management of several public health conditions – has become an important tool in the diagnosis and management of diseases. Today's modern imaging techniques enable healthcare practitioners to evaluate the health of patients at stages that were previously thought impossible. Rapid advancements in medical imaging modalities have resulted in better visualization of structures, to diagnose at early stage and pre-empt complication and further by reducing turnaround times using improved algorithms that provide better interpretations.

Dr. Chaubal emphasises, “Ultrasound really has really good penetration through the length and breadth of this country. It's very easily accessible to a whole lot of patients and a whole lot of population and we also end up seeing a lot of patients for preventive health checkups, especially in the metro cities. We have a huge number of patients. People who are actually walking into our OPD, probably don't know they have a fatty liver, and we are the first ones to really identify it and flag it up to them. That is where our role intensifies because if you are the first one to see the patient, you are able to detect it and counsel the patients. That will go a long way ahead in managing the patients and prevent worsening of any situation.

“While we have been restricted to what we call as a visual scaling of visual analysis on ultrasound, what I may see as an individual may be different, or what I interpret rather as one person maybe different from what the second or the third person interprets, but now we are moving into functional imaging as well where we are able to get actual functional values. We have elastography measurements, attenuation values,



MC Ekambaram
Deputy Director - Marketing,
Ultrasound Division,
Mindray India



WE HAVE BEEN WAITING TO WORK WITH IRIA IN INDIA TO DEVELOP SPECIFIC PROTOCOLS, WHICH WILL NOT ONLY HELP A GROUP OF PATIENTS BUT, ON A LARGE SCALE, WE CAN PROBABLY FOCUS ON A PARTICULAR DISEASE WHERE WE COULD ESTABLISH OR STUDY VALUES FOR ACCURACY AND REPEATABILITY FROM THE INDIAN PROSPECTIVE.



which was not possible till some time back. So, now, we are getting more and more functional data which is independent of how I see it or how a second or third person sees it. However, the skill enhancement of the whole team of radiologists is important, because all of us need to be on the same page.”

Dr. Mathew mentions, “Preventive radiology is a new area that IRIA intends to explore in the new inventive medicine – a focus that we would like to give on early detection of diseases with the help of imaging biomarkers and the strategy of risk stratification. We would like to focus on four areas primarily: (a) NAFLD and NASH, (b) Risk stratification of coronary artery disease and vascular health, (c) Cancer screening with a multi-modality approach, and (d) Screening with imaging biomarkers for diseases like Chronic Kidney Disease (CKD), Chronic Liver Disease (CLD), chronic heart disease, etc. For this, we have partnered with Mindray for a multi-centric study on their sonography technology for the quantification of liver fibrosis. There will be a skill enhancement program in 12 states in India, which will be carried out in the next two years.”

Shedding more light on the Mindray-IRIA collaboration, MC Ekambaram, Deputy Director - Marketing, Ultrasound Division, Mindray India, informs, “We have been waiting to work with IRIA in India to develop certain protocols, which will

not only help a group of patients, but, on a large scale, we can probably focus a particular disease where we could establish or study values for accuracy and repeatability from the Indian perspective. The way Mindray has been progressing for some time in the last particularly five-to-six years, it's important for us to have an association with the strong bodies around the world, including IRIA in India to work together for a better mankind. It's a collaboration of physicians and engineers together to make something possible. So, we, at Mindray are looking forward to this next couple of years, and beyond.”

With its clear aim, Mindray will spare no effort to be a trusted partner in building a healthier Bharat – and will support and help the healthcare community in the country to grow stronger by deepening its technological capabilities.

Dr Mathew further states that preventive radiology is going to play a significant role to especially the non-communicable diseases, which are increasing in great numbers in India.

Resona Club Meeting

Advancing Healthcare with Ultrasound

Mindray India proudly orchestrated the Resona Club Meeting, a congregation of the foremost minds in the ultrasound imaging field driven by a collective dedication to advancing healthcare through ultrasound technology. This event unfolded as a day of profound insights, innovation, and inspiration, setting the stage for transformative advancements in some specialised applications including fetal anomaly, gynaecology breast /thyroid, liver/breast/thyroid elastography, MSK intervention in the realm of ultrasound imaging.

The Resona Club Meeting featured compelling lectures by industry stalwarts, offering invaluable perspectives on the latest developments in ultrasound technology. From impactful presentations, and live workshops to engaging discussions,



the two-day event was a comprehensive exploration of the evolving landscape of ultrasound imaging in advanced application.

With a remarkable attendance of over 250 delegates, the event provided an exceptional opportunity for professionals to connect, collaborate, and network with the best in the business. Beyond the exchange of knowledge, the Resona Club Meeting was a great platform to forge meaningful connections and foster a community committed to pushing the boundaries of healthcare excellence.



Nuewa I9: Mindray's latest ultrasound system to inspire women's healthcare



*THE NUEWA I9,
DEDICATEDLY DESIGNED
FOR WOMEN AND
NEONATAL HEALTHCARE,
PROVIDES AN INNOVATIVE
EXPERIENCE FROM INSIDE
OUT*

After the successful launch of Resona I9, Mindray, a global leading developer and provider of medical devices and solutions, has introduced Nuewa I9, the latest cart-based premium ultrasound system and tailored solution for Obstetrics and Gynaecology (OB/GYN). Committed to inspiring women's healthcare, Mindray's Nuewa I9 elevates scanning to new levels through revolutionary ZST+ platform elevating ultrasound IQ to higher level and provides excellent balance for spatial and temporal resolution and tissue uniformity.

The Nuewa I9, dedicatedly designed for women and neonatal healthcare, provides an innovative experience from inside out. These innovations are developed based on in-depth insights into complex clinical scenarios, providing accurate and timely answers as well as outstanding efficiency and remarkable user experience.

Nuewa I9 offers an unrivalled ultrasound scanning experience in its class. Each feature and innovation have been deliberately designed to address the daily challenges of OB/GYN clinicians. The result is a full-stack smart solution for extraordinarily efficient care, which covers the entire continuum from pre-pregnancy to obstetrics and post-partum. Nuewa I9 boasts an innovative design for the ultimate convenience. Its foldable height and compact body allow the system to easily pass-through doors for quick access across departments. In addition, its breakthrough



exam-specific iConsole control panel is optimized to adapt to different clinical scenarios, and its E-ink keys customized for the most frequently used functions, bring all new workflow experience maintaining speed and high diagnostic confidence.

Nuewa I9 is also packed with automated tools to improve workflow and efficiency in women's and neonatal care, such as Smart-V Trace, Smart Pelvic, and Smart Hip. Besides, one of the biggest innovations featured in Mindray's Nuewa I9 is Smart Scene

3D, a scenario-oriented volume scan technique that enables the automatic identification of tissue characteristics and provides an organ-specific diagnosis. Starting from auto clinical scenario identification, harnessing automation at every point from imaging optimization to plane acquisition, quantification, and the creation of an automated workflow, the technology supports the whole examination procedure. As a result, Nuewa I9 alleviates the workload of manual operation; reduces scanning time for individual patients; and delivers a truly easy, accurate and fast diagnosis.

Further, with reduced knob adjustments, Nuewa I9 also makes 3D/4D interactions extremely intuitive. And, for this, clinicians need only to click and choose their desired effect for different application scenarios, such as Routine, iLive, Bone, Tissue, and Follicle.

Apart from it, preset imaging settings have also been integrated into the system for optimal volume imaging effects, and support ease of use in every possible clinical scenario for OB/GYN.

Nuewa I9 provides full-stack smart solution for extraordinarily efficient women and neonatal care. It covers the continuum from pre-pregnancy, obstetrics to post-partum. The whole exam procedure becomes an automated workflow: it starts by identifying the automatic clinical application scenario, and uses automation at every exam point, such as imaging optimization, plane acquisition, and quantification.

Mindray, with its innovative solutions like Nuewa I9, continues to support the healthcare community towards the path of higher diagnostic confidence even in the most difficult cases, enhanced workflow with reduced scan time, bringing better outcomes for making a healthier world.



NUEWA I9 BOASTS INNOVATIVE DESIGN POWERED BY ZST+ PLATFORM FOR HIGH DIAGNOSTIC CONFIDENCE WITH THE BEST-IN-CLASS USER EXPERIENCE. ITS FOLDABLE HEIGHT AND COMPACT BODY ALLOW THE SYSTEM TO EASILY PASS THROUGH DOORS FOR QUICK ACCESS ACROSS DEPARTMENTS



Nuewa I9

Diagnostic Ultrasound System

Innovation, in every facet

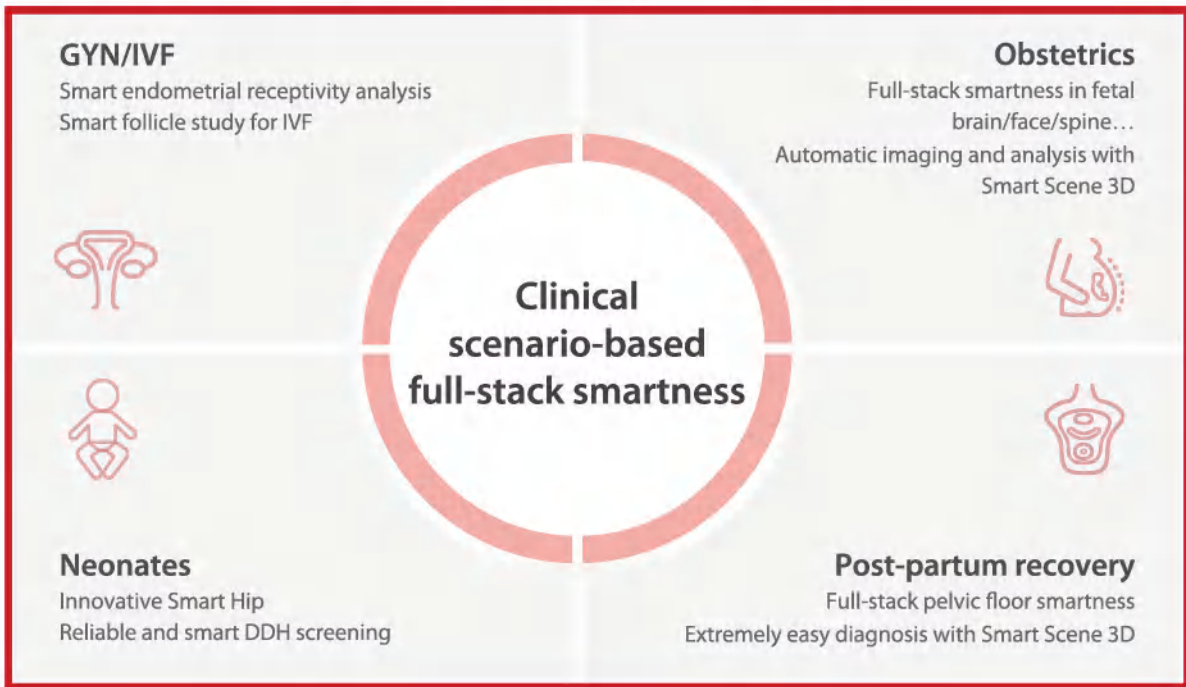



Reducing cost burden for critical care with Tele ICUs



Dr. Sandeep Deewan,
CEO, eNext ICU

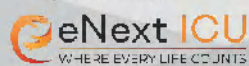

Way back in 1999, when we started our critical care journey, there was only one department in the whole of North India. However, critical care has made a major impact across the country; more so after COVID, because many people were primarily looking for two things at that time: ICUs and critical care doctors; that's when they actually got to know what a critical care expert is.

Today, ICUs are coming at a very fast pace in the private as well as the government sector. However, the number of critical care physicians is actually extremely short. Since it's a small and young speciality, one can't create a critical care physician in a year or so. It takes at least three years of training and three years of experience to become a consultant. Therefore, digitalization of ICUs is bringing e-ICU/ tele-ICU to the fore in today's era. Furthermore, critical care requires a lot of training. We need to train a lot of



INDIA CONTRIBUTES TO 18 PERCENT OF THE WORLDWIDE MORTALITY. WE ARE THE TRAUMA CAPITAL OF THE WORLD, THE DIABETES CAPITAL OF THE WORLD – **PRIMARY ARTERY DISEASE THAT'S MUCH MORE IN INDIA THAN ANYWHERE WORLDWIDE,** AND HEART DISEASE IN INDIA OCCURRED 10 YEARS EARLIER AS COMPARED TO THE POPULATION IN EUROPE AND AMERICA



young doctors since everybody cannot do a fellowship in critical care. Hence, for somebody in deeper parts of the country, we have our own simulation-based training vertical, where we have already trained about 10,000 doctors and nurses in the last five years. In the basics of critical care medicine at this point of time, we are close to monitoring experience of 1,000 ICU beds with the tele ICUs.

We are a team of critical care specialists, physicians, technicians, nurses and paramedics staff, who are continuously monitoring patients in India and abroad. We can manage emergencies as well as the ward patients as that's the beauty of telemedicine – it's critical care sans barriers.

Disease burden in India

India contributes to 18 percent of the worldwide mortality. We are the trauma capital of the world, the diabetes capital of the world – primary artery disease that's much more in India than anywhere worldwide, and heart disease in India occurred 10 years earlier as compared to the population in Europe and America. As we are advancing and ageing, we are living more with comorbidities, but are also learning more with complications.

Post-Independence, the average lifespan of an Indian was 47 years. Today, it is 73 years. So, if people are living till 73 years of age, they will live with more heart diseases, more diabetes, more infections and more problems. That's how a lot of morbidity in the world is contributed by India.

Prior to the COVID-19 pandemic, we spent only one percent of the Gross Domestic Product (GDP) towards our healthcare investment. Post-COVID, it has actually gone to 2.3-2.4 percent, but is still much less. During COVID, we were faced with unprecedented massive load of patients. A lot of patients required ventilators, and there was a huge shortage of ICU beds, but the governments and the private sector actually started making ICU beds at a rapid pace, which came up as a huge relief.



A CONNECTED WORKFLOW HELPS ANALYZE AND PRIORITIZE PATIENTS FASTER, THAT ELIMINATES PRESSURE ON BUSY CLINICIANS AND EMERGENCY MEDICAL PERSONNEL, IN ORDER TO REDUCE THE RISK FOR PATIENTS AND SAVING THEIR LIVES.



Challenges and opportunities

Skilled manpower in the form of trained doctors and nurses is the biggest challenge in critical care. Digitalization and innovations like tele ICUs can go a long way in solving many such problems. In ICUs, an intensivist relies a lot on life-saving alarms and early warning signals. Through digitalization and tele ICUs, a remotely situated critical care specialist can monitor and give junior doctors and nurses a lot of advice in managing critical care patients. This not only improves the quality of care, but has also been proven to decrease mortality. I can envisage that most of the critical care units in tier-II and tier-III cities will be managing their patients via digitalization or tele ICUs in the near future.

A connected workflow helps analyze and prioritize patients faster, which eliminates pressure on busy clinicians and emergency medical personnel, in order to reduce the risk for patients and saving their lives.

Tele ICU has an off-site command centre where a critical care team communicates with



patients in distant ICUs using real-time audio-visual and electronic means, and exchanges health information. This is the cost-effective remote way to provide services to all types of locations. It makes it possible for patients and critical care specialists in the ICU to be face to face within minutes, and for administrations to receive medical attention easily and quickly. Tele ICU programmes have command centres that are staffed with critical care nurses and intensivists who treat patients electronically either with the help of audio connections or video conferences. This allows healthcare professionals to get patient data in real time and resolve issues as soon as possible. Tele ICU has become a way to augment limited resources and use them to save lives every day. It provides patients with flexible and round-the clock access to critical care specialists. In addition to consultation and

“
**TELE ICU SOLUTIONS HAVE
 THE POTENTIAL TO
 SIGNIFICANTLY REDUCE
 THE COST OF
 PROVIDING
 HEALTHCARE TO THOSE
 WHO ARE IN NEED.**
 ”

acute patient management, there are daily rounds where intensivists help guide daily activities and plans for tele ICU patients. Intensivists are generally very experienced in determining criticality of patients' conditions, which is greatly aided by access to vital information provided by the current technology using tele-ICU equipment. This significantly reduces the ICU complications.

Years back, when telemedicine wasn't there, people from remote areas used to struggle as they had to travel far for getting medical treatment. However, now, with the help of telemedicine, patients can stay in their peripheral sites and get treated over there only. Tele ICU solutions have the potential to significantly reduce the cost of providing healthcare to those who are in need. As a result, hospitals can generate significantly more revenue by simply monitoring critically ill patients to a network of remote intensivists and the critical care teams. Thus, telemedicine not only allows doctors to reach more patients, but also saves the hospital cost resulting in better patient care.



POWER OF **ARTIFICIAL INTELLIGENCE** IN HOSPITALS AND HEALTHCARE



How has AI transformed healthcare delivery? What are some of the notable use cases that you recall?

An artificial intelligence (AI) system defeated elite doctors in China in a two-round brain tumour diagnosis competition. AI was correct 87% of the time and took about 15 minutes to diagnose 225 cases in the first round while the doctors achieved 66 percent accuracy in 30 minutes, in the second round AI made correct predictions in 83% of brain hematoma expansion cases in just 3 minutes surpassing the 63% accuracy of a group of physicians, who took 20 minutes. Researchers fed the AI system with thousands of images of nervous system-related diseases. Down the line, the EMR / EHR /PHR would be developed and made to empower the doctors with AI to enable one of the best OPTION impacting everything from patient experience to



Abdullah Saleem
Group CIO-
Incor Omni Hospitals



diagnostics, it would be wondering how long it will be before it's considered incomplete to diagnose a patient's disease without using AI.

What according to you could be the growing potential of AI-based tools for healthcare delivery?

Largely, the AI is going to be embedded in all the clinical pathways to enable a strong clinical application / CDSS which will not be allowing to the treating doctors / treating clinical team to change the content of the treatment by more than 10 to 15 percent at the point of care to deliver the patient care. The AI will also be integrated into runtime with clinical treatment guidelines like NCCN, ESC, ACC, etc to make the most accurate prediction to enable the treatment protocol for the treating doctors / treating clinical team at the point of care. The Artificial (AI) and Predictive Analytics (PA) are the only component which is going to reduce the clinician's involvement to execute the treatment mechanism by 60-70% plus. As far as the potential of AI is concerned, no clinical application would be accepted by healthcare

providers if it has not been made with a deeper AI touch because it is the only component to deliver quality care to reduce clinical errors and better outcomes.

The growing digital footprints and technology trends have enhanced the healthcare systems, but there still lies the need for human manpower. Where are the gaps in curating the healthcare data?

Artificial intelligence has got multiple applications outside of treating and responding to the pandemic. AI is incredibly helpful for improving efficiency with information processing and decision-making for clinicians. In the healthcare industry, AI & machine learning is extremely helpful for the development of new pharmaceuticals and the efficiency of diagnosis processes. A few of the researchers have utilized machine learning to track trends and mental health in correlation to the COVID-19 pandemic. By using an AI model, they were able to analyse thousands of online Reddit messages to find that topics of suicidality and loneliness had nearly doubled over a period of time. This has



the potential to transform the understanding of the mental health of larger populations. However, AI & ML will not replace complete human intervention, but they will be an unavoidable tool for clinicians to adapt during delivering care. There is no denying that the healthcare AI market is brimming with innovations that crop up at an astounding rate. Having said that, it is easy to jump to the conclusion that clinics will inevitably replace doctors with artificial intelligence one day. But in all likelihood, it will never happen, and clinician's/care teams don't need to worry about their involvement to deliver the care delivery.

AI and Robots cannot show empathy, sympathy, and compassion as these are one of the key elements of quality healthcare. It improves patient satisfaction and promotes healing. Unfortunately, empathy and sympathy are unachievable for an automated machine, and that is the main argument against autonomous AI in healthcare.

Though AI can outperform doctors in a variety of tasks, it cannot become a human being. Only a flesh-and-blood clinician can support the patient during a challenging treatment process, hold their hand while breaking life-changing diagnosis news to them, entertain a scared child during drawing blood or genuinely worry about their patients. We might teach robots to mimic these things, but sincerity cannot be taught.

As far as the gaps in curating the healthcare data is concerned, it is related to a challenge from the healthcare provider/hospital's side to consolidate the clinical data which could be coming from multiple resources like medical devices, and interoperability. In other words, this process includes activities like data selection, classification, validation, and remediation of disparate data that comes from multiple sources.

The current trend is trying to mitigate this challenge by adopting the technology to have 100% clinical data consolidation to



healthcare industry is way ahead post-pandemic across the globe.

AI-enabled robots can be a big boon in healthcare. How do you think it is helping doctors in their day-to-day life?

Yes, of course, Robots are helping the surgeons especially, today, in medical science, Robotic systems already provide a wide range of services in healthcare, including surgical assistance, patient rehabilitation, cleaning and sterilization, dispensing drugs, and remote diagnosis, it improves patient satisfaction and promotes healing. It is being used to reduce surgical errors and make surgery less invasive for thousands of patients, it gives surgeons more precise control for a range of procedures.

It puts consumers in control of health and well-being quickly. Additionally, AI Robots increase the ability of healthcare professionals to have a better understanding of the day-to-day patterns and needs of the people they care and treat for, and with that understanding, HCPs can provide better feedback, guidance, and support for staying well & healthy.

AI is getting increasingly sophisticated at doing what the human being does, but more efficiently, more quickly, and at a much lower cost. The potential for both AI and robotics in healthcare is immense and evolving. Just like in our everyday lives, AI and robotics are increasingly a part of the healthcare ecosystem. India is one of the countries that is adopting and promoting robotic tools to deliver care delivery more cost-effective and clinically error-free.

What more can be done to enhance healthcare innovations in India?

Over the last decade, technologies have been driving the healthcare industry through

“
UNFORTUNATELY, EMPATHY
AND SYMPATHY IS
UNACHIEVABLE FOR AN
AUTOMATED MACHINE, AND
THAT IS THE MAIN ARGUMENT
AGAINST AUTONOMOUS AI IN
HEALTHCARE.

enable better CDSS at the Point of care to the clinicians and other HCPs.

However, most hospitals are in the evolving phase to ensure data consolidation so that AI can be enabled much more effective way to get better clinical outcomes. This challenge would be mitigated in the coming days as the adoption of the technology, especially in the

various innovations in how it finds, prevent, and cures diseases. This should not have happened without the gigantic growth of AI-driven technologies and digitization of healthcare workflows & clinical pathways as a response to more savage global conditions, as well as the rising demand for accessible and quality healthcare services.

As we press on into the future, it is critical to remain mindful of the trends driving healthcare technology in 2022 and the coming year.

Although the legacy software and infrastructure which still fulfils a business need is critical to the success of modern hospitals and care centres, it is important that we consider how those systems can integrate with newer technologies or how they may eventually be replaced with more reliable healthcare echo-systems. The focus should be on improving performance, productivity, efficiency, and data security without sacrificing reliability, sustainability, and accessibility.

If you are ready to explore the technological innovations driving the healthcare industry towards digital transformation in the coming year, let us look at the most important technologies that have the potential to transform your organization with cost-effectiveness and affordability. The Indian Hospitals should have a much better understanding and believe that without digital transformation, better and cost-effective care delivery, patient, and clinician satisfaction cannot be achieved. Also, the Hospitals should allot the Information Technology budget by 2.00 to 2.5% of their revenue each year to have state-of-the-art technology-based applications and tools in place always.

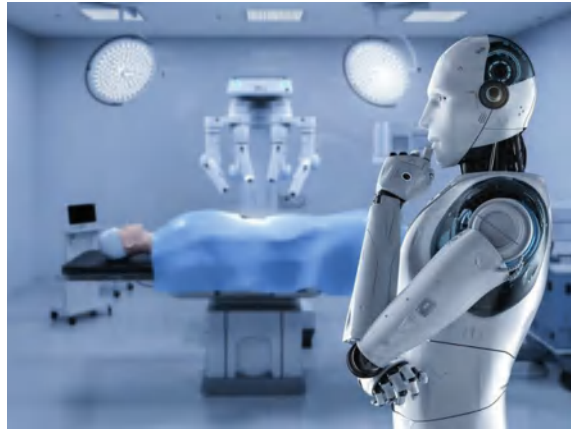

Apart from it, the Indian hospitals should be very innovative by:

- Make innovation part of your culture
- Empowered consumers
- Create a governance structure
- Innovate through collaboration
- Think 'out-of-the-box' for funding
- Use small pilots to innovate
- Data sharing
- Interoperability
- AI in Diagnosis and drug development
- Natural language processing (NLP)
- Complying with regulation
- Data & Security
- Virtual health technology

Optimized uses at your fingertips

uMEC 100/120/150 Patient Monitors



Boost your confidence in clinical judgments with the uMEC series patient monitors. It caters to clinical needs by offering precise and stable measurement of essential parameters.

Excellent Performance

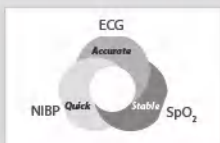

Essentially advanced measurements

2400 hours trends
5000 events
5000 NIBP measurements
120 hours full disclosure

Huge data capacity



12 hours

Long battery working time

Reliability



Drop protection

Ease of Use



Gestures operations



Storage space



Self learning

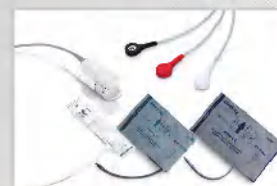

Mindray accessories



Mindray India Unveils Cutting-Edge **uMEC Series Patient Monitors** At ISACON 2023

Mindray proudly unveiled its latest innovation—the uMEC series patient monitors at ISACON 2023, 70th Annual Conference of the Indian Society of Anaesthesiologists (ISACON) 2023. The launch of the state-of-the-art uMEC 100/120/150 patient monitors marked a significant milestone, captivating industry professionals, healthcare practitioners, and enthusiasts alike.

Ease of Use:

The uMEC series prioritizes user-friendliness with a standard touch screen supporting gesture operations. The flat UI design ensures a visually clean and intuitive layout, enhancing overall interaction. Notably, the series supports self-learning, easing caregiver use.

Going beyond standard monitors, uMEC offers comprehensive

analytical results with Early Warning Score (EWS), Glasgow Coma Scale (GCS), and 24-hour ECG summary applications. This wealth of information empowers healthcare professionals with crucial insights for timely interventions. Maintaining a lightweight design, the uMEC series ensures portability without compromising functionality, crucial for dynamic clinical environments.



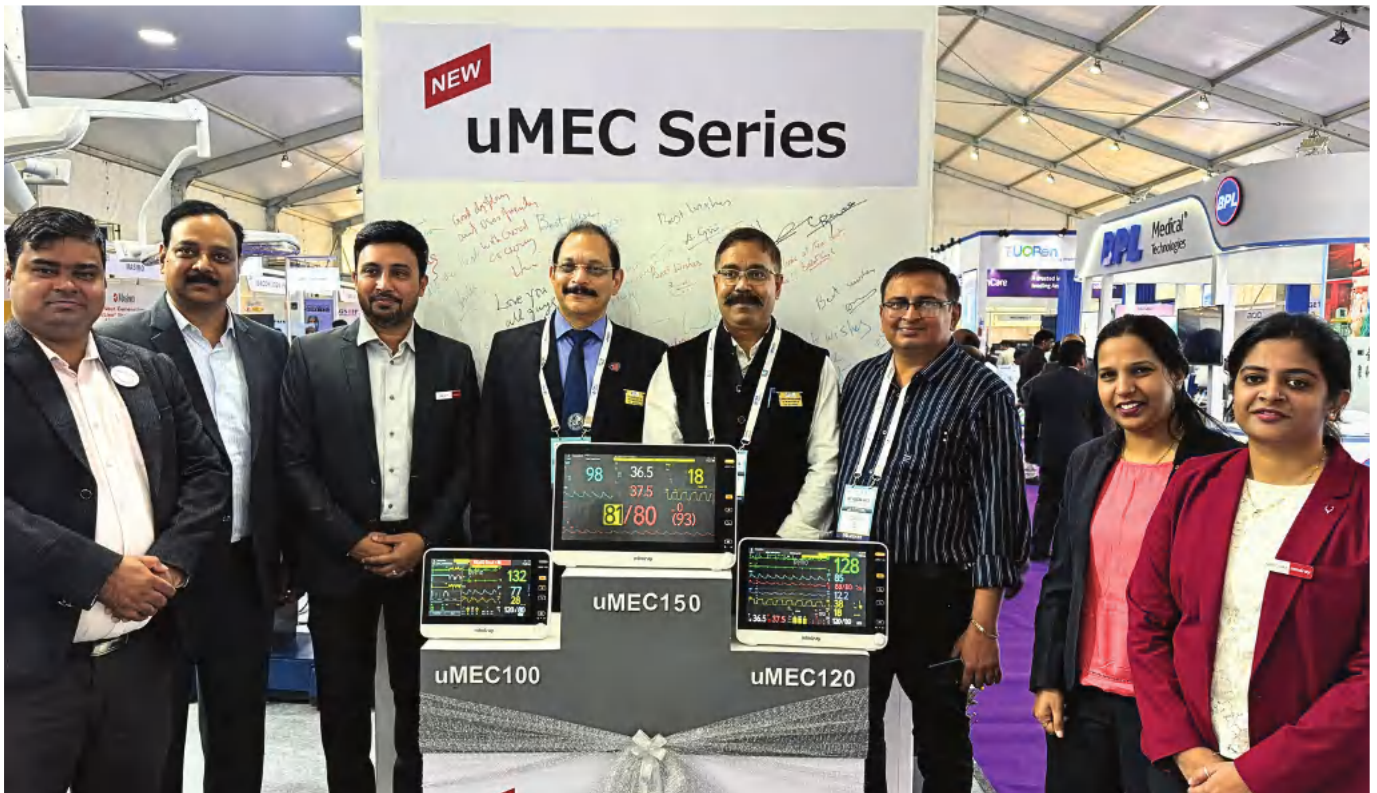

Excellent Performance:

Mindray's patented Multi-lead ECG Algorithm ensures unparalleled accuracy in capturing and analyzing electrocardiogram data. The uMEC series also features a quick NIBP measurement technique for streamlined blood pressure measurement.

External USB storage support enables seamless transfer and storage of vital patient data, ensuring comprehensive record-keeping. The uMEC series boasts ample data storage capacity and an impressive up to 12-hour continuous runtime with one Lithium-ion battery.

Reliability:

Robust design and protective features, including 0.75m drop protection and IPX1 water resistance, make the uMEC series resilient in dynamic clinical settings. Low power consumption and a fanless design contribute to prolonged battery life and environmental sustainability.



Conclusion:

Mindray's uMEC series, launched at ISACON 2023, sets a new standard in patient monitoring technology. It delivers a comprehensive solution that excels in ease of use, excellent performance, and unwavering reliability. This innovation provides healthcare professionals with precise tools for confident clinical decision-making.

In summary, the uMEC series offers a state-of-the-art solution that combines cutting-edge technology with a focus on user experience, analytical precision, portability, performance, and reliability. This launch marks a significant milestone in advancing patient monitoring technology, catering to the evolving needs of healthcare professionals.

Making Every Heartbeat Count!



Mindray India and Narayana Health Team Up for a Guinness World Record

In a remarkable and heartwarming event, Narayana Health, one of our prime customers in India, joined hands with Mindray India to organize a free ECG camp on World Heart Day, September 21, 2023. The goal? Aiming for an astonishing 5000 ECGs in a single day, achieving a remarkable Guinness World Record. Our support for this extraordinary feat is a testament to our unwavering commitment to providing better healthcare for all.



Mindray India's Commitment to Healthcare:

At Mindray, our vision is crystal clear: Better healthcare for all, i.e. to make high-quality healthcare accessible to everyone, everywhere. We believe that health is a fundamental human right, and our goal is to empower medical professionals with cutting-edge technology to deliver superior care to their patients.

The collaboration with Narayana Health is a perfect embodiment of this vision. We are not just a provider of medical equipment; we are a partner in the journey toward a healthier, happier world.

Mindray India's Contribution:

As the exclusive ECG machine partner for Narayana Health's World Heart Day event, Mindray India supplied over 20 demo machines across India. These machines are not just advanced in technology but also designed with ease of use in mind. This reflects our commitment to providing medical professionals with state-of-the-art tools that enhance patient care. In addition to supplying ECG machines, Mindray India played a crucial role in establishing a robust data network to support

the 5000 ECGs conducted during the event. This reflects our dedication to providing comprehensive solutions and support, not just products. Reliable data connectivity ensures that healthcare professionals can make accurate diagnoses and deliver timely care.

The World Heart Day event was more than just a record-breaking feat. It was a celebration of heart health and a reminder of the importance of early detection and prevention. Mindray India values community engagement and education, understanding that health outcomes improve when communities are well-informed and actively participate in their well-being.

A Heartfelt Journey: The Impact

This extraordinary achievement is not just a record in the Guinness World Records; it's a record in the hearts of the people who benefited from this event. By coming together with Narayana Health, Mindray India made a meaningful impact on the lives of thousands of individuals. We helped identify potential heart issues, educated the community about heart health, and paved the way for early intervention and healthier lives.

As we celebrate this remarkable feat, we are reminded of our enduring commitment to make healthcare more accessible, efficient, and patient-centric. We continue to work towards this vision, one heart at a time, one partnership at a time. Together, we can make a difference in the world of healthcare, and this remarkable Guinness World Record is just the beginning of a brighter, healthier future for all.



CUBE HDMI 2023

A Hematology Revolution



The sixth edition of CUBE, the "CUBE – HDMI 2023" organized by Mindray, BLK-Max Super Speciality Hospital, and St. John's Hospital unfolded on September 9th and 10th, 2023. It brought together global hematology experts, professionals, and enthusiasts.

Focused on the dynamic forces reshaping hematology, namely Hemocytomorphometry, Digital Morphology, and Artificial Intelligence, the symposium showcased cutting-edge technologies, research findings, and trend analyses. This two-day milestone event wasn't merely a gathering; it provided a unique opportunity for attendees to immerse themselves in discussions, fostering collaboration and sharing insights at the forefront of hematology advancements.

"CUBE – HDMI 2023" stands as a testament to our commitment to advancing hematology. You're invited to explore the symposium's



website, <https://cubesummit.org/> which is a rich repository of discussions and insights from all CUBE editions. It serves as more than a retrospective; it's a preview into a future where innovation and knowledge converge to reshape the boundaries of hematology.

mindray

Above and Beyond



BC-700 Series

Hematology Analyzer with ESR

CBC & ESR integrated solution

Get both results in 90s

Optical PLT in every CBC & DIFF test

Reliable PLT results even with interference

SF Cube 3D analysis technology

Reliable results for abnormal samples

Exceeds All Expectations

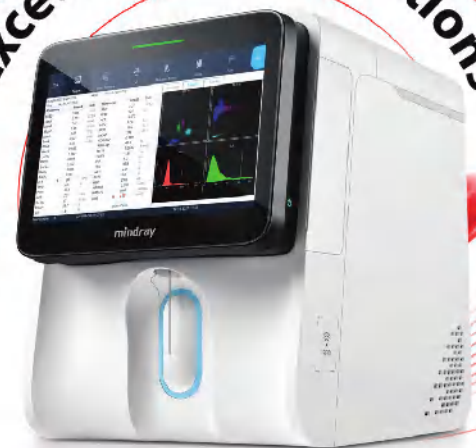

PARAMETERS FOR FEMALES WITH PRIMARY HYPOTHYROIDISM



Hypothyroidism is a clinical syndrome resulting from a deficiency of thyroid hormones, which, in turn, results in a generalized slowing down of metabolic processes. Hypothyroidism affects over one per cent of the general population and about five per cent of individuals over the age of 60 years. It was pointed out in many studies that there exists a relationship between Hypothyroidism and Hyperuricemia which can contribute to increased number of complications.

Changes in routine biochemical indicators of renal function in the hypothyroid status are not well-characterized. Thyroid disease influences the purine metabolism, which may increase serum uric acid level. Serum uric acid has been found to be significantly elevated in primary hypothyroidism in many studies. **This study was designed for evaluation of serum uric acid levels in females having hypothyroidism.**



Dr. Pooja Devi

Assistant Professor,
Dr. Baba Saheb
Ambedkar, Medical
College, Rohini, Delhi

Dr. Pooja Devi holds over 15 years of teaching experience in various dental and medical colleges. She has over 12 years of working experience in diagnostic laboratory, has presented various papers in national conferences, organised Continuing Medical Education (CME) on Thyroid Dysfunction and Diabetes Mellitus in Dr BSA Medical College. She has also published various research papers in national and international journals.



THYROID DISEASE INFLUENCES THE PURINE METABOLISM, WHICH MAY INCREASE SERUM URIC ACID LEVEL. **SERUM URIC ACID HAS BEEN FOUND TO BE SIGNIFICANTLY ELEVATED IN PRIMARY HYPOTHYROIDISM IN MANY STUDIES.**



Materials and methods

An analytical cross-sectional study was conducted in the Department of Biochemistry in April 2022 at Dr BSA Medical College and Hospital, Rohini, Delhi. A total of 90 non-pregnant female patients in the age group of 20 to 50 years newly detected with overt hypothyroidism, coming for thyroid function test, were enrolled in the study. Females with history of liver diseases, kidney disease, diabetes, hypertension, malignancy, oral contraceptive pills, and pregnancy were excluded.

The sample collection involved 5 ml of venous blood that was collected from the selected patients in a plain test tube. Blood collected in plain tube was allowed to clot at room temperature and then centrifuged at 2,500 rpm for five minutes. Serum, so obtained, was used to determine the thyroid hormones (TSH, FT3, FT4) and serum (uric acid). If parameters are





not estimated early, serum is stored at deep freezer at a temperature of -40 degrees Celsius; FT3, FT4 and TSH were determined by CLIA method by CL 1000i Serum uric acid were estimated by using automated BS-600M auto analyzer. Thyroid profile tests (FT3, FT4 and TSH) were estimated to categorize sub-clinical hypothyroidism and overt hypothyroidism.

Results and observation

A positive significant correlation was found between serum TSH and uric acid levels in females with overt hypothyroidism with Pearson's correlation coefficient of 0.270 and p value < 0.009

In our research, uric acid levels in patients with primary thyroid disorders were higher than controls. The uric acid level was substantially higher in hypothyroid patients than in hyperthyroid patients. Uric acid is water-soluble and antioxidant which is

mainly produced by the liver. It inhibits the harm done by the free radicals and protect cell membranes and DNA. Among important biochemical parameters, uric acid is functioning as antioxidant agent, which, affected by thyroid function, and, also, thyroid dysfunction, affects the purine metabolism that may increase uric acid to thyroid dysfunction.

The elevated levels of SUA are also accompanied with other co-morbid conditions including hypertension, metabolic syndrome, chronic kidney disease (CKD) and type-II diabetes mellitus. This may be attributed to increased purine metabolism in primary hyperthyroidism and reduced renal perfusion and glomerular filtration (GFR) in primary hypothyroid patients. The elevated uric acid levels are thought to be an intermediate factor in adipose tissue. In addition, it regulates



endocrine disorders that promote inflammation, which can be an important factor leading to dyslipidemia and atherosclerosis.

Thyroid hormones (THs) are related to Oxidative Stress (OS) as well as the antioxidant status, which is because they can alter the respiratory rate and promote the basal metabolism within mitochondria. Changes in THs contents may serve as the major physiologic regulators for cellular OS in-vivo. The available data concerning OS in thyroid dysfunction are controversial and insufficient. A low amount of free radicals is generated in hypothyroidism, since the decreased THs content led to suppression of metabolism.

It is observed from our study that serum uric acid levels are significantly higher in hypothyroid females. The reason may be that thyroid hormones affect uric acid levels by affecting the catabolism of purine nucleotides, and impact on excretion of uric acid. Hypothyroidism is secondary to a decreased renal plasma flow and impaired

“
IT IS OBSERVED FROM OUR
STUDY THAT **SERUM URIC
ACID LEVELS ARE
SIGNIFICANTLY HIGHER IN
HYPOTHYROID FEMALES**
”

glomerular filtration. It reduces cardiac contractility, and the GFR can decrease by 20-30 per cent to below normal levels, thereby, changing reabsorption and secretion in the tubular, which simultaneously increases the level of uric acid, which results in a decrease in UA excretion.

mindray

Powerful yet Efficient

BS-600M Chemistry Analyzer

SDM

800 T/H
with ISE

6
Sigma

Whole
Blood
HbA1c

↓
COST

↑
COST

↓
COST

EFFICIENCY



Powerful
yet Efficient



Digital Morphology: Revolutionising Hematology



Dr. Anil Handoo

Senior Consultant and
Director of Pathology Dept,
BLK-Max Super Speciality
Hospital, New Delhi
20+ Years of Experience

Dr. Anil Handoo is a renowned pathologist who is working as the Senior Consultant and Director of Pathology Dept, BLK-Max Super Speciality Hospital, New Delhi. He has more than 20 years of experience in this field. He is an active Life Member of the Indian Association of Pathologists & Microbiologists, the Indian Society of Hematology & Transfusion Medicine, Delhi Society of Hematology, The Cytometry Society & the International Clinical Cytometry Society.

1. You have almost two decades of experience in the field of Hematology, according to you, what are the major changes that have changed the face of Hematology today?

Technological advancements in cell counter/hematology analyser science along with automation of the majority of the critical steps in analysis, have been the major changes in recent years, which have led to the facilitation of cellular analysis and improved the way we work in the lab. Right from improvements in technology, with better flag optimization, today's hematology analyzers are able not only to differentiate mature cells but also have the ability, to accurately pick up the presence of abnormal cells. With the addition of a digital morphology platform and artificial intelligence with machine learning algorithms, digitized morphology has further enhanced the ability to pick of incidental findings on the smears, which sometimes were missed by manual microscopy for the sheer lack of time and focus on every slide.

2. If you have to explain the concept of Digital Morphology to a layman, how will you explain it?

Digital morphology is nothing but visualization of peripheral blood smear microscopy using a camera and automating the image capture with projection onto a computer, instead of manually seeing a slide on the microscope. Digitization and AI-based pre-classification of cells on the smear ensure less amount of time spent on every smear with enhanced workflow efficiency. There is also an advantage of having stored digital image data not only for reviews at a later date but also a possibility of remote viewing and opinion seeking.

3. How has Digital Morphology revolutionized the field of Hematology?

“
DIGITAL MORPHOLOGY HAS
ENABLED HIGHLY
REPRODUCIBLE CELLULAR
CLASSIFICATION,
QUANTIFICATION OF
ABNORMALITIES & REVIEW
BY AN EXPERT FROM A
REMOTE LOCATION.
”

Digital Morphology, with artificial intelligence-based algorithms, has ensured highly reproducible cellular classification, and quantification of abnormalities, not only for the white blood cells but also for red cells and platelets. The possibility of scanning the smear on the edges for the presence of platelet clumps, or any other abnormalities enhances pick-up rates of such abnormalities. Additionally, the review and valued opinion of an expert from a remote location, with real-time incorporation into the report has been made possible.

4. What is the role of Artificial Intelligence in Digital Morphology? Can you explain with 1-2 examples?

Artificial intelligence is adding new dimensions to morphology analysis, and the predictive capability of the analysers has been increased by many notches. For example let's say there is an abnormal cell or parasite which is present but in very small numbers, the human eye has a chance to miss, but since a digital morphology analyser is going to look into a lot more cells than human microscopy, chances of it getting picked up are higher.

5. Will Artificial Intelligence replace the role of humans in pathology laboratories?

I do not see that happening in the near future, however, AI-assisted cell analysis helps humans in obtaining more precision & accuracy.



6. To what extent can we rely on the results delivered by Artificial intelligence?

As long as the instrument is well maintained and the smear is appropriately stained, I would trust AI to do a reasonably good job most of the time.

7. How can Digital Morphology be made affordable so that it can reach the masses? What are your suggestions?

Increasing the awareness regarding use of digital morphology would ensure increased demand. In parallel, the miniaturization of devices with smaller footprints and reduction of production costs would help make them affordable to the masses.

8. According to you, what are the aspects of Digital Morphology that need to change or evolve?

High-speed scanning with the upgradation of AI and constant machine learning for the pre-classification of cells would help improve the output. Also, remote web-based access with cloud-based data storage is the way to go to help us utilize the system better.

MINDRAY'S COMMITMENT TO A HEALTHIER BHARAT

ADVANCING ULTRASOUND TECHNOLOGY IN INDIA



Mindray has emerged as one of the top players in the ultrasound industry in India. Could you share the journey and key milestones that have contributed to this success?

In the last decade, Mindray has made significant strides in the Indian ultrasound industry, positioning itself as a key player. We are currently at the #2 position in India in the ultrasound modality. We have expanded our product lines and offered integrated solutions that adapt to different departments to help healthcare providers boost efficiency and optimize management.

Our commitment to offering cutting-edge and innovative ultrasound solutions, and our extensive distribution network, coupled with an experienced team, have allowed us to effectively reach a diverse clientele, spanning from small clinics to large corporate hospitals and diagnostic centres across India.

Ashwani Raina

Director, UIS, Mindray India

We are grateful for the huge support and motivation from our privileged customers in India & stakeholders, who have helped us to establish a significant presence in the country over the years.



MINDRAY STRIVES TO
BE A HOLISTIC
SOLUTION PROVIDER
AND,
**A TRUSTED PARTNER
IN BUILDING A
HEALTHIER BHARAT.**



Innovation is a driving force in the field of medical imaging. How has Mindray consistently introduced cutting-edge devices and technologies to stay at the forefront of the ultrasound industry in India?

Innovation has been an integral part of Mindray's journey and is deeply embedded in our organizational DNA. We've consistently demonstrated a commitment to pushing boundaries and achieving breakthroughs. A key aspect of our strategy is building long-term and sustainable relationships with our partners. We believe that understanding their needs is essential to crafting solutions that truly make a difference. This collaborative mindset has ensured that our innovations are not just technologically advanced but also aligned with the practical requirements of healthcare providers in India.

In addition to our focus on innovation and collaboration, our 24x7 customer service centre plays a vital role in ensuring customer satisfaction.

Through a combination of advanced solutions, collaboration, and robust customer support, we strive to stay at the forefront of the medical imaging landscape in India.



Can you highlight any Mindray ultrasound solution that has made a significant impact in India?

Mindray's recent innovation, the Resona series, has made a significant impact in the field of diagnostic imaging. The Resona I9 is equipped with a range of innovative features that address the evolving demands of diagnostic imaging. The customizable control panel, foldable structure, extended battery life, and super silent design improve the overall workflow efficiency. The system is powered by Mindray's revolutionary ZST+ platform, delivering exceptional image quality for infinite imaging solutions.

This innovative ultrasound system is being actively utilized in an IRIA-initiated study titled **"The diagnostic effectiveness of the new generation ZST Technology-based HFR SWE with M-STB & RLB Map on Resona series for liver elastography."** This study aims to transform the diagnosis and treatment for Non-Alcoholic Fatty Liver Disease (NAFLD) and reduce its burden in India.



Looking ahead to 2024, what innovations and developments can we expect from Mindray in the field of ultrasound modality? Are there any exciting products or technologies on the horizon that you can provide a sneak peek into?

Looking ahead to 2024, Mindray is poised to focus on advanced clinical solutions in GI, Women's Healthcare and POC. In GI, Mindray will lead the industry through the introduction

Mindray's commitment to becoming a trusted partner for a healthier Bharat is commendable. Could you share some insights into the strategies and initiatives that the company has undertaken to achieve this goal, particularly in the Indian healthcare landscape?

Mindray's commitment to becoming a trusted partner for a healthier Bharat is deeply ingrained in our strategies and initiatives, reflecting our dedication to transforming the healthcare landscape in India.

By constantly pushing the boundaries of innovation through strong Research and Development (R&D), we have been able to provide safe, reliable, and user-centric medical devices that address the evolving needs of healthcare professionals. Our operation, sales, marketing, and service teams are dedicated to offering not just devices but also comprehensive support. We also understand that bringing healthcare within reach involves not only providing cutting-edge technology but also offering training and assistance. To address this, Mindray India provides various levels of training to customers, distributors, and service partners.

of a "Multi-parametric solution" dedicated to Liver, Breast, Thyroid, Vascular, and Urology to enhance diagnostic confidence resulting in better treatment outcomes. In Women's Healthcare, Mindray Full Stack Smart Solutions powered by AI & deep learning, are expected to enhance diagnostic confidence, efficiency & standardization - covering Pre-Pregnancy, Pregnancy, Post -postpartum recovery and neonates.

In Point of Care (POC) Mindray's advanced solutions help clinicians reimagine their clinical practice, in demanding environments of critical care and emergency medicine. With industry Unique Xlink, the ability to integrate vital parameters of patients on ultrasound images allows immediate decisions by bedside, supporting rapid clinical decisions for better patient outcomes.

Most importantly revolutionary Zone Sonography Technology will be migrated across mid-segments through the Consona series. This will benefit the entire imaging fraternity in India including Primary care to enhance diagnostic confidence and precision reporting.

By delivering comprehensive solutions and maintaining a broad portfolio, Mindray strives to be a holistic solution provider and a trusted partner in building a healthier Bharat.

mindray

Fusion for Safety[★]

NEW

A7/A5 Anesthesia System

