

**MX7/MX7T/Vaus7/Zeus/ME7/Anesus
ME7/Anesus ME7T/MX7P/MX7W/MX8/
MX8T/Vaus8/ME8**

Diagnostic Ultrasound System

Operator's Manual

[Basic Volume]

Intellectual Property Statement

SHENZHEN MINDRAY BIO-MEDICAL ELECTRONICS CO., LTD. (hereinafter called Mindray) owns the intellectual property rights to this Mindray product and this manual. This manual may refer to information protected by copyright or patents and does not convey any license under the patent rights or copyright of Mindray, or of others.

Mindray intends to maintain the contents of this manual as confidential information. Disclosure of the information in this manual in any manner whatsoever without the written permission of Mindray is strictly forbidden.

Release, amendment, reproduction, distribution, rental, adaptation, translation or any other derivative work of this manual in any manner whatsoever without the written permission of Mindray is strictly forbidden.

mindray is the trademarks, registered or otherwise, of Mindray in China and other countries. All other trademarks that appear in this manual are used only for informational or editorial purposes. They are the property of their respective owners.

This posting serves as notice under 35 U.S.C.§287(a) for Mindray patents:

<http://www.mindrayna.com/patents>.

Responsibility on the Manufacturer Party

Contents of this manual are subject to change without prior notice.

All information contained in this manual is believed to be correct. Mindray shall not be liable for errors contained herein or for incidental or consequential damages in connection with the furnishing, performance, or use of this manual.

Mindray is responsible for the effects on safety, reliability and performance of this product, only if:

- all installation operations, expansions, changes, modifications and repairs of this product are conducted by Mindray authorized personnel;
- the electrical installation of the relevant room complies with the applicable national and local requirements; and
- the product is used in accordance with the instructions for use.

NOTE:

This equipment must be operated by skilled/trained clinical professionals.

WARNING

It is important for the hospital or organization that employs this equipment to carry out a reasonable service/maintenance plan. Neglect of this may result in machine breakdown or personal injury.

Warranty

THIS WARRANTY IS EXCLUSIVE AND IS IN LIEU OF ALL OTHER WARRANTIES, EXPRESSED OR IMPLIED, INCLUDING WARRANTIES OF MERCHANTABILITY OR FITNESS FOR ANY PARTICULAR PURPOSE.

Exemptions

Mindray's obligation or liability under this warranty does not include any transportation or other charges or liability for direct, indirect or consequential damages or delay resulting from the improper use or application of the product or the use of parts or accessories not approved by Mindray or repairs by people other than Mindray authorized personnel.

This warranty shall not extend to:

- Malfunction or damage caused by improper use or man-made failure.
- Malfunction or damage caused by unstable or out-of-range power input.
- Malfunction or damage caused by force majeure such as fire and earthquake.
- Malfunction or damage caused by improper operation or repair by unqualified or unauthorized service people.
- Malfunction of the instrument or part whose serial number is not legible enough.
- Others not caused by instrument or part itself.

Customer Service Department

Manufacturer:	Shenzhen Mindray Bio-Medical Electronics Co., Ltd.
Address:	Mindray Building, Keji 12th Road South, High-tech industrial park, Nanshan, Shenzhen 518057, P.R.China
Website:	www.mindray.com
E-mail Address:	service@mindray.com
Tel:	+86 755 81888998
Fax:	+86 755 26582680

Manufacturer:	Mindray DS USA, Inc.
Address:	800 MacArthur Blvd. Mahwah, NJ 07430-0619 USA
Tel:	+1(201) 995-8000
Toll Free:	+1 (800) 288-2121
Fax:	+1 (800) 926-4275

Important Information



- It is the customer's responsibility to maintain and manage the system after delivery.
- The warranty does not cover the following items, even during the warranty period:



- Damage or loss due to misuse or abuse.
- Damage or loss caused by Acts of God such as fires, earthquakes, floods, lightning, etc.
- Damage or loss caused by failure to meet the specified conditions for this system, such as inadequate power supply, improper installation or environmental conditions.
- Damage or loss due to use of the system outside the region where the system was originally sold.
- Damage or loss involving the system purchased from a source other than Mindray or its authorized agents.
- This system shall not be used by persons other than fully qualified and certified medical personnel.
- DO NOT make changes or modifications to the software or hardware of this system.
- In no event shall Mindray be liable for problems, damage, or loss caused by relocation, modification, or repair performed by personnel other than those designated by Mindray.
- The purpose of this system is to provide physicians with data for clinical diagnosis. The physician is responsible for the results of diagnostic procedures. Mindray shall not be liable for the results of diagnostic procedures.
- Important data must be backed up on external memory media.
- Mindray shall not be liable for loss of data stored in the memory of this system caused by operator error or accidents.
- This manual contains warnings regarding foreseeable potential dangers, but you shall also be continuously alert to dangers other than those indicated. Mindray shall not be liable for damage or loss resulting from negligence or ignorance of the precautions and operating instructions described in this operator’s manual.
- If a new manager takes over this system, be sure to hand over this operator’s manual to the new manager.

About This Manual

This operator’s manual describes the operating procedures for this diagnostic ultrasound system and the compatible probes. To ensure safe and correct operation, carefully read and understand the manual before operating the system.

Meaning of Signal Words

In this manual, the signal words  **DANGER**,  **WARNING**,  **CAUTION**, **NOTE** and **TIP** are used regarding safety and other important instructions. The signal words and their meanings are defined as follows. Please understand their meanings clearly before reading this manual.

Signal word	Meaning
 DANGER	Indicates an imminently hazardous situation that, if not avoided, will result in death or serious injury.
 WARNING	Indicates a potentially hazardous situation that, if not avoided, could result in death or serious injury.
 CAUTION	Indicates a potentially hazardous situation that, if not avoided, may result in minor or moderate injury.
NOTE	Indicates a potentially hazardous situation that, if not avoided, may result in property damage.

Signal word	Meaning
TIP	Important information that helps you to use the system more effectively.

Hardcopy Manuals

- Operator's Manual [Basic Volume]
Describes the basic functions and operations of the system, safety precautions, exam modes, imaging modes, preset, maintenance and acoustic output, etc.
- Operator's Manual [Advanced Volume]
- Operator's Manual [Acoustic Power Data and Surface Temperature Data]
Contains data tables of acoustic output for transducers.
- Quick Reference Guide
Contains a quick reference guide for basic system operations.

The accompanying manuals may vary depending on the specific system you purchased. Please refer to the packing list.

Software Interfaces in this Manual

Depending on the software version, preset settings and optional configuration, the actual interfaces may be different from those in this manual.

Conventions

In this manual, the following conventions are used to describe the buttons on the control panel, items in the menus, buttons in the dialog boxes and some basic operations:

- <Buttons>: angular brackets indicate buttons, knobs and other controls on the control panel or on the keyboard.
- [Items in menu or buttons in dialog box]: square brackets indicate items in menus, on the soft menu or buttons in dialog boxes.
- Click [Items or Buttons]: move the cursor to the item or button and press <Set> or use the soft key corresponding to the soft menu.
- [Items in menu] > [Items in submenu]: select a submenu item following the path.

Notification of Adverse Events

As a health care provider, you may report the occurrence of certain events to SHENZHEN MINDRAY BIO-MEDICAL ELECTRONICS CO., LTD., and possibly to the competent authority of the Member state in which the user and / or patient is established.

These events, include device-related death and serious injury or illness. In addition, as part of our Quality Assurance Program, SHENZHEN MINDRAY BIO-MEDICAL ELECTRONICS CO., LTD. requests to be notified of device failures or malfunctions. This information is required to ensure that SHENZHEN MINDRAY BIO-MEDICAL ELECTRONICS CO., LTD. provides only the highest quality products.

Operator's Manuals

You may receive multi-language manuals on compact disc or paper. Please refer to the English manual for the latest information and registration information.

The content of the operator manual, such as screens, menus or descriptions, may be different from what you see in your system. The content varies depending on the software version, options and configuration of the system.

Contents

Intellectual Property Statement	I
Responsibility on the Manufacturer Party	I
Warranty	II
Exemptions	II
Customer Service Department	II
Important Information	II
About This Manual	III
Meaning of Signal Words	III
Hardcopy Manuals	IV
Software Interfaces in this Manual	IV
Conventions	IV
Notification of Adverse Events	IV
Operator's Manuals	IV
1 Safety Precautions	1 - 1
1.1 Meaning of Safety Symbols	1 - 1
1.2 Safety Precautions	1 - 1
1.3 Latex Alert	1 - 7
2 System Overview	2 - 1
2.1 Intended Use	2 - 1
2.2 Contraindication	2 - 1
2.3 Safety Classifications	2 - 1
2.4 Product Specifications	2 - 2
2.4.1 Power supply	2 - 2
2.4.2 Environmental Conditions	2 - 2
2.4.3 Dimensions and Weight	2 - 2
2.5 Product Differences	2 - 2
2.6 System Configuration	2 - 3
2.6.1 Standard Configuration	2 - 3
2.6.2 Probes and Needle-guided Brackets Available	2 - 4
2.6.3 Options	2 - 4
2.6.4 Peripherals Supported	2 - 6
2.6.5 Parts that can be used within patient environment	2 - 7
2.7 Introduction of Each Unit	2 - 8
2.8 U-Bank Overview	2 - 9
2.8.1 Parts and Names	2 - 10
2.8.2 Installing the U-Bank	2 - 11
2.9 ECG Module Overview	2 - 12
2.10 Control Panel	2 - 13
2.11 Exam Main Menu Screen	2 - 16
2.12 Monitor Display	2 - 17
2.13 Basic Operations	2 - 18

2.13.1 Dialog Box	2 - 18
2.13.2 Touch Screen	2 - 18
2.13.3 Voice Recognition	2 - 22
2.14 Warning Labels	2 - 23
2.15 Symbols	2 - 23
3 System Preparation	3 - 1
3.1 Move/Position the System	3 - 1
3.2 Connecting the Power Cord	3 - 1
3.2.1 Connecting Power	3 - 1
3.2.2 Powered by Batteries	3 - 1
3.3 Power ON/OFF	3 - 2
3.3.1 Check before Powering ON	3 - 3
3.3.2 Power the System ON	3 - 3
3.3.3 Check the system after it is powered on	3 - 4
3.3.4 Power the System Off	3 - 5
3.3.5 Standby	3 - 5
3.4 Monitor Brightness/Contrast Adjustment	3 - 6
3.5 Connecting/Disconnecting a Probe	3 - 6
3.5.1 Connecting a Probe	3 - 6
3.5.2 Disconnecting a probe	3 - 7
3.6 Connecting USB Devices	3 - 7
3.7 Connecting the Footswitch	3 - 8
3.8 Installing a Printer	3 - 8
3.8.1 Connecting a Graph/Text Printer	3 - 8
3.8.2 Connecting a Video Printer	3 - 9
3.8.3 Connecting a Wireless Printer	3 - 10
4 Setup	4 - 1
4.1 System Preset	4 - 2
4.1.1 Region	4 - 2
4.1.2 General	4 - 2
4.1.3 Image Preset	4 - 4
4.1.4 Application	4 - 5
4.1.5 OB	4 - 7
4.1.6 Key Probe	4 - 9
4.1.7 Key Configuration	4 - 10
4.1.8 Gesture	4 - 11
4.1.9 Output	4 - 11
4.1.10 Access Control	4 - 12
4.1.11 Scan Code Preset	4 - 16
4.2 Exam Mode Preset	4 - 18
4.3 Measurement Preset	4 - 19
4.3.1 General Measurement Preset	4 - 19
4.3.2 Application Measurement Preset	4 - 21
4.3.3 Report Preset	4 - 26
4.4 Comment Preset	4 - 27
4.4.1 Comment Configure	4 - 27
4.4.2 Comment Group Define	4 - 28

4.5 iWorks Preset	4 - 28
4.5.1 Protocol Management	4 - 28
4.5.2 View Management	4 - 29
4.5.3 Create a New Protocol	4 - 29
4.6 Stress Echo Preset	4 - 29
4.6.1 Protocol Edit	4 - 29
4.6.2 Maintenance	4 - 30
4.7 DICOM/HL7	4 - 31
4.7.1 DICOM Local Preset	4 - 31
4.7.2 DICOM Service Preset	4 - 32
4.8 Network Preset	4 - 38
4.8.1 Network Settings	4 - 38
4.8.2 iStorage Preset	4 - 39
4.8.3 MedTouch/MedSight Preset	4 - 40
4.8.4 Remote Maintenance	4 - 40
4.8.5 Q-Path Preset	4 - 40
4.8.6 eGateway Preset	4 - 41
4.8.7 MIOT Preset	4 - 43
4.9 Print Preset	4 - 43
4.9.1 Print Setting	4 - 43
4.9.2 Image Settings	4 - 44
4.10 Maintenance	4 - 44
4.10.1 Option	4 - 44
4.10.2 Exporting Setup Data	4 - 44
4.10.3 Importing Setup Data	4 - 44
4.10.4 Probe Check	4 - 44
4.10.5 Other Settings	4 - 45
4.11 Security	4 - 45
4.11.1 Drive Encryption/Secure Data Wipe	4 - 45
4.11.2 Anti-Virus	4 - 46
4.11.3 Transmission Encryption	4 - 46
4.12 System Information	4 - 46
5 Exam Preparation	5 - 1
5.1 Patient Information	5 - 1
5.1.1 New Patient Information	5 - 1
5.1.2 Retrieve Patient Information	5 - 2
5.2 Activate& Continue an Exam	5 - 3
5.2.1 Activate an Exam	5 - 3
5.2.2 Continue an Exam	5 - 3
5.3 Pause & End an Exam	5 - 4
5.3.1 Pause an Exam	5 - 4
5.3.2 End an Exam	5 - 4
6 Image Acquisition	6 - 1
6.1 B Mode	6 - 1
6.1.1 B-mode Image Scanning	6 - 1
6.1.2 B-mode Image Parameters	6 - 1
6.2 Color Mode	6 - 4

6.2.1 Color Mode Image Scanning	6 - 4
6.2.2 Color Mode Image Parameters	6 - 5
6.3 Power Mode	6 - 7
6.3.1 Power Mode Image Scanning	6 - 7
6.3.2 Power Mode Image Parameters	6 - 7
6.4 M Mode	6 - 7
6.4.1 M Mode Image Scanning	6 - 7
6.4.2 M Mode Image Parameters	6 - 8
6.5 Color M Mode (CM)	6 - 8
6.5.1 CM Image Scanning	6 - 9
6.5.2 CM Image Parameters	6 - 9
6.6 Anatomical M Mode	6 - 9
6.6.1 Linear Anatomical M (Free Xros M)	6 - 9
6.6.2 Free Xros CM (Curved Anatomical M-Mode)	6 - 10
6.6.3 Anatomical M Mode Parameters	6 - 11
6.7 PW/CW Mode	6 - 11
6.7.1 PW/CW Mode Image Scanning	6 - 11
6.7.2 PW/CW Mode Image Parameters	6 - 11
6.8 TDI	6 - 13
6.8.1 TDI Mode Image Scanning	6 - 14
6.8.2 TDI Mode Image Parameters	6 - 14
6.8.3 TDI Quantitative Analysis	6 - 14
6.9 iScape	6 - 17
6.9.1 Basic Procedures for iScape Imaging	6 - 18
6.9.2 Image Review	6 - 19
6.9.3 Evaluate image quality	6 - 19
6.9.4 Cine Review	6 - 19
6.10 R-VQS	6 - 20
6.11 Smart B-line	6 - 21
6.11.1 Basic Procedures for Smart B-line	6 - 22
6.11.2 Overview	6 - 23
6.12 Smart VTI	6 - 23
6.13 Smart IVC	6 - 25
6.14 RIMT (Real-time Intima-Media Thickness)	6 - 27
6.15 Tissue Tracking Quantitative Analysis	6 - 28
6.15.1 Basic Procedures for Tissue Tracking QA	6 - 28
6.15.2 Screen Display of Tissue Tracking QA	6 - 29
6.15.3 Select Image and Cardiac Cycle	6 - 30
6.15.4 Myocardial Boundary Tracing	6 - 30
6.15.5 Basic Operations of TTQA	6 - 31
6.15.6 Bulleye	6 - 33
6.15.7 Measurement/Comment	6 - 33
6.15.8 Data Export	6 - 33
6.16 Auto GA	6 - 33
6.17 Auto DFR	6 - 34
6.18 Smart FHR OB1	6 - 34
6.19 AutoEF	6 - 35
6.20 Smart Bladder	6 - 36

6.21 iWorks (Auto Workflow Protocol)	6 - 37
6.21.1 Screen Display	6 - 38
6.21.2 View Operation	6 - 38
6.21.3 Manual Examination	6 - 39
6.21.4 Insert	6 - 39
6.22 Quickly Saving Image Settings	6 - 39
7 Smart 3D	7 - 1
7.1 Overview	7 - 1
7.1.1 Terms	7 - 1
7.1.2 ROI and VOI	7 - 2
7.1.3 Render Mode	7 - 3
7.1.4 MPR	7 - 3
7.1.5 Wire cage	7 - 4
7.2 Note before Use	7 - 4
7.2.1 Smart 3D Image Acquisition	7 - 6
7.2.2 Smart 3D Image Viewing	7 - 7
8 Strain Elastography	8 - 1
8.1 Basic Procedure for Strain Elastography	8 - 1
8.2 Image Parameters	8 - 2
8.3 Mass Measurement	8 - 2
9 Contrast Imaging	9 - 1
9.1 Basic Procedures for Contrast Imaging	9 - 1
9.2 Left Ventricular Opacification	9 - 2
9.3 Low MI Contrast Imaging	9 - 2
9.4 Image Parameters	9 - 2
9.5 Image Saving	9 - 4
9.6 Micro Flow Enhancement	9 - 4
9.7 Contrast Imaging QA	9 - 4
10 Physiological Unit Signal	10 - 1
10.1 ECG	10 - 1
10.2 Respiratory Wave	10 - 3
10.3 ECG Review	10 - 3
10.3.1 Review Principle	10 - 3
10.3.2 Linked Review of Waveforms, M/D Images and 2D Images	10 - 3
10.4 Parameter Description	10 - 4
11 Stress Echo	11 - 1
11.1 Stress Echo Acquisition Procedure	11 - 1
11.2 Selecting Preferred Stress Echo Loops (Select Mode)	11 - 2
11.3 Review/WMS Mode	11 - 4
11.3.1 Enter review mode	11 - 4
11.3.2 Wall Motion Scoring	11 - 5
11.4 Saving Stress Echo Data	11 - 6
11.5 Exiting the Stress Echo Feature	11 - 6
11.6 Measurement and Report	11 - 6

12 Display & Cine Review	12 - 1
12.1 Splitting Display	12 - 1
12.2 Image Magnification	12 - 1
12.2.1 Spot Zoom	12 - 1
12.2.2 Pan Zoom	12 - 1
12.2.3 iZoom (Full-screen Zooming)	12 - 2
12.3 Freeze/Unfreeze the Image.	12 - 2
12.3.1 Imaging Mode Switching When Frozen	12 - 2
12.4 Cine Review	12 - 2
12.4.1 Entering/Exiting Cine Review	12 - 3
12.4.2 2D Cine Review	12 - 3
12.4.3 Cine Review in M/PW/CW/TVD Mode	12 - 4
12.4.4 Linked Cine Review	12 - 5
12.5 Image Compare	12 - 5
12.5.1 Image Compare in Review Mode	12 - 5
12.5.2 Frame Compare	12 - 6
12.6 Cine Saving	12 - 6
12.6.1 Live Capture	12 - 6
12.6.2 Frozen image storage	12 - 7
12.7 Setting Cine Length	12 - 7
12.7.1 Live capture	12 - 7
12.7.2 Freeze storage setting	12 - 7
13 Measurement, Comments and Body Mark	13 - 1
13.1 Measurement	13 - 1
13.2 Comments	13 - 3
13.2.1 Adding Comments	13 - 3
13.2.2 Moving Comments	13 - 4
13.2.3 Editing Comments	13 - 5
13.2.4 Deleting Comments	13 - 5
13.2.5 Setting the Start Position	13 - 6
13.3 Body Mark	13 - 6
13.3.1 Adding Body Mark	13 - 6
13.3.2 Moving Body Marks	13 - 6
13.3.3 Deleting Body Marks	13 - 7
14 Patient Data Management	14 - 1
14.1 Image File Management	14 - 1
14.1.1 Storage Media	14 - 1
14.1.2 Image File Formats	14 - 1
14.1.3 Image Storage Setting	14 - 2
14.1.4 Quickly Saving Images to the System	14 - 2
14.1.5 Saving Images to USB Flash Drive	14 - 2
14.1.6 Exporting Cine File to USB Flash Drive	14 - 2
14.1.7 Auxiliary Output Function	14 - 3
14.1.8 Thumbnails	14 - 3
14.1.9 Image Review and Analysis	14 - 3
14.1.10 Sending Image File	14 - 4
14.2 Report Management	14 - 5

14.2.1 Report storage	14 - 5
14.2.2 Importing, exporting and sending a report	14 - 5
14.3 Patient Data Management (iStation)	14 - 5
14.3.1 Searching a Patient	14 - 6
14.3.2 Patient Data View & Management	14 - 6
14.4 Recycle bin	14 - 7
14.5 iStorage	14 - 8
14.6 Print	14 - 8
14.6.1 Image Print	14 - 8
14.6.2 Report Printing	14 - 8
14.7 Back up Files using the DVD Drive	14 - 8
14.8 Patient Task Management	14 - 9
14.9 V-Access	14 - 10
14.10 Q-Path	14 - 10
15 DICOM/HL7	15 - 1
15.1 DICOM Storage	15 - 1
15.1.1 Send images on iStation/Review/main screens	15 - 1
15.1.2 To send images using a shortcut key	15 - 2
15.1.3 To send images to storage after an exam ends	15 - 2
15.1.4 Encapsulate PDF	15 - 2
15.1.5 Unload DCM file	15 - 2
15.2 DICOM Print	15 - 2
15.2.1 Print images on iStation/Review/Main screen	15 - 2
15.2.2 To send images to DICOM Print after an exam ends	15 - 3
15.3 Worklist	15 - 3
15.4 MPPS	15 - 4
15.5 Storage Commitment	15 - 4
15.5.1 Storage commitment after sending images on the iStation screen	15 - 5
15.5.2 To send storage commitment automatically after an exam ends	15 - 5
15.6 Query/Retrieve	15 - 5
15.7 DICOM Media Storage (DICOMDIR Review)	15 - 6
15.7.1 Media Storage	15 - 6
15.7.2 Media review	15 - 6
15.7.3 Data Restore	15 - 7
15.8 Structured Report	15 - 7
16 Probes and Biopsy	16 - 1
16.1 Probes	16 - 1
16.1.1 Probe Functions by Part	16 - 3
16.1.2 Orientation of the Ultrasound Image and the Probe Head	16 - 4
16.1.3 Procedures for Operating	16 - 5
16.1.4 Wearing the Probe Sheath	16 - 7
16.1.5 Probes Cleaning and Disinfection/Sterilization	16 - 10
16.1.6 Cleaning the probe cable and connector	16 - 14
16.1.7 Probe Environmental Conditions	16 - 15
16.1.8 Storage and Transportation	16 - 16
16.2 Biopsy Guide	16 - 17
16.2.1 Needle-guided Brackets Available	16 - 19





16.2.2 Needle-Guided Bracket Inspection and Installation	16 - 20
16.2.3 Verifying the Biopsy Guide Line	16 - 41
16.2.4 Starting the biopsy procedure	16 - 42
16.2.5 Clean and Sterilize the Needle-Guided Bracket	16 - 42
16.2.6 Storage and Transportation	16 - 45
16.2.7 Disposal	16 - 45
16.3 Middle Line	16 - 45
16.4 eSpacial Navi	16 - 46
16.4.1 Interface	16 - 47
16.4.2 Preset	16 - 48
16.4.3 Preparation Before Needle Guidance	16 - 49
16.4.4 Procedure	16 - 50
16.4.5 Magnetizer Cleaning and Disinfection	16 - 50
16.4.6 Storage and Transportation	16 - 52
16.4.7 Disposal	16 - 52
17 DVR Recording	17 - 1
17.1 Start Recording	17 - 1
17.2 Send Image	17 - 1
17.3 DVR Video Replay	17 - 2
17.3.1 Replay on PC	17 - 2
17.3.2 Replay on the ultrasound system	17 - 2
18 System Maintenance	18 - 1
18.1 Daily Maintenance	18 - 1
18.1.1 Cleaning the System	18 - 1
18.1.2 Disinfecting the Main Unit	18 - 4
18.1.3 Cleaning the peripherals	18 - 4
18.1.4 Checking the Probe	18 - 5
18.1.5 Checking the Power Cable and Plug	18 - 5
18.1.6 Checking Appearance	18 - 5
18.1.7 System Hard Drive Backup	18 - 5
18.2 Troubleshooting	18 - 5
A Barcode Reader	A - 1
A.1 1-D Barcode Reader	A - 1
A.1.1 Setting Up the Reader (Take LS2208 as an example)	A - 2
A.1.2 Setting	A - 2
A.1.3 Scanning in Hand-Held Mode	A - 4
A.1.4 Scanning in Hands-Free Mode	A - 5
A.2 2D Barcode Reader (Take DS4308 as an example)	A - 7
A.2.1 Overview	A - 7
A.2.2 Setting Up the Digital Imager Reader	A - 8
A.2.3 Setting	A - 8
A.2.4 Scanning in Hand-Held Mode	A - 10
A.3 Maintenance	A - 12
A.4 Parameter Defaults	A - 12
B Trolley and Accessories	B - 1
B.1 Accessories	B - 1

B.2 Introduction of Each Unit	B - 2
C Electrical Safety Inspection	C - 1
C.1 Power Cord Plug	C - 1
C.1.1 The Power Plug	C - 1
C.2 Device Enclosure and Accessories	C - 2
C.2.1 Visual Inspection	C - 2
C.2.2 Contextual Inspection	C - 2
C.3 Device Labeling	C - 2
C.4 Protective Earth Resistance	C - 2
C.5 Earth Leakage Test	C - 2
C.6 Enclosure Leakage Test	C - 3
C.7 Patient Leakage Current	C - 3
C.8 Mains on Applied Part Leakage	C - 4
C.9 Patient Auxiliary Current	C - 4
D Wireless LAN	D - 1
D.1 Use the Wireless feature	D - 1
D.2 IP Configure	D - 2
D.3 EAP Network	D - 2
E iScanHelper	E - 1
E.1 Use iScanHelper for Reference	E - 1
E.2 Use iScanHelper for Learning or Training	E - 1
E.3 Basic Screen and Operation	E - 2
E.3.1 View Selecting Area	E - 2
E.3.2 Single/quad-window Display	E - 2
F iVision	F - 1
F.1 Demonstration item	F - 1
F.2 Demonstration catalog	F - 1
F.2.1 Demo Catalog	F - 1
F.2.2 Customize Catalog	F - 1
F.3 Copy the file	F - 2
F.4 Demonstration mode	F - 2
F.5 Option of Demo	F - 2
G List of Vocal Commands	G - 1
H Acoustic Output	H - 1
H.1 Concerns with Bioeffects	H - 1
H.2 Prudent Use Statement	H - 1
H.3 ALARA Principle (As Low As Reasonably Achievable)	H - 1
H.4 MI/TI Explanation	H - 2
H.4.1 Basic Knowledge of MI and TI	H - 2
H.4.2 MI/TI Display	H - 3
H.5 Acoustic Power Setting	H - 3
H.6 Acoustic Power Control	H - 4
H.7 Acoustic Output	H - 4
H.7.1 Derated Ultrasonic Output Parameters	H - 4

H.7.2 Limits of Acoustic Output	H - 5
H.7.3 Differences between Actual and Displayed MI and TI	H - 5
H.8 Measurement Uncertainty	H - 6
H.9 References for Acoustic Power and Safety	H - 6
I EMC Guidance and Manufacturer's Declaration	I - 1
J Indications for Use	J - 1

1 Safety Precautions

1.1 Meaning of Safety Symbols

Symbol	Description
	Type-BF applied part The ultrasound probes connected to this system are type-BF applied parts. The ECG leads within this system is type-BF applied part.
	Caution!
	General warning sign.
	Patient injury or tissue damage from ultrasonic radiation. The ALARA principle must be practiced when operating the ultrasound system.

1.2 Safety Precautions

Please observe the following precautions to ensure patient and operator's safety when using this system.

CAUTION

U.S.A. Federal Law restricts this device to sale by or on the order of a physician.

DANGER

Do not operate this system and probes in an atmosphere containing flammable gases or liquids such as anesthetic gases, hydrogen, and ethanol, because there is danger of explosion.

WARNING

- Do not connect the three-wire cable of the system with a two-wire plug without protective grounding; otherwise, electric shock may result.
- Do connect the power plug of this system to wall receptacles that meet the ratings indicated on the rating nameplate. If adapters or multi-functional

receptacles are used, it may cause the leakage current to exceed the safety requirement.

- In the environment that patient is 1.5 meters around, connect peripherals to the auxiliary power outlet, or power the peripherals by auxiliary output cable or isolation transformer complied with IEC60601-1 or the power input of the same safety level.
- DO NOT use power supply of different phases to power peripherals, like power supply of air-conditioning.
- When using peripherals not powered by the auxiliary output of the ultrasound system, or using peripherals other than permitted by Mindray, make sure the overall leakage current of peripherals and the ultrasound system meets the requirement of the local medical device electrical regulation (like enclosure leakage current should be no more than 500 uA of IEC60601-1), and the responsibility is held by the user.
- Connect the grounding conductor before turning ON the system. Disconnect the grounding cable after turning OFF the system. Otherwise, electric shock may result.
- For the connection of power and grounding, follow the appropriate procedures described in this operator's manual. Otherwise, there is risk of electric shock. Do not connect the grounding cable to a gas pipe or water pipe; otherwise, improper grounding may result or a gas explosion may occur.
- Before cleaning the system, disconnect the power cord from the outlet. System failure and electric shock may result.
- This system is not water-proof designed. Do Not use this system in any place where water or any liquid leakage may occur. If any water is sprayed on or into the system, electric shock may result or the system may be damaged. If water is accidentally sprayed on or into the system, contact Mindray Customer Service Department or sales representative.
- DO NOT use a probe that has a damaged, scratched surface, or exposed wiring of any kind. Immediately stop using the probe and contact Mindray Customer Service Department or sales representative. There is risk of electric shock if using a damaged or scratched transducer.
- Do not allow the patient to contact the live parts of the ultrasound system or other devices, e.g. signal I/O ports. Electric shock may occur.
- Do not use an aftermarket probe other than those specified by Mindray. The probes may damage the system causing a profound failure, e.g. a fire in the worst case.
- Do not subject the transducers to knocks or drops. Use of a defective transducer may cause an electric shock.
- Do not open the covers and front panel of the system. Short circuit or electric shock may result when the system hardware is exposed and powered on.
- Do not use the system with the patient when the system is being serviced or maintained.

- Do not use this system when any digital device such as a high-frequency electrotome, high-frequency therapeutic device or defibrillator is applied already. Otherwise, there is a risk of electric shock to the patient.
 - Only use the ECG leads provided with the physiology module; otherwise, electric shock may be resulted.
 - When moving the system, you should first fold the LCD display, disconnect the system from other devices (including probes) and disconnect the system from the power supply.
 - The auxiliary power output outlet in the system is used to supply power for the recommended peripheral devices. Do not connect other devices to the outlet, otherwise, the rated output power may be exceeded and failure may be resulted.
 - Accessory equipment (analog or digital) connected to the ultrasound system must comply with the relevant IEC standards (e.g., IEC 60950 information technology equipment safety standard and IEC 60601-1 medical equipment standard). Furthermore, all configurations must comply with the standard IEC60601-1. It is the responsibility of the person, who connects additional equipment to the signal input or output ports and configures a medical system, to verify that the system complies with the requirements of IEC60601-1. If you have any questions regarding these requirements, consult your vendor.
 - Prolonged and repeated use of keyboards may result in hand or arm nerve disorders for some individuals. Observe the local safety or health regulations concerning the use of keyboards.
 - When using intra-cavity transducers, do not activate the transducer outside the patient's body.
 - It is not allowed for the operator to have contact with other patients and the electronic parts (such as the input/output terminal of the signal) of other devices that are connected to the system. Otherwise, it may produce the electrical shock to the patient.
 - The operator SHOULD NOT touch Signal Input Ports/Signal Output Ports and the patient at the same time.
 - DO NOT block the cooling vent of the system.
 - Do not expose the device to a magnetic resonance (MR) environment.
-

CAUTION

- Precautions concerning clinical examination techniques:
 - This system must be used only by qualified medical professionals.
 - This operator's manual does not describe clinical examination techniques. The clinician should select the proper examination techniques based on specialized training and clinical experience.
- Malfunctions due to radio wave:

- If a radio wave emitting device is used in the proximity of this system, it may interfere with operations. Do not use or take any devices transmitting RF signals (such as cellular phones, transceivers and radio controlled products) in the room placing the system.
- If a person brings a device that generates radio waves near the system, ask him/her to immediately turn OFF the device.
- Precautions concerning movement of the system:
 - When you place the system on the mobile trolley and move them together, you must secure all objects on the mobile trolley to prevent them from falling. Otherwise you should separate the system from the mobile trolley and move them individually.
When you have to move the system with the mobile trolley upward or downward the stairs, you must separate them first and then move them individually.
 - Object placed on the monitor may fall and injure an individual when moving.
 - Confirm that there is no peripheral device connected to the system before moving the system. Otherwise, peripheral device may fall and injure an individual.
- If the circuit protector is tripped, it indicates that the system or a peripheral device was improperly shut down and the system is unstable. You cannot repair the system under this circumstance and must call the Mindray Customer Service Department or sales representative.
- There is no risk of high-temperature burns during normal ultrasound examinations. It is possible for the surface temperature of the transducer to exceed the body temperature of a patient due to environmental temperature and exam type combinations. Do not apply the transducer to the same region on the patient for a long time. Apply the transducer only for a period of time required for the purpose of diagnosis.
- Do not use the system to examine a fetus for a long period of time.
- Except accessories that have been stated as sterile, the system and its accessories are not disinfected or sterilized prior to delivery. The operator is responsible for the cleaning and disinfection of probes and sterilization of biopsy brackets according to the manuals, prior to the use. All items must be thoroughly processed to completely remove harmful residual chemicals, which will not only harmful to the human body, but also damage the accessory.
- It is necessary to end the current scan that is in progress and clear the current Patient Information field. Otherwise, new patient data may be combined with the previous patient data.
- Do not connect or disconnect the system's power cord or its accessories (e.g., a printer or a recorder) without turning OFF the system power first. This may damage the system and its accessories or cause electric shock.
- If the system is powered off improperly during operation, it may result in data damage of the system's hard disk or system failure.

- Do not use a USB memory device (e.g., a USB flash drive, removable hard disk) which has unsafe data. Otherwise, system damage may result.
 - It is recommended to only use the video devices specified in this manual.
 - Do not use gel, disinfectant, probes, probe sheath or needle-guided brackets that are not compatible with the system.
 - The applied contrast agency should be compliant with the relevant local regulations.
 - Read the Acoustic Output Principle in the operation manual carefully before operating this system on clinical examination.
 - The cover contains natural rubber that can cause allergic reactions in some individuals.
 - Please use the ultrasound gel compliant with the relevant local regulations.
 - DO NOT expose the system to excessive vibration through transportation. Mechanical damage may result.
 - Always keep the system dry. Avoid transporting this system quickly from a cold place to a warm place; otherwise condensation or water droplets may form allowing a short circuit and possible electric shock.
-

NOTE:

- DO NOT use the system in the vicinity of strong electromagnetic field (such as a transformer), which may affect the performance of the system.
- Do not use the system in the vicinity of high-frequency radiation source (e.g. cellular phones), which may affect the performance of the system or even lead to failure.
- When using or placing the system, keep the system horizontal to avoid imbalance.
- To avoid damaging the system, do not use it in following environment:
 - Locations exposed to direct sunlight.
 - Locations subject to sudden changes in environmental temperature.
 - Dusty locations.
 - Locations subject to vibration.
 - Locations near heat generators.
 - Locations with high humidity.
- Turn ON the system only after the power has been turned OFF for a while. If the system is turned ON immediately after being turned OFF, the system may not be rebooted properly and could malfunction.
- Use the Freeze key to freeze an image or turn off the power of the system before connecting or disconnecting a probe.
- Remove the ultrasound gel from the face of the transducer when the examination is completed. Water in the gel may enter the acoustic lens and adversely affect the performance and safety of the transducer.
- You should properly back up the system to a secure external storage media, including system configuration, settings and patient data. Data stored to the system's hard drive may be lost due to system failure, improper operation or accident.
- Do not apply external force to the control panel. Otherwise, the system may be damaged.

- If the system is used in a small room, the room temperature may rise. Please provide proper ventilation and free air exchange.
 - To dispose of the system or any part, contact Mindray Customer Service Department or sales representative. Mindray is not responsible for any system content or accessories that have been discarded improperly.
 - Electrical and mechanical performance may be degraded due to long usage (such as current leakage or distortion and abrasion); the image sensitivity and precision may become worse too. To ensure optimal system operations, it is recommended that you maintain the system under a Mindray service agreement.
 - Refer replacing job to Mindray service engineers or engineers authorized by Mindray only.
 - Do not turn OFF the power supply of the system during printing, file storage or invoking other system operations. An interrupted process may not be completed, and can become lost or corrupted.
 - Ensure that the current exam date and time are the same as the system date and time.
 - Use detachable power supply cord as mains power breaking device. DO NOT set equipment in place where difficult for disconnection of detachable power supply cord.
-

Please read the following precautions carefully to ensure the safety of the patient and the operator when using the probes.

 **WARNING**

- The ultrasound probe is only for use with the specified ultrasound diagnostic system.
 - The ultrasound probe must be used only by qualified professionals.
 - Confirm that the transducer and probe cable are normal before and after each examination. A defective probe may cause electric shock to the patient.
 - Do not subject the probe to shock. A defective probe may cause electric shock to the patient.
 - Do not disassemble the probe to avoid the possibility of electric shock.
 - Never immerse the probe connector into liquids such as water or disinfectant because the connector is not waterproof. Immersion may cause electric shock or malfunction.
 - A transducer sheath must be installed over the transducer before performing examination.
 - When using a probe, pay attention to the status of the ultrasound image. Do not use the probe to perform image acquisition when the image is frozen.
-

 **CAUTION**

- When using the probe, wear sterile gloves to prevent infection.
 - Be sure to use sterile ultrasound gel. Please use the ultrasound gel compliant with the relevant local regulations. And manage the ultrasound gel properly to ensure that it does not become a source of infection.
-

- In normal diagnostic ultrasound mode, there is no danger of a normal-temperature burn; however, keeping the probe on the same region of the patient for a long time may cause such a burn.
 - Do not use the carrying case for storing the transducer. If the carrying case is used for storage, it may become a source of infection.
 - It is required to practice ALARA when operating ultrasound system. Minimize the acoustic power without compromising the quality of images.
 - The probe and accessories supplied with it are not delivered disinfected or sterilized. Sterilization (or high-level disinfect) before use is required.
 - Disposable components should be packaged sterile and for single-use only. Do not use if integrity of packaging violated or if expiration date has passed. Please use the disposable components compliant with the relevant local regulations.
 - Please use the disinfection or sterilization solution recommended in this operator's manual; otherwise Mindray will not be liable for damage caused by other solutions. If you have any questions, please contact Mindray Customer Service Department or sales representative.
 - Do not use pre-lubricated condoms as a sheath. Lubricant may not be compatible with the probe material and damage may result.
 - The damage of the transducer may be caused by the contact of improper gel or cleaner:
 - DO NOT dip the transducer in the strong polar solution of ethanol, chloride of lime, ammonium chloride, acetone and formaldehyde.
 - DO NOT contact the transducer with solution or ultrasound gel containing oily medium such as mineral oil or lanoline.
-

NOTE:

- Read the following precautions to prevent the probe from malfunction:
 - Before connecting or disconnecting the probe, freeze or turn off the diagnostic ultrasound system.
 - Clean and disinfect the probe before and after each examination.
 - After the examination, wipe off the ultrasound gel thoroughly. Otherwise, the ultrasound gel may solidify and the image quality would be degraded.
 - Repeated disinfection will eventually damage the probe, please check the probe performance periodically.
-

1.3 Latex Alert

When choosing a probe sheath, it is recommended that you directly contact CIVCO for obtaining information regarding probe sheaths, pricing, samples and local distribution.

For CIVCO information, please contact the following:

CIVCO Medical Instruments

Tel: 1-800-445-6741

www.civco.com

 **WARNING**

Allergic reactions in patients sensitive to latex (natural rubber) may range from mild skin reactions (irritation) to fatal anaphylactic shock, and may include difficulty breathing (wheezing), dizziness, shock, swelling of the face, hives, sneezing, or itching of the eyes (FDA Medical Alert on latex products, “Allergic Reactions to Latex-containing Medical Devices”, issued on March 29, 1991).

2 System Overview

2.1 Intended Use

NOTE:

The system is not intended for central cardiovascular or central nervous system use.

Diagnostic Ultrasound System is applicable for adults, pregnant women, pediatric patients and neonates. It is intended for use in ophthalmic, fetal, abdominal, pediatric, small organ (breast, thyroid, testes), neonatal cephalic, adult cephalic, trans-rectal, trans-vaginal, musculo-skeletal (conventional), musculo-skeletal (superficial), thoracic/pleural, cardiac adult, cardiac pediatric, peripheral vessel and urology, intra-operative (abdominal, thoracic, and vascular), trans-esoph (Cardiac) exams.

Modes of operation include: B, M, PWD, CWD, Color Doppler, Amplitude Doppler, Combined mode (B+M, PW+B, Color+B, Power+B, PW+Color+B, Power+PW+B), Tissue Harmonic Imaging, iScape, TDI, color M, Smart 3D, Strain Elastography, Contrast imaging (Contrast agent for LVO), Contrast imaging (Contrast agent for Liver).

2.2 Contraindication

For FDA region: None.

For Canada region: Ophthalmic use is only permitted by probes with an ophthalmic indication.

2.3 Safety Classifications

- According to the type of protection against electric shock:
Class I equipment + internally powered equipment
- According to the degree of protection against electric shock:
Type-BF applied part
- According to the degree of protection against harmful ingress of water:
 - The main unit is rated as IPX0
 - The probes are rated as IPX7
 - The foot switch (can be applied in the operating room) is rated as IPX8
 - The power adapter is rated as IP22
- According to the disinfection and sterilization method(s) recommended by manufacturer:
Equipment with disinfection and sterilization method(s) recommended by manufacturer.
- According to the degree of safety of application in the presence of a FLAMMABLE ANESTHETIC MIXTURE WITH AIR or WITH OXYGEN OR NITROUS OXIDE
EQUIPMENT not suitable for use in the presence of a FLAMMABLE ANESTHETIC MIXTURE WITH AIR or WITH OXYGEN OR NITROUS OXIDE

- According to the mode of operation:
Continuous operation
- According to the installation and use:
Portable equipment
Mobile equipment (when the system is installed on the mobile trolley)
- Does the equipment has any defibrillation-proof applied parts:
Non-defibrillation-proof applied part
- Permanently installed equipment or non-permanently installed equipment:
Non-permanently installed equipment

2.4 Product Specifications

NOTE:

The functions described in the operator's manual may vary depending on the specific system purchased.

2.4.1 Power supply

- Voltage: 100 V - 240 V AC
- Frequency: 50/60 Hz
- Power input: 2.0-1.0A; Trolley power input: 4.4-2.5A
- Battery voltage: 14.4 V

2.4.2 Environmental Conditions

- Operating conditions
 - Ambient temperature: 0 °C ~ 40 °C
 - Relative humidity: 20% ~ 85% (no condensation)
 - Atmospheric pressure: 700 hPa ~ 1060 hPa
- Storage and transportation conditions
 - Ambient temperature: -20 °C ~ 55 °C
 - Relative humidity: 20% ~ 95% (no condensation)
 - Atmospheric pressure: 700 hPa ~ 1060 hPa

WARNING

Do not use this system in conditions other than those specified.

2.4.3 Dimensions and Weight

- Dimensions (D×W×H, unit: mm): (322±5) × (364±5) × (44±3)
- Weight (including batteries): <4.0 kg

2.5 Product Differences

Model	Histogram	Profile	Color Vel	Double-Dist	Spline length	Parallel line	Cross	Appearance
MX7	√	√	√	√	√	√	√	Blue
MX7T	√	×	√	√	√	√	√	
Vaus7	×	×	√	√	√	√	√	
Zeus	√	√	×	×	√	√	√	
ME7	√	√	√	√	√	×	√	
Anesus ME7	√	×	√	√	√	×	√	
Anesus ME7T	×	×	√	√	√	×	√	
MX7P	√	×	×	√	×	√	√	
MX7W	√	√	×	×	×	√	√	
MX8	√	√	√	√	√	√	√	
MX8T	√	×	√	√	√	√	√	
Vaus8	×	×	√	√	√	√	√	
ME8	×	×	×	√	√	√	×	

NOTE:

- Histogram - measures and counts the gray distribution of ultrasonic echo signals within a closed region.
- Profile - measures the gray distribution of ultrasonic echo signals on a line.
- Color Vel - measures the velocity of blood flow on the Color Mode image.
- Double-Dist - measures the lengths of line segments A and B perpendicular to each other.
- Spline length - measures the length of a curve on the image.
- Parallel line - measures the distance between every two line segments of five parallel line segments, namely, four distances in total.
- Only MX7, MX7T, ME7, MX8 and ME8 are available in Canada.

2.6 System Configuration

2.6.1 Standard Configuration

- Main unit
- Power adapter
- Built-in batteries
- System software
- Travelling case
- Accessories
 - Operator's manuals
 - User-defined label

– Cables

2.6.2 Probes and Needle-guided Brackets Available

Please see “16 Probes and Biopsy”.

2.6.3 Options

Item		Remarks
Customized button tags		/
Mobile Trolley		Power supply, retractable cable
		Power supply, without retractable cable
		Without power supply, without retractable cable
ECG module		/
Multilingual controls overlay		/
Dust-proof cover		/
WiFi module		/
ECG cables		ECG module should be configured
DC-IN cable		ECG module should be configured
U-Bank (2 Batteries or 4 Batteries)		/
Ultrasound gel		/
Magnetizer package		/
Main unit cover		/
Display cover		/
Special imaging	iScape View	/
	Free Xros M	/
	Free Xros CM	/
	Tissue Doppler Imaging	Cardiology Package should be configured.
	TDI QA	TDI should be configured.
	CW	/
	Contrast imaging	/
	Contrast Imaging QA	Contrast Imaging should be configured.
	LVO	Cardiology Package should be configured.
	Low MI Contrast	Cardiology Package should be configured.
	Strain Elastography	/
	Stress Echo	Cardiology Package should be configured.
	Tissue Tracking QA	Cardiology Package should be configured.
	Smart 3D	/

Item		Remarks
DICOM	DICOM Basic	DICOM Basic, including: <ul style="list-style-type: none">• Verify (SCU and SCP)• Task management• DICOM Storage• DICOM Print• DICOM Storage Commitment• DICOM Media Storage (including DICOM DIR)
	DICOM Worklist	DICOM Basic should be configured.
	DICOM MPPS	
	DICOM Query/Retrieve	
	DICOM OB/GYN SR	
	DICOM Vascular SR	
	DICOM Cardiac SR	
	DICOM Breast SR	
	DICOM Abdomen SR	

	Item	Remarks
Application packages	Abdomen/General Package	/
	Obstetrics Package	/
	Smart OB	Obstetrics package should be configured.
	Smart NT	Obstetrics package should be configured.
	Gynecology Package	/
	Cardiology Package	/
	Small Parts Package	/
	Urology Package	/
	Vascular Package	/
	Pediatrics Package	/
	Nerve Package	/
	Emergency&Critical Package	/
	RIMT	Vascular Package should be configured.
	AutoEF	Cardiology Package should be configured.
	R-VQS	Vascular Package should be configured.
	Smart B-line	/
	Smart VTI	Cardiology Package should be configured.
	Smart IVC	/
	CPP	/
	Smart FHR OB1	/
Smart Bladder	/	
Auto DFR	/	
Auto GA	/	
Others	iWorks	/
	iNeedle	/
	eSpacial Navi	/
	iVocal	/
	McAfee	/
	DVR Module	/

2.6.4 Peripherals Supported

Item	Model
Black/ white video printer (digital)	MITSUBISHI P95DW-N

Item	Model
Black/ white video printer (analog)	SONY UP-X898MD
Digital color video printer	SONY UP-D25MD
iVocal	SAMSON XPD1 Headset SAMSON XPD1 Presentation PYLE PUSBMIC43
External DVD R/W drive	DVDRW HP GP60NB60
Barcode reader	DS4308 LS2208 JADAK HS-1M JADAK HS-1R Honeywell HH1800
Footswitch	971-SWNOM (2-pedals) 971-SWNOM (3-pedals) FS-81-SP-2 (1-pedal)

2.6.5 Parts that can be used within patient environment



- The ultrasound system
- Video Printers

2.7 Introduction of Each Unit

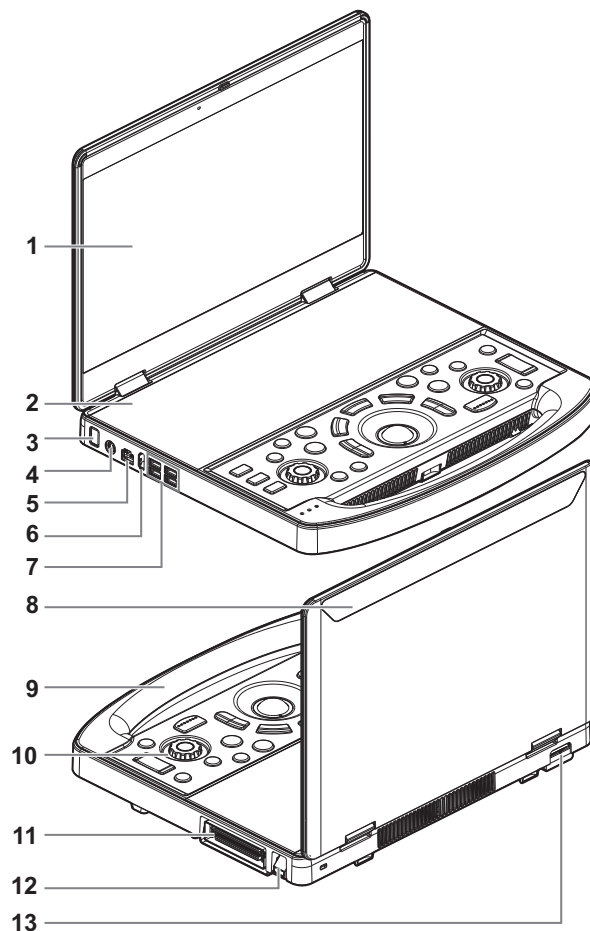
Figure 2-1 Overview



No.	Name	Description
1.	Display	Displays the images and parameters during scanning.
2.	Touch screen	Screen-touching operator-system interface or control.
3.	Power button/Power indicator	Used for turning on/ off the power. The indicator lights up when the system is powered on.
4.	S-Video	S-Video signal output. Used for separate video output, and connecting projector, ultrasound workstation video capture card, etc.
5.	Network port	Used for connecting router, ultrasound workstation, server, etc.
6.	HDMI	High definition multimedia interface. Used for connecting TV, projector, ultrasound workstation video capture card, etc.*
7.	USB ports	Used for connecting storage device such as USB disk, bar code reader, printer, footswitch, DVD recorder, etc.

No.	Name	Description
8.	Secondary Display	Displays battery capacity, AC power status and product model, etc. NOTE: The actual remaining time of the battery varies depending on the actual operating modes.
9.	Handle	Used for carrying the system.
10.	Control Panel	Operator-system interface or control. NOTE: The buttons and knobs on the control panel may be different for different product models. Please refer to the control panel of the product for the actual buttons and knobs.
11.	Probe port	Connects a probe to the main unit; or connects a probe extend module.
12.	Probe locking lever	Locks or unlocks the probe connected with the main unit: <ul style="list-style-type: none"> • : locked symbol. • : unlocked symbol.
13.	Power input port	Connects the power adapter.

2.8 U-Bank Overview

WARNING

- Only technical professionals from Mindray or engineers authorized by Mindray after training can perform batteries in the U-Bank installation and uninstallation.
- If you need to change the batteries in the U-Bank, please contact your sales representative.

Specifications are as follows:

- Voltage: 19V DC
- Capacity: 26400 mAh or 13200 mAh

Under power off or standby status, charging time of the battery from capacity 0 to 100% takes about 5 hours.

U-Bank environmental conditions are as follows:

- Operating conditions
 - Ambient temperature: 0 °C ~ 35 °C
 - Relative humidity: 20% ~ 85% (no condensation)
 - Atmospheric pressure: 700 hPa ~ 1060 hPa
- Storage and transportation conditions
 - Ambient temperature: -20 °C ~ 55 °C
 - Relative humidity: 20% ~ 95% (no condensation)
 - Atmospheric pressure: 700 hPa ~ 1060 hPa

2.8.1 Parts and Names

Figure 2-2 U-Bank

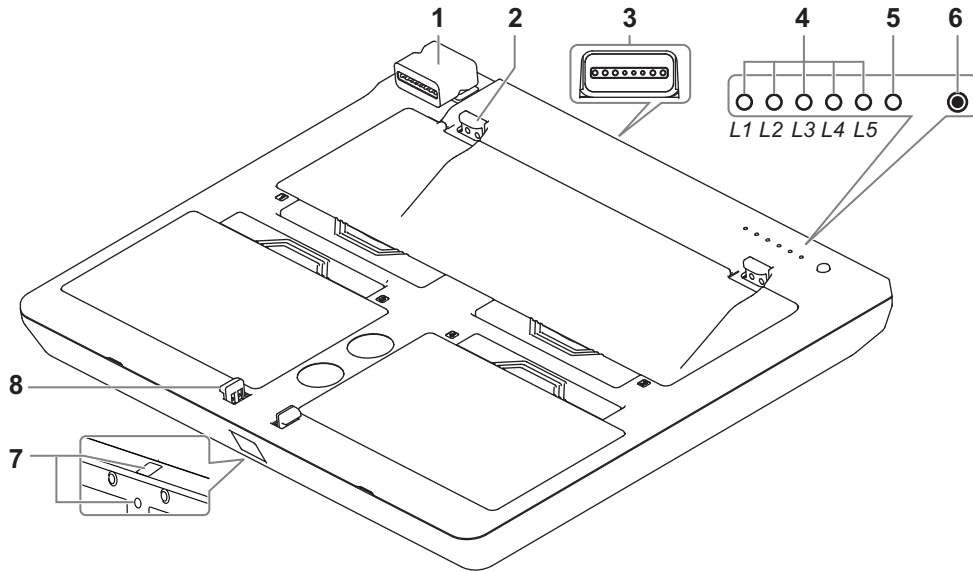

No.	Name	Description
1.	Power connector	Connects to the power input port of the system.
2.	Tabs	Used for fixing the U-Bank to the system.
3.	Charging input port	Connects the power adapter.
4.	Capacity indicators (L1~L5)	<p>Indicates the power of the U-Bank.</p> <ul style="list-style-type: none"> The L1-L5 indicators remain on: fully charged or > 80%. The L1-L4 indicators remain on: 60% < remaining capacity ≤ 80%. The L1-L3 indicators remain on: 40% < remaining capacity ≤ 60%. The L1-L2 indicators remain on: 20% < remaining capacity ≤ 40% The L1 indicator remains on: 10% < remaining capacity ≤ 20% The L1 indicator blinks: remaining capacity ≤ 10%

No.	Name	Description
5.	Battery status indicator	<p>Indicates the charge/discharge status of the U-Bank.</p> <ul style="list-style-type: none"> When the battery is charging: Not fully charged: the indicator lights in orange. Fully charged: the indicator lights in green. When the battery is discharging: The remaining capacity $\geq 20\%$: the indicator lights in green. The remaining capacity $< 20\%$: the indicator blinks in orange. The remaining capacity $\leq 5\%$: the indicator blinks in orange quickly. <p>NOTE:</p> <p>When the U-Bank is charging or when you are pressing the power button, the indicator blinks in orange for 5s, and other indicators remain off. It indicates that the U-Bank may have malfunction. Please stop using the U-Bank and contact the Mindray service engineers or your sales representative.</p>
6.	Power button	Used for checking the U-Bank power status.
7.	Detach levers	<p>Used for detaching the U-Bank from the system.</p> <p>One is located at front side, and the other is located at the bottom.</p> <p>NOTE:</p> <p>Press the two levers at the same time to detach the U-Bank from the system. When the U-Bank is placed on a flat platform, just use the front lever to detach.</p>
8.	Lock/Release tabs	<p>Used for fixing the U-Bank to the system.</p> <p>Release the U-Bank from the system by using the detach lever(s).</p>

2.8.2 Installing the U-Bank

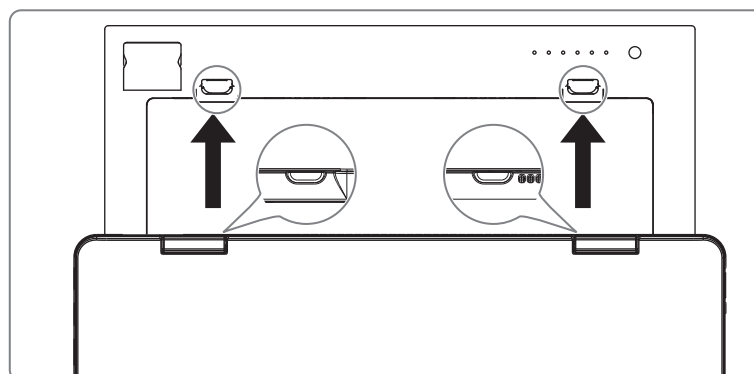

1. Place U-Bank to a flat and solid platform.
2. Align the grooves of the system with the tabs of U-Bank.

3. Push the system in the arrow direction as shown in the figure above until the system is locked in place.

TIP:

To remove the U-Bank from the system, press the detach lever of U-Bank and lift up slightly the system by holding the system's handle.

2.9 ECG Module Overview

Figure 2-3 ECG module

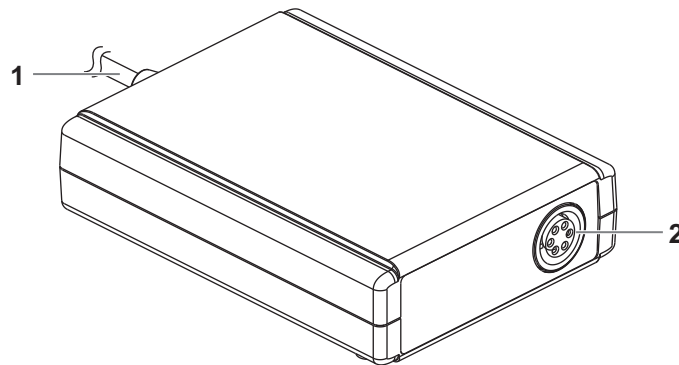

No.	Name	Description
1.	USB cable	Connects to the USB port of the system. NOTE: <ul style="list-style-type: none"> • Ensure the system is powered off before connecting the ECG module. • The ECG module is only for use with the specified system.
2.	ECG lead port	Used for ECG signal input.

2.10 Control Panel

Figure 2-4 Control panel configured with trackball

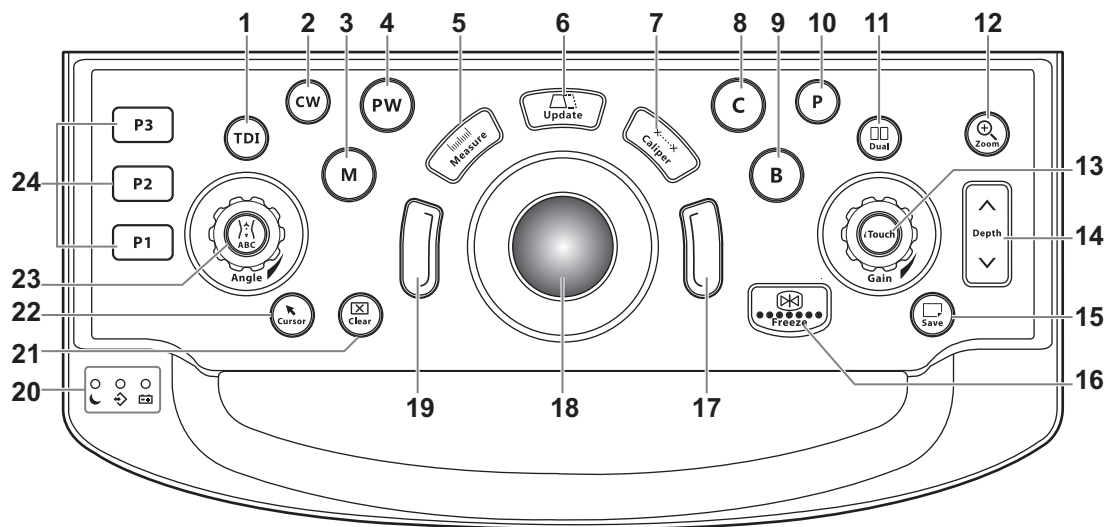
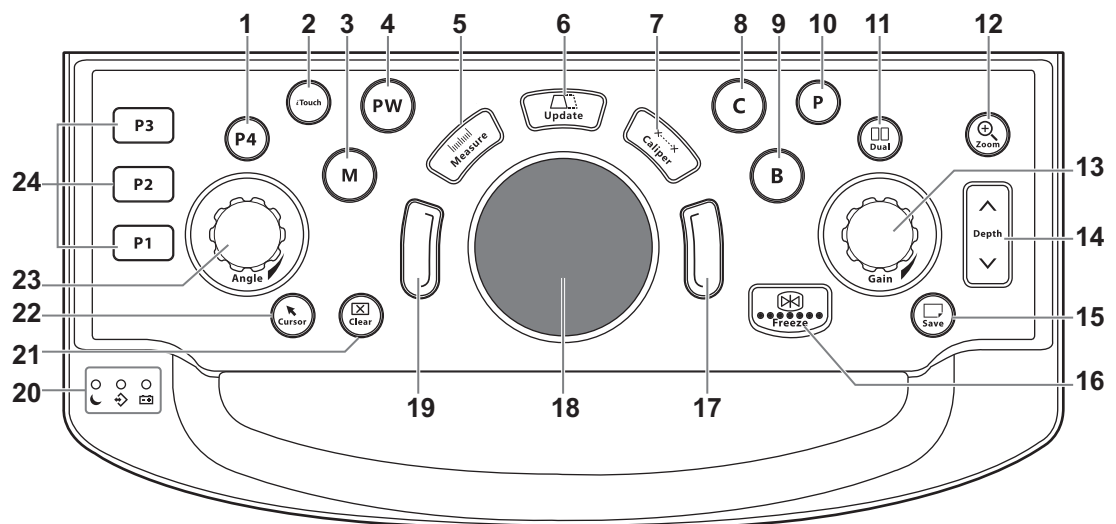











Figure 2-5 Control panel configured with trackpad



No.	Name	English Name	Description
1.	TDI	TDI mode button	Enters TDI mode.
	P4	User-defined key	Undefined button, set by the user in preset.
2.	CW	CW mode button	Enters CW mode.
	iTouch	iTouch button	<ul style="list-style-type: none"> Press to enter iTouch mode. Long press to exit iTouch mode.
3.	M	M mode button	Press to enter M mode.
4.	PW	PW mode button	Press to enter PW mode.
5.	Measure	Measure button	Press to enter/exit application measurement.

No.	Name	English Name	Description
6.	 Update	Update button	Switching key: Press to change the currently active window. Start or end capturing the image in iScape/Smart 3D.
7.	Caliper	Caliper button	Press to enter/exit general measurement.
8.	C	Color mode button	Press to enter Color mode.
9.	B	B mode button	Press to enter B mode.
10.	P	Power mode button	Press to enter Power mode.
11.	 Dual	Dual-split window button	Press to enter the Dual mode from another mode. Press to switch between the two windows in the Dual mode.
12.	 Zoom	Image zoom	Press to enter or exit zoom status.
13.	iTouch/Gain	Gain and iTouch knob	Adjust the gain of the image in various modes. <ul style="list-style-type: none"> • Press to enter iTouch mode. • Long press to exit iTouch mode.
	Gain	Gain knob	Adjust the gain of the image in various modes.
14.	Depth	Depth adjustment button and functional interface	Adjust the depth parameter when the indicator is on.
15.	 Save	Save static image button	Save images in a preset way.
16.	 Freeze	Freeze button	Press to freeze or defreeze the image.
17.	/	Confirm key (right <Set> key)	Press to confirm the operation.
18.	/	Trackball	To move the cursor.
	/	Trackpad	To move the cursor; tap to confirm the operation.
19.	/	Confirm key (left <Set> key)	Press to confirm the operation.

No.	Name	English Name	Description
20.		Standby status indicator	Standby indicator. Standby: blinking in orange. Other status: light off.
		Hard disk read indicator	Hard disk status indicator. The indicator blinks in green when hard disk is running. The indicator is off on the other status. NOTE: DO NOT move the machine when the indicator blinking in green. Otherwise the hard disk may be damaged by sudden shake.
		Battery indicator	Battery status indicator. <ul style="list-style-type: none"> Charging status: It illuminates in orange when batteries are charging; It illuminates in green when batteries are charged fully. Discharging status: It illuminates in green color when the power of the batteries is sufficient; It illuminates in orange color for low battery power.
21.	Clear	Clear button	Press to clear off the comments or measurement calipers on the screen.
22.	 Cursor	Cursor button	Press to show/hide the cursor.
23.	 Angle/ Multi- functional knob	Body mark/ Comment/Angle/ Multi-functional knob	<ul style="list-style-type: none"> Press to enter/ exit the body mark/textual comment mode. Rotate to adjust probe marker orientation of body mark. Rotate to adjust image parameters or direction of comment arrows.
	Angle/Multi- functional knob	Angle/Multi- functional knob	<ul style="list-style-type: none"> Rotate to adjust probe marker orientation of body mark. Rotate to adjust image parameters or direction of comment arrows.
24.	P3/P2/P1	User-defined keys	Undefined buttons, set by the user in preset.

2.11 Exam Main Menu Screen

Figure 2-6 Exam Main Menu

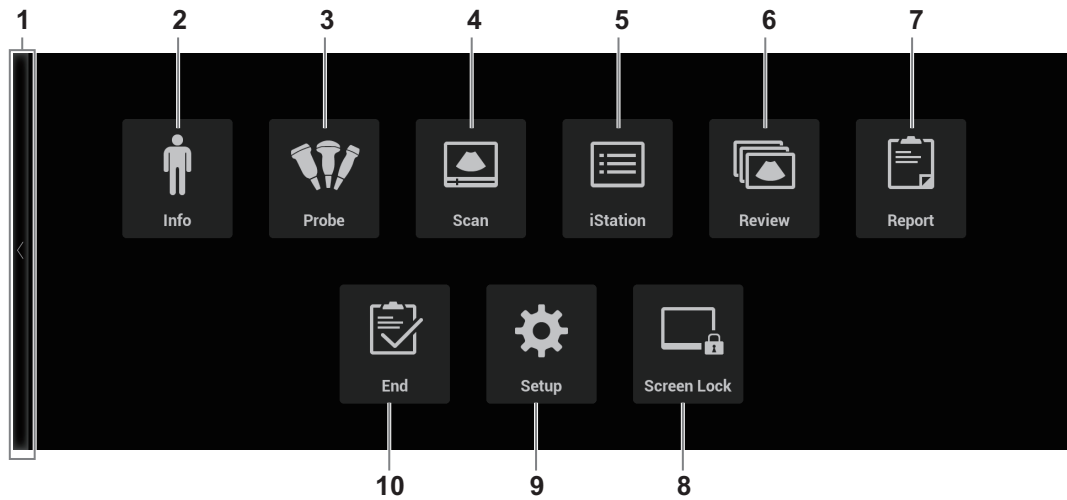

No.	Icon	Name	Description
1.	>/<	Exam Main Menu switch bar	Tap to enter exam main menu/return to the previous screen.
2.		Patient Information button	Tap to enter the Patient information screen.
3.		Probe/exam mode switch button	Tap to switch probe and exam mode.
4.		Scan button	Tap to enter B imaging mode.
5.		Patient data management system button	Tap to enter or exit patient information system.
6.		Image review button	Tap to review the stored images.
7.		Report button	Tap to open/ close the exam report.
8.		Screen Lock button	Tap to lock the system for 10 seconds.
9.		Setup button	Tap to enter/exit Setup.
10.		End exam button	Tap to end an exam.

2.12 Monitor Display

Figure 2-7 Monitor Display

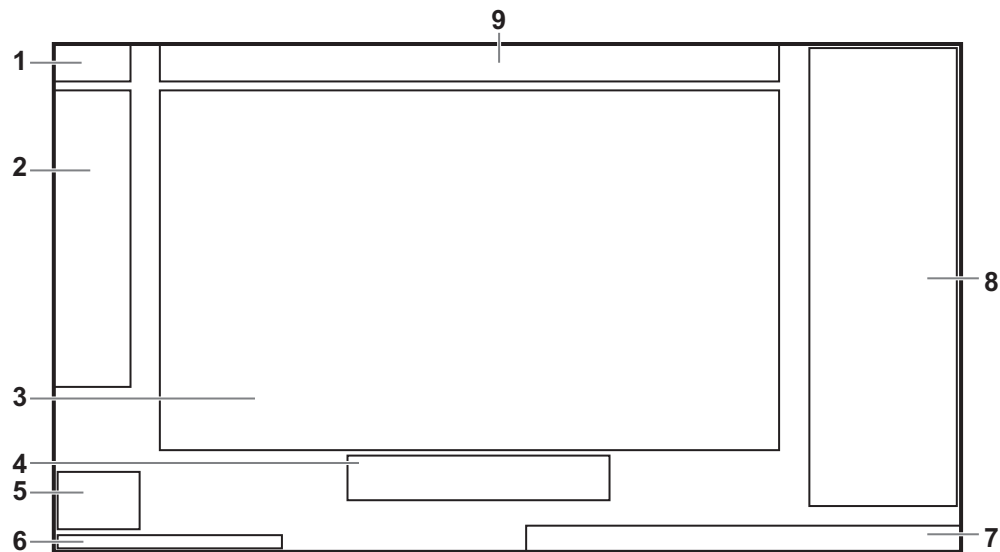

No.	Item	Description
1.	System Information Area	Displays the manufacturer's logo and product model.
2.	Parameters Area	Displays the image parameters for the active window. If there are more than one imaging modes, the parameters are displayed by each mode.
3.	Image Area	Displays the ultrasound images, ECG waveforms, probe mark (or active window mark), time line (in M or PW mode), coordinate axis (including depth, time, velocity/frequency), besides, the comments, bodymark, measurement calipers, color bar/grayscale bar are also displayed here.
4.	Hint (trackball/trackpad and <Set> key function indications)	Displays the current functions of trackball/trackpad and <Set> keys.
5.	User-defined Keys Area	Displays the functions for the user-defined keys.
6.	Help Information Area	Displays various help information items or the progress bar in the current status.
7.	System Icons Area	Displays the relevant system icons, such as USB memory device, printer, network, and current system time, etc.
8.	Clip board/Thumbnails Area	Displays the thumbnail images stored under the current patient. <ul style="list-style-type: none"> When there are more than one page images have been stored, you can turn to the next or preview page by ▼ or ▲ respectively. Click  to enter review screen.

No.	Item	Description
9.	Patient Information Area	Displays the hospital name, the exam time, patient information, the probe model, the exam mode, etc. To preset which kind of patient information is displayed, see “4.1.2 General”

2.13 Basic Operations

2.13.1 Dialog Box

Take the patient information screen as an example.

User Interface Controls

A dialog box screen consists of title, tab pages, contents and buttons, etc.

- Title bar
The title bar is used to give a description of the content and function of the screen.
- Tab page
For some screens, the contents are distributed across several pages. Use the <Set> key to open/close the available pages.
- Content
 - Radio box: click to select the item.
 - Check box: click to check or uncheck the item.
 - Text box: enter characters manually via the keyboard.
 - Drop-down list box: click [▼] to show the list and select an item.
- Standard buttons
When the operation of a screen is completed, click the [OK] or [Cancel] button to save or cancel the operation, and close the screen.

To reposition a dialog box

1. Use the trackball/trackpad to move the cursor onto the title bar of the dialog box.
At this time the cursor becomes a , then press <Set> key.
2. Use the trackball/trackpad and position the rectangular graphic to the new desired location.
3. Release <Set> key, and the dialog box is moved to the desired position.

2.13.2 Touch Screen

Select Exam Mode and Probe

CAUTION

If the exam mode is changed during a measurement, all measurement calipers on the image will be cleared. The data of general measurements will be lost, but the data of application measurements will be stored in the reports.

Connect proper probes to the system, and tap [Probe] on the touch screen, the touch screen displays the following dialog box.

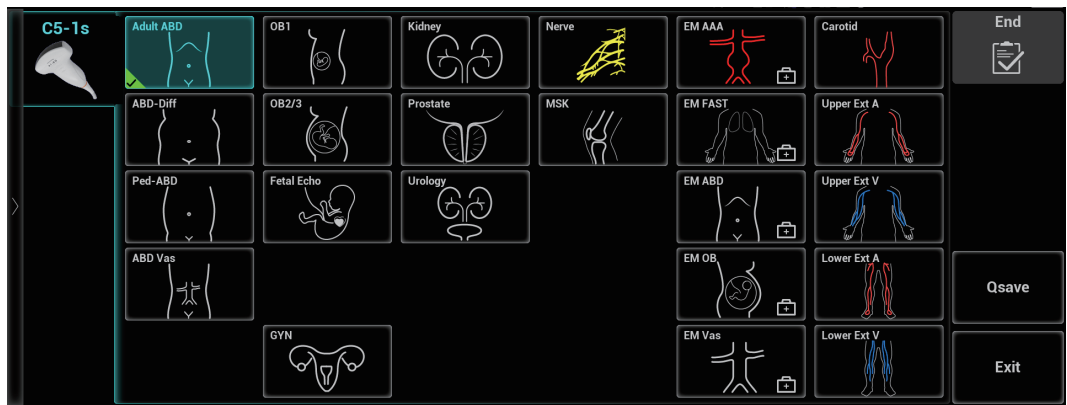

Imaging Mode Screen

The layout of the touch screen varies with the applications or modes. Flip the touch screen to go to another page. Learn the interface display and operations by referring to related chapters.

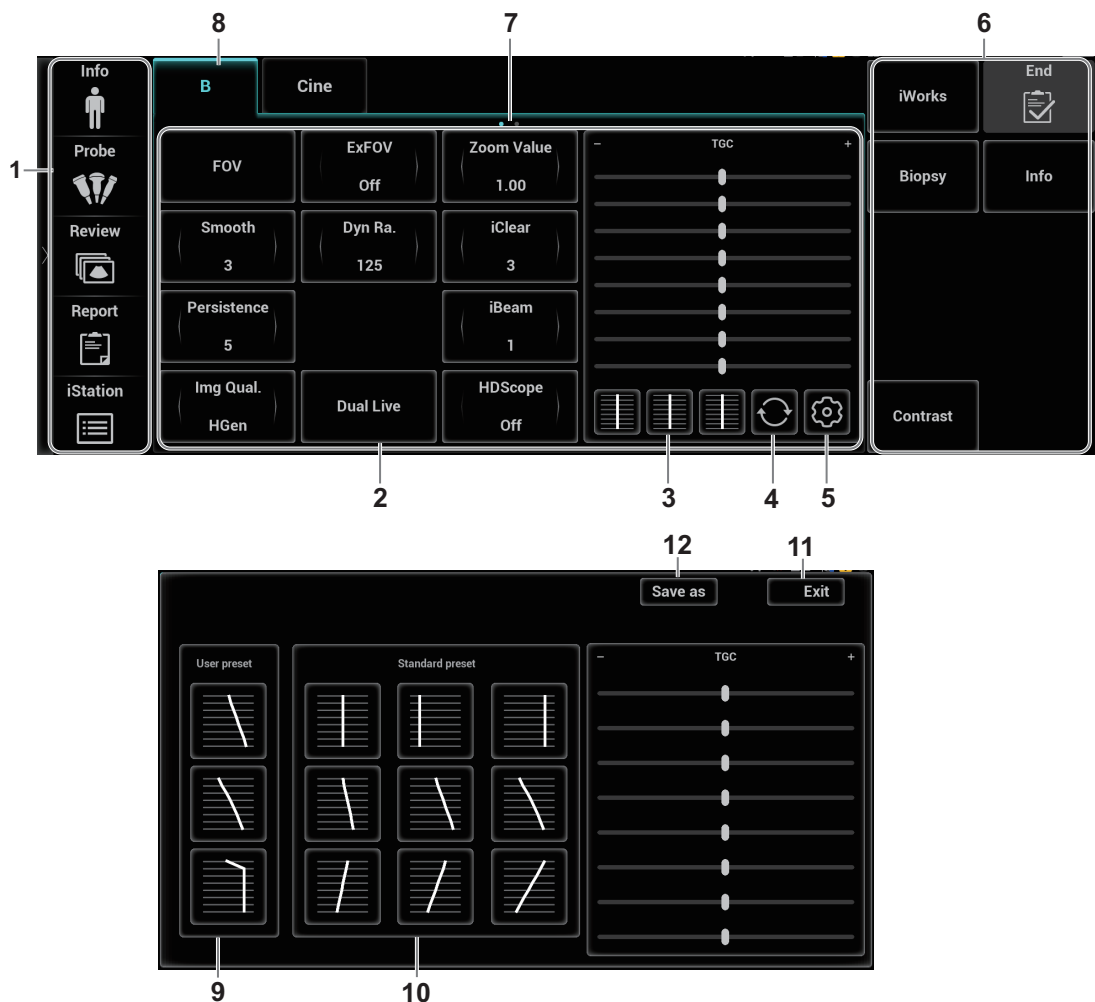

No.	Item	Description
1.	Exam Procedure Group	Display the exam procedure menu. see “4.1.2 General” to set Touchpad Display after Ending Exams.

No.	Item	Description
2.	Parameter adjusting area	<p>Displays the parameters in the current imaging mode or function.</p> <ul style="list-style-type: none"> Parameter magnitude setting: Tap the left/right part of the parameter button, or tap to select the parameter button and rotate the multi-functional knob to increase/decrease the value. ON/OFF setting: some of the parameters only can be set at ON or OFF, ON is to activate the function, and when the function is activated, the key is highlighted. Parameter submenu: tap to pop-up the submenu to select the desired value. <p>NOTE:</p> <p>If the parameters cover more than two pages, tap and slide the area to left or right to find more.</p>
3.	Quick Adjustment	Tap to quickly adjust the TGC sliders.
4.	Restore button	Tap to restore TGC to the original status.
5.	Setup button	Tap to enter TGC setup page.
6.	Other application mode entrance	Displays the available application modes related, click to enter the modes.
7.	Page-turning	If there is more than one page of parameters for the current imaging mode, you can slide to view more.
8.	Mode displaying area (or main functional tabs)	Displays the current modes, tap to enter the corresponding mode.
9.	User Preset	Displays user preset TGC slides.
10.	Standard Preset	The Standard Preset area provide standard TGC slides.
11.	Exit button	Tap to exit TGC setup page.
12.	Save as button	Select the desired slider position in the “Standard preset” or “User Preset” column, make adjustment of the sliders manually if necessary, and then touch [Save as] to select among Save as User1, Save as User2, and Save as User3.

Bodymark and Comments

For products equipped with the trackpad, set user-defined keys for comments (text, arrow and trace) and bodymark. Press }^| (Body Mark)/<ABC> button or the user-defined keys to enter bodymark/comment status.

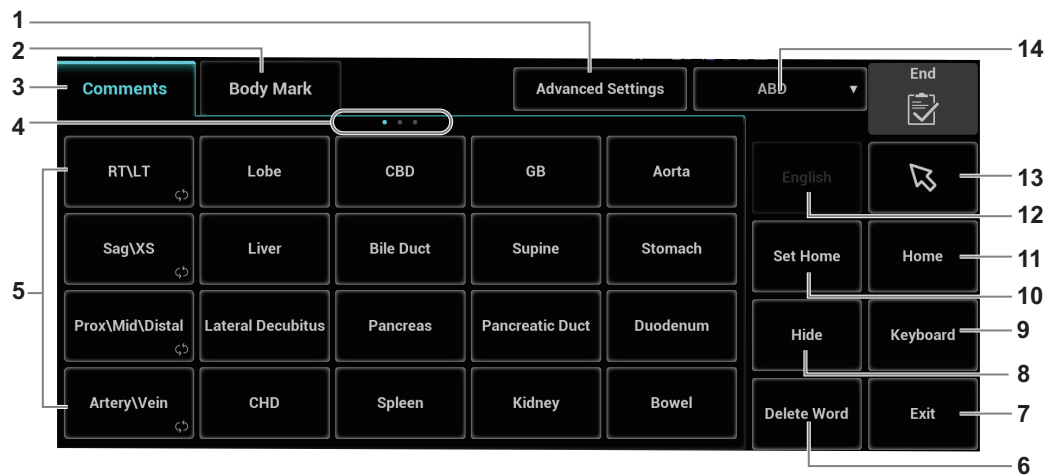

No.	Item	Description
1.	Advanced setting button	Tap to change comment property: <ul style="list-style-type: none"> To change font size, active text color and fix text color. To change arrow size and arrow style.
2.	Bodymark tab	Tap to enter bodymark status.
3.	Comment tab	Tap to enter text/arrow comment status.
4.	Page	If there is more than one page of comment texts for the current exam mode, you can slide to view more.
5.	Comment position button	Tap to directly mark the position. Move the cursor onto the comment item to be modified, and then tap the button to change the already-added comment position.
6.	Delete Word button	Tap to delete the latest comment.
7.	Exit button	Tap to exit the comment status.
8.	Show/Hide button	Tap to display or hide the comments.
9.	Keyboard button	Tap to activate the soft keyboard to type the alphanumeric characters.
10.	Set Home button	Set the start point of the comment cursor.
11.	Home button	Tap to return the cursor to the set home location.
12.	Language button	/
13.	Arrow button	Tap to add an arrow comment to the image.
14.	Library	Tap to pop up and select the library.

Controls on the touch screen

Tap and hold the screen to enter control editing stage.

You can not enter the stage from cine review mode or when there is a dialog box on the screen.

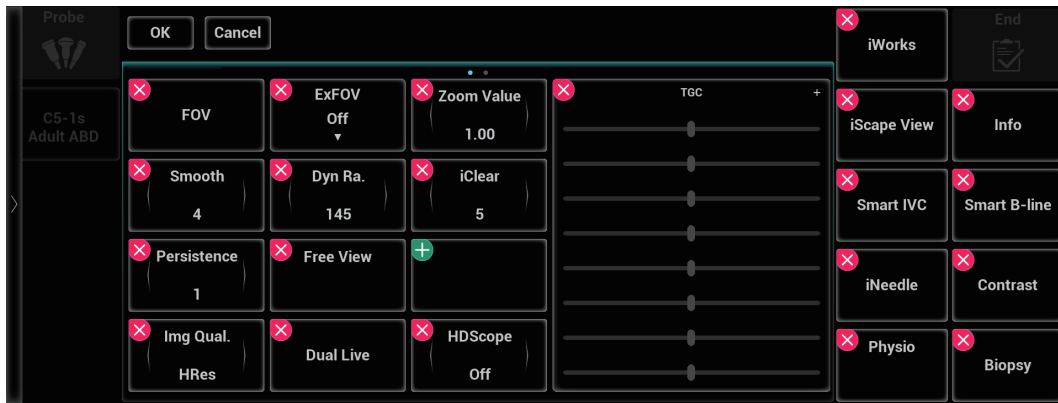

Function	Operations
Adding a control	Tap + to select a button to add and tap [Confirm].
Add a user-defined control	In comment and body mark editing status, tap + and then tap [Custom] to bring out the dialog box for adding user-defined controls. Enter the control name and tap [Confirm].
Delete a control	Tap X of the target control and tap [Confirm] to delete.
Change the control position	Tap and drag the control to the desired position.

2.13.3 Voice Recognition

TIP:

Currently, only wireless microphone devices can be inserted to the system for inputting vocal commands.

Figure 2-8 Voice Control Panel

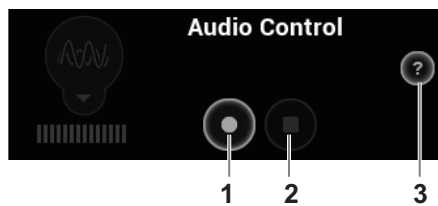





No.	Description
1.	Click to speak to the microphone (the system recognizes the vocal order). The system conducts the operations after recognizing the voice.
2.	Click to stop the voice Recognition.
3.	Click to open the help information.

2.14 Warning Labels

The warning labels are attached to this system in order to call your attention to potential hazards.



The warning labels use the same signal words as those used in the operator's manual. Read operator's manual carefully before using the system.



















The name, pattern and meaning of each warning label are described as follows:













No.	Warning Labels	Meaning
1.		Read this information carefully before using the system.
2.	The following labels are available when the system works with the mobile trolley. 	<ol style="list-style-type: none"> 1. Do not place the system with the mobile trolley on a sloped surface. Otherwise the system may slide, resulting in personal injury or the system malfunction. Two persons are required to move the system over a sloped surface. 2. DO NOT sit on the trolley. 3. When the casters are locked, DO NOT push the trolley.
3.		Non-ionizing radiation
4.		MR Unsafe – the system is not intended to be used within magnetic resonance (MR) environment.

2.15 Symbols



This system uses the symbols listed in the following table. Their meanings are explained as follows:

Symbol	Description
	Type-BF applied part
	Caution!
	Standby

Symbol	Description
	Transducer sockets
	Used for s-video output.
	Network port
	HDMI port
	USB port
	AC (Alternating current)
	Standby indicator
	Harddisk indicator
	Battery indicator
	Unlock position
	Lock position
	Dust-proof mesh
	ECG lead port
	Equipotentiality
	Product serial number
	Manufacture date
	Manufacturer
	Temperature limit
	Humidity limitation

Symbol	Description
	Atmospheric pressure limitation
	Main unit release button on the trolley
	Main unit tray release button on the trolley
 2kg/4.3lbs	Maximum load for small storage bin on the MT3 trolley
 3kg/6.5lbs	Maximum load for big storage bin on the MT3 trolley
10kg/21.9lbs 	Maximum load for main unit tray on the MT3 trolley
 AC 100-240V~ 50/60Hz 240VA	MT3 Trolley AC output
 19V 7.9A	MT3 Trolley DC output
 100-240V~ 50/60Hz 4.4-2.5A	MT3 Trolley input
	Power adapter bracket on the MT3 trolley
 Max load 最大承重 5 kg	Maximum load for the storage bin on the MT2 trolley
19V \equiv 7.9A(Max)	Power consumption
Rx Only	Federal law restricts this device to sale by or on the order of a licensed healthcare practitioner (USA).
ETL CLASSIFIED  Intertek 3179617	CONFORMS TO AAMI STD ES60601-1, IEC STD 60601-2-37, IEC STD 60601-1-6; CERTIFIED TO CSA STD C22.2 NO. 60601-1, 60601-2-37, 60601-1-6

The general meaning assigned to geometric shapes, safety colors and contrast colors for safety signs are as follows:

Geometric shape	Meaning	Safety color	Contrast color	Graphical symbol color
	Prohibition	Red	White	Black
	Mandatory action	Blue	White	White
	Warning	Yellow	Black	Black

3 System Preparation

3.1 Move/Position the System

Read and understand the safety precautions before positioning the system to ensure the safety of both the operator and the devices.

1. Switch off the power, and pull out the power plug.
2. Disconnect all cables from off-board peripheral devices.
3. Place the system in a desired location.

Leave at least 20 cm at the back and both sides of the system.

CAUTION

Maintain a generous, free air flowing space around the back and both sides of the system. Not doing so may result in failure due to the increased rise in the system's operating temperature.

3.2 Connecting the Power Cord

This system can work normally only when it is connected to the external power supply or the battery capacity is sufficient.

3.2.1 Connecting Power

1. Connect the connector of the power adapter to the adapter port in the system.
 2. Use a three-wire cable to connect the adapter with the external power supply.
- If you have any question about the power adapter, please contact your sales representative.

NOTE:

- You must use the specified power adapter.
 - Do not use this power adapter in the conditions other than those specified.
-

3.2.2 Powered by Batteries

When connected to the external power supply, the system is powered by the external power. The lithium ion batteries inside it are in the charging status, the indicator turns off when the capacity is full.

When disconnected from the external power supply, the system is powered by the lithium ion batteries.

WARNING

- The battery is inside the machine. Only Mindray technical professionals or engineers authorized by Mindray following training can perform battery installation and uninstallation.
 - If you need to change the battery or buy a new one, contact your sales representative.
 - The replacement of lithium batteries by inadequately trained personnel could result in a HAZARD (such as excessive temperatures, fire or explosion).
 - The lithium-ion battery has a service life of five years. Replace your battery when it reaches the end of its service life.
-

Battery Performance

Under power off or standby status, charging time of the battery from capacity 0 to 100% takes less than 4 hours.

NOTE:



Power off the system if it will not be used for a long period of time (including storage/transportation condition). Do not leave the system in standby status, otherwise the batteries will be discharged and permanently damaged.

Battery specification

- Voltage: 14.4 V
- Capacity: 6600 mAh (single battery)

Battery Status Indicator

The battery status indicator is located in the bottom-right corner of the screen, indicating the battery capacity.

- : Indicates the battery capacity is nearly empty.
 - : Indicates the battery capacity is full.
-

NOTE:

When the battery power drops to 6%, a window will pop up warning and force the shutdown process. You can exit the shutdown process after connecting the power adapter.

3.3 Power ON/OFF

CAUTION

To ensure safe and effective system operation, you must perform daily maintenance and checks. If the system begins to function improperly, immediately stop scanning. If the system continues to function improperly, fully shut down the system and contact the Mindray Customer Service Department

or a sales representative. If you use the system in a persistent improperly functioning state, you may harm the patient or damage the equipment.

3.3.1 Check before Powering ON

Check before the system is powered on:

- The temperature, relative humidity and atmospheric pressure meet the requirements of the operating conditions, for details see “2.4.2 Environmental Conditions”.
- There is no condensation.
- There is no distortion, damage or dirt on the system and peripheral devices.
If any dirt is found, cleaning shall be performed, see “18 System Maintenance”.
- There are no loose screws on the monitor, control panel or the trolley.
- There is no cable damage (e.g., power cord). Maintain secure connections to the system at all times.
- The probes and probe cables are free from damage or stains.
For details of probe cleaning and disinfection, see “16.1.5 Probes Cleaning and Disinfection/ Sterilization”.
- No miscellaneous odds and ends are attached or affixed to the control panel.
- Ensure that all connections are free from damage and remain clear of foreign object blockages.
There are no obstacles around the system and its air vent.
- Probe cleaning and disinfection.
- The entire scanning environment and field must be clean.
- The locking mechanism of the casters (if there is a trolley) works normally.

3.3.2 Power the System ON

Press the power button to power the system on.

If access control has been set by the system administrator, you can access data in the system only after logging onto the system. For details, see “4.1.10 Access Control”.

You must log in again after system restart or dormancy.

To login onto the system

Perform the following procedure:

1. Select the login type (Local or LDAP), and user name in the drop-down list.
2. Enter the password and click [Login].

When the user has logged onto the system,  is visible in the bottom-right corner of the screen.

To change users

Perform the following procedure:

1. To log out the current user and change to another user, click  in the bottom-right corner of the screen to bring up the following dialog box

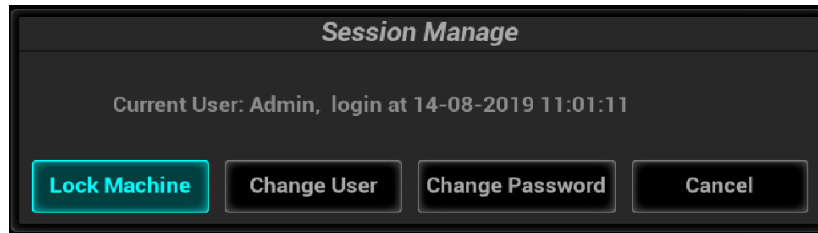

2. Click [Change User] to bring up the Login dialog box.
3. Select the login type, and user name in the drop-down list.
4. Enter the password and click [Login].

To modify password

General operators and administrators can modify the password.

Perform the following procedure:

1. Click  in the bottom-right corner to bring up the Session Manage dialog box where you can see the current user's information.
2. If you want to modify the current password, click [Change Password] to bring up the Change Password dialog box.
3. Enter both the previous and new passwords, and confirm the new password in the dialog box.
4. Click [OK] to exit.

To lock the system

Perform the following procedure:

1. Click the  in the bottom-right corner of the screen to bring up the dialog box.
2. Select [Lock Machine] and the system is locked.

You must log on before using the system.

3.3.3 Check the system after it is powered on

Check after the system is powered on:

- There are no unusual sounds or smells indicating possible overheating.
- There are no persistently displayed system error messages.
- There is no evident excessive noise, or discontinuous, absent or black items in the B mode image.
- Check whether there is abnormal heat on the surface of the probe during an ultrasound procedure. If you use a probe which is giving off excessive heat, it may burn the patient.
- The control panel keys and knobs are fully functional.
- The date and time are displayed correctly.

WARNING

- If you use a probe giving off excessive heat, it may burn the patient.
 - If you find anything not functioning properly, this may indicate that the system is defective. In this case, shut down the system immediately and contact Mindray Customer Service Department or sales representative.
-

NOTE:

When you start the system or switch between transducers, you will hear clicking sounds – this is expected behavior.

3.3.4 Power the System Off

You must follow the correct procedures to power the system off. Also, after you upgrade the software or when the system is down, you need to power off and restart it.

If you will not use the system for a long period of time, you shall:

- Disconnect the power adapter.
- Disconnect the mains power.
- Turn off powers of all peripherals connected to the system.

To power the system off

Perform the following procedure:

1. Press the power button to see the option:
 - Shutdown: to power the system off normally.
 - Standby: to enter standby status.
 - Cancel: to cancel the operation.
 2. Select [Shutdown] to power the system off.
-

NOTE:

- Press and hold the power button for a long time and the system will power off without displaying the “Shutdown Confirm” screen. However, shutting down the system this way may destroy the data.
 - DO NOT rush direct shutdown of the system. It may damage the data.
 - After the system is upgraded, use [Shutdown] to power the system off to make the upgraded data effective.
-

3.3.5 Standby

NOTE:

- Power off the system if you will not use the system for a long period of time (including storage/ transportation condition), and you should not allow the system in standby status, otherwise the batteries will be out of power and permanently damaged.
 - If the system will not be used for a long period of time, you should disconnect the power adapter, disconnect the mains power, and turn off the power to all peripherals connected to the system.
-

To enter standby

- Fully fold the LCD display and wait for 30 seconds, then the system enters the standby status.
- Set the time for screen saver and standby, see “4.1.2 General”. If the system is not carrying out an operation, the screensaver appears after the screensaver delay period. If there is still no operation, the system enters standby after the standby delay period.
- Press the power button and select “Standby”.

To exit standby

- Unfold the LCD display.
- Press the power button.

3.4 Monitor Brightness/Contrast Adjustment

Monitoring the brightness and contrast adjustment is one of the most important factors for proper image qualities. If set incorrectly, the gain, TGC, dynamic range or even acoustic output have to be changed more often than necessary to compensate.

For details about adjustment, see “4.1.2 General”.

NOTE:

On the monitor, the brightness adjustment comes before contrast. After readjusting the monitor’s contrast and brightness, adjust all preset and peripheral settings.

3.5 Connecting/Disconnecting a Probe

CAUTION

- Press <Freeze> to freeze an image or turn off the power of the system before connecting/disconnecting the probe. Otherwise, system or probe failure may occur.
 - When connecting or disconnecting a probe, place it in the proper position to prevent the probe from falling off or becoming damaged.
 - Only use probes provided by Mindray. Aftermarket probes may result in damage or cause a fire.
-

3.5.1 Connecting a Probe

WARNING

The probes, cables and connectors should be in proper operating order and free from surface defects, cracks and peeling. Otherwise, this may lead to electrical shock.

NOTE:

Before inserting the connector into the probe port, inspect the connector pin. If the pin is bent, do not use the probe until it has been inspected/repaired/replaced.

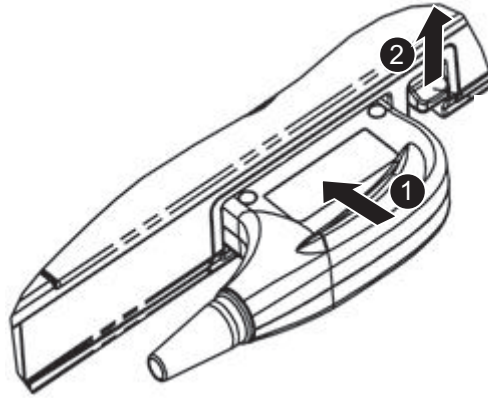

Perform the following procedure:

1. Keep the cable end of the transducer to the front side of the system, insert the connector into the system port, then press in fully.
2. Toggle the locking lever to the lock position.
3. Position the probe properly to avoid it being treaded on or becoming wrapped around other devices. DO NOT allow the probe head to hang free.

3.5.2 Disconnecting a probe

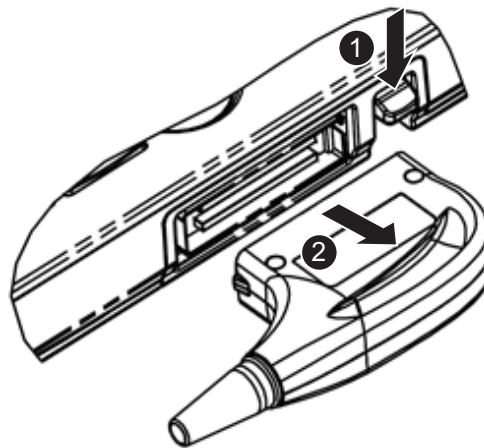



Perform the following procedure:

1. Toggle the locking lever to the unlock position.
2. Pull the transducer connector straight out vertically.

3.6 Connecting USB Devices

⚠ WARNING

DO NOT directly remove a USB memory device, as the USB device and/or the system may become damaged.

- When connecting a USB memory device to the ultrasound system via a USB port, a sound is heard if it is connected successfully and the symbol  appears in the bottom-right corner of the screen.
- To remove the USB device: click  to open the [Remove USB Device] screen. Select the device to be removed and click [OK]. A sound is heard when removing the USB memory device.
- The system supports option of external DVD R/W drive. The DVD R/W drive is connected to the ultrasound system via USB port.

NOTE:

- When connecting an external DVD R/W drive, connect the two cables of the drive to the ultrasound system if the drive provides 2 USB power cables. In this way, the DVD R/W drive can work more normally.
 - If the USB disk cannot be recognized by the system, please try disconnecting and then connecting again several times, or try another USB disk. If the problem still exists, please contact Mindray service engineer.
-

3.7 Connecting the Footswitch

The system supports USB port-type foot switches.

The function of the foot switch can be preset. For details, see “4.1.7 Key Configuration”.

3.8 Installing a Printer

TIP:

- Printers listed in Section 2.6.4 have drivers installed already.
 - If the printer driver is required, please contact Mindray Customer Service Department or sales representative.
 - Please refer to the accompanying manuals of the printers for more details.
-

3.8.1 Connecting a Graph/Text Printer

As shown in the figure below, a graph/text printer has a power cord and data cable. The power cord shall be directly connected to a wall receptacle as required.

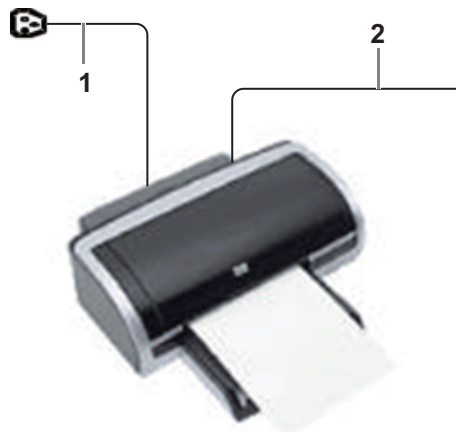

1	Power supply cable	Connect to power supply.
2	Data cable	Connect to the USB port of this system.

Perform the following procedure:

1. Connect the data cable to USB port of the ultrasound device.
2. Power on the system and the printer.
3. Preset the default report printer and its attribute:
 - a. Open [Setup] > [Print] screen.
 - b. Select the “Report Print” column in the Service Type list.
 - c. In the “Property” frame, select printer from the driver list next to “Printer” in the lower screen and set the items.
 - d. Click [Save] after you have finished setting.

3.8.2 Connecting a Video Printer

The digital video printers that system supports consist of the B/W printers and color printers.

Perform the following procedure:

1. Place the printer appropriately.
2. Connect the power cord of the printer to a receptacle. Connect the USB port of the system to the USB port of the printer with USB cable.
3. Load a paper roll and turn on the system and printer.
4. Add a print service:
 - a. Open [Setup] > [Print] screen.
 - b. Click [Add Service] to enter the page.

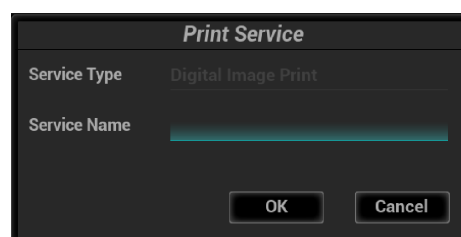

- c. Select the service type and enter the service name manually.
- d. Click [OK] to return to the page.

- e. Select the target printer from the drop-down list in the “Property” box and set other printing properties.
- f. Click [OK] to complete.

3.8.3 Connecting a Wireless Printer

The system supports the wireless graph/text printer for the report print.

Perform the following procedure:

1. Plug the printer power cord to an appropriate outlet.
2. Power on the system and the printer.
3. Make sure the ultrasound machine and the printer are connected to a same LAN, and turned on the W-LAN function of the printer.
4. Select [Setup] > [Print] to choose the report to be printed. Select the printer from the wireless printer list, and set the printer.
5. Click [Save] to exit the preset and make the settings effective.

4 Setup

The Setup function is designed to set the configuration parameters of operating the system and maintaining user workflow setup data. The setup data of the user and system are stored to the hard drive, and should be backed up to CD/DVD or USB memory device.

CAUTION

When the preset data is changed, be sure to save the preset data according to the methods described in this chapter. Mindray is not responsible for the loss of preset data.

- To enter Setup:
Tap [Setup] on the exam main screen of the touch screen.

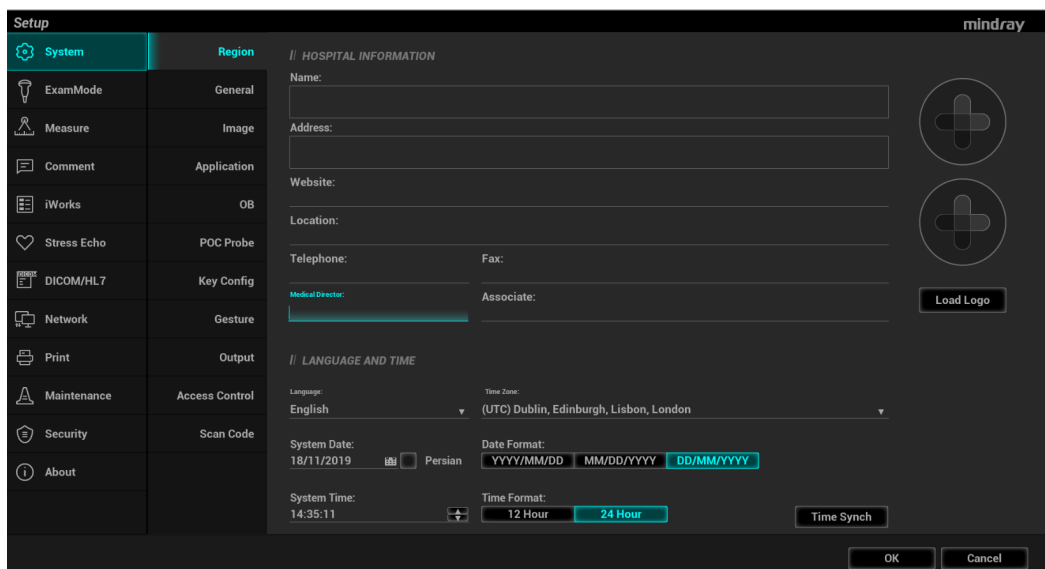

- To exit Setup:
 - Select [OK] in the Setup menu. The parameter settings are saved.
 - Select [Cancel] in the Setup menu to close the Setup menu.When you change the system language and click [OK] in the Setup menu, the system automatically shuts down to make the modification effective.

- Basic operations

The commonly-used setting types are:

- Text box: position the cursor over the corresponding field box. Enter the desired value using the soft keyboard on the soft menu.
- Radio button: click the button to select an item.
- Check box: click the checkbox to select one or more options.
- Drop-down list: click the arrow beside the list to select an item.

4.1 System Preset

4.1.1 Region

Set the hospital name, language, time zone, time format and system date/time.

Item	Description
Hospital Information	To set the hospital-relevant information such as name, address, telephone, and so on.
Language	To select a language (input) for the system.
Load Logo	Import image for logo loading. NOTE: For a better display effect, please try to use an BMP image with 400*400 pixels and 8/24/32 bitdepth.
Time Zone	To select the time zone.
Time Format	To select the time format.
Date Format	To set the date format.
System Date	To set the date for the system.
System Time	Move the cursor over the corresponding field and enter the time manually using the keyboard, or, move the cursor over the time segment and press <Set>, then increase or decrease the required value by clicking the icons on the right side.
Time Synch	To assign a time server and make the time of the ultrasound machine consistent with the server.

4.1.2 General

Set patient information, exam setup, patient management, storage, system dormancy, auxiliary output setting and so on.

Type	Item	Description
PATIENT INFO	Patient Banner Display Content	To select whether to display the available patient information items on the screen.
	H&W Unit	To set the unit for calculating patient height and weight.
	Surface Formula	To set the surface formula.
	Font Size (For Storage)	To set the font size in the Patient Banner Display Content for storage.
	Status after freeze	To set the system state after the image is frozen.
	Storage Beep Volume	Set the key volume for saving single /multi-frame image.

Type	Item	Description
EXAM SETUP	Status after exam ends	To set the system status when an exam ends.
	Touchpad Display after Ending Exams	To set the touchpad display when an exam ends.
	Auto Screenshot of Report Page by Page	After selected, perform measure application and save single frame image, then end the patient exam, the system will save the report image in iStation.
	Sending/printing after Ending Exams	Select whether to automatically archive the exam data to the DICOM server for storage/print.
	Send SR after Ending Exams	Select whether to automatically send structure report to the DICOM server.
	Speed up the export of exams	Select whether to speed up the export of exams after prospective saving the cine.
	Maximum number of exams to be kept	<p>To set the maximum number of exams to be kept. If the actual number is larger than the preset number, the latest exam will replace the earliest exam.</p> <p>NOTE:</p> <p>The patient exams which exceed the preset maximum will be deleted and unrecoverable, it is recommended to perform patient data backup before enabling this function to avoid data loss.</p>
	Exam cannot be activated after	<p>To set the time when the exam can be activated after the end of the exam.</p> <p>NOTE:</p> <ul style="list-style-type: none"> • The default value is 1 day. Only exams within 24 hours can be activated by default. • If not set, all the ended exams can be activated. • The patient information can be added or modified after activating the exam. • The exam image can be added after activating the exam, without affecting the previously saved exam image.

Type	Item	Description
SCREEN SAVER	ScreenSaver	Select the different saver methods to the system. After enabling the screen saver, check “Select Picture-Mindray” to select the image from the system. Or click [Review] to select the image on your own; you can set the interval time for the screen saver slideshow in the drop-down list beside “Interval”. To set the waiting time before the system enters dormancy status in the drop-down list beside “Wait”. The system enters screen saver automatically if the system waiting time exceeds the screen saver already set.
	Standby	The system enters screen saver automatically if the system waiting time exceeds the screen saver already set and standby time.
	CoverOff-Standby	After folding down the monitor, the system enters standby mode automatically if the waiting time exceeds the CoverOff-Standby time.
DISPLAY	Brightness auto adjustment	To set the brightness/contrast of the main screen and the touch screen according to the conditions.
	LCD	To set the brightness and the contrast of the main screen, or restore to the default.
	TouchPanel	After selection, the system restores the touch screen settings back to factory.
IVOCAL	Automatically shut down waiting time.	To set the delay before voice recording stops automatically.
	Enable Voice Response	After it is ticked, the system will repeat recorded voice commands automatically.

4.1.3 Image Preset

Controls are as follows:

Type	Item	Description
RESET CONFIG	Probe	To set the default probe model for the system from the drop-down list. The default parameters are applied to the new probe if checking “Use the default setting when start a new exam.”
	Image size	Set the standard for saving the image or using the digital/graph printer.

Type	Item	Description
PARAMETER	Steer	To set the steer mode in B + Color + PW/CW imaging mode. <ul style="list-style-type: none"> • C&(PW/CW): select to adjust the sample volume in color mode and sample line in PW or CW mode together. • C/(PW/CW): select to adjust the sample volume in color mode and sample line in PW or CW mode separately.
	Auto Invert	The spectrum can automatically invert when the color flow is steered to a certain angle, thus accommodating the operator's wish to distinguish the flow direction.
	iScape Ruler Display	To set whether to display the iScape ruler in iScape imaging mode.
	B+Color Refresh with PW/CW Sampling Line Movement	To set whether to turn on the function that when moving PW/CW sampling line, B+Color image is activated under B+Color+PW/CW mode.
	Uninterruptible image saving when reprocessing parameters are changed	Adjusting reprocessing parameters will not interrupt image/cine saving.
	Color And PW/CW Synchronize Invert	Adjust preprocessing parameter, refresh 2D/M/Doppler cine.
	Color And PW/CW Synchronize Invert	To set whether to invert Color Map and PW/CW spectrum synchronously
	Display Transducer SN	To set whether to display the transducer SN.
	B+Color+PW UnFreeze keeping PW	To set whether to retain PW images when unfrozen under B+Color+PW mode.
TOUCH SCREEN	Touchpad Layout Design	To set the layout style of the touch screen.
TISSURE TRACKING QA	Segment Model	To set the cardiac segment model: 16 or 17.

4.1.4 Application

Set the measurement ruler, measurement setting, follicle method, left ventricular setting, comment setting and so on.

Measure Ruler

Controls are as follows:

Item	Description
Cursor Type	Type of cursor displayed on the measurement caliper and results window. Value options: <ul style="list-style-type: none"> • Number: the cursor always displays as “+” while different measurements are marked with numbers. • Symbol: the cursor displays sequentially in 8 symbols to identify different measurements.
Cursor Size	The size of the cursor.
Heart Beat	The number of cardiac cycles in the heart rate calculation. (In heart rate measurement, the number of cardiac cycles should match the preset number.)
Cursor Line Display	If unselected, the connecting line between the measuring ends will be hidden after measurement.
Ellipse Cross Line Display	If unselected, the measuring axis within the ellipse area will be hidden after measurement.
Clear results while deleting caliper	Uncheck. The image is unfrozen or the image mode is changed after the measurement is completed. The measurement results are saved if the caliper is cleared.
Unit Setting	To set the measurement unit.

LV Cube/Teichholz/Gibsom

Set the tools used in the Cube/Teichholz/Gibson study.

Follicle

Set the method for calculating the follicle.

PW Measure

PW measure velocity displays absolute value.

All measurement results in PW mode are absolute values based on the unit of velocity after checking this item.

Comment

Set whether to clear comments and bodymark:

Item	Description
Clear comments while unfreezing image or changing probe/exam	To set whether to clear comments while unfreezing image or changing probe/exam.
Clear Bodymark upon unfreeze	To set whether to clear bodymark whiling unfreezing image.
Press comment/bodymark key enter comment mode	To set enter comment mode after pressing comment/bodymark key.

Intelligent Input

Set to enable the Input Method Association.

ICA/CCA & RAR

Set the measurement properties of ICA, CCA, Renal A and Aorta.

CARDIAC VALUE RANGE DISPLAY

Set whether to display the EMINCA study.

Item	Description
The number of decimal places of measurement data in SR report is consistent with those displayed in the system.	It is selected by default. When it is not selected, the measurement data in the SR report uses the same number of decimal places as the original measurement data.
The number of decimal places of measurement result that is displayed in millimeters	Sets the number of decimal places of measurement result that is displayed in millimeters. One decimal place is set by default.

4.1.5 OB

Set the relevant information regarding the fetal gestational age, fetal growth formula and fetal weight.

To set the default formula

Perform the following procedure:

1. On the [Fetal Gestational Age], [Fetal Growth] or [Fetal Weight] page, select an OB Item in the left column.
2. Select a formula in the right column.
3. Click [Default].

The default formula is marked with a ✓.

To set the fetal weight display

Perform the following procedure:

1. Enter the [Fetal Calc] page.
2. Select the [Fetal Weight Unit].
Select Metric, English or English & Metric from the drop-down list.
3. Select the formula for calculating the weight percentile.
Select the formula from the drop-down list of [EFW-GP].

To import/export an OB Table or Formula

TIP:

Only imported user-defined tables can be exported.

Perform the following procedure:

1. Select [Import] or [Export] on the Fetal Gestational Age or Fetal Growth page.
2. Select the drive and file path where the data is located.
3. Select the data file to load or export, click [OK] to confirm.

The imported user-defined table for FG and GA must be a *.csv file. The format of the *.csv file is described as follows:

- FG table

Table Type	Author Name	SD Type	Meas Value Unit	SD Unit
FG	The author name	Value of standard deviation	Unit of the measurement value	Unit of the standard deviation
Row Num	Row number (N) of the table			
No.	GA	Min	Meas Value	Max
1	GA value	Minimum value	Measurement value	Maximum value
2
...
N

NOTE:

- Fill in the table according to the actual clinical values, except for those cells with bold text.
- Value of standard deviation. Select from one of the following: None, $\pm 1SD$, $\pm 2SD$, 3%~97%, 5%~95%, 10%~90%.
- Unit of the measurement value: according to the table to import, select from mm, cm, g, kg, cm^2 or mm^2 .
- Row number (N) of the table: the maximum row number N in the column “No.”
- The third row is empty.
- GA value, Minimum value, Measurement value, Maximum value: enter the number of days without the unit.

- GA table

Table Type	Author Name	SD Type	Meas Value Unit	
GA	The author name	Value of standard deviation	Unit of the standard deviation	
Row Num	Row number (N) of the table			
No.	Meas Value	SD(-)	GA	SD(+)
1	Measurement value	Standard deviation (-)	GA value	Standard deviation (+)
2
...

N
---	-----	-----	-----	-----

NOTE:

- Fill in the table according to the actual clinical values, except for those cells with bold text.
- Value of standard deviation. Select from one of the following: None, $\pm 1SD$, $\pm 2SD$, 3%~97%, 5%~95%, 10%~90%.
- Unit of the measurement value: according to the table to import, select from mm, cm, g, kg, cm^2 or mm^2 .
- Row number (N) of the table: the maximum row number N in the column “No.”
- The third row is empty.
- Measurement value, Standard deviation (-), GA value, Standard deviation (+): enter the number of days without the unit.

User-defined OB Items**NOTE:**

The calculation results of the user-defined OB formulae are used for reference rather than clinical diagnosis.

You can add user-defined formulae for items (obstetric tools) that are not included in the GA and FG table.

1. Select [More OB Items] on the Fetal Gestational Age or Fetal Growth page.
2. Select an item and click [OK].
3. The new item appears in the left column and the system asks if to add a formula.
4. Click [OK] to select the *.csv file (formula file) for the item. Or add a formula for the new item by clicking [Import].

Measure Result

EDD display: the EDD is displayed in the result window after checking.

GA Cycle For EDD

- Normal Cycle: GA is calculated according to 40 weeks after checking ($EDD=LMP+287(40\text{ weeks})$).
- French Cycle: GA is calculated according to 41 weeks after checking ($EDD=LMP+287(41\text{ weeks})$).

Display EFW GA in report

Estimate GA according to EFW data after checking.

4.1.6 Key Probe

Assign functions to the key probe buttons.

Item	Description
K1	To set the function of K1 button.
K2	To set the function of K2 button.
K3	To set the function of K3 button.

Item	Description
Enable Key Probe Key Function	After it is ticked, the key function of Key probe is enabled.

4.1.7 Key Configuration

Assign functions to the foot switch and user-defined keys.

Key function setting

You can set the functions for <Save> and user-defined keys.

To assign a function to a key:

1. Click to select the desired key in the Key Function column on the left side of the page.
2. Click to select a function in the Function area. You can see the available functions selected on the right side.
3. Click [OK] to complete the function setting.

Footswitch Function Setting

You can assign a function to the left/middle/right key of the foot switch. The method is similar to setting key functions. See the steps above.

Trackball Speed

Set the speed of the trackball when using the trackball.

Key Volume

Set the key volume level.

Key Brightness

Set the brightness for the keys.

Trackball Light

Set the light color for the trackball.

Touchscreen Volume

Set button volume level on the touch screen.

Auxiliary Output Function

For the following three functions, the system provides auxiliary output function setting: “Save Image”, “Save Cine (Retrospective)” and “Save Cine (Prospective)”. When the corresponding user-defined key is pressed, the system can perform multiple operations one by one as per the preset.

- Save the single-frame image:
 - Send image to DICOM storage
 - Send image to DICOM print
 - Send image to USB disk
 - Send image to iStorage
 - Send image to local printer
- Retrospective/prospective saving cine:
 - Send cine to DICOM storage
 - Send cine to USB disk

- Send cine to iStorage

Setting method (taking “Save Image” as an example, add the auxiliary functions “Send Image to DICOM Storage” and “Send Image to USB disk”):

1. Select a key in the Key Function field on the left side and select “Save Image” in the Output page of Function field on the right side.
2. Click [Add] in the middle part of the screen, then there will be “Function 2: NULL” under the key function in the Key Function Field on the left side, and at the same time, “Output” column on the right side will show the available auxiliary functions for current key. Select “Send Image to DICOM Storage” in the “Output” column on the right side. Then the Function 2 on the left side turns into “Send Image to DICOM Storage”.
3. Click [Add] again, then there will be “Function 3: NULL” under the key function in the Key Function Field on the left side. Select “Send Image to USB disk” in the “Output” column on the right side. Then the Function 3 on the left side turns into “Send Image to USB disk”.
4. Click [OK] to confirm.
5. Scan and freeze the image
6. Press the user-defined key, then the system will perform three steps:
 - a. Save the image to the local hard disk.
 - b. Send image to DICOM Storage server.
 - c. Send the image to USB disk.

TIP:

Repeat step 3 will continue adding auxiliary functions; you can add 6 functions at most.

4.1.8 Gesture

The gesture setting is the same with the settings of other keys, see “4.1.7 Key Configuration”.

4.1.9 Output

Set the output format, the range and the resolution for the image.

Type	Item	Description
AVI ENCODE	Encode Quality	To set the image quality of unloaded AVI. The system unloads according to the settings. The higher the image quality is, the clearer the unloaded image is. The unloading speed become slower with the larger space.
	Operating System Compatibility	To set the unloading format of the AVI. The system unloads according to the settings. If checking “Mac OS”, saving CIN files to USB flash drive as “MP4 Video”.
	Send To Frame Rate	To set whether to enable/disable compression of images.
	Analog Output Mode	To set the format to output/separate the video format: NTSC or PAL.
	COLTEMP	To set screen color temperature: Warm or Cold.

Type	Item	Description
DIGITAL OUTPUT	Output Size	Select VGA, HDMI output image range.
	Resolution	Select VGA, HDMI output image resolution.
DVR OUTPUT	Output Size	Select DVR recording area.
DIALOG STORAGE	White background for dialog storage	To set the white background for dialog storage.

4.1.10 Access Control

The system supports two types of users: administrator and operator.

- Administrator
The system administrator can access all function modules, and view all patient data, such as patient information, images and reports, etc. Only one administrator is configured by default. The administrator can add or delete operators.
- Operator
The operator can only access the function modules with assigned privileges. The operator can only view exam information saved in the system and operated by him or herself, such as patient information, images and reports, etc.

Enabling Access Control

The system administrator can preset the access controls, that is, whether an operator has the right to access data in the system.

Access control only can be set by the system administrator.

Open the “Access Control” page:

- If “Enable User Account Control” is selected, you must be authorized before accessing the data, and you can configure password policy and LDAP, and change password. If unselected, you can access all the data without authorization, and you cannot configure password policy and LDAP, and change password.
- If “Enable Emergency User” is selected, the administrator can edit privileges for emergency users. If unselected, the administrator cannot edit privileges for emergency users.

Adding a User/Assigning privilege

Turn on the access control function and log in to the system as Administrator before you add the user.

1. Click [Add] to bring up the dialog box.
2. Enter the user name and password, confirm password.
3. Select or deselect the check box from the privilege list.

Users can only access the function module with assigned privilege.

4. Click [OK] to confirm the setting and exit the dialog box.

The new user and the privilege will appear in the User List.

Deleting a User

Turn on the access control function and log in to the system as Administrator before you delete the user.

Select the user to be deleted in the User List. Click [Delete] to delete the selected user.

Editing Privilege

Turn on the access control function and log in to the system as Administrator before you edit privileges.

1. Select a user, click [Edit Privilege] to enter the “Edit user privilege” dialog box.
2. Select or deselect the check box from the privilege list.
3. Click [OK] to confirm the editing and exit the dialog box.

The edited privileges will appear in the User List.

Modify Passwords

The system administrator can modify all user passwords. The administrator password is empty by factory default. You can set this password.

An operator can only modify his/her own password.

1. Select the user name to be modified in User List.
2. Click [Change Password] to open the dialog box.
3. Enter current password, new password and confirm new password, then click [OK].

Configure Password Policy

Turn on the access control function and log in to the system as Administrator before you configure the password policy.

Click [Password Policy Config]:

Item	Description	Remark
Lockout Threshold	Set the maximum time that a user can input the wrong password. If you exceed the maximum times, your account will be locked.	For example, assume that the “Lockout Threshold” is set to 5, the “Reset Account Lockout Threshold after” is set to 60, and the “Lockout Duration” is set to 60. That is, a user inputs the wrong password for 5 times within 60 minutes, the account is locked, and the user can log in to the system only after 60 minutes. Other users with unlocked accounts can still log in to the system normally.
Reset Account Lockout Threshold after	Set the duration allowed for a user to continuously input the wrong password.	
Lockout Duration	Set the duration after an account is locked.	
Reset all lockout	Reset all locked accounts.	/

Item	Description	Remark
Enable strong password	<p>Enable strong password to improve security.</p> <ul style="list-style-type: none"> If the strong password is enabled and you log in to the system with the account that is added before the strong password is enabled, the system prompts a warning message to inform you whether your password conforms to the password policy. The administrator can change password for administrator or operator. If the strong password is enabled and you add a new user account, the system prompt an error message to inform you that the password is too weak, please modify the password according to the error message. 	/

LDAP Privilege Management

Turn on the access control function and log in to the system as Administrator before you edit privileges for the LDAP (Lightweight Directory Access Protocol) users.

Click [LDAP Config]:

Item	Description
LDAP Type	To set the type of LDAP.
Service Address	Enter the server address in the field box after accessing the network
Test LDAP Server	To test whether the LDAP server is accessible. If the LDAP is accessible, the system prompts the following message "Server test succeeded."
Root DN	It is automatically displayed after the server is successfully tested.
Default Domain	The default domain is the DC name in the Root DN. For example, if DC=security1, then input "security1" in the field box of the "Default Domain"
Days to keep cached password	<p>Set days to keep the cached passwords in the local system. Users can log in to the server even without accessing the network within the setting days.</p> <ul style="list-style-type: none"> Empty: the passwords are kept in the local system permanently. 0: no passwords are kept in the local system. ≥1: for example, if it is set to 5, the passwords are kept in the local system for 5 days.
Member of filter/Privilege	<ul style="list-style-type: none"> Enter the member name, and select or deselect privileges from the drop-down list of "Privilege". Click [Add], and the new members and privileges will appear in the Member of filter list. Select a member to be deleted, and click [Delete]. Select a member to be modified, modify the member name, and select or deselect privileges from the drop-down list of "Privilege". Click [Modify], and the modified member name and privileges will appear in the Member of filter list.

Item	Description
Logon Test	<ol style="list-style-type: none"> 1. Enter the User name and password in the field boxes of the Authentication test area. 2. Click [Logon Test] to test whether the user is authenticated.
User field name	<p>Select [Use user field name] to customize the user field name. After that, the members and privileges cannot be edited.</p> <p>Enter the user field name in the field box of the “User field name” (the user field names are configured in the LDAP server. For details, please refer to the LDAP server manual).</p> <p>The user field name corresponding to privileges are as follows:</p> <ul style="list-style-type: none"> • iStation Access: 1 • Save Exam: 2 • Export Exam: 4 • Network Settings: 8 • Maintenance Menus: 16 • System Settings: 32 • Workflow Settings: 64 • Worklist Access: 128 <p>NOTE:</p> <p>The privilege items can be combined randomly. For example, if user A is assigned with all the above 8 privileges, the user field name for user A is $1+2+4+8+16+32+64+128=255$.</p>

Auto Lock Machine

To set the waiting time before the system enters locked status in the drop-down list beside “Wait”. The system will be locked automatically if the system waiting time exceeds the duration already set.

Scene Preset Management

The system can manage preset data under different scene applications. When the feature is turned on, you can use different preset data for print, DICOM, iStorage and eGateway services.

To enable the function:

1. Check the checkbox next to “Enable Preset Scene Mangement”.
2. Click [OK] to confirm.
3. Switch different scenarios:
 - a. In non-preset screen, press <Cursor> to show the cursor and move the cursor to the bottom-right corner of the screen. Click  icon to see the scene management list.

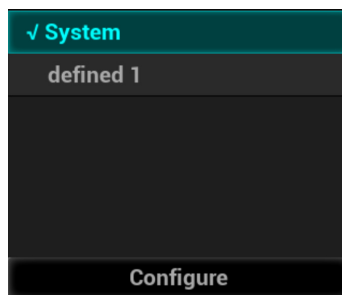

- b. Position the cursor on the target scene and press <Set> to switch.

4. Configure scenes:
 - a. In non-preset screen, press <Cursor> to show the cursor and move the cursor to the bottom-right corner of the screen. Click  icon to see the scene management list.
 - b. Click [Configure] to see the following dialog box.



- c. Add scenes: click [Add] and enter the scene name in the Add Scene dialog box and then click [OK].
- d. Click to select the target scene name in the Scene Name list on the left side.
- e. Click to select a desired preset service on the right to open the screen.
- f. Set necessary parameters and click [Save] to exit.
- g. Click [Exit] to exit configuration.

4.1.11 Scan Code Preset

Set the code parameters for barcode reader.

1-dimension barcode reader (1D)

Item	Description
Scan Item	<p>After scanning 1D bar code, the regular expression is matched in the priority order: “Patient ID > Other ID > First name > Last name > Middle name > Accession# > Operator > Diagnostician”. If the regular expression is matched successfully, the data of 1D bar code will be displayed in this item in Patient page automatically.</p> <p>Example: The data of the bar code is 123 after scanning 1D bar code. The regular expression is matched in the priority order: “Patient ID > Other ID > First name > Last name > Middle name > Accession# > Operator > Diagnostician”. If the regular expression of “Other ID” is matched successfully, “123” will be displayed in “Other ID” item in Patient page automatically.</p>
Regular Expression	Set the regular expression according to the bar code format.

Item	Description
Append Options	<p>The information of operator or diagnostician can be appended after selecting the check box.</p> <p>For example, after scanning a 1D barcode of an operator or diagnostician, the obtained data is A, and A will be displayed in “Operator” or “Diagnostician” item in Patient page automatically.</p> <p>After scanning a 1D barcode of an operator or diagnostician for a second time, the obtained data is B, and A will be appended by B in “Operator” or “Diagnostician” item in Patient page automatically.</p>
Default Item	<p>If the default item is set to “No”, and both the 2D and 1D barcodes fail to be matched, the obtained data of the barcode is input as a string of characters. After selecting a default item from the drop down list of “Default Item”, the obtained data of the scanned barcode will be displayed in the corresponding selected default item.</p> <p>For example, if the default item is set to “Patient ID”, and both the 2D and 1D barcodes fail to be matched, the obtained data is displayed in the “Patient ID” item in Patient page automatically.</p>
Move Up/Down	Move up or Move down a selected item.
Add/Delete	Add or delete a selected item. (Only the default item can be added or deleted.)
Load default	Restore the parameter value to the default value.
Worklist Options	<ul style="list-style-type: none"> • Select “Worklist server” from the drop-down list, and the system searches the Worklist server according to the scanned data. • Select “No” from the drop-down list, and the system creates a new exam in the Patient page according to the scanned data.
Worklist Default	<ul style="list-style-type: none"> • Select a default item for searching the Worklist server. For example, users select “Patient ID” from the drop down list of “Worklist Default”, and the system searches Patient ID in the Worklist server. • Select “No”, and the system searches the Worklist server in the priority order: “Patient ID” > “Last name” > “Accession #”. <p>NOTE:</p> <p>The matching priority order is 2D item, 1D item, and Default Item, after the 1D/2D and default items are configured.</p>
Import/Export	Import and export configuration files to preset the barcode. For details, please contact the Mindray service engineer.

2-dimension barcode reader (2D)

- General Analysis Mode
Select “General” from “Analysis Mode” drop-down list: The scan codes consist of Patient ID, Other ID, Patient Name, Birth, etc.

Item	Description
Scan Barcode Example	Input a barcode example, barcode example is separated by separators (the separator is used to set the start and end position of each item), and the barcode data is displayed in the following items in turn.

Item	Description
Parameters	<ul style="list-style-type: none"> Input a barcode example, and you can change the information of Patient ID, Other ID, First Name, Last Name, Middle Name, Birth (Day), Birth (Month), Birth (Year), Age, Gender and etc. in the “Content” list. Note: Ignore item is used to add one line below the selected item to hide unimportant patient information. Set the start and end position of each item via separators. After inputting a barcode example, you can select item separators from the drop-down list of the Separator. (Only separators that are input in the field box of the Scan Barcode Example can be displayed in the drop-down list of the Separator.) Note: You can customize the age unit of Birth (Day), Birth (Month), Birth (Year) in the Content column. If the DOB provided by the patient contains only digit, the system displayed an auto-generated age.
Age Unit	Select an age unit from the drop-down list of the “Age Unit”: Year, Month, or Day.
Male/Female	Input the customized gender symbol besides the Male and Female field box, such as Male (M) or Female (F).

- Advanced Analysis Mode
Select “Advanced” from “Analysis Mode” drop-down list: user enters scan barcode example and regular expression and click [Match], the system will match scan barcode example with regular expression automatically, and if which is matched successfully, the scan item will display the barcode by separators.

4.2 Exam Mode Preset

You can assign available exam modes for probes.

Perform the following procedure:

- To select a probe, move the cursor over the Probe column and select the probe model using the drop-down list.
- Select/delete exam modes:

On the left side, you can view all the available exam modes in the exam library for the probe.

On the right side of the screen, you can view the current exam modes assigned to the probe.

- Click [>]: add a selected exam mode in the [Exam mode Library] to the [Probe and Exam mode] list.
- Click [<]: add a selected exam mode in the [Probe and Exam Mode] to the [Exam Mode Library] list.
- Click [>>]: add all exam modes in the library to the [Probe and Exam Mode] list.
- Click [<<]: add all probe and exam modes in the library to the [Exam Mode Library] list.
- Click [Delete] to delete a user-defined exam in the Exam Mode Library area.
- Click [Default] to set a selected exam mode as the default exam mode. The default exam mode is marked by a “√”.

4.3 Measurement Preset

“Exam Mode XX” on the upper left side refers to the currently configured exam mode. The configured general/application menus are only related to the current exam mode.

There are three kinds of measurement items.

Measurement

Results of measurements are directly obtained via the measurement tools, which are indicated by “” in the preset screen.

For example, “Distance” in the 2D general measurement or “HC” in the OB measurement.

On the touch screen, measurement tools are displayed using square button.

Calculation

Results of calculations are automatically derived by the system using other measured or calculated values as parameters, they are indicated by “” in the preset screen.

For example, EFW (Estimated Fetal Weight) in the OB measurement.

If all measurements related to a calculation tool are completed, the system will automatically calculate the result. If some measurement tools are performed again, the system will automatically update the calculation result using the latest measurement results.

On the touch screen, calculation tools are displayed using square button.

Study

A group of measurements and/or calculations for a specific clinical application, which are indicated by “” in the preset screen.

For example, AFI in the OB measurement.

Fold/unfold the study to hide/show the measurement or calculation items included.

On the touch screen, study items are displayed with an arrow indicating the tools to be selected.

4.3.1 General Measurement Preset

You can preset the General Measurement packages for 2D (B/Color/Power Mode), M Mode, or Doppler (PW/CW) Mode respectively.

Perform the following procedure:

1. Select the [Caliper] on the [Measure] page.
2. Select the [2D], [M] or [Doppler] tab to go to the corresponding preset menu.
 - [Available Items]: general measurement tools configured by the system in the current scanning mode which are available but not assigned yet.
 - [Selected Items]: displays the tools to be added to the menu.
3. Add/Remove the general measurement item using the following buttons:
 - [>]: To add the selected tool from the [Available Items] to the [Selected Items].
 - [>>]: To add all tools in the [Available Items] to the [Selected Items].
 - [<]: To remove the selected tool from the [Selected Items] to the [Available Items].
 - [<<]: To remove all tools from the [Selected Items] to the [Available Items]. You do not need to select any items before removing.
4. Set the default item.

Select an item from the [Selected Items], then click [Default]. The item is marked with a ✓.

The default item is activated automatically when entering this general measurement menu.

5. Adjust the item position.

Select an item from the right column and click [Up]/[Down] to adjust the sequence in which the items are arranged in the corresponding general measurement menu (touch screen display).

6. Modify the properties of a measurement item.

The following takes D trace as an example to show how to set the properties of a measurement tool.

- a. Select the [Doppler] tab to go to the corresponding preset menu.
- b. Select [D Trace] from the [Selected Items] and click [Property] to bring up the following dialog box.

Item Name	Result	Unit	CalcMethod
PS	<input checked="" type="checkbox"/>	cm/s	Last
ED	<input checked="" type="checkbox"/>	cm/s	
TAMAX	<input checked="" type="checkbox"/>	cm/s	
TAMEAN	<input checked="" type="checkbox"/>	cm/s	
PI	<input checked="" type="checkbox"/>		Mean after Calc
RI	<input checked="" type="checkbox"/>		Mean after Calc
S/D	<input checked="" type="checkbox"/>		Mean after Calc
HR	<input checked="" type="checkbox"/>	Bpm	
PV	<input type="checkbox"/>	cm/s	
MD	<input type="checkbox"/>	cm/s	
PPG	<input type="checkbox"/>	mmHg	Mean after Calc

Descriptions of the attributes are shown in the following table:

Item	Description
Item Name & Result	<p>Results obtained from D trace are listed. The selected items will be displayed in the results window after measurement.</p> <ul style="list-style-type: none"> • If PV is selected, other results become deselected (except the temporary result “velocity”). • Some results, such as PS and ED, can be derived via a simple method (e.g., Velocity), but others, such as TAMAX, can only be derived via complicated methods such as Manual, Spline, Auto, etc. • Only Vel. is available in [Method] if only PS or ED is selected. • Methods for obtaining PS and TAMAX simultaneously (trace, spline and auto) should be chosen if both PS and TAMAX are selected (TAMEAN should use auto method).
Unit	<p>Select the measurement unit.</p> <p>Click “Unit” column of each item to select.</p>
CalcMethod	<p>Select the measurement method for the tool.</p> <p>Click “CalcMethod” column of each item to select.</p>

- c. Click [OK] to confirm the setting.

7. Select the measurement sequence.

- [Repeat]: after the current measurement is completed, the system automatically activates the current tool again.

- [Next]: after the current measurement is completed, the system automatically activates the next tool in the menu.
 - [None]: after the current measurement is completed, the cursor can be moved over the whole screen. And the cursor will automatically return to the menu of the corresponding measurement.
8. Click [OK] to confirm.

4.3.2 Application Measurement Preset

Measurement Package Preset

During measurement, the preset package displays on the touch screen. Items in the package can be preset and may belong to different application regions.

You may configure more than one measurement package for current exam mode. Under actual measurement status, switch the measurement library if necessary.

Click [Advanced] on the [Measure] page to enter the “Add New Package” page.

- [Available Items]: shows application packages configured in the system but not yet assigned to the current mode.
- [Selected Items]: shows application packages assigned to the current exam mode. If more than one package is assigned to the current exam mode, you can rotate the knob under the [Library] button on the touch screen or clicking menu title in the measuring status.

Package editing includes Creating Packages, Add/Remove Items, Deleting Measurement Packages, Setting Default Packages, Adjusting Package Positions.

- Creating Packages: Click [New] and enter a name for the new package in the dialog box pop-up. Click [OK] to confirm, the new package displays in the [Available Items] list.
- Adding/Removing Packages: Add/remove the package by clicking [>], [>>], [<] and [<<].
- Deleting Packages: Select a package from the [Available Items] list, click [Delete]. To delete an item from [Selected Items], you need to move it to the [Available Items] first.
- Setting Default Packages: Select a package from the [Selected Items] list, then click [Default]. The default package is marked with a √.

The default package displays when entering the [Measure] page.

The measurement menu of the default package (corresponding to the exam mode) displays when entering the measuring status.

- Adjusting Package Positions: Select a package from the [Selected Items] and click [Move Up]/[Move Down] to adjust the sequence that the packages in the menu are arranged in.

Measurement Menu Preset

The following operations are available.

- Adding/Removing Items: Add/Remove the general measurement item using the [>], [>>], [<] and [<<].
- Setting Default Items: Select an item from the [Selected Items] list, click [Default]. The defaulted item is marked with a √.

To deselect the default tool, select it and click [Default] or set another item as the default.

If a particular item is set as the default item, it automatically displays the submenu of the study when entering this measurement menu.

- Adjusting Item Positions: Select an item from the [Selected Items], click [Move Up]/[Move Down].

The order in the list is also the item position in the menu.

User-defined Measurement/Calculation/Study

NOTE:

- Please ensure the correctness and validity of the defined formula, otherwise Mindray will not be liable for damage caused by improper definition of the formula.
- Trigonometric functions are in degrees, not radians.
- PI is accurate to 7 digits.
- Adding B-Hist or B-Profile to the study is not supported.
- Click [Export Custom] in the measurement preset window to export the user-defined measurement.

User-defined Measurement

Perform the following procedure:

1. In Measure page, select [New], the “Measurement Custom Wizard” dialog box appears.
2. Enter the Name in the “Measurement Custom Wizard” dialog box, and select Add Meas.

The “Measurement Custom Wizard” dialog box appears, as shown in the following figure.

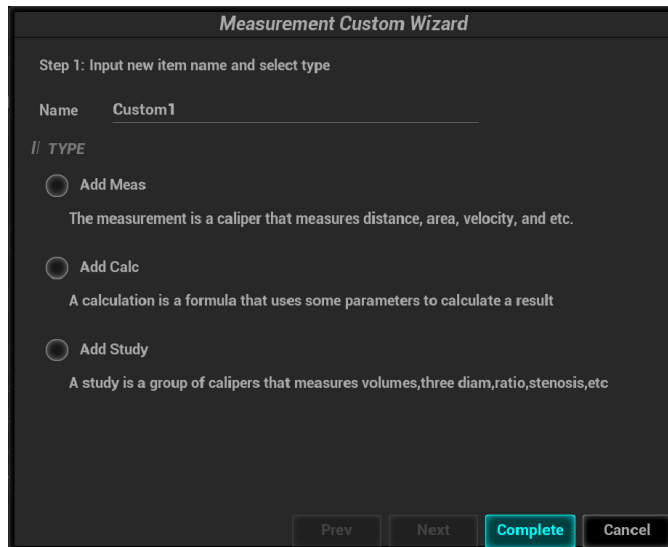

3. Select [Next] to Step 2. Select the [Tool Type], [App Region] and the Measurement Result. Descriptions of the attributes in the dialog box are shown in the following table.

Attributes	Descriptions
App Region	Select the application region for the user-defined item.
Tool Type	General measurement tool type of the user-defined item. E.g. Select Dist. if you want to add a new item to measure the distance.
Has Left-Right	If selected, you can choose left or right side in the measurement menu.
Has Prox-Mid-Dist	If selected, you can choose proximal, middle or distal in the measurement menu.
Measurement Result	Choose the results to be displayed in the results window. The result name can be changed. Move the cursor over an item, then enter the name in the text box.

Attributes	Descriptions
Unit	Select the measurement unit. Select “Unit” column of each item to select.

4. Select [Complete] to finish setting. The user-defined measurement item is listed in the “Selected Items” menu and in the “User-defined” category of “Available Items.” An asterisk appears after the user-defined item for identification.

In the meantime, the user-defined item will be added automatically to the “Selected Items” in the Report template. If the item is completed in an exam, the results will be displayed in the report.

User-defined Calculations

User-defined calculations are derived from arithmetic operations in which the parameters are measurement, calculation or study results obtained in measurement items which exist in the system or are user-defined.

Perform the following procedure:

1. In Measure page, select [New], the “Measurement Custom Wizard” dialog box appears.
2. Enter the Name in the “Measurement Custom Wizard” dialog box, and select Add Calc.
3. Select [Next] to Step 2. Select the [App Region] and edit the formula.

Descriptions of the attributes in the dialog box are shown in the following table.

Attributes	Descriptions
Formula	Displays the user-defined formula.
Verify	Used to verify if the formula is valid.
Application Region	Select the application region for the user-defined item.
Measurement Item	All available measurement items of the application region selected in the previous step.
Calculator/Function	You can select from measurement/calculation/study items in 2D/M/Doppler mode.
Unit	Used to enter numbers and functions in the formula.

For example, to create a user-defined measurement item (HC/AC):

- a. Enter name for the item, such as “calculation 1.”
- b. In Region select “Obstetric,” then select the measurement tool sources “2D” and “Measurement.”
- c. Find HC in the “Item Name” list, click to select it, then double-click HC in the Result Name box on the right side. The index is added to the formula.
- d. In the Calculator, click “/” and it is added to the formula.
- e. Find AC in the “Item Name” list, click to select it, then double-click AC in Result Name box on the right side. The index is added to the formula.

The function description is as follows:

Function	Method	Parameter Number	Function Description
sin	sin(a)	1	Sine (the ratio of the opposite to the hypotenuse)
cos	cos(a)	1	Cosine (the ratio of the adjacent to the hypotenuse)
tan	tan(a)	1	Tangent (the ratio of the opposite to the adjacent)
atan	atan(a)	1	Arctangent (the result is expressed in radian.)
min	min(a,b,...)	≥ 2	Minimum
max	max(a,b,...)	≥ 2	Maximum
sqrt	sqrt(a)	1	Square root
pow	pow(a,b)	2	Calculate b power of a
exp	exp(a)	1	Exponential function with natural constant e as the base
ln	ln(a)	1	Logarithm with natural constant e as the base
log	log(a)	1	Logarithm with 10 as the base
avg	avg(a,...)	≥ 1	Average value
abs	abs(a)	1	Absolute value
PI	PI	/	Constant π , 3.1415926

NOTE:

The letter “a” and “b” in the “Method” Column are parameters.

The following physiological indicators can be added to the formula.

Name	Definition	Unit
Age	Age	day
BSA	Body surface area	m ²
PSA	Prostate specific antigen	ng/ml
PPSA Coefficient	PPSA Coefficient	ng/ml ²
RAP	Right atrial pressure	mmHg
GA	Gestational age	day
Height	Height	cm
Weight	Weight	kg
Heart Rate	Heart rate	bpm
High BP(CAR)	High blood pressure (Cardiac)	mmHg
Low BP(CAR)	Low blood pressure (Cardiac)	mmHg
High BP(VAS Left)	High blood pressure (Left Vessel)	mmHg

Name	Definition	Unit
Low BP(VAS Left)	Low blood pressure (Left Vessel)	mmHg
High BP(VAS Right)	High blood pressure (Right Vessel)	mmHg
Low BP(VAS Right)	Low blood pressure (Right Vessel)	mmHg

- Verify the formula, select the unit of the result, then select [Complete]. The user-defined calculation item is listed in the “User-defined” category of “Available Items.”

In the meantime, the user-defined item will be added automatically to the “Selected Items” in the Report template. If the item is completed in an exam, the results will be displayed in the report.

User-defined Study Items

Perform the following procedure:

- In Measure page, select [Add Study].
- Enter the study name in the dialog box that appears.
- Select [OK] and the item will be added to the “Selected Items.”
- Select a measurement/calculation item from the “Available Items” and select [>] to add the item to the user-defined study.

Add a Study

You can add or remove user-defined study items in the [Selected Items] column.

Perform the following procedure:

- Select the [Measure] tab page.
- Click [Add Study] on the right.
- Enter the study name in the dialog box that appears.
- Click [OK] and the item will be added to the “Selected Items.”
- Select a measurement/calculation item from the “Available Items” and click [>] to add the item to the user-defined study.
- Repeat the step 5 to add more items if necessary.
- Move the cursor to click on the study and click [Property] on the right to edit the measure sequence.

Edit User-defined Items

Select the target defined item in the “Available Items”, and click [Edit].

Remove User-defined Items

- Remove Measurement/Calculation
 - Select “User Defined” in the “Available Items”, and select the desired item.
 - Click [Delete].
- Remove Study

Select a user-defined study, click [<].

4.3.3 Report Preset

NOTE:

- Deleting is not supported in IVF, IMT and EM reports.
 - Watch the layout when setting the patient information layout of the report template. Do not set too many characters in one line; otherwise it may affect the display of the report.
-

Creating Report Templates

Perform the following procedure:

1. Select the [Report] on the [Measure] page.
2. Click [New] to bring up the following dialog box.
3. Select template: click the drop-down list under “Application Region” to select the template and click [OK] to confirm the template layout and exit the dialog box.
4. Enter the name for the user-defined report template in the box after “Report Template Name”.
5. Click [Measurement] to select measurement results to be displayed in the report:
 - a. Select an application category from the drop-down list beside “Available Items”.
 - b. Select Measurement, Calculate, Study or All from the drop-down list beside “Available Items”. The corresponding items appear in the list.
 - c. Use the [>] or [>>] buttons to add items to the “Selected” list.
 Only tools which appear in the right column and are completed in the ultrasound exam can be displayed in the report.
 In cardiac mode, if result items of only one formula are selected, only results of that one formula will be displayed after measurement. (For e.g., if only items suffixed with Teicholz are selected, not with Gibson or Cube, then only results suffixed with Teicholz after measurement are displayed.)
 - d. Add the study.
 Click [Add Study] and enter the study name in the dialog box which appears, then click [OK].
 The new added study appears in the “Selected” list.
 - e. Adjust the item position.
 Select an item from the “Selected” list, click [Up]/[Down] to adjust the position of the item in the list, as well as in the report template.
 - f. Click [OK] to save the settings and exit the dialog box.
6. Set the module display in the report: click [Setting] to make a selection;
 - Tick the check box in front of the module name to display the module in the report;
 - Click [OK] to save the setting and exit.
7. Change the patient information layout in the report template:
 - Change the template used in the report layout: click [New Layout] to select another template.
 - Double click the information lines to be edited in “Report body”. The dialog box of font setting appears. Set the font size, font weight or hidden key words.
 - Double click the blank of a module in “Report Body”. The dialog box of editing the content appears. Select the content to be displayed at current position.
 - Press left <Set> key on the blank of a module in “Report Body”. Choose to add or delete the line, or add the table, etc.

8. Click [Save] to save the setting.
9. Click [Close] to quit the template.

Deleting Report Templates

Perform the following procedure:

1. Select the [Report] on the [Measure] page.
2. Select the template to be deleted from the list.
3. Click [Delete] > [Yes] to delete the selected template.
4. Click [OK] to confirm the settings.

Editing Report Templates

Perform the following procedure:

1. Select the [Report] on the [Measure] page.
2. Select the template to be modified from the list.
3. Select [Edit] to enter the [Measurement Report Preset] dialog box.
4. Click [OK] to confirm the settings.

Setting Default Templates

Perform the following procedure:

1. Select the [Report] on the [Measure] page.
2. Select a report template from the list.
3. Click [Default].
4. Click [OK] to confirm.

4.4 Comment Preset

You can preset the custom comments library for current exam mode. The comments in the library are provided by the system or user-defined ones.

4.4.1 Comment Configure

Add a user-defined item

Directly enter user-defined comment texts: posit the cursor in the field box above [Add Comment], enter the text comment through the soft keyboard, and then click [Add Comment]. Then the directly-entered comment will be added to the Selected Items.

Select available items

Perform the following procedure:

1. Select available items:
 - a. Select a comment library in the drop-down list below “Application”.
 - b. Select a comment type in the drop-down list below “Type”.

All items will be displayed below “Available Items”.

2. Click [>], [>>], [<] and [<<] to add the item in Available Items on the left into Selected Items on the right.

TIP:

You can only delete the user-defined items rather than the items in the system library. After a user-defined item is deleted, it will not be available.

Change position of the selected items

Select an item on the right side box and click [Up], [Down], [Left] or [Right] button to change the position of the item.

4.4.2 Comment Group Define

Add user-defined group

Enter user-defined group name in the name text box below [Lists Name] through the soft keyboard, click [Add Group]. The entered group name will be added to the Group Lists.

Add comment items to the user-defined group

Perform the following procedure:

1. Select a user-defined comment group from the “Group Lists”.
2. Do one of following to add comment items:
 - Select a comment library in the drop-down list below “Application”: Select a comment item, click [>] to add it into Selected Items on the right; click [>>] to add all items into Selected Items on the right directly
 - Add user-defined comment item: Enter user-defined comment in the name text box above [Add Comment] through the soft keyboard, click [Add Comment]. The entered comment item will be added to the Selected Items.

Change position of the selected items

Select an item and click [Up], [Down] button to change the position of the item.

Delete a comment item from user-defined group

Select an item in the Selected Items, click [<].

TIP:

You can only delete the user-defined items rather than the items in the system library. After a user-defined item is deleted, it will not be available.

4.5 iWorks Preset

You can customize the protocols and views in the iWorks preset screen.

4.5.1 Protocol Management

- Click to select the protocol in the list. The protocol type can be checked on the right.
- Click [Add Protocol] to create a new protocol. It can be customized.
- Click to select a protocol in the list on the left and click [Copy]. A protocol named “XXX_Copy1” is created with the copied views, which can be customized.
- Select a view with “Left”, “Lt”, “Right” or “Rt” in its name in the list on the left, and click [Copy L<>R]. The selected view is copied onto a new view in which bodymarks, annotations and measurement items are reversed to the opposite side.

- Click [Delete] to delete a user-defined protocol.
- Click [Up] or [Down] to move the selected protocol.
- Click [Move to Top]/[Move to Bottom] to move the selected protocol to the top or bottom of the list.

4.5.2 View Management

- Click to select the views in the list. The image, annotation, body mark and measurement settings can be checked on the right.
- Click to select a user-defined protocol in the list. Click [Add View] to add a view template to the protocol.

4.5.3 Create a New Protocol

You can create user-defined protocols and customize the automated procedure.

Perform the following procedure:

1. In the iWorks preset screen, click [Add Protocol] to create a new protocol.
Or, select an existing protocol and click [Copy] to customize the protocol based on the previous template.
2. Enter the protocol name, type and select the application region.
3. Click [Add View] to enter the view name and perform image settings.
 - To set PW Angle Correction, you can select [Default/Last Use] to keep the angle of a newly-created view the same as that of the last view.
 - In the measurement setting, if “Measurement on next section” is selected, the system will save two section images after finishing the section operation. One of the two sections will include the measurement result.
 - Select the checkbox of “Disable Protocol Body Marks” for body mark display settings.

4.6 Stress Echo Preset

4.6.1 Protocol Edit

You can create, edit, delete, copy, export and load the Stress Echo protocols using the Protocol Editor dialog box.

Item	Description
Protocol Name	Enter the protocol name.
Trigger	Set the trigger type.
WMS model	Set the chamber segment division method.
Loop usage	Displays the acquired loop number as well as the total usable loop number.
View	Set the views for each stage.
Standard Views	Set the standard view.
Load	Import a protocol.
Export	Export a protocol.
New Protocol	Create a new protocol.

Item	Description
Copy Protocol	Create a new protocol with an existing one.
Delete Protocol	Delete the protocol.
New stage	Create a stage for the current protocol.

Creating a Stress Echo Protocol

Perform the following procedure:

1. Click the [New Protocol] to the right of the Protocol Editor dialog box.
2. Enter the protocol name in the Protocol Name box at the top.
3. For each view (all views display for each phase):
 - a. Select “New View” in the View list.
 - b. Select a standard view from the Standard View list. Or you can customize the view name.
4. For each phase in the protocol:
 - a. Select “New Stage” in the Stage list.
 - b. Enter a phase name.
 - Select “Auto Select”, the system jumps to Select Mode after retrospective acquisition.
 - Select the required option from the Clip Capture drop-down list.
 - Select the number of loops to acquire (per view in the selected phase) in the Loops list (for non-continuous stages).
 - Select the type: exercise or drug.
5. Click [OK] to save changes and quit.

Editing a Stress Echo Protocol

Perform the following procedure:

1. Click a user-defined protocol on the Select Protocol screen.
2. Edit the protocol as described in the create protocol.

Deleting a Stress Echo Protocol

Click an user-defined protocol on the Select Protocol screen, click [Delete Protocol].

4.6.2 Maintenance

Item	Description
Acquire mode	Set the type of ROI: manual ROI or full-screen.
Overlay	Select the items to be labeled on each loop.
WMS score type	Set the chamber segment division method.
QT-Time table	To customize the length of systolic duration acquired for a specific heart rate, it will store the clip duration. You can add and remove entries in this table. You can also load the factory defaults.
Heart rate	Enter the heart rate.
Syst. duration	Enter the systolic duration.
Load factory	To reset the QT time table.

4.7 DICOM/HL7

4.7.1 DICOM Local Preset

TIP:

- AE Title should be the same with the SCU AE Title preset in the server (PACS/RIS/HIS), for example, if the AE Title of the server preset in the storage server is Storage, and the AE Title of the accepted SCU is preset as Machine, then in the figure above, the AE Title of Local should be Machine, and the AE Title of storage server should be Storage.
- The device name is random. If the server name is same with that in the DICOM server list, the information “the server added already exists”, click [OK] to retype the name.
- IP address should be the address of the remote server.

DICOM local preset items are described as follows:

	Item	Description
Local Host DICOM service property	AE Title	Application Entity title.
	Port	Communication port, DICOM communication port.
	PDU	Maximum PDU data package size (not need to change), ranging from 16384 to 65536; if the value is less than 16384 or greater than 65536, the system automatically sets it to the value 32768.
	DICOM output charasets	Select an character set for DICOM output according to the local PACS workstation.
	Transcoding elements	Set what DICOM element(s) will be transcoded.
	TLS Port	Set the TLS port.
	TLS Server Setting	Import the encryption key/certificate.
	TLS Client Setting	<ul style="list-style-type: none"> • After importing TLS certificates, and selecting Verify Certificate check box, the system verifies the effectiveness of the TLS function in the DICOM storage, print, and worklist services. • Import trusted certificates, or delete certificates.
Server Setting	Device	Name of the device supporting DICOM services.
	IP Address	IP address of the server.
	Ping	You can ping the other machines after you entered the correct IP address. Besides, you can select a server in the Device list to ping it.
	Device List	Displays the added device.
	Set DICOM Service	Provides server settings of DICOM service, for details, please refer to the following chapters.
	Set DICOM Strategy	Click to enter the configure the strategy screen.
	Log Level	For engineer use only.
	Capture	

Add a Server

Perform the following procedure:

1. Enter the server device name and IP address.
2. Click [Ping] to check the connection.
3. Click [Add] to add the server to the device list, and its name and address are displayed in the list.

Delete a Server

Select a server in the device list, and then click [Delete].

Set DICOM Strategy

TIP:

- The DICOM strategy must be configured by qualified personnel with good knowledge of DICOM standards.
 - The qualified personnel must ensure the validity of the DICOM strategy.
-

Perform the following procedure:

1. Click [Set DICOM Strategy].
2. Edit the DICOM strategy:
 - Add: Enter strategy name and description, and click [Add] to add a new strategy. Then the added strategy will be added to the Strategy List.
 - Delete: Select a strategy from the Strategy List, and click [Delete].
 - Update: Select a strategy from the Strategy List, re-enter strategy name or description, and click [Update].
3. Configure the item:

Select a strategy name from the Strategy List, and assign strategy items to the selected strategy.

- Add: Set the function from the drop-list box, enter the parameter 1 and parameter 2, and click [Add]. Then the added strategy item will be added to the Strategy Items List.
 - Delete: Select a strategy item from the Strategy Items List, and click [Delete].
 - Update: Select a strategy from the Strategy Items List, reselect the function or re-enter the parameter 1/2, and click [Update].
4. Import/Export strategy:
 - Import: Click [Import], browse the desired strategy file and operate according to the screen prompts to import.
The imported file for DICOM strategy must be a *.xml file.
 - Export: Select a strategy from the Strategy List, click [Export] and then select the export path and type the file name.
E drive is default, and the file type is .xml.

4.7.2 DICOM Service Preset

The DICOM Service screen is used to set attributes for DICOM service.

When the system is configured with DICOM basic function module, and installed with DICOM modules, the corresponding preset can be found in DICOM Service screen.

TIP:

Not all SCPs can support verification. See the SCP properties to confirm whether the SCP can support this service. If not, the verification will not be successful.

Perform the following procedure:

1. Click [Set DICOM Service] on the DICOM/HL7 screen.
2. Select the DICOM service tab to enter the corresponding settings screen.
3. Enter the correct AE Title, port, etc.
 - Click [Add] to add the service to the Service List.
 - Select an item in the service list, change the parameters in the above area, and click [Update] to update the item in the service list.
 - Click to delete the selected service in the service list.
 - Select an item in the service list, click [Default] and you can see “Y” in the Default column.
4. Click [Verify] to verify that the two DICOM application entities are properly connected. If the verification is successful, the system displays “xxx Verify Succeed.” Otherwise, it displays “xxx Verify Failed.”

If verification failed, possible causes may be: wrong IP address, not able to access IP address, remote DICOM server is not running, wrong port, incorrect application name.

Storage Service Preset

DICOM storage preset items are described as follows:

Item	Description
Device	After you set the server (s) in DICOM Preset screen, the name (s) will appear in the drop-down list, select the name of the storage server.
Service Name	Default is xxx-Storage, user-changeable.
AE Title	Application Entity title, here, it should be consistent with that of the storage server.
Port	DICOM communication port, 104 is default. Here, the port should be consistent with that of the storage server port.
Maximum Retries	Set the maximum retries (0-9). The default value is 3. If the DICOM task sending to the server fails, the retry times should be 3.
Interval Time(s)	Interval time.
Timeout	Refers to the amount of time after which the system will stop trying to establish a connection to the service.
TLS	Transport Layer Security. Select whether to encrypt the data during network transportation.
Cine Zoom Mode	Select the cine zoom mode during image file storage.
Compression Mode	Select the compression mode: original data (uncompressed), RLE (the image not compressed), JPEG, and JPEG2000.
Compression Ratio	Select the JPEG compression ratio: lossless, low, medium, and high. The compression ratio is inversely proportional to the image quality (reserved function).

Item	Description
Color Mode	Select the color mode. If you choose the mix or the grey, RLE/JPEG is unavailable. The image uses 24 bit when sending the image from the ultrasound device to the server; it depends on the image when choosing the mix. The image use 8 bit if the image is captured in color mode or the image has the tint. All images use 8 bit when choosing the grey.
Allow Multiframe	If SCP supports this function, then select it.
Max Frame Rate	Set the frame range of transferring cin file into DCM multi-frame file. It is editable to the user.
3D/4D	Set the 3D/4D image transfer mode. Set the transfer mode for the 3D/4D cine sending. <ul style="list-style-type: none"> • Normal: use the way that 2D image adopts to send; • Volume: use Enhanced US Volume Storage IOD to send; • Data source: used to obtain 3D/4D image for 4D Viewer.
SR Storage Option	To enable or disenable structured reporting sending.
Encapsulated PDF	Select if to encapsulate PDF format report in DICOM standard. It becomes available if SCP supports the function.
Doppler audio	Set to save the audio of PW mode.
Storage mode	Set the storage mode for image and cine file: <ul style="list-style-type: none"> • Parallel file: save the current file, and is ready for the storage of the next file. • Parallel frame: send the current frame, and is ready for sending the next frame.
TransducerTracking	Files of images that are saved in DCM format through DICOM or DICOMDIR contain transducer serial number information.
Strategy Name	Set the DICOM strategy.

TIP:

- If the server software supports the compression algorithm, select JPEG, RLE, JPEG2000. Otherwise, original data should be used (RLE is the default method).
- RLE, JPEG and JPEG2000 are not supported by all SCPs. Refer to the SCP's DICOM CONFORMANCE STATEMENT electronic file to check whether SCP supports it or not. Do not select these compression modes if the storage server does not support them.
- Images of PW/M/TVM/TVD mode (B image is not frozen) and images other than PW/M/TVM/TVD mode: if "Max Frame rate" is not "Full" and the actual frame rate is larger than the set value, the system will save the image files in a frame rate of the set value, and transfer in a frame rate of B mode.
- Images of PW/M/TVM/TVD mode (B image is frozen), the system will save/transfer the images files in frame rate of 6.

Print Service Preset

DICOM print preset items are described as follows:

Item	Description
Device	After you set the server (s) in DICOM Preset screen, the name (s) will appear in the drop-down list, select the name of the print server.
Service Name	Default is xxx-Print, user-changeable.
AE Title	Application Entity title, here, it should be consistent with that of the print server.
Port	DICOM communication port, 104 is default. Here, the port should be consistent with that of the print server port.
Maximum Retries	It starts retrying if it fails to send DICOM task to the server. The retry entry times should be this value.
Interval Time (s)	Reserved time.
Timeout	Refers to the amount of time after which the system will stop trying to establish a connection to the service.
TLS	Transport Layer Security. Select whether to encrypt the data during network transportation.
Copies	Refer to copies of printed files. You can select among 1 through 5, or directly enter the numeral.
Settings	The system supports RGB (color printing) and MONOCHROME2 (black and white printing). Please select the type the printer supports.
Film Orientation	Select between LANDSCAPE and PORTRAIT.
Priority	Specify printing task priority among HIGH, MED and LOW.
Film Size	Select film size among the selections listed in the drop-down list.
Display Format	Specify quantity of printed files, e.g. STANDARD\2, 3 indicates 6 images are printed for each page.
Medium Type	Specify print medium: Paper, Clear Film, Blue Film; select Blue Film or Clear Film for black and white printing; select Paper for color printing.
Trim	Specify whether you want a trim box to be printed around each image on the film: Yes or No.
Configuration Info	Enter configuration information in the field.
Min Density	Enter the minimum density of the film.
Max Density	Enter the maximum density of the film.
Destination	Specify where the file is exposed: MAGAZINE (stored in the magazine), or, PROCESSOR (exposed in the processor).
Magnification Type	Select how the printer magnifies an image to fit the film. <ul style="list-style-type: none"> • Replicate: interpolated pixels belong to duplicate of adjacent pixels); • Bilinear: interpolated pixels are generated from bilinear interpolations between adjacent pixels; • Cubic: interpolated pixels are generated from cubic interpolations between adjacent pixels; • None: without interpolation.

Item	Description
Strategy Name	Set the DICOM strategy.

Worklist Setting

DICOM service setting for Worklist is described as follows:

Item	Description
Device Name	After you set the server (s) in DICOM Server Setting screen, the name (s) will appear in the drop-down list, select the name of the Worklist server.
Service Name	Default is server-Worklist, and it can be modified.
AE Title	Application Entity title. It is consistent with that of the Worklist server.
Port	DICOM communication port, 104 by default. The port should be consistent with that of the Worklist server port.
Maximum Retries	Reserved feature.
Interval Time(s)	Reserved feature.
Timeout	Refers to time after which the system will stop trying to establish a connection to the service.
TLS	Transport Layer Security. Select whether to encrypt the data during network transportation.
Strategy Name	Set the DICOM strategy.
Remove Attributes(0)	Set what DICOM element(s) that will not be used in worklist query.

MPPS Preset

MPPS setting items are described as follows:

Item	Description
Device Name	After you set the server (s) in DICOM Server Setting, the name (s) will appear in the drop-down list, select the name of the MPPS server.
Service Name	Default is server-MPPS, and it can be modified.
AE Title	Application Entity title. It should be consistent with that of the MPPS server.
Port	DICOM communication port, 104 by default. The port should be consistent with that of the MPPS server.
Maximum Retries	It starts retrying if it fails to send DICOM task to the server. The retry entry times should be this value.
Interval Time(s)	Reserved feature.
Timeout	Refers to the amount of time after which the system will stop trying to establish a connection to the service.
TLS	Transport Layer Security. Select whether to encrypt the data during network transportation.

TIP:

Set the MPPS service as the default when using the MPPS.

Storage Commitment Setting

DICOM storage commitment setting items are described as follows:

Name	NOTE
Device Name	After you set the server (s) in DICOM Server Setting, the name (s) will appear in the drop-down list, select the name of the storage commitment server.
DICOM Service Name	Default is server-SC, and it can be modified.
AE Title	Application Entity title. Here, it should be consistent with that of the storage commitment server.
Port	DICOM communication port, 104 by default. Here, the port should be consistent with that of the storage commitment server port.
Maximum Retries	Reserved feature.
Interval Time(s)	Reserved feature.
Timeout	Refers to the amount of time after which the system will stop trying to establish a connection to the service.
Associated Storage Service	The associated storage server is preset before storage commitment, only after the exam is sent out, can storage commitment be created.
TLS	Transport Layer Security. Select whether to encrypt the data during network transportation.

Query/Retrieve

DICOM query/retrieve setting items are described as follows:

Item	Description
Device Name	Select the name of a device that can be added (including the local).
Service Name	Default is server-queryRetrieve, and it can be modified.
AE Title	Application Entity title. Here, it should be consistent with that of the storage commitment server.
Port	DICOM communication port, 104 by default. Here, the port should be consistent with that of the storage commitment server port.
Maximum Retries	Reserved feature.
Interval Time(s)	Reserved feature.
Timeout	Refers to the amount of time after which the system will stop trying to establish a connection to the service.
TLS	Transport Layer Security. Select whether to encrypt the data during network transportation.

HL7 Query Service Preset

The protocol version that the ultrasound system supports: V2.3, V2.4, V2.5, V2.6.

HL7 service setting for Worklist is described as follows:

Item	Description
Device Name	After you set the server (s) in DICOM Server Setting screen, the name (s) will appear in the drop-down list, select the name of the Worklist server.
Service Name	Default is server-HL7Query, and it can be modified.
AE Title	Application Entity title.here, it should be consistent with that of the HL7 server.
Port	DICOM communication port, 104 by default.Here, the port should be consistent with that of the HL7 server port.
Maximum Retries	Reserved feature.
Interval Time(s)	Reserved feature.
Timeout	Refers to the amount of time after which the system will stop trying to establish a connection to the service.
Listen mode	This function enables the ultrasound system to use the listen port for data receiving.
Listen port	Port for ultrasound system to receive data after the listen mode function is activated. Here, the port should be consistent with that of the HL7 server port. For details of listen port setting, refer to settings in the server.

4.8 Network Preset

4.8.1 Network Settings

Transmission Encryption

After accessing the network, click [VPN Config] to enter the “VPN Config” interface.

The screenshot shows the 'VPN Config' interface with the following elements:

- Status:** Ready
- Server IP:** [Empty text field]
- Group:** [Empty text field]
- User Name:** [Empty text field]
- Password:** [Password input field with a blue bar]
- Hide characters:** (checked)
- Buttons:** Connect, Disconnect, Advance, and Close.

Item	Description
Status	<ul style="list-style-type: none"> No driver: click [SetupDriver] to enter the “TAP-Windows 9.21.2 Setup” interface, and do as instructed. Ready: the VPN is ready for use. Advance: VPN Advance Configuration Connected: VPN is successfully connected. Disconnected: VPN is disconnected. Error: error connection.
Server IP	/
Group	/
User Name	/
Password	/
Hide characters	The password is displayed as *.
Connect/ Disconnect	Connect or disconnect VPN.
Advance	<p>Enters the “VPN Advance Config” interface.</p> <ul style="list-style-type: none"> Reset: if the system does not respond after you click [Config], click [Reset]. Config: enters the “OpenConnect-GUI VPN client” interface. For details about the settings, please refer to the TAP manual. <p>NOTE:</p> <p>After exiting the “VPN Advance Config” interface, you need to reboot the system; otherwise, you cannot connect VPN normally.</p>
Close	Close the “VPN Advance Config” interface.

Turn on Wi-Fi function

1. Select [Network Settings] page in Network Preset screen.
2. Confirm the Wi-Fi is enabled: [Disable Wifi] appears on the screen.

Turn on hosted network function

Reserved.

4.8.2 iStorage Preset

You can send exam data or images to the iStorage server and perform analysis using UltraAssist. For details about this feature, see the UltraAssist manual.

Item	Description
Service Name	The name of the iStorage service.
IP Address	IP address of the iStorage service device.
Port	Port for transmitting.
Charset	Set the character set.

Add an iStorage service

Perform the following procedure:

1. Set the iStorage server properties as described above.
2. Click [Connect] to verify connection.
3. Click [Add] to add the service to the Service list.

Edit a network service

Perform the following procedure:

1. Select the service to be updated in the service list.
2. You can see properties in the Configure Service area.
3. Do one of the following to edit the network service:
 - Modify the properties and click [Update] to update the setting.
 - Click [Default] to set as the default service.
 - Click [Delete] to delete it from the service list.

4.8.3 MedTouch/MedSight Preset

You can set environment for MedTouch/MedSight here and then use the MedTouch/MedSight function by mobile phone or tablet computers. See MedTouch/MedSight manual for details.

4.8.4 Remote Maintenance

NOTE:

- After the remote maintenance permission is enabled, it indicates that the ultrasound equipment permits remote access from the remote controller to upgrade the equipment, transmit files, or check and download logs.
 - Once enabled, the remote maintenance permission is enabled by default after restarting the ultrasound equipment.
-

Perform the following procedure:

1. Select [Remote Maintenance Permission].
2. Select [Upload logs to remote server] to upload logs to the remote server, Mindray service engineers can acquire and handle those log.

Check the process in “Task Management” screen.

4.8.5 Q-Path Preset

You can use the ultrasound system to check data on browser directly. After you have ordered storage service of a network website service, you can check data using the website, authorized account and password (provided by the service vendor). You can open the browser (Q-View) to review previously sent DICOM data.

Q-path is a network server provided by Telexy Healthcare Inc. for digital image storage. Q-View is a client viewing tool for the server. Telexy Healthcare developed technology and a command structure that allows any Q-view enabled ultrasound system to access Q-path directly from the ultrasound system using a single control. The primary purpose for Q-view is to provide remote access to Q-path from the ultrasound system to complete the exam report on the ultrasound system and submit for QA.

To access Q-Path on the system, the user just opens the Q-View first and then enters the URL, user account and password provided by Telexy Healthcare, and the system software system will call Q-View tool then for user Q-Path application.

For details, please contact Q-Path service provider.

Q-Path Basic Preset

Item	Description
Advanced	Sets the sub URLs of “QView full” and “QView lite”. The sub URL is set by default. Users can modify the sub URL and click [Apply] to exit the “QView sub URL setting” window.
Enable Direct Report	Sets whether to open the Q-Path server through the [Report] key.
Worksheet Only	Sets whether to directly enter the Worksheet interface after opening the Q-Path server.
Password On Worksheet	Sets whether to display the Signature field box in a worksheet. Tap [Report] > [WorkSheet] or tap [Review] > [Report] > [WorkSheet], enter the worksheet password in the field box, and click [OK]. Users can query the corresponding worksheet by searching the worksheet password in the Q-Path server.
Password On End Exam	Sets whether to input the worksheet password after ending an exam.
Password Visible	Sets whether the password is visible.
Import	Imports a user-defined worksheet template from the USB storage (downloaded from the Q-Path server).
Backup	Backs up worksheets to the USB storage.
Restore	Restores the backup worksheet template from the USB storage to the ultrasound system.
Delete	Deletes a worksheet template.
Restore Factory	Restores the worksheet template to the default state.

Perform the following procedure:

1. Select “Enable Q-Path”.
2. Enter the website, account and password of the target service.
3. Select user type: Personal User or Default User.
 - Personal User: the personal user needs to enter the user name and password in every-time login.
 - Default User: after the default user enters the user name and password in the field box of the “User Name” and “Password”, and click [OK], no login is required to access the Q-Path server later.
4. Select an appropriate item from the drop-down list of “Available Items”.
5. Select an exam mode in the left “Exam Mode” column.
6. Select a worksheet in the right “Worksheets” column.
7. Click [OK] to exit, and the system will shut down.

4.8.6 eGateway Preset

Before using eGateway, the system should be in the same network segment with the eGateway server, and ensure that the eGateway software version is 7.1 or later versions.

For details of eGateway installation and configuration, see eGateway manual.

eGateway Query

Item	Description
Service Name	The name of the eGateway service.
IP Address	Input the ADT Source IP address in the eGateway Server configuration interface.
Port	Input the MAQ Server Port in the eGateway Server configuration interface.
Clear	Click to cancel the parameter setting.
Add	Click to add the Network service to the service list.
Update	Select an item in the service list, change the parameters in the above area, and click [Update] to update the item in the service list.
Delete	Click to delete the selected service in the service list
Default	Set the eGateway server as the default. Select an item in the service list, click [Default] and you can see “Y” in the Default column.
Connect	Click to verify whether the connection is normal.

To add an eGateway service

1. Set the eGateway server properties as described above.
2. Tap [Add] to add the service to the service list.

To modify a network service

1. Select the service to be updated in the service list.
2. Modify the parameters in the upper part of the screen and tap [Update] to update the setting.

eGateway Store

Before using the eGateway storage, ensure the Send Mode is set to “MDM with Reference” in the eGateway Server configuration interface.

Type	Item	Description
Configure Service	Service Name	The name of the eGateway service.
MultiBackend	IP Address	Input the ADT Source IP address in the eGateway Server configuration interface.
	Port	/
DocServer	IP Address	Input the ADT Source IP address in the eGateway Server configuration interface.
	Port	Input the Document Sharing SSL Port in the eGateway Server configuration interface.
	Image/Cine/PDF Report	Set the shared document content.

Type	Item	Description
/	Clear	Click to cancel the parameter setting.
	Add	Click to add the Network service to the service list.
	Update	Select an item in the service list, change the parameters in the above area, and click [Update] to update the item in the service list.
	Delete	Click to delete the selected service in the service list
	Default	Set the eGateway server as the default. Select an item in the service list, click [Default] and you can see “Y” in the Default column.
	Connect	Click to verify whether the connection is normal.

To add an iStorage service

1. Set the iStorage server properties as described above.
2. Tap [Add] to add the service to the service list.

To modify a network service

1. Select the service to be updated in the service list.
2. Modify the parameters in the upper part of the screen and tap [Update] to update the setting.

4.8.7 MIOT Preset

After the MIOT (Mindray Internet of Things) service is enabled and configured, the Ultrasound device information such as Usage, Operating duration, can be transmitted to MIOT.

Item	Description
IP Address	IP address of the MIOT service device.
Port	Port for transmitting.
MIOT Service Switch On	Tap to enable MIOT service.

4.9 Print Preset

This screen is used to set up the printer and image printing.

4.9.1 Print Setting

Item	Description
Add Service	Click to begin adding print services.
Remove Service	Click to delete the selected print service.
Rename Service	Click to rename the selected print service.
Property	Preset print service properties.

4.9.2 Image Settings

Click [Image Setting] to enter the page, you can set the brightness, contrast and saturation of image printing, or you can use the default values.

4.10 Maintenance

In the Setup menu, select [Maintenance] to enter the screen.

The [Maintenance] function is designed for you to import or export user data, restore factory setting and export log. You may also execute self-test and option installation/trial through the maintenance menu. Furthermore, you can set the factory preset, export the register data, and etc.

If you require other maintenance functions, please contact Mindray Customer Service Department or sales representative.

4.10.1 Option

The system enters the Option page after entering the Maintenance screen. In the Option list, the system lists all the system-supported options and their installation status (not installed or installed).

To install and uninstall:

- Click [Install] to begin installing a disabled option.
- Click [Uninstall] to begin uninstalling a previously-installed option.

Please contact the Mindray Customer Service Department or a sales representative for details.

4.10.2 Exporting Setup Data

This function is used to write all setup data of the system into a disk for backup.

Perform the following procedure:

1. Select the target module.
2. Click [Export] to open the [Export Data] screen.
3. Select the path to save the data.
4. Select the exported file and type as PDP and click [OK].

4.10.3 Importing Setup Data

This function is used to import the existing setup data to the setup data memory of the system. The system will reset and operate according to the setup preferences that were imported.

Perform the following procedure:

1. Click [Import] to open the Load Data screen.
2. Select the imported file.
3. Click [OK], a progress bar will appear and the setup data is imported to the specified path.
4. To restore the factory setup data, click [Load Factory] on the right side of the screen.

4.10.4 Probe Check

This function is used to check the condition of transducer elements to evaluate the probe performance.

Before performing the probe check, ensure the probe head must be clean and the probe is in non-scanning state.

Click [Probe Check] to enter the Probe Check screen:

- If a transducer element is in malfunction, it is displayed as a red spot.
- If a transducer element functions well, it is displayed as a green spot.

You can export the result image to the external device.

4.10.5 Other Settings

Other preset settings are described as follows:

Item		Description
Load Factory		Local factory default settings.
Setup	Export Log	Export the log.
	Self Test	Perform system self-test and restart the machine.
	Recover	To recover the system.
	Enter Windows	For password, please contact your service engineer.
	Prepay Installment	Display the prepay installment information.
	Start/Stop WinProxy	Cursor debug interface.
	Touch Screen Calibration	To calibrate the touch screen.
	Needles List Replace	Update the list of needles that support eSpacial Navi function. NOTE: The list of needles must be release version provided by Mindray.
	Needles List Recover	Restore the list of needles that support eSpacial Navi function to the last version.
	Needles List Factory	Restore the list of needles that support eSpacial Navi function to the factory version.
	Enable Tracking	Enable the transducer and patient tracking function: <ul style="list-style-type: none"> • Find transducers used with a patient by patient ID. • Find patients who used a transducer by transducer SN. After enabling the tracking function, you can set the maximum number of days the data can be retained.
Fast Startup	To speed up the startup process. NOTE: If McAfee has been installed, please disable this function to avoid McAfee failure.	

If you have any questions, please contact the service engineer or your sales representative.

4.11 Security

4.11.1 Drive Encryption/Secure Data Wipe

Encrypt the patient data stored in the hard disk. The system provides two encryption methods: Factory Default and User Define.

- Factory Default: the system is in factory state by default.
- User Define: add a user-defined password.

Perform the following procedure:

1. Select [User Define].
2. If no patient data are stored in the hard disk, click [Confirm], input the password and click [Confirm] to finish the password setting

If the patient data are already stored in the hard disk, the system will pop-up prompts, follow the steps below:

- a. Click [OK].
- b. Click [Wipe] and operate according to the screen prompts to clear patient data.
- c. Select [User Define] again, and click [Confirm].
- d. Input the password and click [Confirm] to finish the password setting.

NOTE:

- If you want to switch to Factory Default, perform steps above again. The password is the same as that of the User Define.
 - When you set password, multi-language and Chinese characters are not supported.
-

4.11.2 Anti-Virus

The system provides two anti-virus software: Windows Defender and McAfee. They can effectively prevent the ultrasound system from being attacked by virus, spyware, or other malware.

- Windows Defender is already installed on the system.
- The McAfee software is an option. If you want to buy McAfee, contact the service engineer or your sales representative.

NOTE:

McAfee cannot be uninstalled after successful installation.

4.11.3 Transmission Encryption

After accessing the network, click [VPN Config] to enter the “VPN Config” interface, see “4.8.1 Network Settings”.

4.12 System Information

Click [About] on the Setup menu to enter the system information screen.

This screen displays the system software version and other versions of devices. You cannot edit the information, only view them. The information varies depending on the system configurations and version.

5 Exam Preparation

You can start a patient exam in the following situations:

- New patient information: to start a new patient exam, patient information must first be entered.
- New exam: to start a new exam for patient who is already registered, the recorded information can be obtained through either iStation or Worklist.
- Activate exam: to select an exam that has been completed within 24 hours, continue the exam with imported patient information and exam data.
- Continue an exam: to select an exam that has been paused within 24 hours, continue the exam with imported patient information and exam data.

5.1 Patient Information

5.1.1 New Patient Information

CAUTION

Before examining a new patient, tap the [End] on the touch screen to end the exam of the previous patient, update the patient ID and information, to avoid mixing data of the next new patient.

To start a new patient exam, it is better to type the detailed patient information. The system will set up a unique information database for each patient based on the patient information entered, so that the information of one patient will not be confused with that of another patient.

1. Tap [Info] on the touch screen to enter the patient information page.

Place the cursor onto the targeted box. The field box is highlighted and a flashing cursor appears. Information can be entered or selected from the options

NOTE:

- Patient ID is generated automatically by the system after starting a new patient, and can be modified manually. The characters “\”, “*”, “□” are not permitted.
 - You can either enter the patient’s date of birth manually, or click  to select the date, and click [Confirm] to finish.
 - The age unit can be “Years”, “Months” or “Days.” If the age is less than one year, the system will automatically calculate the age in months or days.
2. Exam Type
 - Select the exam type tab to enter exam-specific information.
 - Input general information/operating Information
 3. Functional keys
 - [New Patient]: click to clear the current patient information in the patient information screen in order to input new patient information.

- [New Exam]: click to clear the current exam information in order to create a new exam for the current patient.
- [Pause Exam]: to pause the current exam due to some special causes or system power off.
- [Cancel Exam]: to cancel the current exam.
The cancelled exam can't be restored.
- [Quick Register]: to save the patient information quickly and return to the main screen.
- [OK]: click to save the patient data entered and exit the screen.
- [Cancel]: click to cancel the patient data entered and exit the screen.

5.1.2 Retrieve Patient Information

iStation

The patient data can be obtained in iStation from the system hardware or USB memory device. You can enter the searching conditions for the patient.

1. Do one of the following to enter iStation screen:
 - Tap [iStation] on the touch screen.
 - Click [iStation] in the “Patient Info” screen.
 - Click [iStation] in the Review screen.

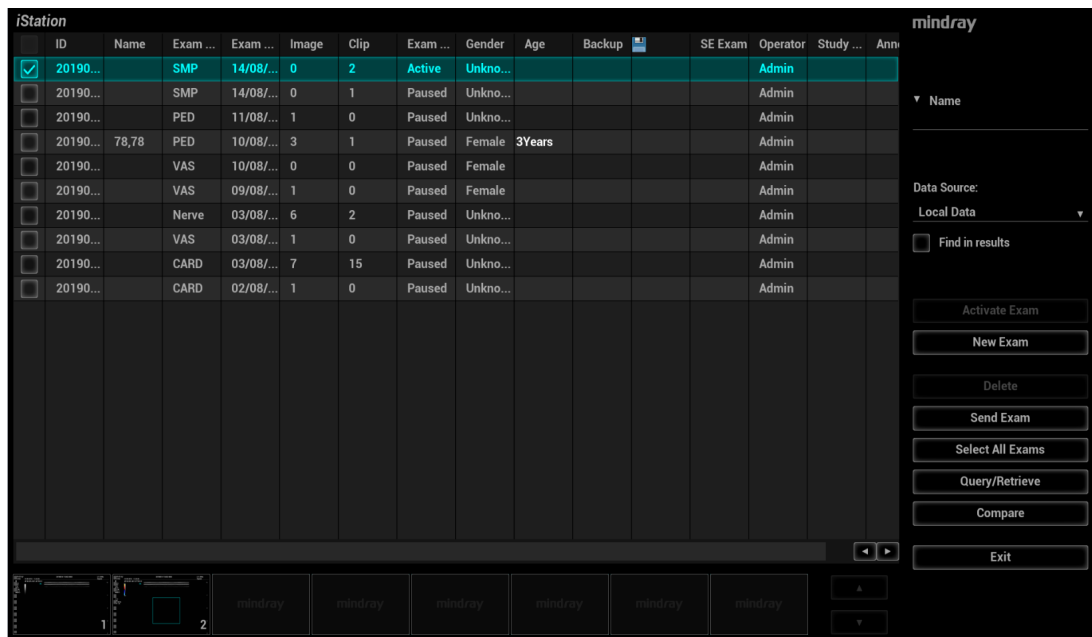

2. Select the data source.
Select the data source in the drop-down list of “Data Source”.
3. Input the searching condition.
The default condition is name. Select a searching condition from the drop-down list, enter a keyword or select the period in accordance with the condition selected.
Select “Find in results”, the system will search the keyword based on the existed searched results.
4. Select the desired patient information in the list, and the system pops up the shortcut menu.

Review Image	Click to enter the Review screen.
--------------	-----------------------------------

Patient Infor	Click to enter the Patient Info screen.
Review Report	Enter diagnostic report screen.
Delete Exam	Delete the selected record.
Backup Exam	Click to back up the selected patient record to media supported.
Restore Exam	Click to import the patient data from an external media.
Send Exam	Click to send the selected patient data to external device, storage server or printer.
Activate Exam	Click to continue an exam that has been finished within 24 hours.
Continue Exam	Click to continue an exam that has been paused within 24 hours.
Annotation Exam	Click to add annotations to the selected exam, or view the history annotations of the selected exam.

- Click [New Exam] to enter the Patient Info screen.

The corresponding patient information is also imported to the new exam simultaneously. After editing the patient information in the Patient Info screen, select [OK] to start a new exam.

WorkList/HL7 Enquiry

TIP:

Worklist is an optional function. Configure DICOM Basic and DICOM WorkList first.

When the DICOM basic package is configured and the Worklist server has been set, click [Worklist] in the "Patient Info" screen to query or import the patient data. For details, see "15.3 Worklist".

5.2 Activate& Continue an Exam

5.2.1 Activate an Exam

In iStation screen, select the exam record finished within 24 hours, and click [Activate Exam] from the menu popped up; or, click [Active Exam] in iStation or Review screen to activate the exam.

NOTE:

- The system can automatically load the patient information and exam data to continue the exam.
- If you want to continue an exam which data lies in an external memory database, you have to first allow the system to load the patient data to the system's patient database.
- For an only one re-activated exam, you can modify patient ID.

5.2.2 Continue an Exam

In iStation screen, select an exam record paused within 24 hours, click [Resume Exam] from the menu popped up to continue the exam.

If you want to select a patient data in an external memory database, you have to first allow the system to load the patient data to the system's patient database.

The patient ID can be modified for the exam only with one exam record and being activated again.

5.3 Pause & End an Exam

5.3.1 Pause an Exam

Sometimes, you have to stop an uncompleted exam due to some special causes. When the exam is paused, the system can begin other exams.

1. Tap [Info] on the touch screen to enter the patient information page.
2. Click [Pause Exam].

If the system is powered off during scanning, the exam status turns “paused” after the system restart.

When an exam is paused, the system will:

- Save the exam-related images, reports and measurement data, modify the status as “Paused”.
- Save the exam information, including report, imaging mode, exam mode, image parameters, operation mode, and imaging/measurement data and so on.

5.3.2 End an Exam

Before examining a new patient, tap [End] to end the exam of the previous patient, update the patient ID and information, to avoid mixing data of the next new patient.

To end an exam, do one of the following:

- Tap [End] on the touch screen to finish the current exam.
- Click [New Patient] on the Patient Info screen to end the last patient exam and clear the patient information.
- Click [New Exam] on the Patient Info screen (or iStation screen, or Review screen) to end the last exam and clear the exam data.

6

Image Acquisition

WARNING

- The images displayed in this system are only reference for diagnosis. Mindray is not responsible for the correctness of diagnostic results.
 - In Dual-B imaging mode, the measurement results of the merged image may be inaccurate. Therefore, the results are provided for reference only, not for confirming a diagnosis.
-

TIP:

Operations for switching between different image modes and optimizing images, see “2.13 Basic Operations”.

6.1 B Mode

B mode is the basic imaging mode that displays real-time views of anatomical tissues and organs.

6.1.1 B-mode Image Scanning

Press on the control panel to enter B mode.

If the system is in other imaging mode, press to return B mode.

Adjust parameters to optimize the image.

6.1.2 B-mode Image Parameters

Image Quality

Used for switching B/THI and adjusting the frequency. The real-time value of frequency is displayed in the image parameter area, and if harmonic frequency is used, “F H” is displayed as harmonic frequency value.

The system provides a THI function using harmonics of echoes to optimize the image. Harmonic imaging enhances near field resolution and reduces low-frequency and large amplitude noise, so as to improve small parts imaging.

Please select the frequency according to the detection depth and current tissue features.

Gain

To adjust the gain of the whole receiving information in B mode. The real-time gain value is displayed in the image parameter area.

Depth

This function is used to adjust the display depth of sampling, the real-time value of which is displayed in the image parameter area.

Depth increase will cause a decrease in the frame rate.

TGC

The system compensates the signals from deeper tissue by segments to optimize the image.

There are 8-segment TGC sliders corresponding to the areas in the image.

Adjust the signal gain for the certain image area to get a balanced image.

Quick TGC Adjustment

The system provides “User preset” or “Standard preset” to quickly adjust the TGC sliders.

Touch the desired icon in the “User preset” or “Standard preset” column on the touch screen to adjust TGC sliders.

Tap the  icon on the touch screen to restore TGC to the original status.

TGC User Preset

Users can preset the TGC sliders to the desired position.

Tap the  icon on the touch screen to enter TGC user preset screen. Select the desired slider position in the “Standard preset” or “User Preset” column, make adjustment of the sliders manually if necessary, and then touch [Save as] to select among Save as User1, Save as User2, and Save as User3.

Acoustic Power

Refers to the power of ultrasonic wave transmitted by the probe, the real-time value of which is displayed in the upper left corner of the screen.

TIP:

You should perform exams according to actual situation and follow the ALARA Principle.

Scan range and FOV position

More information can be obtained without moving the probe or changing the sampling position.

TIP:

- The FOV position/range is available only for the convex and phased probes.
 - When the scan range is adjusted to the widest, the FOV position cannot be changed.
-

Steer

To steer the beam the probe transmits.

TIP:

Steer is available only for linear probes.

Line Density

The function determines the quality and information of the image.

The higher the line density is, the higher the resolution becomes.

Dynamic Range

Adjusts contrast resolution of an image, compresses or expands gray display range.

The real-time dynamic range value is displayed on the image parameter area.

The more the dynamic range, the more specified the information, and the lower the contrast with more noise.

Smooth

This feature is used to reject the noise and smooth the image.

iClear

The function is used to enhance the image profile so as to distinguish the image boundary for optimization.

Persistence

Used to superimpose and average adjacent B images, so as to optimize the image and remove noises.

Rotation/Flip

This function provides a better observation for image display.

The “M” mark indicates the orientation of the image; the M mark is located on the top of the imaging area by default.

iBeam

This function is used to superimpose and average images of different steer angles to obtain image optimization.

TIP:

The phased probe does not support iBeam. iBeam is unavailable when ExFov is enabled.

Auto Merge

In the Dual-split mode, when the images of the two windows have the same probe type, depth, invert status, rotation status and magnification factor, the system will merge the two images so as to extend the field of vision.

TIP:

Only for linear probes.

Gray Map

Adjusting grayscale contrast to optimize the image.

Tint Map

This function provides an imaging process based on color difference rather than gray distinction.

TSI

The TSI function is used to optimize the image by selecting acoustic speed according to tissue characteristics.

HD Scope

The image inside the ROI is clearer than these outside when the function is enabled.

The function is disabled in frozen state.

The optimize speed is ended when saving the image in real-time.

iTouch

To optimize image parameters as per the current tissue characteristics for a better image effect. It is available for all real-time imaging in B mode.

H Scale

Display or hide the width scale (horizontal scale).

The scale of the horizontal scale is the same as that of vertical scale (depth), they change together in zoom mode, or when the number of the image window changes. The H Scale will be inverted when image is turned upwards/downwards.

Dual Live

Display different image effects of one probe for a better observation.

Two pages of adjustable parameters are displayed on the touch screen as well; where, shared parameters and left window parameters are displayed in the B (L) page, while right window parameters are displayed in the B(R) page.

In the image parameter area, parameters of the both windows are displayed.

It supports the magnification of the image.

LGC

Adjust the gain along the scan line to improve the lateral resolution of the image.

TIP:

The system provides several preset parameters for imaging.

Echo Boost

The contrast is increased and the noise is decreased with the clear boundary after generating the function.

TIP:

Use phased probe to activate the function in cardiac mode.

6.2 Color Mode

The Color mode is used to detect color flow, and the color is designed to judge the direction and speed of blood flow.

Generally, the color above the color bar indicates the flow towards the probe, while the color below the color bar indicates the flow away from the probe; the brighter the color is, the faster the flow speed becomes; while the darker the color is, the slower the flow speed becomes.

TIP:

In Color Mode, acoustic power is synchronous with that of B Mode. Adjustment of the depth or zoom to the B Mode image will lead to corresponding changes in Color Mode image.

6.2.1 Color Mode Image Scanning

Perform the following procedure:

1. Select a premium image during B mode scan, and adjust to place the area of interest in the center of the image.

2. Press <C> to enter B+Color mode.
3. Use the trackball/trackpad and <Set> to change position and size of the Region of Interest (ROI).
4. Adjust the image parameters during scan to obtain optimized images.

6.2.2 Color Mode Image Parameters

Color Gain

Refers to the overall sensitivity to flow signals. The real-time gain value is displayed in the image parameter area.

Increasing the gain will increase the flow signal presented as well as noise, while the signals may be missing when the gain is adjusted too low.

Image Quality

Refers to the transmitting frequency in Doppler mode of the probe, the real-time value of which is displayed in the image parameter area.

B/C Align

To set and constrain the maximum width of the B mode image to that of the Color ROI.

Dual Live

This function is used to display B image and Color image synchronously.

Steer

The feature is used to adjust the ROI of color flow with different angles with immobility of the probe.

This function is used to adjust the scan angle of linear probes, so as to change the angle between the transmitting beam and flow direction.

TIP:

Steer is available only for linear probes.

Line Density

The function determines the quality and information of the image.

The higher the line density is, the higher the resolution becomes.

Packet Size

This function is an indication of the ability to detect flow, which is used to adjust the accuracy of color flow.

The higher the sensitivity is, the more sensitive indication for low-velocity flow becomes.

Flow State

Refers to optimizing the various flow states.

Persistence

This function is to adjust the temporal smooth to optimize the image.

Smooth

This feature is used to reject the noise and smooth the image.

Scale

This function is used to adjust the speed range of color flow, which is adjusted through PRF in the system. The real-time PRF value is displayed in the image parameter area.

Aliasing may occur if low velocity scale is used and high velocities are encountered.

Low velocities may not be identified when a high velocity scale is used.

Baseline

Refers to the area where the velocity is zero in the scale. Adjust according to the actual situation so as to get an optimum flow display.

Invert

To set the display mode of the color flow, the color scale will be inverted when the function is activated.

TIP:

It is available only for linear probes.

Color Map

This function is a combination of several image parameters, which indicates the display effect of color image.

WF (Wall Filter)

It filters out low-velocity signals to provide effective information, and this function is used to adjust the filtered frequency. The real-time value (WF) is displayed in the image parameter area.

Smart Track

To optimize image parameters as per the current tissue characteristics for a better image effect. The angle and the position of the ROI are adjusted after the function is enabled. The area is tracked without being affected by the dynamic moves.

TIP:

The linear probes for Upper Ext Artery, Upper Ext Vein, Lower Ext Artery, Lower Ext Vein, carotid, EM Vascular exam supports the smart track.

Priority

This function is used to set levels of the flow display, to display the grayscale signal or color signal.

The color image is preferred with higher value; while grayscale signals are displayed with the lower value.

Velocity Tag

This function is used to mark the specified velocity range in flow to check the flow function or specific flow velocity value.

Enable this function, the green mark appears on the color scale. Use trackball/trackpad and <Set> to set the marking range and marking position.

iTouch

To optimize image parameters as per the current tissue characteristics for a better image effect.

6.3 Power Mode

Power mode provides a non-directionally display of blood flow in the form of intensity as opposed to flow velocity.

DirPower (Directional Power Mode) provides the additional information of flow direction towards or away from the probe.

TIP:

In Power mode, the acoustic power is synchronous with that of B mode. Adjustment of the depth to the B mode image will lead to corresponding changes in Power mode image.

6.3.1 Power Mode Image Scanning

Perform the following procedure:

1. Select a premium image during B mode or B+ Color scan, and adjust to place the area of interest in the center of the image.
2. Press <P> to enter B+Power mode.
3. Use the trackball/trackpad and <Set> to change position and size of the Region of Interest (ROI).
4. Adjust the image parameters during scan to obtain optimized images.

6.3.2 Power Mode Image Parameters

Because both are based on Doppler color imaging, the adjustments of Power mode are same with these of Color mode's. Hence, only the adjustments of Power mode are introduced.

Power Gain

Refers to the overall sensitivity to flow signals, and this function is used to adjust the gain in Power mode. The real-time gain value is displayed in the image parameter area.

Color Map

This feature indicates the display effect of power image. The maps in Power mode image are grouped into two categories: Power maps and Directional Power maps.

- The Power maps provide information of blood flow, which are highly sensitive to the low-velocity flows.
- The Directional Power maps provide information of flow direction.

Dynamic Range

This function is to adjust the transformation of echo intensity into color signal.

Increasing dynamic range will lead to higher sensitivity to low-power signals, thus enhances the range of signals to display.

6.4 M Mode

6.4.1 M Mode Image Scanning

Perform the following procedure:

1. Select a premium image during B mode or B+ Color scan, and adjust to place the area of interest in the center of the image.

2. Press <M> on the control panel, and use the trackball/trackpad to adjust the sampling line.
3. Press <M> on the control panel again or <Update> to enter M mode, and then you can observe the tissue motion along with anatomical images of B mode. During the scanning process, you can also adjust the sampling line accordingly when necessary.
4. Adjust the image parameters to obtain optimized images.

6.4.2 M Mode Image Parameters

Gain

To adjust the gain of M mode image, the real-time gain value is displayed in the image parameter area.

Increasing the gain will brighten the image and you can see more received signals. However, noise may also be increased.

Display Format

To set the display format of B mode image and M mode image.

Adjust according to the actual situation and obtain a desired analysis through comparison.

Speed

This function is used to set the scan speed of M mode imaging, and the real-time speed value is displayed in the image parameter area.

Tint Map

This function provides an imaging process based on color difference rather than gray distinction.

Gray Map

Adjusting grayscale contrast to optimize the image.

Edge Enhance

This function is used to increase image profile, so as to distinguish the image boundary.

Larger edge enhance may lead to noise increase.

Dynamic Range

Adjusts contrast resolution of an image, compresses or expands gray display range. The real-time dynamic range value will be displayed on the image parameter area on the top of the screen.

M Soften

This feature is used to process the scan lines of M images to reject noise, making the image details to be clearer.

6.5 Color M Mode (CM)

To know the cardiac motion state, CM is overlaid with flow based on M mode, which is more sensitive to the instantaneous signal changes. Then, it shows the diagnosis information in detail.

TIP:

Linear probe does not support Color M mode.

6.5.1 CM Image Scanning

Perform the following procedure:

1. To enter CM mode:
 - In B+M mode, press <C>.
 - In B+Color, press <M>.
2. Adjust the image parameters to obtain optimized images.

6.5.2 CM Image Parameters

In CM mode, parameters that can be adjusted are in accordance with those in B, M and Color modes; please refer to relevant sections of B, Color and M mode for details.

The ROI size and position determine the size and position of the color flow displayed in the color M mode image.

6.6 Anatomical M Mode

For an image in the traditional M mode, the M-mark line goes along the beams transmitted from the probe. Thus it is difficult to obtain a good plane for difficult-to-image patients who cannot be moved easily. However, in the Anatomical M mode, you can manipulate the M-mark line and move it to any position at desired angles. The system supports anatomical M scanning (including Free Xros M mode and Free Xros CM mode) in 2D imaging modes (B, Color, Power and TVI mode).

CAUTION

Anatomical M Mode and Color Anatomical M mode images are provided for reference only, not for confirming diagnoses. Compare the image with those of other machines, or make diagnoses using non-ultrasound methods.

TIP:

Free Xros M imaging and Free Xros CM imaging are options.

6.6.1 Linear Anatomical M (Free Xros M)

Free Xros M imaging is supported on frozen B image, B+M image and B+Power/Color/TVI image.

Perform the following procedure:

1. Adjust the probe and image to obtain the desired plane in real-time B mode or M mode.
Or select the B mode cine file to be observed.
2. Tap [Free Xros M] on the touch screen to enter Free Xros M mode or press the user-defined key to enter Free Xros M mode.

There are 3 M-mark lines available, each with a symbol of “A”, “B” or “C” at one end as identification.
3. Adjust the sampling line (single line or couple of lines) to obtain optimized images and necessary information.
 - Tap [Show A], [Show B] or [Show C] on the touch screen to adjust the sampling line. The corresponding sampling line and the Free Xros M image appear on the screen. Then, activate the sampling line.

- Tap [Display Cur.] or [Display All] on the touch screen to select whether to display the image of the current M-mark line or all.
You can choose to display the sampling line on the current image or all.
 - Press <Set> to switch among the sampling lines and press <Cursor> to show the cursor.
4. Adjust the image parameters to obtain optimized images.
 5. Press to return to real-time B mode.

6.6.2 Free Xros CM (Curved Anatomical M-Mode)

In Free Xros CM mode, the distance/time curve is generated from the sample line manually depicted anywhere on the image. Free Xros CM is used for TVI and TEI modes.

CAUTION

Curved anatomical M image in the operator's manual that it is provided for reference, not for confirming a diagnosis. Generally it should be compared with other device or make a diagnosis by non-ultrasonic methods.

TIP:

Only phased probe supports Free Xros CM.

Perform the following procedure:

1. In real-time 2D mode, adjust the probe and image to obtain the desired plane.
2. Press <TDI> to obtain the image.
3. Tap [Free Xros CM] on the touch screen to enter the mode.
4. Use the trackball/trackpad to define the start point of the sampling line on the 2D image.
The cursor displays as +, and can be moved within the 2D image only.
5. Press <Set> to fix the start point, and the digital number "1" is marked beside the point.
6. Define the next point using the trackball/trackpad and <Set> key (tap [Undo] on the touch screen to cancel the current point and activate the preview point). The system updates the time-motion curve in real time, and each point is marked with a number in sequence.
7. Repeat Step 6 to finish the sampling line.
8. Double press <Set> to finish the editing.
9. You can edit the curve if needed:
 - a. After finishing the sampling line, tap [Edit] on the touch screen. The cursor becomes the icon □.
 - b. Move the cursor over the curve, press <Set> to activate the spot.
 - c. Move the cursor to change the shape of the curve.
 - d. Double press <Set> to finish the editing.

NOTE:

- Tap [Delete] on the touch screen to remove the curve, and tap [Edit] to re-edit the curve.
10. Adjust the parameters to obtain the desired tissue of Free Xros CM image. Then, save the image.
 11. Tap [Free Xros CM] or press the user-defined key for "Free Xros CM", or press to exit.

6.6.3 Anatomical M Mode Parameters

In anatomical M mode, adjustable parameters are similar with these in M mode.

6.7 PW/CW Mode

PW (Pulsed Wave Doppler) mode or CW (Continuous Wave Doppler) mode is used to provide blood flow velocity and direction utilizing a real-time spectral display. The horizontal axis represents time, while the vertical axis represents Doppler frequency shift.

PW mode provides a function to examine flow at one specific site for its velocity, direction and features; while CW mode proves to be much more sensitive to high velocity flow display. Thus, a combination of both modes will contribute to a much more accurate analysis.

CW module is optional.

6.7.1 PW/CW Mode Image Scanning

Perform the following procedure:

1. Select a premium image during B mode or B+ Color (Power) scan, and adjust to place the area of interest in the center of the image.
2. Press <PW>/<CW> or the user-defined key to adjust the sampling line.

The sampling status will be displayed in the image parameter area.

3. Set the position of the sample line and the SVD by using the trackball/trackpad, and adjust the angle and SV size according to the actual situation.
4. Press <PW>/<CW> or the user-defined key again or <Update> to enter PW/CW mode and perform the examination.

Observe and calculate the data based on B mode or Color mode image. You can also adjust the SV size, angle and depth in the real-time scan.

5. Adjust the image parameters to obtain optimized images.

6.7.2 PW/CW Mode Image Parameters

Gain

This function is intended to adjust the gain of spectrum map. The real-time gain value is displayed in the image parameter area.

PW Sampling Gate

Adjusts the SV position and size of sampling in PW mode, the real-time value of SV and SVD are displayed in the image parameter area, in which SV represents the size of the sampling gate, and SVD represents the sampling depth.

CW Focus Position

To adjust the focus position of CW mode. The real-time focus position value is displayed on the image parameter area in SVD.

Image Quality

Refers to the transmitting frequency in Doppler mode of the probe, the real-time value of which is displayed in the image parameter area.

Scale

This function is used to adjust the speed range of color flow, which is adjusted through PRF in the system. The real-time PRF value is displayed in the image parameter area.

To provide a much clearer color flow image.

Use low PRF to observe low-velocity flows, and use high PRF to observe high-velocity flows.

iTouch

To optimize image parameters as per the current tissue characteristics for a better image effect.

Auto Calculation

This function is used to trace the spectrum and calculate the PW/CW mode image parameters. The results are displayed in the results window.

In real-time scanning, the results displayed are derived from the calculation of the latest cardiac cycle.

In the freeze and cine status, the results displayed are calculated from the current selected area.

- Auto Calculation Parameter: To set the calculation results to display.
- Auto Calculation Cycle: To set the heart cycle number for auto-calculation.
- Trace Area: To set the trace area of the Doppler wave in the spectrum map, applicable for auto calculation, V Max and V Mean display.
- Trace Smooth: To set the smooth level when tracing.
- Trace Sensitivity: This function is used to set the sensitivity of tracing in the spectrum.

Invert

This function is used to set the display manner of spectrum.

TIP:

It is available only for linear probes.

Speed

This function is used to set the scan speed of PW mode imaging.

T/F Res

Adjusts for a balance between time resolution and spatial resolution.

WF (Wall Filter)

To display the image accurately, it adjusts the cut-off used in the wall filter, and filters out the flow noise which is produced by vessel wall vibration. The real-time value is displayed in the image parameter area.

Tint Map

This function provides an imaging process based on color difference rather than gray distinction.

Gray Map

Selects among post processing map curves to optimize grayscale images.

Display Format

Sets the display proportion of PW mode image and B mode image.

Duplex/Triplex

This function is used to set if B image or B+Color image (Power) is scanned synchronously.

HPRF

HPRF mode is used when detected velocities exceed the processing capabilities of the currently selected PW Doppler scale or when the selected anatomical site is too deep for the selective PW Doppler scale.

Baseline

Refers to the area where the velocity is zero in the spectrum. The map changes after being edited.

Angle

This function is used to adjust the angle between Doppler vector and flow to make the velocity more accurate.

The real-time adjusting angle value is displayed in the image parameter area.

Quick Angle

Adjusts the angle faster in increments of 60°, and the real-time value of which is displayed in the image parameter area.

Dynamic Range

The dynamic range conveys the information that being transformed from echo intensity to gray scale.

Audio

Adjusts the output audio in spectrum Doppler.

Steer

Adjusts the scan angle in PW mode, so as to change the angle between the transmitting beam and flow direction.

Obtain more information with immobility of the probe.

Values of steer angles vary with the probe.

TIP:

Steer is available only for linear probes.

6.8 TDI

TDI mode is intended to provide information of low-velocity and high-amplitude tissue motion, specifically for cardiac movement.

There are 4 types of TDI mode available:

- Tissue Velocity Imaging (TVI): This imaging mode is used to detect tissue movement with direction and speed information. Generally the warm color indicates the movement towards the transducer, while the cool color indicates the movement away from the transducer.
- Tissue Energy Imaging (TEI): This imaging mode reflects the status of cardiac movement by providing the energy information, the larger the energy is, the brighter the color becomes.
- Tissue Velocity Doppler Mode (TVD): This imaging mode provides direction and speed information of the tissue.

- Tissue Velocity M Mode (TVM): This function assists to observe the cardiac motion through a direct angle.

TIP:

TDI is optional.

6.8.1 TDI Mode Image Scanning

Perform the following procedure:

1. Press <TDI> or the user-defined key to enter the TDI mode.
 - In B or B+Color mode: to enter TVI Mode, parameters of TVI mode will be displayed on the touch screen.
 - In Power mode: to enter TEI Mode, parameters of TEI mode will be displayed on the touch screen.
 - PW mode: Press <TDI> or the user-defined key and then press <PW> or <Update> to enter TVD. The parameters of TCD are displayed on the touch screen.
 - M mode: Press <TDI> or the user-defined key and then press <M> or <Update> to enter TVM. The parameters of TVM are displayed on the touch screen.
2. Adjust the image parameters to obtain optimized images.
3. Press <TDI> or the user-defined key to exit from TDI mode and enter general imaging modes.
Or, press on the control panel to return to B mode.

6.8.2 TDI Mode Image Parameters

In each TDI mode, the parameters that can be adjusted are similar to those in the color flow modes (Color, PW, and Power). See the relevant sections for details. The following introduces the specific items in TDI mode.

Tissue State

This function is used for fast image optimization.

6.8.3 TDI Quantitative Analysis

 CAUTION

TDI is provided for reference, not for confirming a diagnosis.

NOTE:

To perform the strain and strain curve, the ECG curve is in need in case of the deviation in curve.

TIP:

- TDI quantitative analysis is an option.
 - The current image (in frozen state) and the saved image can be used in the quantitative analysis.
 - Only after the user chooses the image review, the quantitative analysis is available. If the user chooses the static image (only one frame), the quantitative analysis is not available.
-

It is about analyzing the data of TVI imaging and measuring the velocity of the myocardium with the cardiac cycle.

Here are three types of curves to perform the quantitative analysis:

- Velocity-time curve
- Strain-time curve
- Strain rate-time curve
 - Strain: Deformation and displacement of the tissue within the specified time.
 - Strain rate: speed of the deformation, as myocardial variability will result in velocity gradient, strain rate is used commonly to evaluate how fast the tissue is deforming.

Figure 6-1 Quantitative analysis display (taking velocity-time curve as the example)

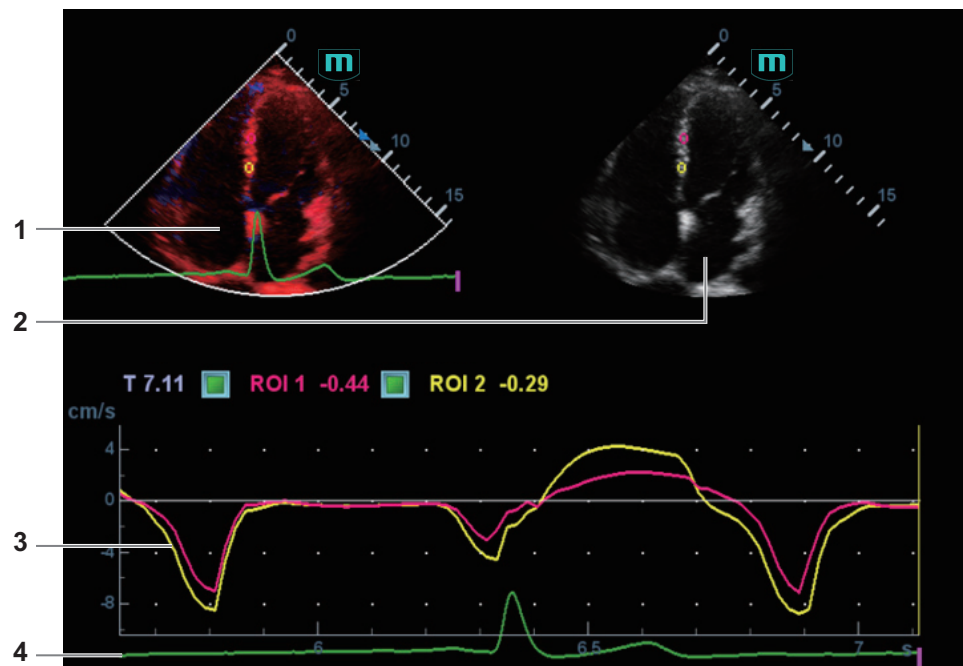

1	TDI review	Sampling area: indicates the sampling position of the curve. The sampling lines are marked with color numbers. It can mark 8 ROIs at most.
2	2D grey image review	<ul style="list-style-type: none"> • Use the trackball/trackpad; the images in TDI review window and 2D review window are reviewed synchronously, since the two images are frozen at the same time. • ROI movement is linked between the TDI (Tissue Doppler Imaging) review window and the 2D imaging reviewing window.

3	Display analysis curve	<ul style="list-style-type: none"> • Y-axis represents the velocity (unit: cm/s) [in strain-time curve, Y-axis represents the strain (%); in strain-time curve, Y-axis represents the strain (unit: 1/s)]. • X-axis represents time (s); • Frame mark: a white straight line perpendicular to the X-axis, and can be moved left and right by using the trackball/trackpad. • Click the check box in front of the ROI to display or hide the analysis curve. • You can get the current X/Y axis value by moving the cursor onto one point on the curve; and if you press <Set> at this time, the frame marker will move to the spot.
4	ECG display area	/

Perform the following procedure:

1. Scan the image with the moves of myocardium on, freeze the image and select the scan scope, or open the image which includes the myocardium moves already.

NOTE:

- The current image (in frozen state) and the saved image can be used in the quantitative analysis.
- Only after the user chooses the image review, the quantitative analysis is available. If the user chooses the static image (only one frame), the quantitative analysis is not available.

2. Tap [TDI QA] or press the user-defined key for “TDI QA” to enable the function.
3. Mark the interested myocardium area.

One image can save 8 ROIs at most, and draw the corresponding curve in image area. Each ROI has different color; the corresponding curve is painted with each color.

ROI settings:

- a. Tap [Standard ROI]/[Ellipse ROI] to select a ROI method.
The cursor moves into the review area (TDI review window or 2D grey review window).
- b. Review to the desired frame.
- c. Move the cursor to one cine review window.
- d. Add a ROI.

When selecting “Standard ROI”: Add ROI automatically after capturing the area. ROI size is decided by “Standard Height/Width/Angle”.

When selecting “Ellipse ROI”: Press <Set> to confirm the start point, and use the trackball/trackpad and press <Set> to confirm the next point; then use the trackball/trackpad to adjust the size and press <Set> to complete the drawing.

You can press <Clear> to remove the last ROI.

4. Select the curve: Tap [Speed], [Strain] or [Strain Rate].

For [Strain] or [Strain Rate], tap [Strain Dist.] on the touch screen to select the corresponding value for Strain – Time curve or Strain Rate – Time curve.

If needed, tap [ROI Tracking] to enable the function. This function provides a motion compensated ROI as precise time-intensity information can be acquired using active tracking. It can enhance the calculation accuracy as reducing the impact of probe or patient respiratory movement.

NOTE:

Elliptical ROIs can be positioned in any manner that keeps their center within the image boundaries. In the case that part of the ROI is outside the image boundary, only data from within the image boundary is used for calculating the mean intensity value.

5. Adjust the curve display:
 - X Scale: Choose different value, so that the X scale display manner will be changed. This function can be used to track detailed tissue information.
 - Smooth: Adjust the smooth feature of the curves.
6. Save the curves, and export the curve data, parameter data.
 - a. Tap [Export] on the touch screen.
The dialog box appears.
 - b. Select the storage path and type the file name.
E drive is default; and the file type is .CSV.
 - c. Click [OK] to complete the export.

After being exported successfully, a BMP. file shows on the thumbnail area.

The exported data include:

- Current image;
 - Analysis curve data;
 - Analysis parameter.
7. Tap [Exit] to exit the quantitative analysis.

6.9 iScape

The iScape panoramic imaging feature extends your field of view by piecing together multiple B images into a single, extended B image. Use this feature, for example, to view a complete hand or thyroid.

When scanning, move the probe linearly and acquire a series of B images. The system pieces these images together into a single, extended B image in real time. The system also supports out-and-back image piecing.

After obtaining the extended image, you can rotate it, move it linearly, magnify it, add comments or body marks, or perform measurements on the extended image.

The system provides a color iScape function, so you can get more information from extended images.

CAUTION

- It is provided for reference, not for confirming a diagnosis.
 - iScape panoramic imaging constructs an extended image from individual image frames. The quality of the resulting image is user-dependent and requires operator skill and additional practice to become fully proficient. Therefore, the measurement results can be inaccurate. Exercise caution when you perform measurements in iScape mode. A smooth and even speed will help produce optimal image results.
-

NOTE:

- Guidance and precautions for even movement:
 - Make sure there is enough coupling gel along the scan path.
 - Always move the probe slowly and steadily.
 - Continuous contact is required throughout the length of the extended image. Do not lift the probe from the skin's surface.
 - Always keep the probe perpendicular to the skin's surface. Do not rock, rotate or tilt the probe during the scan.
 - The system accommodates a reasonable range of motion velocity. Do not make abrupt changes in motion speed.
- Deeper scans generally require reduced acquisition speed.

NOTE:

- iScape is an option.
- Needle mark cannot be displayed in iScape imaging mode.

6.9.1 Basic Procedures for iScape Imaging

Perform the following procedure:

1. Connect an appropriate iScape compatible probe. Make sure there is enough coupling gel along the scan path.
2. Press the user-defined key for “iScape View” or tap [iScape View] on the touch screen (it is available after enter Power/Color mode).
3. Optimize the 2D mode image:

In the capture preparation status, tap [B] ([Power]/[Color]) page tab to go for the B mode image optimization. Do measurement or add comment/bodymark to the image if needed.
4. Tap [iScape View] page tab to enter the iScape acquisition preparation status.
5. Tap [Start Capture] or press <Update> on the control panel to begin the capture.

The system enters into image review status when the acquisition is completed. You can perform operations such as parameter adjusting.
6. Scan slowly to obtain a single extended field of view image. You can also erase and retrace if the image is not satisfactory.
 - During image acquisition, none of the parameters are adjustable, and functions such as measurement, comments and body marks are not available.
 - A green box on the image indicating the boundary between the merged images and the unfinished images.
 - During image slicing, the system gives feedback on the probe’s moving speed in the form of colors and words. The meanings are as follows:

Status	ROI Color	Tip
Speed too low	Blue	Moving speed of the probe is too low.
Appropriate	Green	/
Speed too high	Red	Moving speed of the probe is too high.

7. Do one of following to end image capture:
 - Tap [Stop Capture] on the touch screen.
 - Press <Update>.
 - Wait until the acquisition completes automatically.

After the acquisition is completed, the panoramic image will be displayed and the system enters iScape viewing mode.

6.9.2 Image Review

After the acquisition is completed, the panoramic image will be displayed and the system enters iScape viewing mode.

6.9.3 Evaluate image quality

Many variables may affect the overall image quality. It is important to evaluate the image content and quality before an image is used for diagnosis or measurements.

NOTE:

- iScape panoramic imaging is intended for use by well-trained ultrasound operators or physicians. The operator must recognize image items that will produce a sub-optimal or unreliable image.
 - If the image quality cannot satisfy the following criteria, you shall remove the image and capture it again.
 - The Image must be continuous (no part of an image moves suddenly or disappears.)
 - No shadow or absent signal along the scan plane.
 - Clear profile of anatomy through the entire scan plane without distortion.
 - Skin line is continuous.
 - The images are captured from the same plane.
 - There are no large black areas in the image.
-

6.9.4 Cine Review

Tap [Review Cine] on the touch screen in panoramic image viewing status to enter cine reviewing mode. In cine reviewing mode, a frame marker indicates the sequence of the currently reviewed images in the panoramic image on the left-hand side of screen.

In cine review status:

- Use the trackball/trackpad to review the captured images frame by frame.
- Tap [Auto Play] to start or end auto play.
- In auto play mode, tap [Auto Play] on the touch screen, or press/rotate the corresponding knob to change the play speed. When the speed is off, the system exits auto play mode.
- Review to a certain image. Tap [Set Begin] to set the start point. Review to another image. Tap [Set End] to set the end point. In auto play mode, the review region is confined to the set start point and end point.
- Tap [iScape View] > [Overview] on the touch screen to exit cine review mode. The panoramic image displays.
- In cine review mode, press <Freeze> on the control panel to return to the acquisition preparation status.

6.10 R-VQS

R-VQS (RF-data based quantification on arterial stiffness) tracks movements of the upper and lower vessel walls and measures vessel diameter, displacement, coefficient of hardness and PWV (dimensionless pulse wave velocity).

Hardness coefficient: Arterial stiffness is changed with the blood pressure changing. The bigger the value the higher the stiffness.

PWV (dimensionless pulse wave velocity) represents the transmit speed of pulse wave. The bigger the stiffness parameter the higher the PWV.

NOTE:

- Vascular Package should be configured.
 - R-VQS is an option.
 - Only linear probe under Carotid exam mode supports this feature.
-

Perform the following procedure:

1. Select a probe and carotid exam mode. Perform B real-time imaging and search for carotid vessel. Try to place the vessel on the image horizontally.
2. Tap [R-VQS] and use the trackball/trackpad to locate the ROI box on the target area.
Dotted line of the ROI lies in the middle of the vessel and divides the vessel upper wall and lower wall. Use <Set> key and trackball/trackpad to change ROI size and position.
Note that ROI should include the upper and lower wall of the vessel.
3. Tap [Start Calc] to start tracking. Upper wall and lower wall are marked by the line in the ROI box.

Motion curve of vessel walls display under the image in real time. 6 cardiac cycles are calculated in total with each results display in the result window on the left synchronously.

Where,

$$\text{Dist} = [\text{maximum diameter within 1 s}] - [\text{minimum diameter within 1 s}]$$

Diam: Vessel diameter refers to maximum diameter within 1 s.

6 R-VQS (RF-data based quantification on arterial stiffness) values (6 cardiac cycles are calculated in total), standard deviation SD and ROI length will be displayed in the result window on the left.

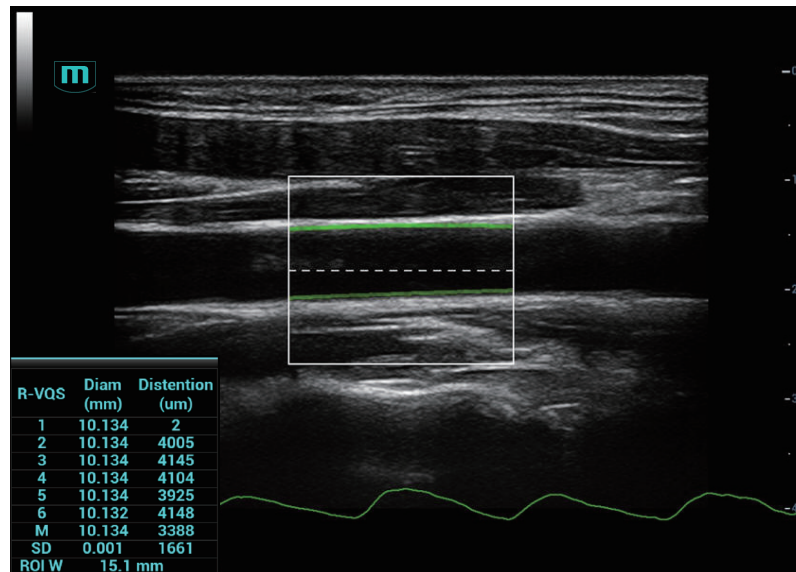

4. Adjust parameters.
 - Speed: Adjust refresh speed of vessel wall motion curve.
 - Position: Adjust the location of the motion curve upwards and downwards.
 - Curve Disp (Min)/Curve Disp (Max): Adjust amplitude of vessel wall motion curve.
5. Tap [Stop Calc] or press <Freeze> to freeze the image and stop updating motion curve and result data.
6. Use the trackball/trackpad to review the cine file and select desired frame.
 - Tap [Accept Result] to update the result window data to the report.
Save the single-frame and multi-frame image if necessary.
 - Tap [Cancel Result] to recalculate and perform step 3-5 if necessary.
7. Tap [Report] to check report.

Only the last result data will be saved.

If pressure is entered in the patient information page or the report page, Hardness coefficient and PWV result will be displayed on the report.

For details about report operation, refer to *Advanced Volume*.

6.11 Smart B-line

The lung acoustic impedance difference increases with the increase of lung liquids. The ultrasound waves produce strong reverberations in the lung at different depth. After multiple reflections, the comet tail sign is formed, which is perpendicular to the pleura plane. Starting from the pleura line, the comet tail sign moves along with the lung and extends to the far field. The reverberation line perpendicular to the pleura plane is called Smart B-line.

Smart B-line is used to detect the B line of the lung in B mode. It supports B-line detecting in both real-time and freeze modes.

TIP:

- Smart B-line is only available in Single B imaging mode.
- It supports single-frame and multi-frame image file detection in B mode.

- Smart B-line is an option.

6.11.1 Basic Procedures for Smart B-line

Perform the following procedure:

1. Select an appropriate probe and exam mode. The system enters the B mode by default.
2. Adjust the image parameters to obtain optimized images.
For details about image parameter adjustment, see “6.1 B Mode”.
3. Tap [Smart B-line] on the touch screen or the user-defined key to enter Smart B-line mode.
Tap [Scanning Areas] to select different zone combinations for examination.
4. Select a desired zone, and tap [Auto Calc].

The system automatically starts tracing the B line sampling area, and automatically recognizes and traces the B line in frame.

If necessary, use the trackball/trackpad and <Set> keys to adjust the B line sampling area.

5. Press the <Freeze> key to freeze the image.

The system automatically calculates the quantitative index, and the calculation results are displayed on the screen.

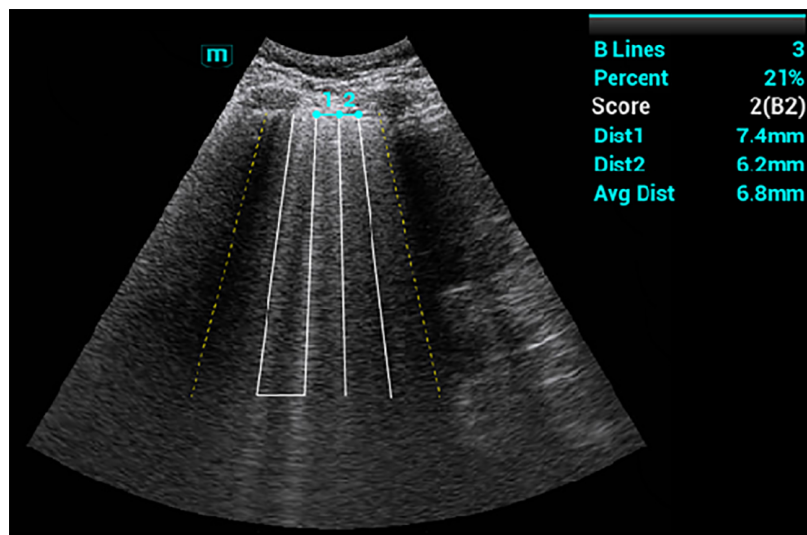

- B Lines: indicates the number of B lines of the current frame. The number can be 1, 2, 3, 4, or ≥ 5 . When the number is equal to or greater than 5, the system does not display a specific number.
- Percent: indicates the percent of the B lines area against the total sampling area.
- Score: the score is among 0 to 3.

Normal: when there are a lung sliding sign and A line, or isolated B lines (<3), it is marked as N in the brackets and the score is 0.

Moderate: when there are multiple clearly-distributed B lines, it is marked as B1 in the brackets and the score is 1.

Severe: when there are intensively fused B lines, it is marked as B2 in the brackets and the score is 2.

Lung consolidation: when the lung has a symptom that is similar to the liver lesion structure and air bronchogram, it is marked as C in the brackets and the score is 3. When

the lung consolidation and pleural effusion occur at the same time, it is marked as C/P in the brackets and the score is 3.

- Dist n (B Line distance): indicates the distance between the 2 neighboring lines and is measured in the pleura line area, among which, n corresponds to the number between the 2 B lines.
- Avg Dist (B Line average distance): indicates the average distance of all B lines.

According to the quantitative index calculated by the system, you can add image and diagnosis information. Tap the check box under the [Image] or [Diagnosis] tab to select items:

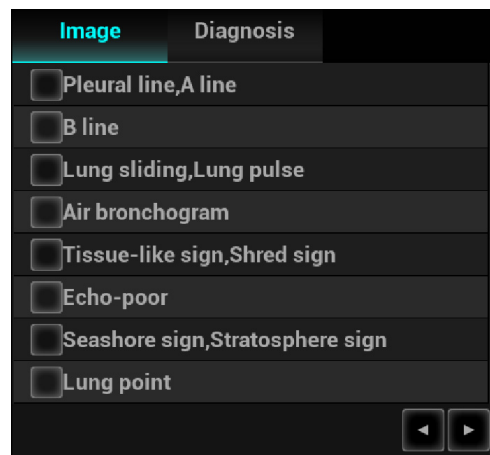

6. Press the <Save> key to save the single-frame image and B line calculation results. If necessary, press the <Freeze> key again to unfreeze the image. Repeat steps 4-6 to finish calculating other points.
7. Tap [Report], and select “Fluid Management” from the drop list box of [Report Type] to check report. For details about report operation, refer to *Advanced Volume*.

6.11.2 Overview

After capturing images, tap [Overview] to enter the Overview screen. The Smart B-line supports displaying two types of lung overviews in the main screen. You can switch the two lung overviews using the corresponding buttons on the touch screen.

- **Image Map:** Displays the ultrasound images of all zones, so as to check the overall lung condition. Every lung zone displays the ultrasound image with the highest percent of the B line area by default. If a zone saves multiple ultrasound images, tap the point corresponds to this zone, and tap [Pre Item] and [Next Item] to switch the image.
- **Color Map:** Displays the color map of the lung and ultrasound image of a zone. The color map uses different colors to mark the ultrasound image analysis result of every lung zone. This analysis result is calculated from the ultrasound image with the highest percent of B line area. Tap a point on the touch screen to check the calculation result of the zone related to this point.

6.12 Smart VTI

Smart VTI (Velocity-Time Integral) is used to calculate the CO (cardiac output) of the LVOT (left ventricular output tract), so as to quickly evaluate the cardiac function.

TIP:

- The cardiac package should be configured in advance.
 - Smart VTI is an option.
 - Smart VTI supports B mode image calculation in real time.
-

Perform the following procedure:

1. Select a phased probe and “Adult Cardiac” exam mode.
2. Move the probe to capture an appropriate image of the long axis view of the left ventricular near the sternum.
3. Press the <Measure> key to enter the application measurement. Select the “LVOT Diam” item and the measurement cursor is displayed on the main screen.
 - a. Move the cursor to the starting point and press <Set> to confirm.
 - b. Move the cursor to the end point.
Press <Clear> to cancel setting the starting point for measurement and <Update> to switch the active end and fixed end of the caliper.
 - c. Press <Set> to set the end point.

For more information about measurement, see *Advanced Volume*.

4. Press the <Freeze> key to unfreeze the image. Move the probe to capture an appropriate image of the apical five chamber view.
5. Tap [Smart VTI] on the touch screen or the user-defined key to enter the Smart VTI mode.

The system will:

- Automatically trace the color VOI, and PW sampling line and sampling volume.
 - Automatically recognize the cardiac cycle: when there are ECG inputs, the ECG signals are preferred; when there are no ECG signals, the system automatically starts calculation.
 - Trace the LVOT spectrum in a cardiac cycle in real time to gain the VTI, HR, and CO results of the LVOT.
6. If necessary, adjust the color VOI, and PW sampling line and sampling volume:
 - Use the trackball/trackpad and <Set> keys to adjust the color VOI position and size, and the PW sampling line position.
 - Tap the PW tab to enter the PW mode, and adjust the PW sampling volume.

After adjustment, the LVOT spectrum tracing and calculation results display in real time.

7. Press the <Freeze> key to freeze the image, and check the Smart VTI calculation results.

If necessary, you can edit the LOVT spectrum manually:

- a. Tap [Edit VTI] on the touch screen.
- b. Press the <Cursor> key to activate the cursor.
- c. Move the cursor to the spectrum tracing line and press the <Set> key.
- d. Use the trackball/trackpad to trace a line.
After tracing, the calculation results display in real time.

8. Tap [Save VTI] to save the Smart VTI calculation results of the current cardiac cycle to the report.

9. Tap [Graph] to check the quantitative index trend curve.

VTI, SV, and CO have different trend curves and are differentiated by colors. A maximum of 6 sets of Smart VTI results can be saved and displayed.

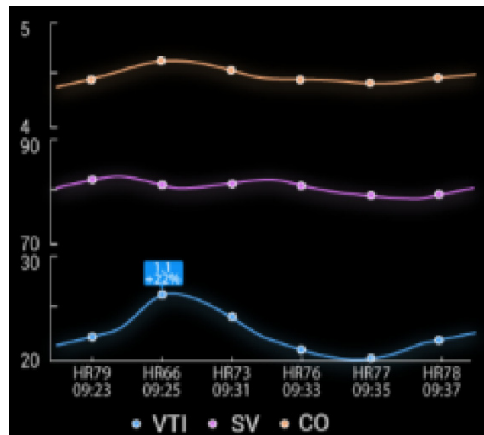

10. Tap [Report], and select “Fluid Management” from the drop list box of [Report Type] to check report.

For details about report operation, refer to *Advanced Volume*.

6.13 Smart IVC

Smart IVC is used to automatically measure the IVC inner diameter and calculate the change rate in the B mode image. Measure the IVC (Inferior Vena Cava) in real time, and the system automatically tracks and measures the changes of IVC inner diameter. It can be used to assist in treatments, such as volume estimation and fluid infusion.

TIP:

- Smart IVC is an option.
- Smart IVC supports calculation in both real time and freeze modes.
 - Enable Smart IVC in real time. The calculation starts from the current frame and ends after the image is frozen.
 - Enable Smart IVC in freeze mode or from the cine file. The calculation starts from the current frame and ends at the last frame. If the cine length is no longer than 10 seconds, it is allowed to calculate in retrospective from the current frame after the cine length reaches 10 seconds.

Perform the following procedure:

1. Select an appropriate probe and exam mode.
2. Move the probe to gain an appropriate IVC long axis image.
3. Tap [Smart IVC] on the touch screen or the user-defined key to enter Smart IVC mode and start calculation.
 - a. Tap to select a breath type: Spontaneous Breath or Mechanical Ventilation.
 - b. Select [Change Resp time] > [Resp Time] to set a respiratory time.

The system measures the IVC inner diameter of the image in every frame, calculates the maximum and minimum IVC diameters, and draws a quantitative index change curve in real time.

4. If necessary, you can adjust the IVC sampling line manually:
 - a. Tap [Edit Line] on the touch screen.

- b. Use [Angle] on the touch screen to adjust the sampling line angle, and use the trackball/trackpad to adjust the sampling line position.
 - c. Press the <Update> key to start calculating IVC again.
5. Press the <Freeze> key to freeze the image and finish calculating IVC.

The calculation results and quantitative trend curve are displayed on the main screen. Tap the diagnostic Information item on the touch screen to add diagnostic information to the image quickly.

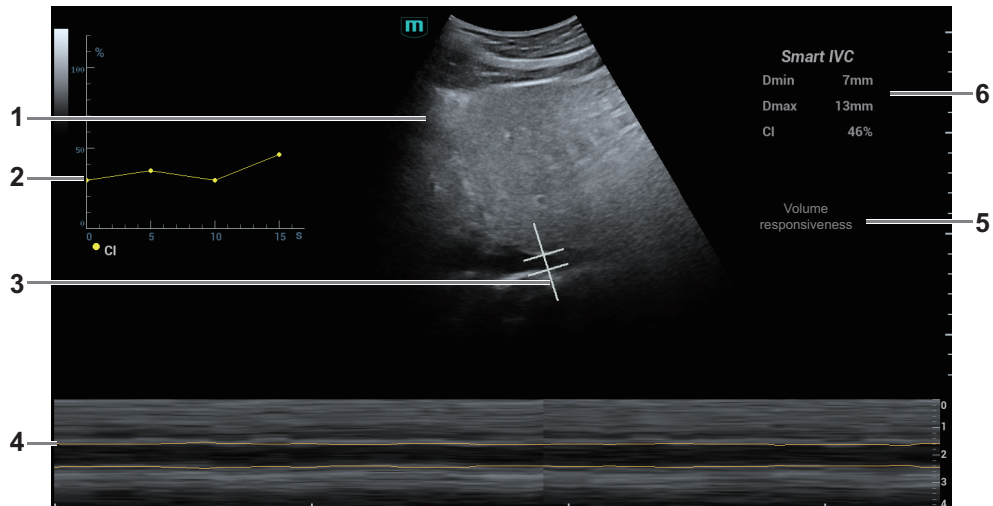

1	B Mode Image	/
2	IVC CI (Collapsibility Index), DI (Distensibility Index), IVCV trend curve	Corresponds to the selected breath type: <ul style="list-style-type: none"> • Spontaneous Breath: displays the IVC CI curve. • Mechanical Vent: displays the IVC DI curve and IVCV curve.
3	IVC Sampling Line	/
4	IVC Trending Line	The horizontal axis represents the time, which is displayed in the below Free Xros M image, and is traced along the IVC vessel wall.
5	Diagnostic Information	Displays the added diagnostic information.
6	Calculation Results Window	Displays the calculation results within the current calculation range. <ul style="list-style-type: none"> • Dmax: indicates the maximum IVC inner diameter within a respiratory cycle. • Dmin: indicates the minimum IVC inner diameter within a respiratory cycle. • $IVC\ CI = (Dmax - Dmin) / Dmax$ • $IVC\ DI = (Dmax - Dmin) / Dmin$ • $IVCV = (Dmax - Dmin) / [(Dmax + Dmin) / 2]$

6. Tap [Save Data] to save the calculating IVC results to the report.
7. Tap [Report], and select “Fluid Management” from the drop list box of [Report Type] to check report.

For details about report operation, refer to *Advanced Volume*.

6.14 RIMT (Real-time Intima-Media Thickness)

RIMT early detects and prevents coronary heart disease, artery vessel from being pathological, and estimates the therapeutic effects. RIMT detects the changes of the vascular intima in real time, and monitors and calculates the thickness of the carotid intima automatically.

TIP:

- RIMT is an option.
 - It is merely available to enter RIMT imaging mode in B single window and dual window when adopting linear probe for carotid exam.
 - Do not press the probe after entering RIMT imaging mode when scanning the image in real time.
-

Perform the following procedure:

1. Select the probe first. Perform B mode in carotid exam mode. Detect the patient's carotid in B mode. Keep the acoustic beam vertical with the anterior and the posterior of the vascular and make the anterior and the posterior of the intima visible at the carotid stenosis to obtain a premium image.
2. Tap [RIMT] to activate the function. Use [Side] on the touch screen to select left or right carotid.
3. Use the trackball/trackpad to locate ROI over the target area. The dotted line of the ROI is in the middle of the blood vessel. Press <Set> to confirm the position and size of the ROI.
4. Tap [Start Calc] to measure RIMT of left carotid and right carotid. 6 RIMT values (each RIMT value represents maximum IMT value within one cardiac cycle), RIMT average value (arithmetic mean value of the 6 RIMT values), SD (standard deviation of the 6 RIMT values) and ROI length are displayed in the result pane.
 - Tap [Accept Result] or press <Set>, the image is frozen. You may save single frame image and results to the result pane.
 - Tap [Cancel Result] to recalculate RIMT. Perform step 4 to reset the RIMT.
5. Tap [Report] to view the report. Only last acceptable data, including RIMT on left and right carotid, is in the data sheet.

You can perform:

- Deleting data: select RIMT data from the data sheet. Tap [Delete Rows] to remove the RIMT data of the left and the right carotid.
- Viewing graphic: tap [IMT Trend] to view the RIMT graphic. The data on the graphic is same with these in data list. The RIMT average value, SD and ROI length of the exams are displayed at the bottom of the graphic (including the current exam).
- Previewing the report: tap [Preview] to show IMT. The RIMT average value, SD and ROI length of the exams are displayed.

For details about report operation, refer to *Advanced Volume*.

6. Tap [RIMT] again to exit.

6.15 Tissue Tracking Quantitative Analysis

CAUTION

Tissue Tracking Quantitative Analysis images are provided for reference only, not for confirming diagnoses.

Apart from TDI imaging function, the system also provides tissue tracking QA function for myocardial movement evaluation.

By tissue tracking QA function, the ultrasound system will scan each pixel position by frame within the cardiac cycle, and then use region matching method and auto-correlation searching method to trace each spot and calculate the movement, so as to determine myocardial motion in a more quantitative way.

Tissue tracking quantitative analysis is an option.

NOTE:

Only use the probes that support stress echo function under the cardiac mode to start Tissue Tracking QA function.

6.15.1 Basic Procedures for Tissue Tracking QA

Perform the following procedure:

1. Open a saved B mode cardiac cine file.
A cin. format file which contains more than 1 cardiac cycle (with 2 R waves) and ECG signal.
2. Tap [Tissue Tracking QA] or press the user-defined key to activate the function:
 - You can determine the image of interest by previewing the image.
 - Use [Cycle] to select and find the image of interest.
3. Select the corresponding section name and locate one frame image with good image effect by cine play. Use the cursor to set the reference point:
 - Long axis section: use the “3-point” method or “Manual” method to set.
 - Short axis section: enter multiple points (at least 6 points) using the cursor manually to set.
4. After reference points are set, the system will display the boundary of the endocardium and epicardium. Adjust the thickness if necessary.
If the traced result is poor, tap [Reload] to re-trace the reference points, or make fine adjustments to the points using the cursor.
If the cycles are not adequate to provide the information, switch to another cycle to trace.
5. Tap [Start Tracking] on the soft menu to start the tracking function. Adjust the parameters if necessary.
Tap [Edit] on the soft menu to display the cursor. Use the trackball/trackpad and press <Set> to re-select the trace reference points (inner dots of the curve). Move the cursor to the exact boundary position and press <Set> again to set the right place. Tap [Start Tracking] to start tracking again.
6. Tap [Accept & Compute] to calculate and display the curve.
Adjust the parameters if necessary.
7. Tap [Bull’s Eye] to see the result.

8. Tap [Data Export] to export analyzed data.
9. Tap [Exit] to exit.

6.15.2 Screen Display of Tissue Tracking QA

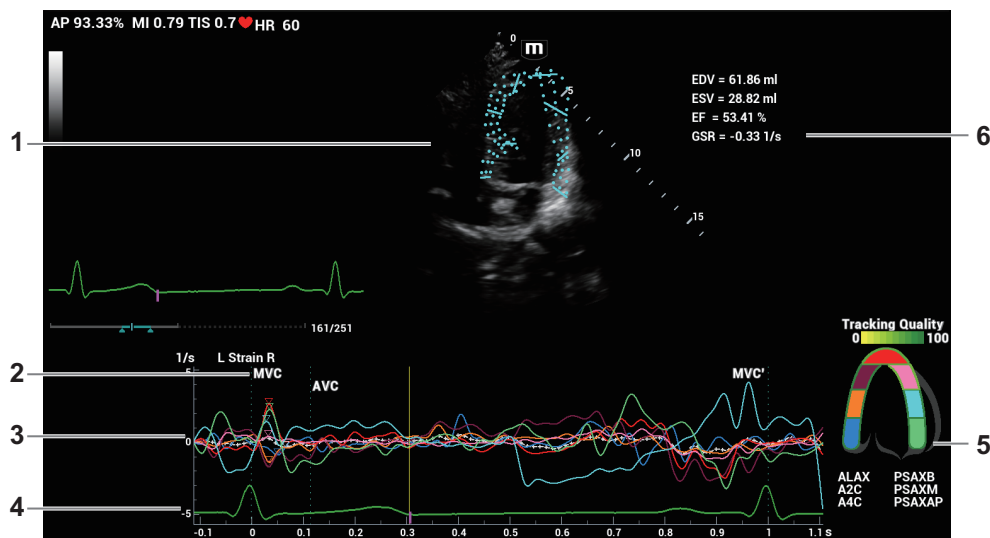

1	Displays image used to generate trace curve	/
2	Displays corresponding time of AVO (aortic valve open)/AVC (aortic valve close)/MVO (mitral valve open)/MVC (mitral valve close).	/
3	Display curve: Velocity/ Displacement/Strain/Strain Rate.	<p>Each curve on the image is matched with a certain segment in the cardiac segmentation model (6), identified by different colors.</p> <ul style="list-style-type: none"> • Velocity curve: X-axis represents time (s); Y-axis represents velocity (cm/s). • Displacement curve: X-axis represents time (s); Y-axis represents displacement (mm). • Strain curve: X-axis represents time (s); Y-axis represents deformation of the tissue (%). • Strain-rate curve: X-axis represents time (s); Y-axis represents strain by time (s^{-1}).
4	Displays ECG trace	/
5	Displays cardiac segmentation model, and each segment name is illustrated beneath the model.	<ul style="list-style-type: none"> • In the figure, ∇ marks the peak position of the curve. • Under tracking status, click on a segment in the cardiac segmentation model. The segment has "X" mark and its corresponding calculating is eliminated. • Tap certain segment in the cardiac segmentation model, the segment will turn grey and its corresponding curve no longer displays. • You can get the current X/Y axis value by moving the cursor onto one point on the curve; and if you press <Set> at this time, the frame marker will move to the spot. <p>The segment boundary color indicates the tracking quality.</p>

6	Displays measurement and calculation results	<ul style="list-style-type: none"> • EDV: Maximum value of the end diastolic volume during the trace. • EDA: Maximum value of the end diastolic area (Left Ventricular) during the trace. • ESV: Maximum value of the end systolic volume (Left Ventricular) during the trace. • ESA: Maximum value of the end systolic area (Left Ventricular) during the trace. • FAC (for short axis section): Fractional Area Change= (EDA — ESA)/EDA • EF (for long axis section): Ejection fraction • HR: Heart rate • Global strain of all segments. • Displays when strain rate curve is acquired. • Global strain rate of all segments. • Displays when strain rate curve rate is acquired. <p>Also on Bull's Eye figure, the system displays TPSD value: Time to Peak Standard Deviation (TPSD): Where, standardized value of time to peak data: $\{TP_i i \in [1, N]\}$. (N is the number of time to peak data) Average value of standardized value of time to peak data: \overline{TP}, and the standard deviation is</p> $TPSD = \sqrt{\frac{\sum_{i=1}^N (TP_i - \overline{TP})^2}{N}}$
---	--	--

6.15.3 Select Image and Cardiac Cycle

You can select images with a better image quality so as to guarantee the analysis result.

Switch the cine file

1. Tap [Review] to enter the review state on touch screen.
2. Double-click the target file.
3. The system closes current displayed file and switch to the newly selected file.

Switch cardiac cycle within the cine file

Tap [Circle] to select when opening a cine which includes multiple cardiac cycles.

6.15.4 Myocardial Boundary Tracing

Tracing

The system provides 2 kinds of tracing method for 2 kind of sections. Long axis section (A4C, A2C, ALAX): 3-point method and manual tracing method are both available. Short axis section (PSAX B, PSAX M, PSAX AP): only manual tracing is available.

- 3-point method

As shown in the following figure, after operation by pressing <Set> to place 3 points on the image, the system generates the trace automatically.

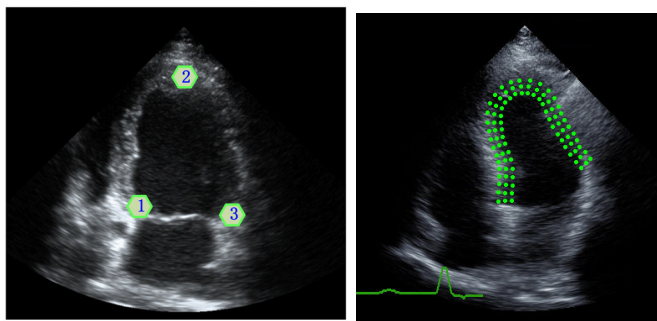

- Manual trace method

Press <Set> and move the cursor by using the trackball/trackpad along the boundary to add the trace points gradually, after trace is finished, press <Set> twice to finish tracing.

NOTE:

At least 6 points should be determined by you before the system generates automated trace. Press <Set> to make the traces on the image clockwise or anticlockwise.

Retracing

If current trace is not satisfactory, tap [Reload] on the touch screen to clear the trace and to start another tracing.

During the tracing drawing, press <Clear> to clear already traced drawing.

Make fine adjustment to the trace

You can make fine adjustments to the trace after it is completed.

Perform the following procedure:

1. Under tracing curve adjusting status, the cursor turns into □.
2. Move the cursor to the editable point, press <Set>.
3. Use the trackball/trackpad to drag the curve to desired position, press <Set> again to set the point to the new position.
4. Repeat step 2~3 above to finish all points that need adjustment.

TIP:

Under tracking status, tap [Edit] on the touch screen to enter the status.

6.15.5 Basic Operations of TTQA

Switch among the operation controls

- [Start Tracking]: tap to start tracking.
- [Accept & Compute]: tap to start calculation and display the curve.
- [Exit]: tap to exit tissue tracking.
- [Parameter]: rotate to select the curve type.
- [Bull's Eye]: touch to turn on/off bull's eye and peak data table.
- [Auto Play]: change the speed of the play.

View Selection

Before tracing, touch the corresponding keys to select for the view.

- [A4C]: apical four chamber.

- [A2C]: apical two chamber.
- [ALAX]: apical long-axis view, also called 3-chamber view.
- [PSAX B]: short axis view of base section, short axis view of mitral valve.
- [PSAX M]: short axis view of base section, short axis view of papillary muscle.
- [PSAX AP]: short axis view of apex.

Parameter Adjustment

- [Thickness]: adjusts the tracing thickness, i.e., the distance between the endocardium wall and the tracking points on the epicardium.
- [Tracking Points]: adjusts the number of points within the segment.
- [Cycle]: select the next cycle.
- [Display Effect]: turns on/off the arrow vector graphical display of the myocardial movement.
- [Velocity Scale]: adjust the scale length of the velocity.
- [Display Style]: display the endometrial, the epicardium, the myocardial or all.
- [Tracking Cycles]: select the cycles to be tracked.
- [Average Cycles]: obtain the average parameter curves of the tissue.
- [Cycle Select]: select among different cycles.

Time Mark

According to the status of the current section, tap the corresponding key on the touch screen to check the matching time.

- [AVO]: displays aortic valve open time.
- [AVC]: displays aortic valve closure time.
- [MVO]: displays mitral valve open time.
- [MVC]: displays mitral valve closure time.

Curve Display

Select [Parameter], the system provides different curves of different segments for observation.

- General
 - Speed curve: The X-axis represents time (s); the Y-axis represents velocity (cm/s).
 - Displacement curve: The X-axis represents time (s); the Y-axis represents displacement (cm).
- Long axis section
 - Volume: The X-axis represents time(s); the Y-axis represents volume (ml).
 - Strain curve (Longitudinal, Transversal): The X-axis represents time (s); the Y-axis represents strain deformation of the tissue (%).
 - Strain-rate curve (Longitudinal, Transversal): The X-axis represents time (s); the Y-axis represents strain by time (s^{-1}).
- Short axis section
 - Area curve: The X-axis represents time(s); the Y-axis represents area (cm²).
 - Strain curve (Radial, Circumferential): The X-axis represents time (s); the Y-axis represents strain deformation of the tissue (%).
 - Strain-rate curve (Radial, Circumferential): The X-axis represents time (s); the Y-axis represents strain by time (s^{-1}).
 - Circumferential Rotation curve: The X-axis represents time (s); the Y-axis represents rotation of the tissue (Deg).

- Circumferential Rotation Rate curve: The X-axis represents time (s); the Y-axis represents rotation by time (Deg/s).

Torsion & Torsion Rate Curve

The system provides left ventricular torsion data based on short axis sections of PSAX AP and PSAX B. Torsion is acquired by calculating difference of apex and base of the heart.

$$\text{Torsion} = \text{PSAX AP Rot.} - \text{PSA XB Rot.}$$

- The X-axis represents time (s).
- The Y-axis represents torsion by time (Deg/s).

6.15.6 Bulleye

After tracking, the system can display Bull's Eye graph, so as to judge reverse movement or scope of myocardium.

1. Tap [Bull's Eye] on the touch screen to turn on the function:

You can acquire:

- Time to peak value and peak value of the 17 segments (similar to 16 segments);
 - Display measurement result EDV/ESV/EF/TPSD.
2. Use [Parameter] on the touch screen to see different parameter bull's eye graph.
 - “-” will display in the table to indicate those segments that are not well tracked.

6.15.7 Measurement/Comment

Under tissue tracking QA mode, only Time measurement is available. For details, please refer to Operator's Manual *Advanced Volume*.

Comments and Body Mark operations are the same as in other modes.

6.15.8 Data Export

The system provides data exporting function, so that you can export calculation result for analysis (for instance, SPSS analysis).

Tap [Data Export] on the touch screen, to export analyzed data of each segment in .csv format.

6.16 Auto GA

NOTE:

Auto GA must be used with convex probe.

After acquired image(s) of gastric antrum, by freezing image and tapping the Auto GA button, the feature shows boundary of gastric antrum and calculates the area of gastric antrum.

Perform the following procedure:

1. Scan and obtain the gastric antrum image and freeze the image.
2. Select [Auto GA], the system will automatically recognize and trace the target boundary to calculate.

The calculation result is displayed on the screen.

3. If the calculation result is not satisfactory, adjust the trace to recalculate.

- a. Select the traced contour to activate the cursor.
 - b. Anchor the desired point on the traced contour.
 - c. Select and move the cursor to the desired position by trackball/trackpad.
 - d. Repeat steps *b* to *c* above to adjust more points if needed.
The calculation results display in real time.
4. Tap [Accept Results] to accept the result.
After accepting the result, if the accepted result is not satisfactory, tap [Remeasure] and repeat step 3 above to update the result.
 5. Select [Trend Curve] to check the trend curve of all the accepted results.

6.17 Auto DFR

The Auto DFR is used to estimate the diastolic function of left ventricular. E/A and E/ E' are the indexes of diastolic function and can be automatically measured.

Perform the following procedure:

1. Select a phased probe (except TEE probes) and cardiac exam.
2. Acquire an Apical four-chamber image.
3. Select [Auto DFR].
If necessary, adjust the PW Doppler sample volume.
4. Select the desired calculation item (MV E/A, MV E/E' Septal, MV E/E' Lateral) to acquire the results by auto calculation.
5. Press the Freeze button to freeze the image.
6. Select an appropriate heart cycle by using the trackball, and select [Accept Result] to accept the calculation result.
If necessary, adjust the position of E or A peak point to fine tune the calculation result, and then select [Accept Result].
7. Measurement results include Peak E-wave velocity, Peak A-wave velocity, MV E/A ratio, Pulsed-wave TDI E' velocity and Mitral E/E' ratio.

6.18 Smart FHR OB1

This feature is to manually select ROI (region of interest) of fetal heart in B mode, and then automatically calculate period of fetal heart motion and FHR (fetal heart rate).

NOTE:

- Different imaging presets or setups may affect the frame rate. Improve the frame rate by adjusting the image parameters to ensure the frame rate is at least 20 frame per second.
 - Place the ROI on the target area after the fetal heart position remains stable, and keep the fetal heart located in the ROI box. When fetal heart remains inside the ROI placed by the operator, its position is considered to be stable.
-

Perform the following procedure:

1. Perform B-mode scanning under OB1, EM OB, ABD or EM ABD exam mode.
2. Adjust the image parameters to obtain a good image.
3. Perform the following operation to enter Smart FHR OB1.

- In real-time or frozen mode, select [Smart FHR OB1].
 - Open a saved cine file. Select [Smart FHR OB1].
4. Select the fetal heart area to position the ROI. The fetal heart rate measurement result will be displayed on the screen automatically.

If necessary, perform the following operation to update the measurement result.

Adjust the Region of Interest (ROI) if necessary:

- Select the corner (green dot) of the ROI and drag to change the size.
- Select inside the ROI box and drag to change the position.

In frozen mode, you can also use the start/end mark on the cine menu to reselect the time period.

The measurement result is updated simultaneously.

5. Tap [Accept Result] to save the calculation result to the report.

6.19 AutoEF

Measure the systole and diastole planes automatically.

TIP:

- Only cardiac exam mode supports this function.
- Recommend to connect ECG, capture the cine of standard A2C and A4C planes, and select cardiac cycles which have the clear plane of the cardiac muscle and less interference to perform AutoEF measure.

Measure items:

Item	Description
LVLd (A2C)	Left ventricular long-axis length at end diastole (A2C)
LVAd (A2C)	Left ventricular long-axis area at end diastole (A2C)
LVLs (A2C)	Left ventricular long-axis length at end systole (A2C)
LVAs (A2C)	Left ventricular long-axis area at end systole (A2C)
LVLd (A4C)	Left ventricular long-axis length at end diastole (A4C)
LVAd (A4C)	Left ventricular long-axis area at end diastole (A4C)
LVLs (A4C)	Left ventricular long-axis length at end systole (A4C)
LVAs (A4C)	Left ventricular long-axis area at end systole (A4C)

Measurement Result:

Item	Description
EDV (A2C/A4C/BP)	End-diastolic Left Ventricular Volume
EDV Index (A2C/A4C/BP)	End-diastolic Left Ventricular Volume Index
ESV (A2C/A4C/BP)	End-systolic Left Ventricular Volume
ESV Index A2C/A4C/BP)	End-systolic Left Ventricular Volume Index
SV (A2C/A4C/BP)	Stroke Volume

Item	Description
SI (A2C/A4C/BP)	SV Index
EF (A2C/A4C/BP)	Ejection Fraction
CO (A2C/A4C/BP)	Cardiac Output
CI (A2C/A4C/BP)	Cardiac output index

Perform the following procedure:

1. Select the [AutoEF] in the measurement menu.
2. In apical two-chamber view, measure the following parameters:
 - Left ventricular endocardium at end-diastolic, the EDV (A2C), SV (A2C), EF (A2C) is obtained automatically.
 - Left ventricular endocardium at end-systolic, the ESV (A2C), SV (A2C), EF (A2C) is obtained automatically.
3. In apical four-chamber view, measure the following parameters:
 - Left ventricular endocardium at end-diastolic, the EDV (A4C), SV (A4C), EF (A4C) is obtained automatically.
 - Left ventricular endocardium at end-systolic, the ESV (A4C), SV (A4C), EF (A4C) is obtained automatically.

If the height and weight have already been entered, the SI, EDV Index and ESV Index are calculated.

4. Select the HR source: ECG or entered.
 ECG obtains the HR automatically. If ECG is not connected, it should start HR on the menu.
 The CO and CI are calculated automatically using the entered height and weight values.

6.20 Smart Bladder

NOTE:

- Smart Bladder must be used with convex-wide probe.
- Smart Bladder is available in Single/Dual B imaging mode.

Function: measure the volume of the urine in the bladder.

1. Select an appropriate probe and exam mode.
2. Scan and obtain the image of the bladder.
3. Press <Freeze> to freeze the image and tap [Smart Bladder] in the measurement menu.
 [XS] is selected by default and two diameters d1 and d2 (perpendicular to each other by default) of the transverse section are recognized by the system.

NOTE:

[Sag] can be selected manually if scan and obtain the longitudinal section image of the bladder.

4. If the current result is satisfactory, tap [Accept Result] or press <Set> to save the result.
 Or, if the result is not satisfactory:
 - a. Tap [Auto Detect] to update the result.

- b. Tap [Accept Result] to save the result.
5. Press <Freeze> to unfreeze the image.
6. Tap [Smart Bladder]. Scan and obtain the longitudinal section image of the bladder.
The diameter d3 is recognized by the system automatically.
7. If the current result is satisfactory, tap [Accept Result] or press <Set> to save the result.
Or, if the result is not satisfactory:
 - a. Tap [Auto Detect] to update the result.
 - b. Tap [Accept Result] to save the result.
8. The measurement results will be displayed in the results window.

6.21 iWorks (Auto Workflow Protocol)

The main objective of ultrasound workflow automation (iWorks) is to speed up exam times and reduce the excessive number of user interface manual key strokes that can lead to repetitive strain injuries over time. It automates a clinical workflow in common exam protocols in a logical “step by step” manner. It also prevents missing important parts of examinations as well as decreasing exam times.

A Protocol Event contains series workflow events (annotation comments, body marks and measurements) and image modal commands to assist the user in routine ultrasound examinations.

TIP:

- The system provides different protocol events based on the different application regions.
 - iWorks is an option.
-

Perform the following procedure:

1. Input the patient information.
2. Tap [iWorks] on the touch screen or press the user-defined key for “iWorks” to enter the protocol selection screen, and tap the corresponding protocol button to enter the status.

After the system enters the iWorks screen, the available protocol is displayed on the right of the screen.
3. Perform the scanning and saving according to the screen prompt.
4. Perform measurements or add comments/body marks to the image according to the screen prompt.
5. After a view scanning is complete, press the user-defined save key to switch to the next view according to the screen prompt.
6. Repeat steps 3 to 5 to acquire all the necessary images.
 - If a pathology is discovered, tap [Insert] to select a protocol outside of the normal routine to start scanning.
 - Tap [Repeat] to add a copy of the selected view to work on if necessary.
 - Tap [Next] or [Previous] to skip to a particular view you are interested in.
 - Tap [Replace] to delete images and operations for the selected view and restart operations on that view.
 - Tap [Delete] to delete the currently activated view.
 - Tap [Suspend] to start a manual scan when an unusual or atypical workflow is required, and tap [Resume iWorks] to restart the iWorks procedure.

- After all views are finished, the system will prompt you to exit iWorks. Tap [Yes] to exit.

6.21.1 Screen Display

Monitor Display

The monitor displays the following screen:

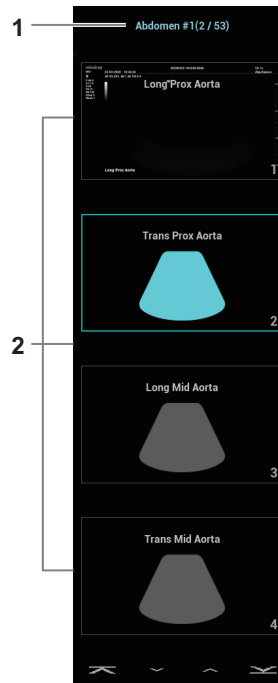

1	Displays the protocol name, and the number of views contained.
2	Displays the view steps in the protocol. The current active view with a solid frame around the image.

Touchscreen Display

The touchscreen displays the following screen:

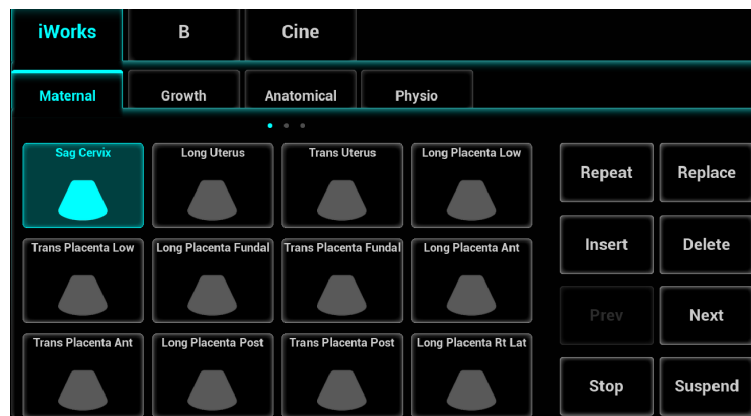

6.21.2 View Operation

In iWorks status, you can perform view selection, repeat, replacement and delete operations using the touch screen.

For some views, the system switches to the relevant imaging modes if necessary.

The comment for the current view has been automatically added to the bottom-left corner of the image, ready for you to scan the specified anatomy.

View Selection

Tap [Prev]/[Next] to select the view to be scanned. The current view is surrounded by a solid frame.

View Operation

In the current active view, you can perform image scanning, measurements, and adding comments and body marks, etc. Operations are the same as those for manual operation. See the relevant chapters for details.

Repeat View

If necessary, tap [Repeat] to insert another template of the current view. You can then perform an extra examination.

View Replacement

The previous image will be deleted and replaced by the new image.

Delete View

Tap [Prev]/[Next] to select the view to be deleted. Tap [Delete] to delete the selected view.

6.21.3 Manual Examination

Suspend - Exit the protocol so the user can run the system manually. This is used when an unusual or atypical workflow is required.

You can run the system manually if necessary.

- Start manual examination: tap [Suspend] to pause the current iWorks protocol. The system enters manual examination status.
- Return to iWorks: tap [Resume iWorks] to return to automated status. You can continue the previous iWorks scan.

6.21.4 Insert

Insert is a specialized protocol event within iWorks and iWorks OB. It assists with the workflow for documenting and measuring common pathological (disease) states (i.e. Mass, Cyst, Stenosis, Thrombus) that occurs outside a routine, normal examination.

Tap [Insert] on the touch screen to enter the status.

Select the necessary protocol and the system adds the protocol events to the current protocol.

Perform measurements or add comments/body marks to the image if necessary.

6.22 Quickly Saving Image Settings

TIP:

It is unavailable for frozen dual-probe mode.

Perform the following procedure:

1. Adjust parameters to optimize the image.
2. Select [Probe] > [QSave] or press the user-defined key for “QSave” to enter the QSave dialog box.

3. Click [Show Parameter] to view the image parameter of the current exam mode and the probe.
4. Click [Advanced] to set the following items if needed:
 - Set the value to TIC/TIB/TIS.
 - Enable the M-mark line.

The M-mark line always appears after being set when entering PW/M/TVM mode for once. Press <PW>/<M> to enter the corresponding mode one time.

This function is unavailable for frozen dual-probe mode.
5. To save image parameters:
 - Click [Save] to save the current image values for the current exam mode of the certain probe.
 - Click [Create] to save the current image parameters, measurements, comments, body mark settings to the exam mode. The system will ask for a new name of the exam.
 - Click [Restore] to restore the probe and exam mode to factory settings.

7 Smart 3D

The operator moves the probe to change its position/angle when performing the scanning. After the scanning, the system carries out image reconstruction, and then displays a single frame of 3D image.

NOTE:

Smart 3D imaging is largely environment-dependent, so the images obtained are provided for reference only, not for confirming a diagnosis.

TIP:

Smart 3D is an option.

7.1 Overview

The ordinary 2D imaging has the limitations on viewing the overall structure and different planes of the target. However, 3D imaging can obtain the reference information by overall observation.

7.1.1 Terms

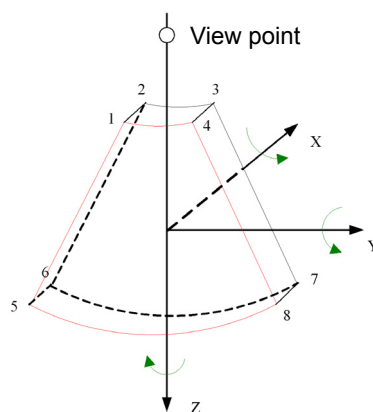

- Volume data: to obtain the data collection of three-dimensional object via the sequence reconstruction to two-dimensional object.
- 3D image Volume Rendering (VR): the 3D image on the screen.
- View point: the position for viewing volume data/3D image.
- MultiPlaner Rendering (MPR): a tangent plane of the 3D image that obtained by algorithm. Of which, XY-paralleled plane is C-plane, XZ-paralleled plane is B-plane, and YZ-paralleled plane is A-plane. YZ-paralleled plane is B-section. The probe is moved along the X-axis.
- ROI (Region of Interest): a volume box used to determine the height and width of scanning volume.

- VOI (Volume of Interest): a volume box used to display 3D image (VR) by adjusting interesting region in MPR.

7.1.2 ROI and VOI

After the system enters 3D imaging, a B image with ROI displays on the screen. A line (shown in the following figure) that shows the upper edge position of VOI is inside ROI.

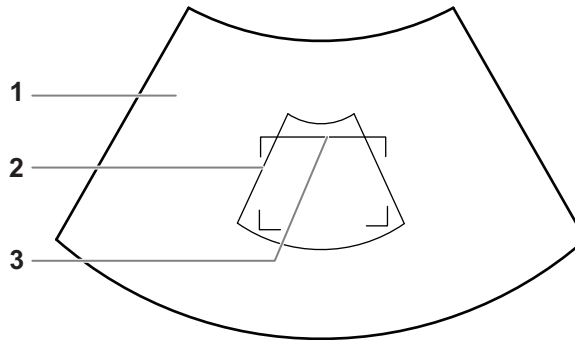

1	2D image
2	ROI
3	Cut plane

Define the ROI and curved VOI:

NOTE:

- To define a ROI, please remove the useless data as to reduce the volume data and shorten the time for image storing, processing and reconstruction.
- Set ROI on the 2D image with the largest section area of the fetal face.
- Set ROI a little larger than the fetal head.

Perform the following procedure:

1. Press the right <Set> key to toggle among setting the ROI position, size or curved VOI.
2. Use the trackball/trackpad to change the ROI size, position and curved VOI,
3. Press the left <set> key to adjust VOI angle.

Depending on the view direction, the orientation and the shape (line or dot) of curved VOI vary:

View	Curved VOI
U/D	At the upper part of curved VOI
D/U	At the lower part of curved VOI
L/R	At the left part of curved VOI
R/L	At the right part of curved VOI
F/B	Displays as a dot
B/F	Displays as a dot

7.1.3 Render Mode

Surface

Set 3D image rendering mode as Surface.

This is helpful for surface imaging, such as fetus face/hand or foot.

TIP:

You may have to adjust the threshold to obtain a clear body boundary.

Max

Set Max as 3D image rendering mode, displays the maximum echo intensity in the observation direction.

This is helpful for viewing bony structures.

Min

Set Min as 3D image rendering mode. Display the minimum echo intensity in the observation direction.

This is helpful for viewing vessels and hollow structures.

X Ray

Set X-ray as 3D image rendering mode. Display the average value of all gray values in the ROI.

This is used for imaging tissues with different structure inside or tissues with tumor.

7.1.4 MPR

MPR represents three different views of 3D image.

In the quad display format view, the screen displays 3 MPRs (A, B and C) and the 3D image.

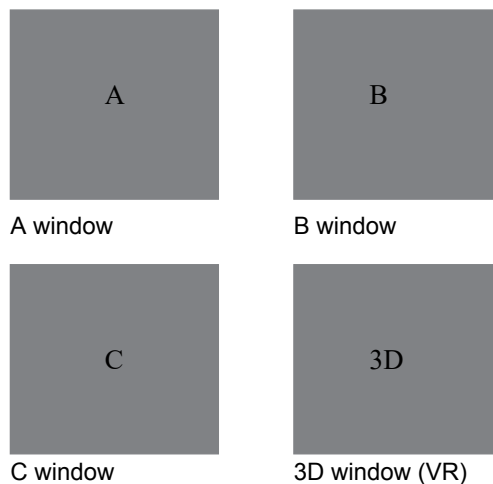

A, B, C sectional images are corresponding to the following sections of 3D image.

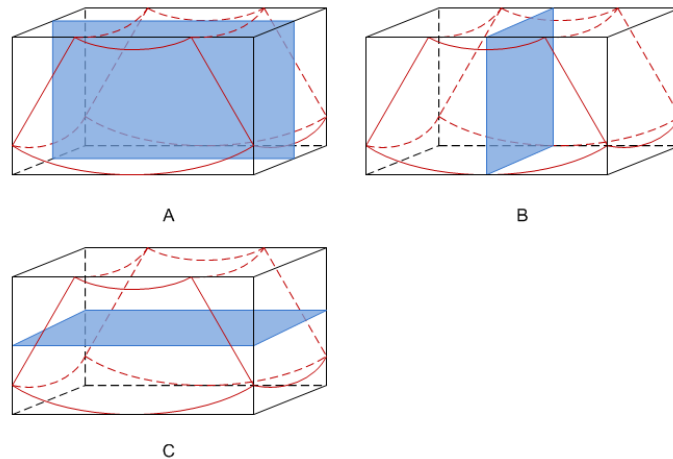

- Section A: corresponds to the 2D image in B mode. Section A is the sagittal section in fetal face up posture, as shown in the figure A above.
- Section B: it is the horizontal section in fetal face up posture, as shown in the figure B above.
- Section C: it is the coronal section in fetal face up posture, as shown in the figure C above.

The upper part of the 3D image in the 3D window is corresponding to the orientation mark on the probe, if the fetal posture is head down (orientating the mother's feet), and the orientation mark is orientating the mother's head, then the fetus posture is head down in the 3D image, you can make the fetus head up by rotating the 3D image by tapping [180°] on the touch screen.

⚠ CAUTION

The ultrasound images are provided for reference only, not for confirming a diagnosis. Please use caution to avoid misdiagnosis.

7.1.5 Wire cage

When you view a 3D image on the display monitor, it's sometimes difficult to recognize the orientation. The system displays a three-dimensional drawing to illustrate the orientation for help. Of which, the blue plane presents the image acquisition where started, while the red plane presents the image acquisition where ended. Besides, a yellow plane in the wire cage presents the position of the MPR.

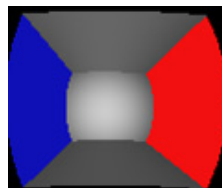

7.2 Note before Use

The quality of images reconstructed in the freehand 3D mode is closely related to the fetal condition, angle of a B tangent plane and scanning technique. The following Smart 3D description uses the fetal face imaging as an example, the other parts imaging are same as 3D imaging.

NOTE:

- In accordance with the ALARA (As Low As Reasonably Achievable) principle, please try to short the sweeping time after a good 3D imaging is obtained.

- A region with qualified image in B mode may not be optimal for 3D imaging. E.g. adequate AF isolation for one section plane of 2D image doesn't mean the whole desired region is isolated by AF for 3D imaging.
- More practices are needed for a high success of qualified 3D imaging.
- Even with good imaging condition, to acquire an approving 3D image may need more than one scanning.

Fetal Condition

- Gestational age
Fetuses of 24~30 weeks old are the most appropriate to 3D imaging.
- Fetal body posture
Recommended: Cephalic face up (figure a) or face aside (figure b); NOT recommended: Cephalic face down (figure c).

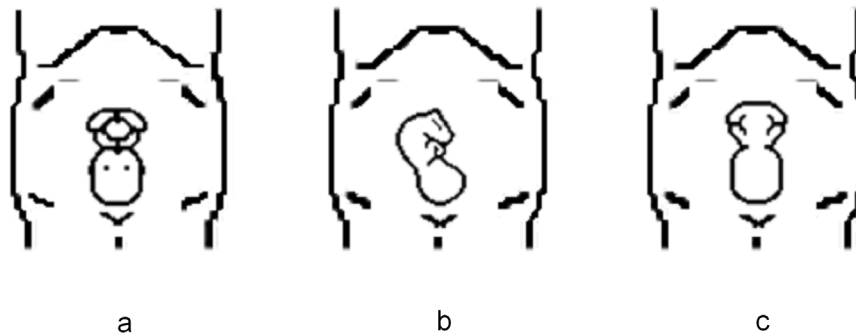

- Amniotic fluid (AF) isolation
 - The region desired is isolated by amniotic fluid adequately.
 - The region for imaging is not covered by limbs or umbilical cord.
- The fetus keeps still. If there is a fetal movement, you need a rescan when the fetus is still.

Angle of a B tangent plane

The optimum tangent plane to the fetal face 3D imaging is the sagittal section of the face. To ensure high image quality, you'd better scan maximum face area and keep edge continuity.

Image quality in B mode (2D image quality)

Before entering 3D capture, optimize the B mode image to ensure:

- High contrast between the desired region and the amniotic fluid surrounded.
- Clear boundary of the desired region.
- Low noise of the amniotic fluid area.

Scanning technique (only for Smart 3D)

- Stability: body, arm and wrist must move smoothly, otherwise, the restructured 3D image distorts.
- Slowness: Move or rotate the transducer slowly. The speed of linear scan is about 2 cm/s and the rotation rate of the fan scan is about 10°/s ~ 15°/s.
- Evenness: move or rotate the transducer at a steady speed or rate.
- Method
Capture images using Linear scan or Rocked scan.

- Linear scanning

Move the probe across the surface. See the following figure.

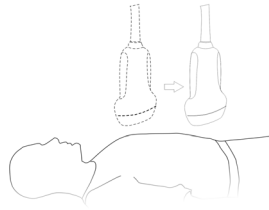

- Rocked scanning

Rotate the probe once from the left to the right side (or from the right to the left) to include the entire desired region. See the following figure.



Scanning plane and probe movement

Move the probe across the body surface.

The arrow in the figure below indicates the movement of the probe.

You can move the probe in the opposite direction to the arrow.

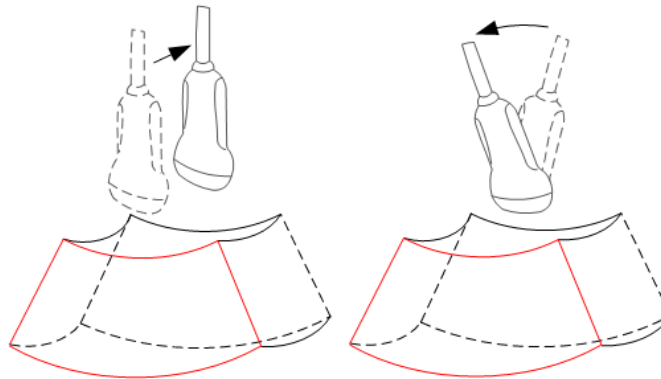

7.2.1 Smart 3D Image Acquisition

NOTE:

In Smart 3D image scanning, if the probe orientation mark is oriented to the operator's finger, perform the scan from right to left in linear scan, or rotate the probe from left to right in rocked scanning. Otherwise, the VR direction will be wrong.

Perform the following procedure:

1. Select the proper probe and exam mode; make sure there is sufficient gel on the probe for scanning.

2. Obtain a 2D image, and optimize the image if necessary.
3. Press the user-defined key for “Smart 3D” to enter Smart 3D imaging mode.
 - Adjust ROI size and position and the position of VOI.
 - Select the render mode.
 - Set the scan method and the movement of the probe.
4. Press <Update> to start 3D imaging.

The system enters into 3D image review status when the acquisition is completed; or, you can finish the acquisition ahead by pressing <Freeze> or <Update>.

5. Exit Smart 3D
 - Press <Update> or <Freeze> to return to Smart 3D acquisition preparation status.
 - Or press or the user-defined key for “Smart 3D” to exit the mode.

7.2.2 Smart 3D Image Viewing

Activate MPR

Select [Ref. Image] > [A], [B], [C] or [VR] to activate sectional plane image (MPR) or 3D image (VR).

MPR Viewing

In actual display, different colors of the window box and the section line are used to identify the section A, B and C.

- The color of window A is blue, and the color of the lines (representing section A) displayed in the other two windows is blue as well.
- The color of window B is yellow, and the color of the lines (representing section B) displayed in the other two windows is yellow as well.
- The color of window C is orange, and the color of the lines (representing section C) displayed in the other two windows is orange as well.

Positions of the other two sectional planes are indicated in the selected plane. You can roll the track ball to change the position.

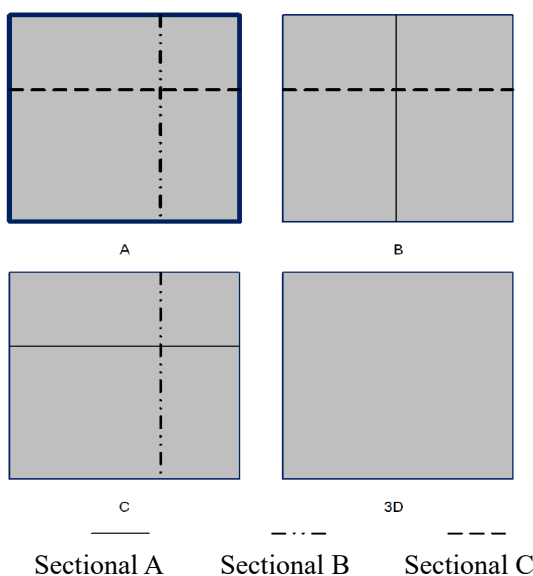

MPR Only

Select [Display Format] > [MPR Only] on the touch screen to display section images. And the adjustable image parameters are changed into MPR parameters automatically.

Only A, B and C section images are displayed, and 3D image is not displayed.

Asymmetric

Select [Display Format] > [A4:1] on the touch screen to display section images and 3D image.

View Direction

The Region of Interest (ROI) contains the section of the volume you want to render. You can adjust the view direction of the ROI.

The system supports the observation of 3D image from 6 directions.

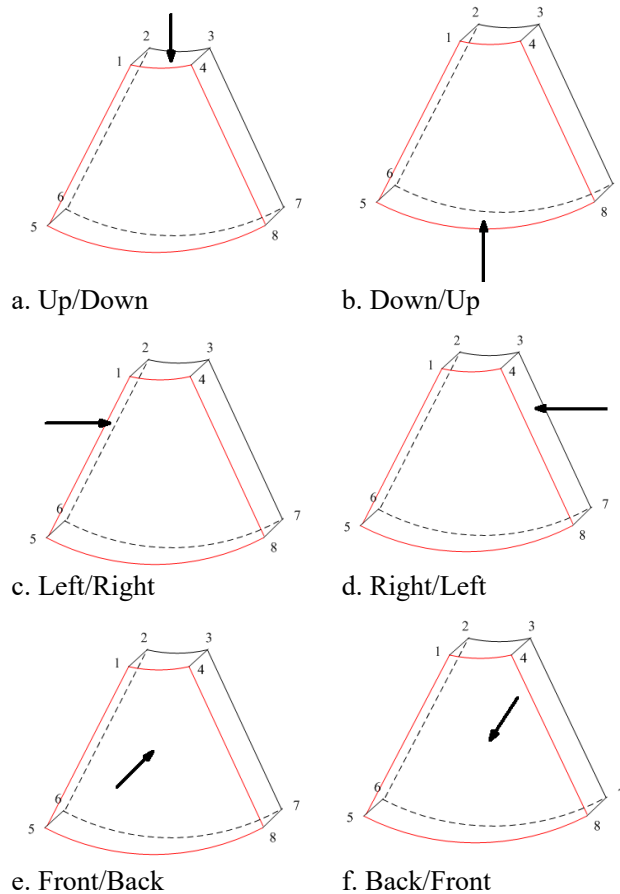

Tap [Up/Down], [Left/Right] or [Front/Back] to select the direction of the figure a, c and e.

Tap [Flip] on the first page to observe by the converse direction of the current direction, which is equivalent of the 180° rotation of current VOI, as shown in the figure b, d, e and f.

Adjust VOI

Adjusting the VOI box size and position is to select the volume data needed to restructure the 3D image and improve the reconstruction effect.

- VOI On
 - 3D image (VR) image displays VOI information.
 - a. In image viewing status, tap [VOI] to be "On".
 - b. Select a desired section plane by tapping [Ref. Image] > [A], [B] or [C] or [VR].

- c. Use the trackball/trackpad to adjust VOI position, size and curved VOI, and press <Set> to toggle among the adjusting status.
- VOI Off
3D image (VR) image displays ROI information.
Tap [VOI] to be Off, then the ROI image is displayed on the screen, use the trackball/trackpad to observe section images.

Accept VOI

This function is usually used for section image observation and to determine the relative position of the section image to the VR.

1. Tap [Accept VOI].
2. Select a desired MPR image by tapping [Ref. Image] > [A], [B] or [C].
3. Use the trackball/trackpad to view the current active section image, and the other section images change correspondingly

In Accept VOI status, when the 3D image is active or the section image which is perpendicular to the view direction is active, center point of the 3D image displays, and you can adjust the position by using the trackball/trackpad.

The adjustment of Rendering Parameters

In image viewing status, you can render the image by adjusting the relevant parameters.

Tap [VR] or [MPR] on the touch screen to select the VR parameters or MPR parameters.

- When [VR] button is highlighted, adjust parameters of 3D image (VR).
- When [MPR] button is highlighted, adjust parameters of sectional image.

You can adjust:

Item	Description
Threshold	Set the threshold for 3D image rendering. 3D image is rendered on the signal above thresholds by eliminating noise via the Threshold parameter. Lower threshold can eliminate lower range noises and echo, which will contribute to a clearer and smoother image. Available only in Surface rendering mode.
Opacity	Adjust the transparency value for 3D image rendering. It implies the transparency of the light. The higher the value is, the tougher the surface becomes. The lower the number is, the more transparent the gray scale information will be. Available only in Surface rendering mode.
Smooth	Set the smoothness of 3D image. NOTE: Insufficient smoothness can result in a fuzzy image; however, too much smoothness will lead to image distortion.
Brightness	Set the brightness of image. NOTE: The adjustment is for 3D (VR) and MPR.

Item	Description
Contrast	Set the contrast scale of the image. As long as the contrast becomes larger, the bright spot and dark spot on the image change as well. NOTE: The adjustment is for 3D (VR) and MPR.
Tint	Enable/disable tint map. The color of image change according the tint value.
Quick Rotation	Rotate the 3D image quickly.
iClear	Use the 3D self-adapation filter to strengthen the space continuity of the tissue structure, and provide speckle suppression, and improve the image contrast effect, so as to optimize the image data. Adjust iClear to optimize MPR image.
VR Refine	Optimize the signal-noise ratio and the contrast of VR image.
MagiClean	Reduce the noise and keep the boundary of the image more clearly. NOTE: Available only in Surface rendering mode.
Depth VR	Superimpose the tint map basic on the VR image to improve the stereoscopic sensation and the contrast of the image.
Thickness	Adjust the render thickness of MPR.

Reset Curve

Do one of the following to reset the curve:

Item	Description
Ori	To reset the volume rotation, shifting and zooming of 3D image to original status.
All	To reset the parameters, rendering rotation, VOI and image effect.
Reset Curve	To reset the curve to be the original beeline.

Render Mode

Set 3D image rendering mode.

The rendering manners can be applied to inversion mode.

Inversion

This function is to inverse the echo of the 3D image, so as to enhance observation for low-echo region, applicable for vessel, cyst and etc.

When the Inversion is turned on, the rendering mode parameters change into the corresponding inversion parameters.

Vessel shape is correct with the capture target. The vessel wall is smooth and clear.

Rotate the Image

NOTE:

You can view the back of the VR by rotating it 180°. The back view image may not be as vivid as the front. (Here we call the initial view of the VR the “front”). It is recommended to re-capture rather than rotate the VR if a certain desired region is obscured in the VR.

- Axial rotation
Axial rotation is to rotate the 3D image around the X, Y or Z axis. Use [X Axis], [Y Axis] and [Z Axis] buttons to rotate the image along the selected axis:
 - Tap the left part of the button, or rotate the multi-functional knob anticlockwise: the image rotates left along the selected axis.
 - Tap the right part of the button or rotate the multi-functional knob clockwise: the image rotates right along the selected axis.
- Auto Rotation
 - a. In 3D viewing mode, tap [Tools] > [Auto Rot.] to enter into auto rotation preparation state.
 - b. Tap [Left/Right] or [Up/Down] to set the auto rotation direction
 - c. Set Start position and End position:
Start position: Use the trackball/trackpad to view to a certain position, tap [Set Start].
End position: Use the trackball/trackpad to view to a certain position, tap [Set End]
 - d. Set the auto rotation increment: rotate the knob under the [Increment].
 - e. Tap [Off] to start auto rotation.
Use [Speed] to adjust the rotation speed
Tap [SE/SE] for single direction rotation; tap [SE/ES] for bidirectional rotation.

Surface Enhancement

This function is to make the edge structure of the image and surface details clearer, so as to enhance the overall contrast.

Tap [Surf. ENH] to adjust the enhancement level, the higher the level is, the clearer the edge structure of the image is.

When the level is higher than 0 and [Move Light] is highlighted, image close to the light source is clearer, and image away from the light source is darker.

Move the light

This function is to adjust the position of the light source as VR is considered. The image becomes clearer as keeping closer to the light.

Use the trackball/trackpad and change the light position to make fine adjustments after tapping [Move Light].

Sync

This function is to switch the direction of the image to the direction that is perpendicular to the current active plane, so as to get a better observation.

Comments and Body Marks

Add comments and body marks to the MPR and VR.

The operations are the same with these in B mode.

Image Editing

Image cutting is a more elaborate function than VOI adjusting to optimize the 3D by clipping (removing) the part blocked the region of interests.

TIP:

- In image cutting status, image parameter can not be edited. There displays a cutting cursor + or an eraser cursor ○, and the system enters “Accept VOI” status.
- The editing function is only available on 3D image.

Perform the following procedure:

1. Enter image cutting status by tapping “Tools” tab page.
2. Select an edit/erase tool:

Item	Description	Operation
Polygon	Allows you to trace a polygon on the image you want to cut.	Follow the steps below: 1. Press <Set> to position the start point. 2. Use the trackball/trackpad to set a region and press <Set> to trace the region. When the start point and the end point coincide, the region is selected or you can press <Set> twice to finish tracing. 3. Move the cursor to the region you want to edit and press <Set> again to edit.
Contour	Allows you to trace the portion of the image you want to cut.	Follow the steps below: 1. Press <Set> to position the start point. 2. Use the trackball/trackpad to trace the region. When the start point and the end point coincide, the region is selected or you can press <Set> twice to finish tracing. 3. Move the cursor to the region you want to edit and press <Set> again to edit.
Rectangle	Displays a box which can be used to define the portion of the image you want to cut.	Follow the steps below: 1. Press <Set> to fix the rectangle position. 2. Use the trackball/trackpad to change the size, and press <Set> again to finish rectangle drawing. 3. Move the cursor to the region you want to edit and press <Set> again to edit.

Item	Description	Operation
Line	Use a multi-point line to trace the boundary quickly.	Follow the steps below: 1. Press <Set> to position the start point and the system will display a reference line. 2. Use the trackball/trackpad to set the line orientation and press <Set> to start drawing, press <Set> when ends are necessary; press <Set> twice to finish drawing. 3. Move the cursor to the region you want to edit and press <Set> again to edit.
Soft Eraser	Applies to softer or smoother boundary within a small range of the image.	Follow the steps below: 1. Press <Set> to position the start point. 2. Use [Eraser Diam.] to adjust the eraser size if needed. 3. Use the trackball/trackpad to select the region, and press <Set> when ends are required. You can repeat the step to erase all parts blocking the interesting region.
Hard Eraser	Applies to a distinct boundary of within a wider range of the image.	
Eraser Diam.	As the eraser erases the image by means of sphere, you can adjust the size so as to adjust the erased area and depth. The eraser sphere center has a more distinct effect of clearing compared to other parts.	
Undo	To undo the last cut only.	/
Undo All	To undo all cuts since you entered image edit mode.	/

Section image (MPR) measurement

2D related measurement can be performed. For details, please refer to *Advanced Volume*.

TIP:

Capturing preparation does not support the measurement.

Image Saving

- Image saving
In the 3D Review mode, press <Save> key (with user-defined saving function) to save the current image and volume data to the patient information management system in the set format.
- Image review
Open an image file to enter the image review mode. In this mode, you can perform the same operations as what you can in review mode.

This page intentionally left blank.

8

Strain Elastography

⚠ CAUTION

It is provided for reference, not for confirming a diagnosis.

TIP:

- The strain elastography is an option.
 - Select an appropriate probe before performing elastography imaging scan, see “16.1 Probes”.
-

It is produced based on the slight manual-pressure or human respiration in 2D real-time mode. The tissue hardness of the mass can be determined by the image color and brightness. Besides, the relative tissue hardness is displayed in quantitative manners.

8.1 Basic Procedure for Strain Elastography

Perform the following procedure:

1. Perform 2D scan to locate the region.
2. Tap [Elasto] on the touch screen or press the user-defined key for “Elasto” to enter the elastography mode.

The system displays two dual B+E windows in real time. The left one is 2D image, and the right one is elasto image.

3. Adjust ROI according to the lesion size.

Press <Set> to switch between the solid line and the dotted line status.

- When the ROI box is solid line, use the trackball/trackpad to change its position.
- When the ROI box is dotted line, use the trackball/trackpad to change the size.

4. Press the probe according to the experiences and actual situation.

The screen displays the pressure curve in real-time:



Where, the X-axis represents time and Y-axis represents pressure.

5. Adjust the image parameters to obtain optimized image and necessary information.
6. Press or tap [Elasto] to exit, and then return to B mode.

8.2 Image Parameters

Smooth

Adjust the smooth feature of the Elasto image.

Opacity

Adjust the opacity feature of the Elasto image.

Invert

Invert the E color bar and therefore invert the colors of benign and malignant tissue.

Display Format

Adjust the display format of ultrasound image and the Elasto image.

Tap [H 1:1], [V 1:1], [Full] on the touch screen to adjust.

The system provides 3 types of display format:

- H 1:1: Right and left display (the real-time ultrasound image appears on the left, and the elasto image appears on the right);
- V 1:1: Up down display (the elasto image appears above, and the real-time ultrasound image appears below).
- Full: The elasto image only displayed.

Map

Select different maps for observation.

Strain mode

Affect the display effect of adjusting dynamic range.

Dynamic Range

Adjust contrast resolution of an image.

The real-time dynamic range value is displayed on the image parameter area in the upper left corner of the screen.

E Sensitivity

Increase the image palpability.

Strain Scale

Adjust the bar height of the pressure hint curve to keep the average height of the hint bar on proper position.

Map Position

Adjust the up/down position of the map.

8.3 Mass Measurement

Press <Measure> to enter measurement status.

You can measure shell thick, strain ratio, strain-hist, etc.

For details, see *Advanced Volume*.

9 Contrast Imaging

The contrast imaging is used in conjunction with ultrasound contrast agents to enhance imaging of blood flow and microcirculation. Injected contrast agents re-emit incident acoustic energy at a harmonic frequency much more efficient than the surrounding tissue. Blood containing the contrast agent stands out brightly against a dark background of normal tissue.

CAUTION

- Set MI index by instructions in the contrast agent accompanied manual.
 - Read contrast agent accompanied manual carefully before using contrast function.
-

NOTE:

- Make sure to finish parameter setting before injecting the agent into the patient to avoid affecting image consistency. This is because the acting time of the agent is limited.
 - The applied contrast agency should be compliant with the relevant local regulations.
-

TIP:

- Contrast imaging is an option.
 - Select an appropriate probe for Contrast Imaging, see “16.1 Probes”.
-

9.1 Basic Procedures for Contrast Imaging

Perform the following procedure:

1. Select an appropriate probe, and perform 2D imaging to obtain the target image, and then fix the probe.
2. Tap [Contrast] or press the user-defined key for “Contrast” to enter the contrast imaging mode.
3. Adjust the acoustic power experientially to obtain a good image.
Tap [Dual Live] to be “On” to activate the dual live function. Observe the tissue image to find the target view.
4. Inject the contrast agent, and set [Timer 1] at “ON” to start the contrast timing. When the timer begins to work, the time will be displayed on the screen.
5. Observe the image, use the touch screen button of [Pro Capture] and [Retro Capture] or the user-defined key to save the images.
Press <Freeze> to end the live capture.
Perform several live captures if there are more than one interested sections.
6. At the end of a contrast imaging, set [Timer 1] at “OFF” to exit the timing function.
Perform steps 3-6 if necessary.

For every single contrast imaging procedure, use [Timer 2] for timing.

If necessary, activate destruction function by tapping [Destruct] at “ON” to destruct the micro-bubbles left by the last contrast imaging; or to observe the reinfusion effect in a continuous agent injecting process.

7. Exit contrast imaging.

Press button to return to B mode.

9.2 Left Ventricular Opacification

TIP:

LVO contrast imaging is an option.

Perform the following procedure:

1. Acquire ECG signal.
2. Select an appropriate probe and LVO exam mode.
3. Workflow of LVO is similar to abdomen contrast imaging, see “9.1 Basic Procedures for Contrast Imaging”.

9.3 Low MI Contrast Imaging

TIP:

Low MI contrast imaging is an option.

This feature enhances echo reflection by using contrast agent to perform myocardial analysis based on echocardiography technique.

Perform the following procedure:

1. Acquire ECG signal.
2. Select an appropriate probe and cardiac exam mode.
3. Workflow of Low MI Contrast imaging is similar to abdomen contrast imaging, see “9.1 Basic Procedures for Contrast Imaging”.

9.4 Image Parameters

When entering contrast imaging mode, the screen displays the contrast image, and if [Dual Live] item on the touch screen is “ON”, both the contrast image (marked with “C”) and tissue image (marked with “T”) are displayed (the two window position can be changed).

Parameters in Contrast mode are similar to those in B mode; please refer to B chapter for details, special Contrast imaging parameters are introduced in the following.

Timer

NOTE:

The starting time displayed may be inconsistent with the actual one due to system error or some other man-made mistakes; please check the agent-injecting time.

The two timers are used to record total time of contrast imaging and single time of one contrast exam.

After the image is frozen, Timer 1 is still timing, and after unfreezing the image, the corresponding time can be seen.

Timer 2 stops timing when one contrast exam is frozen, and after unfreezing the image, the Timer 2 is off.

Set [Timer 1] as “ON” to start the timing at the moment you inject the contrast agent. Here, the screen displays the times at the lower corner.

Micro-bubble Destruction

CAUTION

Use the contrast imaging according to the residual level of the micro-bubbles, using contrast imaging continuously may result in human harm.

Destruct the micro-bubbles left by the last contrast imaging; or to observe the reinfusion effect in a continuous agent injecting process.

Tap [Destruct] on the touch screen to enable the micro-bubble destruction function:

- DestructAP: Adjust the destruct acoustic power via the touch screen.
- Destruct Time: Adjust the destruct time via the touch screen.

Dual Live

In live mode or freeze mode, set touch screen item [Dual Live] as “ON” to enable dual live function. Both the contrast mode and tissue mode are displayed. The THI and B image are displayed on the screen if the [Dual Live] is enabled.

TIP:

- In dual live mode, the screen displays the contrast image and tissue image
- In freeze mode, there displays only one cine review progress bar as the contrast image and tissue image are reviewed synchronously.

Mix Map

This function is to mix the contrast image with the tissue image, so that interested contrast regions can be located.

Use [Mix] to select different mixing mode.

- When dual live function is on, you can see the mixed effect on the contrast image.
- When dual live function is off, you can see the mixed effect on the full screen image.

Select the map through the [Mix Map] item.

iTouch

On contrast status, you can also get a better image effect by using iTouch function.

1. Press <iTouch> on the control panel to turn on the function.

The symbol of iTouch will be displayed in the image parameter area once press <iTouch>.

2. Select different levels of iTouch effect through [iTouch] on the touch screen.
3. Long press <iTouch> to exit the function.

9.5 Image Saving

- Live capture
In live mode, you can save the interested images by tapping [Pro Capture] and [Retro Capture].
- Cine saving
In live mode, press <Freeze> on the control panel to enter cine review status.

9.6 Micro Flow Enhancement

MFE superimposes and processes multiple frames of contrast image during the cycle; it indicates tiny vessel structures in detail by recording and imaging microbubbles.

TIP:

- MFE imaging is available only for real-time imaging or cine file of auto review mode. If a MFE cine is reviewed manually, MFE effect cannot be displayed.
 - In MFE status, patient should lie down and hold breath, and transducer should be kept still.
-

Perform the following procedure:

1. During real-time scanning, tap [MFE] on the touch screen to start MFE imaging.
2. Use [MFE Period] on the touch screen to select different imaging period suitable for current flow. Where, MAX is the maximum superimposing effect.

9.7 Contrast Imaging QA

 CAUTION

Contrast Imaging QA images are provided for reference only, not for confirming a diagnosis.

TIP:

- In case of inaccuracy of the data, do not adjust the depth and the pan-zoom when saving the cine.
 - If the contrast signal inside the selected ROI does not meet the requirements of gamma fitting condition, that is the bulleting injection, curve fitting may not be available.
-

Contrast Imaging QA adopts time-intensity analysis to obtain perfusion quantification information of velocity flow. This is usually performed on both suspected tissue and normal tissue to get specific information of the suspected tissue.

Figure 9-1 Contrast QA Screen

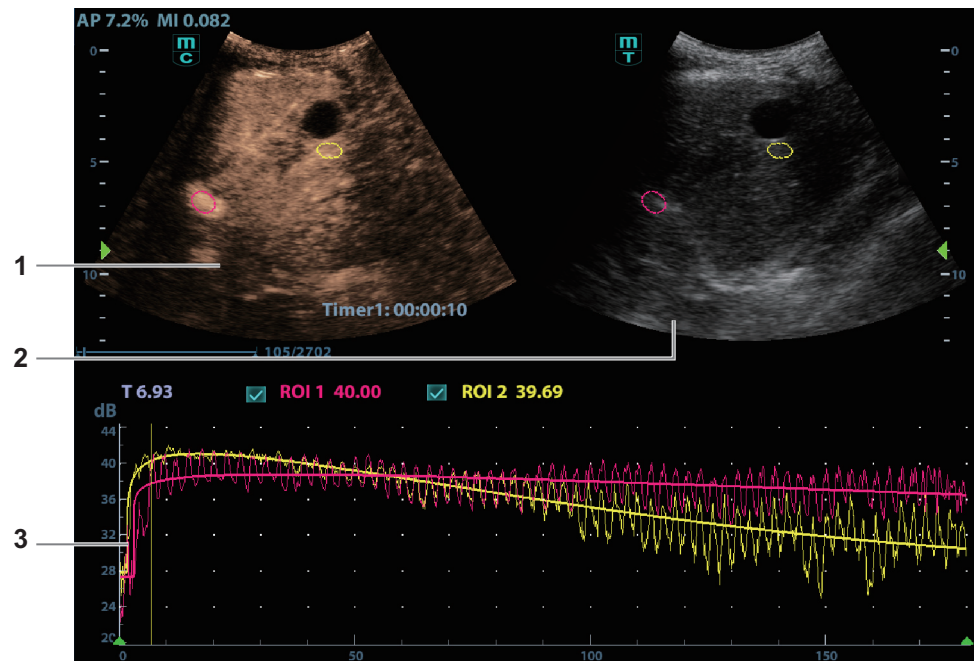

1	Contrast cine loop window	Sample area: indicates sampling position of the analysis curve. The sample area is color-coded, 8 (maximum) sample areas can be indicated.
2	B cine loop window	Sample areas are linked in the contrast cine loop window and B cine loop window.
3	Time-intensity curve	<ul style="list-style-type: none"> • Y axis represents the intensity (unit: dB), while X axis represents the time (unit: s). • Frame marker: a white line that is perpendicular to the X axis, can be moved horizontally left to right (right to left) by using the trackball/trackpad. • Click the check box beside the ROI to set if to hide or to display the QA curve. • You can get the current X/Y axis value by moving the cursor onto one point on the curve; and if you press <Set> at this time, the frame marker will move to the spot.

Perform the following procedure:

1. Perform image scanning, freeze the image and select a range of images for analysis; or select a desired cine loop from the stored images.

The system set the starting time and ending time of the cine to be first frame and last frame of QA analysis range.

2. Review the image to a desired frame.
3. Tap [Contrast QA] on the touch screen to activate the function.
4. Mark out the interested part (ROI).

Up to 8 ROIs can be saved on the reference image, with the corresponding eight traces plotted simultaneously on the graph. Each ROI display has a different color, and its corresponding trace data is plotted using that same color.

- a. Use [ROI Type] to select the method for determining the shapes of the sample area: Trace ROI and Ellipse ROI.
The cursor is evolved in the image review area.
- b. Use the trackball/trackpad to position the caliper on the reference image at the start point. Press <Set> to fix the start point.

Trace ROI	<p>Follow the steps below:</p> <ol style="list-style-type: none"> 1. Press <Set> key to fix the starting point. 2. Press <Set> key, and use the trackball/trackpad to depict the ROI. Press <Clear> to cancel the last point. The system automatically links the start point to the end point by drawing a straight line between them. 3. When a suitable ROI has been drawn, confirm the ROI by double pressing <Set>.
Ellipse ROI	<p>Follow the steps below:</p> <ol style="list-style-type: none"> 1. Use the trackball/trackpad to position the caliper on the reference image at the start point. Press <Set> to fix the start point. 2. Trace the outline of the desired ROI by moving the cursor with the trackball/trackpad. 3. Press <Set> to fix the end point, and use trackball/trackpad to depict the ROI. When a suitable ROI has been drawn, confirm the ROI by pressing <Set> key.

- Press <Clear> key to clear out the last ROI.
 - Tap [Delete All] on the touch screen to clear out all ROIs.
The corresponding traces for the deleted ROIs are erased from the plot.
 - Tap [Copy ROI] to create a new ROI similar to the current or latest added ROI
5. Tap [Motion Tracking] to enable the Motion Tracking function.
This function provides a motion compensated ROI as precise time-intensity information can be acquired using active tracking. It can enhance the calculation accuracy as reducing the impact of probe or patient respiratory movement.
 6. If necessary, tap [Fit Curve] to perform curve fitting on the time-intensity curve, where color of the fitted curve is consistent with color of the current ROI curve.
The system can calculate characteristic parameters according to curve fitting formula and data, display fit curve for time-intensity curve, and perform data analysis on time-intensity curve for data table.
 - Tap [Raw Curve] to hide/display raw curve.
 - Tap [Table Display] to check parameters:

Item	Description
GOF (Goodness of Fit)	Calculate the fit degree of the curve; range: 0-1, where 1 means the fit curve fits the raw curve perfectly.
BI (Base Intensity)	Basic intensity of no contrast agent perfusion status.
AT (Arrival Time)	Time point where contrast intensity appears, generally, the actual time value is 110% higher than the base intensity.
TTP (Time To Peak)	Time when the contrast intensity reaches peak value.

Item	Description
PI (Peak Intensity)	Contrast peak intensity.
AS (Ascending Slope)	Ascending slope of contrast, the slope between the start point of lesion perfusion to the peak.
DT/2	Time when the intensity is half the value of the peak intensity.
DS (Descending Slope)	Descending slope of the curve.
AUC (Area Under Curve)	To calculate the area under the time-intensity curves during contrast.

You can set range for the fit curve. After the range is set, the system displays fit curve within the range only. Use the trackball/trackpad to the time-intensity curve to move the frame marker position.

- a. Set starting point of the fit curve: Use the trackball/trackpad to select the starting time and tap [Set Fit Start].
 - b. Set end of the fit curve: Use the trackball/trackpad to select the end time and tap [Set Fit End].
7. Use [X Scale] on the touch screen to choose different value, so that the X scale display manner will be changed.

This function can be used to track detailed tissue information.

8. Save the curved image, export the data and do parameter analysis.

- a. Tap [Export] on the touch screen.
- b. Select the drive and enter the file name in the displayed window.
- c. Select [OK] to save the data and return to the QA Analysis screen.

All displayed ROI traces are saved in the exported file.

The parameters are included in the trace file if the user has fixed a ROI.

After the exporting is succeeded, a .BMP format image is displayed in the thumbnail area of the screen.

Only data from the user selected image range is included in the exported trace file.

9. Tap [Exit] to exit Contrast QA.

This page intentionally left blank.

10 Physiological Unit Signal

The physiological unit signal waveform is used for checking ultrasound image in ultrasound exam (cardiac exam mainly).

WARNING

- Do not use the physiological traces for diagnosis and monitoring.
- To avoid electric shock, the following checks shall be performed prior to an operation:
 - The ECG electrode cable must not be cracked, frayed or show any signs of damage or strain.
 - The ECG electrode cable must be correctly connected.
 - You must use the ECG leads provided with the physiological unit module. Failure to do so may result in electric shock.
- The ECG electrode cable must be connected to the system first. Only after the cable is connected to the system, can the patient be connected to the ECG electrodes. Failure to follow these instructions may subject the patient to electric shock.
- Do not place the ECG electrodes directly in contact the patient's heart; otherwise it may lead to stop of the patient's heartbeat.
- Do not use this system when any digital device such as a high-frequency electrotome, high-frequency therapeutic device or defibrillator is applied already.
- Conductive parts of electrodes and associated connectors for ECG should not contact other conductive parts including earth/grounding.
- Frequent trampling or squeezing on the cables may result in cable breakdown or fracture.
- Display effect of respiratory curve depends on the patient breathing status. While a very slow or smooth breathing may lead to an inapparent respiratory curve, breathing in a large amplitude may cause an incomplete display of the respiratory curve. Display effect is linked to the connected parts of the body. Generally, signals by connecting to limbs are stronger than by connecting to the chest.

10.1 ECG

Perform the following procedure:

1. Connect the device and place ECG electrodes.
 - a. Turn off the power supply of the system, and connect the ECG module to the system.

- b. Connect the ECG cable to the ECG module.
- c. Turn on the power supply of the system.
- d. Place the ECG electrodes on the patient's body (as shown in the following figure).

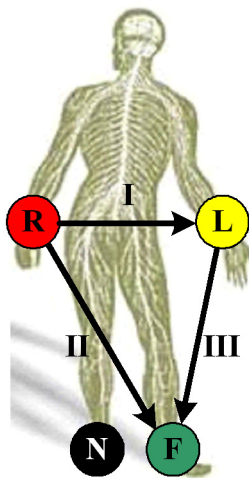

2. Tap [Physio] or press the user-defined key for “Physio” to enter physio operation interface.
3. Switch the imaging modes and display formats, adjusting the parameters to get an optimized image.
4. Parameter adjusting:
Tap [ECG] on the touch screen to enable or disable ECG waveform curve. Adjust the [Speed], [ECG Gain], [Position] and [Invert].
5. Trigger:
Select the trigger mode, or tap [Real & Trig] to set the trigger time, triggering delay time and image display format.
6. Freeze the triggering image and the curve, and then review them.
7. Tap [Physio] or press the user-defined key for “Physio” to exit ECG mode, and remove ECG electrodes from the patient.

ECG Triggering

ECG triggering means that image scanning is activated at some time points of ECG signals, thus obtaining B images at these time points. The triggering image should be in 2D-mode.

When ECG triggering occurs, some marks (frame triggering mark) appear on the ECG waveform (relative R wave, the time for delay set), indicating the time points when the 2D images are captured.

TIP:

- The triggering mark is displayed in both freeze mode and live mode
 - The marks in Dual trigger are in different colors.
 - Triggering function is unavailable if the ECG trace is disappeared. Only the live 2D image can be triggered.
 - No delay time or time interval shall be less than the time required to scan a single image.
 - If the delay time is longer than a heart cycle, then the heart cycle in the delay time is omitted, that is to say no trigger is occurred when R waveform is detected in the duration.
-

Triggering Mode

There are three triggering modes available: Single, Dual, and Timer.

- Single Trigger: When an R waveform is detected, an image will be triggered after delay time T1. The time of T1 can be edited in single mode.
- Dual trigger: when an R waveform is detected, two images in two windows will be triggered respectively after delay time T1 and T2. The time of T1 and T2 can be edited in dual mode.
- Timer Trigger: an image will be triggered after a time interval. The time interval can be edited in triggering status.

The image triggering operation is described as follows (Take single trigger as an example):

1. Select exam mode.
2. Tap [Trig Mode] on the touch screen to enable the trigger.
3. Select [Single].
4. Set the delay time (or use the T1 by default).

Real & Trigger

Tap [Real & Trigger] to enable or disable the real trigger function.

After the [Real & Trigger] is enabled, two images are displayed respectively in two windows. One is triggered by ECG, and the other is non-triggered real time image.

10.2 Respiratory Wave

Perform the following procedure:

1. Connect the ECG lead and position the ECG electrodes.
2. Tap [Physio] or press the user-defined key for “Physio” to enter Physio screen.
3. Switch the imaging modes and display formats, adjusting the parameters to get an optimized image.
4. Parameter adjusting:
 - a. Tap [RESP] on the touch screen.
 - b. Adjust [Speed], [RESP Gain], [Position] and [Invert].
5. Exit Respiratory display mode, and remove ECG electrodes from the patient.
6. Tap [Physio] or press the user-defined key for “Physio” to exit physio mode.

10.3 ECG Review

10.3.1 Review Principle

When an image is frozen, the ECG waveform where the image is triggered will be frozen at the same time. In the Dual triggering mode, the two window images are frozen at the same time. When images are reviewed with the ECG electrodes connected, the ECG trace is the reference for time.

After the images are frozen, all real time images are in the status of linked review.

10.3.2 Linked Review of Waveforms, M/D Images and 2D Images

If the physio unit signal, time curve and 2D image are frozen at the same time, the replay of them is displayed at the same time.

10.4 Parameter Description

The physio parameters are described as follows:

Parameter	Description
ECG Source	Select ECG source.
Gain	Set the amplitude of the trace.
Position	Set the vertical position of the both traces on the image display.
Speed	Change the speed of the physio trace.
T1	Set the delay time T1 in Single trigger or Dual trigger.
T2	Set the delay time T2.
Interval	Set the time interval for Timer.
Invert	Invert the display.

11 Stress Echo

Stress Echo is an option, only the phased probes support stress echo function under the cardiac mode.

CAUTION

Stress echo data are provided for reference only, not for confirming diagnoses.

The Stress Echo feature allows you to capture and review cardiac loops for multiple-phase (multiple-stage) Stress Echo protocols.

Stress Echo data consists of Stress Echo loops, wall motion scores, and all other information pertaining to the Stress Echo portion of a patient examination.

A loop is a clip that displays the motion of an entire heart cycle, or from the beginning systole to the end systole, as indicated by the R-wave of the ECG trace and determined by the QT – Time Table.

The loops in a given protocol are acquired by stages (phases), according to stage configuration (continuous (prospective) or retrospective (non-continuous)).

- Loops in non-continuous stages are limited to a specified loop-per-view maximum (such as four). View labels can only be selected in the configured order. Acquisition is retrospective - when you press <Save> on the control panel, the system saves the previously acquired images.
- Loops in continuous stages are limited by time rather than a maximum number of loops - the system stops acquisition after two minutes. Acquisition is prospective - when you select the stage label and then press <Save> on the control panel, the system starts saving newly acquired images. In some protocols, the system will jump to Select Mode after retrospective saving.

When images are saved, the system places a green checkmark to the right of the view or continuous stage and then shifts the red mark to the next view or next stage.

11.1 Stress Echo Acquisition Procedure

To acquire Stress Echo loops, you must enable the ECG function.

Perform the following procedure:

1. Use the proper probe and cardiac-related exam mode, tap [Stress Echo] or press the user-defined key for “Stress Echo” to enter stress echo imaging.

The system displays the “Select Protocol” window with the protocol selections.

2. Select the desired protocol and then tap [OK].

The system displays the real-time imaging screen.

- If the Stress Echo manual ROI option is selected in the Maintenance dialog box, the system also displays a region of interest (ROI).
 - If Acquire Mode is set as Full-screen in Maintenance, then no ROI box is displayed.
3. According to the help information in the bottom of the screen, if an ROI is displayed, adjust the ROI size and position. Press <Update> on the control panel to confirm the ROI.

When you confirm the ROI size by pressing <Update>, you cannot adjust the ROI size during acquisition. You can only adjust the ROI position using the trackball/trackpad.

4. Press <Save> on the control panel to start acquisition.

The system displays the Protocol window on the screen, listing the phases for the selected protocol along with the first phase views (phases are stages). The system selects the first view for acquisition by default.

5. Proceed through each view in each stage according to the following instructions:

Non-continuous stages:

- To save acquired images for the selected view, press <Save> on the control panel. The system goes to the next view for acquisition by default, saved views are marked with a green “√.”
- Use [Stages XXX] or [Views XXX] to select the stage and view for image acquisition (or reacquisition). Press <Save> to start acquisition.
Views can be re-acquired until you tap [End Acquisition].

If the protocol contains continuous stages (for alternative workflows), then proceed through each continuous stage according to the following instructions:

- To begin saving acquired images for the selected stage, press <Save> on the control panel.
- The system displays a percentage marker below the selected stage indicating the progress of the continuous capture.
- To halt saving acquired images for the selected stage, tap [Pause] on the touch screen or press <Freeze> directly. The percentage stops increasing.
- Select [Continue] or press <Freeze> again to continue.
- To end the current acquisition, press <Save> on the control panel.
- To select another continuous stage, use [Stages XXX] on the touch screen.
- Suspending is not allowed under continuous exam.

When acquisition is complete for each stage, the system advances to the next stage. If the stage is non-continuous, the system displays the stage views. When image acquisition is completed for all views and continuous stages, the system switch to Select Mode.

6. To start or restart the timer, tap [Stage Timer]/[Exam Timer] to turn it on.

The Stage time is displayed to the right side of each stage in the protocol list, while the Exam time is displayed in the left side of the screen.

Each saved image will be marked with two times T1 and T2. T1 refers to the total time of the whole acquisition, while T2 indicates the time the acquisition lasted for a certain stage.

7. To review loops before ending acquisition, select [Review/WMS]. You can redisplay the real-time imaging screen to continue acquisition by selecting [Acquire].
8. To end the acquisition and review the acquired images, tap [End Acquisition].

When the acquisition is ended, no stress echo image acquisition can be performed for the same exam.

11.2 Selecting Preferred Stress Echo Loops (Select Mode)

The selected clips are used for analysis in the review mode and wall motion scoring mode. Select Mode is used to select the best loops of the examination.

When the acquisition is ended, select mode is enabled automatically.

In Select Mode, you can select the representative loop (“preferred” loop) for each view.

To select “preferred” loops:

1. Use the <Update> key according to tips in the trackball/trackpad hint area or select [Select] to enter the Select Mode, or the system enters the Select Mode directly after the acquisition is finished.
2. Select the loop. Use the buttons displayed during Select Mode to designate another loop or another view for display.
 - Use [Stages XXX] or [Views XXX] to select the target stage/view.
 - Single-click a clip to select the clip for current stage/view and zoom in the clip to the full-screen.
 - Double-click a clip. The clip will be magnified.
 - Tap [First/Last] or [Previous/Next] on the touch screen to display another loop in the current view.
3. Select the stage and view to display all loops for the view and then continue designating the “preferred” loop for each displayed view until all views are completed.

Description of select mode controls:

Selection	Description
Stages XXX	To select a stage.
Views XXX	To select a view.
Acquire/Select/ Review/ WMS	To switch the mode status.
1. Clip/2. Clip/3. Clip/4. Clip	For selecting views in the selected stage.
Next	Next four Clips.
Previous	Previous four Clips.
First	Go to “first” Clips.
Last	Go to “last” Clips.
Play	Click to play/stop cine play.
Prev frame	See previous frame of the cine file.
Next frame	See next frame of the cine file.
First frame	See first frame of the cine file.
Last frame	See last frame of the cine file.
Speed decrease/Speed increase	Decreases or increases playback speed.
Text	Function that turns the screen graphic text “On” or “Off”. Information includes: name of level, name of view, heart rate, time stamp acquisition, timers, frame slider, loop ID, clip control. For the cine without distributed view, the name of level and name of view are displayed in “--”.
Apply edit all	Clip edit applied to all clips taken.
Clip Length	Specify the clip segments: systole, diastole, full cycle or user-defined.

Selection	Description
Bookmark	For continuous acquisition, when the bookmark is set to “On”, only the selected loops for the current view can be displayed.
Delete Unselected	Delete clips that are not selected. If selected, the system will delete all clips that are not selected after the exam is ended.
Suspend exam	Pauses the stress echo exam but does not end the stress echo exam. When a stress echo exam is suspended, the user can perform image acquisition of all other imaging modes, or perform operations such as measurement.
End SE exam	End the stress echo exam.

11.3 Review/WMS Mode

Review/WMS mode is used by cardiologists to evaluate clips for cardiac wall motion abnormalities. Different views from different stages are selected for comparison across a wide variety of combinations. The most common workflow is to compare “same views” but at “different stages” of the exam (e.g., PSLA view, Rest stage compared to PSLA view, Post-exercise stage).

11.3.1 Enter review mode

Select [Review/WMS] to enter review mode, and then select the label of the phase or view (for example, Rest or Long Axis), the system displays all loops that represent the selected phase or view.

To display phases for the selected view(s)

Perform the following procedure:

1. To include a phase or view for display, select the leftmost, gray box to the left of each required phase and/or view.

The system inserts a checkmark into each selected gray box.

2. To exclude a phase or view from display, select the blue box to the left of each required phase and/or view.

The system inserts a X into each selected box, like .

3. Select [Display Selected] on the touch screen.

The system displays the selected phases for each selected view side by side.

To display all views for a specific phase

Select the phase label (for example, Rest).

To display all phases for a specific view

Select the view label (for example, PLAX).

The system displays all phases for the selected view.

To display a loop in full-screen format

1. Double-click the loop to display in full-screen format.
2. Double-click the loop again to display the loop in its initial size, select the loop again.

Description of review/WMS mode keys (keys with the same function as in select mode are not described below):

Item	Description
Review/WMS	<p>Perform side-by-side comparison of the same views at different stages (PLAX, PSAX, A4C, A2C at “Rest” compared to PLAX, PSAX, A4C, A2C “Post-Exercise”). Clips are synchronized.</p> <ul style="list-style-type: none"> Under [Text] “Off” status, when you select one stage, all view loops are displayed on the screen; when you select one view, all loops of the same view in different stages will be displayed on the screen. Set [Text] to “On”, the system will select loops of first two views of the first two stages to display automatically. If you choose [Previous], then loops of the next two views of the first stages will be displayed. If you choose [Next], loops of the first two views in the 3rd and 4th stage will be displayed. <p>In the meantime, if you choose one stage, loops of all views under this stage will be displayed on the screen (4 at most), and choosing one view will lead to loops of this view in different stages be displayed (4 at most).</p>
Display Selected	Displays loops of all the stages and views selected.

11.3.2 Wall Motion Scoring

The WMS-Report lists user-assigned wall motion scores and associated data.

The Wall Motion Score (WMS) measurement is an application prepared for assisting in stress echo semi-quantitative evaluations of abnormalities with left ventricular wall motion or changes in wall thickness. The left ventricle is divided into segments for scoring to evaluate the degree of abnormality from the sum of the scores in each segment using the motion of the walls of the entire left ventricle.

You can assign wall motion scores to specific portions within each view (representative loop). You can also assign a normal wall motion score (WMS) to the currently selected view or to all displayed views.

Two methods of chamber segment division, ASE 16 and ASE 17, are supported. In addition, each segment has 3 kinds of scoring method: 4, 5 and 7 points. Select through the [Scoring] control on the touch screen.

To assign a wall motion score (WMS):

1. Select a colored number.

The meanings and colors used in segments are listed in the table below.

Score	Meaning	Color
1	Normal	Green
2	Hypokinesis	Yellow
2.5	Severe Hypokinesis	Khaki
3	Akinesis	Blue
4	Dyskinesis	Red
5	Aneurysm	Purple

2. Use the trackball/trackpad to select the value and then click the target segments, then the segment is assigned with a value.

3. Repeat step 2 to perform value assign for all segments.
 - To assign a normal wall motion score (WMS) to all currently displayed views:
Select [Set All Normal] on the touch screen.
 - To assign a normal wall motion score (WMS) to the currently selected view:
Select [Set Current Normal] on the touch screen.

11.4 Saving Stress Echo Data

Stress Echo data consists of Stress Echo loops, wall motion scores, and all other information pertaining to the Stress Echo portion of a patient examination.

When the exam is ended, the system will save all images within the exam.

11.5 Exiting the Stress Echo Feature

To exit the Stress Echo feature:

Tap [End SE exam] on the touch screen.

11.6 Measurement and Report

Suspend the stress echo exam by selecting [Suspend Exam]. Press the measurement related keys or buttons to enter cardiology measurement. For details, see the *Advanced Volume*.

Reports contain the entered indication, if any, and also any entered comments that are specific to the report. You can include or exclude data from specific phase(s). You can preview and print the report for the currently selected mode. You can also enable colored report printing in Maintenance.

You can enter indications or comments for display in Stress Echo reports.

To enter an indication:

1. Tap <Report> to open the report.
2. Use the soft keyboard to enter text in the Indication dialog box and then tap [OK].

12 Display & Cine Review

12.1 Splitting Display

The system supports dual-split and quad-split display format. However, only one window is active. The multi-window display can complete the image and multi-frame image comparison.

Dual-split

Press <Dual> on the control panel to enter the dual-split mode, and use <Dual> / <Update> key to switch between the two images; press to exit.

Quad-split

Press the user-defined key for “Quad” to enter the quad-split mode, and use the user-defined key to switch among four images; press to exit.

Modes support quad-split display: B mode, Color mode and Power mode.

12.2 Image Magnification

NOTE:

Zooming an image changes the frame rate which tends to change thermal indices. The position of the focal zones may also change which may cause the peak intensity to occur at a different location in the acoustic field. As a result, the MI may change.

12.2.1 Spot Zoom

Perform the following procedure:

1. Press <Zoom> to enter the sample volume definition status.
2. Use the trackball/trackpad to change the box size and position. Press <Set> to toggle between setting the size and position.
3. After the sample volume is set, press <Zoom> / <Update> again to enter spot zoom status.
4. Use [Zoom Value] to change the magnification factor.
The image magnification factor value will display in real time in the image parameter area.
5. The size and position of sample volume box change along with scan depth and area.
6. Press <Zoom> again to exit spot zoom.

12.2.2 Pan Zoom

Perform the following procedure:

1. Use [Zoom Value] on the touch screen to enter the pan zoom status.
2. Adjust the Zoom value, Image-in-image is displayed.

The image magnification factor value will display in real time in the image parameter area. For example, “Z 1.40” indicates that the magnification factor is 1.4.

3. Use the trackball/trackpad to shifting the image.
4. Adjust the magnification factor to 1.00 to exit pan zoom.

12.2.3 iZoom (Full-screen Zooming)

Perform the following procedure:

1. Press the user-defined key for “iZoom” to zoom in the image.
The zooming area includes image area, parameter area, image banner, and so on.
2. Press the user-defined key again to zoom in the image area only.
The image goes to full-screen.
3. Press the user-defined key again to exit.

12.3 Freeze/Unfreeze the Image.

Press [Freeze] key on the control panel to freeze a scanning image. In freezing mode, the probe stops transmitting acoustic power, and all images as well as the parameters are kept still.

After freezing an image, the system may enter cine review, measure, comment adding, or body mark mode, which is dependent upon preset, see “4.1.2 General”.

Press <Freeze> in frozen mode to unfreeze the image, and the system continues image scanning.

12.3.1 Imaging Mode Switching When Frozen

Imaging mode switching in frozen mode follows the following principles:

- In splitting display B mode, press <Dual>/user-defined key for “Quad” to switch among the windows; press to exit splitting display mode and enter the image of the currently activated window in full screen.
- In frozen mode, the system supports imaging mode switching between the sub-modes (only for the activated window). For example, if the frozen image is of B+C+PW mode, then the system supports imaging mode switching between B+C+PW, B+C, B+PW and B by pressing <C> or <PW>.
- The imaging mode and parameters of an unfrozen image is the same as the corresponding one that before frozen; but the display format is the same as the one before unfrozen.

12.4 Cine Review

The system allows you to review and edit the images prior to the image frozen. This function is called as cine review. The magnified images can also be reviewed, and the operating method is the same. You can perform zoom, measurements, add comments and body marks on the images being reviewed.

The system supports manual review as well as automatic review. The default setup is Manual Cine, but you can switch between Auto Cine and Manual Cine.

In addition, the system supports the images reviewed along with physiological unit waveforms, if the detection of physiological unit waveforms is performed.

CAUTION

- The cine memory must be cleared at the end of the current patient and the onset of the next new patient by tapping [End].

- Cine files stored in the system's hard drive shall contain patient information, to avoid the selection of an incorrect image file and potential misdiagnosis.

12.4.1 Entering/Exiting Cine Review

To Enter Cine Review

- The system enters the manual cine review status once press <Freeze> to freeze the image.
- Open cine files in thumbnail, iStation or Review. The system enters automatic cine review status.

To Exit Cine Review

Press <Freeze> or , the system will return to image scanning and exit cine review.

12.4.2 2D Cine Review

Manual Cine Review

Enter the cine mode in 2D imaging mode. Use the trackball/trackpad to view the cine.

- If you move the playback mark to the left by using the trackball/trackpad, the review sequence is reversed to the image-storing sequence, thus the images are displayed in descending order. Whereas, if you move the playback mark to the right by using the trackball/trackpad, the review sequence is the same as the image-storing sequence, thus the images are displayed in ascending order. When you review images until the first or the last frame, further using the trackball/trackpad will display the last or first frame.
- The review speed is adjusted through the trackball/trackpad.

The cine progress bar at the bottom of the screen (as shown in the figure below):

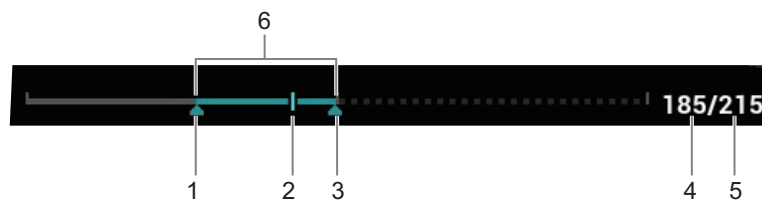

1	Start mark
2	Playback mark
3	End mark
4	Current frame
5	Total frames
6	Auto Review Region

Reviewing all of Auto Review

Perform the following procedure:

1. In the manual cine review status, use the [Auto Play] to set the review speed to activate auto cine review.
2. Exit:

Tap [Auto Play] on the touch screen, or use the trackball/trackpad, the auto review state becomes manual cine review.

Setting scope of Auto Review

You can set a segment of cine loop which can be reviewed automatically. After the auto review scope is set, the auto cine review can only be performed within this scope; but the manual cine review can be performed beyond this scope. When the cine file is saved, only the images within this scope are saved.

TIP:

You can perform cine review on each image window in the dual/quad splitting mode, and set auto review region for each window.

Perform the following procedure:

1. Set the start frame:

Manually review the cine file by trackball/trackpad, and tap [Set Begin] on the touch screen to set current frame to be the start point.

2. Set the end frame:

Manually review the cine file by trackball/trackpad, and tap [Set End] on the touch screen to set current frame to be end.

3. Use [Auto Play] on the touch screen to set the review speed.

The system plays the auto review region automatically.

4. Tap [Jump to First]/ [Jump to Last] to review the first or last image.

12.4.3 Cine Review in M/PW/CW/TVD Mode

Enter cine review in M mode, PW mode, CW mode TVD mode, and then use the trackball/trackpad the cine images are displayed on the screen one by one.

Move the playback mark to the left by using the trackball/trackpad. The review progress slider moves to the left, the images moves to the right, and the earlier stored images are invoked. Whereas move the playback mark to the right by using the trackball/trackpad, the review progress slider moves to the right, and the images move to the left, the recently stored images are invoked. When the image goes to the first/last frame, the cine is played in loop with the trackball/trackpad moving left or right.

The cine progress bar at the bottom of the screen (as shown in the figure below):

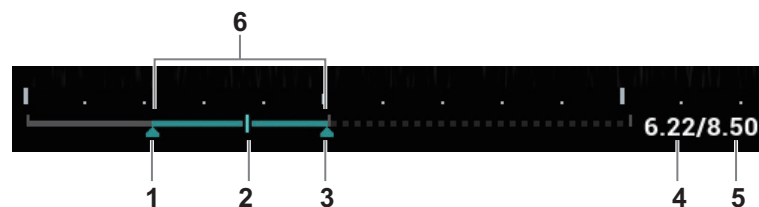

1	Start mark
2	Playback mark
3	End mark
4	Time played
5	Total time

6	Auto Review Region
---	--------------------

Cine review operations are the same as these of 2D mode.

TIP:

There is no audio when the spectrum is reviewed in manual status but audio synchronization can be realized in auto review status with speed of $\times 1$.

12.4.4 Linked Cine Review

The linked cine review refers to review of the images captured at the same moment.

- B/Color/Power/TVI/TEI dual live
- B/B dual live
- B+M synchronization mode
- B+PW/TVD duplex mode
- TVM, CM triplex mode



1	Frame synchronization mark
2	Playback progress bar

The frame synchronization mark on the time mark of M/PW image indicates the corresponding 2D image and M/PW image. In statuses other than dual live status, you can only review images in the currently active window.

12.5 Image Compare

12.5.1 Image Compare in Review Mode

TIP:

For B/B+COLOR/B+TVI/B+POWER/B+TEI mode image, you can select at most 4 images; for PW/M/CW/TVD mode image, you can select at most 2 images

Perform the following procedure:

1. Tap [Compare] on iStation screen or Review screen.
2. Select the images for comparison.

Click to select the image, and the icon  appears on the image, which indicates the image is to be compared.

If select the wrong image, click the image again to cancel the selection.

- Select image size display on “Thumbnail Size” bar to display more images at a time.

- Image compare of different exams for the same patient: Select “all” in the drop-down list of “Exam History” to see all exam files, then you can select different images of different exams to compare.
3. Repeat the step 2 above to add the image to be compared.
There is “Display” column you can filter the images by selecting “All Items”, “Selected”, “Unselected”.
Click [Clear Selected] to clear all selected images.
 4. Click [OK] to enter image comparison.
 5. Switch the multi-frame cine among the windows to review (single-frame image cannot be reviewed).
 - Press <Dual> to toggle between the two images.
 - Press the user-defined key for “Quad” to switch among 3-4 images.
 The window with the highlighted “M” mark is the current activated window.
You can select the image to be reviewed at synchronous time when the multi-frame image is reviewed by using [Sync Play].
 6. Save the image if necessary.
 7. Click [Return] on the screen or press <Freeze> to exit image compare.

12.5.2 Frame Compare

TIP:

Cine compare can only be performed for B/C mode image only. The image on dual/quad window cannot be compared.

Perform the following procedure:

1. Freeze the image in B/C mode, tap [Frame Compare] in “Cine” page on the touch screen to enter frame comparison mode.
2. Review the images of different image windows (cine replaying can't be performed for single-frame image file), press <Update> or <Dual> key to switch the active image window.
3. Save the image if it is necessary.
Measurements, adding comments and body marks are allowed.
4. Tap [Frame Compare] again to return to image frozen status; press <Freeze> to enter real-time imaging.

12.6 Cine Saving

12.6.1 Live Capture

Live capture refers to saving the images or cines in image scanning status; after the storage, the system continues image scanning.

Live capture can be divided into 2 kinds: retrospective and prospective.

- Retrospective saving is to save the specified images before the current moment; to save the images stored in the cine memory to the system hard disk.
- Prospective saving is to save the specified images later than the current moment; to save the images to both the cine memory and the system hard disk.

The live capture time can be set in “Cine” page on the touch screen.

In imaging mode, tap [Pro Capture] / [Retro Capture] on the touch screen or press the user-defined key for “Save Cine (Prospective)/(Retrospective)” on the control panel.

TIP:

- Press the save key again or <Freeze> to stop saving.
 - When a saving is completed, a thumbnail is showed in the Thumbnail area.
-

12.6.2 Frozen image storage

In frozen mode, tap [Pro Capture] / [Retro Capture] on the touch screen or press the user-defined key (The key has already been assigned the function as “Save Clip retrospective or prospective”).

After the cine is successfully saved, there is a thumbnail displayed on the screen.

12.7 Setting Cine Length

NOTE:

The system ends up saving if the cine length goes beyond the maximum value.

12.7.1 Live capture

Prospective Cine Length

Prospective cine duration: set the time that the user taps [Prospective] as the start time. The system proceeds saving the cine.

- With the ECG disabled: tap [Cine] tab, and use [Time (Pro)] to adjust it.
- With the ECG enabled: tap [Cine] tab. Tap [Saving type (Post)] to choose the type of the saving time and the cardiac cycles. Use [Time (Post)] or [Cycle (Post)] to adjust it.

Retrospective Cine Length

Retrospective cine duration: set the time that user taps [Retro] when playing the first frame of the image. It also refers to saving the cine or cycles retrospectively.

- With the ECG disabled: tap [Cine] tab, and use [Time (Retro)] to adjust it.
- With the ECG enabled: tap [Cine] tab. Tap [Saving type (Retro)] to choose the type of the saving time and the cardiac cycles. Use [Time (Retro)] or [Cycle (Retro)] to adjust it.

12.7.2 Freeze storage setting

The first frame of the image starts when the user presses <Freeze> at the first time. The system saves the cine in the auto review scope retrospectively.

Press <Freeze> to freeze the image. Use [Time (Retro)] to set the cine time of retrospective saving in frozen status under Cine page, or mark the start frame in the auto review scope to set the cine time of retrospective saving in frozen status.

TIP:

It is only available to save the cine retrospectively in the frozen status.

This page intentionally left blank.

13 Measurement, Comments and Body Mark

13.1 Measurement

There are general measurements and application measurement. You can perform measurements on a zoomed image, cine reviewing image, real-time image, or frozen image. For measurement details, please refer to the *Advanced Volume*.

WARNING

- Be sure to measure areas of interest from the most optimal image plane to avoid misdiagnosis from inaccurate measurement values.
 - To obtain accurate Doppler flow measurement values, make sure the transmitting beam is not perpendicular to the flow, otherwise false readings and potential misdiagnosis may result.
-

CAUTION

- If an image is unfrozen or the mode is changed during a measurement, the calipers and measurement data will be cleared from the screen, but the measurement data will be stored in the report.
 - If the system is turned off or [End] is selected during a measurement, the data not saved will be lost.
 - In Dual-B imaging mode, the measurement results of the merged image may be inaccurate. Therefore, the results are provided for reference only, not for confirming a diagnosis.
-

Measurement Accuracy

Table 13-1 Error of 2D Images

Parameter	Value Range	Error
Distance	Full screen	Within $\pm 3\%$
Area	Full screen	Within $\pm 7\%$
Circ	Full screen	Within $\pm 10\%$
Angle	Full screen	Within $\pm 3\%$
Volume	Full screen	Within $\pm 10\%$

Table 13-1 Error of 2D Images

Parameter	Value Range	Error
Distance (iScape)	Full screen	Within $\pm 5\%$ (for linear, wide-convex, and phased probes)
	Full screen	Within $\pm 10\%$ (for micro-convex probes)

Table 13-2 Time/Motion Measurements

Parameter	Value Range	Error
Distance	Full screen	Within $\pm 3\%$
Time	Timeline Display	Within $\pm 2\%$
Heart rate	Timeline Display	Within $\pm 4\%$
Velocity (PW mode)	10-200 cm/s (for non-transcranial application)	When angle $\leq 60^\circ$, $\leq 5\%$
	10-300 cm/s (for transcranial application)	Within $\pm 20\%$
Velocity (CW mode)	10-200 cm/s (for non-transcranial application)	When angle $\leq 60^\circ$, $\leq 5\%$
	10-300 cm/s (for transcranial application)	Within $\pm 20\%$

Table 13-3

Function	Measurement item	Error
Smart IVC	Dmax	Within $\pm 10\%$
	Dmin	Within $\pm 10\%$
	CI	Within $\pm 10\%$
	DI	Within $\pm 10\%$
	IVCV	Within $\pm 10\%$
Smart VTI	LVOT Vmax	Within $\pm 10\%$
	LVOT VTI	Within $\pm 10\%$
	LVOT HR	Within $\pm 10\%$
	LVOT SV	Within $\pm 10\%$
	LVOT CO	Within $\pm 10\%$
Smart B-line	Percent	Within $\pm 10\%$
	Dist	Within $\pm 10\%$
	Avg Dist	Within $\pm 10\%$
	B lines	0
Smart FHR OB1	/	Within $\pm 10\%$

Table 13-3

Function	Measurement item	Error
Auto GA	/	Within $\pm 10\%$
Smart Bladder	/	Within $\pm 10\%$
Auto DFR	/	Within $\pm 20\%$

NOTE:

Within the selected field range, the measurement accuracy is ensured within the range mentioned above. The accuracy specifications are performance in the worst conditions, or based on the real test for the system, regardless of acoustic speed error.

13.2 Comments

Comments can be added to an ultrasound image to bring attention, note or communicate information observed during the examination. You can add comments to: zoomed image, cine review image, real-time image, frozen image. You can type the character as comments; insert the pre-defined comments from the comment library; insert arrow markers or add the trace.

For products equipped with the trackpad, set user-defined keys for comments (text, arrow and trace) first, see “4.1.7 Key Configuration”.

WARNING

You must ensure that the entered comments are correct. Incorrect comments may lead to misdiagnosis.

13.2.1 Adding Comments

Adding an Comments Text

Perform the following procedure:

1. Select <ABC> button > [Comments] tab or press the user-defined key for “Annotation” to enter the comment status.
2. Use the trackball/trackpad or press direction-control keys on the soft keyboard to move the cursor to the desired location for comments.
3. Do one of the following to add a comment:
 - Tap the desired comment text on the touch screen, the system adds the selected comment text onto the screen where the cursor is anchored, you can edit the comment directly.
 - Type the alphanumeric characters through the soft keyboard.

In the edit status, tap [Enter] to move the cursor to the new line, and the location of the cursor is aligned with that of the first line

4. In comments edit status, press <Set> or <Enter> key, or move the cursor to confirm the added comments text and exit the edit status.

Adding an Arrow

You can add an arrow to a location where you want to pay attention.

Perform the following procedure:

1. Select <ABC> button > [Comments] > Arrow button or press the user-defined key for “Arrow” to enter the arrow status.
2. Adjust the position and orientation of the arrow:
 - Use the trackball/trackpad to move the arrow to the desired position.
 - Rotate the <Angle> knob to change the arrow’s orientation.

If needed, tap [Advanced Settings] to enter comment property screen to set the arrow style/size.

3. Press <Set> to anchor the arrow position.
Repeat steps above to add more arrows if necessary.
4. Press <ABC> or the user-defined key for “Arrow” to exit the arrow comment status.

Trace

In comment status, tap [Advanced Settings] > [Trace] on the touch screen to activate trace function, and the current image is also displayed on the touch screen.

Using the control panel:

1. Use the trackball/trackpad to move the cursor to a desired position, and press <Set> to confirm the start point.
2. Use the trackball/trackpad to move the cursor along the edge of the desired region and trace the outline of the region.
 - Rotate the <Angle> knob counter-clockwise to cancel 1 pixel of trace.
 - Rotate the <Angle> knob clockwise to restore 1 pixel of trace.
 - Short press <Clear> to clear last trace. Long press <Clear> to delete all tracing.
3. Press <Set> to finish the tracing.

Using the touch screen:

1. Trace around the ROI by tapping the touch screen image using your finger.
2. Remove your finger to finish the tracing.
 - [Clear]: tap to delete the trace in reverse order one by one.
 - [Clear All]: tap to delete all traces.
3. Tap [Exit] to exit the tracing.

13.2.2 Moving Comments

TIP:

If image size and position changed due to display format switching, then the position of the comment can be changed, too.

Perform the following procedure:

1. Select the comment to be moved.
2. Use the trackball/trackpad to move the comment to the new position.
3. Press <Set> key to anchor the comment in the new position, and the comment-moving operation is complete.

13.2.3 Editing Comments

Modifying characters

Perform the following procedure:

1. In comment status, move the cursor onto the comments to be modified.

Press alphabetic keys to enter the character to the cursor position directly.

Or, double press <Set> to enter comment editing status, and use the direction-control keys to move the cursor to the desired location to insert/delete characters; you can either type characters by pressing the corresponding keys or select the new comment text from the menu.

2. Press to delete the comment character or text on the right side of the cursor; press <Back> to delete the comment character or text on the left side of the cursor.
3. Press <Set> key, or move the cursor to confirm the added comments text and exit the edit status.

If there are already comments on the screen, press the space bar to enter editing status.

Modifying Arrows

Perform the following procedure:

1. Move the cursor on the arrow that needs to be modified. After the cursor becomes , press <Set>. There is a frame around the arrow, indicating the arrow can be edited. Move the cursor to change the arrow position.
2. Rotate the <Angle> knob to modify the arrow's direction.
3. Press <Set> key to complete the operation.

13.2.4 Deleting Comments

Deleting Comments Characters, Texts or Arrows

Perform the following procedure:

1. Move the cursor to the comments to be deleted.
2. Press <Set> to select the comment.
3. Tap [Delete Word] or press <Clear> to complete the deletion.

Deleting a recently-added character, text or arrow

In comment status, press <Clear> to delete the latest added/modified comment unit.

Enter letters by pressing the alphanumeric key on the keyboard and use blank key to divide the letters. Tap [Delete Word] to delete latest added/modified comment unit and enter comment status.

Delete letters one by one

In comment editing status, tap <Back> to delete letters before cursor “|”.

In comment editing status, tap to delete letters after cursor “|”.

In comment status, enter letters by pressing the alphanumeric key on the keyboard. Tap [Delete Word] to delete letters before cursor “|”.

Erase All Text

NOTE:

- When no item is selected, press <Clear> will clear all comments and all measurements calipers.

- After powering off, the system will clear all comments on the image.
-

Long press <Clear> key to delete all the comments.

13.2.5 Setting the Start Position

Perform the following procedure:

1. Select <ABC> > [Comments] or press the user-defined key for “Annotation” to enter the comment status.
2. Move the cursor to the target position, then press <Set Home> to set the start position of the comment.

Tap <Home> on the touch screen; the cursor returns to the start position.

13.3 Body Mark

NOTE:

After powering off, the system will clear all comments on the image.

The Body Mark feature is used for indicating the exam position of the patient and transducer position and orientation.

You can preset the system configured general body marks for each exam mode. The system supports the import of user-defined body marks.

For products equipped with the trackpad, set user-defined keys for bodymark first, see “4.1.7 Key Configuration”.

13.3.1 Adding Body Mark

Perform the following procedure:

1. Press  or the user-defined key for “Body Mark” to enter the Body Mark status.
2. Tap the desired body mark on the touch screen directly.
3. To adjust the probe position and orientation marker:
 - Use the trackball/trackpad to place the probe marker at the correct position.
 - Rotate <Angle> to adjust the mark’s direction.
 - Tap [Save Probe] to save the current direction and position for the probe mark of the current body mark.
4. Press <Set> to confirm the position and orientation of the probe marker and exit the body mark mode.

13.3.2 Moving Body Marks

You can move the body mark graphics to any desired position within the image area.

NOTE:

In Dual B Mode, a Body Mark cannot be moved between the separate image windows.

Perform the following procedure:

1. Press <Cursor> and move the cursor onto the body mark. The cursor then becomes , indicating you can move the Body Mark graphic to a new position.

2. Press <Set> key to select the body mark.
3. Move the Body Mark graphic to the desired position.
4. Press <Set> key to anchor and confirm the new graphic position.

13.3.3 Deleting Body Marks

TIP:

- Preset returning, switching the exam mode/patient/probe will clear the body marks.
 - Set if body mark is erased when the image is unfrozen, see “4.1.4 Application”.
-

Perform the following procedure:

1. Press <Cursor> and move the cursor onto the body mark. The cursor then becomes .
2. Press <Clear> to delete the body mark.

This page intentionally left blank.

14 Patient Data Management

An exam record consists of all information and data of one exam.

An exam record consists of the following information:

- Patient basic information and exam data
- Image files
- Report

NOTE:

- DO NOT use the internal hard drive for long-term image storage. Daily backup is recommended. External storage media is recommended for archiving images.
 - The system patient database space is limited, please back up or clear patient data in time.
 - Mindray is not responsible for lost data if you DO NOT follow suggested backup procedures.
-

14.1 Image File Management

You can store the image files either in the patient database in the system, or to external memory devices. For a save image, you can perform operations like image reviewing, analyzing and demonstration.

14.1.1 Storage Media

System supported memory media including:

- System hard disk
- USB memory devices: USB flash drive, removable USB hard disk
- Optical disk.

14.1.2 Image File Formats

The system supports file formats which belong to the system and file formats which are PC-compatible.

System-relevant formats

- Single-frame image file (FRM)
Refers to single-frame static image files not to be compressed; you can perform measurements and comments adding on this type of files.
- Cine file (CIN)
System-defined multi-frame file format; you can perform manual or auto cine review, and perform measurements or add comments for the reviewed images. After you open a stored CIN file, the system automatically enters cine review status.

PC-compatible formats

- Screen file (BMP)

- Single-frame file format, used to save the current screen, non-compressed format;
- JPG: Single frame export format.
- TIFF: Single frame export format
- Multi-medium files
Multi-frame export format.
- DICOM files
DICOM standard files format, single-frame or multi-frame format, used to record patient information and images; you can only open DCM files to view rather than to edit.

14.1.3 Image Storage Setting

- Set the image size, see “4.1.3 Image Preset”.
- Set cine saving length, see “12.7 Setting Cine Length”.
- Set send/print image after end exam, see “4.1.2 General”.
- Set user-defined key and auxiliary output function, see “4.1.7 Key Configuration”.

14.1.4 Quickly Saving Images to the System

To save a single-frame image to the system quickly

Press the user-defined key for “Save Image” to save the image.

- The image format is FRM in the imaging interface.
- When a dialog box is displayed on the current screen, press the user-defined key to save the screen in the BMP format.

To save cineloop image to the system quickly

Press the user-defined key for “Save Cine (Retrospective/Prospective)” to save the cine file in the default file directory in the CIN format.

The thumbnail of this image will appear in the thumbnail area on the screen. When you move the cursor onto the thumbnail, its file name with suffix will be displayed.

Quickly Saving Full Screen Image to the System

Press the user-defined key for “Full Screen” to save the image. The format of the image is PNG.

The full screen image is saved to the default path with the default name. The thumbnail of this image will appear in the thumbnail area on the screen. When you move the cursor onto the thumbnail, its file name with suffix will be displayed.

14.1.5 Saving Images to USB Flash Drive

Press the user-defined key for “Save Image to USB Disk” to save the image to the USB flash drive.

14.1.6 Exporting Cine File to USB Flash Drive

Use the user-defined key to export the cine to the USB flash drive (not saved to the local path).

The file is stored in the directory: X (USB flash drive name): patient name+ ID\exam type + exam time \ image ID.

1. Perform the scan and freeze the image.
2. Press the user-defined key for “Send Cine to USB Disk” to save the images to the USB flash drive.

14.1.7 Auxiliary Output Function

For the following three functions, the system provides auxiliary output function setting: “Save Image”, “Save Cine (Retrospective)” and “Save Cine (Prospective)”. When the corresponding user-defined key is pressed, the ultrasound system can perform multiple operations one by one as per the preset.

Taking “Save Image” as an example, add the auxiliary functions “Send Image to DICOM Storage” and “Send Image to USB disk”, press the user-defined key, then the system will perform three steps:

1. Save the image to the local hard disk.
2. Send image to DICOM Storage server.
3. Send the image to USB disk.

14.1.8 Thumbnails

The stored images or cineloops are displayed in the form of thumbnails on the screen:

- During image scanning, thumbnails of the current exam display in the Clip board/Thumbnails Area of the screen.
- In the iStation screen, the thumbnails of the current selected patient display at the bottom of the screen. When you move the cursor onto a thumbnail, its name and format will display.
- On the [Review] page, the thumbnails refer to the images stored in the same exam. When you move the cursor onto a thumbnail, its name and format will display.
- On the Review page, open images to enter the image analyzing status, all the thumbnails belong to the exam are displayed.

14.1.9 Image Review and Analysis

The system supports the image review and analysis to the saved patient image.

To review images

You can review all images stored in an exam, and send, delete or analyze the stored images.

- During image scan, saved image thumbnails will display on the right of the screen. Move the cursor onto a thumbnail, and press <Set> twice to open the image. The [Review] page display in the touchscreen to display the image file, double click the image in the touchscreen to open the image; if the stored image is a cine file, double-click the thumbnail to enter the auto cine review.
- To enter image review:
 - Tap [Review] to enter review page. Images of the current exam and the current patient are displayed.
 - Select an exam of a patient in the iStation screen, and click <Review> or double-click the exam to enter the Review screen to review the images of the patient.

Analysis

In the image analysis status, you can view, zoom, perform post processing and measurements, add comments and perform cine review for a stored image (FRM or CIN format). The operation steps are the same as those for real-time scanning; please refer to relevant sections for details.

1. To enter image analysis:
 - In the image scanning or freeze status, double-click a thumbnail stored in this exam to enter the image analysis status; or

- In the image review status, double-click the selected thumbnail to open the image.

You can perform cine review operations in image analysis status.

2. To exit the image analysis:

- Press <Freeze> to exit and enter the real-time scan status.
- Press [Return] to exit from the image analysis to the Review status. In image analysis status, the selected image is displayed on the screen, and the thumbnails of the same exam are displayed on the thumbnail area, you can turn pages using the buttons on the right side of the thumbnail.



14.1.10 Sending Image File

NOTE:

Data saved this way can only be reviewed on the PC and cannot be restored to the ultrasound system.

Perform the following procedure:

1. Do one of the following to bring up the “Send To” screen:

- In the main screen, select a stored image thumbnail and click  on the upper right corner of the image.
- In the iStation screen, select a stored image thumbnail and click  on the upper right corner of the image.
- In the Review screen, select a image and click [Send to].

2. Select from the destination:

Item	Description
USB/iStorage	For external memory devices (e.g. USB memory devices, DVD recorder) or network storage server, you can set: <ul style="list-style-type: none"> • PC format transfer. • DCM format transfer • Cine Zoom Mode. • Export the report or the report format. • Hide patient information.
DICOM/Print/eGateway	Select the DICOM Storage, Print server or eGateway server.
MedTouch/MedSight	Send the image to MedTouch/MedSight as necessary. NOTE: The file sent to MedTouch/MedSight is transferred into PNG format, and the cine file is transferred into AVI format.

NOTE:

If the transferred AVI file cannot be played normally on PC, please try to transfer the multi-frame cine file in MP4 format and try Send To function again, or use a VLC media player.

14.2 Report Management

14.2.1 Report storage

The exam reports are stored under the directory of the exam of the patient.

14.2.2 Importing, exporting and sending a report

Import/export report via Backup

In iStation screen, select patient data, click [Restore Exam] or [Backup Exam] in the popped up menu to import or export patient information, images and reports from or to an external memory device.

Perform the following procedure:

1. Click to select patient data, and click [Restore Exam] or [Backup Exam].
2. Select the destination.
3. Select whether to remove from local HD after Backup:
 - If “Remove Exams” is selected, the patient information and images are removed.
 - If “Remove Images” is selected, only the patient images are removed.
4. Select whether to hide the patient information.
5. Select whether to encrypt backup exams for USB only: input the password and confirm password in the field box. Click [Backup], a “Patient.7z” compressed package is backed up to the USB device, and you need to input the password to open the package.

NOTE:

- If the password is forgotten, you cannot open the backup package.
- The password cannot be multi-language or Chinese characters.

Export report via Send To

In the iStation or Review screen, click [Send Exam] or [Send to] to send patient data to an external memory device (USB disk or disc) or network storage, you can choose if reports are exported.

Perform the following procedure:

1. Check “Export Report” on the screen.
2. Select report type to be exported.
3. Click [OK] to confirm.

The size of the report can be set, see “4.9 Print Preset”.

14.3 Patient Data Management (iStation)

The patient data include basic patient information, exam information, image files and reports. You can search, view, backup, send, restore, delete or export patient data in iStation.

Do one of the following to enter iStation:

- Tap [iStation] on the exam main screen.
- Click [iStation] in the Patient Info screen.
- Click [iStation] in the Review screen.

14.3.1 Searching a Patient

Perform the following procedure:

1. Select the data source.
Click [Data Source] to select the data source of patient data, the system patient database is default.
2. Set search conditions in the “Item” drop-down list.
3. Enter the key word. The matching patient information is displayed in the patient list.
4. When you select a patient in the patient list, the images of this patient will be displayed at the bottom of the screen.

14.3.2 Patient Data View & Management

Select the desired patient information in the list.

Item	Description
Review an image	Select an exam of a patient, click [Review Image] to enter Review screen.
Patient Information	Select an exam of a patient, click [Patient Info] to check the patient information of this exam.
Review Report	After you select an exam of a patient, click [Review Report] to view the report of this exam for this patient.
Delete Exam	<ul style="list-style-type: none"> • Select the patient record. Click [Delete Exam] to delete the exam. However, you cannot delete patient data being printed, exported or sent, or delete the current exam. • To delete an image, select the image and click  on the right side.
Backup Exam	<p>You can back up the selected patient data to the system-supported media in order to view it on PC, or restore the patient data to the system from an external media. The exam after being backed up can be restored to the system for another review. Click to back up the selected patient data to the system-supported media.</p> <ul style="list-style-type: none"> • Original format: to back up the data in original format. • DICOM format: you can change the cine compression mode, and JPEG compression mode. • You can select whether to remove images or the whole exam record from the system.
Restore Exam	Click to import the patient data from an external media.
Send Exam	<p>You can use this function to export the exam data to external devices (in PC data or DICOMDIR data format) and then import to PC or restore to the ultrasound system to review the data.</p> <ol style="list-style-type: none"> 1. Select the patient record, click [Send Exam] in the menu to send exam data or images of the selected record. 2. Select from the destination, and set related settings.
Activate an Exam	<p>After you select an exam, which has been performed within 24 hours, click [Activate Exam] to activate the exam and load the basic patient information and measurement data to continue the exam.</p> <p>If you want to select a patient data in an external memory database to start a new exam or recover the exam, you have to first allow the system to load the patient data to the system’s patient database.</p>

Item	Description
Continue an Exam	<p>Select an exam that is paused within 24 hours, click [Continue Exam] to activate the exam and load the basic patient information and measurement data to continue the exam.</p> <p>If you want to select a patient data in an external memory database, you have to first allow the system to load the patient data to the system's patient database.</p>
Annotation an exam	<p>Select an exam and click [Annotation Exam] to add annotation.</p> <p>In the popped-up screen, you can also review the history annotations for the selected exam.</p>

14.4 Recycle bin

The recycle bin is used to store deleted patient data, exam data and images.

The system supports recovery of these data from the recycle bin.

Click  at the lower right corner of the screen (when the button is gray, the operation is unavailable) to enter the Patient Recycle Bin screen.

To recover the deleted patient data

NOTE:

If the capacity of the recycle bin exceeds 200. The system reminds the user to clean. Follow the procedures below to clean the recycle bin.

Perform the following procedure:

1. Select items to be recovered in the list.
2. Select operations:
 - Click [Restore Items] to restore the item back to iStation.
 - Click [Delete] to delete the item permanently, and the item can never be restored again;
 - Click [Restore All Items] to restore all the items back to iStation;
 - Click [Empty Recycle Bin] to empty the recycle bin and all items can never be restored again.
 - Click [Exit] to exit the recycle bin.

To set maximum number of days or deleted data to be kept in the recycle bin

NOTE:

The patient exams which exceed the preset maximum will be deleted and unrecoverable, it is recommended to perform patient data backup before enabling this function to avoid data loss.

Perform the following procedure:

1. Input the desired number besides “Maximum number of days to be kept”.

If the input box is left blank, the feature will not be enabled.

Only the whole number ranging from 1 to 365 can be input.
2. Click [Modify].

14.5 iStorage

TIP:

To use iStorage function, you need UltraAssist software in 2.0 version (with V1.0 network protocol); consult Mindray service engineer for details.

Network storage is used to save image files and measurement reports to the remote PC server.

For network storage setting, see “4.8.2 iStorage Preset”.

1. Enter iStation, select one (or more than one) patient data or image in the local data source.
2. Click [Send Exam].
3. Select [iStorage] in the Send To dialog box, and select the PC server of the right side.
4. Select PC transfer format and check whether to send report.
5. Click [OK] to start sending.

14.6 Print

For printer connection, see “3.8 Installing a Printer”.

For user-defined key for printing and video output settings, see “4.1 System Preset”.

14.6.1 Image Print

For DICOM image printing, refer to relevant chapters. Video printer is applied in image print service.

Perform the following procedure:

1. Select the desired image in iStation or Review screen.
2. Click  icon on the upper right side of the image, and select the printer in the popped up dialog box.
3. Click [OK] to start printing.

Please refer to the accompanying manuals of the printers for more details.

14.6.2 Report Printing

Both reports and images can be printed on a graph/text printer. For detailed information about the report printing, see *Advanced Manual*.

14.7 Back up Files using the DVD Drive

 CAUTION

During the backup process, if a CD/DVD is forcibly taken out or you perform other operations, the backup process will fail or the system may malfunction.



TIP:

- Writing data using “Send To” supports the PC format transfer function, while CD/DVD writing using “Back Up” supports only system-relevant formats.

- The  symbol indicates that the input CD/DVD is damaged or contains data in an incorrect format.

The system supports writing data to CD/DVD using the DVD-RW/DVD+RW drive and reading data from CD/DVD on the PC.

Perform the following procedure:

1. Put a CD/DVD in the tray.
2. Select the data to be backed up. Select [Send Exam] or [Back up Exam] in the menu which appears. Select the target drive in the Send To or Back Up Patient Record dialog box.
3. Click [OK] or [Back up] to begin writing when the  symbol displays.
4. After the writing process is complete, click  to bring up the Disc Option dialog box, and select [Eject] to eject the CD/DVD.

14.8 Patient Task Management

Click  in the bottom-right corner of the screen to bring up the Task Management dialog box.

Storage Task

Displays the DICOM storage task.

DICOM Print Task

Displays the DICOM print task.

Media Storage Task

- DICOM media storage task (including disc and USB devices): In iStation screen, select the target exam and click [Send Exam], then click DICOMDIR in the menu which appears.
- Back up task (system-relevant format): Select the exam to be backed up in iStation and click [Back Up Exam].
- Send to external devices (including disc and USB devices): Select exam data or images in the iStation or Review screen. Click [Send Exam] for the image.
- iStorage task: In iStation screen, select the target exam and click [Send Exam], then click iStorage in the menu which appears.
- MedTouch/MedSight storage task:
 - In iStation screen, send exam to MedTouch/MedTouch devices.
 - In Review screen, iStation screen, thumbnail area, send the image(s) to MedTouch/MedSight devices.

Print Task

Displays image or report printing tasks.

In the Task Management dialog box, the patient ID, name, destination, progress, type, contents and task created time are displayed.

You can perform the following operations:

- Click [Delete] to delete the task.
- Click [Retry] to retry the failed task.
- Click [Select All] to select all the tasks.

Task Status

When there are tasks underway, the task management icon displays as . Click the icon to check the process.

When tasks have failed, the task management icon displays as . Click the icon to check the reason for the failure.

When the task management icon displays as , it means no task is underway or has failed.

DICOM Service Setting

On the Storage Task and DICOM Print Task page, click [Service Setting] to enter the DICOM service setting screen. For details, see “4.7 DICOM/HL7”.

Troubleshooting

If a serious error occurs, such as network disconnection or operation timeout, the system can try to reconnect the network. The interval time and maximum retries can be set as desired. For details, see “4.7.2 DICOM Service Preset”.

14.9 V-Access

The ultrasound system can be used to log on to a remote server to check or modify patient data on the server.

Perform the following procedure:

1. Press the user-defined key for “V Access” to use the function.

The system brings up a dialog box for entering the IP address of the remote server.

2. Enter the IP address and click [OK].
3. Log on with the server account and password.
4. Check the data transferred and carry out operations as necessary.

After logging in to the remote server, you can switch from the Ultrasound System and the remote server as follows:

- a. Click [Minimize] to exit the remote server and enter the Doppler interface.
- b. Press the user-defined key for “V-Access” to enter the remote server again.

14.10 Q-Path

You can use the ultrasound system to check data on browser directly. After you have ordered storage service of a network website service, you can check data using the website, authorized account and password (provided by the service vendor). You can open the browser to review previously sent DICOM data. For Q-Path settings, see “4.8.5 Q-Path Preset”.

Perform the following procedure:

1. Send stored images or worksheet reports from iStation/Review/thumbnail area to the Q-Path server.
2. Press the user-defined key for “Q-Path” to enable the function.
3. Log in to the Q-Path server through the Q-View browser to check the stored images and worksheet reports.
4. Click [Esc] to exit the Q-View browser.

15 DICOM/HL7

NOTE:

Before using DICOM, please read the electronic file DICOM CONFORMANCE STATEMENT along with the device.

TIP:

The DICOM package is optional, so the description here is only applicable for the system configured with the DICOM package.

This system supports the following DICOM functions:

- Verify Connectivity
- DICOM Storage
- DICOM Print
- DICOM Worklist
- MPPS (Modality Performed Procedure Step)
- Storage Commitment
- Query/Retrieve
- Structured Report
- DICOM Medium Storage (DICOMDIR Review)
- DICOM Task Management

If all the DICOM presets on the DICOM Service Preset screen are completed, you are ready for the Storage, Print, Worklist (HL7 Query), MPPS, Storage Commitment and Query/Retrieve applications. For detailed information about DICOM presets, see “4.7 DICOM/HL7”.

15.1 DICOM Storage

DICOM Storage is used to send images (single-frame or multi-frame) or structured report to the DICOM storage server for storage.

15.1.1 Send images on iStation/Review/main screens

Perform the following procedure:

1. Do one of the following to select images:
 - Tap [iStation] on the exam main screen to enter the iStation page. Click to select a patient or an exam record in the list. Thumbnails are displayed in the thumbnail area in the lower part of the screen, and then click to select a thumbnail or the cine. Or, select an exam or exams from the patient list (there should be images for this exam).
 - Tap [Review] on the exam main screen to enter the Review screen. Click to select a thumbnail or the cine.
 - On the main screen, select a thumbnail or the cine.

2. Click  in the top-right part or [Send To] to bring up the Send To dialog box.
3. Click to select “DICOM” in the Target box on the left side, then select the DICOM storage server in the Storage Server box on the right side, and click [OK].

15.1.2 To send images using a shortcut key

You can save single-frame images or multi-frame images to a DICOM server while saving to hard drive using a shortcut key.

TIP:

To define the shortcut key, for details see “4.1.7 Key Configuration”.

Start the ultrasound exam scan. Press the user-defined key to send the image or the cine to DICOM storage.

15.1.3 To send images to storage after an exam ends

TIP:

To preset Sending/printing after End Exam, for details see “4.1.2 General”.

Start the ultrasound exam scan. Tap [End] to send the image or the cine to DICOM storage automatically.

15.1.4 Encapsulate PDF

Encapsulate PDF refers to the PDF file is encapsulated in DICOM IOD.

Encapsulated PDF is sent by following the procedures below:

- Send in the unit of single exam.
- The exam with the state of End, Cancel or Stop cannot be sent as encapsulated PDF.
- Check “Encapsulate PDF” in the storage service preset.
- If there is an exam result in the report template, this type of exam should be performed.

Sending the exam or archiving the exam can send the encapsulated PDF file.

15.1.5 Unload DCM file

The image can be unloaded to DCM format and send to the storage media, iStorage.

Perform the following procedure:

1. Select the image, and click .
2. Select “Target” > “iStorage” to export the image in DCM format.
3. Click [OK] to send DCM format file to the external media

15.2 DICOM Print

DICOM Print is used to send images to the DICOM print server for printing.

15.2.1 Print images on iStation/Review/Main screen

Perform the following procedure:

1. Do one of the following to select images:

- Tap [iStation] on the exam main screen to enter the iStation page. Click to select a patient or an exam record in the list. Thumbnails are displayed in the thumbnail area in the lower part of the screen, and then click to select a thumbnail. Or, select an exam or exams from the patient list (there should be images for this exam).
 - Tap [Review] on the exam main screen to enter the Review screen. Click to select a thumbnail.
 - On the main screen, select a thumbnail or the cine.
2. Click  in the top-right part or [Send To].
 3. Click to select “DICOM” in the Target box on the left side, then select the DICOM print server on the right side, and click [OK].

15.2.2 To send images to DICOM Print after an exam ends

TIP:

Preset Sending/printing after End Exam, for details see “4.1.2 General”.

Start the scan and obtain the image. Each time [End Exam] is tapped, the system will send the image to the default DICOM print server for printing.

15.3 Worklist

When the DICOM basic package is configured and the Worklist server has been set, click [Worklist] in the “Patient Info” screen to query or import the patient data.

The system supports: DICOM, HL7 and eGateway.

Perform the following procedure:

1. Tap [Info] on the touch screen to enter the patient information page.
2. Click [Worklist] to enter the Worklist page.

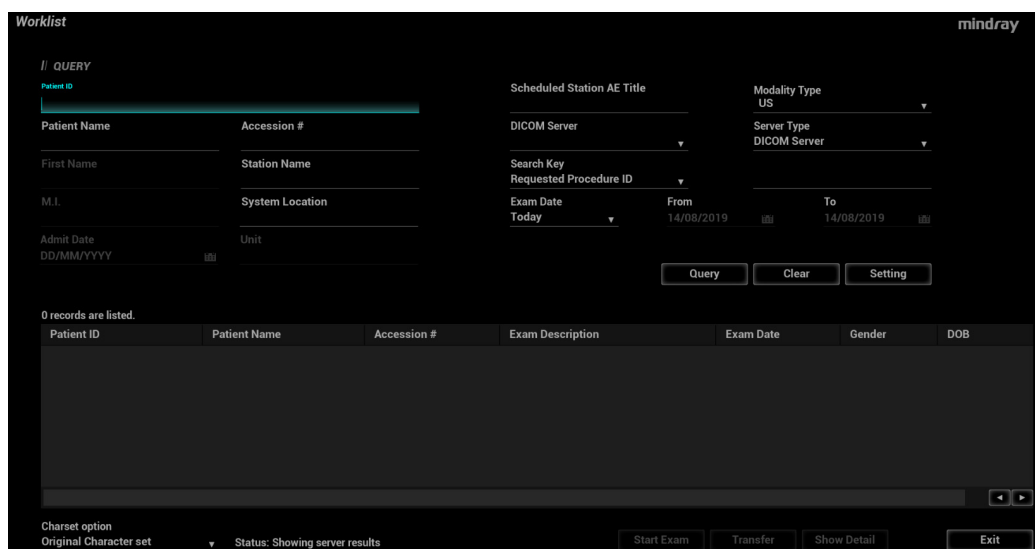

The screenshot shows the 'Worklist' screen with the following details:

- Search Fields:** Patient ID, Patient Name, Accession #, Station Name, System Location, Admit Date (DD/MM/YYYY), Scheduled Station AE Title, DICOM Server, Search Key, Requested Procedure ID, Exam Date (From: Today, To: 14/08/2019), Modality Type (US), Server Type (DICOM Server).
- Buttons:** Query, Clear, Setting.
- Table:** 0 records are listed. Columns: Patient ID, Patient Name, Accession #, Exam Description, Exam Date, Gender, DOB.
- Footer:** Charset option (Original Character set), Status: Showing server results, Start Exam, Transfer, Show Detail, Exit.

3. Guarantee the data source: after select the service type, select the worklist server from the corresponding server.
4. Input the searching condition:

- DICOM server: Search via patient ID, accession #, key words, AE title, worklist server or exam date.
 - Select HL7 server: Search via patient ID, patient name.
 - eGateway server: Search via patient ID, patient name, exam date, and so on.
5. Click [Query]. The scheduled patients, which meet the criteria, are displayed in the lower part of the screen.
- After the first query, you can perform the second query based on the preview results. The scheduled patients in the list will update in real time.
 - Enter patient ID, patient name, accession # and exam date, the system affords the result in real-time.
 - Select the keyword type, enter the keywords and then click [Query] to search.

To reset the criteria, click [Clear] button.

6. Select the desired patient from the list.
- When there is no exam,
Click [Start Exam], the patient information is imported into the system and then an exam is started.
Click [Transfer], the patient information is imported into the “Patient Info” screen and it is opened. After you edit the patient information in the “Patient Info” screen, click [OK] to start a new exam.
 - When there is a current exam,

Click [Start Exam] and a dialog box pops up.
 - Start New: Ends the current exam and creates an exam with the selected patient information.
 - Merge: Merges the selected patient information with that of the current exam.Click [Transfer] and the ‘End Exam’ dialog box pops up. Click [OK] to start a new exam.
- Click [Show Detail] to see details of patient data.
7. Click [Exit] to exit the Worklist.

15.4 MPPS

MPPS is used to send exam state information to the configured server. This facilitates the other systems in obtaining the exam progress in time.

After you preset the Worklist server and MPPS server, if the system obtains the patient information from Worklist server to begin the exam, it will send exam status information to MPPS server of when the exam is undergoing or ended. If the sending fails, the system resends automatically.

15.5 Storage Commitment

Storage commitment is used to confirm whether the images or structured reports are successfully stored on the DICOM storage server.

Before using storage commitment, set the associated storage service

If images are successfully sent to the storage server, the storage commitment server will return to the information about the successful image storage. In the iStation screen, you will see a tick “√” marked in the list below .

NOTE:

Multi-frame storage is not allowed if “Allow Multiframe” is not selected (About “Allow Multiframe” setting, see “4.7.2 DICOM Service Preset”). Even if there is a multi-frame file in the exam to be sent, only single-frame image storage will be performed. After the storage is complete, there is no “√” marked in the list of the iStation screen.

15.5.1 Storage commitment after sending images on the iStation screen

Select the image, the cine or the data, and send it, see “15.1 DICOM Storage”.

The system will send all the images stored in the exam record to the storage server. Meanwhile, it will send storage commitment to the storage commitment server.

15.5.2 To send storage commitment automatically after an exam ends

TIP:

- Preset Sending/printing after End Exam, for details see “4.1.2 General”.
 - Set the default storage server, and click “Storage Commitment” to connect to the storage server, see “4.7.2 DICOM Service Preset”.
-

Start the scan and obtain the image. Tap [End] each time; the system will send the image to the default DICOM storage server for storage and send storage commitment to the storage commitment server.

Storage commitment is confined to the whole exam. Not each image sending can be indicated.

15.6 Query/Retrieve

The query/retrieve function is used to query and retrieve patient exam records in a designated server.

After setting the DICOM query/retrieve server, you can perform the query/retrieve function in the iStation screen.

1. Tap [iStation] to enter iStation screen.
2. Click [Query/Retrieve] to open Query/Retrieve screen.
3. Select the server in the “Server and Service” area (both the source and the destination) and query level.
4. Enter the query information, such as Patient ID, Patient Name, Accession #, Exam Date or key words.
Click [Clear] to empty the entered query information.
5. Click [Query]. The system performs the query and lists the results in the patient (source) list.
You can perform further queries based on the results by entering new query information.
6. Select one or more patient records according to the actual situation.
 - Click [Select All] to select all the patient records in the list.

- Click [Deselect All] to deselect all the patient records in the list.
- 7. Click [Retrieve] to retrieve the patient records in the DICOM query/retrieve server to the local machine.
- 8. Click [Exit]. The retrieved patient records are listed in the iStation screen.

15.7 DICOM Media Storage (DICOMDIR Review)

Patient data in the ultrasound system can be saved on external media in DCM format, while DCM files can be accessed in the ultrasound system.

DICOM media storage and DICOMDIR review should meet the following conditions:

- There is a DVD disk in the ultrasound device, and it works well.
- File system format of CD/ DVD optical file should be ISO9660, and the optical disk should not be damaged.
- File system format of DVD optical file should be UDF, and the optical disk should not be damaged.
- Normally read/write data from the USB ports on the ultrasound system.
- File system format of removable device (USB flash drive) is FAT32 and the media should not be damaged.

15.7.1 Media Storage

Perform the following procedure:

1. Select patient records in the iStation screen.
2. Click [Send Exam] in the menu which appears to open the dialog box.
3. Select the destination to “DICOMDIR” and DICOM Format as well as compression mode. You can select to delete the exam or the image after the backup, and select to hide patient information.
4. Click [OK]. The image from the current exam is sent to the external storage media in DICOM format.

If the backup is successful, a tick will appear in the Backup list in the iStation screen. If not, there will be no tick.

TIP:

There must be no DICOMDIR/DCMIMG/IHE_PDI files on the external storage media of the same name as the one being backed up. Otherwise, the backup cannot proceed. Ensure there is enough storage space, or the backup may fail due to shortage of space.

15.7.2 Media review

Perform the following procedure:

1. Connect the external media with DCM files to the system.
2. Select the data source in iStation screen, and the visible data will be shown.
3. If there are several types of data on the media, the system will ask you to select the format. Then, click [DICOMDIR].

15.7.3 Data Restore

NOTE:

Only system-accessible media can be selected.

After the DICOM format data are saved to external media, restore the data to the ultrasound system.

Connect the external media containing DCM files to the system.

1. In iStation, review the data stored on the external media.
2. Select the data to be restored in iStation.
3. Click [Restore Exam] on the iStation screen.

15.8 Structured Report

The Structured Report (SR) can be sent with meeting the following procedures:

- DICOM structured report installed with the corresponding exam mode;
- The state of the SR should be “Cancel” or “Stop”.
- Set the storage option to “Attach SR When Store Images” or “Only Store SR”, see “4.7.2 DICOM Service Preset”.

Perform the following procedure:

1. Click to select a patient or an exam record in the list on iStation page, and click [Send Exam] in the iStation page.
2. Select DICOM in the storage server list, select a server in the “Storage Server” list.
3. Click [OK], the status of sending task can be viewed in task management.

After successful storage of both image and structured report; you can see the storage commitment mark “√” in the list below  on the iStation screen.

NOTE:



Only the PACS system from the Medstreaming company (<http://www.medstreaming.com/default.aspx>) supports sending self-defined measurements by DICOM SR.





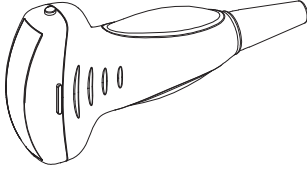
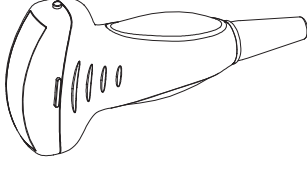
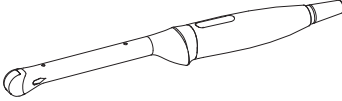

This page intentionally left blank.

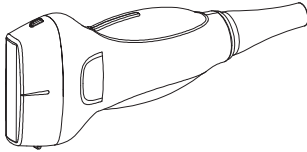
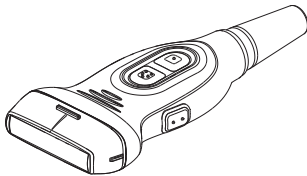
16 Probes and Biopsy

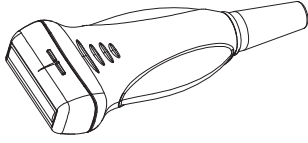
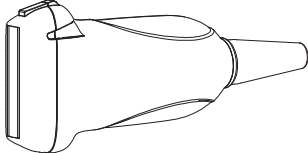
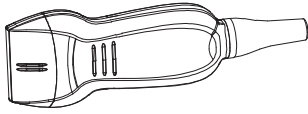
16.1 Probes

Table 16-1 Available probes

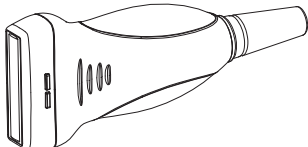
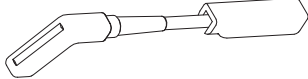
Probe Model	Region Applied	Probe Figure
C5-1s	Body surface	
SC5-1Ns	Body surface	
V11-3Hs	Intracavitary	
V11-3s	Intracavitary	
L13-3s	Body surface	
L13-3Ns	Body surface	
L12-3RCs	Body surface	

Probe Model	Region Applied	Probe Figure
L11-3VNs	Body surface	
L14-6Ns	Body surface	
L20-5s	Body surface	
P4-2s	Body surface	
SP5-1Ns	Body surface	
L12-3VNs	Body surface	
L9-3s	Body surface	
L16-4Hs	Body surface, Intra-operative	
C11-3s	Body surface	
P10-4s	Body surface	

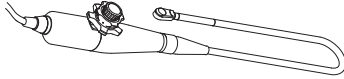
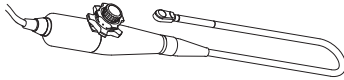
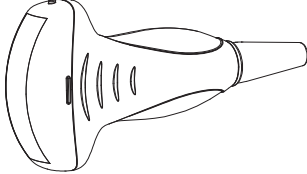
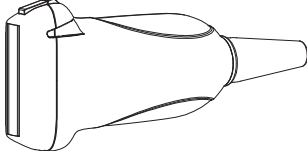
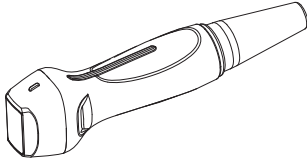
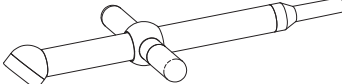
Probe Model	Region Applied	Probe Figure
P7-3Ts	Transesophageal	
P8-3Ts	Transesophageal	
C5-2s	Body surface	
L12-4s	Body surface	
P8-2s	Body surface	
CW2s	Body surface	

TIP:

Abdominal use of C5-1s, and SC5-1Ns includes gynecology application region.

16.1.1 Probe Functions by Part

The basic structures and corresponding functions of probes are basically the same; take the following probe as an example.

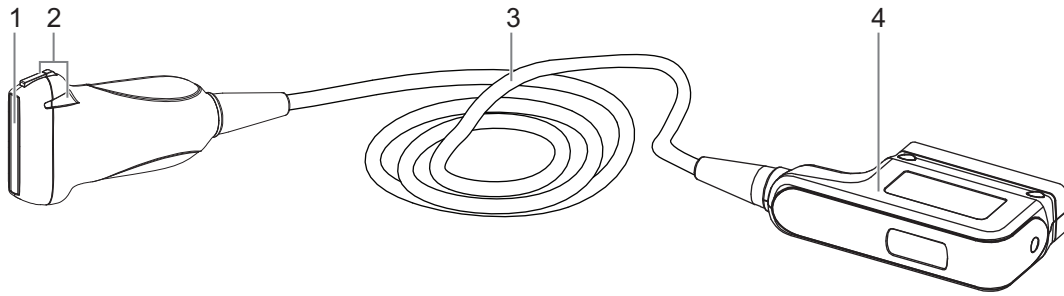

No.	Item	Description
1.	Probe head	Converts the electrical signal into an ultrasonic signal, focusing the sound beams in a given direction; meanwhile, it receives the reflected ultrasonic signal and converts it into an electrical signal for transmission over the cable. The lens on the surface is the acoustic lens. Apply ultrasound gel on the acoustic lens for correct operation.
2.	Needle-guided bracket fix tabs and grooves	Provides mounting support of the needle-guided bracket. NOTE: This structure of probes in the figure above may vary with the matched needle-guided brackets.
3.	Probe cable	Transmits electrical signals between the probe body and connector.
4.	Probe connector	Connects the probe and cable to the ultrasonic diagnostic system.

16.1.2 Orientation of the Ultrasound Image and the Probe Head

The orientation of the ultrasound image and the probe are shown as below. The “M” side of the ultrasound image on the monitor corresponds to the mark side of the probe. Check the orientation before the examination (Using a linear probe as an example).

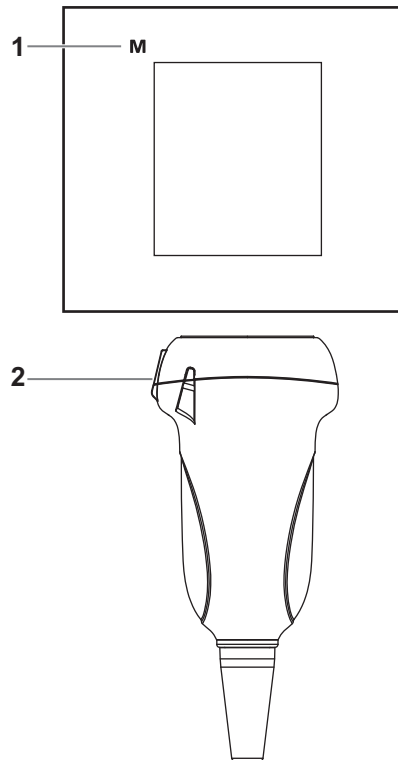

1	Orientation mark
2	Mark

16.1.3 Procedures for Operating

⚠ WARNING

Disinfect the probe and sterilize the needle-guided bracket before and after an ultrasound-guided biopsy procedure is performed. Failure to do so may cause the probe and the needle-guided bracket becomes a source of infection.

This section describes general procedures for operating the probe. The proper clinical technique to be used for operating the probe should be selected on the basis of specialized training and clinical experience.

Procedures for operating (with biopsy function)

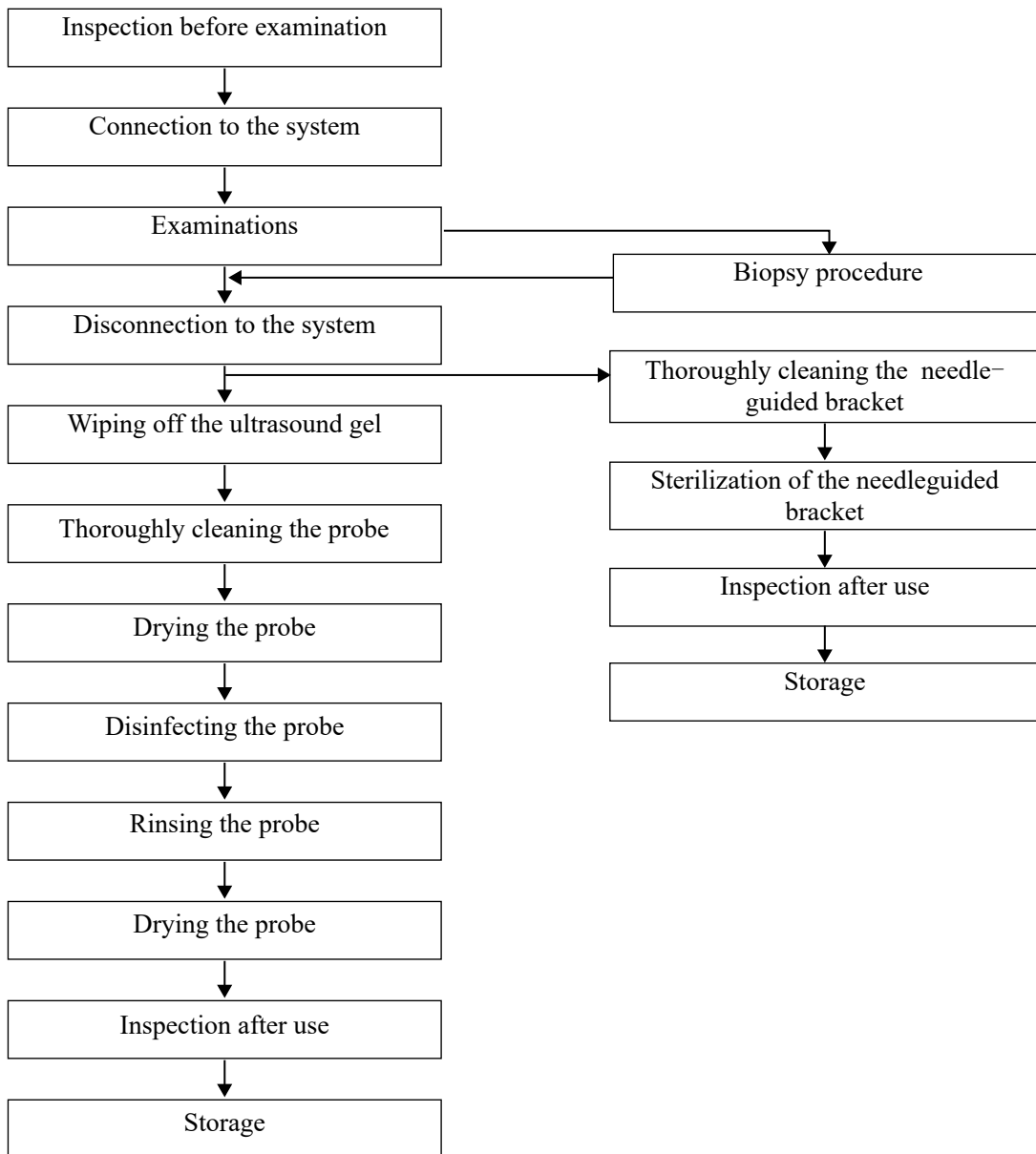

Procedures for operating (with no biopsy function)

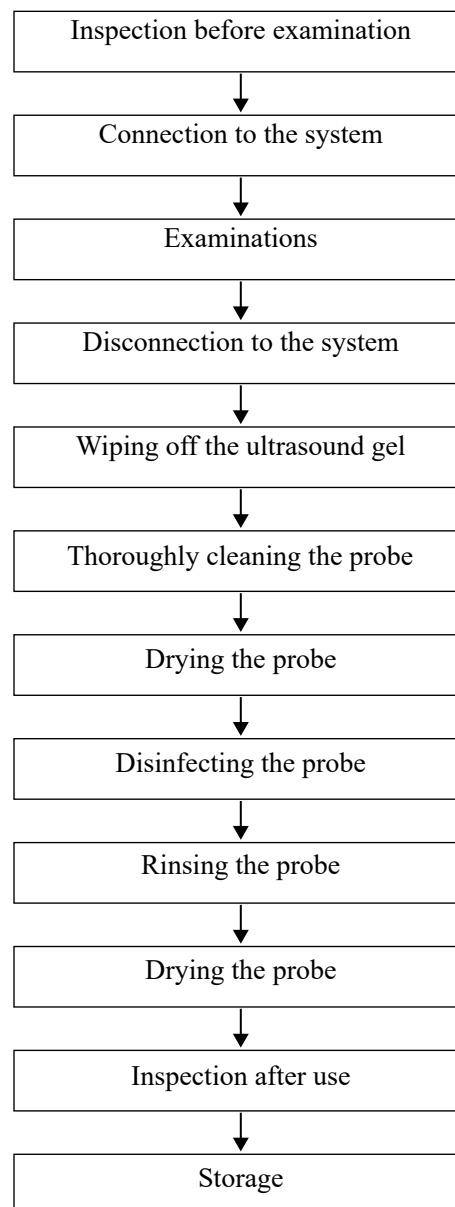

16.1.4 Wearing the Probe Sheath

⚠ CAUTION

- Be sure to cover the probe with a new (unused) probe sheath to prevent infection during examination. If the package of a probe sheath is open or broken, the sterilization of the probe sheath may not be sufficient. **DO NOT** use such a probe sheath.
- The cover contains natural rubber latex and talc that can cause allergic reactions in some individuals.
- **DO NOT** use an expired probe sheath. Before using a probe sheath, verify whether the term of validity has expired.

A legally marketed probe sheath must be installed over the probe before performing intra-cavitary and intra-operative examination. Protective barriers may be required to minimize disease transmission. Probe sheaths are available for use with all clinical situations where infection is a concern.

To order probe sheath, contact:

CIVCO Medical Instruments Co.

102 First Street South, Kalona, IA 52247-9589 USA

Tel: 1-319-656-4447

E-mail: info@civco.com

<http://www.civco.com>

Refer to the following dimension table of all probes to choose the necessary probe sheath type. You can select the probe sheath according to the actual application situation.

Probe Mode	Length(mm)	Width(mm)	Height(mm)	Cable Length(mm)
C5-1s	111.9	76.7	28	2050±50
SC5-1Ns	111.8	76.7	28	2050±50
V11-3s	317	41	33	2050±50
V11-3Hs	319.6	33	38.1	2050±50
L11-3VNs	43.3	10.4	12.6	2050±50
L12-3RCs	101.8	55.6	22	2050±50
L13-3s	101.6	61	25.7	2050±50
L13-3Ns	101.1	56.8	22	2050±50
L14-6Ns	101.6	61	25.7	2050±50
L20-5s	98	43	22.8	2260±50
P4-2s	102.7	38.1	27.8	2050±50
SP5-1Ns	102	38	30	2050±50
L12-3VNs	101.8	56.8	25.3	2050±50
L9-3s	103.5	58.6	23.3	2050±50
L16-4Hs	41.8	34.6	11.5	2050±50
C11-3s	96.4	32.8	25	2050±50
P10-4s	82.5	28.5	21.1	2050±50
P7-3Ts	1500	59.6	29	1530±50
P8-3Ts	720	63	67.8	1770±50
C5-2s	112.4	76.3	25.6	2050±50
L12-4s	101.6	61	25.7	2050±50
P8-2s	82.7	30.6	23.2	2050±50
CW2s	121.8	79.5	17.8	1950±50

The following figure is a dimension illustration of the V11-3s probe.

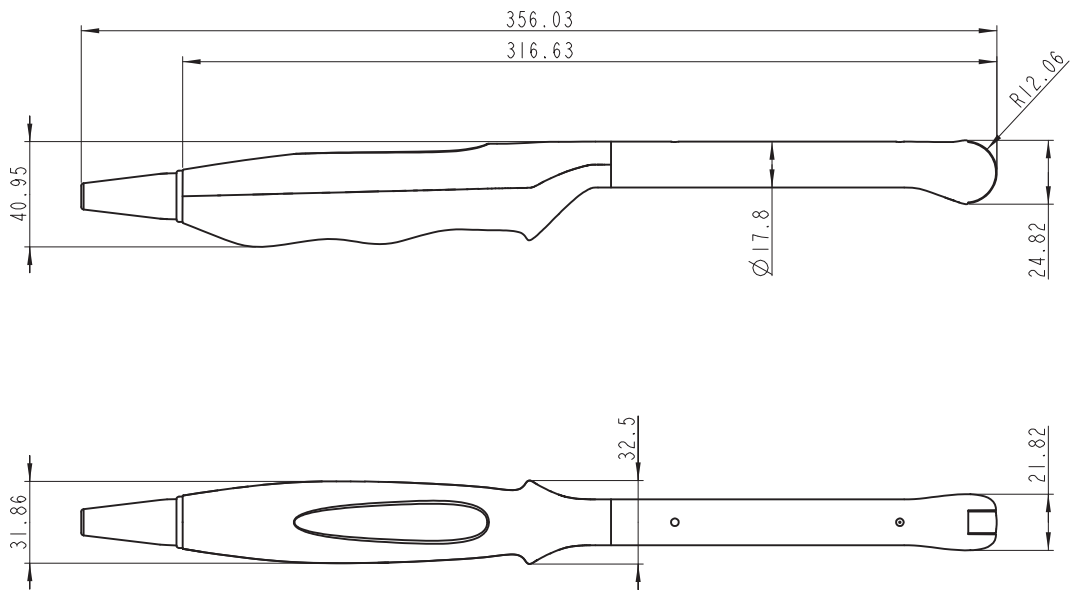

Perform the following procedure to install the probe sheath:

1. Place an appropriate amount of gel inside the sheath or on the probe acoustic lens. Poor imaging may result if no gel is used.

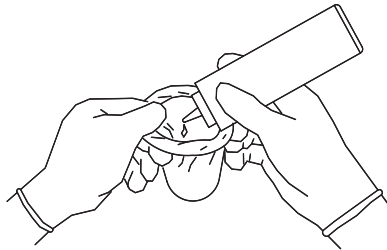

2. Insert the probe into the sheath; make sure to use proper sterile technique. Pull cover tightly over probe acoustic lens to remove wrinkles and air bubbles, and taking care to avoid puncturing the sheath.

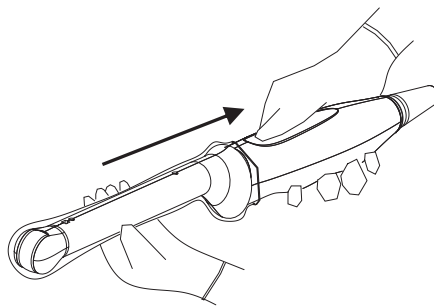

3. Secure the sheath with the enclosed elastic bands.

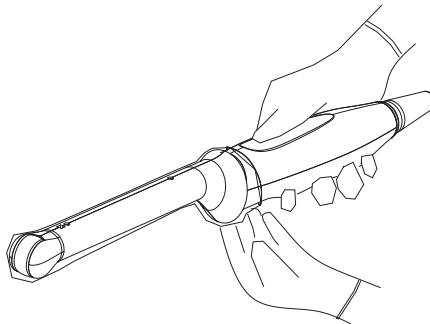

4. Inspect the sheath to ensure there is no hole or tear.

16.1.5 Probes Cleaning and Disinfection/Sterilization

Before and after completing each examination, clean and disinfect (or sterilize) the probes as required. When biopsy procedures have been performed, be sure to sterilize the needle-guided bracket. Fail to do so may result in the probe and the needle-guided bracket to becoming sources of infection. Please follow the instructions in the manual for cleaning.

⚠ WARNING

Never immerse the probe connector into liquid such as water or disinfectant. Immersion may cause electrical shock or malfunction.

⚠ CAUTION

- No cleaning and disinfecting may result in the probe becoming a source of infection.
 - Please follow the disinfectant manufacturer's manual for performing cleaning and disinfection, including preparing sterile water and cleaning and disinfection time.
-

NOTE:

- After the examination, wipe off the ultrasound gel thoroughly. Otherwise, the ultrasound gel may solidify and degrade the image quality of the probe.
 - DO NOT make the probe to become overheated (more than 55 °C) during cleaning and disinfections. High temperature may cause the probe to become deformed or damaged.
 - Observe the graph here carefully to immerse the probe. Only soak parts of the probe below the strain relief.
 - Repeated disinfection will eventually damage the probe, please check the probe performance periodically.
-

Cleaning and Disinfection/Sterilization Overview

Cleaning and disinfection refer to two distinct processes. According to the Centers for Disease Control and Prevention (CDC) "Guideline for Disinfection and Sterilization in Healthcare Facilities" (2008):

- Cleaning is the removal of visible soil (e.g. organic and inorganic material) from objects and surfaces and normally is accomplished manually or mechanically using water with detergents

or enzymatic products. Thorough cleaning is essential before high-level disinfection and sterilization because inorganic and organic material that remains on the surfaces of instruments interfere with the effectiveness of these processes.

- Disinfection describes a process that eliminates many or all pathogenic microorganisms, except bacterial spores.
 - Low-Level Disinfection—Destruction of most bacteria, some viruses, and some fungi. Low-level disinfection will not necessarily inactivate *Mycobacterium tuberculosis* or bacterial spores.
 - High-Level Disinfection (HLD)—Destruction/removal of all microorganisms except bacterial spores.
- Sterilization describes a process that destroys or eliminates all forms of microbial life and is carried out in healthcare facilities by physical or chemical methods.

Selecting a Microbicidal Method

Probes can be divided into three categories based on their intended use. Some probes may fall into more than one category (e.g. probes use for biopsy procedures). When selecting a disinfectant, determine the required level of disinfection based on intended use and possibility of cross-contamination.

- Contacts intact skin: Probes that only come into contact with clean, intact skin are considered noncritical devices and require cleaning after every use. Cleaning may be followed by a low-level disinfectant spray or wipe.
- Contacts mucous membranes and non-intact skin: This category includes all endocavity probes - intravaginal, transrectal, and transesophageal (TEE) and probes use for biopsy procedures. These semi-critical probes must be cleaned with an appropriate cleaner after use followed by high-level disinfection.
- Contacts otherwise sterile tissue or body-space: These probes are considered critical and include all intraoperative probes. These probes must be cleaned with an appropriate cleaner after each use, followed by a sterilization process.

Cleaning

Please refer to the instructions in the manual and follow your hospital policy and procedures for cleaning.

Perform the following procedure:

1. Wear a pair of gloves to prevent infection.
2. Disconnect the probe from the system. If the sheath is used, take off the sheath and discard it.
3. Wipe off the ultrasound gel or other visible dirt on the surface of the probe by using a damp piece of disposable lint-free soft cloth or tissue.
4. Choose an appropriate cleaning agent including mild detergents, enzymatic cleaners and specially designed enzymatic sponges.
5. Immerse the probe fully in the cleaning fluid for at least 1 minute or according to manufacturer's instructions. Lightly mechanical clean the probe with a piece of lint-free soft cloth or soft sponge until no dirt is visible. When necessary, clean the seams or biopsy guide features by using disposable cotton swabs. Avoid using a brush to wash the lens because it may damage the probe.
6. Rinse the probe thoroughly by using a large amount of clean water (about 7.5 L/2 gallons) at room temperature for about 30 s to remove the residual dirt and cleaning solvent. Repeat the rinsing operation twice.
7. Dry the probe by wiping with a piece of disposable lint-free soft cloth or tissue.

- Do not dry the probe by heating.
8. Inspect the probe. If visible dirt still exists, repeat the preceding steps to wash the probe until it is all clean.
 9. Check whether the probe has defects such as peeling, rifts, bumps, cracks, or liquid spill. If such defects exist, the probe has reached the end of its service life. In this case, stop using it and contact the Mindray service department.

Low-level disinfection of a non-critical probe

⚠ CAUTION

Use protective eyewear when disinfecting using sprays.

Perform the following procedure:

1. Wear a pair of gloves to prevent infection.
2. Clean the probe thoroughly in accordance with the cleaning procedure before disinfection.
3. Disinfect the probe by using an appropriate low-level disinfectant. Follow the disinfection agent manufacturer's instructions for preparation and use of the disinfectant.
 - Wipes: Wipe all the surface of the probe according to the wiping duration specified in the operator's manual provided by the manufacturer.
 - Spray: Spray the disinfectant directly on the surface of the probe or spray the disinfectant on a piece of disposable lint-free soft cloth and wipe the probe according to the wiping duration in the operator's manual provided by the manufacturer.

Observe the graph here carefully to perform disinfection. Do not spray the strain relief on the connector end or the connector.

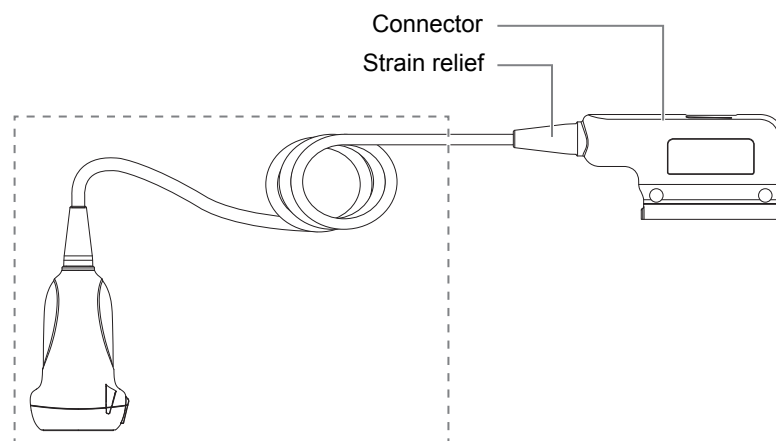

4. Wipe away the residual disinfectant on the probe by using a piece of lint-free soft cloth soaked with clean water. Wipe three times. Or rinse the probe thoroughly by using a large amount of clean water (about 7.5 L/2 gallons) at room temperature.
5. Dry the probe by wiping with a piece of disposable lint-free soft cloth. Do not dry the probe by heating.
6. Check whether the probe has defects such as peeling, rifts, bumps, cracks, or liquid spill. If such defects exist, the probe has reached the end of its service life. In this case, stop using it and contact the Mindray service department.
7. Store the probe in a cool, clean and dry environment. And repeat the cleaning and disinfection process before the next use.

High-level disinfection of a semi-critical probe

Perform the following procedure:

1. Wear a pair of gloves to prevent infection.
2. Clean the probe thoroughly in accordance with the cleaning procedure before disinfection.
3. Disinfect the probe by using an appropriate high-level disinfectant or system. For how to use a high-level disinfectant or system, see the operator's manual provided by the manufacturer. Prepare a disinfectant by using sterile distilled or softened water when necessary.

- Soaking: Immerse the probe head in the disinfectant and shake the probe appropriately to remove any bubbles on the probe surface. For details about the probe immersion duration, see the operator's manual provided by the manufacturer.

Observe the graph here carefully to immerse the probe. Only soak parts of the probe below the strain relief.

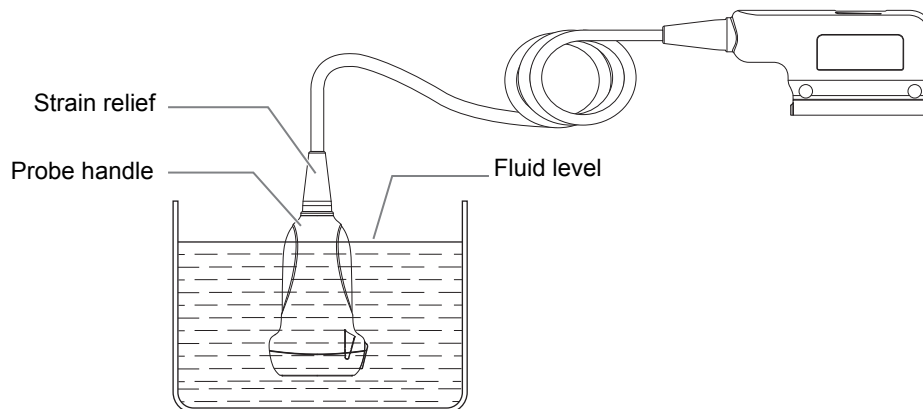

- Wiping: Use a market disinfection wipe product or sterile disposable lint-free soft cloth wetted with disinfection spray and wipe all surfaces of the probe for a duration according to the manufacturer instructions.
4. Rinse the probe thoroughly by using a large amount of clean water (about 7.5 L/2 gallons) at room temperature for about 30 s to remove the residual disinfectant. Repeat the operation twice. Or follow the disinfectant manufacturer's instructions regarding rinsing.
 5. Dry the probe by wiping with a piece of clean disposable lint-free soft cloth. Do not dry the probe by heating.
 6. Check whether the probe has defects such as peeling, rifts, bumps, cracks, or liquid spill. If such defects exist, the probe has reached the end of its service life. In this case, stop using it and contact the Mindray service department.
 7. Store the probe in a cool, clean and dry environment. And repeat the cleaning and disinfection process before the next use.

Sterilization of a critical probe

⚠ CAUTION

Repeated sterilization will eventually damage the probe, please check the probe's performance periodically.

For intra-operative probes, they have to be thoroughly cleaned and sterilized after completing each examination.

Perform the following procedure:

1. Wear a pair of gloves to prevent infection.
2. Clean the probe thoroughly in accordance with the cleaning procedure before sterilization.
3. Sterilize the probe by using an appropriate sterilant or system.

For how to use a system, see the operator's manual provided by the manufacturer.

When using a sterilant, follow the following steps:

- a. Prepare a sterilant by using sterile distilled or softened water when necessary.
- b. Immerse the probe head in the sterilant and shake the probe appropriately to remove any bubbles on the probe surface.

For details about the probe immersion duration, see the operator's manual provided by the manufacturer.

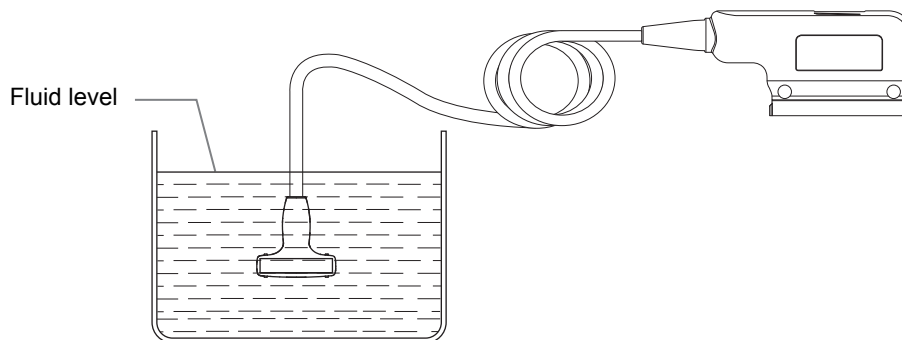

- c. Rinse the probe thoroughly by using a large amount of sterile distilled or softened water (about 2 gallons) at room temperature for about 30 s to remove the residual disinfectant. Repeat the operation twice. Or follow the sterilant manufacturer's instructions regarding rinsing.
 - d. Dry the probe by wiping with a piece of sterile disposable lint-free soft cloth.
Do not dry the probe by heating.
4. Check whether the probe has defects such as peeling, rifts, bumps, cracks, or liquid spill. If such defects exist, the probe has reached the end of its service life. In this case, stop using it and contact the Mindray service department.
 5. Store the probe in a cool, clean and dry environment. And repeat the cleaning and sterilization process before the next use.

Compatible Cleaners and Disinfectants

For the detailed information about cleaners and disinfectants, see *Mindray Transducer Disinfectant Recommendation*.

16.1.6 Cleaning the probe cable and connector

NOTE:

Do not use cloth with water to clean the probe connector.

Perform the following procedure:

1. Wipe out the dust attached to surface of probe connector and cable.
2. Use soft brush to brush the dust inside probe connector gently.
3. Remained stain or dust attached to surface of cable or surface of connector should be washed out by cloth with a little soapy water, and then air-dry.

16.1.7 Probe Environmental Conditions

Table 16-2 Probe Environmental Conditions

Probe Model	Conditions	Ambient temperature	Relative humidity (no condensation)	Atmospheric pressure
C5-1s	Operating	0°C ~ 40°C	30% ~ 85%	700 hPa ~ 1060 hPa
	Storage and transportation	-20°C ~ 55°C	30% ~ 95%	700 hPa ~ 1060 hPa
C5-2s	Operating	0°C ~ 40°C	30% ~ 85%	700 hPa ~ 1060 hPa
	Storage and transportation	-20°C ~ 55°C	30% ~ 95%	700 hPa ~ 1060 hPa
C11-3s	Operating	0°C ~ 40°C	30% ~ 85%	700 hPa ~ 1060 hPa
	Storage and transportation	-20°C ~ 55°C	30% ~ 95%	700 hPa ~ 1060 hPa
SC5-1Ns	Operating	0°C ~ 40°C	20% ~ 85%	700 hPa ~ 1060 hPa
	Storage and transportation	-20°C ~ 55°C	20% ~ 95%	700 hPa ~ 1060 hPa
V11-3s	Operating	0°C ~ 40°C	30% ~ 85%	700 hPa ~ 1060 hPa
	Storage and transportation	-20°C ~ 55°C	30% ~ 95%	700 hPa ~ 1060 hPa
V11-3Hs	Operating	0°C ~ 40°C	20% ~ 85%	700 hPa ~ 1060 hPa
	Storage and transportation	-20°C ~ 55°C	20% ~ 95%	700 hPa ~ 1060 hPa
L9-3s	Operating	0°C ~ 40°C	20% ~ 85%	700 hPa ~ 1060 hPa
	Storage and transportation	-20°C ~ 55°C	20% ~ 95%	700 hPa ~ 1060 hPa
L11-3VNs	Operating	0°C ~ 40°C	20% ~ 85%	700 hPa ~ 1060 hPa
	Storage and transportation	-20°C ~ 55°C	20% ~ 95%	700 hPa ~ 1060 hPa
L12-3VNs	Operating	0°C ~ 40°C	20% ~ 85%	700 hPa ~ 1060 hPa
	Storage and transportation	-20°C ~ 55°C	20% ~ 95%	700 hPa ~ 1060 hPa
L12-3RCs	Operating	0°C ~ 40°C	20% ~ 85%	700 hPa ~ 1060 hPa
	Storage and transportation	-20°C ~ 55°C	20% ~ 95%	700 hPa ~ 1060 hPa
L12-4s	Operating	0°C ~ 40°C	30% ~ 85%	700 hPa ~ 1060 hPa
	Storage and transportation	-20°C ~ 55°C	30%~95%	700 hPa ~ 1060 hPa
L13-3s	Operating	0°C ~ 40°C	20% ~ 85%	700 hPa ~ 1060 hPa
	Storage and transportation	-20°C ~ 55°C	20% ~ 95%	700 hPa ~ 1060 hPa

Table 16-2 Probe Environmental Conditions

Probe Model	Conditions	Ambient temperature	Relative humidity (no condensation)	Atmospheric pressure
L14-6Ns	Operating	0°C ~ 40°C	30% ~ 85%	700 hPa ~ 1060 hPa
	Storage and transportation	-20°C ~ 55°C	30% ~ 95%	700 hPa ~ 1060 hPa
L16-4Hs	Operating	10°C ~ 40°C	30% ~ 85%	700 hPa ~ 1060 hPa
	Storage and transportation	0°C ~ 60°C	30% ~ 95%	700 hPa ~ 1060 hPa
L20-5s	Operating	0°C ~ 35°C	15% ~ 80%	700 hPa ~ 1060 hPa
	Storage and transportation	-20°C ~ 60°C	15% ~ 90%	500 hPa ~ 1060 hPa
L13-3Ns	Operating	0°C ~ 40°C	20% ~ 85%	700 hPa ~ 1060 hPa
	Storage and transportation	-20°C ~ 55°C	20% ~ 95%	700 hPa ~ 1060 hPa
P4-2s	Operating	0°C ~ 40°C	30% ~ 85%	700 hPa ~ 1060 hPa
	Storage and transportation	-20°C ~ 55°C	30% ~ 95%	700 hPa ~ 1060 hPa
P8-2s	Operating	0°C ~ 40°C	20% ~ 85%	700 hPa ~ 1060 hPa
	Storage and transportation	-20°C ~ 55°C	20% ~ 95%	700 hPa ~ 1060 hPa
P10-4s	Operating	0°C ~ 40°C	30% ~ 85%	700 hPa ~ 1060 hPa
	Storage and transportation	-20°C ~ 55°C	30% ~ 95%	700 hPa ~ 1060 hPa
SP5-1Ns	Operating	0°C ~ 40°C	20% ~ 85%	700 hPa ~ 1060 hPa
	Storage and transportation	-20°C ~ 55°C	20% ~ 95%	700 hPa ~ 1060 hPa
CW2s	Operating	0°C ~ 40°C	30% ~ 85%	700 hPa ~ 1060 hPa
	Storage and transportation	-20°C ~ 55°C	30% ~ 95%	700 hPa ~ 1060 hPa

16.1.8 Storage and Transportation

When all examinations for the day have been completed, confirm that the probe is in good condition. After disinfecting the probe, confirm that the probe is in good condition and stored in a suitable place

- To prevent the probe from being damaged, DO NOT store it in locations where it may be exposed to:
 - Direct sunlight or X-rays
 - Sudden changes in temperature
 - Dust
 - Excessive vibration
 - Heat generators

- When the probe is sent to MINDRAY Customer Service Department or sales representative for repair, be sure to disinfect it and keep it in the carrying case to prevent infection.

16.2 Biopsy Guide

WARNING

- The person performing biopsy procedures must understand diagnostic ultrasound thoroughly and have been trained adequately, otherwise, side effects may be caused to the patient.
- In situations listed below, the biopsy needle may fail to penetrate the target. The incorrect biopsy may cause various side effects in the patient.
 - Use a needle-guided bracket other than that provided.
 - Mount the needle-guided bracket incorrectly.
 - Use a biopsy needle that is unsuitable for the type of biopsy being performed.
 - Use a biopsy needle that is unsuitable for the needle guide.
- Before and after a biopsy procedure is performed, confirm that the needle-guided bracket is normal. Manually confirm that the parts of the needle-guided bracket do not slip off or move from their proper positions. If the needle-guided bracket is used when parts are not securely and correctly installed, the patient may be injured. If an abnormality is found on the needle-guided bracket, immediately stop using it and contact MINDRAY Customer Service Department or sales representative.
- Needle guided brackets are required to be verified before each biopsy. If the verification fails, it indicates that the needle-guided brackets are out of service life.
- Disposable brackets are packaged sterile and are single-use only, and the method of sterilization is irradiation. Do not use if the sterile packaging is open or broken, and do not reuse or resterilize the disposable brackets.
- DO NOT use a needle-guided bracket when scanning is performed. The needle may advance in an incorrect direction and possibly injure the patient.

Never perform a biopsy during image scanning.
- DO NOT freeze an image while performing biopsy procedure.
- During biopsy procedures, the needle may deviate from the desired course due to the tissue characteristics or the type of needle. In particular, needles of small diameters may deviate to a greater degree.
- Disinfect the probe and sterilize needle-guided bracket before and after each ultrasound-guided biopsy procedure is performed. Failure to do so may cause the probe and the needle-guided bracket to become sources of infection.
- The needle mark displayed on the ultrasound image does not indicate the actual position of the biopsy needle. Therefore, it should only be used as a

reference. Always monitor the relative positions of the biopsy needle during the procedures.

- Adjust the needle mark before the biopsy procedure is performed.
- When performing biopsy procedures, use only sterile ultrasound gel that is certified to be safe. And manage the ultrasound gel properly to ensure that it does not become a source of infection.
- When performing the operation concerning biopsy, wear sterile gloves.
- Image of the biopsy target and the actual position of the biopsy needle: Diagnostic ultrasound systems produce tomographic plane images with information of a certain thickness in the thickness direction of the probe. (That is to say, the information shown in the images consist all the information scanned in the thickness direction of the probe.) So, even though the biopsy needle appears to have penetrated the target object in the image, it may not actually have done so. When the target for biopsy is small, dispersion of the ultrasound beam may lead to image deviate from the actual position. Pay attention to this.

If the target object and the biopsy needle appear in the image as shown in the figures below (For reference only):

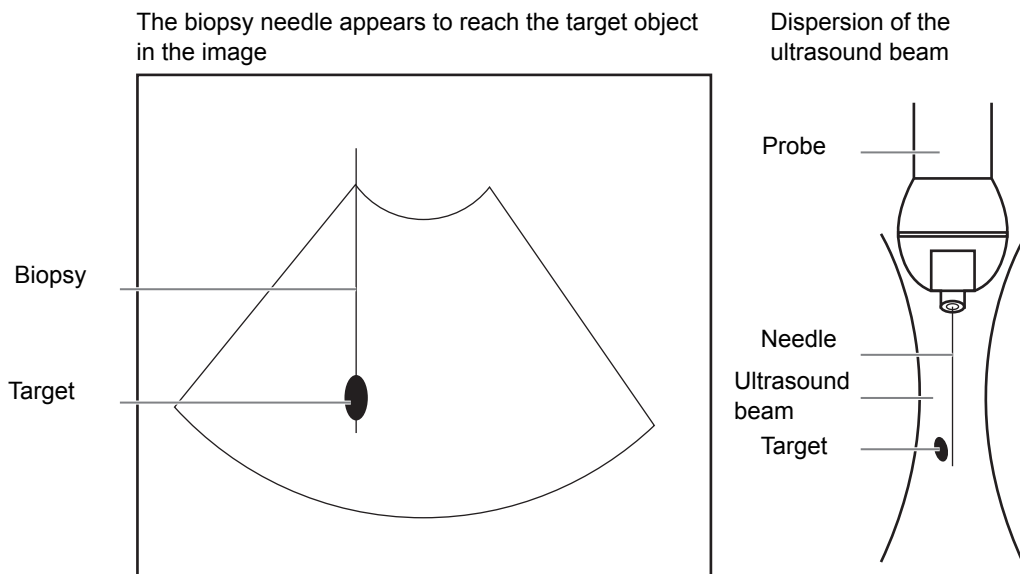

The biopsy needle may not have actually entered the target object even though it appears to have done so in the image. To avoid this, note the points below:

- Do not rely only on the needle tip in the image. Pay careful attention to the fact that when the biopsy needle enters the target object or comes into contact with it, the object should shift slightly.
- Before performing the biopsy, evaluate the size of the object and confirm whether the biopsy can be carried out.

16.2.1 Needle-guided Brackets Available

Some of the probes have matched needle-guided brackets for biopsy, the available probes and the corresponding needle-guided brackets are listed as follows.

Table 16-3 Needle-guided Brackets Available

Probe Model	Needle-guided Bracket Model	Biopsy angle/ depth($\pm 1^\circ$)	Applicable Biopsy Needle
V11-3s	NGB-004 Metal-needle undetachable	/	16G, 17G, 18G
L12-4s L13-3s L14-6Ns	NGB-007 plastic/needle detachable Metal-needle detachable	40°, 50°, 60°	Metal: 14G, 16G, 18G, 20G, 22G Plastic: 13G, 15G, 16G, 18G, 20G
SP5-1Ns P4-2s	NGB-011 Metal-needle undetachable	11°, 23°	13G, 15G, 16G, 18G, 20G
C5-2s	NGB-015 Metal-needle detachable	25°, 35°, 45°	14G, 16G, 18G, 20G, 22G
C11-3s	NGB-018 Metal-needle detachable	15°, 25°, 35°	14G, 16G, 18G, 20G, 22G
C5-1sSC5-1Ns	NGB-022 Metal-needle detachable	25°, 35°, 45°	14G, 16G, 18G, 20G, 22G
V11-3Hs	NGB-025 Metal-needle undetachable	1.6°	16G, 17G, 18G
L9-3s	NGB-034 Metal-needle detachable	40°, 50°, 60°	14G, 16G, 18G, 20G, 22G
L12-3RCs	NGB-043 Metal-needle detachable	Angle range: 35° ~ 80°	20G, 21G, 22G, 23G
	NGB-044 Metal-needle detachable	Biopsy depth: 5mm, 10mm, 15mm, 25mm, 35mm	18G, 20G, 21G
V11-3s	NGB-045 Metal-needle undetachable	1°	16G, 17G, 18G
L13-3Ns	NGB-053 Metal-needle detachable	40°, 50°, 60°	11G, 23G

Table 16-4 Disposable Brackets

Probe Model	Needle-guided Bracket Model
V11-3s	CIVCO 610-543
	CIVCO 610-1274
L12-4s, L13-3s, L14-6Ns	CIVCO 658-001
C5-2s	CIVCO 658-002

16.2.2 Needle-Guided Bracket Inspection and Installation

A needle-guided bracket is available for purchase as an optional accessory; it is used in combination with the probe. Some of the probes have matched needle-guided bracket and needles. To order needle-guided brackets, contact MINDRAY Customer Service Department or sales representative.

For biopsy or treatment, ultrasound-guided biopsy procedures can be performed using the probe in combination with a needle-guided bracket (optional accessory) and a biopsy needle (provided by the user).

Be sure to perform inspections before and after use of the needle-guided bracket. If an abnormality is found on the needle-guided bracket, immediately stop using it and contact MINDRAY Customer Service Department or sales representative.

- Sterilize the needle-guided bracket before and after use.
- Put on the sterile probe sheath before installing to the probe.
- Confirm that the needle-guided bracket is free of damage, deformation, stripping, malfunction, loose, or missing parts.
- Confirm that the needle-guided bracket is securely mounted in the correct position.
- Select the proper needle according to the specification above, and adjust the needle shift to the same specification of the selected needle.

NGB-004 Metal-needle undetachable needle-guided bracket

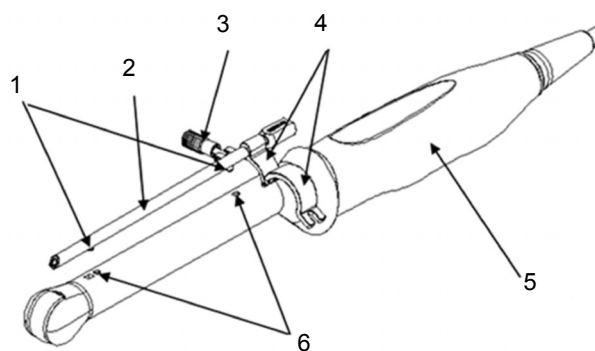

1	Locating bulge
2	Needle guide
3	Locking nut
4	Retaining clamp
5	Probe

6	Locating groove
---	-----------------

Perform the following procedure:

1. Install the needle-guided bracket:
 - a. Put on the sterile probe sheath.

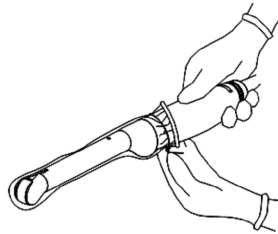

- b. Open the retaining clamp, align the needle-guided bracket with the probe to align the locating bulge on the needle guide with the locating grooves on the probe, then turn the retaining clamp to align it with the probe.

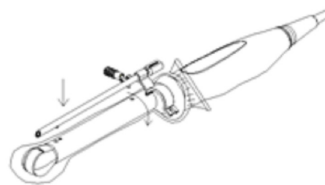

- c. When the retaining clamp is turned to the correct position, the locking nut will lock the retaining clamp and the needle-guided bracket is then mounted in the correct position.



2. Remove the needle-guided bracket:

Hold the probe in your left hand. Unscrew the locking nut with your right hand to open the retaining clamp, then raise the needle-guided bracket to separate the locating bulge from the locating grooves.

NGB-007 Metal/needle detachable needle-guided bracket

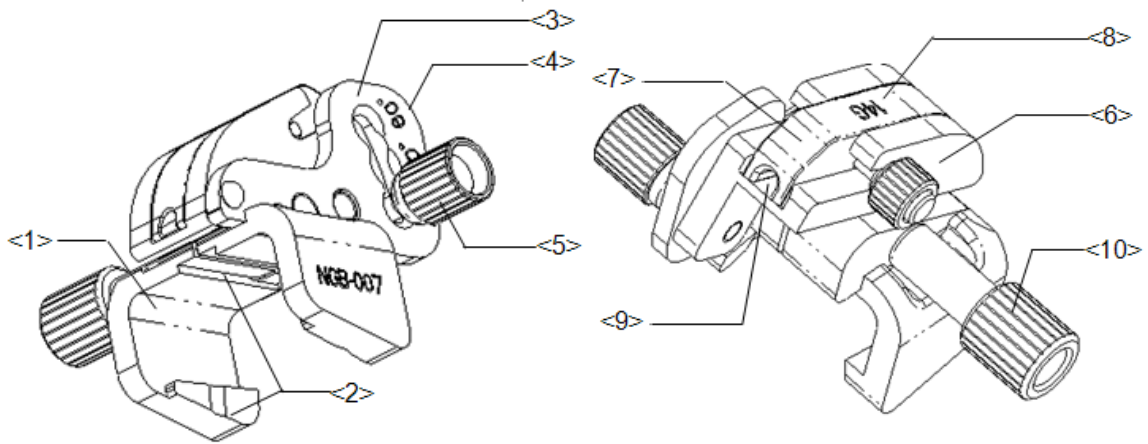

1	Support for needle-guided bracket
2	Tab and groove for the needle-guided bracket
3	Angle-adjusting base
4	Angle shift sign
5	Angle pinch nut
6	Angle block
7	Guiding block
8	Guiding block specification
9	Needle guide hole
10	Needle-guided bracket pinch nut

Perform the following procedure:

1. Install the needle-guided bracket:
 - a. Put on the sterile probe sheath.
 - b. Hold the probe in one hand, select the correct needle-guided bracket and hold it with the other hand. Match the groove and tab with the tab and groove of the probe respectively. Mount the bracket onto the probe.

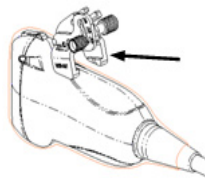

- c. Screw the pinch nut of the needle-guided bracket to ensure that the needle-guided bracket is properly installed on the probe.

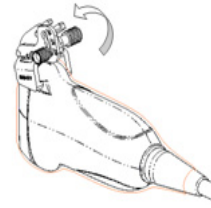

2. Adjust the needle angle to the proper shift as required:
 - a. Loosen the angle pinch nut.
 - b. Adjust the angle block to the desired level.
 - c. Tighten the angle pinch nut.

3. Install the guiding block

- a. Select a suitable guiding block and push it into the groove above the angle block, then clamp it tightly

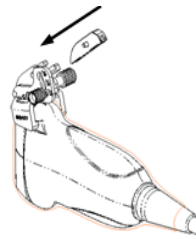

- b. Screw the block's nut to secure the block.

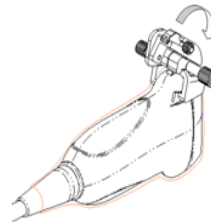

- c. Insert a biopsy needle with the same specification as that of the guiding block into the guiding block hole.

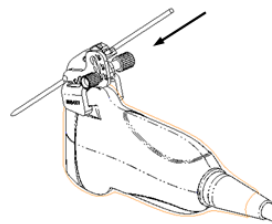

4. Release the needle from the bracket:

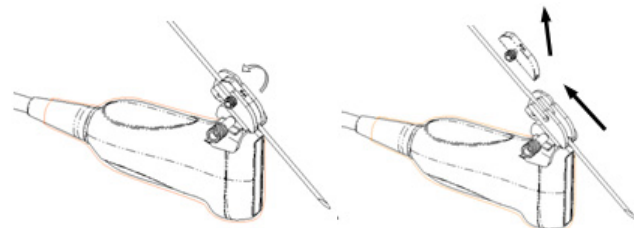

- a. Screw the nut of the guiding block and remove the guiding block slightly along the direction of the needle's tail.
- b. Separate the residual part of the needle-guide bracket and the probe from the needle.

5. Remove the needle-guided bracket:

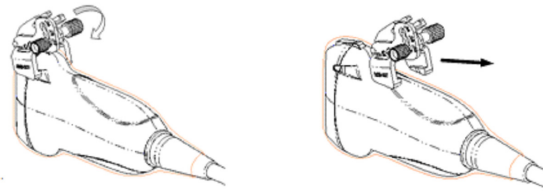

- a. Unscrew the Needle-guided bracket pinch nut, and remove the needle-guided bracket from the probe.
- b. Separate the probe and the needle-guided bracket.

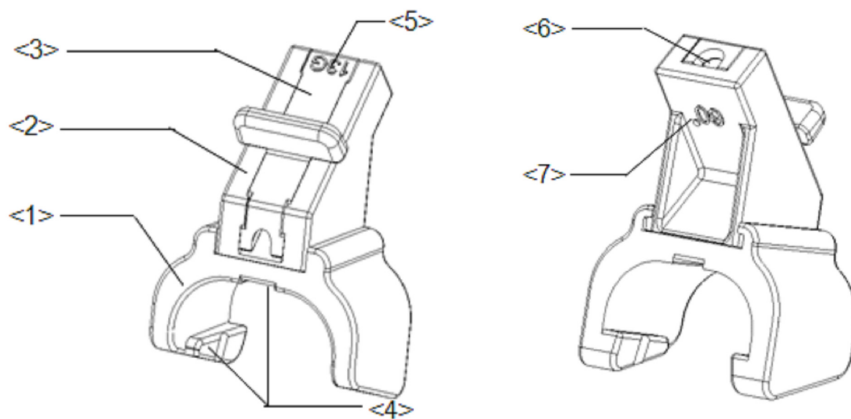
NGB-007 Plastic/needle detachable needle-guided bracket

1	Support of needle-guided bracket
2	Angle block
3	Guiding block
4	Groove and tab of the needle-guided bracket
5	Specification of guiding block
6	Guiding hole of the biopsy needle
7	Specification of angle block

Perform the following procedure:

1. Install the needle-guided bracket:
 - a. Put on the sterile probe sheath.
 - b. Hold the probe by one hand, select the proper needle-guided bracket, and hold it with the other hand. Align the narrow end tab of the needle-guided bracket with the groove of the probe, then push the needle-guided bracket forward, making the tabs and the grooves of the needle-guided bracket to match with the grooves and tabs of the probe.

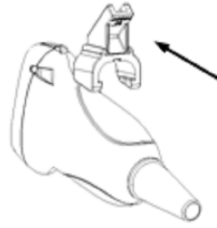

- c. Check manually to confirm that the needle-guided bracket is securely installed on the probe.

2. Install the guiding block:

- a. Select a proper guiding block and push it into the groove above the angle block, and clamp it tightly.

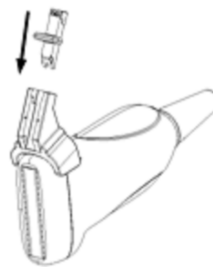

- b. Insert a biopsy needle with the same specification as that of the guiding block into the hole of the guiding block.



3. Release the needle from the bracket:



- a. Remove the guiding block slightly along the direction of the needle's tail.

- b. Separate the residual part of the needle-guide bracket and the probe from the needle.
4. Remove the needle-guided bracket:



Remove the support of needle-guided bracket from the probe.

NGB-011 Metal-needle undetachable needle-guided bracket

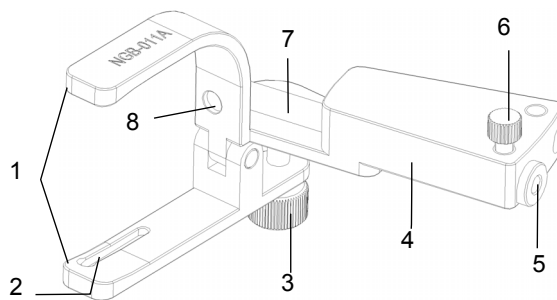

1	Clamp
2	Locating groove
3	Grip knob
4	Needle guide rack
5	Needle guide hole
6	Needle guide clamping knob
7	Needle guide
8	Locating pit

Perform the following procedure:

1. Install the needle-guided bracket:
 - a. Put on the sterile probe sheath.
 - b. Connect the locating groove on the clamp with the two raised edges on the probe head and align the locating pit of the clamp with the convex point on the probe head.
 - c. Turn the grip knob at the tail of the needle-guided bracket tightly.
2. Remove the needle-guided bracket:

Hold the probe and the needle-guided bracket, then open the grip knob of the needle-guided bracket.

NGB-015/NGB-022 Metal-needle detachable needle-guided bracket

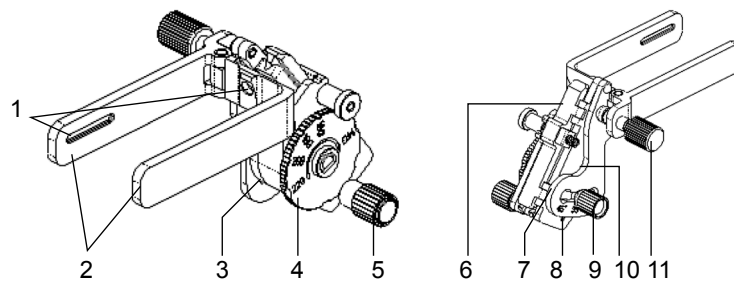

1	Groove
2	Clamp
3	Needle type adjusting base
4	Needle type dial scale
5	Needle fixing nut
6	V-shaped cover
7	Angle adjusting base
8	Angle shift sign
9	Angle pinch nut
10	Angle block
11	Pinch nut

Perform the following procedure:

1. Install the needle-guided bracket:
 - a. Put on the sterile probe sheath.
 - b. Hold the probe by one hand, select the proper needle-guided bracket, and hold it with the other hand. Match the groove of the bracket with the tab of the probe. Amount the bracket onto the probe.

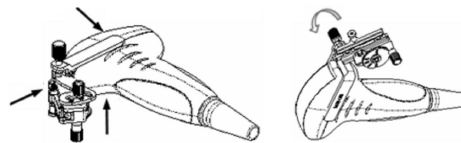

- c. Screw the pinch nut of the needle-guided bracket to confirm that the needle-guided bracket is properly installed on the probe.
2. Adjust the needle angle to the proper shift as required:
 - a. Loosen the angle pinch nut.
 - b. Adjust the angle block to the desired level.
 - c. Tighten the angle pinch nut.
3. Insert the biopsy needle:

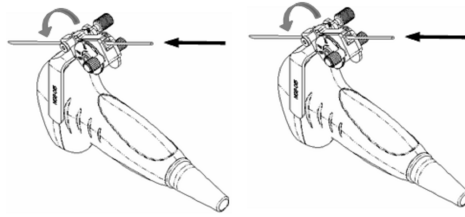

- a. Adjust the dial scale to the required needle type shift, and then screw the needle fixing nut to lock the dial scale. (To adjust the dial scale you have to loosen the needle fixing nut first.)
 - b. Pull the lock pin and close the V-shaped cover to fix the lock pin in the groove of the needle type adjusting base, so as to install the needle into the guiding hole.
4. Release the needle from the bracket:

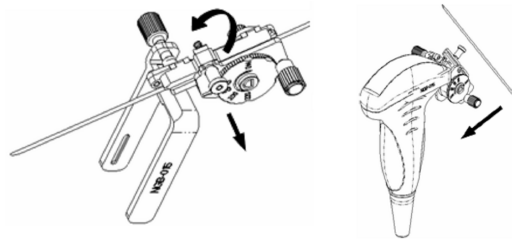

- a. Pull the lock pin and open up the V-shaped cover to expose the needle.
 - b. Separate the bracket and the probe from the needle.
5. Remove the needle-guided bracket:

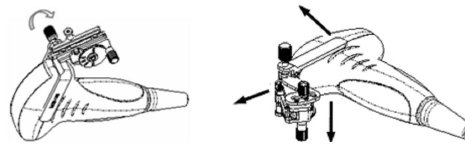

- a. Screw the pinch nut to release the needle-guided bracket.
- b. Separate the bracket and the probe.

NGB-018 Metal-needle detachable needle-guided bracket

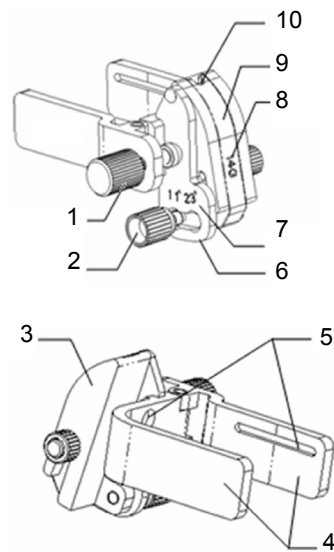

1	Pinch nut of bracket
2	Angle pinch nut
3	Angle block
4	Clamp
5	Groove
6	Angle-adjusting base
7	Angle shift sign
8	Guiding block specification
9	Guiding block
10	Needle guide hole

Perform the following procedure:

1. Install the needle-guided bracket:

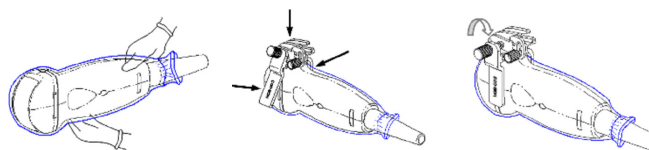

- a. Put on the sterile probe sheath.
 - b. Select a suitable needle-guided bracket and match the groove to the tab of the probe. Mount the bracket onto the probe.
 - c. Screw the pinch nut of the needle-guided bracket to ensure that the needle-guided bracket is properly installed on the probe.
2. Adjust the needle angle to the proper shift as required:
 - a. Loosen the angle pinch nut.
 - b. Adjust the angle block to the desired level.
 - c. Tighten the angle pinch nut.

3. Install the guiding block:

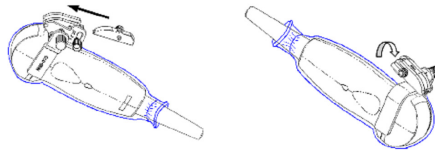

- a. Select a suitable guiding block and push it into the groove above the angle block
 - b. Screw the block's nut to secure the block.
 - c. Insert a biopsy needle with the same specification as that of the guiding block into the guiding block hole.
4. Release the needle from the bracket:

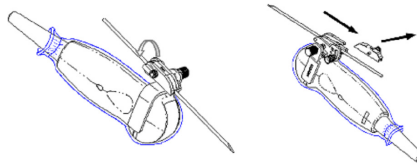

- a. Loosen the guiding block's nut and slightly move the guiding block in the direction of the needle's tail.
 - b. Separate the residual part of the needle-guide bracket and the probe from the needle.
5. Remove the needle-guided bracket:

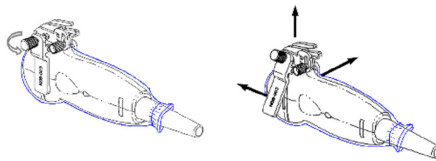

- a. Screw the pinch nut to release the needle-guided bracket
- b. Separate the bracket and the probe.

NGB-025 Metal-needle undetachable needle-guided bracket

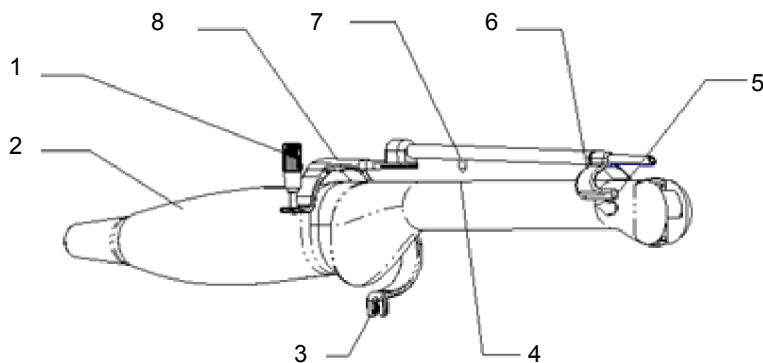

1	Pinch nut
2	Intra-cavity probe
3	Lower clamp

4	Location hole
5	Front slot
6	Front clamp
7	Location clamp
8	Upper clamp

Perform the following procedure:

1. Install the needle-guided bracket:
 - a. Put on the sterile probe sheath.

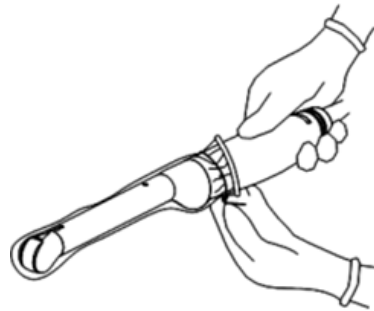

- b. Open the clamp. Insert the front clamp to the front groove, and align front clamp with front groove.

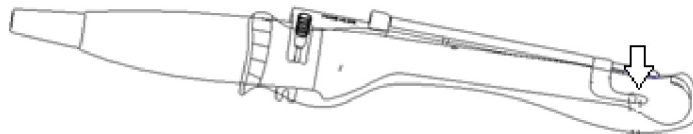

- c. Push the biopsy forward (arrow's direction) until the locating pole inserting into the location hole. Turn the lower clamp against the intra-cavity probe. Tighten the nut to lock the biopsy (arrow's direction)

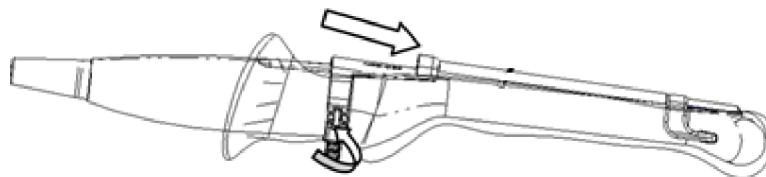

2. Remove the needle-guided bracket:
 - a. Hold the prober in the left hand; unscrew the locking nut with the right hand to loose the clamp (arrow's direction).

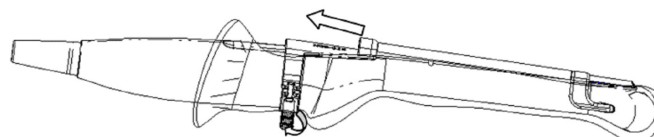

- a. Hold the prober in the left hand; unscrew the locking nut with the right hand to loose the clamp (arrow's direction).

- b. Lift the biopsy up (towards arrow's direction). The locating pole, front clamp, the locating hole and the front clamp become loose.

NGB-034 Metal-needle detachable needle-guided bracket

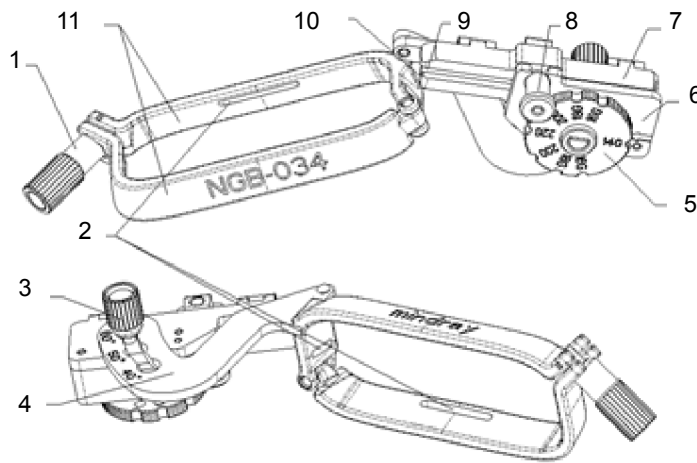

1	Needle fixing nut
2	Guiding groove
3	Angle fixing nut
4	Angle adjusting base
5	Needle type dial scale
6	Needle adjusting base
7	V-shape cover
8	Lock pin
9	Needle guide hole
10	V-shaped guiding block
11	Clamp

Perform the following procedure:

1. Install the needle-guided bracket:

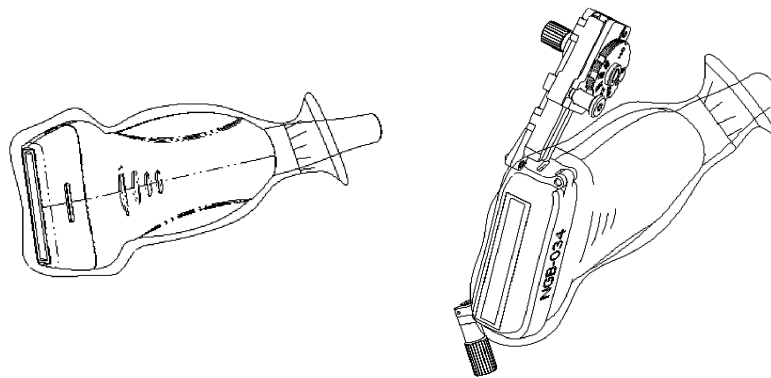

- a. Put on the sterile probe sheath.

- b. Select a proper needle-guided bracket, and match the locating groove with the tab of the probe. Mount the bracket onto the probe.
 - c. Tighten the pinch nut of the needle-guided bracket to confirm that the needle-guided bracket is properly installed on the probe.
2. Adjust the needle angle to the proper shift as required:
 - a. Loosen the angle pinch nut.
 - b. Adjust the angle block to the desired level.
 - c. Tighten the angle pinch nut.
3. Insert the biopsy needle:
 - a. Adjust the dial scale to the required needle type shift.
 - b. Pull the lock pin and close the V-shaped cover to fix the lock pin in the groove of the needle type adjusting base, so as to install the needle into the guiding hole.
4. Release the needle from the bracket:

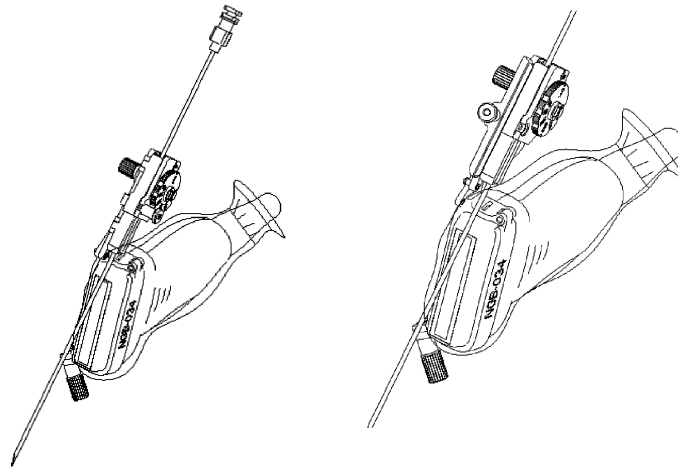

- a. Pull the lock pin out until the V-shaped cover can be turned and opened up.
 - b. Turn over the V-shaped cover to expose the needle. Remove the probe and bracket.
5. Remove the needle-guided bracket:

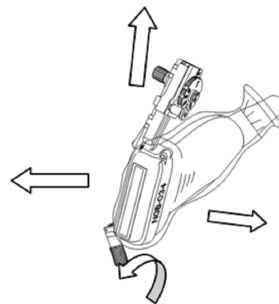

- a. Unscrew the pinch nut to release the needle-guided bracket.
 - b. Hold the probe and take out the bracket.

NGB-043 Metal-needle detachable needle-guided bracket

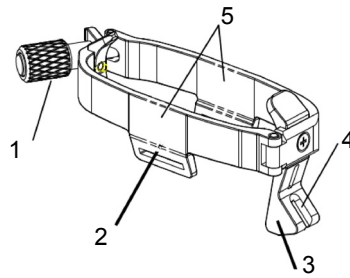

1	Locking nut of left and right clamps
2	Groove
3	Guide frame
4	Guide block hole
5	Clamps

Perform the following procedure:

1. Install the needle-guided bracket:
 - a. Put on the sterile probe sheath.
 - b. Hold the probe in one hand, select the correct needle-guided bracket and hold it with the other hand. Match the grooves of the needle-guided bracket to the tabs of the probe.
 - c. Mount the bracket onto the probe, and rotate the locking nut to fix the bracket.
2. Insert the biopsy needle:

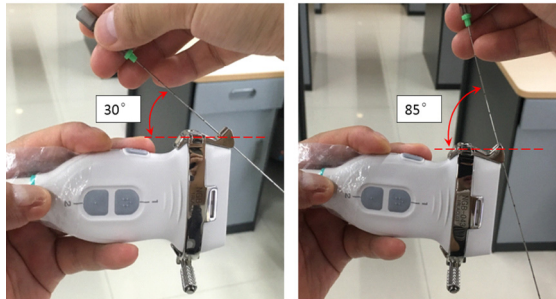

- a. Insert a biopsy needle into the guiding block hole.
 - b. Adjust the biopsy angle of the needle, and ensure that the needle can be adjusted continuously within the range of 30° to 85°.
3. Release the needle from the bracket:

Hold the probe, and remove the biopsy needle from the guiding hole of the guiding block.
4. Remove the needle-guided bracket:



- a. Rotate the locking nut in the direction of the arrow shown on the figure to separate the bracket from the probe.
- b. Hold the probe and take out the bracket.

NGB-044 Metal-needle detachable needle-guided bracket

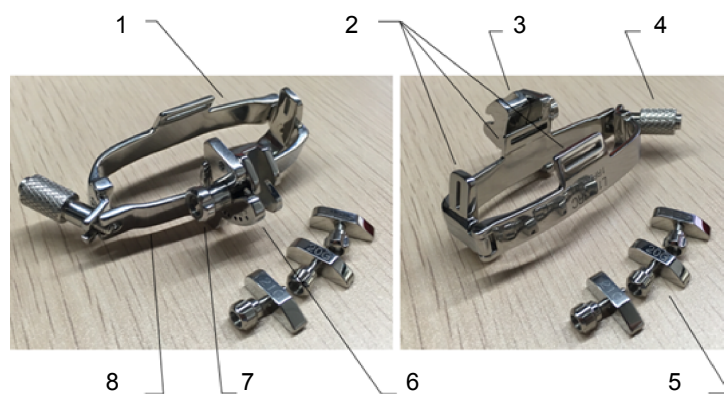

1	Right clamp
2	Groove
3	Guiding block fixing frame
4	Locking nut of left and right clamps
5	Guiding blocks
6	Depth shift sign
7	Depth pinch nut
8	Left clamp

Perform the following procedure:

1. Install the needle-guided bracket:



- a. Put on the sterile probe sheath.
 - b. Hold the probe in one hand, select the correct needle-guided bracket and hold it with the other hand. Match the grooves of the needle-guided bracket to the tabs of the probe.
 - c. Mount the bracket onto the probe, and rotate the locking nut to fix the bracket.
2. Adjust the needle angle to the proper shift as required:



- a. Loosen the depth pinch nut.
 - b. Adjust the depth shift to the desired level.
 - c. Tighten the depth pinch nut.
3. Insert the biopsy needle:
- a. Select a suitable guiding block and loosen its nut, install the guiding block to the guiding block fixing frame, then tighten the block nut tightly.

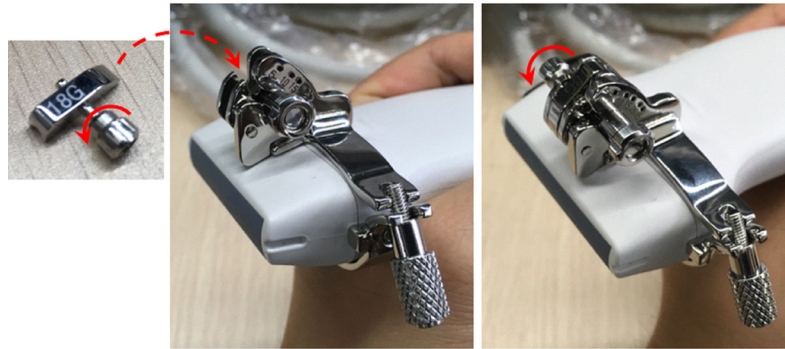

- b. Insert a biopsy needle with the same specification as that of the guiding block into the guiding block hole

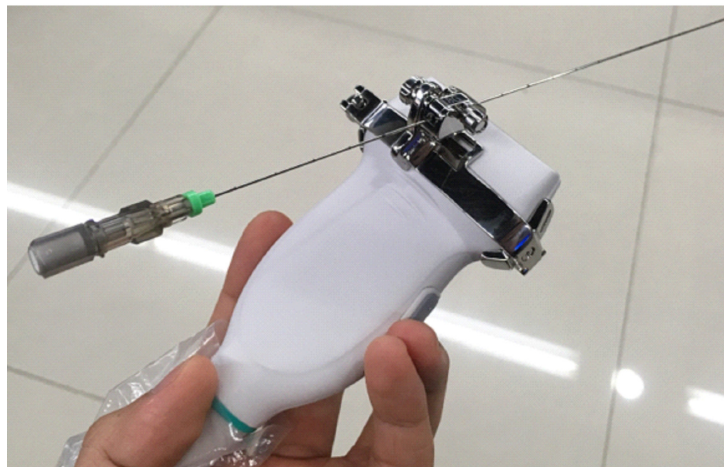

4. Remove the needle-guided bracket:
 - a. Hold the probe and remove the needle.
 - b. Loosen the guiding block nut, and remove it from the guiding block fixing frame.



- c. Rotate the clamping nuts of the needle guided-bracket. The needle guided-bracket is separate from the probe. Hold the probe and take out the bracket.



NGB-045 Metal-needle undetachable needle-guided bracket

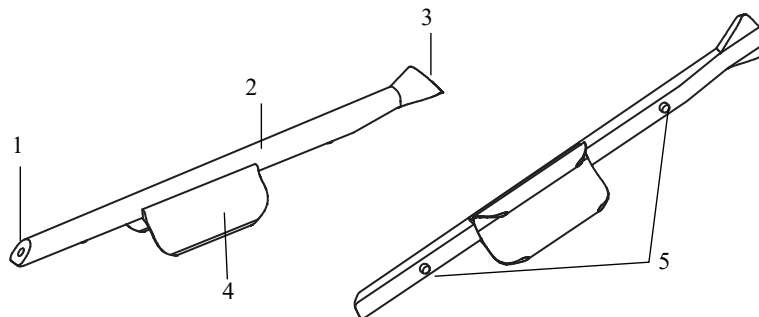

1	Needle exit
2	Needle guide
3	Needle entry
4	Retaining clamp
5	Locating bulges

Perform the following procedure:

1. Install the needle-guided bracket:
 - a. Put on the sterile probe sheath.

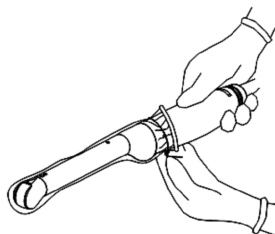

- b. Align the needle-guided bracket with the probe to align the locating bulges on the needle guide with the locating grooves on the probe, then turn the retaining clamp to the correct position.

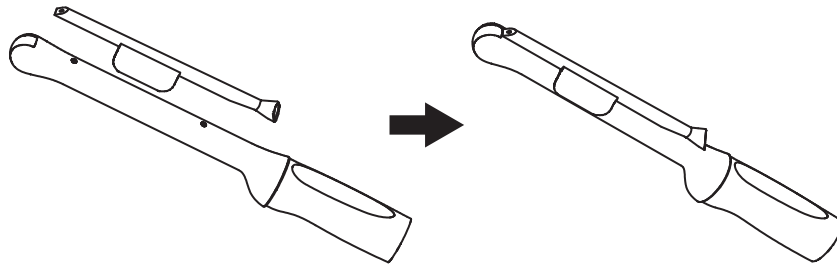

- c. Hold the probe, and insert the needle into Needle entry of the needle guide.

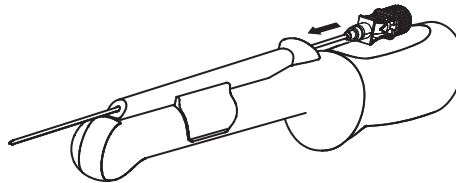

2. Remove the needle-guided bracket:
a. Hold the probe and remove the needle.

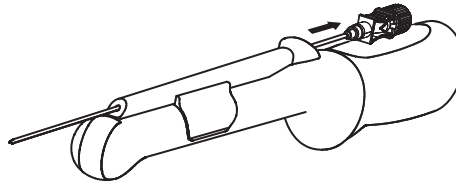

- b. Hold the probe and raise the needle-guided bracket to separate the locating bulge from the locating grooves.

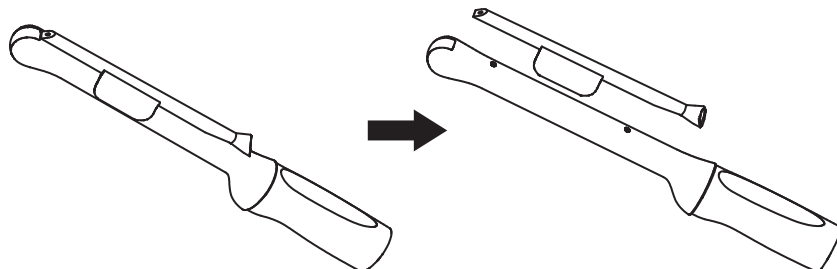

NGB-053 Metal-needle detachable needle-guided bracket

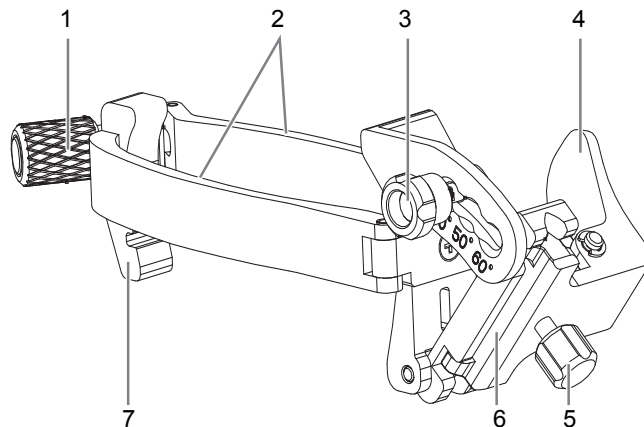

1	Clamp pinch nut
2	Clamps
3	Angle pinch nut
4	Separation pressure position
5	Needle type adjusting nut
6	Needle guide hole
7	The location position block

Perform the following procedure:

1. Install the needle-guided bracket:
 - a. Put on the sterile probe sheath.
 - b. Hold the probe in one hand, select the correct needle-guided bracket and hold it with the other hand. Match the grooves of the needle-guided bracket to the tabs of the probe.
 - c. Mount the bracket onto the probe, and rotate the pinch nut to fix the bracket.
2. Adjust the needle angle to the proper shift as required:
 - a. Loosen the angle pinch nut.
 - b. Adjust the angle block to the desired level.
 - c. Tighten the angle pinch nut.
3. Insert the biopsy needle:
 - a. Hold the probe. Press the separation pressure position to separate needle guided V-shaped block from pressure position of the needle.
 - b. Put the needle into the needle guided-bracket, and the needle leans to V-shaped block.
 - c. Hold the probe, and release the pressure position of the needle. Adjust the needle-type adjusting nut manually. The needle moves smoothly at the vertical direction due to its gravity.
4. Release the needle from the bracket:
 - a. Hold the probe. Press the biopsy needle to separate the needle from pressure position of the needle.
 - b. Separate the bracket and the probe from the needle.

5. Remove the needle-guided bracket:
 - a. Rotate the pinch nut of the needle guided-bracket.
The needle guided-bracket is separate from the probe.
 - b. Hold the probe and take out the bracket.

16.2.3 Verifying the Biopsy Guide Line

WARNING

- Prior to each biopsy procedure, be sure to verify the guide line.
 - If the needle is not consistent with the guide line, **DO NOT** perform the biopsy procedure.
-

NOTE:

You can perform guide line verification on a single live B/C image, and all biopsy-irrelevant operations are forbidden.

Adjusting the needle mark is necessary before each biopsy procedure.

Perform the following procedure:

1. Confirm that the needle-guided bracket has been installed securely in the correct position.
2. Prepare a container filled with sterile water.
3. Place the head of the probe in the sterile water and place a biopsy needle in the needle guide.
4. When the biopsy needle appears on the image, confirm that the biopsy needle is displayed at almost the same position as the selected needle mark.
5. Tap [Biopsy] to enter Biopsy.
 - Select the biopsy bracket angle/guide line: If the needle-guided bracket supports more than one biopsy angle, select the angle/guideline by using [Biopsy Kit].
 - Select the guide line dot size: Tap [Dot Size] to select the dot size.

NOTE:

- The distance between two dots is depth-dependent. Move the cursor over the big dot and a numeral, representing the biopsy depth, is displayed.
 - The biopsy guidezone adjusts along with image adjustments, such as image inversion/rotations, zoom and depth changes.
 - When the imaging depth and area are changed, the guide line is adjusted.
6. Tap [Verify] in the Biopsy tab to open the Biopsy Verify menu.
 - Adjust the guide line position: Use [Position] to change the position of the guide line.
 - Adjust the angle: Use [Angle] to change the guide line angle.
 - Save the verified settings: After the position and angle of the guide line are adjusted, tap [Save] and the system saves the current guide line settings. If biopsy is entered again, the displayed Position and Angle are the verified value.
 - Restore the factory default settings: Tap [Load Factory] and the position and angle of the guide line are restored to the factory default settings.
 - Exit biopsy verify status: Tap [Exit] and the system exits the guide line verification status.

16.2.4 Starting the biopsy procedure

DANGER

- Ensure that all guide parts are properly fixed prior to performing a biopsy.
- If you changed the probe or needle-guided bracket during the biopsy, verify the guide line again.
- Failure to match the guide zone displayed to the guide may cause the needle to track a path outside the zone.
- It is extremely important that when using the adjustable angle biopsy guides, the angle displayed on the screen matches the angle set on the guide, otherwise the needle will not follow the displayed guide zone and this could result in repeated biopsies or patient injury.

Perform the following procedure:

1. Select the correct needle-guided bracket and needle and install them properly.
2. Tap [Biopsy] to enter the biopsy.

If the current probe has no corresponding bracket, or the image is frozen and the guide line was hidden before the image was frozen, then you cannot enter the Biopsy menu.

3. Select the bracket and guide line according to the actual situation.

Tap [Verify] to enter Biopsy Verify menu to fine tune the guide line if needed.

4. If available, use iNeedle function to help enhance the needle visualization when the needle display is not clear.

iNeedle is an option.

- a. Tap [iNeedle] in B menu.

The parameters that can be adjusted appear on the menu:

[B/iNeedle]: tap to display B image and iNeedle image synchronously.

[Needle Dir.]: select to adjust the needle direction display according to actual direction of needle insertion. The iNeedle affecting region changes correspondingly.

- b. Tap [iNeedle] again to exit iNeedle.
5. Scan to locate the target. Center the target in the electronic guidezone path.
 6. Direct the needle into the area of interest for specimen.
 7. After extracting the biopsy sample is complete, gently remove the probe from the body.
 8. Tap [Exit] to exit the Biopsy menu
 9. Disassemble the items and properly dispose of these items as required.

16.2.5 Clean and Sterilize the Needle-Guided Bracket

CAUTION

- Needle-guided brackets whose name starts with NGB are reusable, and need thorough cleaning and sterilization before and after each biopsy.
- Follow local regulations when selecting and using the disinfectant.

- Repeated sterilization may degrade the safety and performance of the needle-guided bracket. Before use, please check whether the needle-guided bracket has defects such as deformation and rusting. If such defects exist, the bracket has reached the end of its service life. In this case, stop using it and contact the Mindray service department.
- It is recommended to use immersion sterilization for plastic needle-guided brackets and high-pressure steam sterilization for metal needle-guided brackets.
- For detailed operations about the cleaning solvent, sterilant and high-temperature steam sterilizer, see the respective operator's manuals provided by the manufacturer.

NOTE:

Disposable components are packaged sterile and are single-use only. Do not use if integrity of packaging is violated or if expiration date has passed. Please use the disposable components compliant with the relevant local regulations.

Cleaning

Perform the following procedure:

1. Wear a pair of gloves to prevent infection.
2. After use, immerse the needle-guided bracket in distilled water immediately to prevent dirt from drying. Wipe the entire surface of the needle-guided bracket by using a piece of disposable lint-free soft cloth to remove coarse dirt.
3. Prepare a cleaning solvent (enzymatic or neutral pH detergent, e.g., liquinox, MetriZyme) by using distilled or softened water in accordance with the operator's manual provided by the manufacturer.
4. Detach all the detachable parts of the needle-guided bracket and immerse the needle-guided bracket and all its parts fully in the cleaning solvent for at least 1 minute or a period specified by the manufacturer.
5. Immerse the needle-guided bracket and all its parts fully in the cleaning solvent. Wipe and wash the surface and connecting parts of the needle-guided bracket gently by using a soft brush until no dirt is visible. Place the needle-guided bracket inside an ultrasonic cleaner and perform ultrasonic cleaning for 3–5 minutes.
6. Rinse the needle-guided bracket thoroughly by using a large amount of distilled or softened water (about 2 gallons) at room temperature for about 30 s to remove the residual dirt and cleaning solvent. Repeat the operation twice.
7. Wipe away the water on the needle-guided bracket by using a piece of disposable lint-free soft cloth.
8. Inspect the needle-guided bracket. If visible dirt still exists, repeat the preceding steps to wash the bracket until it is all clean.

Sterilization with a sterilant

Perform the following procedure:

1. Wear a pair of gloves to prevent infection.
2. Clean thoroughly in accordance with the cleaning procedure before sterilization.

3. Prepare a sterilant by using sterile distilled water when necessary.

Table 16-5 Recommended sterilization solution

Chemical name	Trade name	Procedures
Glutaraldehyde (2.4%)	Cidex Activated Dialdehyde Solution (applicable for FDA region only)	Refer to the instructions provided by the solution manufacturer for details.
22% Hydrogen Peroxide 4.5% Peroxyacetic Acid	Minnicare liquid disinfectant (applicable for Canada only)	Refer to the instructions provided by the solution manufacturer for details.
Glutaraldehyde (2.6%)	Metricide	Refer to the instructions provided by the solution manufacturer for details.

4. Immerse the needle-guided bracket fully in the sterilant and shake the bracket appropriately to remove any bubbles on the surface. Use a syringe to draw an appropriate amount of sterilant and inject the sterilant into the hole to remove the bubbles inside the hole if necessary.

For details about the immersion duration, see the operator's manual provided by the manufacturer.
5. After sterilization, wash the needle-guided bracket thoroughly by using a large amount of sterile distilled water (about 2 gallons) at room temperature for about 30 s to remove the residual sterilant. Repeat the operation twice.
6. Dry the needle-guided bracket by using a piece of sterile disposable lint-free soft cloth.
7. Store the needle-guided bracket in a cool, clean and dry environment.

High-pressure steam sterilization

Perform the following procedure:

1. Wear a pair of gloves to prevent infection.
2. Clean thoroughly in accordance with the cleaning procedure before sterilization.
3. Package the needle-guided bracket in accordance with the sterilization requirements of surgical instruments.
4. Place the packaged needle-guided bracket inside a high-temperature steam sterilizer and perform sterilization. The sterilization parameters are 121 °C and 30 minutes for a gravity displacement steam sterilizer and are 132 °C and 4 minutes for a dynamic-air-removal steam sterilizer.
5. Take out the sterilization package after sterilization and dry it in an oven at 60 °C for 20 minutes to 30 minutes.

Keep the sterilization package together with other sterilized surgical instruments in a sterile item storage area.

High-pressure steam sterilization is preferred for the metal guided brackets. And the sterilizer and accessories should be cleared by FDA for the intended sterilization cycle.

Perform the following procedure:

1. Wear a pair of gloves to prevent infection.
2. Clean thoroughly in accordance with the cleaning procedure before sterilization.
3. Package the needle-guided bracket in accordance with the sterilization requirements of surgical instruments using the sterilization wrap or pouch cleared by FDA.

4. Place the packaged needle-guided bracket inside a high-temperature steam sterilizer and perform sterilization. The sterilization parameters are 121 °C and 30 minutes for a gravity displacement steam sterilizer and are 132 °C and 4 minutes for a dynamic-air-removal steam sterilizer.
5. Take out the sterilization package after sterilization and dry it in an oven at 60 °C for 20 minutes to 30 minutes.

Keep the sterilization package together with other sterilized surgical instruments in a sterile item storage area.

16.2.6 Storage and Transportation

- Do not use the carrying case for storing the needle-guided bracket. If the carrying case is used for storage, it may become a source of infection.
- Between examinations, keep the needle-guided bracket in a sterile environment.
- If the needle-guided bracket is sent to your MINDRAY representative for repair, be sure to disinfect or sterilize it and keep it in the carrying case to prevent infection.
- Sterilize the carrying case as necessary.
- Store or transport the needle-guided bracket under the following ambient conditions:
 - Ambient temperature: -20 °C to 55 °C
 - Relative humidity: 20% to 85% (no condensation)

16.2.7 Disposal

Be sure to sterilize the needle-guided bracket before disposing of it.

Contact your MINDRAY representative when disposing of this device.

16.3 Middle Line

Middle Line helps to locate and observe the focus point of lithotripsy wave during lithotripsy treatment. By means of providing information for the lithotripsy machine as well as a tool for watching the procedure of lithotripsy in real-time, you can adjust the intension and frequency of the lithotripsy wave through lithotripsy machine.

NOTE:

This function in the ultrasound system is for lesion (stone) location and observation only. For details, please refer to lithotripsy machine accompanying manuals.

Tap [Biopsy] > [Middle Line] or press the user-defined key for “Middle Line” to turn on the function.

- The middle line is a vertical dotted line located in the middle of the screen, the position and direction of which cannot be changed.
- There is a mark icon of “×” located on the middle line which can be moved up and down along the line by using the trackball/trackpad.
- To use the Middle Line function of the ultrasound system:
 - a. Use the trackball/trackpad to change the mark position and by adjusting lithotripsy machine tools or patient posture to locate the stone center at the mark.
 - b. Read the depth of the mark by observing the depth caliper on the screen.
 - c. After the stone is located, refer to lithotripsy machine manuals to perform the lithotripsy.
- The depth of the mark is displayed in the image parameter area of the screen.

16.4 eSpacial Navi

The eSpacial Navi function builds up the connection between the ultrasound system and the processed needles. The needle position appears on the image in real time. Meanwhile, the virtual needle mark guides the needle path on the ultrasound image. Based on the magnetic induction technology, the eSpacial Navi function aids in and enhance the ultrasound needle guidance.

WARNING

- Ultrasound images should be referenced during the whole process of needle guidance.
 - The magnetizer should be used with the needle cap. Disinfect the magnetizer after use.
 - The needle cap is a sterile, single use device. To maintain procedural sterility, it is important that the needle cap is isolated from non-sterile objects.
-

CAUTION

- Keep the magnetizer away from any device that is sensitive to magnetic fields. Never place or hold the magnetizer within 1 m of the probe.
 - The eSpacial Navi system supports only the needle types listed on the needle list. For details, see “16.4.1 Interface”.
 - Keep the L11-3VNs and L12-3VNs away from the source of disturbance, such as metal objects and magnetized objects. Do not use or store L11-3VNs and L12-3VNs in the vicinity of strong electric or magnetic fields.
-

NOTE:

- When used under optimal operating conditions by an experienced medical professional, the eSpacial Navi system can achieve precision as high as ± 2.4 mm.
 - Place the magnetizer in the proper position to prevent the magnetizer from falling off or becoming damaged.
 - DO NOT make the magnetizer overheated (more than 50 °C) during cleaning and disinfections. High temperature may cause the magnetizer to become deformed or damaged.
-

16.4.1 Interface

In Plane Needle Guidance GUI

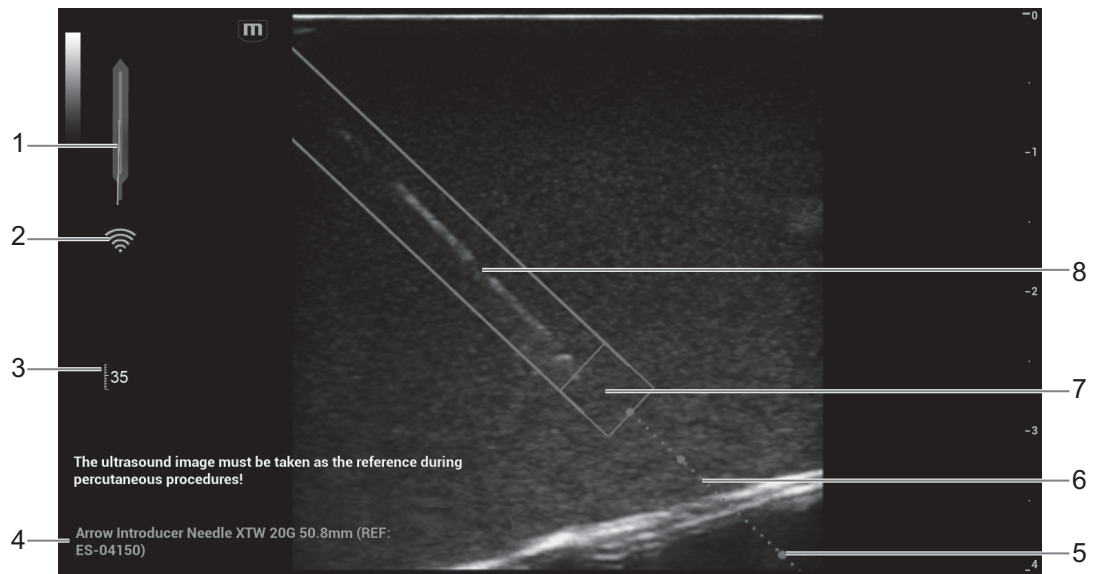

1	Alignment indicator (plan view)
2	Filed strength
3	Maximum depth at which the needle can be detected
4	Selected needle type
5	Scale of guideline (5 mm/scale)
6	Needle guidance trajectory
7	Needle tip position in the ultrasound plane
8	Needle position in the ultrasound plane

Out of Plane Needle Guidance GUI

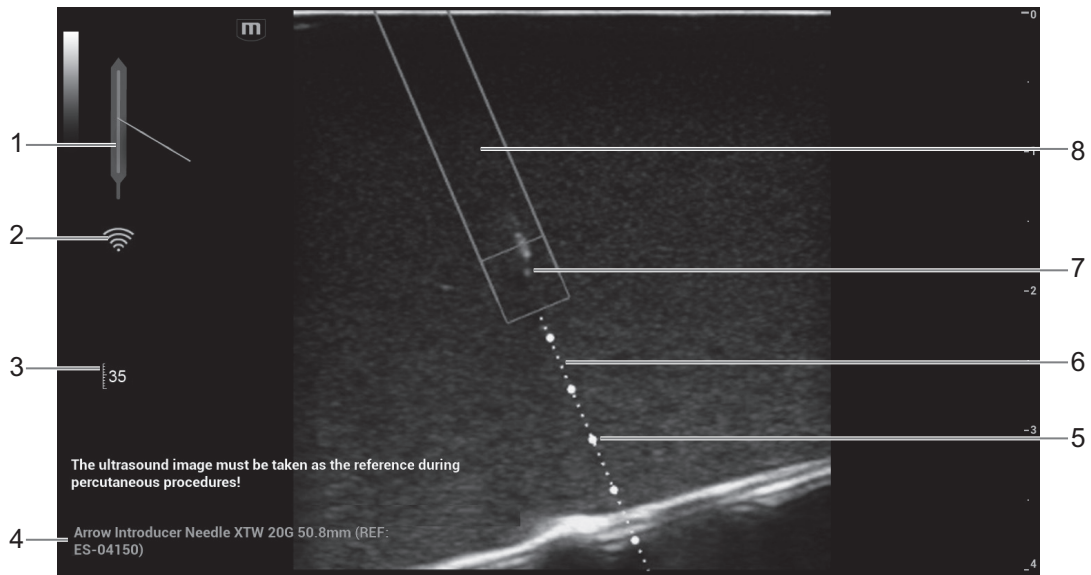

1	Alignment indicator (plan view)
2	Filed strength
3	Maximum depth at which the needle can be detected
4	Selected needle type
5	Scale of guideline (5 mm/scale)
6	Projection position of the needle guidance trajectory in the ultrasound plane
7	Position at which the needle cross the ultrasound plane
8	Needle projection position in the ultrasound plane

16.4.2 Preset

eSpatial Navi Needle Menu

Select [eSpatial Navi] > [eS.Navi Needle] to enter the “eS.Navi Needle” menu.

Controls are as shown in Table 16-6.

Table 16-6 eSpatial Navi Needle settings

Item	Description
Needle	Select the desired needle from the drop-down list. You can set the most frequently used needle to a favorite one.
Display Favourite Only	After it is ticked, only the favorite needles are displayed on the needles list.
Auto Optimize	After it is ticked, the system adjusts focus position automatically according to the position of the needle tip, and enable or disable ExFOV function.

eS.Navi Settings Menu

Tap [eSpatial Navi] > [eS.Navi Settings] to enter the “eS.Navi Settings” menu, and tap the items to be displayed on the screen.

16.4.3 Preparation Before Needle Guidance

NOTE:

Before and during calibration, keep the probe away from the magnetic sources, such as metal objects, electrical motors, switching power supplies, nerve stimulators and similar medical devices.

Perform the following procedure:

1. Scan the target tissue and adjust the image parameters.
2. Check the field strength to ensure that the field strength indicator is . If the field strength is low, hold the probe and tap [Calibrate] on “eS.Navi Needle” menu. Do not move the probe during the calibration.

Indicator Colors	Description
Green	Low magnetic interference: appropriate for needle guidance.
Yellow	Medium magnetic interference: be cautious for needle guidance.
Red	High magnetic interference: do not perform needle guidance.

3. Magnetize a needle cap.
 - a. Place an appropriate sterile needle cap (length: 3.5cm to 4.5cm, diameter < 7 mm, with bottom closed) into the magnetizer.





- b. Introduce a needle into the cap, and ensure that the needle tip contacts the bottom of the needle cap.
If the needle cap associated with the needle does not meet the requirements, you are recommended to use BBraunSterican <35 mm needles cap or B&D Microlance <35 mm needles cap.



- c. Hold the needle for 1 or 2 seconds and then withdraw it quickly from the magnetizer.

16.4.4 Procedure

NOTE:

- The Pan Zoom function is not supported on eSpacial Navi mode.
- Do not freeze the ultrasound image during the procedure. Otherwise, biopsy guidance information will disappear.
- When the insertion angle of a needle relative to the skin surface exceeds 60°,  is displayed on screen to notify users to adjust the angle. After the angle is smaller than 60°,  disappears.

Perform the following procedure:

1. Hold the probe stably and put the needle close to the probe for connection. After the needle and probe are successfully connected, the system automatically calculate the maximum depth at which the needle can be detected in real time, and display the depth value in the touch screen.

When the actual depth is greater than the maximum value, the needle guidance information disappears temporarily.

2. Adjust the needle position and angle to define the position for inserting the needle.

Pay attention to the field strength during the needle guidance process.

16.4.5 Magnetizer Cleaning and Disinfection

After use, clean and disinfect the magnetizer as required. Failure to do so may result in the magnetizer becoming sources of infection.

 CAUTION

- When performing cleaning and disinfection of the magnetizer to prevent infection, wear sterile gloves.
- After disinfection, rinse the magnetizer thoroughly with sterile water to remove all chemical residues.
- No cleaning and disinfecting may result in the magnetizer becoming a source of infection.
- Please follow the disinfectant manufacturer's manual for performing cleaning and disinfection, including preparing sterile water and cleaning and disinfection time.

NOTE:

- Please refer to the instructions provided by the manufacturer of the disinfectant for details.
 - The magnetizer can be disinfected using the compatible disinfectants at least 500 times.
-

Compatible disinfectants for the magnetizer are shown in Table 16-7.

Table 16-7 Compatible disinfectants

Trade Name	Manufacturer	Chemical Name	Procedures
Surfa'safe	Anios Laboratoires	didecyldimethylammonium chloride 1.4mg/g; polyhexamethylene biguanide hydrochloride 0.96mg/g	Sprays, fungicidal in 20 min T.B in 15 min
Sani-Cloth [®] Plus	PDI	n-Alkyl dimethyl benzyl ammonium chloride; n-Alkyl ethylbenzyl ammonium chloride	Wipes, 3 min
Oxivir ^{TM/MC} Tb	Diversey	0.5% hydrogen peroxide	Sprays, 10 min
CLEANISEPT [®] WIPES	DR.SCHUMACHE R GMBH	0.25g didecyldimethylammoniumchloride; 0.5g quaternary ammonium compounds; benzyl-C12-16-alkyldimethyl-; chlorides	Wipes, 2 min
mikrozid [®] AF Wipes Jumbo	SCHÜLKE	25% ethanol; 35% propan-1-ol	Wipes, 15 min
IODOCLEAN	Anios Laboratoires	sodium thiosulfate and excipients	Sprays, 5 ~ 15 min
tristel duo	TRISTEL SOLUTIONS	chlorine dioxide	Sprays, 1 min
75% alcohol	/	alcohol	Solution, 3 min
iodophor	/	/	Solution, 3 min

Cleaning

Perform the following procedure:

1. Wear sterile gloves to prevent infection.
2. Wash the magnetizer with clean water or soapy water to remove all the foreign matters, or, wipe the magnetizer with a soft ethyl carbamate sponge.
Avoid using a brush, because it may damage the magnetizer.
3. Dry the magnetizer using a sterile cloth or gauze after rinsing. Do not dry the magnetizer by heating it.

Disinfecting with Sprays or Wipes

CAUTION

Use protective eyewear when disinfecting using sprays.

Perform the following procedure:

1. Wear sterile gloves to prevent infection.
2. After you have finished cleaning, wipe or spray the magnetizer with a disinfectant.
Follow the disinfectant manufacturer's recommended contact time and mode.

3. Remove any residue with a water-moistened soft cloth on the magnetizer.
4. Wipe off water on the magnetizer using sterile cloth or gauze after washing.

Disinfecting by Immersion

Perform the following procedure:

1. Wear sterile gloves to prevent infection.
2. Clean the magnetizer before disinfecting it. MINDRAY recommends the compatible solutions to disinfect the magnetizer.
 - Refer to the instructions provided by the chemical manufacturer concerning concentration of the disinfectant solution, method of disinfection and dilution and cautions during use.
 - Soak the magnetizer into the disinfectant solution for the shortest time the manufacturer recommends.
 - Follow local regulations when selecting and using the disinfectant.
3. Rinse the magnetizer with plenty of water (about 2 gallons) for at least 1 minute to remove all chemical residues on it. Or, follow the rinsing method recommended by the disinfectant manufacturer to rinse the magnetizer.
4. Wipe off the water on the magnetizer with sterile cloth or gauze after rinsing it. Do not dry the magnetizer by heating.

16.4.6 Storage and Transportation

When all examinations for the day have been completed, confirm that the magnetizer is in good condition. After disinfecting the magnetizer, confirm that the magnetizer is in good condition and stored in a suitable place.

- To prevent the magnetizer from being damaged, DO NOT store it where it may be exposed to:
 - Direct sunlight
 - Sudden changes in temperature
 - Dust
 - Excessive vibration
 - Heat generators
- Store and transport the magnetizer in the ambient temperature range of -40 °C to 50 °C.
- Sterilize the carrying case as necessary.

16.4.7 Disposal

Be sure to disinfect the magnetizer before disposing of it.

Contact your MINDRAY representative when disposing of this device.

17 DVR Recording

NOTE:

- Strictly observe the procedures described here to perform the recording and replaying operations; otherwise it may result in data loss or system malfunction.
 - Set the PAL or NTSC in the setup and this shall be consistent with that in the DVR.
 - Accidental exposure to strong electromagnetic fields or mishandling of the video cassette may result in image and data loss, so check if the recording is successful as soon as possible. Mindray is not responsible for any data loss.
-

The system provides built-in DVR recording function. You can use the DVR to record and replay videos and audios that can be stored in DVD disc or hard disc.



The recorded video is AVI format; you can save it in the hard disk drive, burn to the DVD or export to the USB disk.

When the built-in DVR is in normal status, the  displays at the lower right corner of the screen.

17.1 Start Recording

After recording, the system will save the recording file automatically, you can select to save in local disk, U disk or optical disk.

Perform the following procedure:

1. Perform ultrasound exams, select appropriate views and adjust parameters to prepare for recording.
2. Click  to open the dialog box and select desired recording type: Hard disk/USB/CDRO.
3. Click [Close] to enter recording status.
4. Press the user-defined key for “DVR” and click [OK] to start recording, and the DVR icon displays as  in recording status.

During the recording process, you can perform imaging mode switching, comments adding, body mark adding and measurements.

5. Press the user-defined key for “DVR” again to stop recording, the DVR icon in the lower right corner turns into data transfer status .
 - If USB/CDROM is selected, the system sends the recorded file to the target storage media (USB disk or DVD optical disk drive) in the meantime.
 - If “Hard disk” is selected, the system saves the file to the path: D:\Monet\DVR.

In the patient task management screen, click [Media Storage Task] tab to check transferring status.

17.2 Send Image

The system also supports exporting recorded images that are saved in the local disk.

Perform the following procedure:

1. Click  to open the dialog box, and click [Local Video Management] to enter the managing dialog box.

Click [Rename] to rename the video file.

2. Select the destination and the target file, click [Send] to send the file to the selected path. During sending progress, the icon displays as .

17.3 DVR Video Replay

You can replay the video and audio record.

17.3.1 Replay on PC

Connect the USB disk or optical disk with the file to the PC, open the file directly.

17.3.2 Replay on the ultrasound system

Perform the following procedure:

1. Click  to open the dialog box and select desired playing type: Hard disk/USB/CDROM.
2. Click [Play] to open the dialog box.
3. Select the path and name for the file and then click [OK] to replay the file, or double-click the file name directly.

18 System Maintenance

Routine system maintenance shall be carried out by the user. System maintenance after the warranty has expired is the full responsibility of the owner/operator.

The responsibility for maintenance and management of the product after delivery resides with the customer who has purchased the product.

If you have any questions, please contact Mindray Customer Service Department or sales representative.

WARNING

- Only an authorized Mindray service engineer can perform maintenance not specified in this operator's manual.
 - For the sake of the system performance and safety, you should perform periodical checks for the system.
-

18.1 Daily Maintenance

You are responsible for daily maintenance.

18.1.1 Cleaning the System

WARNING

- Before cleaning the system, be sure to turn off the power and disconnect the power cord from the outlet. Cleaning the system while the power is "On" may result in electric shock.
Especially, the touch screen and control panel of the system equipped with trackpad can be cleaned on power-on status: tap > bar in the left side of the touch screen to enter the Exam Main Menu screen and select  to lock the system for 10 seconds while the power is "On"; before cleaning other parts of the system, be sure to turn off the power and disconnect the power cord from the outlet; or, it may result in electric shock while the power is "On".
 - DO NOT directly spray solution onto the monitor, system control panel or hard surfaces that is under pressure or pumped. Ingress fluid leakage into the monitor or system can damage the monitor or system, causing possible electric shock or system failure.
-

⚠ CAUTION

Do not spill water or other liquid into the system while you perform the cleaning. Otherwise it may result in malfunction or electric shock.

NOTE:

- DO NOT use hydrocarbon glass cleaner or cleaner for OA (Office Automation) equipment to clean the monitor. These substances may cause deterioration of the monitor.
 - Please clean the control panel periodically, otherwise the button may be blocked by dirt and the system will be buzzing while the button makes no response.
-

Cleaning probes

Tools: mild soapy water, dry soft cloth, soft brush

Method:

1. Wipe out the dust attached to surface of probe head, connector and cable.
 2. Use soft brush to brush the dust inside probe connector gently.
 3. Remained stain or dust attached to surface of cable or surface of connector should be washed out by cloth with a little soapy water, and then air-dry.
-

NOTE:

Don't use cloth with water to clean the probe connector.

Cleaning holders

Tools: soft dry cloth, soapy water, soft brush.

Remaining stains should be wiped away using a cloth with clean or soapy water and the surface left to air dry.

Perform the following procedure:

1. Use a soft dry cloth to wipe away dust attached to the inside, outside and gaps in the probe holder. Use a soft brush to brush away dust or stains from the small intra-cavity probe holder or its gap.
2. Remaining stains on the inside and outside of the holder should be wiped away using a cloth with a little soapy water and then air dried.

Cleaning the monitor and the touch screen

Tool: soft dry cloth, soapy water

The surfaces of the monitor and touch screen should be cleaned with a soft dry cloth. Remaining stains should be wiped away using a cloth with a little soapy water and then air dried.

Cleaning the main panel

Tools: soft dry cloth, soapy water

1. Use a soft dry cloth to clean the surface of the control panel.

If the control panel is dirty, moisten the soft cloth with a little mild soapy water and wipe away any stains.

2. Use another soft dry cloth to remove any moisture and allow all hard surfaces to completely air dry.

If the control panel is difficult to clean, disassemble the key caps first and then clean it with mild soapy water.

Cleaning the trackball

Tools: paper, dry cloth, mild soapy water

For the stable performance of the system, you should perform periodical cleaning for the trackball. A dumb cursor may be resulted from dirt inside the trackball.

Perform the following procedure:

1. Disassembling:

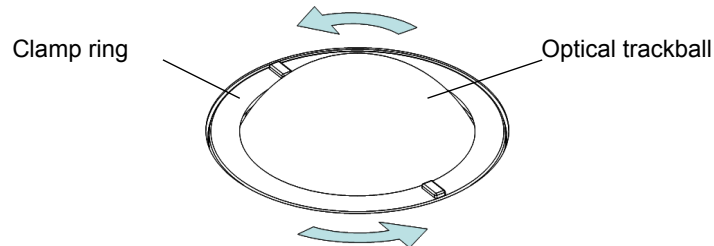

Rotate the trackball clamp ring anticlockwise. When the clamping ring lifts, remove the clamping ring and trackball. You can draw out the ball with the help of adhesive tape.

2. Cleaning:

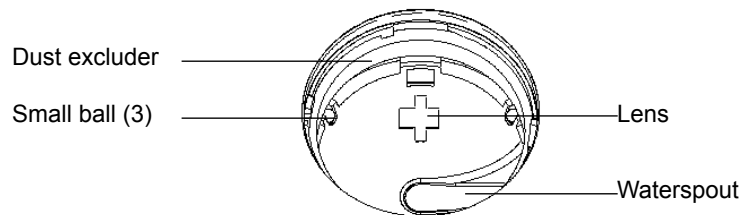

Clean the lens slightly using the tissue until there is no foreign matter. Then clean the other parts and the dust excluder. Make sure to exert force properly when clean the small ball, otherwise, the small ball may drop down.

When liquid is spray onto the trackball area, most of the liquid can be discharged through the waterspout, besides, you can dry the leaving water using the tissue or cloth.

3. Installing:

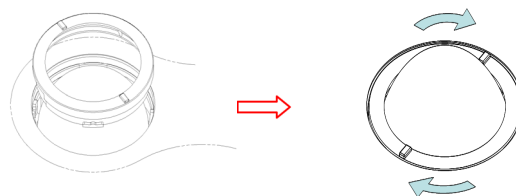

Put back the ball, align the buckle with gap of the front cover, press the clamp ring with both hands and rotate it clockwise to click the buckle. At this moment, the clamp ring cannot be moved any further, it indicates that the clamp ring clicks in position.

Cleaning the dust-proof covers

CAUTION

Please clean all dust-proof covers of the system periodically (1 time per month); otherwise, system damage may result. Cleaning times can be increased when the system is used in the open air or somewhere dust is more.

Tool: soft brush

Method:

Disassemble dust-proof cover before cleaning.

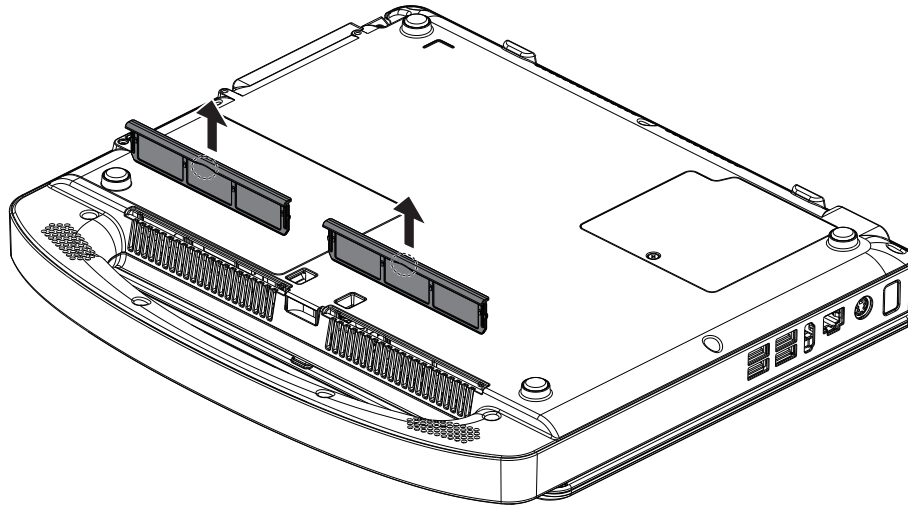

18.1.2 Disinfecting the Main Unit

For details about disinfecting the main unit, please refer to the Cleaning, Disinfection & Sterilization Guide.

18.1.3 Cleaning the peripherals

Do the cleaning maintenance according to your actual peripheral configuration; items which are not configured can be skipped.

Content	Description
Color and B/W video printer	First wipe off dust or stain attached to the cover of printer with soft dry cloth, then clean the inside of printer. Be sure to do the cleaning maintenance according to the operation manual if necessary.
Graph / text printer	First wipe off dust or stain attached to the cover of printer with soft dry cloth, then clean the inside of printer. Be sure to do the cleaning maintenance according to the operation manual if necessary.
Footswitch	Use soft dry cloth with a little mild soap water to wipe off the dust or stain attached to the pedals or cable of foot switch.
Barcode reader	First use soft dry cloth to wipe off dust attached to glass panel of the reader, then the dust or strain attached to cable and bracket.

18.1.4 Checking the Probe

- Visually check to confirm that there are no cracks or expansion of the probe head.
- Visually check to confirm that there is no deterioration or erosion of the probe cable.
- Visually check to confirm that none of the connector pins are bent, destroyed or falling off.

18.1.5 Checking the Power Cable and Plug

Visually check to confirm that there are no wrinkles, cracks or deterioration, and no cracks or expansion on the surface of the adapter.

Manually check to confirm that there is no looseness or rupture. The connection of the plug is reliable.

18.1.6 Checking Appearance

Check if there are any cracks in the covers:

- Ultrasound system covers.
- Probe appearance.
- External appearance of the ECG lead.

18.1.7 System Hard Drive Backup

To prevent deterioration or loss of data stored in the system hard drive (including patient info data, preset data, etc.), create a backup copy of the hard drive at regular intervals.

18.2 Troubleshooting

If any persistent system malfunction is experienced, e.g., an onscreen error message, blank imaging screen, absent menus, see the table below. If the failure cannot be resolved, contact the Mindray Customer Service Department or a sales representative.

No.	Failure	Cause	Measure
1.	The power indicator of the monitor is lit up, but the image is blank.	The interval between turning off and restarting the system is too short - wait at least 20 seconds.	Turn off the system and wait at least 1 minute, then restart the system.
		The monitor brightness or contrast may be improperly set.	Adjust the monitor brightness and contrast back to the factory defaults.
2.	The monitor displays the characters and menus but no images.	The transmission power, overall gain or TGC controls are improperly set.	Adjust the transmission power, gain or TGC control.
		Check that a probe is connected and/or fully connected.	Ensure proper probe connection.
		The system is in freeze status.	Unfreeze the image.

No.	Failure	Cause	Measure
3.	The image quality is degraded	The exam mode is incorrect.	Select an appropriate exam mode.
The image post-processing settings are incorrect.		Adjust the image post-processing settings or reset post-processing to the default values.	
The image presets are inappropriate.		Reset the factory default presets.	
4.	The button does not respond and the system is buzzing	There is dirt blocking the button.	Check the control panel for the blocked button and press it several times to release it.
Clean the button.			

A Barcode Reader

The product supports two kinds of readers for logging data as patient ID. For details of the JADAK or Honeywell barcode readers, please refer to the accompanying manuals.

The laser transmitted by SYMBOL LS2208 is Class 2 laser.

SYMBOL DS4308 is classified as “EXEMPT RISK GROUP” according to IEC 62471:2006 and EN 62471:2008.

WARNING

- Class 2 laser adopts low power, visible LED. DO NOT stare into beam because of unknown hazards of transient radiation provided by class 2 laser.
 - DO NOT stare into beam emitted by SYMBOL DS4308 for more than 10 s.
-

CAUTION

Ensure the information acquired by barcode reader is consistent with the actual information.

TIP:

The reader does not support decoding of Multi-language.

A.1 1-D Barcode Reader

There are 2 operation modes for 1-D barcode readers:

- Hand-held mode: press the trigger to decode.
- Hands-free mode: seat the reader in the stand to enter the mode, the reader decodes automatically.



1	LED	<ul style="list-style-type: none"> • Green: A barcode was successfully decoded. • Red: A data transmission error or reader malfunction occurred.
2	Scan window	Scan the barcode.
3	Trigger	Press to decode.

A.1.1 Setting Up the Reader (Take LS2208 as an example)

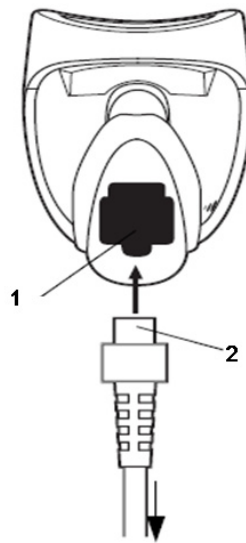

1	Cable interface port
2	Interface cable modular connector

Perform the following procedure:

1. Plug the interface cable modular connector into the cable interface port on the bottom of the reader handle, and ensure the connector is properly secured.
2. Connect the other end of the interface cable to the host.

A.1.2 Setting

The reader has factory settings; please refer to A.4 for details.

The reader supports some user-defined functions as introduced below.

For more details, please contact the SYMBOL reader agents or Mindray Customer Service Department.

Volume setting

Scan the following barcode to set the volume parameter.

- Low Volume:



Low Volume

- Medium Volume:



Medium Volume

- High Volume:



High Volume

Code 93 and codebar scanning

- To enable or disable Code 93, scan the appropriate barcode below.



Enable Code 93

- To enable Codebar, scan the appropriate barcode below.



Enable Codebar

Code 39 full ASCII scanning

Code 39 Full ASCII is a variant of Code 39 which pairs characters to encode the full ASCII character set. To enable or disable Code 39 Full ASCII, scan the appropriate barcode below.



Enable Code 39 Full ASCII



Disable Code 39 Full ASCII

I 2 of 5 symbols setting:



I 2 of 5 - One Discrete Length

Select this option to decode only I 2 of 5 symbols containing a selected length. Select the length using the numeric barcodes below. For example, to decode only I 2 of 5 symbols with 8 characters, scan I 2 of 5 - One Discrete Length, then scan 0 followed by 8.



A.1.3 Scanning in Hand-Held Mode

Perform the following procedure:

1. Ensure all connections are secure.
2. Aim the reader at the barcode. Press the trigger.

Ensure the scan line crosses every bar and space of the symbol, see the figure below.



3. Upon successful decode, the reader beeps and the LED turns green.

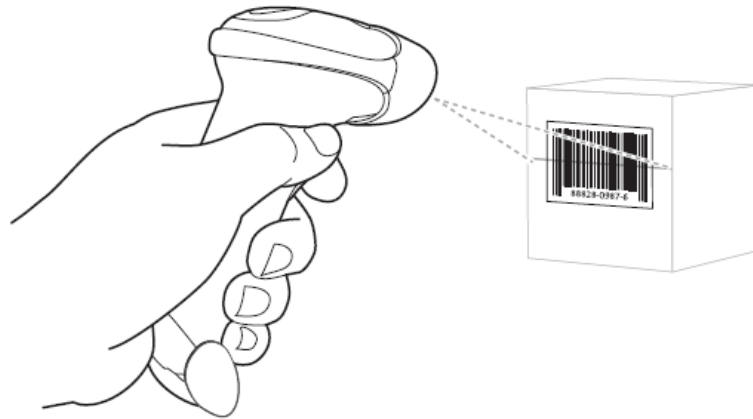

Do not hold the reader directly over the barcode. Laser light reflecting directly back into the reader from the barcode is known as specular reflection. This specular reflection can make decoding difficult. You can tilt the reader up to 55° forward or back and achieve a successful decode.

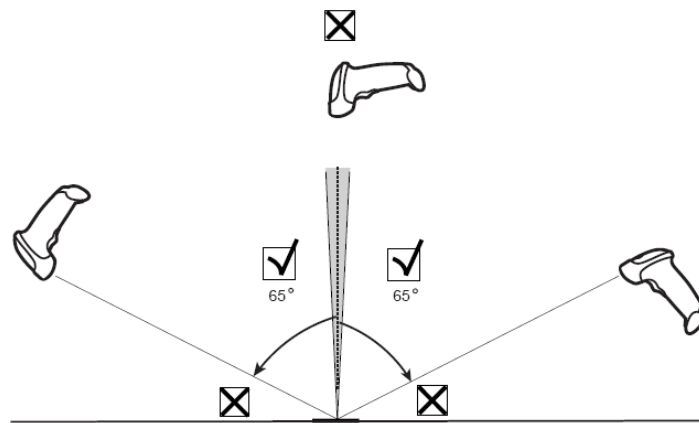

A.1.4 Scanning in Hands-Free Mode

Assembling the Intellistand

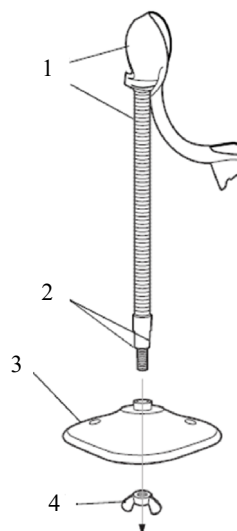

1	One piece scanner “cup” with flexible neck
---	--

2	Flat areas
3	Stand base
4	Wingnut

Perform the following procedure:

1. Unscrew the wingnut from the bottom of the one piece scanner “cup”.
2. Fit the bottom of the neck piece into the opening on the top of the stand base.
3. Tighten the wingnut underneath the base to secure the cup and neck piece to the base.

Before tightening the wingnut under the base, ensure that the flat areas on the flexible neck fit securely in the grooves in the base.

4. Bend the neck to the desired position for scanning.

Mounting the Stand (optional)

You can attach the base of the reader’s stand to a flat surface using two screws or double-sided tape (not provided).

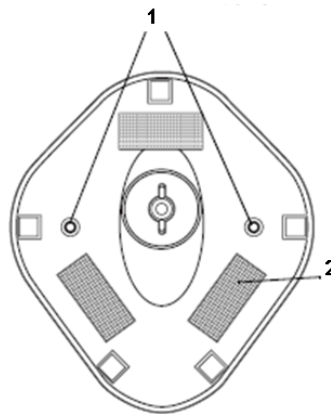

1	Two screw-mount holes	For Screw Mount, follow the steps below: <ol style="list-style-type: none"> 1. Position the assembled base on a flat surface. 2. Screw one #10 wood screw into each screw-mount hole until the base of the stand is secure
2	Double-side tap areas (3 places, dimensions: 1”×2”)	For Tape Mount, follow the steps below: <ol style="list-style-type: none"> 1. Peel the paper liner off one side of each piece of tape and place the sticky surface over each of the three rectangular tape holders. 2. Peel the paper liner off the exposed sides of each piece of tape and press the stand on a flat surface until it is secure.

Perform Scanning in Hands-Free Mode

When the reader is seated in the scanner cup, the reader’s built-in sensor places the reader in hands-free mode. When you remove the reader from the stand it operates in its normal hand-held mode.

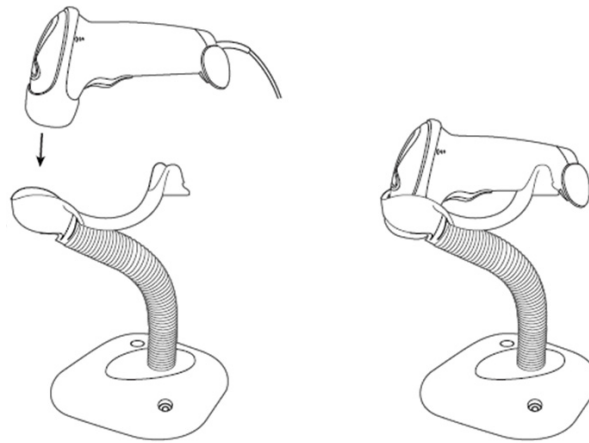

A.2 2D Barcode Reader (Take DS4308 as an example)

The 2-D barcode reader supports hand-held operation mode.

Hand-held mode: press the trigger to decode.

A.2.1 Overview

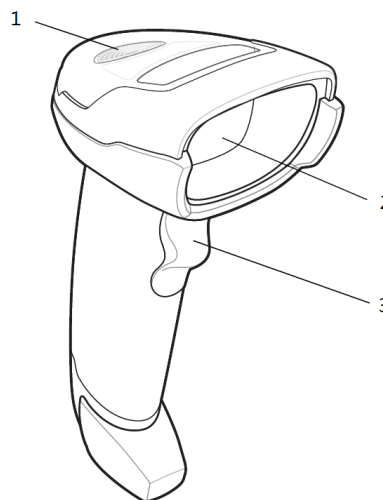

1	LED	<ul style="list-style-type: none"> Green: A barcode was successfully decoded. Red: A data transmission error or reader malfunction occurred.
2	Scan window	Scan the barcode.
3	Trigger	Press to decode.

A.2.2 Setting Up the Digital Imager Reader

Installing the Interface Cable

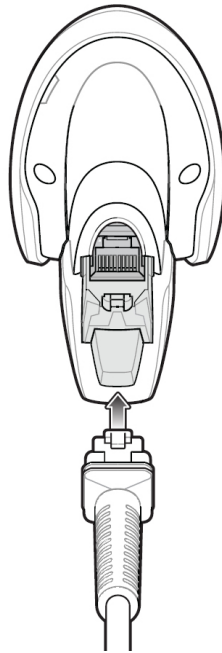

Perform the following procedure:

1. Plug the interface cable modular connector into the cable interface port on the bottom of the reader handle and ensure the connector is properly secure.
2. Connect the other end of the interface cable to the host.

Removing the Interface Cable

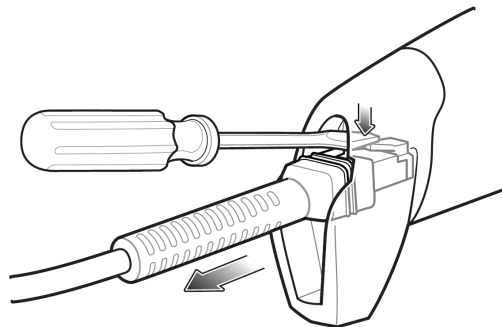

Perform the following procedure:

1. Using the tip of a screwdriver or some other tools with a sharp head, depress the cable's modular connector clip.
2. Carefully slide out the cable.

A.2.3 Setting

The reader has factory settings, for details see “A.4 Parameter Defaults”.

The reader supports some user-defined functions as introduced below.

For more details, please contact the SYMBOL reader agents or Mindray Customer Service Department.

Volume setting

Scan the following barcode to set the volume parameter.

- Low Volume



Low Volume
(2)

- Medium Volume



Medium Volume
(1)

- High Volume



***High Volume**
(0)

Code 93 and codabar setting

- To enable Code 93, scan the appropriate barcode below.



***Enable Code 93**
(1)

- To enable Codabar, scan the appropriate barcode below



***Enable Codabar**
(1)

Code 39 full ASCII setting

Code 39 Full ASCII is a variant of Code 39 which pairs characters to encode the full ASCII character set. To enable or disable Code 39 Full ASCII, scan the appropriate barcode below.



Enable Code 39 Full ASCII
(1)



***Disable Code 39 Full ASCII**
(0)

I 2 of 5 symbols setting



I 2 of 5 - One Discrete Length

Select this option to decode only I 2 of 5 symbols containing a selected length. Select the length using the numeric barcodes below. For example, to decode only I 2 of 5 symbols with 8 characters, scan I 2 of 5 - One Discrete Length, then scan 0 followed by 8.



0



1



2



3



4



5



6



7



8



9

A.2.4 Scanning in Hand-Held Mode

Perform the following procedure:

1. Ensure all connections are secure (see the appropriate host chapter.)
2. Aim the digital imager reader at the barcode.

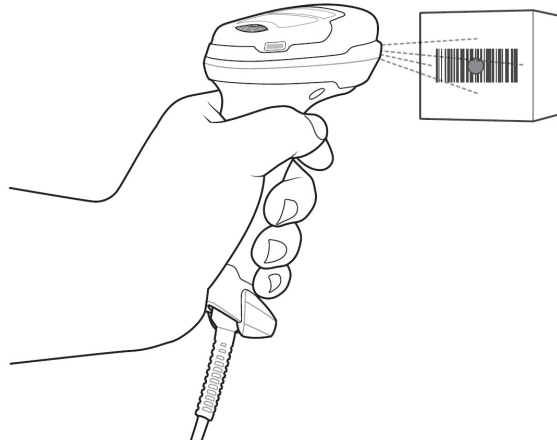

- When the digital imager reader senses movement, in its default Auto Aim trigger mode, it projects a red LED dot which allows positioning the barcode within the field of view.

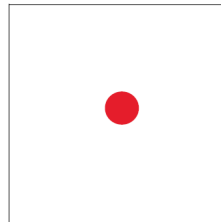

If necessary, the digital imager reader turns on its red LEDs to illuminate the target barcode.

- Center the symbol. Be sure the entire symbol is within the rectangular area formed by the illumination LEDs.

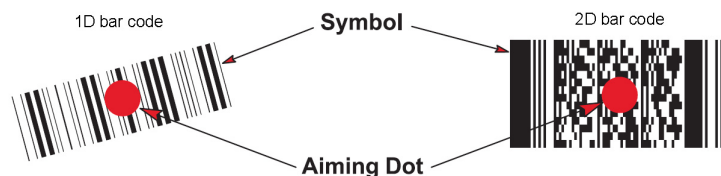

- Hold the trigger until the digital imager reader beeps, indicating the barcode is successfully decoded.

Steps 2 - 4 above may be required to repeat on poor quality or difficult barcodes.

The aiming pattern is smaller when the digital imager reader is closer to the symbol and larger when it is farther from the symbol. Scan symbols with smaller bars or elements (mil size) closer to the digital imager reader, and those with larger bars or elements (mil size) farther from the digital imager reader.

The digital imager reader can also read a barcode presented within the aiming dot not centered. The top examples in show acceptable aiming options, while the bottom examples cannot be decoded.



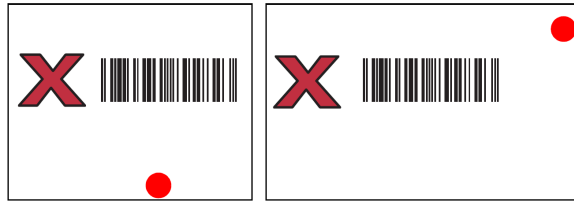

A.3 Maintenance

Cleaning the exit window is the only maintenance required. A dirty window can affect scanning accuracy.

- Do not allow any abrasive material to touch the window.
- Remove any dirt particles with a damp cloth.
- Wipe the window using a tissue moistened with ammonia/water.
- Do not spray water or other cleaning liquids directly into the window.

A.4 Parameter Defaults

Refer to the following table for parameter defaults of LS2208 and DS4308.

Parameter	Defaults	Parameter	Defaults
1-D Symbologies		Interleaved 2 of 5 (ITF)	
UPC/EAN		Interleaved 2 of 5 (ITF) Enable	Enable
UPC-A	Enable	Set Lengths for I 2 of 5	14
UPC-E	Enable	I 2 of 5 Check Digit Verification	Disable
UPC-E1	Disable	Transmit I 2 of 5 Check Digit	Disable
EAN-8/JAN 8	Enable	Convert I 2 of 5 to EAN 13	Disable
EAN-13/JAN 13	Enable	Codabar (NW - 7)	
Bookland EAN	Disable	Codabar	Enable
Decode UPC/EAN/JAN Supplementals (2 and 5 digits)	Ignore	Set Lengths for Codabar	5 to 55
UPC/EAN/JAN Supplemental Redundancy	10	CLSI Editing	Disable
Transmit UPC-A Check Digit	Enable	NOTIS Editing	Disable
Transmit UPC-E Check Digit	Enable		
Transmit UPC-E1 Check Digit	Enable	2-D Symbologies	
UPC-A Preamble	System Character	PDF417	Enable
UPC-E Preamble	System Character	MicroPDF417	Disable
UPC-E1 Preamble	System Character	Code 128 Emulation	Disable
Convert UPC-E to A	Disable	Data Matrix	Enable
Convert UPC-E1 to A	Disable	Maxicode	Enable

Parameter	Defaults	Parameter	Defaults
EAN-8/JAN-8 Extend	Disable	QR Code	Enable
UCC Coupon Extended Code	Disable		
Code 128			
Code 128	Enable		
UCC/EAN-128	Enable		
ISBT 128	Enable		
Code 39			
Code 39	Enable		
Trioptic Code 39	Disable		
Convert Code 39 to Code 32 (Italian Pharmacy Code)	Disable		
Code 32 Prefix	Disable		
Set Length(s) for Code 39	2 to 55		
Code 39 Check Digit Verification	Disable		
Transmit Code 39 Check Digit	Disable		
Code 39 Full ASCII Conversion	Disable		
Buffer Code 39	Disable		
Code 93			
Code 93	Enable		
Set Length(s) for Code 93	4 to 55		

This page intentionally left blank.

B Trolley and Accessories

WARNING

- DO NOT connect the trolley to the outlets with the same circuit breakers and fuses that control the current to devices such as life-support systems. If the trolley or the system malfunctions and generates over-current, or when there is an instantaneous current at power ON, the circuit breakers and fuses of the building's supply circuit may be tripped.
 - When you connect another device to the trolley, you should use the equipotential wire to connect each of equipotential terminals; otherwise electric shock may result.
 - Be sure to connect the equipotential wire before inserting the power plug into the receptacle; be sure to remove the power plug from the receptacle before disconnecting the equipotential wire; otherwise electric shock may result.
 - Connect the earth cable before powering ON. Disconnect the earth cable after powering OFF. Otherwise, electric shock may result.
-

CAUTION

- Maximum output power of the outlet in the trolley is 240 VA.
 - When moving the trolley with mounted system, please take care of the connector of the power adapter in case of damage.
 - DO NOT insert fingers into the gap next to the plug in case of injury.
-

B.1 Accessories

TIP:

The supplied accessories are depending on the actual purchased order.

MT3 Trolley

- Power cord
- Probe holder (4D probe holder, big probe holder)
- Cover grounding cable
- Probe extension module or Probe extend module panel
- Auxiliary output cable
- Printer bracket

MT2 Trolley

- Probe extension module
- Printer bracket
- Probe holder (4D probe holder, big probe holder)

B.2 Introduction of Each Unit

MT3 Trolley

Figure B-1 Overview of the Trolley

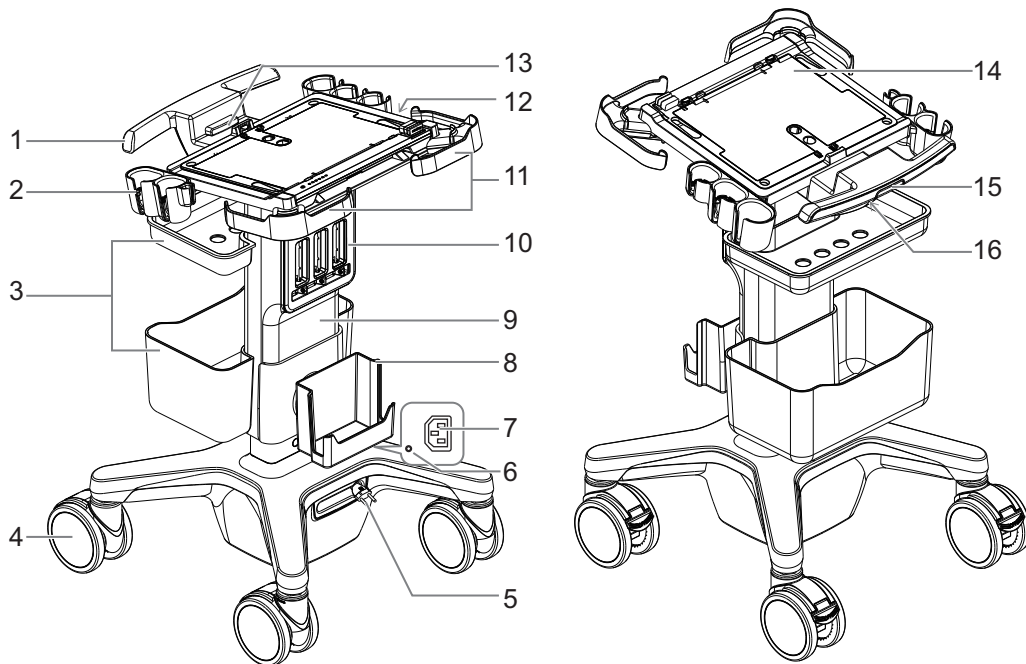

No.	Item	Description
1.	Trolley handle	Used for ascending/descending the trolley or moving the trolley.
2.	Probe holder	Used for placing probes temporarily.
3.	Storage box	Used for placing report or other stuff.
4.	Caster	Used for securing or moving the system.
5.	Retractable cable	AC power supply cable.
6.	Power indicator	Lights at AC supply.
7.	Power outlet	Supplies the power for peripheral devices.
8.	Power adapter bracket	Used for placing the power adapter.
9.	Lifting column	Used for adjusting the height of operation panel.
10.	Probe extension module	Used for extend ports for connecting probes (optional).
11.	Protective handle	Used for moving the trolley and protecting the trolley from crash during moving.

No.	Item	Description
12.	Equipotential terminal	Used for equipotential connection, balancing the protective earth potentials between the system and other electrical equipment.
13.	Anti-theft lock	Used for releasing the main unit from the trolley.
14.	Main unit tray	Used for placing and fixing the main unit. You can remove the tray and install the U-Bank (purchased separately) instead. NOTE: Keep the main unit tray carefully for future use after it is removed from the trolley. Reinstall the main unit tray to the trolley if the U-Bank has been removed from the trolley.
15.	Height lever	Used for adjusting the height of the stand.
16.	Tray release lever (located on the bottom of the handle)	Used for removing the main unit tray.

MT2 Trolley

Figure B-2 Overview of the Trolley

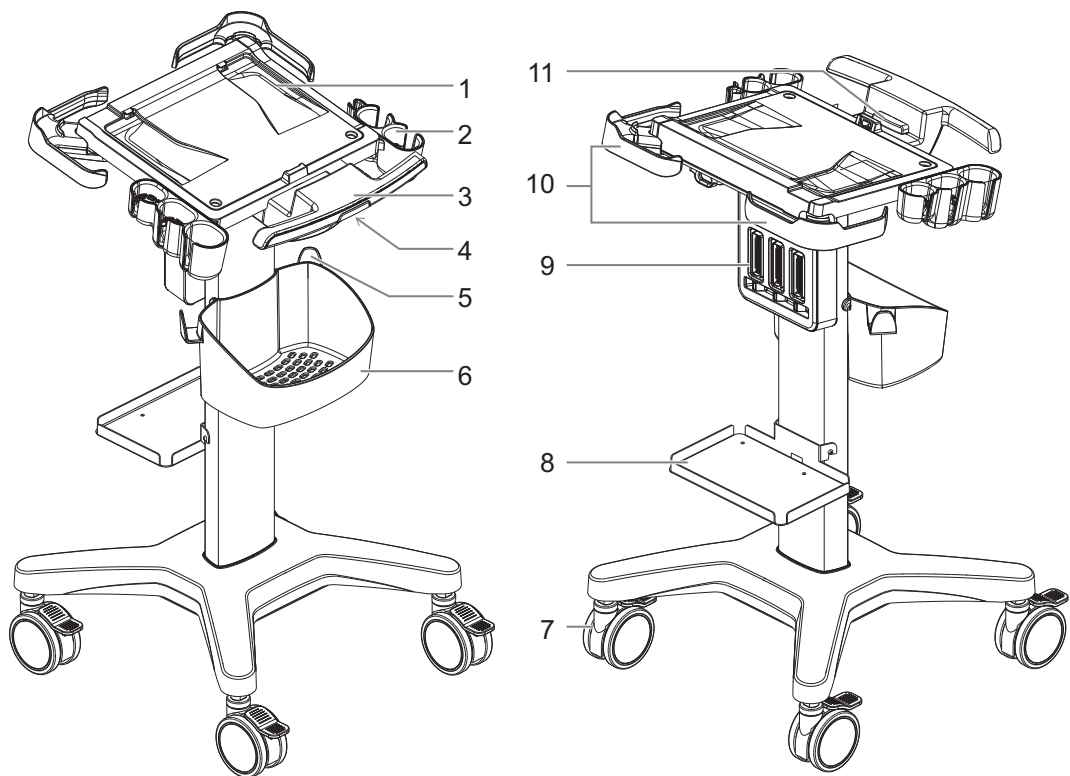

No.	Item	Description
1.	Main unit tray	Used for placing and fixing the main unit. You can remove the tray and install the U-Bank (purchased separately) instead. NOTE: Keep the main unit tray carefully for future use after it is removed from the trolley. Reinstall the main unit tray to the trolley if the U-Bank has been removed from the trolley.
2.	Probe holder	Used for placing probes temporarily.
3.	Trolley handle	Used for moving the trolley.
4.	Tray release lever (located on the bottom of the handle)	Used for removing the main unit tray.
5.	Cable hook	Manage cables.
6.	Storage box	Used for placing report or other stuff.
7.	Caster	Used for securing or moving the system.
8.	Printer bracket	Used for placing the printer.
9.	Probe extension module	Used for extend ports for connecting probes (optional).
10.	Protective handle	Used for moving the trolley and protecting the trolley from crash during moving.
11.	Anti-theft lock	Used for releasing the main unit from the trolley.

C

Electrical Safety Inspection

The following electrical safety tests are recommended as part of a comprehensive preventive maintenance program. They are a proven means of detecting abnormalities that, if undetected, could prove dangerous to either the patient or the operator. Additional tests may be required according to local regulations.

All tests can be performed using commercially-available safety analyzer test equipment. These procedures assume the use of a 601PROXL International Safety Analyzer or equivalent safety analyzer. Other popular testers which comply with IEC 60601-1 and are used in Europe, such as Fluke, Metron or Gerb, may require modifications to the procedure. Follow the analyzer manufacturer's instructions.

An electrical safety inspection should be periodically performed every two years. The safety analyzer is also an excellent troubleshooting tool for detecting abnormalities in line voltage and grounding, as well as total current loads.

NOTE:

Make sure the safety analyzer is authorized and complies with the requirements of IEC 61010-1. Follow the analyzer manufacturer's instructions.

C.1 Power Cord Plug

C.1.1 The Power Plug

Test Item		Acceptance Criteria
The power plug	The power plug pins	No broken or bent pins. No discolored pins.
	The plug body	No physical damage to the plug body.
	The strain relief	No physical damage to the strain relief. No plug warmth when device is in use.
	The power plug	No loose connections.
The power cord		No physical damage to the cord. No deterioration to the cord.
		For devices with detachable power cords, inspect the connection with the device.
		For devices with non-detachable power cords, inspect the strain relief at the device.

C.2 Device Enclosure and Accessories

C.2.1 Visual Inspection

Test Item	Acceptance Criteria
The enclosure and accessories	No physical damage to the enclosure and accessories.
	No physical damage to meters, switches, connectors, etc.
	No residue of fluid spillage (e.g., water, coffee, chemicals, etc.).
	No loose or missing parts (e.g., knobs, dials, terminals, etc.).

C.2.2 Contextual Inspection

Test Item	Acceptance Criteria
The enclosure and accessories	No unusual noises (e.g., rattles inside the case).
	No unusual smells (e.g., burning or smoky smells, particularly from ventilation holes).
	No taped notes that may suggest device deficiencies or operator concerns.

C.3 Device Labeling

Check that the labels provided by the manufacturer or the healthcare facility are present and legible.

- Main unit label
- Integrated warning labels

C.4 Protective Earth Resistance

1. Plug the analyzer probes into the device's protective earth terminal and the protective earth terminal of the AC power cord.
2. Test the earth resistance with a current of 25 A.
3. Verify the resistance is less than the limits.

LIMITS

ALL COUNTRIES $R = 0.2 \Omega$ Maximum

C.5 Earth Leakage Test

Run an Earth Leakage test on the device being tested before performing any other leakage tests.

The following outlet conditions apply when performing the Earth Leakage test.

- normal polarity (Normal Condition);
- reverse polarity (Normal Condition);

- normal polarity with open neutral (Single Fault Condition);
- reverse polarity with open neutral (Single Fault Condition).

LIMITS

- For ES 60601-1:
 - 300 μA in Normal Condition.
 - 1000 μA in Single Fault Condition.
- For IEC 60601-1:
 - 500 μA in Normal Condition.
 - 1000 μA in Single Fault Condition.

C.6 Enclosure Leakage Test

The following outlet conditions apply when performing the Enclosure Leakage test.

- normal polarity (Normal Condition);
- reverse polarity (Normal Condition);
- normal polarity with open neutral (Single Fault Condition);
- reverse polarity with open neutral (Single Fault Condition);
- normal polarity with open earth (Single Fault Condition);
- reverse polarity with open earth (Single Fault Condition).

LIMITS

- For ES 60601-1
 - 100 μA in Normal Condition.
 - 300 μA in Single Fault Condition.
- For IEC 60601-1:
 - 100 μA in Normal Condition.
 - 500 μA in Single Fault Condition.

C.7 Patient Leakage Current

Patient leakage currents are measured between a selected applied part and mains earth. All measurements have a true RMS only.

The following outlet conditions apply when performing the Patient Leakage Current test.

- normal polarity (Normal Condition);
- reverse polarity (Normal Condition);
- normal polarity with open neutral (Single Fault Condition);
- reverse polarity with open neutral (Single Fault Condition);
- normal polarity with open earth (Single Fault Condition);
- reverse polarity with open earth (Single Fault Condition).

LIMITS

For BF  applied parts:

- 100 μA in Normal Condition.
- 500 μA in Single Fault Condition.

C.8 Mains on Applied Part Leakage

The Mains on Applied Part test applies a test voltage, which is 110% of the mains voltage using a limiting resistance, to selected applied part terminals. Current measurements are then taken between the selected applied part and earth. Measurements are taken with the test voltage (110% of mains) on applied parts in the normal and reverse polarity conditions.

The following outlet conditions apply when performing the Mains on Applied Part test.

- Normal Polarity;
- Reversed Polarity.

LIMITS

For BF  applied parts: 5000 μA .

C.9 Patient Auxiliary Current

Patient Auxiliary currents are measured between any selected Applied Part connector and the remaining Applied Part connectors. All measurements may have a true RMS response.

The following outlet conditions apply when performing the Patient Auxiliary Current test.

- normal polarity (Normal Condition);
- reverse polarity (Normal Condition);
- normal polarity with open neutral (Single Fault Condition);
- reverse polarity with open neutral (Single Fault Condition);
- normal polarity with open earth (Single Fault Condition);
- reverse polarity with open earth (Single Fault Condition).

LIMITS

For BF  applied parts,

- 100 μA in Normal Condition.
- 500 μA in Single Fault Condition.

D Wireless LAN

The system provides wireless net adapter configuration, so as to assist information query and unlimited network service. The ultrasound system can be connected to router, mobile phone, tablet, ultrasound workstation, server network device and so on via wireless network

WARNING

- Use the wireless LAN function prudently in OR/ICU/CCU as it may interfere with other devices.
 - When the wireless LAN function is turned on, the ultrasound system may suffer interference from other equipment, even if that other equipment complies with CISPR EMISSION requirements.
 - Keep at least 20 cm away from the ultrasound system when the wireless LAN function is in use.
-

NOTE:

Disconnection may be caused if the devices connected exceed the router capacity (please refer to settings of the router, generally it should be ≤ 5 .)

DO NOT connect devices other than specified into the LAN.

Medical devices within the same LAN may interfere with each other, the operator should be cautious. (Do not connect devices that may cause strong interference. For example, life-supporting devices should not be connected in the same LAN.)





Other non-medical devices in the same frequency band may cause interference, please be cautious.

For a better wireless LAN transmission effect, please take the following settings:

- SSID > 80% with stable WLAN network.
 - Wireless router and the server are in the same network segment.
 - Router setting:
 - Wireless standard IEEE 802.11 ac/a/b/g/n.
 - Maximum transmission speed 300 Mbps.
 - Number of the devices connected to the same router ≤ 5 .
 - Target server setting:
 - Network is stable and not under overloading state (e.g. high CPU/memory usage, fast HDD speed, limited HDD space).
 - Level other than the highest level of firewall is adopted.
 - Operating system is Windows 10 or higher versions and it supports a Gigabit Ethernet.
-

D.1 Use the Wireless feature

Perform the following procedure:

1. Press <Cursor> to show the cursor, click  in the bottom bar to open the wireless network manager.
2. Move the cursor to the target network and press <Set> to select it, then click [Connect] to connect to the network.
3. When connecting an encrypted network, enter the password in the box first. You can select to hide password characters or not.
4. The system tries to connect and the wireless manager icon turns into . The icon turns into  or  after successful connection.
5. Click [Refresh] to refresh the “Wireless Network Connection” list.

D.2 IP Configure

NOTE:

- When the system background is processing network task (DICOM sending for example), please do not enter network setting to change the IP, otherwise the background task may fail. You can check if there are tasks undergoing in the task manager.
 - If the IP address displays as 0.0.0.0, this means that the network is abnormal. The reason for the failure may be disconnection or the system cannot obtain the IP address.
-

IP config is used for setting local network parameters, which is also applied to DICOM connection.

Perform the following procedure:

1. In Wireless network manager screen, click [IP Config] to open the configuration page.
 - If “DHCP” is selected, the IP address will be automatically obtained from the DNS server.
 - If “Static” is selected (using a static IP address), enter the IP address.
IP address of the system should be in the same network segment with the server.
2. Click [OK] to save current setting. Click [Cancel] to exit.

D.3 EAP Network

For setting EAP network, contact Mindray Customer Service Department or the sales representatives.

E iScanHelper

By providing the referential information, such as, the ultrasonic image, the anatomic graphic, scanning pictures/other scanning tips or diagnosis comments, the system helps the doctors to operate the scanning by iScanHelper. Furthermore, it is a good platform for the self-learning and training of ultrasound scanning technique for doctors. The system also plays a role in the assistant software system in fulfilling training and education.

NOTE:

THIS “iScanHelper” IS FOR REFERENCE OR TUTORIAL PURPOSES ONLY, AND THE MANUFACTURER WILL NOT BE LIABLE FOR DAMAGES AND/OR OTHER UNDESIRABLE CONSEQUENCE IN ANY KIND THAT MAY OCCUR TO THE PATIENT OR THE USERS BY USING THE SOFTWARE.

TIP:

iScanHelper feature is available under abdominal, gynecological, urological, obstetrical, small parts and nerve block area.

E.1 Use iScanHelper for Reference

Perform the following procedure:

1. Perform ordinary scanning procedure.
2. Press the user-defined key for “iScanHelper” to enter iScanHelper status.
3. Use the trackball/trackpad to move the cursor onto the target view name in the view selecting box and then press <Set>.
4. Perform scanning according to information displayed on the help information area.
5. Press the user-defined key again to exit.

E.2 Use iScanHelper for Learning or Training

Perform the following procedure:

1. Switch to the exam modes that support iScanHelper.
2. Press the user-defined key for “iScanHelper” to enter iScanHelper status.
3. Learn and practice views by system defaulted sequence according to the information displayed on help information area; or select unfamiliar views to practice.
4. Press the user-defined key again to exit iScanHelper.

E.3 Basic Screen and Operation

E.3.1 View Selecting Area

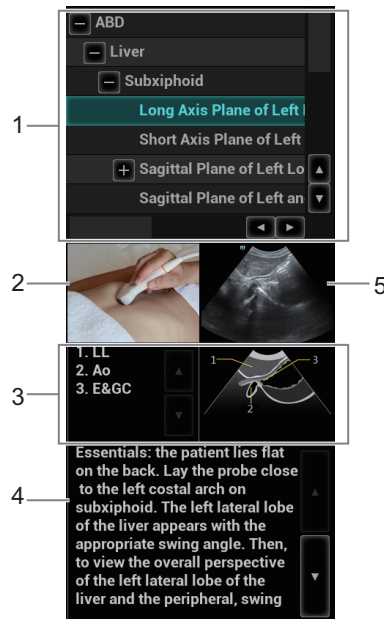

1	Section selecting box	Move the cursor onto the target view and press <Set> to select a section.
2	Anatomic graphic	Related anatomical tissue information are provided here.
3	Scanning picture	Ordinary scanning tips can be observed here, including posture, probe mark, probe swing/sweep techniques.
4	Scanning tips	You can read tissue related anatomical information and adjacent tissue information here.
5	Ultrasonic image	It is used to compare with images scanned by the operator.

E.3.2 Single/quad-window Display

You can zoom in the anatomic graphic, ultrasonic image as well as scanning picture to view those information more conveniently.

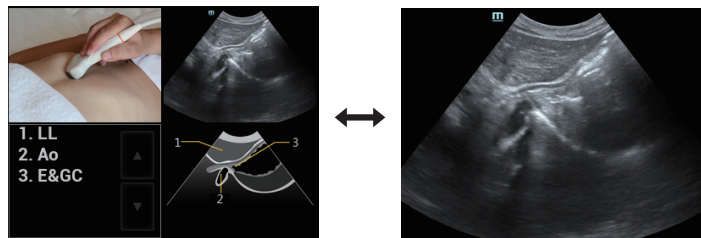

Press <Cursor> to obtain the cursor. Move the cursor on the anatomic graphic, the ultrasound image or scanning picture.

- Double-click Anatomic graphic, Scanning picture or Ultrasonic image to go to the single window of each of them.
- Double-click single window again to return to quad-window display.

F iVision

The iVision function is used to demonstrate the stored images. Image files are played one by one according to file names (including system-relevant and PC-compatible format images).

Perform the following procedure:

1. Press the user-defined key for “iVision” to enter the iVision screen.
2. Add the contents to be played and select demo mode.
3. Select an item in the list and click [Start] to begin the demonstration.
4. Click [Exit] to exit iVision status.

F.1 Demonstration item

Demonstration items are image files in formats supported by the system. You can add exam data from the patient database or system-supported image files and folders to the demonstration list. For files and folders in the demonstration list, the images in the directory and subdirectory are played one by one, and the system will automatically skip files that cannot be opened.

F.2 Demonstration catalog

There are two kinds of catalog: Demo Catalog and Customize Catalog.

F.2.1 Demo Catalog

The demo catalog is a folder on the hard disk where the factory DEMO is stored. The system plays the images in this folder when performing demonstrations.

The system supports importing, deleting or clearing the data in the demo catalog.

Click [Demo Manager] to operate:

- [>]: to import data into the demo catalog.
- [<]: to delete selected data.
- [<<]: to delete all data.

F.2.2 Customize Catalog

The catalog of the displayed images is saved here. The system plays the images in the catalog when performing demonstrations.

Operate the catalog or the files using the buttons on the right:

- [Add File]: to add files to the file list.
- [Add Catalog]: to add a catalog of files to the list.
- [Delete]: to delete selected files or catalogs from the file list.
- [Clear]: to clear all the files or catalogs in the file list.
- [Export]: to export selected directories/files to external storage devices. Click [Export] to bring up the Browse dialog box, select the path and click [OK].

F.3 Copy the file

Transfer files between the mobile hard disk and the ultrasound system.

Perform the following procedure:

1. Plug the USB disk, and click [Copy File].
2. Select the path of the source file from the “Drive” and “File Name”.
3. Click [Choose Catalog]. Select the path of the source file from the “Drive” and “File Name”, and then click [OK].
4. Click [OK] again to complete the task.

F.4 Demonstration mode

The system automatically plays all the image files in the list one by one.

The time interval between images played is same and can be changed.

F.5 Option of Demo

You can choose whether to repeat the demonstration or exit after a demonstration is completed.

G

List of Vocal Commands

The ultrasound system can automatically recognize some vocal commands. You can use a microphone device to input the vocal commands as shown in the following table. After the input command is recognized, the system automatically performs the corresponding operations.

Vocal command	Operation
Hello Mindray	Turn On Audio Control
Turn Off	Turn Off Audio Control
B Mode	Back to B Mode
CDI Mode	Turn on/off CDI Mode
Power Mode	Turn on/off Power Mode
M Mode	Turn on/off M Mode
PW Mode	Turn on/off PW Mode
3D	Turn on/off 3D Mode
Freeze	Freeze Image
UnFreeze	UnFreeze Image
Clear	Clear
Dual	Enter Dual Windows Format
Quad	Enter Quad Windows Format
QSave	QSave
Update	Update
Full Image	Turn on/off Full Image Mode
Middle Line	Display/Hide Middle Line
iNeedle	Turn on/off iNeedle Mode
iTouch	Turn on iTouch Mode
Depth Increase	Depth Increase One
Depth Decrease	Depth Decrease One
Gain Increase	Gain Increase One
Gain Decrease	Gain Decrease One
Gain Auto Increase	Gain Auto Increase
Gain Auto Decrease	Gain Auto Decrease
Gain Stop	Gain Stop Auto Increase/Decrease
Zoom In	Zoom In Image
Zoom Out	Zoom Out Image

Vocal command	Operation
Open Smart Track	Turn on Smart Track Mode
Close Smart Track	Turn off Smart Track Mode
Sound Volume Up	Turn Sound Volume Up
Sound Volume Down	Turn Sound Volume Down
Angle More	Angle More One
Angle Less	Angle Less One
Left Steer	Left Steer the Color ROI or Linear Image
Right Steer	Right Steer the Color ROI or Linear Image
BaseLine Down	Decrease the Baseline Position
BaseLine Up	Increase the Baseline Position
Save Image	Save Image
Save Clip	Save Clip
Save Screen	Save Screen
Adult Abdomen	Switch Exam Mode to Adult Abdomen
Abdomen Difficult	Switch Exam Mode to Adult Abdomen Difficult
Pediatric Abdomen	Switch Exam Mode to Pediatric Abdomen
Bowel	Switch Exam Mode to Bowel
Abdomen Vascular	Switch Exam Mode to Abdomen Vascular
Neonatal Abdomen	Switch Exam Mode to Neonatal Abdomen
Adult Cardiac	Switch Exam Mode to Adult Cardiac
Cardiac Difficult	Switch Exam Mode to Adult Cardiac Difficult
Pediatric Cardiac	Switch Exam Mode to Pediatric Cardiac
Left ventricular opacification	Switch Exam Mode to LVO
Neonatal Cardiac	Switch Exam Mode to Neonatal Cardiac
TEE Cardiac	Switch Exam Mode to TEE Cardiac
Coronary Artery	Switch Exam Mode to Coronary Artery
Gynecology	Switch Exam Mode to Gynecology
1st Trimester	Switch Exam Mode to 1st Trimester
2nd & 3rd Trimester	Switch Exam Mode to 2nd & 3rd Trimester
Fetal Echo	Switch Exam Mode to Fetal Echo
Kidney	Switch Exam Mode to Kidney
Urology	Switch Exam Mode to Urology
Prostate	Switch Exam Mode to Prostate
Transcranial Imaging	Switch Exam Mode to Transcranial Imaging
Carotid	Switch Exam Mode to Carotid
Upper External Artery	Switch Exam Mode to Upper Ext Artery

Vocal command	Operation
Lower External Artery	Switch Exam Mode to Lower Ext Artery
Upper External Vein	Switch Exam Mode to Upper Ext Vein
Lower External Vein	Switch Exam Mode to Lower Ext Vein
Thyroid	Switch Exam Mode to Thyroid
Breast	Switch Exam Mode to Breast
Testicle	Switch Exam Mode to Testicle
Musculoskeletal	Switch Exam Mode to Musculoskeletal
Superficial	Switch Exam Mode to Superficial
Shoulder	Switch Exam Mode to Shoulder
Intraoperative	Switch Exam Mode to Intraoperative
Nerve Block	Switch Exam Mode to Nerve Block
Emergency Abdomen	Switch Exam Mode to Emergency Abdomen
Emergency FAST	Switch Exam Mode to Emergency Focused Assessment with Sonography for Trauma
Emergency Obstetrics	Switch Exam Mode to Emergency Obstetrics
Emergency Vascular	Switch Exam Mode to Emergency Vascular
Emergency Superficial	Switch Exam Mode to Emergency Superficial
Lung	Switch Exam Mode to Lung
Neonatal Head	Switch Exam Mode to Neonatal Head
Orthopedic	Switch Exam Mode to Orthopedic
Deep Nerve	Switch Exam Mode to Deep Nerve
Superficial N	Switch Exam Mode to Superficial Nerve
Renal Artery	Switch Exam Mode to Renal Artery
Ocular	Switch Exam Mode to Ocular
Wrist	Switch Exam Mode to Wrist
Emergency AAA	Switch Exam Mode to Emergency Abdomen Aorta An-eurysm
Emergency Cardiac	Switch Exam Mode to Emergency Cardiac
IMT	Switch Exam Mode to IMT
Open Patient Info Dialog	Open Patient Info Dialog
Close Patient Info Dialog	Close Patient Info Dialog
Open Probe Dialog	Open Probe Dialog
Close Probe Dialog	Close Probe Dialog
Open Review Dialog	Open Review Dialog
Close Review Dialog	Close Review Dialog
Open Report Dialog	Open Report Dialog

Vocal command	Operation
Close Report Dialog	Close Report Dialog
Open Preset Dialog	Open Preset Dialog
Close Preset Dialog	Close Preset Dialog
Smart IVC	Smart IVC
Smart VTI	Smart VTI
Smart B-lines	Smart B-lines

H Acoustic Output

This section of the operator's manual applies to the overall system including the main unit, probes, accessories and peripherals. This section contains important safety information for operators of the device, pertaining to acoustic output and how to control patient exposure through use of the ALARA (as low as reasonably achievable) principle. Also this section contains information regarding the acoustic output testing and the real-time output display.

Read this information carefully before using the system.

H.1 Concerns with Bioeffects

Diagnostic ultrasound is recognized as being safe. In fact, there have been no reports of injuries to patients caused by diagnostic ultrasound.

It cannot be stated categorically that ultrasound is 100% safe. Studies have revealed that ultrasound with extremely high intensity is harmful to body tissues.

Diagnostic ultrasound technology has made a great leap forward during the last several years. This rapid advance has generated concerns about the potential risk of bioeffects when new applications or diagnostic technologies become available.

H.2 Prudent Use Statement

Although there are no confirmed biological effects on patients caused by exposures from present diagnostic ultrasound instruments, the possibility exists that such biological effects may be identified in the future. Thus ultrasound should be used in a prudent manner to provide medical benefit to the patient. High exposure levels and long exposure times should be avoided while acquiring necessary clinical information.

H.3 ALARA Principle (As Low As Reasonably Achievable)

It is required to practice ALARA when using ultrasound energy. Practicing ALARA ensures that the total energy level is controlled below a low enough level at which bioeffects are not generated while diagnostic information is being accumulated. The total energy is controlled by output intensity and total radiation time. The output intensity necessary for examinations differs depending on the patient and the clinical case.

Not all examinations can be performed with an extremely low level of acoustic energy. Controlling the acoustic level at an extremely low level leads to low-quality images or insufficient Doppler signals, adversely affecting the reliability of the diagnosis. However, increasing the acoustic power more than necessary does not always contribute to an increase in quality of information required for diagnosis, rather increasing the risk of generating bioeffects.

Users must take responsibility for the safety of patients and utilize ultrasound deliberately. Deliberate use of ultrasound means that output power of ultrasound must be selected based on ALARA.

Additional information regarding the concept of ALARA and the possible bioeffects of Ultrasound is available in a document from the AIUM (American Institute of Ultrasound Medicine) title “Medical Ultrasound Safety”.

H.4 MI/TI Explanation

H.4.1 Basic Knowledge of MI and TI

Mechanical Bioeffect and Thermal Bioeffect

The relationship of various ultrasound output parameters (frequency, acoustic pressure and intensity, etc.) to bioeffects is not fully understood presently. It is recognized that two fundamental mechanisms may induce bioeffects. One is a thermal bioeffect with tissue absorption of ultrasound, and another one is a mechanical bioeffect based on cavitations. Thermal Index (TI) gives the relative index of temperature increase by thermal bioeffect, and Mechanical Index (MI) gives the relative index of mechanical bioeffect. TI and MI indices reflect instantaneous output conditions, so they DO NOT consider the cumulative effects of the total examination time. TI and MI models contain practical simplifications to complex bioeffects interaction. Then the operator should be aware that the actual worst case temperature rise may be up to several times higher than the displayed TI value.

MI (Mechanical Index)

The mechanical bioeffects are the result of compression and decompression of insonated tissues with the formation of micro bubbles that may be referred to as cavitations.

MI is an index that shows the possibility of the cavitations generation based on acoustic pressure, and the value in which the peak-rarefactional acoustic pressure is divided by the square root of the frequency. Therefore MI value becomes smaller when the frequency is higher or the peak-rarefactional acoustic pressure is lower, it becomes difficult to generate the cavitations.

$$MI = \frac{P_{r, \alpha}}{\sqrt{f_{awf}} \times C_{MI}}$$

$$C_{MI} = 1 \text{ (MPa} / \sqrt{\text{MHz}})$$

For the frequency 1 MHz and the peak rarefactional acoustic pressure 1 MPa, MI becomes 1. It is possible to think MI to be one threshold of the cavitations generation. Especially, it is important to keep MI value to be low when both gases and the soft tissues exist together, for such as lung exposure in cardiac scanning and bowel gas in abdominal scanning.

TI (Thermal Index)

TI is determined by the ratio of the total acoustic power to the acoustic power required to raise the tissue temperature by 1 degree C. In addition, because the temperature rises is greatly different according to tissue structures, TI is divided three kinds: TIS (Soft-tissue Thermal Index), TIB (Bone Thermal Index) and TIC (Cranial-bone Thermal Index).

- TIS: Thermal index related to soft tissues, such as abdominal and cardiac applications.
- TIB: Thermal index for applications, such as fetal (second and third trimester) or neonatal cephalic (through the fontanel), in which the ultrasound beam passes through soft tissue and a focal region is in the immediate vicinity of bone.
- TIC: Thermal index for applications, such as pediatric and adult cranial applications, in which the ultrasound beam passes through bone near the beam entrance into the body.

Although the output power is automatically controlled for the selected applications, high TI values should be kept to a minimum or avoided in obstetric applications. WFUMB (World Federation for Ultrasound in Medicine and Biology) guidelines: state that temperature increase of 4 degree C for 5 min or more should be considered as potentially hazardous to embryonic and fetal tissue.

The smaller the MI/TI values, the lower the bioeffects.

H.4.2 MI/TI Display

TI and MI values are displayed in the upper part of the screen in real-time. The operator should monitor these index values during examinations and ensure that exposure time and output values are maintained at the minimum amounts needed for effective diagnosis.

NOTE:

If there is a value of MI or TI exceeds 1.0, you must be careful to practice the ALARA principle.

The display precision is 0.1.

Real-time Display accuracy: $MI \leq 28.5\%$, $TI \leq 38.7\%$

H.5 Acoustic Power Setting

Acoustic power adjustment

Use the [A.power] to adjust the acoustic power percentage, and its value is displayed on the corresponding item, as well as at the top of the screen. The greater the acoustic power percentage, the greater the current acoustic output. When the image is frozen, the system stops transmitting acoustic power.

Default setting of acoustic power

Selection of diagnostic applications is the most important factor for controlling ultrasound output. The permissible level of intensity of ultrasound differs depending on the region of interest. For fetal examinations, in particular, much care must be exercised.

In this system, imaging setups can be created using the ultrasound output set by you.

Once you perform preset settings, default setting values of the system may be changed and invalid. It is the user's responsibility for any change to the default settings.

Adjusting range

Initial power: 0.13% to 100%*

Definition of 100%: The maximum acoustic power of a probe determined by the increase in probe surface temperature in the selected mode and the acoustic power restrictions specified by the FDA.

Default settings of acoustic power value refer to the best image quality of the probe. The larger the acoustic power value, the better the image quality.

In this product, to obtain optimum images for applications under the requirements of safety and ALARA principle, we set acoustic power default values in factory to be maximum 93.33% in all exam modes for a better image quality. The user can make adjustments according to the imaging effect in practical use.

NOTE:

This system automatically returns to the settings whenever changes are made to the values (when you turn on the power, switch between probes, end the exam, or select OK or Cancel in the Setup menu). In the factory default settings, the Acoustic Output is limited below 100%. Following the ALARA restriction, you are allowed to increase the acoustic power under FDA 510 (k) Guidance-Track 3 limits and to set it in the image preset screen.

The acoustic output of the system has been measured and calculated in accordance with IEC60601-2-37: 2015, FDA 510(K) GUIDANCE, IEC 62359: 2017, Ultrasonics-Field characterization-Test methods for the determination of thermal and mechanical indices related to medical diagnostic ultrasonic fields.

H.6 Acoustic Power Control

The qualified operator may use the system controls to limit the ultrasound output and to adjust the quality of the images. There are three categories of system controls relative to output. They are,

- Controls that have direct effect on the output
- Controls that indirectly control output
- Controls that are receiver controls

Direct controls

It is possible to control, if necessary, the acoustic output with the “A.power” item. In this case, the maximum value of the acoustic output never exceeds an MI of 1.9 and an $I_{SPTA,3}$ of 720 mW/cm² in any mode of operation.

Indirect controls

The controls that indirectly affect output are the many imaging parameters. These are operating modes, frequency, focal point positions, overall depth, and PRF.

The operating mode determines whether the ultrasound beam is scanning or non-scanning. Thermal bioeffect is closely connected to M mode, Doppler and Color mode. Acoustic attenuation of tissue is directly related to probe frequency. The focal point is related to active aperture of probe and beam width. For the higher PRF (pulse repetition frequency), the more output pulses occur over a period of time.

Receiver controls

The receiver controls (for example, gain, dynamic range, and image post-processing, etc.) won't affect output. These controls should be used, when possible, to improve the image quality before using controls that directly or indirectly affect output.

H.7 Acoustic Output

H.7.1 Derated Ultrasonic Output Parameters

In order to determine the relevant Ultrasonic Output Parameters, a method is used which allows for the comparison of ultrasound systems which operate at different frequencies and are focused at different depths. This approach, called “derating” or “attenuating”, adjusts the acoustic output as measured in a water tank to account for the effect of ultrasound propagation through tissue. By convention, a specific average intensity attenuation value is used, which corresponds to a loss of 0.3 dB/cm/MHz. That is, the intensity of ultrasound will be reduced by 0.3 dB/MHz for every centimeter of travel from the probe. This can be expressed by the following equation:

$$I_{atten} = I_{water} \times 10^{((-0.3)/10 \times f_c \times z)}$$

Where I_{atten} is the attenuated intensity, I_{water} is the intensity measured in a water tank (at distance z), f_c is the center frequency of the ultrasound wave (as measured in water), and z is the distance from the probe. The equation for attenuating pressure values is similar except that the attenuation coefficient is 0.15 dB/cm/MHz, or one-half the intensity coefficient. The intensity coefficient is double the pressure coefficient because intensity is proportional to the square of pressure.

Although the attenuation coefficient chosen, 0.3 dB/cm/MHz, is significantly lower than any specific solid tissue in the body, this value was chosen to account for fetal examinations. In early trimester ultrasound fetal examinations, there may be a significant fluid path between the probe and the fetus, and the attenuation of fluid is very small. Therefore the attenuation coefficient was lowered to account for this case.

H.7.2 Limits of Acoustic Output

In accordance with the FDA Track 3 requirements, the derating (or attenuated) approach was incorporated into the FDA Acoustic Output Limits, as listed below. The maximum acoustic output level from any probe in any operating mode is expected to fall below these limits.

FDA Maximum Acoustic Output Limits for Track 3 (Attenuated Values)

Application: Regions (except eyes)	$I_{spta.3} \text{ (mW/cm}^2\text{)} \leq 720$	$I_{sppa.3} \text{ (W/cm}^2\text{)} \leq 190$ or $MI \leq 1.9$
Application: Ophthalmic	$I_{spta.3} \text{ (mW/cm}^2\text{)} \leq 50$	$MI \leq 0.23$

H.7.3 Differences between Actual and Displayed MI and TI

In operation, the system will display to the operator the Acoustic Output Parameters Thermal Index, TI, or Mechanical Index, MI (or sometimes both parameters simultaneously). These parameters were developed as general indicators of risk from either thermal or mechanical action of the ultrasound wave. They serve to indicate to the operator whether a particular setting of the system increases or decreases the possibility of Thermal or Mechanical effect. More specifically, they were designed to assist in the implementation of the ALARA principle. As an operator changes a given system control, the potential effect of the change in output will be indicated. However, the Thermal Index is not the same as temperature rise in the body, for several reasons. First of all, in order to provide a single display index to you, a number of simplifying assumptions had to be made. The biggest assumption was the use of the attenuating formula described above, which is much lower than the actual value for most tissues within the body. Scanning through muscle or organ tissue, for example, will produce much higher attenuation than 0.3 dB/cm/MHz. There were also significant simplifications made for the thermal properties of tissue. Therefore, scanning through highly perfused tissue, such as the heart or vasculature, will produce significantly less thermal effect than that suggested by the Thermal Index.

Similarly, the Mechanical Index was derived to indicate the relative possibility of mechanical (cavitation) effects. The MI is based on the derated peak-rarefactional pressure and the center frequency of the ultrasound wave. The actual peak-rarefactional pressure is affected by the actual attenuation caused by tissue in the path between the probe and the focal point. Again, all solid tissues within the body have higher attenuation than the prescribed 0.3 dB/cm/MHz value, and therefore, the actual peak-rarefactional pressure will be lower. Further, the actual peak-rarefactional pressure will change depending upon the region of the body being scanned.

For these reasons, the TI and MI displays should only be used to assist the operator in implementing ALARA at the time of the patient examination.

H.8 Measurement Uncertainty

The total estimated measurement uncertainty (where the total uncertainty includes the uncertainties in hydrophone response, measurement, calculation, and positioning) are:

Acoustic Quantities	Total Uncertainties (Standard)
Power	26.48% for non-scan modes; 6.03% for scan modes.
Frequency	0.22%
Pressure	13.01%
I_{ta}	26.48% for non-scan modes; 26.95% for scan modes.
I_{pa}	26.5%
Mechanical Index	13.01%
Total Uncertainty for TIS	Non-scan Modes: 26.48%; Scan-Modes: 6.03%
Total Uncertainty for TIB	Non-scan Modes: 26.48% or 18.72%; Scan-Modes: 6.03%
Total Uncertainty for TIC	Non-scan Modes: 26.48%; Scan-Modes: 6.03%

H.9 References for Acoustic Power and Safety

- “Bioeffects and Safety of Diagnostic Ultrasound” issued by AIUM in 1993
- “Medical Ultrasound Safety” issued by AIUM in 1994
- Marketing Clearance of Diagnostic Ultrasound Systems and Transducers, June 27, 2019. Center for Devices and Radiological Health.
- Medical electrical equipment-Part 2-37: Particular requirements for the basic safety and essential performance of ultrasonic medical diagnostic and monitoring equipment issued by IEC in 2015
- IEC 62359, Ultrasonics-Field characterization-Test methods for the determination of thermal and mechanical indices related to medical diagnostic ultrasonic fields, 2017.

EMC Guidance and Manufacturer's Declaration

The system complies with the EMC standard IEC 60601-1-2: 2014+A1:2020.

Intended Environments: HOME HEALTHCARE ENVIRONMENT (except for the probe P7-3Ts/P8-3Ts/CW2s).

Intended Environments: Professional healthcare facility environment (including the probe P7-3Ts/P8-3Ts/CW2s)

WARNING

- The use of unapproved accessories may diminish system performance.
- Use of components, accessories, probes, and cables other than those specified may result in increased emission or decreased immunity of system.
- Operation of system, in the case that the patient physiological signal is lower than the minimum amplitude or value specified in the product specifications, results may not be obtained (results can be obtained when the HR is in the range of 30-250 bmp or when the QRS wave amplitude is between 0.5-5 mV.)
- Use of this equipment adjacent to or stacked with other equipment should be avoided because it could result in improper operation. If such use is necessary, this equipment and the other equipment should be observed to verify that they are operating normally.
- Use of accessories, transducers and cables other than those specified or provided by the manufacturer of this equipment could result in increased electromagnetic emissions or decreased electromagnetic immunity of this equipment and result in improper operation.
- Portable RF communications equipment (including peripherals such as antenna cables and external antennas) should be used no closer than 30 cm (12 inches) to any part of the system, including cables specified by the manufacturer. Otherwise, degradation of the performance of this equipment could result.
- Keep a distance of at least 20 cm away from the monitor when WiFi function is in use.
- The system should be away from RFID, MRI, diathermy, and electrocautery testing, wireless power transfer, 5G cellular and security equipment (such as electromagnetic anti-theft system and metal detector). If the devices are near and are interfered by the concealed and undiscovered RF transmitter (for example, scanning mode changes or image disturbances affecting

diagnosis), the user should immediately take mitigation measures, such as redirecting, repositioning or shielding the RF transmitter.

- This equipment has been tested and found to comply with the limits for a Class B digital device, pursuant to part 15 of the FCC Rules. These limits are designed to provide reasonable protection against harmful interference in a residential installation. This equipment generates, uses and can radiate radio frequency energy and, if not installed and used in accordance with the instructions, may cause harmful interference to radio communications. However, there is no guarantee that interference will not occur in a particular installation. If this equipment does cause harmful interference to radio or television reception, which can be determined by turning the equipment off and on, the user is encouraged to try to correct the interference by one or more of the following measures:
 - Reorient or relocate the receiving antenna.
 - Increase the separation between the equipment and receiver.
 - Connect the equipment into an outlet on a circuit different from that to which the receiver is connected.
 - Consult the dealer or an experienced radio/TV technician for help.Any Changes or modifications not expressly approved by the party responsible for compliance could void the user's authority to operate the equipment.
- The device has been evaluated to meet general RF exposure requirement. The device can be used in portable exposure condition without restriction. This device complies with part 15 of the FCC Rules. Operation is subject to the following two conditions: (1) This device may not cause harmful interference, and (2) this device must accept any interference received, including interference that may cause undesired operation.

NOTE:

If the system is operated within the electromagnetic environment listed in Table I-1, Table I-2, Table I-3, Table I-4, Table I-5 and Table I-6, the system will remain safe and will provide the following basic performances:

- Imaging;
- Doppler acoustic spectral displaying;
- Taking measurements;
- Patient information;

- Date/time information.

Table I-1

GUIDANCE AND MINDRAY DECLARATION-ELECTROMAGNETIC EMISSIONS		
The system is intended for use in the electromagnetic environment specified below. The customer or the user of system should assure that it is used in such an environment.		
EMISSIONS TEST	COMPLIANCE	ELECTROMAGNETIC ENVIROMENT - GUIDANCE
RF emissions CISPR 11	Group 1	The system uses RF energy only for its internal function. Therefore, its RF emissions are very low and are not likely to cause any interference in nearby electronic equipment.
RF emissions CISPR 11	Class B	The system is suitable for use in all establishments including domestic establishments and those directly connected to the public low-voltage power supply network that supplies buildings used for domestic purposes
Harmonic Emissions IEC 61000-3-2	Class A	
Voltage Fluctuations/ Flicker Emissions IEC 61000-3-3	Compliance	

Table I-2

GUIDANCE AND MINDRAY DECLARATION-ELECTROMAGNETIC EMISSIONS		
The Probe which integrated in the system is intended for use in the electromagnetic environment specified below. The customer or the user of system should assure that it is used in such an environment.		
EMISSIONS TEST	COMPLIANCE	ELECTROMAGNETIC ENVIROMENT - GUIDANCE
RF emissions CISPR 11	Group 1	The Probes uses RF energy only for its internal function. Therefore, its RF emissions are very low and are not likely to cause any interference in nearby electronic equipment.
RF emissions CISPR 11	Class A	The Probe is suitable for use in all establishments other than domestic and those directly connected to the public low-voltage power supply network that supplies buildings used for domestic purposes
Harmonic Emissions IEC 61000-3-2	Class A	
Voltage Fluctuations/ Flicker Emissions IEC 61000-3-3	Compliance	

Table I-3

GUIDANCE AND MINDRAY DECLARATION-ELECTROMAGNETIC IMMUNITY			
The system is intended for use in the electromagnetic environment specified below. The customer or the user of system should assure that it is used in such an environment.			
IMMUNITY TEST	IEC 60601 TEST LEVEL	COMPLIANCE LEVEL	ELECTROMAGNETIC ENVIRONMENT-GUIDANCE
Electrostatic Discharge(ESD) IEC 61000-4-2	±8 kV contact; ±2 kV, ±4 kV, ±8 kV, ±15 kV air	±8 kV contact; ±2 kV, ±4 kV, ±8 kV, ±15 kV air	Floors should be wood, concrete or ceramic tile. If floors are covered with synthetic material, the relative humidity should be at least 30%.
Electrical fast Transient / burst IEC 61000-4-4	±2 kV for power supply lines; ±1 kV for input/output lines	±2 kV for power supply lines; ±1 kV for input/output lines	Mains power quality should be that of a typical commercial or hospital environment.
Surge IEC 61000-4-5	±0,5 kV, ±1 kV line(s) to line(s); ±0,5 kV, ±1 kV, ±2 kV line(s) to earth	±0,5 kV, ±1 kV line(s) to line(s); ±0,5 kV, ±1 kV, ±2 kV line(s) to earth	Mains power quality should be that of a typical commercial or hospital environment.
Voltage dips, Short interruptions and voltage variation on power supply input voltage IEC 61000-4-11	0 % U_T ; 0,5 cycle At 0°, 45°, 90°, 135°, 180°, 225°, 270° and 315° 0 % U_T ; 1 cycle 70% U_T for 25/30 cycle at 0° 0 % U_T ; 250/300 cycle	0 % U_T ; 0,5 cycle At 0°, 45°, 90°, 135°, 180°, 225°, 270° and 315° 0 % U_T ; 1 cycle 70% U_T for 25/30 cycle at 0° 0 % U_T ; 250/300 cycle	Mains power quality should be that of a typical commercial or hospital environment. If you require continued operation during power mains interruptions, it is recommended that our product be powered from an uninterruptible power supply or a battery.
Power frequency (50/60 HZ) magnetic field IEC 61000-4-8	30 A/m	30 A/m	Power frequency magnetic fields should be at levels characteristic of a typical location in a typical commercial or hospital environment.

NOTE:

U_T is the A.C. mains voltage prior to application of the test level.

Table I-4

GUIDANCE AND MINDRAY DECLARATION-ELECTROMAGNETIC IMMUNITY			
The system is intended for use in the electromagnetic environment specified below. The customer or the user of system should assure that it is used in such an environment.			
IMMUNITY TEST	IEC 60601 TEST LEVEL	COMPLIANCE LEVEL	ELECTROMAGNETIC ENVIRONMENT-GUIDANCE
Conducted RF IEC 61000-4-6	3 Vrms 0,15 MHz – 80 MHz 6 Vrms in ISM ^a and amateur radio bands between 0,15 MHz and 80 MHz	3 Vrms 0,15 MHz – 80 MHz 6 Vrms in ISM and amateur radio bands between 0,15 MHz and 80 MHz	Portable and mobile RF communications equipment should be used no closer to any part of system, including cables, than the recommended separation distance calculated from the equation applicable to the frequency of the transmitter. Recommended separation distance $d = 1.2 \times \sqrt{P}$ $d = 2 \times \sqrt{P}$
Radiated RF IEC 61000-4-3	10 V/m 80MHz - 2.7GHz	10 V/m 80MHz - 2.7GHz	$d = 1.2 \times \sqrt{P}$ 80 MHz to 800 MHz $d = 2.3 \times \sqrt{P}$ 800 MHz to 2.7GHz Where, P is the maximum output power rating of the transmitter in watts (W) according to the transmitter manufacturer and d is the recommended separation distance in meters (m). Field strengths from fixed RF transmitters, as determined by an electromagnetic site survey ^b , should be less than the compliance level in each frequency range ^c . Interference may occur in the vicinity of equipment marked with the following symbol: 

Note 1: At 80 MHz and 800 MHz, the higher frequency range applies.

Note 2: These guidelines may not apply in all situations. Electromagnetic propagation is affected by absorption and reflection from structures, objects and people.

Table I-4

GUIDANCE AND MINDRAY DECLARATION-ELECTROMAGNETIC IMMUNITY			
The system is intended for use in the electromagnetic environment specified below. The customer or the user of system should assure that it is used in such an environment.			
IMMUNITY TEST	IEC 60601 TEST LEVEL	COMPLIANCE LEVEL	ELECTROMAGNETIC ENVIRONMENT-GUIDANCE
<p>a: The ISM (industrial, scientific, and medical) bands between 150 kHz and 80 MHz are 6,765 MHz to 6,795 MHz; 13,553 MHz to 13,567 MHz; 26,957 MHz to 27,283 MHz; and 40,66 MHz to 40,70 MHz. The amateur radio bands between 0,15 MHz and 80 MHz are 1,8 MHz to 2,0 MHz, 3,5 MHz to 4,0 MHz, 5,3 MHz to 5,4 MHz, 7 MHz to 7,3 MHz, 10,1 MHz to 10,15 MHz, 14 MHz to 14,2 MHz, 18,07 MHz to 18,17 MHz, 21,0 MHz to 21,4 MHz, 24,89 MHz to 24,99 MHz, 28,0 MHz to 29,7 MHz and 50,0 MHz to 54,0 MHz.</p> <p>b: Field strengths from fixed transmitters, such as base stations for radio (cellular/cordless) telephones and land mobile radios, amateur radio, AM and FM radio broadcast and TV broadcast cannot be predicted theoretically with accuracy. To assess the electromagnetic environment due to fixed RF transmitters, an electromagnetic site survey should be considered. If the measured field strength in the location in which the device is used exceeds the applicable RF compliance level above, the device should be observed to verify normal operation. If abnormal performance is observed, additional measures may be necessary, such as re-orienting or relocating the device.</p> <p>c: Over the frequency range 150 kHz to 80 MHz, field strengths should be less than 3 V/m.</p>			

Table I-5

GUIDANCE AND MINDRAY DECLARATION—ELECTROMAGNETIC IMMUNITY			
The system is intended for use in the electromagnetic environment specified below. The customer or the user of system should assure that it is used in such an environment.			
IMMUNITY TEST	IEC 60601 TEST LEVEL	COMPLIANCE LEVEL	ELECTROMAGNETIC ENVIRONMENT – GUIDANCE
Proximity magnetic fields IEC 61000-4-39	8 A/m 30 kHz CW	8 A/m 30 kHz CW	/
	65 A/m 134,2 kHz Pulse modulation 2,1 kHz	65 A/m 134,2 kHz Pulse modulation 2,1 kHz	
	7,5 A/m 13,56 MHz Pulse modulation 50 kHz	7,5 A/m 13,56 MHz Pulse modulation 50 kHz	

Table I-6 Test specifications and minimum distances

Recommended separation distances between portable and mobile RF communications equipment and system						
The system is intended for use in an electromagnetic environment in which radiated RF disturbances are controlled. The customer or the user of system can help prevent electromagnetic interference by maintaining a minimum distance between portable and mobile RF communications equipment (transmitters) and The system as recommended below, according to the maximum output power of the communications equipment. Portable and mobile radio communications equipment (e.g. two-way radio, cellular/ cordless telephones and similar equipment) should be used no closer to any part of this system, including cables, than determined according to the following method:						
Test frequency (MHz)	Band(MHz)	Service	Modulation	Maximum power (W)	Distance (m)	Immunity test level (V/m)
385	380 - 390	TETRA 400	Pulse modulation 18Hz	1.8	0.3	27
450	430 -470	GMRS 460 FRS 460	FM \pm 5 kHz deviation 1 kHz sine	2	0.3	28
710	704 - 787	LTE Band 13,17	Pulse modulation 217 Hz	0.2	0.3	9
745						
780						
810	800 - 960	GSM 800/900, tetra 800, iDEN 820, CDMA 850, LTE Band 5	Pulse modulation 18 Hz	2	0.3	28
870						
930						
1720	1700 -1990	GSM 1800, CDMA 1900, GSM 1900, DECT, LTE Band 1, 3, 4, 25, UMTS	Pulse modulation 217 Hz	2	0.3	28
1845						
1970						
2450	2400 -2570	Bluetooth, WLAN, 802.11 b/g/n, RFID 2450, LTE Band 7	Pulse modulation 217 Hz	2	0.3	28
5240	5100 -5800	WLAN, 802.11 a/n	Pulse modulation 217 Hz	0.2	0.3	9
5500						
5785						

Table I-7

RECOMMENDED SEPARATION DISTANCES BETWEEN PORTABLE AND MOBILE RF COMMUNICATION DEVICE AND THE SYSTEM				
The system is intended for use in an electromagnetic environment in which radiated RF disturbance are controlled. The customer or the user of system can help prevent electromagnetic interference by maintaining a minimum distance between portable and mobile RF communication equipment (transmitters) and system as recommended below, according to the maximum output power of the communication equipment.				
Rated Maximum Output power of Transmitter (W)	Separation Distance According to Frequency of Transmitter			
	150kHz -80MHz Out ISM and amateur radio bands $d=1.2 \sqrt{P}$	150kHz -80MHz in ISM and amateur radio bands $d=2 \sqrt{P}$	80MHz-800MHz $d=1.2 \sqrt{P}$	800MHz-2.7GHz $d=2.3 \sqrt{P}$
0.01	0.12	0.2	0.12	0.23
0.1	0.38	0.64	0.38	0.73
1	1.2	2	1.2	2.3
10	3.8	6.4	3.8	7.3
100	12	20	12	23

For transmitters at a maximum output power not listed above, the recommended separation distanced in meters (m) can be determined using the equation applicable to the frequency of the transmitter, where P is the maximum output power rating of the transmitter in watts (W) according to the transmitter manufacturer.

If system image distortion occurs, it may be necessary to position system further from sources of conducted RF noise or to install external power source filter to minimize RF noise to an acceptable level.

Note 1: At 80 MHz and 800 MHz, the higher frequency range applies.

Note 2: These guidelines may not apply in all situations. Electromagnetic propagation is affected by absorption and reflection from structures, objects and people.

Table I-8 Cable sample

No.	Name	Cable length (m)	Shield or not	Remarks
1	Power input	2.5m	Not shielded	/
2	SIP/SOP	< 3.0m	Shielding	/
3	ECG cable	4.0m	Shielding	/
4	Probe Cable	< 3.0m	Shielding	/
5	Footswitch Cable	2.9m	Shielding	/

Radio Regulatory Compliance

RF parameter

Features	2.4GHz	5GHz
Frequency Range	2412MHz - 2483.5MHz	5.15 - 5.25GHz 5.25 - 5.35GHz 5.47 - 5.725GHz 5.725 - 5.850GHz
Modulation	DSSS and OFDM	OFDM
Output Power	≤20dBm	

NOTE:

Keep a distance of at least 20cm away from the monitor when Wi-Fi function is in use.

This page intentionally left blank.

J

Indications for Use

Intended Use: Diagnostic ultrasound imaging or fluid flow analysis of the human body as follows:									
Clinical Application		Mode of Operation							
General (Track 1 Only)	Specific (Track 1 & 3)	B	M	PWD	CWD	Color Doppler	Amplitude Doppler	Combined (specify)	Other (specify)
Ophthalmic	Ophthalmic	P		P		P		P	
Fetal Imaging & Other	Fetal	P	P	P		P	P	P	Note 1,2,4,5
	Abdominal	P	P	P	P	P	P	P	Note 1,2,4,5,8
	Intra-operative (Specify*)	P	P	P	P	P	P	P	Note 1,2,5
	Intra-operative (Neuro)								
	Laparoscopic								
	Pediatric	P	P	P	P	P	P	P	Note 1,2,4,5
	Small Organ (Specify**)	P	P	P		P	P	P	Note 1,2,4,5,6
	Neonatal Cephalic	P	P	P	P	P	P	P	Note 1,2,4,5
	Adult Cephalic	P	P	P	P	P	P	P	Note 1,2,4,5
	Trans-rectal	P	P	P		P	P	P	Note 1,2,4,5,6
	Trans-vaginal	P	P	P		P	P	P	Note 1,2,4,5,6
	Trans-urethral								
	Trans-esoph. (non-Card.)								
	Musculo-skeletal (Conventional)	P	P	P		P	P	P	Note 1,2,4,5,6
	Musculo-skeletal (Superficial)	P	P	P		P	P	P	Note 1,2,4,5,6
Intravascular									
Thoracic/Pleural (Specify****)	P	P			P	P	P	Note 1,2,4,5	
Cardiac	Cardiac Adult	P	P	P	P	P	P	P	Note 1,2,3,4,5,7
	Cardiac Pediatric	P	P	P	P	P	P	P	Note 1,2,3,4,5
	Intravascular (Cardiac)								
	Trans-esoph. (Cardiac)	P	P	P	P	P	P	P	Note 1,3,4
Peripheral vessel	Intra-cardiac								
	Peripheral vessel	P	P	P		P	P	P	Note 1,2,4,5
	Other (Specify***)	P	P	P		P	P	P	Note 1,2,4,5,6

N=new indication ; P=previously cleared by FDA ; E=added under Appendix E

Additional comments: Combined modes--B+M, PW+B, Color + B, Power + B, PW +Color+ B, Power + PW +B.

*Intraoperative includes abdominal, thoracic, and vascular etc.

**Small organ-breast, thyroid, testes.

***Other use includes Urology.

****For detection of fluid and pleural motion/sliding.

Note 1: Tissue Harmonic Imaging. The feature does not use contrast agents.

Note 2: iScape

Note 3: TDI

Note 4: Color M

Note 5: Smart 3D

Note 6: Strain Elastography

Note 7: Contrast imaging (Contrast agent for LVO)

Note 8: Contrast imaging (Contrast agent for Liver)

Transducer:	C5-1s								
Intended Use:	Diagnostic ultrasound imaging or fluid flow analysis of the human body as follows:								
Clinical Application		Mode of Operation							
General (Track 1 Only)	Specific (Track 1 & 3)	B	M	PWD	CWD	Color Doppler	Amplitude Doppler	Combined (specify)	Other (specify)
Ophthalmic	Ophthalmic								
Fetal Imaging & Other	Fetal	P	P	P		P	P	P	Note 1,2,4,5
	Abdominal	P	P	P		P	P	P	Note 1,2,4,5,8
	Intra-operative (Specify*)								
	Intra-operative (Neuro)								
	Laparoscopic								
	Pediatric	P	P	P		P	P	P	Note 1,2,4,5
	Small Organ (Specify**)								
	Neonatal Cephalic								
	Adult Cephalic								
	Trans-rectal								
	Trans-vaginal								
	Trans-urethral								
	Trans-esoph. (non-Card.)								
	Musculo-skeletal (Conventional)	P	P	P		P	P	P	Note 1,2,4,5
	Musculo-skeletal (Superficial)								
	Intravascular								
Thoracic/Pleural (Specify****)	P	P			P	P	P	Note 1,2,4,5	
Cardiac	Cardiac Adult								
	Cardiac Pediatric								
	Intravascular (Cardiac)								
	Trans-esoph. (Cardiac)								
	Intra-cardiac								
Peripheral vessel	Peripheral vessel	P	P	P		P	P	P	Note 1,2,4,5
	Other (Specify***)	P	P	P		P	P	P	Note 1,2,4,5
N=new indication ; P=previously cleared by FDA ; E=added under Appendix E									
Additional comments: Combined modes--B+M、PW+B、Color + B、 Power + B、 PW +Color+ B、 Power + PW +B.									
*Intraoperative includes abdominal, thoracic, and vascular etc.									
**Small organ-breast, thyroid, testes.									
***Other use includes Urology.									
****For detection of fluid and pleural motion/sliding.									
Note 1: Tissue Harmonic Imaging. The feature does not use contrast agents.									
Note 2: iScape									
Note 3: TDI									
Note 4: Color M									
Note 5: Smart 3D									
Note 6: Strain Elastography									
Note 7: Contrast imaging (Contrast agent for LVO)									
Note 8: Contrast imaging (Contrast agent for Liver)									

Transducer:	C11-3s								
Intended Use:	Diagnostic ultrasound imaging or fluid flow analysis of the human body as follows:								
Clinical Application		Mode of Operation							
General (Track 1 Only)	Specific (Track 1 & 3)	B	M	PWD	CWD	Color Doppler	Amplitude Doppler	Combined (specify)	Other (specify)
Ophthalmic	Ophthalmic								
Fetal Imaging & Other	Fetal								
	Abdominal	P	P	P		P	P	P	Note 1,2,4
	Intra-operative (Specify*)								
	Intra-operative (Neuro)								
	Laparoscopic								
	Pediatric	P	P	P		P	P	P	Note 1,2,4
	Small Organ (Specify**)								
	Neonatal Cephalic	P	P	P		P	P	P	Note 1,2,4
	Adult Cephalic								
	Trans-rectal								
	Trans-vaginal								
	Trans-urethral								
	Trans-esoph. (non-Card.)								
	Musculo-skeletal (Conventional)								
	Musculo-skeletal (Superficial)								
	Intravascular								
	Thoracic/Pleural (Specify****)	P	P	P		P	P	P	Note 1,2,4
Cardiac	Cardiac Adult								
	Cardiac Pediatric	P	P	P		P	P	P	Note 1,2,4
	Intravascular (Cardiac)								
	Trans-esoph. (Cardiac)								
	Intra-cardiac								
Peripheral vessel	Peripheral vessel	P	P	P		P	P	P	Note 1,2,4
	Other (Specify***)								
N=new indication ; P=previously cleared by FDA ; E=added under Appendix E									
Additional comments: Combined modes--B+M、PW+B、Color + B、Power + B、PW +Color+ B、Power + PW +B.									
*Intraoperative includes abdominal, thoracic, and vascular etc.									
**Small organ-breast, thyroid, testes.									
***Other use includes Urology.									
****For detection of fluid and pleural motion/sliding.									
Note 1: Tissue Harmonic Imaging. The feature does not use contrast agents.									
Note 2: iScape									
Note 3: TDI									
Note 4: Color M									
Note 5: Smart 3D									
Note 6: Strain Elastography									
Note 7: Contrast imaging (Contrast agent for LVO)									
Note 8: Contrast imaging (Contrast agent for Liver)									

Transducer:	SC5-1Ns								
Intended Use:	Diagnostic ultrasound imaging or fluid flow analysis of the human body as follows:								
Clinical Application		Mode of Operation							
General (Track	Specific (Track 1 & 3)	B	M	PWD	CWD	Color Doppler	Amplitude Doppler	Combined (specify)	Other (specify)
Ophthalmic	Ophthalmic								
Fetal Imaging&	Fetal	P	P	P		P	P	P	Note 1,2,4,5
Other	Abdominal	P	P	P		P	P	P	Note 1,2,4,5,8
	Intra-operative (Specify*)								
	Intra-operative (Neuro)								
	Laparoscopic								
	Pediatric	P	P	P		P	P	P	Note 1,2,4,5
	Small Organ (Specify**)								
	Neonatal Cephalic								
	Adult Cephalic								
	Trans-rectal								
	Trans-vaginal								
	Trans-urethral								
	Trans-esoph. (non-Card.)								
	Musculo-skeletal (Conventional)	P	P	P		P	P	P	Note 1,2,4,5
	Musculo-skeletal (Superficial)								
	Intravascular								
	Thoracic/Pleural (Specify****)	P	P			P	P	P	Note 1,2,4,5
Cardiac	Cardiac Adult								
	Cardiac Pediatric								
	Intravascular (Cardiac)								
	Trans-esoph. (Cardiac)								
	Intra-cardiac								
Peripheral vessel	Peripheral vessel	P	P	P		P	P	P	Note 1,2,4,5
	Other (Specify***)	P	P	P		P	P	P	Note 1,2,4,5
N=new indication ; P=previously cleared by FDA ; E=added under Appendix E									
Additional comments: Combined modes--B+M, PW+B, Color + B, Power + B, PW +Color+ B, Power + PW +B.									
*Intraoperative includes abdominal, thoracic, and vascular etc.									
**Small organ-breast, thyroid, testes.									
***Other use includes Urology.									
****For detection of fluid and pleural motion/sliding.									
Note 1: Tissue Harmonic Imaging. The feature does not use contrast agents.									
Note 2: iScape									
Note 3: TDI									
Note 4: Color M									
Note 5: Smart 3D									
Note 6: Strain Elastography									
Note 7: Contrast imaging (Contrast agent for LVO)									
Note 8: Contrast imaging (Contrast agent for Liver)									

Transducer:	V11-3s								
Intended Use:	Diagnostic ultrasound imaging or fluid flow analysis of the human body as follows:								
Clinical Application		Mode of Operation							
General (Track 1 Only)	Specific (Track 1 & 3)	B	M	PWD	CWD	Color Doppler	Amplitude Doppler	Combined (specify)	Other (specify)
Ophthalmic	Ophthalmic								
Fetal Imaging& Other	Fetal	P	P	P		P	P	P	Note 1,2,4,5
	Abdominal								
	Intra-operative (Specify*)								
	Intra-operative (Neuro)								
	Laparoscopic								
	Pediatric								
	Small Organ (Specify**)								
	Neonatal Cephalic								
	Adult Cephalic								
	Trans-rectal	P	P	P		P	P	P	Note 1,2,4,5,6
	Trans-vaginal	P	P	P		P	P	P	Note 1,2,4,5,6
	Trans-urethral								
	Trans-esoph. (non-Card.)								
	Musculo-skeletal (Conventional)								
	Musculo-skeletal (Superficial)								
	Intravascular								
	Thoracic/Pleural (Specify****)								
Cardiac	Cardiac Adult								
	Cardiac Pediatric								
	Intravascular (Cardiac)								
	Trans-esoph. (Cardiac)								
	Intra-cardiac								
Peripheral vessel	Peripheral vessel								
	Other (Specify***)	P	P	P		P	P	P	Note 1,2,4,5,6
N=new indication ; P=previously cleared by FDA ; E=added under Appendix E									
Additional comments: Combined modes--B+M、PW+B、Color + B、 Power + B、 PW +Color+ B、 Power + PW +B.									
*Intraoperative includes abdominal, thoracic, and vascular etc.									
**Small organ-breast, thyroid, testes.									
***Other use includes Urology.									
****For detection of fluid and pleural motion/sliding.									
Note 1: Tissue Harmonic Imaging. The feature does not use contrast agents.									
Note 2: iScape									
Note 3: TDI									
Note 4: Color M									
Note 5: Smart 3D									
Note 6: Strain Elastography									
Note 7: Contrast imaging (Contrast agent for LVO)									
Note 8: Contrast imaging (Contrast agent for Liver)									

Transducer:	L9-3s								
Intended Use:	Diagnostic ultrasound imaging or fluid flow analysis of the human body as follows:								
Clinical Application		Mode of Operation							
General (Track	Specific (Track 1 & 3)	B	M	PWD	CWD	Color Doppler	Amplitude Doppler	Combined (specify)	Other (specify)
Ophthalmic	Ophthalmic								
Fetal Imaging&	Fetal								
Other	Abdominal	P	P	P		P	P	P	Note 1,2,5
	Intra-operative (Specify*)								
	Intra-operative (Neuro)								
	Laparoscopic								
	Pediatric	P	P	P		P	P	P	Note 1,2,5
	Small Organ (Specify**)	P	P	P		P	P	P	Note 1,2,5
	Neonatal Cephalic								
	Adult Cephalic								
	Trans-rectal								
	Trans-vaginal								
	Trans-urethral								
	Trans-esoph. (non-Card.)								
	Musculo-skeletal (Conventional)	P	P	P		P	P	P	Note 1,2,5
	Musculo-skeletal (Superficial)	P	P	P		P	P	P	Note 1,2,5
	Intravascular								
	Thoracic/Pleural (Specify****)								
Cardiac	Cardiac Adult								
	Cardiac Pediatric								
	Intravascular (Cardiac)								
	Trans-esoph. (Cardiac)								
	Intra-cardiac								
Peripheral vessel	Peripheral vessel	P	P	P		P	P	P	Note 1,2,5
	Other (Specify***)								
N=new indication ; P=previously cleared by FDA ; E=added under Appendix E									
Additional comments: Combined modes--B+M、PW+B、 Color + B、 Power + B、 PW +Color+ B、 Power + PW +B.									
*Intraoperative includes abdominal, thoracic, and vascular etc.									
**Small organ-breast, thyroid, testes.									
***Other use includes Urology.									
****For detection of fluid and pleural motion/sliding.									
Note 1: Tissue Harmonic Imaging. The feature does not use contrast agents.									
Note 2: iScape									
Note 3: TDI									
Note 4: Color M									
Note 5: Smart 3D									
Note 6: Strain Elastography									
Note 7: Contrast imaging (Contrast agent for LVO)									
Note 8: Contrast imaging (Contrast agent for Liver)									

Transducer:	V11-3Hs								
Intended Use:	Diagnostic ultrasound imaging or fluid flow analysis of the human body as follows:								
Clinical Application		Mode of Operation							
General (Track 1 Only)	Specific (Track 1 & 3)	B	M	PWD	CWD	Color Doppler	Amplitude Doppler	Combined (specify)	Other (specify)
Ophthalmic	Ophthalmic								
Fetal Imaging& Other	Fetal	P	P	P		P	P	P	Note 1,2,4,5
	Abdominal								
	Intra-operative (Specify*)								
	Intra-operative (Neuro)								
	Laparoscopic								
	Pediatric								
	Small Organ (Specify**)								
	Neonatal Cephalic								
	Adult Cephalic								
	Trans-rectal	P	P	P		P	P	P	Note 1,2,4,5,6
	Trans-vaginal	P	P	P		P	P	P	Note 1,2,4,5,6
	Trans-urethral								
	Trans-esoph. (non-Card.)								
	Musculo-skeletal (Conventional)								
	Musculo-skeletal (Superficial)								
	Intravascular								
	Thoracic/Pleural (Specify****)								
Cardiac	Cardiac Adult								
	Cardiac Pediatric								
	Intravascular (Cardiac)								
	Trans-esoph. (Cardiac)								
	Intra-cardiac								
Peripheral vessel	Peripheral vessel								
	Other (Specify***)	P	P	P		P	P	P	Note 1,2,4,5,6
N=new indication ; P=previously cleared by FDA ; E=added under Appendix E									
Additional comments: Combined modes--B+M、PW+B、Color + B、Power + B、PW +Color+ B、Power + PW +B.									
*Intraoperative includes abdominal, thoracic, and vascular etc.									
**Small organ-breast, thyroid, testes.									
***Other use includes Urology.									
****For detection of fluid and pleural motion/sliding.									
Note 1: Tissue Harmonic Imaging. The feature does not use contrast agents.									
Note 2: iScape									
Note 3: TDI									
Note 4: Color M									
Note 5: Smart 3D									
Note 6: Strain Elastography									
Note 7: Contrast imaging (Contrast agent for LVO)									
Note 8: Contrast imaging (Contrast agent for Liver)									

J Indications for Use

Transducer:	L11-3VNs								
Intended Use:	Diagnostic ultrasound imaging or fluid flow analysis of the human body as follows:								
Clinical Application			Mode of Operation						
General (Track 1 Only)	Specific (Track 1 & 3)	B	M	PWD	CWD	Color Doppler	Amplitude Doppler	Combined (specify)	Other (specify)
Ophthalmic	Ophthalmic								
Fetal Imaging& Other	Fetal								
	Abdominal	P	P	P		P	P	P	Note 1,2,5
	Intra-operative (Specify*)								
	Intra-operative (Neuro)								
	Laparoscopic								
	Pediatric	P	P	P		P	P	P	Note 1,2,5
	Small Organ (Specify**)	P	P	P		P	P	P	Note 1,2,5,6
	Neonatal Cephalic								
	Adult Cephalic								
	Trans-rectal								
	Trans-vaginal								
	Trans-urethral								
	Trans-esoph. (non-Card.)								
	Musculo-skeletal (Conventional)	P	P	P		P	P	P	Note 1,2,5
	Musculo-skeletal (Superficial)	P	P	P		P	P	P	Note 1,2,5
	Intravascular								
	Thoracic/Pleural (Specify****)	P	P			P	P	P	Note 1,2,5
Cardiac	Cardiac Adult								
	Cardiac Pediatric								
	Intravascular (Cardiac)								
	Trans-esoph. (Cardiac)								
	Intra-cardiac								
Peripheral vessel	Peripheral vessel	P	P	P		P	P	P	Note 1,2,5
	Other (Specify***)								
N=new indication ; P=previously cleared by FDA ; E=added under Appendix E									
Additional comments: Combined modes--B+M、PW+B、Color + B、Power + B、PW +Color+ B、Power + PW +B.									
*Intraoperative includes abdominal, thoracic, and vascular etc.									
**Small organ-breast, thyroid, testes.									
***Other use includes Urology.									
****For detection of fluid and pleural motion/sliding.									
Note 1: Tissue Harmonic Imaging. The feature does not use contrast agents.									
Note 2: iScape									
Note 3: TDI									
Note 4: Color M									
Note 5: Smart 3D									
Note 6: Strain Elastography									
Note 7: Contrast imaging (Contrast agent for LVO)									
Note 8: Contrast imaging (Contrast agent for Liver)									

Transducer:	L12-3VNs								
Intended Use:	Diagnostic ultrasound imaging or fluid flow analysis of the human body as follows:								
Clinical Application		Mode of Operation							
General (Track 1 Only)	Specific (Track 1 & 3)	B	M	PWD	CWD	Color Doppler	Amplitude Doppler	Combined (specify)	Other (specify)
Ophthalmic	Ophthalmic								
Fetal Imaging& Other	Fetal								
	Abdominal	P	P	P		P	P	P	Note 1,2,5
	Intra-operative (Specify*)								
	Intra-operative (Neuro)								
	Laparoscopic								
	Pediatric	P	P	P		P	P	P	Note 1,2,5
	Small Organ (Specify**)	P	P	P		P	P	P	Note 1,2,5,6
	Neonatal Cephalic								
	Adult Cephalic								
	Trans-rectal								
	Trans-vaginal								
	Trans-urethral								
	Trans-esoph. (non-Card.)								
	Musculo-skeletal (Conventional)	P	P	P		P	P	P	Note 1,2,5
	Musculo-skeletal (Superficial)	P	P	P		P	P	P	Note 1,2,5
	Intravascular								
	Thoracic/Pleural (Specify****)	P	P			P	P	P	Note 1,2,5
Cardiac	Cardiac Adult								
	Cardiac Pediatric								
	Intravascular (Cardiac)								
	Trans-esoph. (Cardiac)								
	Intra-cardiac								
Peripheral vessel	Peripheral vessel	P	P	P		P	P	P	Note 1,2,5
	Other (Specify***)								
N=new indication ; P=previously cleared by FDA ; E=added under Appendix E									
Additional comments: Combined modes--B+M、 PW+B、 Color + B、 Power + B、 PW +Color+ B、 Power + PW +B.									
*Intraoperative includes abdominal, thoracic, and vascular etc.									
**Small organ-breast, thyroid, testes.									
***Other use includes Urology.									
****For detection of fluid and pleural motion/sliding.									
Note 1: Tissue Harmonic Imaging. The feature does not use contrast agents.									
Note 2: iScape									
Note 3: TDI									
Note 4: Color M									
Note 5: Smart 3D									
Note 6: Strain Elastography									
Note 7: Contrast imaging (Contrast agent for LVO)									
Note 8: Contrast imaging (Contrast agent for Liver)									

J Indications for Use

Transducer:	L12-3RCs								
Intended Use:	Diagnostic ultrasound imaging or fluid flow analysis of the human body as follows:								
Clinical Application			Mode of Operation						
General (Track	Specific (Track 1 & 3)	B	M	PWD	CWD	Color Doppler	Amplitude Doppler	Combined (specify)	Other (specify)
Ophthalmic	Ophthalmic								
Fetal Imaging& Other	Fetal								
	Abdominal	P	P	P		P	P	P	Note 1,2,5
	Intra-operative (Specify*)								
	Intra-operative (Neuro)								
	Laparoscopic								
	Pediatric	P	P	P		P	P	P	Note 1,2,5
	Small Organ (Specify**)	P	P	P		P	P	P	Note 1,2,5,6
	Neonatal Cephalic								
	Adult Cephalic								
	Trans-rectal								
	Trans-vaginal								
	Trans-urethral								
	Trans-esoph. (non-Card.)								
	Musculo-skeletal (Conventional)	P	P	P		P	P	P	Note 1,2,5
	Musculo-skeletal (Superficial)	P	P	P		P	P	P	Note 1,2,5
	Intravascular								
	Thoracic/Pleural (Specify****)	P	P	P		P	P	P	Note 1,2,5
Cardiac	Cardiac Adult								
	Cardiac Pediatric								
	Intravascular (Cardiac)								
	Trans-esoph. (Cardiac)								
	Intra-cardiac								
Peripheral vessel	Peripheral vessel	P	P	P		P	P	P	Note 1,2,5
	Other (Specify***)								
N=new indication ; P=previously cleared by FDA ; E=added under Appendix E									
Additional comments: Combined modes--B+M、PW+B、Color + B、Power + B、PW +Color+ B、Power + PW +B.									
*Intraoperative includes abdominal, thoracic, and vascular etc.									
**Small organ-breast, thyroid, testes.									
***Other use includes Urology.									
****For detection of fluid and pleural motion/sliding.									
Note 1: Tissue Harmonic Imaging. The feature does not use contrast agents.									
Note 2: iScape									
Note 3: TDI									
Note 4: Color M									
Note 5: Smart 3D									
Note 6: Strain Elastography									
Note 7: Contrast imaging (Contrast agent for LVO)									
Note 8: Contrast imaging (Contrast agent for Liver)									

Transducer:	L13-3s								
Intended Use:	Diagnostic ultrasound imaging or fluid flow analysis of the human body as follows:								
Clinical Application	Mode of Operation								
General (Track	Specific (Track 1 & 3)	B	M	PWD	CWD	Color Doppler	Amplitude Doppler	Combined (specify)	Other (specify)
Ophthalmic	Ophthalmic	P		P		P		P	
Fetal Imaging& Other	Fetal								
	Abdominal	P	P	P		P	P	P	Note 1,2,5
	Intra-operative (Specify*)								
	Intra-operative (Neuro)								
	Laparoscopic								
	Pediatric	P	P	P		P	P	P	Note 1,2,5
	Small Organ (Specify**)	P	P	P		P	P	P	Note 1,2,5,6
	Neonatal Cephalic								
	Adult Cephalic								
	Trans-rectal								
	Trans-vaginal								
	Trans-urethral								
	Trans-esoph. (non-Card.)								
	Musculo-skeletal (Conventional)	P	P	P		P	P	P	Note 1,2,5
	Musculo-skeletal (Superficial)	P	P	P		P	P	P	Note 1,2,5
	Intravascular								
	Thoracic/Pleural (Specify****)	P	P			P	P	P	Note 1,2,5
Cardiac	Cardiac Adult								
	Cardiac Pediatric								
	Intravascular (Cardiac)								
	Trans-esoph. (Cardiac)								
	Intra-cardiac								
Peripheral vessel	Peripheral vessel	P	P	P		P	P	P	Note 1,2,5
	Other (Specify***)								
N=new indication ; P=previously cleared by FDA ; E=added under Appendix E									
Additional comments: Combined modes--B+M、 PW+B、 Color + B、 Power + B、 PW +Color+ B、 Power + PW +B.									
*Intraoperative includes abdominal, thoracic, and vascular etc.									
**Small organ-breast, thyroid, testes.									
***Other use includes Urology.									
****For detection of fluid and pleural motion/sliding.									
Note 1: Tissue Harmonic Imaging. The feature does not use contrast agents.									
Note 2: iScape									
Note 3: TDI									
Note 4: Color M									
Note 5: Smart 3D									
Note 6: Strain Elastography									
Note 7: Contrast imaging (Contrast agent for LVO)									
Note 8: Contrast imaging (Contrast agent for Liver)									

Transducer:	L13-3Ns								
Intended Use:	Diagnostic ultrasound imaging or fluid flow analysis of the human body as follows:								
Clinical Application		Mode of Operation							
General (Track 1 Only)	Specific (Track 1 & 3)	B	M	PWD	CWD	Color Doppler	Amplitude Doppler	Combined (specify)	Other (specify)
Ophthalmic	Ophthalmic	P		P		P		P	
Fetal Imaging & Other	Fetal								
	Abdominal	P	P	P		P	P	P	Note 1,2,5
	Intra-operative (Specify*)								
	Intra-operative (Neuro)								
	Laparoscopic								
	Pediatric	P	P	P		P	P	P	Note 1,2,5
	Small Organ (Specify**)	P	P	P		P	P	P	Note 1,2,5,6
	Neonatal Cephalic								
	Adult Cephalic								
	Trans-rectal								
	Trans-vaginal								
	Trans-urethral								
	Trans-esoph. (non-Card.)								
	Musculo-skeletal (Conventional)	P	P	P		P	P	P	Note 1,2,5
	Musculo-skeletal (Superficial)	P	P	P		P	P	P	Note 1,2,5
	Intravascular								
	Thoracic/Pleural (Specify****)	P	P			P	P	P	Note 1,2,5
Cardiac	Cardiac Adult								
	Cardiac Pediatric								
	Intravascular (Cardiac)								
	Trans-esoph. (Cardiac)								
	Intra-cardiac								
Peripheral vessel	Peripheral vessel	P	P	P		P	P	P	Note 1,2,5
	Other (Specify***)								
N=new indication ; P=previously cleared by FDA ; E=added under Appendix E									
Additional comments: Combined modes--B+M、PW+B、Color + B、Power + B、PW +Color+ B、Power + PW +B.									
*Intraoperative includes abdominal, thoracic, and vascular etc.									
**Small organ-breast, thyroid, testes.									
***Other use includes Urology.									
****For detection of fluid and pleural motion/sliding.									
Note 1: Tissue Harmonic Imaging. The feature does not use contrast agents.									
Note 2: iScape									
Note 3: TDI									
Note 4: Color M									
Note 5: Smart 3D									
Note 6: Strain Elastography									
Note 7: Contrast imaging (Contrast agent for LVO)									
Note 8: Contrast imaging (Contrast agent for Liver)									

Transducer:	L14-6Ns								
Intended Use:	Diagnostic ultrasound imaging or fluid flow analysis of the human body as follows:								
Clinical Application		Mode of Operation							
General (Track	Specific (Track 1 & 3)	B	M	PWD	CWD	Color Doppler	Amplitude Doppler	Combined (specify)	Other (specify)
Ophthalmic	Ophthalmic	P		P		P		P	
Fetal Imaging& Other	Fetal								
	Abdominal	P	P	P		P	P	P	Note 1,2,5
	Intra-operative (Specify*)								
	Intra-operative (Neuro)								
	Laparoscopic								
	Pediatric	P	P	P		P	P	P	Note 1,2,5
	Small Organ (Specify**)	P	P	P		P	P	P	Note 1,2,5,6
	Neonatal Cephalic								
	Adult Cephalic								
	Trans-rectal								
	Trans-vaginal								
	Trans-urethral								
	Trans-esoph. (non-Card.)								
	Musculo-skeletal (Conventional)	P	P	P		P	P	P	Note 1,2,5
	Musculo-skeletal (Superficial)	P	P	P		P	P	P	Note 1,2,5
	Intravascular								
	Thoracic/Pleural (Specify****)	P	P			P	P	P	Note 1,2,5
Cardiac	Cardiac Adult								
	Cardiac Pediatric								
	Intravascular (Cardiac)								
	Trans-esoph. (Cardiac)								
	Intra-cardiac								
Peripheral vessel	Peripheral vessel	P	P	P		P	P	P	Note 1,2,5
	Other (Specify***)								
N=new indication ; P=previously cleared by FDA ; E=added under Appendix E									
Additional comments: Combined modes--B+M、PW+B、Color + B、Power + B、PW +Color+ B、Power + PW +B.									
*Intraoperative includes abdominal, thoracic, and vascular etc.									
**Small organ-breast, thyroid, testes.									
***Other use includes Urology.									
****For detection of fluid and pleural motion/sliding.									
Note 1: Tissue Harmonic Imaging. The feature does not use contrast agents.									
Note 2: iScape									
Note 3: TDI									
Note 4: Color M									
Note 5: Smart 3D									
Note 6: Strain Elastography									
Note 7: Contrast imaging (Contrast agent for LVO)									
Note 8: Contrast imaging (Contrast agent for Liver)									

J Indications for Use

Transducer:	L16-4Hs								
Intended Use:	Diagnostic ultrasound imaging or fluid flow analysis of the human body as follows:								
Clinical Application		Mode of Operation							
General (Track	Specific (Track 1 & 3)	B	M	PWD	CWD	Color Doppler	Amplitude Doppler	Combined (specify)	Other (specify)
Ophthalmic	Ophthalmic								
Fetal Imaging& Other	Fetal								
	Abdominal	P	P	P		P	P	P	Note 1,2,5
	Intra-operative (Specify*)	P	P	P		P	P	P	Note 1,2,5
	Intra-operative (Neuro)								
	Laparoscopic								
	Pediatric	P	P	P		P	P	P	Note 1,2,5
	Small Organ (Specify**)	P	P	P		P	P	P	Note 1,2,5
	Neonatal Cephalic	P	P	P		P	P	P	Note 1,2,5
	Adult Cephalic								
	Trans-rectal								
	Trans-vaginal								
	Trans-urethral								
	Trans-esoph. (non-Card.)								
	Musculo-skeletal (Conventional)	P	P	P		P	P	P	Note 1,2,5
	Musculo-skeletal (Superficial)	P	P	P		P	P	P	Note 1,2,5
	Intravascular								
	Thoracic/Pleural (Specify****)								
Cardiac	Cardiac Adult								
	Cardiac Pediatric								
	Intravascular (Cardiac)								
	Trans-esoph. (Cardiac)								
	Intra-cardiac								
Peripheral vessel	Peripheral vessel	P	P	P		P	P	P	Note 1,2,5
	Other (Specify***)								
N=new indication ; P=previously cleared by FDA ; E=added under Appendix E									
Additional comments: Combined modes--B+M、PW+B、Color + B、Power + B、PW +Color+ B、Power + PW +B.									
*Intraoperative includes abdominal, thoracic, and vascular etc.									
**Small organ-breast, thyroid, testes.									
***Other use includes Urology.									
****For detection of fluid and pleural motion/sliding.									
Note 1: Tissue Harmonic Imaging. The feature does not use contrast agents.									
Note 2: iScape									
Note 3: TDI									
Note 4: Color M									
Note 5: Smart 3D									
Note 6: Strain Elastography									
Note 7: Contrast imaging (Contrast agent for LVO)									
Note 8: Contrast imaging (Contrast agent for Liver)									

Transducer:	L20-5s								
Intended Use:	Diagnostic ultrasound imaging or fluid flow analysis of the human body as follows:								
Clinical Application		Mode of Operation							
General (Track	Specific (Track 1 & 3)	B	M	PWD	CWD	Color Doppler	Amplitude Doppler	Combined (specify)	Other (specify)
Ophthalmic	Ophthalmic	P		P		P		P	
Fetal Imaging& Other	Fetal								
	Abdominal								
	Intra-operative (Specify*)								
	Intra-operative (Neuro)								
	Laparoscopic								
	Pediatric	P	P	P		P	P	P	Note 1,2,5
	Small Organ (Specify**)	P	P	P		P	P	P	Note 1,2,5,6
	Neonatal Cephalic								
	Adult Cephalic								
	Trans-rectal								
	Trans-vaginal								
	Trans-urethral								
	Trans-esoph. (non-Card.)								
	Musculo-skeletal (Conventional)	P	P	P		P	P	P	Note 1,2,5,6
	Musculo-skeletal (Superficial)	P	P	P		P	P	P	Note 1,2,5,6
	Intravascular								
Thoracic/Pleural (Specify****)									
Cardiac	Cardiac Adult								
	Cardiac Pediatric								
	Intravascular (Cardiac)								
	Trans-esoph. (Cardiac)								
	Intra-cardiac								
Peripheral vessel	Peripheral vessel	P	P	P		P	P	P	Note 1,2,5
	Other (Specify***)								
N=new indication ; P=previously cleared by FDA ; E=added under Appendix E									
Additional comments: Combined modes--B+M、 PW+B、 Color + B、 Power + B、 PW +Color+ B、 Power + PW +B.									
*Intraoperative includes abdominal, thoracic, and vascular etc.									
**Small organ-breast, thyroid, testes.									
***Other use includes Urology.									
****For detection of fluid and pleural motion/sliding.									
Note 1: Tissue Harmonic Imaging. The feature does not use contrast agents.									
Note 2: iScape									
Note 3: TDI									
Note 4: Color M									
Note 5: Smart 3D									
Note 6: Strain Elastography									
Note 7: Contrast imaging (Contrast agent for LVO)									
Note 8: Contrast imaging (Contrast agent for Liver)									

J Indications for Use

Transducer:	P4-2s								
Intended Use:	Diagnostic ultrasound imaging or fluid flow analysis of the human body as follows:								
Clinical Application		Mode of Operation							
General (Track 1 Only)	Specific (Track 1 & 3)	B	M	PWD	CWD	Color Doppler	Amplitude Doppler	Combined (specify)	Other (specify)
Ophthalmic	Ophthalmic								
Fetal Imaging& Other	Fetal								
	Abdominal	P	P	P	P	P	P	P	Note 1,2,4,5
	Intra-operative (Specify*)								
	Intra-operative (Neuro)								
	Laparoscopic								
	Pediatric	P	P	P	P	P	P	P	Note 1,2,4,5
	Small Organ (Specify**)								
	Neonatal Cephalic	P	P	P	P	P	P	P	Note 1,2,4,5
	Adult Cephalic	P	P	P	P	P	P	P	Note 1,2,4,5
	Trans-rectal								
	Trans-vaginal								
	Trans-urethral								
	Trans-esoph. (non-Card.)								
	Musculo-skeletal (Conventional)								
	Musculo-skeletal (Superficial)								
	Intravascular								
	Thoracic/Pleural (Specify****)	P	P			P	P	P	Note 1,2,4,5
Cardiac	Cardiac Adult	P	P	P	P	P	P	P	Note 1,2,3,4,5,7
	Cardiac Pediatric	P	P	P	P	P	P	P	Note 1,2,3,4,5
	Intravascular (Cardiac)								
	Trans-esoph. (Cardiac)								
	Intra-cardiac								
Peripheral vessel	Peripheral vessel								
	Other (Specify***)								
N=new indication ; P=previously cleared by FDA ; E=added under Appendix E									
Additional comments: Combined modes--B+M、PW+B、Color + B、Power + B、PW +Color+ B、Power + PW +B.									
*Intraoperative includes abdominal, thoracic, and vascular etc.									
**Small organ-breast, thyroid, testes.									
***Other use includes Urology.									
****For detection of fluid and pleural motion/sliding.									
Note 1: Tissue Harmonic Imaging. The feature does not use contrast agents.									
Note 2: iScape									
Note 3: TDI									
Note 4: Color M									
Note 5: Smart 3D									
Note 6: Strain Elastography									
Note 7: Contrast imaging (Contrast agent for LVO)									
Note 8: Contrast imaging (Contrast agent for Liver)									

Transducer:	SP5-1Ns								
Intended Use:	Diagnostic ultrasound imaging or fluid flow analysis of the human body as follows:								
Clinical Application		Mode of Operation							
General (Track 1 Only)	Specific (Track 1 & 3)	B	M	PWD	CWD	Color Doppler	Amplitude Doppler	Combined (specify)	Other (specify)
Ophthalmic	Ophthalmic								
Fetal Imaging& Other	Fetal								
	Abdominal	P	P	P	P	P	P	P	Note 1,2,4,5
	Intra-operative (Specify*)								
	Intra-operative (Neuro)								
	Laparoscopic								
	Pediatric	P	P	P	P	P	P	P	Note 1,2,4,5
	Small Organ (Specify**)								
	Neonatal Cephalic	P	P	P	P	P	P	P	Note 1,2,4,5
	Adult Cephalic	P	P	P	P	P	P	P	Note 1,2,4,5
	Trans-rectal								
	Trans-vaginal								
	Trans-urethral								
	Trans-esoph. (non-Card.)								
	Musculo-skeletal (Conventional)								
	Musculo-skeletal (Superficial)								
	Intravascular								
	Thoracic/Pleural (Specify****)	P	P			P	P	P	Note 1,2,4,5
Cardiac	Cardiac Adult	P	P	P	P	P	P	P	Note 1,2,3,4,5,7
	Cardiac Pediatric	P	P	P	P	P	P	P	Note 1,2,3,4,5
	Intravascular (Cardiac)								
	Trans-esoph. (Cardiac)								
	Intra-cardiac								
Peripheral vessel	Peripheral vessel								
	Other (Specify***)								
N=new indication ; P=previously cleared by FDA ; E=added under Appendix E									
Additional comments: Combined modes--B+M、PW+B、Color + B、Power + B、PW +Color+ B、Power + PW +B.									
*Intraoperative includes abdominal, thoracic, and vascular etc.									
**Small organ-breast, thyroid, testes.									
***Other use includes Urology.									
****For detection of fluid and pleural motion/sliding.									
Note 1: Tissue Harmonic Imaging. The feature does not use contrast agents.									
Note 2: iScape									
Note 3: TDI									
Note 4: Color M									
Note 5: Smart 3D									
Note 6: Strain Elastography									
Note 7: Contrast imaging (Contrast agent for LVO)									
Note 8: Contrast imaging (Contrast agent for Liver)									

J Indications for Use

Transducer:	P7-3Ts								
Intended Use:	Diagnostic ultrasound imaging or fluid flow analysis of the human body as follows:								
Clinical Application		Mode of Operation							
General (Track 1 Only)	Specific (Track 1 & 3)	B	M	PWD	CWD	Color Doppler	Amplitude Doppler	Combined (specify)	Other (specify)
Ophthalmic	Ophthalmic								
Fetal Imaging& Other	Fetal								
	Abdominal								
	Intra-operative (Specify*)								
	Intra-operative (Neuro)								
	Laparoscopic								
	Pediatric								
	Small Organ (Specify**)								
	Neonatal Cephalic								
	Adult Cephalic								
	Trans-rectal								
	Trans-vaginal								
	Trans-urethral								
	Trans-esoph. (non-Card.)								
	Musculo-skeletal (Conventional)								
	Musculo-skeletal (Superficial)								
	Intravascular								
	Thoracic/Pleural (Specify****)								
Cardiac	Cardiac Adult								
	Cardiac Pediatric								
	Intravascular (Cardiac)								
	Trans-esoph. (Cardiac)	P	P	P	P	P	P	P	Note 1,3,4
	Intra-cardiac								
Peripheral vessel	Peripheral vessel								
	Other (Specify***)								
N=new indication ; P=previously cleared by FDA ; E=added under Appendix E									
Additional comments: Combined modes--B+M、PW+B、Color + B、Power + B、PW +Color+ B、Power + PW +B.									
*Intraoperative includes abdominal, thoracic, and vascular etc.									
**Small organ-breast, thyroid, testes.									
***Other use includes Urology.									
****For detection of fluid and pleural motion/sliding.									
Note 1: Tissue Harmonic Imaging. The feature does not use contrast agents.									
Note 2: iScape									
Note 3: TDI									
Note 4: Color M									
Note 5: Smart 3D									
Note 6: Strain Elastography									
Note 7: Contrast imaging (Contrast agent for LVO)									
Note 8: Contrast imaging (Contrast agent for Liver)									

Transducer:	P8-3Ts								
Intended Use:	Diagnostic ultrasound imaging or fluid flow analysis of the human body as follows:								
Clinical Application		Mode of Operation							
General (Track 1 Only)	Specific (Track 1 & 3)	B	M	PWD	CWD	Color Doppler	Amplitude Doppler	Combined (specify)	Other (specify)
Ophthalmic	Ophthalmic								
Fetal Imaging& Other	Fetal								
	Abdominal								
	Intra-operative (Specify*)								
	Intra-operative (Neuro)								
	Laparoscopic								
	Pediatric								
	Small Organ (Specify**)								
	Neonatal Cephalic								
	Adult Cephalic								
	Trans-rectal								
	Trans-vaginal								
	Trans-urethral								
	Trans-esoph. (non-Card.)								
	Musculo-skeletal (Conventional)								
	Musculo-skeletal (Superficial)								
	Intravascular								
	Thoracic/Pleural (Specify****)								
Cardiac	Cardiac Adult								
	Cardiac Pediatric								
	Intravascular (Cardiac)								
	Trans-esoph. (Cardiac)	P	P	P	P	P	P	P	Note1,3,4
	Intra-cardiac								
Peripheral vessel	Peripheral vessel								
	Other (Specify***)								
N=new indication ; P=previously cleared by FDA ; E=added under Appendix E									
Additional comments: Combined modes--B+M、 PW+B、 Color + B、 Power + B、 PW +Color+ B、 Power + PW +B.									
*Intraoperative includes abdominal, thoracic, and vascular etc.									
**Small organ-breast, thyroid, testes.									
***Other use includes Urology.									
****For detection of fluid and pleural motion/sliding.									
Note 1: Tissue Harmonic Imaging. The feature does not use contrast agents.									
Note 2: iScape									
Note 3: TDI									
Note 4: Color M									
Note 5: Smart 3D									
Note 6: Strain Elastography									
Note 7: Contrast imaging (Contrast agent for LVO)									
Note 8: Contrast imaging (Contrast agent for Liver)									

Transducer:	P10-4s								
Intended Use:	Diagnostic ultrasound imaging or fluid flow analysis of the human body as follows:								
Clinical Application		Mode of Operation							
General (Track 1 Only)	Specific (Track 1 & 3)	B	M	PWD	CWD	Color Doppler	Amplitude Doppler	Combined (specify)	Other (specify)
Ophthalmic	Ophthalmic								
Fetal Imaging & Other	Fetal								
	Abdominal	P	P	P	P	P	P	P	Note 1,4,5
	Intra-operative (Specify*)								
	Intra-operative (Neuro)								
	Laparoscopic								
	Pediatric	P	P	P	P	P	P	P	Note 1,4,5
	Small Organ (Specify**)								
	Neonatal Cephalic	P	P	P	P	P	P	P	Note 1,4,5
	Adult Cephalic								
	Trans-rectal								
	Trans-vaginal								
	Trans-urethral								
	Trans-esoph. (non-Card.)								
	Musculo-skeletal (Conventional)								
	Musculo-skeletal (Superficial)								
	Intravascular								
	Thoracic/Pleural (Specify****)								
Cardiac	Cardiac Adult								
	Cardiac Pediatric	P	P	P	P	P	P	P	Note 1,3,4,5
	Intravascular (Cardiac)								
	Trans-esoph. (Cardiac)								
	Intra-cardiac								
Peripheral vessel	Peripheral vessel								
	Other (Specify***)								
N=new indication ; P=previously cleared by FDA ; E=added under Appendix E									
Additional comments: Combined modes--B+M、PW+B、 Color + B、 Power + B、 PW +Color+ B、 Power + PW +B.									
*Intraoperative includes abdominal, thoracic, and vascular etc.									
**Small organ-breast, thyroid, testes.									
***Other use includes Urology.									
****For detection of fluid and pleural motion/sliding.									
Note 1: Tissue Harmonic Imaging. The feature does not use contrast agents.									
Note 2: iScape									
Note 3: TDI									
Note 4: Color M									
Note 5: Smart 3D									
Note 6: Strain Elastography									
Note 7: Contrast imaging (Contrast agent for LVO)									
Note 8: Contrast imaging (Contrast agent for Liver)									

Transducer:	C5-2s								
Intended Use:	Diagnostic ultrasound imaging or fluid flow analysis of the human body as follows:								
Clinical Application		Mode of Operation							
General (Track	Specific (Track 1 & 3)	B	M	PWD	CWD	Color Doppler	Amplitude Doppler	Combined (specify)	Other (specify)
Ophthalmic	Ophthalmic								
Fetal Imaging&	Fetal	P	P	P		P	P	P	Note 1,2,4,5
Other	Abdominal	P	P	P		P	P	P	Note 1,2,4,5,8
	Intra-operative (Specify*)								
	Intra-operative (Neuro)								
	Laparoscopic								
	Pediatric	P	P	P		P	P	P	Note 1,2,4,5
	Small Organ (Specify**)								
	Neonatal Cephalic								
	Adult Cephalic								
	Trans-rectal								
	Trans-vaginal								
	Trans-urethral								
	Trans-esoph. (non-Card.)								
	Musculo-skeletal (Conventional)	P	P	P		P	P	P	Note 1,2,4,5
	Musculo-skeletal (Superficial)								
	Intravascular								
	Thoracic/Pleural								
Cardiac	Cardiac Adult								
	Cardiac Pediatric								
	Intravascular (Cardiac)								
	Trans-esoph. (Cardiac)								
	Intra-cardiac								
Peripheral vessel	Peripheral vessel	P	P	P		P	P	P	Note 1,2,4,5
	Other (Specify***)	P	P	P		P	P	P	Note 1,2,4,5
N=new indication ; P=previously cleared by FDA ; E=added under Appendix E									
Additional comments: Combined modes--B+M、PW+B、Color + B、Power + B、PW +Color+ B、Power + PW +B.									
*Intraoperative includes abdominal, thoracic, and vascular etc.									
**Small organ-breast, thyroid, testes.									
***Other use includes Urology.									
****For detection of fluid and pleural motion/sliding.									
Note 1: Tissue Harmonic Imaging. The feature does not use contrast agents.									
Note 2: iScape									
Note 3: TDI									
Note 4: Color M									
Note 5: Smart 3D									
Note 6: Strain Elastography									
Note 7: Contrast imaging (Contrast agent for LVO)									
Note 8: Contrast imaging (Contrast agent for Liver)									

Transducer:	L12-4s								
Intended Use:	Diagnostic ultrasound imaging or fluid flow analysis of the human body as follows:								
Clinical Application		Mode of Operation							
General (Track 1 Only)	Specific (Track 1 & 3)	B	M	PWD	CWD	Color Doppler	Amplitude Doppler	Combined (specify)	Other (specify)
Ophthalmic	Ophthalmic	P		P		P		P	
Fetal Imaging & Other	Fetal								
	Abdominal	P	P	P		P	P	P	Note 1,2,5
	Intra-operative (Specify*)								
	Intra-operative (Neuro)								
	Laparoscopic								
	Pediatric	P	P	P		P	P	P	Note 1,2,5
	Small Organ (Specify**)	P	P	P		P	P	P	Note 1,2,5,6
	Neonatal Cephalic								
	Adult Cephalic								
	Trans-rectal								
	Trans-vaginal								
	Trans-urethral								
	Trans-esoph. (non-Card.)								
	Musculo-skeletal (Conventional)	P	P	P		P	P	P	Note 1,2,5
	Musculo-skeletal (Superficial)	P	P	P		P	P	P	Note 1,2,5
	Intravascular								
	Thoracic/Pleural (Specify****)	P	P			P	P	P	Note 1,2,5
Cardiac	Cardiac Adult								
	Cardiac Pediatric								
	Intravascular (Cardiac)								
	Trans-esoph. (Cardiac)								
	Intra-cardiac								
Peripheral vessel	Peripheral vessel	P	P	P		P	P	P	Note 1,2,5
	Other (Specify***)								
N=new indication ; P=previously cleared by FDA ; E=added under Appendix E									
Additional comments: Combined modes--B+M、PW+B、 Color + B、 Power + B、 PW +Color+ B、 Power + PW +B.									
*Intraoperative includes abdominal, thoracic, and vascular etc.									
**Small organ-breast, thyroid, testes.									
***Other use includes Urology.									
****For detection of fluid and pleural motion/sliding.									
Note 1: Tissue Harmonic Imaging. The feature does not use contrast agents.									
Note 2: iScape									
Note 3: TDI									
Note 4: Color M									
Note 5: Smart 3D									
Note 6: Strain Elastography									
Note 7: Contrast imaging (Contrast agent for LVO)									
Note 8: Contrast imaging (Contrast agent for Liver)									

Transducer:	P8-2s								
Intended Use:	Diagnostic ultrasound imaging or fluid flow analysis of the human body as follows:								
Clinical Application	Mode of Operation								
General (Track 1 Only)	Specific (Track 1 & 3)	B	M	PWD	CWD	Color Doppler	Amplitude Doppler	Combined (specify)	Other (specify)
Ophthalmic	Ophthalmic								
Fetal Imaging & Other	Fetal								
	Abdominal	P	P	P	N	P	P	P	Note 1,3,4,5
	Intra-operative (Specify*)								
	Intra-operative (Neuro)								
	Laparoscopic								
	Pediatric	P	P	P	N	P	P	P	Note 1,3,4,5
	Small Organ (Specify**)								
	Neonatal Cephalic	P	P	P	N	P	P	P	Note 1,3,4,5
	Adult Cephalic	P	P	P	N	P	P	P	Note 1,3,4,5
	Trans-rectal								
	Trans-vaginal								
	Trans-urethral								
	Trans-esoph. (non-Card.)								
	Musculo-skeletal (Conventional)	P	P	P		P	P	P	Note 1,3,4,5
	Musculo-skeletal (Superficial)								
	Intravascular								
	Thoracic/Pleural (Specify****)								
Cardiac	Cardiac Adult	P	P	P	N	P	P	P	Note 1,3,4,5
	Cardiac Pediatric	P	P	P	N	P	P	P	Note 1,3,4,5
	Intravascular (Cardiac)								
	Trans-esoph. (Cardiac)								
	Intra-cardiac								
Peripheral vessel	Peripheral vessel								
	Other (Specify***)								
N=new indication ; P=previously cleared by FDA ; E=added under Appendix E									
Additional comments: Combined modes--B+M、PW+B、Color + B、Power + B、PW +Color+ B、 Power + PW +B.									
*Intraoperative includes abdominal, thoracic, and vascular etc.									
**Small organ-breast, thyroid, testes.									
***Other use includes Urology.									
****For detection of fluid and pleural motion/sliding.									
Note 1: Tissue Harmonic Imaging. The feature does not use contrast agents.									
Note 2: iScape									
Note 3: TDI									
Note 4: Color M									
Note 5: Smart 3D									
Note 6: Strain Elastography									
Note 7: Contrast imaging (Contrast agent for LVO)									
Note 8: Contrast imaging (Contrast agent for Liver)									

J Indications for Use

Transducer:	CW2s								
Intended Use:	Diagnostic ultrasound imaging or fluid flow analysis of the human body as follows:								
Clinical Application		Mode of Operation							
General (Track 1 Only)	Specific (Track 1 & 3)	B	M	PWD	CWD	Color Doppler	Amplitude Doppler	Combined (specify)	Other (specify)
Ophthalmic	Ophthalmic								
Fetal Imaging & Other	Fetal								
	Abdominal								
	Intra-operative (Specify*)								
	Intra-operative (Neuro)								
	Laparoscopic								
	Pediatric				P				
	Small Organ (Specify**)								
	Neonatal Cephalic								
	Adult Cephalic				P				
	Trans-rectal								
	Trans-vaginal								
	Trans-urethral								
	Trans-esoph. (non-Card.)								
	Musculo-skeletal (Conventional)								
	Musculo-skeletal (Superficial)								
	Intravascular								
	Thoracic/Pleural (Specify****)								
Cardiac	Cardiac Adult				P				
	Cardiac Pediatric				P				
	Intravascular (Cardiac)								
	Trans-esoph. (Cardiac)								
	Intra-cardiac								
Peripheral vessel	Peripheral vessel				P				
	Other (Specify***)								
N=new indication ; P=previously cleared by FDA ; E=added under Appendix E									
Additional comments: Combined modes--B+M、PW+B、Color + B、Power + B、PW +Color+ B、Power + PW +B.									
*Intraoperative includes abdominal, thoracic, and vascular etc.									
**Small organ-breast, thyroid, testes.									
***Other use includes Urology.									
****For detection of fluid and pleural motion/sliding.									
Note 1: Tissue Harmonic Imaging. The feature does not use contrast agents.									
Note 2: iScape									
Note 3: TDI									
Note 4: Color M									
Note 5: Smart 3D									
Note 6: Strain Elastography									
Note 7: Contrast imaging (Contrast agent for LVO)									
Note 8: Contrast imaging (Contrast agent for Liver)									

