

VS 8/VS 8A

Vital Signs Monitor

Operator's Manual

© Copyright 2021-2024 Shenzhen Mindray Bio-Medical Electronics Co., Ltd. All rights reserved.

Release time: February 2024

Revision: 6.0

WARNING

- **Federal Law (USA) restricts this device to sale by or on the order of a physician or other practitioner licensed by U.S. state law to use or order the use of this device.**
-
-

Intellectual Property Statement

SHENZHEN MINDRAY BIO-MEDICAL ELECTRONICS CO., LTD. (hereinafter called Mindray) owns the intellectual property rights to this Mindray product and this manual. This manual may refer to information protected by copyright or patents and does not convey any license under the patent rights or copyright of Mindray, or of others.

Mindray intends to maintain the contents of this manual as confidential information. Disclosure of the information in this manual in any manner whatsoever without the written permission of Mindray is strictly forbidden.

Release, amendment, reproduction, distribution, rental, adaptation, translation or any other derivative work of this manual in any manner whatsoever without the written permission of Mindray is strictly forbidden.

mindray is the trademark, registered or otherwise, of Mindray in China and other countries. All other trademarks that appear in this manual are used only for informational or editorial purposes. They are the property of their respective owners.

This posting serves as notice under 35 U.S.C.§287(a) for Mindray patents: <http://www.mindrayna.com/patents>.

Manufacturer's Responsibility

Contents of this manual are subject to changes without prior notice.

Mindray is responsible for the effects on safety, reliability and performance of this product, only if:

- all installation operations, expansions, changes, modifications and repairs of this product are conducted by Mindray authorized personnel;
- the electrical installation of the relevant room complies with the applicable national and local requirements;
- the product is used in accordance with the instructions for use.

WARNING

- **Only skilled/trained clinical professionals should operate this equipment.**
 - **It is important for the hospital or organization that uses this equipment to perform a recommended service/maintenance plan. Neglect of this may result in machine breakdown or personal injury.**
-
-

Service

Mindray maintains a network of service representatives and factory-trained distributors. Prior to requesting service, perform a complete operational check of the instrument to verify proper control settings. If operational problems continue to exist, contact Mindray service.

In North America contact the Service Department at (800) 288-2121, ext: 8116 for Technical Support or (201) 995-8000 for assistance in determining the nearest field service location.

Please include the instrument model number, the serial number, and a description of the problem with all requests for service.

Any questions regarding the warranty should be directed to the local sales or service representative.

Company Contact

Manufacturer:	Shenzhen Mindray Bio-Medical Electronics Co., Ltd.
Address	Mindray Building, Keji 12th Road South, High-tech Industrial Park, Nanshan, Shenzhen 518057, P.R.China
Website	www.mindray.com
E-mail Address:	service@mindray.com
Tel:	+86 755 81888998
Fax:	+86 755 26582680

Distributor:	Mindray DS USA, Inc.
Address:	800 MacArthur Boulevard, Mahwah, New Jersey, 07430 USA
Tel:	1.800.288.2121, 1.201.995.8000
Website:	www.mindray.com

Preface

Manual Purpose

This manual contains the instructions necessary to operate the product safely and in accordance with its function and intended use. Observance of this manual is a prerequisite for proper product performance and correct operation and ensures patient and operator safety.

This manual is based on the maximum configuration and therefore some contents may not apply to the product. If you have any question, please contact Mindray.

This manual is an integral part of the product. It should always be kept close to the equipment so that it can be obtained conveniently when needed.

Intended Audience

This manual is geared for clinical professionals who are expected to have a working knowledge of medical procedures, practices and terminology as required for monitoring of patients.

Illustrations

All illustrations in this manual serve as examples only. They may not necessarily reflect the setup or data displayed on the monitor.

Conventions

- *Italic text* is used in this manual to quote the referenced manuals, chapters, sections and formulas.
- **Bold text** is used to indicate the screen texts and names of hard keys.
- → is used to indicate operational procedures.

Contents

1 Safety	1 - 1
1.1 Safety Information	1 - 1
1.1.1 Warnings	1 - 1
1.1.2 Cautions	1 - 2
1.1.3 Notes	1 - 3
1.2 Equipment Symbols	1 - 4
2 Equipment Introduction	2 - 1
2.1 Indications for Use	2 - 1
2.2 Applied Parts	2 - 1
2.3 Main Unit	2 - 2
2.3.1 Front View	2 - 2
2.3.2 Side View	2 - 4
2.3.3 Rear View	2 - 5
3 Getting Started	3 - 1
3.1 Equipment Preparation Safety Information	3 - 1
3.2 Unpacking and Checking	3 - 2
3.3 Environmental Requirements	3 - 2
3.4 Setting Up the Equipment	3 - 3
3.4.1 Installing a Battery	3 - 3
3.4.2 Connecting the AC Mains	3 - 3
3.4.3 Connecting a Barcode Reader	3 - 4
3.4.4 Connecting a Digital Scale	3 - 4
3.4.5 Setting up a Card Reader	3 - 4
3.5 Turning on the Monitor	3 - 5
3.6 Start Wizard	3 - 5
3.7 Operation and Navigation	3 - 6
3.7.1 Using the Touchscreen	3 - 6
3.7.2 Using the Knob	3 - 7
3.7.3 Using the On-Screen Keyboard	3 - 7
3.7.4 Using the Barcode Reader	3 - 8
3.8 Screen Display	3 - 9
3.8.1 Main Screen	3 - 9
3.8.2 Dialogs	3 - 10
3.8.3 Quick Keys	3 - 10
3.8.4 On-screen Symbols	3 - 11
3.9 Configuring the Monitor	3 - 12
3.9.1 Setting the Workflow	3 - 12
3.9.2 Adjusting the Screen Brightness	3 - 17
3.9.3 Adjusting the Volume	3 - 17
3.9.4 Changing Measurement Colors	3 - 18
3.9.5 Setting the Date and Time	3 - 18

3.9.6 Checking Software Licenses	3 - 18
3.10 Start Working	3 - 19
3.10.1 Selecting a Work Mode	3 - 19
3.10.2 Inputting Patient Information	3 - 21
3.10.3 Accessing Parameter Setup Menus	3 - 21
3.10.4 Checking the Alarm Settings	3 - 21
3.11 Connecting the CMS	3 - 21
3.12 Connecting the eGateway	3 - 22
3.13 Connecting the Wireless Network	3 - 22
3.14 Stopping a Parameter Measurement	3 - 22
3.15 Turning Off the Monitor	3 - 22
4 Managing Patients	4 - 1
4.1 Admitting a Patient	4 - 1
4.1.1 Automatically Admitting a Patient	4 - 1
4.1.2 Manually Admitting a Patient	4 - 1
4.2 Managing Patient Information	4 - 2
4.2.1 Entering the Patient Management Menu	4 - 2
4.2.2 Editing Patient Information	4 - 2
4.2.3 Saving Patient Data from ADT Database to Local Patient List	4 - 2
4.3 Discharging a Patient	4 - 3
4.3.1 Manually Discharging a Patient	4 - 3
4.4 Deleting Patient Data	4 - 3
5 Alarms	5 - 1
5.1 Alarm Introduction	5 - 1
5.2 Alarm Safety Information	5 - 1
5.3 Understanding the Alarms	5 - 2
5.3.1 Alarm Categories	5 - 2
5.3.2 Alarm Priorities	5 - 2
5.3.3 Alarm Indicators	5 - 2
5.3.4 Alarm Status Symbols	5 - 3
5.4 Checking Alarm List	5 - 4
5.5 Accessing On-screen Help for Technical Alarms (AlarmSight)	5 - 4
5.6 Changing Alarm Settings	5 - 4
5.6.1 Setting Parameter Alarm Properties (Continuous Monitoring Mode)	5 - 4
5.6.2 Guard Limit	5 - 5
5.6.3 Changing the Alarm Volume	5 - 5
5.6.4 Setting the Apnea Delay Time	5 - 5
5.6.5 Restoring the Default Alarm Settings	5 - 6
5.7 Pausing Alarms/Pausing Alarm Tones	5 - 6
5.7.1 Pausing Alarms	5 - 6
5.7.2 Pausing Alarm Sound	5 - 7
5.8 Resetting Alarms	5 - 8
5.8.1 Resetting Physiological Alarms	5 - 8

5.8.2 Resetting Technical Alarms	5 - 8
5.9 Latching Alarms	5 - 9
5.10 Nurse Call	5 - 9
5.11 Testing Alarms	5 - 10
6 Monitoring Pulse Oxygen Saturation (SpO₂)	6 - 1
6.1 SpO ₂ Introduction	6 - 1
6.2 SpO ₂ Safety Information	6 - 2
6.3 SpO ₂ Measurement Limitations	6 - 3
6.4 SpO ₂ Display	6 - 5
6.5 Preparing for SpO ₂ Monitoring	6 - 5
6.6 Changing the SpO ₂ Settings	6 - 6
6.6.1 Changing the SpO ₂ Alarm Settings	6 - 6
6.6.2 Nellcor SatSeconds™ Alarm Management	6 - 7
6.6.3 Setting the Nellcor SpO ₂ SatSeconds	6 - 8
6.6.4 Setting SpO ₂ Sensitivity (for Masimo SpO ₂)	6 - 8
6.6.5 Enabling FastSAT (for Masimo SpO ₂)	6 - 9
6.6.6 Displaying SIQ (for Masimo SpO ₂)	6 - 10
6.6.7 Changing Averaging Time (for Masimo SpO ₂)	6 - 10
6.6.8 Showing/Hiding PI	6 - 11
6.6.9 Monitoring SpO ₂ and NIBP Simultaneously	6 - 11
6.6.10 Changing the Sweep Speed of the Pleth Wave	6 - 11
6.7 SpO ₂ Troubleshooting	6 - 11
6.8 Nellcor Information	6 - 12
6.9 Masimo Information	6 - 13
6.10 Masimo End-User License Agreement	6 - 13
7 Monitoring PR	7 - 1
7.1 PR Introduction	7 - 1
7.2 PR Display	7 - 1
7.3 Changing the PR Settings	7 - 1
7.3.1 Changing the PR Alarm Settings	7 - 1
7.3.2 Changing the Pulse Volume	7 - 2
7.3.3 Enabling Irregular PR	7 - 2
8 Measuring Temperature (Temp)	8 - 1
8.1 Temp Introduction	8 - 1
8.2 Temp Display	8 - 1
8.3 Monitoring Temp with TrueTemp™ Module	8 - 2
8.3.1 Measuring Temp	8 - 3
8.3.2 Cleaning and Disinfecting Temperature Probe	8 - 6
8.4 Monitoring Temp with Exergen TemporalScanner™ Thermometer	8 - 8
8.4.1 Safety Information	8 - 8
8.4.2 Taking a Temperature with the TemporalScanner™	8 - 9
8.4.3 Understanding the TemporalScanner™ Thermometer LED Display	8 - 11
8.4.4 Fahrenheit or Celsius Conversion	8 - 11

8.4.5 Replacing the Battery	8 - 12
8.4.6 Troubleshooting	8 - 12
8.4.7 Cleaning the TemporalScanner™ Thermometer	8 - 13
8.5 Manually Inputting Temp	8 - 13
9 Measuring Noninvasive Blood Pressure (NIBP)	9 - 1
9.1 NIBP Introduction	9 - 1
9.2 NIBP Safety Information	9 - 2
9.3 NIBP Measurement Limitations	9 - 3
9.4 Measurement Modes	9 - 3
9.5 NIBP Display	9 - 4
9.6 Preparing for NIBP Measurement	9 - 5
9.6.1 Preparing the Patient for NIBP Measurement	9 - 5
9.6.2 Placing the NIBP Cuff	9 - 6
9.7 Performing Measurement	9 - 7
9.7.1 Performing Manual Measurement	9 - 7
9.7.2 Performing Auto Measurement	9 - 8
9.7.3 Performing STAT Measurement	9 - 8
9.7.4 Performing Sequence Measurement	9 - 9
9.8 Changing NIBP Settings	9 - 9
9.8.1 Setting the NIBP Alarm Properties	9 - 9
9.8.2 Setting the NIBP Interval	9 - 9
9.8.3 Selecting NIBP Start Mode	9 - 9
9.8.4 Enabling the NIBP End Tone	9 - 10
9.8.5 Setting NIBP Sequence	9 - 10
9.8.6 Setting the NIBP Display Format	9 - 10
9.8.7 Setting the NIBP Alarm Limits Display Switch	9 - 11
9.8.8 Setting Measurement Times	9 - 11
9.8.9 Correcting the NIBP Measurements	9 - 11
9.9 BP Averaging	9 - 11
9.9.1 Enabling BP Averaging	9 - 11
9.9.2 BP Averaging Display	9 - 12
9.9.3 Performing BP Averaging	9 - 12
9.9.4 Changing BP Averaging Settings	9 - 13
9.10 Orthostatic BP Measurement	9 - 14
9.10.1 Enabling Orthostatic BP Measurement	9 - 14
9.10.2 Orthostatic BP Measurement Display	9 - 14
9.10.3 Performing Orthostatic BP Measurement	9 - 15
9.10.4 Changing Orthostatic BP Measurement Settings	9 - 15
9.11 Assisting Venous Puncture	9 - 17
9.12 NIBP Troubleshooting	9 - 18
10 Monitoring Respiration	10 - 1
10.1 RR Display	10 - 1
10.2 Manually Inputting RR Value	10 - 1
10.3 Setting Timer Interval	10 - 1

11 Manual Parameters	11 - 1
11.1 Manual Input Parameters	11 - 1
11.2 The Manual Input Display	11 - 1
11.3 Inputting/Editing Parameter Information	11 - 2
11.4 Changing the Display of Manual Parameters	11 - 3
12 Clinical Assistive Applications (CAA)	12 - 1
12.1 Early Warning Score (EWS)	12 - 1
12.1.1 The EWS Display	12 - 2
12.1.2 Accessing the EWS Screen	12 - 2
12.1.3 Performing EWS Scoring	12 - 4
12.1.4 Enabling Auto Scoring	12 - 4
12.1.5 Setting Auto Scoring Interval	12 - 5
12.1.6 EWS Alarm	12 - 5
12.1.7 Changing EWS Settings	12 - 6
12.1.8 Viewing Historical Scores	12 - 6
12.2 Glasgow Coma Scale (GCS)	12 - 7
12.2.1 GCS Display	12 - 8
12.2.2 Accessing the GCS Dialog	12 - 9
12.2.3 Performing GCS Scoring	12 - 9
12.2.4 Reviewing GCS Data	12 - 10
12.3 Pain Score	12 - 10
12.3.1 The Pain Score Display	12 - 11
12.3.2 Performing Pain Score	12 - 11
12.4 Targeted Goal	12 - 11
12.4.1 Entering the Targeted Goal Screen	12 - 11
12.4.2 The Display of the Targeted Goal Screen	12 - 12
12.4.3 Operating the Targeted Goal Screen	12 - 12
13 Recording	13 - 1
13.1 Recorder	13 - 1
13.2 Starting Recordings	13 - 1
13.3 Stopping Recordings	13 - 2
13.3.1 Stopping Recordings Manually	13 - 2
13.3.2 Stopping Recordings Automatically	13 - 2
13.4 Recording Related Flags	13 - 2
13.5 Setting up the Recorder	13 - 2
13.6 Clearing Recording Tasks	13 - 3
13.7 Loading Paper	13 - 3
13.8 Removing Paper Jam	13 - 3
13.9 List of Recording Reports	13 - 4
14 Review	14 - 1
14.1 Review Overview	14 - 1
14.2 Review Dialog	14 - 1
14.2.1 Accessing the Review Dialog	14 - 1

14.2.2 Example Review Dialog	14 - 1
14.2.3 Reviewing the Tabular Trends	14 - 2
14.2.4 Reviewing Scores	14 - 3
14.2.5 Reviewing the Graphics Trends	14 - 3
14.2.6 Reviewing Events	14 - 3
15 Managing Configurations	15 - 1
15.1 Configuration Introduction	15 - 1
15.2 Changing the Department	15 - 1
15.3 Setting Default Patient Category	15 - 2
15.4 Setting Workflows	15 - 2
15.5 Transferring a Configuration	15 - 2
15.5.1 Exporting a Configuration	15 - 2
15.5.2 Importing a Configuration	15 - 2
15.6 Modifying Configuration Password	15 - 3
15.7 Restoring the Latest Configuration Automatically	15 - 3
16 Password-protected User Settings	16 - 1
16.1 Setting the Device Location	16 - 1
16.1.1 Setting Monitor Information	16 - 1
16.1.2 Setting Monitor Location	16 - 1
16.1.3 Enabling the Auto Obtain Bed Number Function	16 - 1
16.2 Changing Patient Management Settings	16 - 2
16.2.1 Selecting Displayed Patient Information	16 - 2
16.2.2 Selecting Query Criteria for Searching Patients in ADT Server	16 - 2
16.2.3 Auto Discharging a Patient after Monitor Power Off	16 - 3
16.2.4 Auto Deleting Patient Data after Discharging a Patient	16 - 3
16.2.5 Clearing All Patient Data	16 - 3
16.2.6 Setting Patient Location Options for the Standby Screen	16 - 4
16.3 Changing the Authorization Settings	16 - 4
16.3.1 Setting Clinician Login	16 - 4
16.3.2 Selecting Password for User Maintenance	16 - 4
16.3.3 Selecting Password for Changing Alarm settings	16 - 5
16.3.4 Selecting Password for Viewing Discharged Patient Data	16 - 5
16.4 Changing Settings about Saving and Sending Data	16 - 6
16.4.1 Setting Items about Saving Data	16 - 6
16.4.2 Setting Items about Sending Data	16 - 7
16.5 Changing the Alarm Settings	16 - 8
16.5.1 Setting Alarm Tone Properties	16 - 8
16.5.2 Setting Alarm Pausing and Resetting Properties	16 - 9
16.5.3 Latching Physiological Alarms	16 - 11
16.5.4 Setting Guard Limits	16 - 11
16.5.5 Selecting Alarms to be Sent to the Nurse Call System	16 - 12
16.5.6 Changing Alarm Priority Settings	16 - 12
16.5.7 Setting the Alarm Delay Time	16 - 14
16.6 Changing the Standby Settings	16 - 14

16.6.1	Setting Prompt Message on Standby Screen	16 - 14
16.6.2	Setting Auto Standby	16 - 15
16.6.3	Enabling Black Standby Screen	16 - 15
16.7	Changing CAA Settings	16 - 15
16.7.1	Selecting the Default Scoring Tool	16 - 15
16.7.2	Managing the Scoring Tools	16 - 15
16.7.3	Setting GCS Threshold for Each Consciousness Level	16 - 16
16.8	Changing Module Settings	16 - 16
16.8.1	Selecting NIBP Measurement Algorithm	16 - 16
16.8.2	Selecting Temp Module	16 - 17
16.8.3	Setting Temp Measurement Sites	16 - 17
16.8.4	Adding a New Manual Parameter	16 - 17
16.8.5	Managing Pain Score	16 - 18
16.8.6	Setting Parameter Measurement Timeout	16 - 19
16.8.7	Enabling Outline Font for Suspected Values	16 - 19
16.9	Setting Parameter Units	16 - 19
16.10	Setting the Time	16 - 20
16.10.1	Setting the Time Synchronization	16 - 20
16.10.2	Enabling Auto Daylight Savings Time	16 - 20
16.11	Viewing Version Information	16 - 21
16.12	Checking Battery Information	16 - 21
16.13	Changing Scanner Settings	16 - 21
16.13.1	Setting Scanner Information	16 - 21
16.13.2	Identifying the Barcode Reader (for the non-Mindray Custom 2D Barcode Reader)	
16 - 22		
16.13.3	Selecting Patient Information Read by the Barcode Reader (for the Mindray Custom 2D Barcode Reader)	16 - 22
16.14	Setting the Report Layout	16 - 22
16.15	Configuring the Network	16 - 22
16.15.1	Network Safety Information	16 - 23
16.15.2	Selecting a Network Type	16 - 24
16.15.3	Managing TLS Certifications	16 - 24
16.15.4	Setting the Wired Network	16 - 24
16.15.5	Setting the Wireless Network	16 - 25
16.15.6	Managing Certifications	16 - 25
16.15.7	Enabling Selecting a CMS	16 - 26
16.15.8	Adding CMSs	16 - 26
16.15.9	Using the ADT Gateway	16 - 26
16.15.10	Sending Realtime Data, Waveforms and Alarms via HL7 Protocol	16 - 27
16.15.11	Setting Multicast Parameters	16 - 27
16.15.12	Setting the Network Service Quality Level	16 - 27
16.15.13	Setting MLDAP	16 - 28
16.15.14	Testing MLDAP Server Connection	16 - 28
16.15.15	Setting VitalsLink	16 - 28
16.16	Enabling Bluetooth	16 - 28
16.17	Defining Other Functions	16 - 29

16.17.1 Setting the SpO ₂ Tone Mode	16 - 29
16.17.2 Selecting the Language	16 - 29
16.17.3 Browsing System Log	16 - 30
16.17.4 Exporting System Log	16 - 30
16.17.5 Exporting Patient Data	16 - 30
17 Battery	17 - 1
17.1 Battery Introduction	17 - 1
17.2 Battery Safety Information	17 - 1
17.3 Battery Indications	17 - 2
17.3.1 Battery LED	17 - 2
17.3.2 Battery Symbols	17 - 2
17.3.3 Battery-related Alarms	17 - 2
17.4 Replacing the Battery	17 - 3
17.5 Connecting an External Battery	17 - 3
17.6 Charging a Battery	17 - 4
17.7 Maintaining the Battery	17 - 4
17.7.1 Conditioning the Battery	17 - 4
17.7.2 Checking Battery Performance	17 - 5
17.8 Storing Batteries	17 - 5
17.9 Recycling Batteries	17 - 6
18 Care and Cleaning	18 - 1
18.1 Care and Cleaning Introduction	18 - 1
18.2 Care and Cleaning Safety Information	18 - 1
18.3 Cleaning and Disinfecting the Equipment	18 - 2
18.3.1 Approved Cleaning and Disinfecting Agents	18 - 2
18.3.2 Cleaning the Equipment	18 - 5
18.4 Disinfecting the Equipment.....	18 - 5
18.5 Cleaning the Thermal Print Head	18 - 5
18.6 Cleaning and Disinfecting the Accessories	18 - 6
18.6.1 Approved Accessories Cleaning and Disinfecting Agents	18 - 6
18.6.2 Cleaning the Accessories	18 - 9
18.6.3 Disinfecting the Accessories	18 - 9
18.7 Sterilization	18 - 9
19 Maintenance	19 - 1
19.1 Maintenance Introduction	19 - 1
19.2 Maintenance Safety Information	19 - 1
19.3 Maintenance and Testing Schedule	19 - 2
19.4 Checking Version Information	19 - 3
19.5 Testing Methods and Procedures	19 - 3
19.5.1 Performing Visual Inspection	19 - 3
19.5.2 Performing Power-on Test	19 - 4
19.5.3 Testing the Recorder	19 - 4
19.5.4 Checking the Battery	19 - 4

19.6 NIBP Maintenance	19 - 4
19.6.1 NIBP Leakage Test	19 - 4
19.6.2 NIBP Accuracy Test	19 - 4
19.7 Disposing of the Monitor	19 - 4
20 Accessories	20 - 1
20.1 SpO ₂ Accessories	20 - 1
20.1.1 Extension Cables and Adapter Cables Available for Purchase	20 - 2
20.1.2 Extension Cables and Adapter Cables Also Compatible	20 - 2
20.1.3 Masimo SpO ₂ RD Set Sensors Available for Purchase	20 - 2
20.1.4 Masimo SpO ₂ LNCS Sensors Also Compatible	20 - 3
20.1.5 Nellcor SpO ₂ Sensors Also Compatible	20 - 4
20.2 NIBP Accessories	20 - 4
20.2.1 NIBP Hoses Available for Purchase	20 - 4
20.2.2 Cuffs Available for Purchase	20 - 5
20.3 Temp Accessories	20 - 6
20.3.1 TrueTemp™ Probes Available for Purchase	20 - 6
20.3.2 TrueTemp™ Probe Wells Available for Purchase	20 - 6
20.3.3 TrueTemp™ Probe Covers Available for Purchase	20 - 6
20.3.4 Exergen Temp Probe Available for Purchase	20 - 6
20.4 Mount and Mounting Accessories	20 - 7
20.5 Miscellaneous Accessories	20 - 7
A Product Specifications	A - 1
A.1 Monitor Safety Specifications	A - 1
A.2 Environmental Specifications	A - 1
A.3 Power Supply Specifications	A - 2
A.4 Physical Specifications	A - 3
A.5 Hardware Specifications	A - 3
A.5.1 Display	A - 3
A.5.2 Recorder	A - 3
A.5.3 LEDs	A - 4
A.5.4 Audio Indicator	A - 4
A.5.5 Monitor Interface Specifications	A - 4
A.5.6 Outputs	A - 4
A.5.7 Wireless Network	A - 4
A.5.8 Wi-Fi Performance Specifications	A - 5
A.5.9 Bluetooth Specification	A - 7
A.5.10 Bluetooth Performance Specifications	A - 7
A.6 Measurement Specifications	A - 9
A.6.1 SpO ₂ Specifications	A - 9
A.6.2 PR Specifications	A - 11
A.6.3 NIBP Specifications	A - 13
A.6.4 Temp Specifications	A - 14
B EMC and Radio Regulatory Compliance	B - 1
B.1 EMC	B - 1

B.2 Radio Regulatory Compliance	B - 7
C Default Settings	C - 1
C.1 Parameters Default Settings	C - 1
C.1.1 SpO ₂ Default Settings	C - 1
C.1.2 PR Default Settings	C - 2
C.1.3 Temp Default Settings (TrueTemp™)	C - 2
C.1.4 NIBP Default Settings	C - 2
C.1.5 EWS Default Settings	C - 5
C.2 Routine Default Settings	C - 6
C.2.1 Alarm Default Settings	C - 6
C.2.2 Parameter Color Default Settings	C - 6
C.2.3 Display Default Settings	C - 6
C.2.4 Volume Default Settings	C - 6
C.2.5 Record Setup	C - 7
C.2.6 System Time Default Settings	C - 7
D Alarm Messages	D - 1
D.1 Physiological Alarm Messages	D - 1
D.1.1 General Physiological Alarm Messages	D - 1
D.1.2 SpO ₂ Physiological Alarm Messages	D - 1
D.1.3 PR Physiological Alarm Messages	D - 2
D.1.4 NIBP Physiological Alarm Messages	D - 2
D.2 Technical Alarm Messages	D - 2
D.2.1 General Technical Alarm Messages	D - 3
D.2.2 SpO ₂ Technical Alarm Messages	D - 3
D.2.3 Temp Technical Alarm Messages	D - 5
D.2.4 NIBP Technical Alarm Messages	D - 6
D.2.5 EWS Technical Alarms	D - 7
D.2.6 Power Supply Technical Alarm Messages	D - 7
D.2.7 Technical Alarm Messages Related to Networked Monitoring	D - 8
D.2.8 Other System Technical Alarm Messages	D - 9
E SpO₂ Sensor Accuracy	E - 1
E.1 The Accuracy of Masimo SpO ₂ Sensors	E - 1
E.2 The Accuracy of Nellcor SpO ₂ Sensors	E - 5
F Units, Symbols and Abbreviations	F - 1
F.1 Units	F - 1
F.2 Symbols	F - 2
F.3 Abbreviations	F - 3

1 Safety

1.1 Safety Information

WARNING

- Indicates a potential hazard or unsafe practice that, if not avoided, could result in death or serious injury.
-
-

CAUTION

- Indicates a potential hazard or unsafe practice that, if not avoided, could result in minor personal injury or product/property damage.
-
-

NOTE

- Provides application tips or other useful information that does not involve patient or user risk.
-
-

1.1.1 Warnings

WARNING

- This equipment is used for a single patient at a time.
- To avoid explosion hazards, do not use the equipment in the presence of oxygen-rich atmospheres, flammable anesthetics, or other flammable agents.
- Do not touch the equipment's metal parts or connectors when in contact with the patient; otherwise patient injury may result.
- MR unsafe: the VS series vital signs monitor is not intended to be used within the Magnetic Resonance (MR) environment.
- Before connecting the equipment to the mains power, ensure that the voltage and frequency ratings of the power line are the same as those indicated on the equipment's label or in this manual.

- Before putting the system into operation, the operator must verify that the equipment, connecting cables, and accessories are in correct working order and operating condition.
 - To avoid risk of electric shock, the equipment must only be connected to mains power with protective earth, or operated on battery power.
 - Do not touch the patient and live parts simultaneously. Otherwise patient injury may result.
 - Do not open the equipment housings. All servicing and future upgrades must be carried out by trained and authorized personnel.
 - Do not rely exclusively on the audible alarm system for patient monitoring. Turning the alarm volume to a low level or off may result in a hazard to the patient. Always keep the patient under close surveillance.
 - Alarm settings should be customized according to patient situations.
 - Do not place the equipment or accessories in any position that might cause it to fall on the patient.
 - Do not start or operate the equipment unless the setup was verified to be correct.
 - To avoid inadvertent disconnection, route all cables in a way to prevent a stumbling hazard. Wrap and secure excess cabling to reduce risk of entanglement by patients or personnel.
 - The physiological data and alarm messages displayed on the equipment are for reference only and cannot be directly used for diagnostic interpretation. The equipment should not be used as the sole basis for medical decisions. It must be used in conjunction with clinical signs and symptom. If any measurement seems questionable, first check the patient's vital signs by alternate means and then check the equipment for proper functioning.
 - Do not come into contact with the patient during defibrillation. Otherwise serious injury or death could result.
 - The equipment should not be used as the sole basis for medical decisions. It must be used in conjunction with clinical signs and symptom. If any measurement seems questionable, first check the patient's vital signs by alternate means and then check the equipment for proper functioning.
 - Do not use the multiple portable socket outlets (MPSO) or AC mains extension cords. Insure that the sum of the individual ground leakage currents does not exceed the allowable limits.
-
-

1.1.2 Cautions

CAUTION

- Use only parts and accessories specified in this manual.

- **Disposable accessories are not designed to be reused. Reuse may cause a risk of contamination and affect the measurement accuracy.**
 - **Ensure that the equipment is supplied with continuous electric power during operation from the mains power or batteries. Sudden power failure may cause data loss.**
 - **When no battery is installed, ensure that the monitor is supplied with continuous electric power during operation. Sudden power failure may lead to data loss.**
 - **Store and use the equipment in specified environmental condition. The monitor and accessories may not meet the performance specification due to aging, stored or used outside the specified temperature and humidity range.**
 - **Magnetic and electrical fields are capable of interfering with the proper performance of the equipment. For this reason make sure that all external devices operated in the vicinity of the equipment comply with the relevant EMC requirements. Mobile phones, X-ray equipment, and MRI devices are possible sources of interference as they may emit higher levels of electromagnetic radiation.**
 - **Always install or carry the equipment properly to avoid damage caused by drops, impacts, strong vibrations or other mechanical forces.**
 - **Dry the equipment immediately in case of rain or water spray.**
 - **Some settings are password protected and can only be changed by authorized personnel. Contact your department manager or biomedical engineering department for the passwords used at your facility.**
 - **Do not loop the patient cabling into a tight coil or wrap around the device, as this can damage the patient cabling.**
 - **Dispose of the package material as per the applicable waste control regulations. Keep it out of children's reach.**
 - **At the end of its service life, the equipment, as well as its accessories, must be disposed of in compliance with the guidelines regulating the disposal of such products. If you have any questions concerning disposal of the equipment, please contact Mindray.**
-

1.1.3 Notes















NOTE





















- **The equipment software copyright is solely owned by Mindray. No organization or individual shall resort to modifying, copying, or exchanging it or to any other infringement on it in any form or by any means without due permission.**
- **Put the equipment in a location where it can be easily viewed and operated.**

- The equipment uses a mains plug as isolation means to the mains power. Do not locate the equipment in a place difficult to access the mains plug.
- During normal use, the operator is expected to face the front of the equipment.
- Remove the battery before shipping the monitor or if it will not be used for an extended period of time.
- The software was developed in compliance with IEC62304, to minimize the possibility of hazards arising from software errors.
- This manual is based on the maximum configuration and therefore some contents may not apply to the product. If you have any question, please contact Mindray.
- Observance of this manual is a prerequisite for proper product performance and correct operation and ensures patient and operator safety.
- Keep this manual in the vicinity of the equipment so that it can be referenced when needed.

1.2 Equipment Symbols

Some symbols may not appear on your equipment.

	Caution		Serial number
	Refer to instruction manual/ booklet		Date of manufacture
	Direct current		Alternating current
	Battery indicator		Input/output
	USB connector		Equipotentiality
	DEFIBRILLATION-PROOF TYPE BF APPLIED PART		DEFIBRILLATION-PROOF TYPE CF APPLIED PART
	Gas inlet		Gas outlet

	Graphical record		Alarm Reset
	NIBP Start/Stop key		Admit patient
	Stand-by		Computer network
	General warning sign		Temperature limit
	Atmospheric pressure limitations		Humidity limitations
	This way up		Keep away from rain
	Fragile, handle with care		Stacking limit by number
	Non-ionizing electromagnetic radiation		Plastic identification symbol
	Dispose of in accordance to your country's requirements		Authorized representative in the European Community
	Manufacturer		MR Unsafe (magnetic resonance)
TrueBP™	TrueBP is Mindray's new non-invasive blood pressure measurement algorithm using linear inflation technology, which can measure the blood pressure quickly and comfortably during cuff inflation.		
TrueTemp™	TrueTemp™ is Mindray's new prediction algorithm to measure body temperatures accurately and quickly.		

This page intentionally left blank.

2 Equipment Introduction

2.1 Indications for Use

The VS 8/VS 8A Vital Signs Monitors are intended for monitoring, displaying, reviewing, storing, alarming, and transferring of multiple physiological parameters including Temperature (Temp), Pulse Oxygen Saturation (SpO₂), Pulse Rate (PR), Non-invasive Blood Pressure (NIBP). All the parameters can be monitored on single adult, pediatric, and neonatal patients.

The monitors are to be used in healthcare facilities by clinical professionals or under their guidance. They should only be used by persons who have received adequate training in their use. The VS 8/VS 8A Vital Signs Monitors are not intended for helicopter transport, hospital ambulance, or home use.

NOTE

- **This manual is based on the maximum configuration and therefore some contents may not apply to the product. If you have any question, please contact Mindray.**
-

2.2 Applied Parts

The applied parts of the monitor are:

- SpO₂ sensor
- Temp probe
- NIBP cuff

2.3 Main Unit

2.3.1 Front View

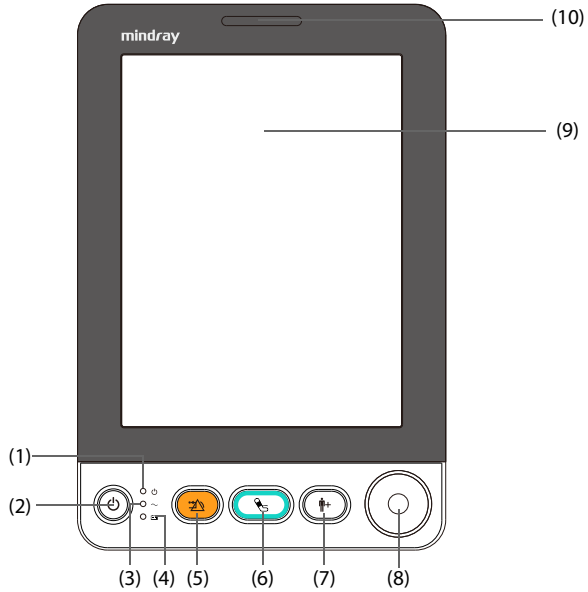

- (1) Power on/off indicator
- On: indicates that the monitor is on or on Standby.
 - Off: indicates that the monitor is off.
- (2) Power switch:
- Pressing this switch turns on the monitor.
 - When the monitor is on, if no measurement is being performed, pressing this switch enters standby mode.
 - When the monitor is on, pressing and holding this switch for above 3 seconds turns off the monitor.
- (3) AC power indicator:
- On: when AC power is connected.
 - Off: when AC power is not connected.

- (4) Battery indicator:
 - Yellow: the battery is being charged.
 - Green: the battery is fully charged.
 - Flashing green: the monitor operates on battery power.
 - Off: no battery is installed, or the monitor is powered off and no AC power is connected.
- (5) Alarm Reset/Pause key
 - Pressing this key resets the alarm system.
 - Pressing and holding this key for more than 2 seconds pauses or resumes alarms.
- (6) NIBP Start/Stop key
Starts/stops NIBP measurement.
- (7) Admit patient key
Press this key to admit a new patient.
- (8) Knob
 - Rotate the knob clockwise or counterclockwise to switch to another screen element.
 - Press the knob to select one item, such as accessing a menu or confirming the selection.
- (9) Display screen
- (10) Alarm indicator
When a physiological alarm or a technical alarm occurs, this indicator will flash as defined below.
 - High priority alarm: the lamp quickly flashes red.
 - Medium priority alarm: the lamp slowly flashes yellow.Low priority alarm: the lamp lights in cyan without flashing.

2.3.2 Side View

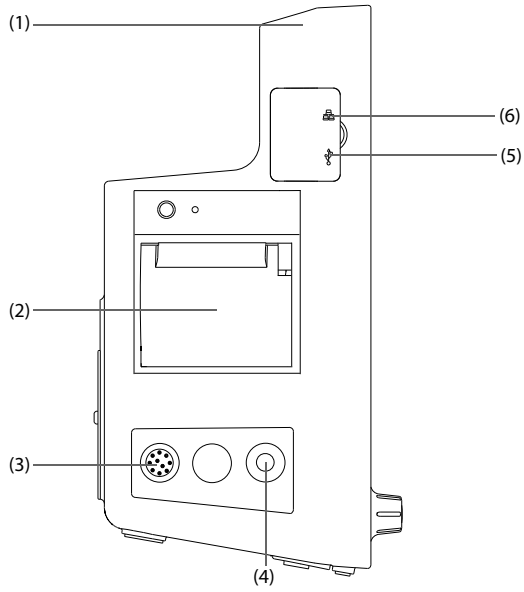

- (1) Handle
- (2) Recorder
- (3) Connector for SpO₂ cable
- (4) Connector for NIBP cuff
- (5) USB connectors
Connect approved USB devices, for example the keyboard, mouse, and barcode reader.
- (6) Network connector

2.3.3 Rear View

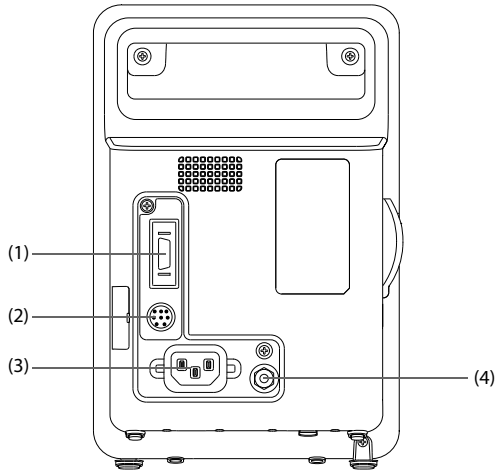

- (1) Multi-function connector
- (2) Connector for an external battery
- (3) AC power input
- (4) Equipotential grounding terminal
When using the monitor together with other devices, connect their equipotential grounding terminals together to eliminate the potential difference between them.

This page intentionally left blank.

3 Getting Started

3.1 Equipment Preparation Safety Information

WARNING

- Use only installation accessories specified by Mindray.
 - Connect only approved devices to this equipment. Devices connected to the equipment must meet the requirements of the applicable IEC standards (e.g. IEC 60950 safety standards for information technology equipment and IEC 60601-1 safety standards for medical electrical equipment). The system configuration must meet the requirements of the IEC 60601-1 medical electrical systems standard. Any personnel who connect devices to the equipment's signal input/output port are responsible for providing evidence that the safety certification of the devices has been performed in accordance to the IEC 60601-1. If you have any questions, please contact Mindray.
 - The monitor and parameter monitoring accessories are suitable for use within the patient environment. For other equipment and accessories connected to the monitor, consult corresponding manufacturers for the suitability within the patient environment.
 - If it is not evident from the equipment specifications whether a particular combination with other devices is hazardous, for example, due to summation of leakage currents, please consult the manufacturer or an expert in the field. A determination must be made that the proposed combination will not negatively affect the devices themselves or the patient's safety.
 - If the accuracy of any value displayed on the monitor, central station, or printed on a report is questionable, determine the patient's vital signs by alternative means. Verify that all equipment is working correctly.
-
-

CAUTION

- The equipment should be installed by Mindray authorized personnel.
- When disposing of the packaging material, be sure to observe the applicable waste control regulations and keep it out of children's reach.
- Before use, verify whether the packages are intact, especially the packages of single use accessories. In case of any damage, do not apply it to the patient.
- Avoid rough handling during transport.

- **Make sure that the equipment operating environment meets the specific requirements. Otherwise unexpected consequences, e.g. damage to the equipment, could result.**
 - **Observance of this manual is a prerequisite for proper product performance and correct operation and ensures patient and operator safety.**
-

NOTE

- **This manual is based on the maximum configuration and therefore some contents may not apply to the product. If you have any question, please contact Mindray.**
 - **Put the equipment in a location where it can be easily viewed and operated.**
 - **Keep this manual in the vicinity of the equipment so that it can be referenced when needed.**
 - **Save the packing case and packaging material as they can be used if the equipment must be reshipped.**
 - **Many settings in the patient monitor are password protected. It is recommended to change the default passwords and keep the passwords safe. Passwords should only be changed by authorized personnel. Contact the department manager or biomedical engineering department for the passwords used at the facility.**
-

3.2 Unpacking and Checking

Before unpacking, examine the packaging carefully for signs of damage. If any damage is detected, contact the carrier, distributor, or Mindray.

If the packing case is intact, open the package and remove the equipment and accessories carefully. Check all materials against the packing list and check for any mechanical damage. Contact Mindray in case of any problems.

3.3 Environmental Requirements

The operating environment of the equipment must meet the requirements specified in this manual.

The environment where the equipment is used shall be reasonably free from noises, vibration, dust, corrosive, flammable and explosive substances. Moreover, to maintain good ventilation, the equipment shall be at least 2 inches (5cm) away from around the cabinet.

When the equipment is moved from one place to another, condensation may occur as a result of temperature or humidity difference. In this case, never start the system before the condensation evaporates.

CAUTION

- **Make sure that the equipment operating environment meets the specific requirements. Otherwise unexpected consequences, e.g. damage to the equipment, could result.**
-

3.4 Setting Up the Equipment

Observance of this manual is a prerequisite for proper product performance and correct operation. It ensures patient and operator safety.

3.4.1 Installing a Battery

It is recommended to always install a fully charged battery in the monitor to ensure normal monitoring in case of accidental power failure.

Follow this procedure:

1. Make sure the monitor is off and all cables are disconnected.
2. Lay the monitor down to have access to the bottom of the monitor.
3. Open the battery compartment door by turning the screw counterclockwise.

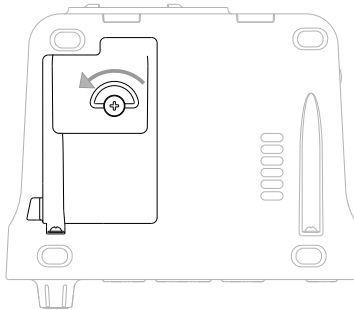

4. Insert the battery into the battery compartment with the battery terminal outwards. Then connect the battery to the connectors on the left of the battery compartment.
5. Close the battery door and turn the screw clockwise.

3.4.2 Connecting the AC Mains

The monitor is powered by an AC power supply. Before connecting the equipment to the AC mains, check that the voltage and frequency ratings of the power line are the same as those indicated beside the AC power input.

To use the AC power source, follow this procedure:

1. Connect the female end of the power cord with the AC power input.
2. Connect the male end of the power cord with a wall AC outlet.
3. Check that the AC indicator is on.

The AC indicator is off if the AC mains is not connected. When AC mains is connected, the AC indicator is illuminated in green.

WARNING

- **Operate the equipment on battery power if the integrity of the protective earth conductor or the protective earthing system in the installation is in doubt.**
-
-

CAUTION

- **Always use the accompanying power cord delivered with the monitor.**
 - **Before connecting the equipment to the AC mains, ensure that the voltage and frequency ratings of the power line are the same as those indicated beside the AC power input.**
-
-

NOTE

- **Use the cable retainer to secure the power cord to prevent it from falling off.**
-
-

3.4.3 Connecting a Barcode Reader

The monitor supports both linear (1D) barcode reader and two-dimension (2D) barcode reader. The barcode reader is connected to the monitor via the USB connector.

3.4.4 Connecting a Digital Scale

You can connect a HEALTH O METER 600KL-BT scale via the USB connector to obtain the height, weight, and BMI data of a patient.

3.4.5 Setting up a Card Reader

You can connect a card reader to read clinician's ID cards for easy input of clinician information. The card reader is connected to the monitor via the USB connector.

The monitor supports the following two types of card readers:

- RF IDeas, RDR-80531BKU
- RF IDeas, RDR-805H1AKU-X-C72

To set up the card reader, follow this procedure:

1. Configure the card reader to work with your Clinician card. For detailed instructions, refer to the user manual of the card reader.
2. Connect the card reader to the monitor via the USB connector.
3. On the monitor, set the MLDAP server as described in *16.15.13 Setting MLDAP*.
4. Test the server connection as described in *16.15.14 Testing MLDAP Server Connection*.
5. Set the clinician login as described in *16.3.1 Setting Clinician Login*. Make sure the settings of **Clinician Login** and **Imprivata Domain** on the monitor are the same with the settings on the Imprivata server.

If your card reader has problem scanning your card after long time use, perform the above procedure again to re-set your card reader.

3.5 Turning on the Monitor

Before beginning measurement, turn on the monitor, and perform the following inspections:

1. Check the monitor for any mechanical damage. Make sure that all external cables, plug-ins and accessories are properly connected.
2. Connect the power cord to the AC power source. Make sure the battery power is sufficient if the monitor is powered by the battery.
3. Press the power switch to turn on the monitor.

The monitor automatically performs a self test at startup. Check that the alarm tone is heard and the alarm lamp illuminates, one after the other, in red, yellow, and cyan. This indicates that the visible and audible alarm indicators function correctly.

CAUTION

- **Check that visual and auditory alarm signals are presented correctly when the equipment is powered on.**
 - **Do not use the monitor on a patient if you suspect it is not working properly, or if it is mechanically damaged. Contact the service personnel or Mindray.**
-

3.6 Start Wizard

When the monitor is started for the first time, a start wizard is launched to help set up your monitor. You can:

- Set the system language: select a language from the list and then select →.
- Set the Temp type: select the Temp module of your monitor and then select →.
- Select **Import Configuration** if a preferred configuration has been exported and saved in a USB drive. For details, refer to *15.5.2 Importing a Configuration*.
- Select **Create New Configuration** to:

- ◆ Set the system time: for details of the settings, see *3.9.5 Setting the Date and Time*.
- ◆ Set parameter units: for details of the settings, see *16.9 Setting Parameter Units*.
- ◆ Set the department of your monitor: the default configurations are department-oriented. Select a department and then select →.

After completing the above settings, you can select:

- **Restart to use:** the monitor restarts and enters normal working mode.
- **Advanced Settings:** you can continue to set the network and workflow. For more information about workflow setting, refer to *3.9.1 Setting the Workflow*.
- **Export Configuration:** you can export the current configuration to a USB drive. Before selecting this option, connect a USB drive to the USB connector first. For details, refer to *15.5.1 Exporting a Configuration*.

3.7 Operation and Navigation

Everything needed to operate the monitor is on its screen. Almost every element on the screen is interactive. Screen elements include parameter values, waveforms, quick keys, information fields, alarms fields and menus. Often you can access the same element in different ways. For example, you can access a parameter dialog by selecting corresponding numeric area or waveform area, or by selecting the **Main Menu** quick key and then **Setup** from the **Parameters** column.

3.7.1 Using the Touchscreen

The monitors are configured with touchscreen. You can touch the screen or swipe across the screen with your fingers to operate the monitor.

3.7.1.1 Tapping or Swiping across the Screen

- Tapping the screen
 - ◆ To select an item from menus or lists, or select a quick key, tap on it with your finger.
 - ◆ To enter a parameter menu, tap the corresponding numeric area or waveform area. For example, select the NIBP area to enter the NIBP menu.
- Swiping across the screen with a single finger:
 - ◆ To scroll through a list or a menu, swipe up or down.
 - ◆ To show more pages of a screen, such as the **Main Menu** screen, swipe left or right to switch between the two setup pages.

3.7.1.2 Locking the Touchscreen



To avoid accidental use, you can temporarily disable the touchscreen by holding and pressing the **Main Menu** quick key and sliding as directed by the arrow. When the

touchscreen is locked, the **Main Menu** quick key changes to .

The touchscreen lock period is configurable. To do so, follow this procedure:

1. Select the **Main Menu** quick key → from the **Display** column select **Display**.
2. Set **Screen Lock Duration**.
 - ◆ **1 min, 30 sec, 20 sec or 10 sec:** a countdown clock is displayed after the touchscreen is locked. When the preset time is reached, the touchscreen is enabled.
 - ◆ **Permanent:** the touchscreen can only be enabled manually.

If you need to manually enable the touchscreen, follow this procedure:

1. Tap anywhere on the touchscreen.
2. Press  and slide it to the  position.

CAUTION





- **Check that the touchscreen is not damaged, broken, or loose. If there is any sign of damage, stop using the monitor and contact the service personnel.**
 - **Wipe off the water on the touchscreen in case of rain or water spray.**
-

3.7.2 Using the Knob

VS 8 series monitor provides a navigation knob and four hardkeys. For detailed descriptions, refer to 2.3.1 *Front View*.

3.7.3 Using the On-Screen Keyboard

The on-screen keyboard enables you to enter information:

- Enter the information by selecting one character after another.
- Select the Backspace key  to delete single characters or select  to delete the entire entry.
- Select the Caps Lock key  to access uppercase letters.
- Select the Enter key  to confirm the entry and close the on-screen keyboard.
- Select  to show the password that has been input.

3.7.4 Using the Barcode Reader

The monitor supports both a linear (1D) barcode reader and two-dimensional (2D) barcode reader. The barcode reader is connected to the monitor through the USB connector.

If you are using the Mindray custom 2D barcode reader (Model HS-1R, HS-1RS or HS-1M), before using it for the first time, clear old data formats and configure the barcode reader.

To do so, follow this procedure:

1. Scan the engineering barcode to clear the previous data format.
2. Scan the 2D engineering barcode which contains the hospital's data format.

NOTE

- **Contact the scanner manufacturer or Mindray to obtain the barcodes for clearing data formats and programming the hospital's data format.**
-

3.8 Screen Display

3.8.1 Main Screen

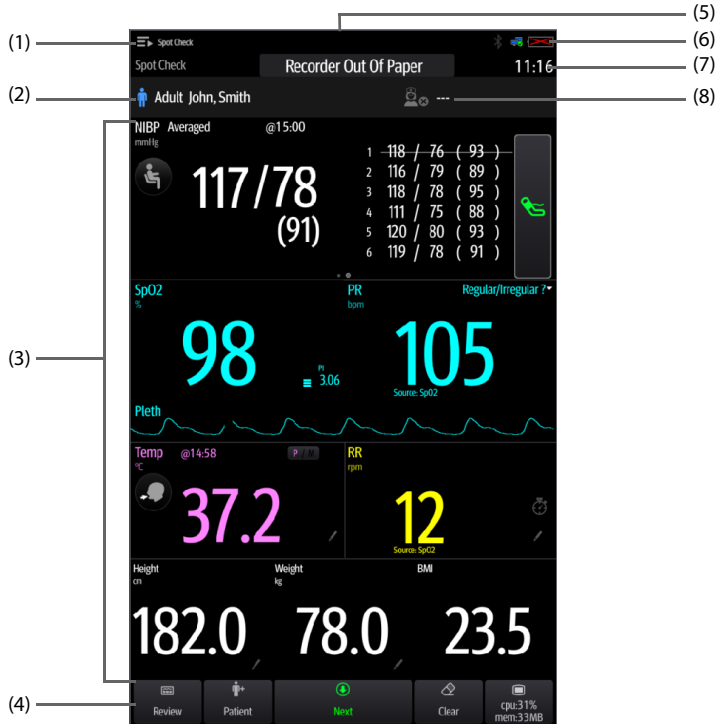

- (1) Workflow area: displays the current workflow. Select this area and you can switch to another workflow.
- (2) Patient information area: displays patient information, including patient ID, name, gender and so on. The displayed patient information is configurable. Selecting this area enters the **Patient Management** menu.
- (3) Parameter area: displays parameter values, waveforms, alarms and so on. Selecting a parameter area displays the corresponding parameter menu.
- (4) Quick key area: displays quick keys. These keys may vary according to the workflow settings.
- (5) Alarm information area: displays physiological alarms on the above, and prompt messages and technical alarms at the bottom.
- (6) System status information area: displays symbols indicating the battery status, network status, blue tooth status etc.

- (7) System time: displays the current system time.
- (8) Clinician information: displays login information of clinician. Select this area to log in or out.

3.8.2 Dialogs

All dialogs have similar style and structure, see the figure below:













- (1) Dialog heading
- (2) Subdialog tabs
- (3) Main body area: includes dialog items and options.
- (4) Operation buttons
- (5) Exit button: closes the current dialog.
- (6) Switch:
 - Green: the switch is on.
 - Gray: the switch is off.

3.8.3 Quick Keys









The monitor provides quick keys for you to quickly access some functions. The quick key area is located at the bottom of the screen. These keys may vary according to the workflow settings.











The following table shows available quick keys.

Symbol	Label	Function	Symbol	Label	Function
	Review	Enters the Review dialog.		Patient	Displays the patient list.
	Save	Saves the input information.		Clear	Clears all input information.
	Main Menu	Enters the main menu.		More	Shows more quick keys.
	Next	Shows the next screen.		Back	Shows the previous screen.
	Alarm Pause	Pauses the physiological alarms.		Alarm Reset	Resets the alarm system.
	Targeted Goal	Enters the Targeted Goal screen.			

3.8.4 On-screen Symbols

The following table lists the on-screen symbols:

Symbol	Description	Symbol	Description
	Adult, male (blue)		Adult, female (pink)
	Pediatric, male (blue)		Pediatric, female (pink)
	Neonate, male (blue)		Neonate, female (pink)
	Wired network is connected.		Wired network is not connected.

Symbol	Description	Symbol	Description
	All the alarms are paused.		Individual physiological alarms are turned off or the monitor is in the alarm off status.
	Audible alarm tones are paused.		Alarms are acknowledged and the alarm is reset.
	Audible alarm tones are turned off.		CMS is connected. Press this button to select another available CMS, if any.
	Wireless network is connected. The solid part indicates network signal strength. Press this button to select another available network, if any.		Wireless network cannot be connected.
	Bluetooth device is connected.		Bluetooth function is enabled.

3.9 Configuring the Monitor

Configure the monitor before putting it in use.

3.9.1 Setting the Workflow

Workflow is a configuration user-definable basing on daily tasks to simplify the use of the monitor.



You can set the screen layout to select parameters displayed on the main screen and their positions.

You can also make preferential settings for each parameter. For workflows under **Continuous Monitoring**, you can change alarm settings.



Every time you switch to a workflow, the pre-defined settings are loaded.

3.9.1.1 Accessing the Workflow Setup Menu

Access the **Workflow Setup** menu in the following ways:

- Select the **Main Menu** quick key → from the **Configuration** column select **Workflow** → input the required password → select .
- Select the **Main Menu** quick key → from the **Configuration** column select **Manage** → input the required password → select  → **Workflow Setup**.

In the **Workflow Setup** menu, the currently set workflows are listed under the work modes. You can:





- Select  to change the current workflow settings.
- Select  to add a copy of the current workflow.
- Select  to delete a workflow.
- Select **Add Workflow** to create a new workflow.

NOTE

- **You can save up to 10 workflows.**
-

3.9.1.2 Setting the Screen Layout

To set the parameters and their positions to be displayed on the screen, follow this procedure:

1. In the **Workflow Setup** menu, select  on the right of the workflow to be set.
2. Select an area, and then from the popup list select the parameter to be displayed.
 - ◆ You can set up to 3 pages of screens and each page displays up to 4 rows of parameters, corresponding to the parameter areas displayed on the main screen.
 - ◆ Select  to lock or unlock the first parameter of the first page. If locked, a  is displayed and this parameter is displayed as the first parameter of each page.
 - ◆ Select  to change the current row to a two-tile display area. The previously selected parameter will be changed to **Off**.
 - ◆ Select  to change the current row to an undivided display area. The previously selected parameters will be changed to **Off**.

3.9.1.3 Changing Parameter Settings

After setting the screen layout, you can make preferential settings for each parameter on the monitor. To access the **Parameters Setup** menu, in the **Edit Workflow** menu, select **Parameters Setup**.

The settings under the tabs might be different for different departments and work modes. For details, see the table below:

Tab	Menu Item	Description	Work Mode
NIBP	NIBP End Tone	If enabled, a reminder tone is issued at the completion of NIBP measurement.	Both
	Display Format	Selects the type and sequence of displayed NIBP readings.	Both
	Initial Pressure (Neo)	Sets the initial cuff inflation pressure for neonatal patients.	Both
	Measurements	Sets the number of measurement that can be performed in Manual NIBP Measurement. For details, see <i>9.7.1 Performing Manual Measurement</i> .	Spot Check
	Interval	Sets the interval between two auto NIBP measurement.	Continuous Monitoring
	Start Mode	Defines how NIBP auto mode works. For details, see <i>9.8.3 Selecting NIBP Start Mode</i> .	Continuous Monitoring
	Display Alarm Limits	Sets whether to display the alarm limits of diastolic NIBP and mean NIBP.	Continuous Monitoring
	Patient Position	Sets the patient position for NIBP measurement.	Both
	Measurement Site	Sets the measurement site for NIBP measurement.	Both
	Sequence	Sets the duration and interval of NIBP measurement sequences.	Continuous Monitoring
	Orthostatic BP Measurement	Selects whether to enable Orthostatic BP measurement.	Spot Check
	Position	Sets the patient position for Orthostatic BP measurement. Measurements are performed following the sequence of the position setting. Available only when Orthostatic BP Measurement is enabled.	
	Lying Duration/ Sitting Duration	Sets the time before starting lying or sitting BP measurement. Available only when Orthostatic BP Measurement is enabled.	
	Standing BP Measurement Interval/ Sitting BP Measurement Interval	Sets the interval for automatic standing or sitting BP measurement. Available only when Orthostatic BP Measurement is enabled.	
	Maximum Standing BP Measurements/ Maximum Sitting BP Measurements	Sets the number of automatic standing or sitting BP measurement. Available only when Orthostatic BP Measurement is enabled.	

Tab	Menu Item	Description	Work Mode
NIBP	BP Averaging	Selects whether to enable BP averaging. Available only when Department is set to Physician Office .	Spot Check
	Number of Measurements	Sets the number of measurement to be performed in a group of BP measurements for averaging. Available only when Department is set to Physician Office .	
	Discard First Group of Readings	Selects whether to include the first group of readings in the averaging calculation. Available only when Department is set to Physician Office .	
	Delay Before Starting Measurement	Sets the time to wait before starting the first measurement. Available only when Department is set to Physician Office .	
	Time Between Readings	Sets the time to wait before starting the rest automatic BP measurement. Available only when Department is set to Physician Office .	
SpO2	Sensitivity	For Masimo SpO ₂ modules, see 6.6.4 <i>Setting SpO₂ Sensitivity (for Masimo SpO₂)</i> .	Both
	Display PI (for Masimo SpO ₂)	Sets whether to display PI in the SpO ₂ parameter area.	
	Sat-Seconds (for Nellcor SpO ₂)	For Nellcor SpO ₂ modules, see 6.6.2 <i>Nellcor SatSeconds™ Alarm Management</i> .	
	Speed	Sets the sweep speed of Pleth waveforms.	
	Averaging (for Masimo SpO ₂)	For Masimo SpO ₂ modules, see 6.6.7 <i>Changing Averaging Time (for Masimo SpO₂)</i> .	
	Fast SAT (for Masimo SpO ₂)	For Masimo SpO ₂ modules, see 6.6.5 <i>Enabling FastSAT (for Masimo SpO₂)</i> .	
	Display SIQ (for Masimo SpO ₂)	For Masimo SpO ₂ modules, see 6.6.6 <i>Displaying SIQ (for Masimo SpO₂)</i> .	
	NIBP Simul	Switch on for patients performing SpO ₂ and NIBP monitoring on the same limb. The SpO ₂ alarm status is locked until the NIBP measurement ends.	Continuous Monitoring
PR	Pulse Volume	Sets the pulse volume.	Both
	Irr. PR Switch	Selects whether to enable the Irregular PR function. If enabled, you can mark the pulse as regular or irregular on the PR screen.	Spot Check
Temp	Measurement Site (Manual)	Sets the default measurement site for Temp measurement.	Both

Tab	Menu Item	Description	Work Mode
RR	Timer Reminder Interval	Sets the interval of reminder tone for the timer used for manual RR. For details, see <i>10.3 Setting Timer Interval.</i>	Both
	Apnea Delay (Adult)/(Ped)/(Neo)	Sets the delay for giving an Apnea alarm.	Continuous Monitoring
Pain	Default Method	Sets the default pain scale for scoring.	Both
	Pain Score Setup	See <i>16.7.2 Managing the Scoring Tools.</i>	
EWS	Default Adult Score	Sets the default scoring protocol for adult patients.	Spot Check
	Default Ped Score	Sets the default scoring protocol for pediatric patients.	
	Default Neo Score	Sets the default scoring protocol for neonatal patients.	
EWS(Adult)	Score	Sets the default scoring protocol for adult patients.	Continuous Monitoring
	Auto Scoring	Selects the condition to start auto scoring. If none of the options is checked, auto scoring is switched off. For details, see <i>12.1.4 Enabling Auto Scoring.</i>	
	Interval	Sets the auto scoring interval. For details, see <i>12.1.5 Setting Auto Scoring Interval.</i>	
	Auto Refresh Scores	Selects whether to enable the auto refreshing score function. For details, see <i>12.1.6.2 Auto Refreshing Scores.</i>	
	Alarm	Selects whether to enable EWS alarms. For details, see <i>12.1.6 EWS Alarm.</i>	
	EWS Score		
	3 in single parameter		
EWS(Ped)/(Neo)	Score	/	Continuous Monitoring
	Auto Scoring	Selects the condition to start auto scoring. If none of the options is checked, auto scoring is switched off. For details, see <i>12.1.4 Enabling Auto Scoring.</i>	
	Interval	Sets the auto scoring interval. For details, see <i>12.1.5 Setting Auto Scoring Interval.</i>	
Manual Input	/	Selects the parameters and their position to be displayed in the Manual Input list.	Both
	Parameter Library	See <i>16.8.4 Adding a New Manual Parameter.</i>	Both

Tab	Menu Item	Description	Work Mode
Parameter Color	NIBP	White	Both
	SpO2	Blue	Both
	Temp	White	Both
	RR	Yellow	Both

3.9.1.4 Changing Alarm Settings

For workflows under **Continuous Monitoring**, you can enable or disable an alarm, and set the alarm limits and priorities of physiological alarms of each parameter.

Follow this procedure:

1. After setting the screen layout, in the **Edit Workflow** menu, select **Alarm Setup**.
2. Select **Adult**, **Ped**, and **Neo** tabs to set the alarms for adult, pediatric and neonatal patients.

NOTE

- **SpO2 Desat and Apnea alarms cannot be disabled by default.**

3.9.2 Adjusting the Screen Brightness

To adjust the screen brightness, follow this procedure:

1. Select the **Main Menu** quick key → from the **Device** column select **Display**.
2. If you are using the AC power, set **Brightness**. If you are using the battery to run the monitor, set **Brightness On Battery**. You can set the brightness to 1 to 10, in which 10 is the brightest, and 1 is the least bright.

If the monitor operates on battery power, you can set a less bright screen to prolong the operating time of the battery. When the monitor enters **Standby** mode, the screen will change to the least brightness automatically.

3.9.3 Adjusting the Volume

To adjust the volume, follow this procedure:

1. Select the **Main Menu** quick key → from the **Device** column select **Volume**.
2. You can set **Alarm Volume**, **Pulse Volume**, and **Key Volume**. Select +/- to decrease or increase the volume or select  to turn it off.

3.9.4 Changing Measurement Colors

You can set the color of measurement values and waveforms for each parameter. To do so, follow this procedure:

1. Select **Main Menu** quick key → from the **Parameters** column select **Parameter Color**. The **Current** tab is displayed.
2. Set the colors of the currently monitoring measurement values and waveforms.

3.9.5 Setting the Date and Time

To set the system time, follow this procedure:

1. Select the **Main Menu** quick key → from the **System** column select **Time**.
2. Set **Date** and **Time**.
3. Set **Date Format** to **yyyy-mm-dd**, **mm-dd-yyyy**, or **dd-mm-yyyy**, in which:
 - ◆ **yyyy** indicates the year.
 - ◆ **mm** indicates the month.
 - ◆ **dd** indicates the day.
4. If you want to use the 12-hour mode, switch off **24-Hour Time**.
5. If you want to use daylight savings time, switch on **Daylight Savings Time**. You can manually switch on or off the daylight savings time only when the auto daylight savings time function is disabled. For more information, see *16.10.2 Enabling Auto Daylight Savings Time*.

CAUTION

- **Changing the date and time affects the storage of trends and events and may result in loss of data.**

NOTE

- **If your monitor is connected to a central monitoring system (CMS) or hospital clinical system (HIS), the date and time are automatically taken from the CMS. In this case, you cannot change the date and time from your monitor.**

3.9.6 Checking Software Licenses

To run the following functions in your monitor, software licenses are required:

- Orthostatic BP measurement
- Vitalslink
- Network Connectivity
- MLDAP

To check the licenses, select the **Main Menu** quick key → from the **System** column select **License** → **Local**.

To install the licenses, follow this procedure:

1. Connect the USB drive with the licenses in to the monitor’s USB connector.
2. Select the **Main Menu** quick key → from the **System** column select **License** → select **External**.
3. Select **Install**.

3.10 Start Working

3.10.1 Selecting a Work Mode

The monitor provides spot check mode and continuous monitoring mode. It works based on the workflow you selected.

3.10.1.1 Continuous Monitoring Mode

The continuous monitoring mode is used for long-term patient monitoring. To switch to monitoring mode, select the workflow area and select a workflow under **Continuous Monitoring**.

3.10.1.2 Spot Check Mode

The spot check mode is intended for on-spot measurement in a short period. To switch to spot check mode, select the workflow area and select a workflow under **Spot Check**.

In spot check mode, physiological alarm system is disabled.

- There will be no physiological alarm related indications.
- The alarm setup menus will not be displayed.
- Alarm limits cannot be set.

Different features between continuous monitoring mode and spot check mode:

Functions	Continuous Monitoring mode	Spot check mode
Configure and use Sat-Seconds (Nellcor)	Yes	No
Access Alarm Setup tab	Yes	No
Access Events tab	Yes	No
Access Graphic Trends tab	Yes	No
Auto data updating with the central monitoring system	Yes	No
BP Averaging	No	Yes

Functions	Continuous Monitoring mode	Spot check mode
Orthostatic BP measurement	No	Yes

3.10.1.3 Standby Mode

You can temperately stop patient monitoring without switching off the monitor by entering the standby mode. In standby mode, the monitor behaves as follows:

- Stops all parameter measurement.
- Disables all the alarms and prompt messages, except for the battery low alarm.
- Turns screen brightness to the dimmest after entering the standby mode.

You can switch the monitor to standby mode manually, or set **Auto Enter Standby** for the monitor to enter standby mode automatically.

To switch the monitor to standby mode:

1. Press the power switch, or select the **Main Menu** quick key → from the **Patient Management** column select **Standby**.
2. If the monitor is in **Continuous Monitoring** mode, select a location in the drop down list to define where the patient is when the monitor enters the standby mode. If the monitor is in **Spot Check** mode, skip this step.
3. Select **OK**.

To set **Auto Enter Standby**:

1. Select the **Main Menu** quick key → from the **System** column select **Maintenance** → input the required password → select .
2. Select the **Standby** tab, switch on **Auto Enter Standby**, and set the **Auto Enter Standby Time**.

After setting, the monitor enters standby mode automatically if no operation is detected after the **Auto Enter Standby Time**.

WARNING

- **Pay attention to the potential risk of placing the monitor to standby. In the standby mode, the monitor stops all parameter measurement and disable all the alarm indications, except for the battery low alarm.**
-
-

If the monitor enters standby mode in **Continuous Monitoring** mode, you can:

- Change the patient location from the standby screen.
- Select **Discharge Patient** on the standby screen to discharge a patient.
- Select **Resume monitor** on the standby screen to exit the standby mode.

If the monitor enters standby mode in **Spot Check** mode, you can select anywhere on the touchscreen to exit the standby mode.

3.10.2 Inputting Patient Information

It is recommended to input the patient information correctly before monitoring. Follow this procedure:

1. Select patient information area and the Patient Management menu is displayed.
2. Input the **Patient ID**, name, date of birth, **Patient Category**, and **Gender**.
3. Select **OK**.

3.10.3 Accessing Parameter Setup Menus

Each parameter has a setup menu in which you can adjust the alarm and parameter settings. You can enter a parameter setup menu by using the following methods:

- In **Continuous Monitoring** mode, select the parameter area to display a parameter setup menu.
- In **Spot Check** mode, select the **Main Menu** quick key → from the **Parameters** column select **Setup** → select the desired parameter.

3.10.4 Checking the Alarm Settings

For patients under continuous monitoring, make sure the alarm limits are appropriate for the currently admitted patient. To check the alarm limits, in **Continuous Monitoring** mode, select the **Main Menu** quick key → from the **Alarm** column select **Limits**. Change them if necessary.

3.11 Connecting the CMS

You can connect the monitor to the BeneVision CMS through wired LAN or wireless LAN. When connected to the CMS, the system provides the following function.

- The monitor can transmit parameter values, waveforms, alarm settings (if the monitor is working in **Continuous Monitoring** mode), and events to the CMS. From the CMS, you can check the patient's data and alarms (if any).
- When the monitor is working in **Continuous Monitoring** mode, patient information, alarm settings, and alarm status can be synchronized between the monitor and the CMS.
- You can start or stop NIBP measurement from the CMS.
- In case of network disconnection, the monitor can transmit the offline data to the CMS when network is reconnected.

For more information on the CMS, see the operator's manual of corresponding central monitoring system.

To select a CMS, select the system status information area at the top right corner of the main screen. Select the desired CMS from the popup CMS list.

NOTE

- **You can select CMS only when the Select CMS switch is on. For more information, see 16.15.7 Enabling Selecting a CMS.**
-

3.12 Connecting the eGateway

You can connect the monitor to the eGateway through wired LAN or wireless LAN to implement interaction between the monitor and external devices. When connected to the eGateway, the system provides the following functions:

- The monitor can transmit parameter values, waveforms, alarm settings (if the monitor is working in **Continuous Monitoring** mode), and events to the eGateway.
- Clock can be synchronized between the monitor and the eGateway.

3.13 Connecting the Wireless Network

You can add up to five wireless networks for the monitor. For more information, see 16.15.5 *Setting the Wireless Network*.

If connecting the current wireless network fails, the monitor automatically connects other wireless networks in the order when they were added.

To manually switch the wireless network, from the system status information area on the top right corner of the screen select , and select the desired wireless network.

3.14 Stopping a Parameter Measurement

To stop monitoring a parameter, follow this procedure:

1. Remove corresponding sensors from the patient.
2. Disconnect the sensor from the patient cable.
3. Disconnect the patient cable from the parameter connector.
4. If you are using the disposable sensor, discard it.

3.15 Turning Off the Monitor

Before turn off the monitor, perform the following check:

1. Ensure that the monitoring of the patient has been completed.
2. Disconnect the cables and sensors from the patient.
3. Save or clear the patient data as required.

To turn off the monitor, press and hold the power switch for 3 seconds.

CAUTION

- **Press and hold the power switch for 10 seconds to forcibly shut down the monitor if it could not be shut down normally. This may cause loss of patient data.**
-

NOTE

- **Turning off the monitor does not disconnect the monitor from the AC mains. To completely disconnect the power supply, unplug the power cord.**
 - **If a monitor is on during a power loss, then the monitor is automatically switched on when the power is restored.**
 - **In case of a temporary power failure, if the power is restored within 30 minutes, monitoring will resume with all active settings unchanged. If the monitor is without power for more than 30 minutes, it behaves the same as if it were normally turned off.**
-

This page intentionally left blank.

4 Managing Patients

The monitor provides patient management functions. On the monitor, you can admit and discharge a patient, and edit, review, import, and export patient information.

4.1 Admitting a Patient

4.1.1 Automatically Admitting a Patient

The monitor admits a new patient automatically when started for the first time or after a patient is discharged. For automatically admitted patient, you need to input and save the patient information so the measurements and other physiological data could be correctly saved to the patient.

Always inputs patient information as soon as the patient is admitted. For more information, see *4.2.2 Editing Patient Information* for details.

WARNING

- **The setting of patient category always contain a default value, regardless of whether the patient is admitted or not. Check if the setting is correct for your patient.**
-
-

4.1.2 Manually Admitting a Patient

You can admit a patient from **ADT Database** (if available) and **Local Patient List**. You can also admit a new patient. Follow this procedure:

1. Select **Patient** quick key.
 2. Select a patient from the list and then select **Admit** to admit a patient. Or, select **Add New** to admit a new patient.
 3. Check or modify the information of the patient. Select **OK**.
-
-

WARNING

- **Before admitting a patient, make sure the data for the current patient is properly edited and saved. Failure to do so can lead to data being attributed to the wrong patient.**
-
-

4.2 Managing Patient Information

4.2.1 Entering the Patient Management Menu

Use any of the following methods to enter the **Patient Management** menu:

- Select the patient information area at the top left corner of the screen.
- Select the **Main Menu** quick key → from the **Patient Management** column select **Patient Management**.

4.2.2 Editing Patient Information

Edit patient information after a patient has been admitted, or when patient information is incomplete, or when you want to change patient information.

To edit patient information, follow this procedure:

1. Enter the **Patient Management** menu. For more information, see *4.2.1 Entering the Patient Management Menu*.
2. Edit patient information as required.

If you connect a barcode reader with your monitor, you can scan the patient's barcode to enter the patient's information.

Input the **Patient ID** or **Visit Number** of a patient, other information will automatically fill in if the patient is in the **Local Patient List** or **ADT Database** (if the monitor is connected with the Admit-Discharge-Transfer (ADT) server through the eGateway).

NOTE

- **The monitor will reload the configuration if you changed the patient category.**
-

4.2.3 Saving Patient Data from ADT Database to Local Patient List

If the monitor is connected with the Admit-Discharge-Transfer (ADT) server through the eGateway, you can save the patient data on the server to the local patient list. To do so, follow this procedure:

1. Select **Patient** quick key and access the **ADT Database** tab.
2. Input the **Patient ID**, **Last Name** or **First Name** and then select **Search** to search for a patient.
3. Select **Select Patient** and check the patients to be saved.
4. Select **Save To Local** to save the selected patient data.

NOTE

- **Earlier patient data will be overwritten by the saved data if the capacity is reached.**
-

4.3 Discharging a Patient

The monitor discharges a patient in the following situations:

- After a patient is manually admitted, the previous patient is automatically discharged.
- In **Spot Check** mode, a patient is discharged if the monitor is powered off or workflow is switched.
- For patients under **Continuous Monitoring** mode, you can let the monitor automatically discharge a patient after the monitor has been switched off for a period of time. The configuration of this function is password protected. For more information, see *16.2.3 Auto Discharging a Patient after Monitor Power Off*.
- If the monitor has not detected certain patient vital signs (SpO₂, PR, RR, NIBP) for 30 minutes, you will be prompted whether to start monitoring a new patient if any of the above vital signs are detected again.

When a patient is discharged, all patient data, including patient information, trend data, and physiological alarm information is deleted from the monitor. The technical alarms is reset, and monitor settings returns to their defaults.

NOTE

- **Discharging a patient deletes all history data from the monitor.**
-

4.3.1 Manually Discharging a Patient

Patients under **Continuous Monitoring** mode can be discharged manually. Follow this procedure:

1. Make sure all the patient data needed is properly saved.
2. Select the patient information area at the top left corner of the screen.
3. Select **Discharge Patient**.

4.4 Deleting Patient Data

To delete the data of discharged patients, follow this procedure:

1. Select the **Patient** quick key.
2. Select **Select Patient**. From the patient list select desired patients.
3. Select **Delete**.

This page intentionally left blank.

5 Alarms

5.1 Alarm Introduction

This chapter describes alarm functions and alarm settings.

5.2 Alarm Safety Information

WARNING

- **A potential hazard can exist if different alarm presets and default configuration settings are used for the same or similar equipment in the same care area, for example an intensive care unit or cardiac operating room.**
 - **If the monitor is connected to the central monitoring system (CMS), alarms can be presented and controlled remotely. Remote suspension, inhibition, or reset of monitor alarms via the CMS may cause a potential hazard. For more information, see the operator's manuals for the CMS.**
 - **The monitors in the care area may each have different alarm settings to suit different patients. Always check that the alarm settings are appropriate for the patient before start monitoring. Always make sure that necessary alarm limits are active and set according to the patient's clinical condition.**
 - **Setting alarm limits to extreme values may cause the alarm system to become ineffective. For example, setting the SpO₂ high alarm limit to 100% is equivalent to switching the alarm off.**
 - **When the alarm sound is switched off, the monitor gives no alarm tones even if a new alarm occurs. Be careful about when considering to switch off the alarm sound. When the alarms are off or while alarm audio is paused either temporarily or indefinitely, observe the patient frequently.**
 - **When monitoring patients that are not continuously attended by a clinical operator, properly configure the alarm system and adjust alarm settings as per the patient's condition.**
 - **Do not rely exclusively on the audible alarm system for monitoring. Adjustment of alarm volume to a low level may result in a hazard to the patient.**
-

5.3 Understanding the Alarms

5.3.1 Alarm Categories

The monitor has two different types of alarms: physiological alarms and technical alarms.

- Physiological alarms are triggered by patient measurement exceeding the parameter limits, or by an abnormal patient conditions. Physiological alarms are available only when the monitor is in **Continuous Monitoring** mode.
- Technical alarms are triggered by an electrical, mechanical, or other monitor failure, or by failure of a sensors or components. Technical alarm conditions may also be caused when an algorithm cannot classify or interpret the available data.

Apart from the physiological and technical alarms, the monitor can also prompt some messages describing the system status or patient status.

5.3.2 Alarm Priorities

By severity, the alarms are classified into the following priority levels:

- High priority alarms: indicate a life threatening situation or a severe device malfunction. High priority alarms require an immediate response.
- Medium priority alarms: indicate abnormal vital signs or a device malfunction. Medium priority alarms require a prompt response.
- Low priority alarms: indicate a discomfort condition, a device malfunction, or an improper operation. Low priority alarms require you to be aware of this condition.
- Messages: provide additional information on the patient or the equipment.

5.3.3 Alarm Indicators

When an alarm occurs, the monitor indicates it through visual or audible alarm indications. For more information, see the following table.

Alarm Indicator		High Priority Alarm	Medium Priority Alarm	Low Priority Alarm	Message
Alarm lamp		Red Flashing frequency: 1.4 - 2.8 Hz Duty cycle: 20 - 60% on	Yellow Flashing frequency: 0.4 - 0.8 Hz Duty cycle: 20 - 60% on	Cyan No flashing Duty cycle: 100% on	None
Audible tone pattern	ISO	Repeat pattern of triple + double + triple + double beeps	Repeat pattern of triple beeps	Single beep	None

Alarm Indicator	High Priority Alarm	Medium Priority Alarm	Low Priority Alarm	Message
Alarm message ¹	White text inside a red box	Black text inside a yellow box	Black text inside a cyan box	White text
Alarm priority indicator ²	!!!	!!!	!	None
Parameter value	White text inside a flashing red box	Black text inside a flashing yellow box	Black text inside a flashing cyan box	None

¹: Alarm messages are displayed in the alarm information area at the top of the screen. You can select the alarm messages to show the alarm list.

²: The indicator appears in front of the corresponding alarm message.

NOTE

- **When multiple alarms of different priority levels occur simultaneously, the monitor selects the highest priority alarm to light the alarm lamp and issue the alarm tone.**
- **When multiple alarms of different priority levels occur simultaneously and should be displayed in the same area, the monitor only displays the messages from the highest priority alarm.**
- **When multiple alarms of the same priority levels occur simultaneously alarm messages are displayed circularly.**
- **Some physiological alarms, such as Apnea, are exclusive. They have identical alarm tones and alarm lights with normal high level physiological alarms, but their alarm messages are displayed exclusively. That is, when an exclusive physiological alarm and a normal high level physiological alarm are triggered simultaneously, only exclusive physiological alarm message will be displayed.**

5.3.4 Alarm Status Symbols

Apart from the alarm indicators as described in 5.3.3 *Alarm Indicators*, the monitor uses the following symbols to indicate the alarm status:



Alarm pause: indicates that all the alarms are paused.



Alarm off: indicates that individual measurement alarms are turned off or the system is in the alarm off status.



Audio pause: indicates that audible alarm tones are paused.



Audio off: indicates that audible alarm tones are turned off.



Alarm reset: indicates that the alarm system is reset.

5.4 Checking Alarm List

To check the alarm list, follow this procedure:

1. Select the technical alarm area to check the **Technical Alarms**.
2. Select the physiological alarm area to check the **Physiological Alarms**.

5.5 Accessing On-screen Help for Technical Alarms (AlarmSight)

In the technical alarm list, alarm messages followed by **Detail** include help messages or pictures to help you identify the problem. This function is called AlarmSight. To access AlarmSight, follow this procedure:

1. Select the technical alarm area to check the **Technical Alarms** list.
2. From the alarm list select **Detail** on the right of the desired alarm.

NOTE

- **If there are no displayed alarms, selecting the technical alarm area will not open any dialogs.**
-

5.6 Changing Alarm Settings

From the **Alarm** column of the main menu, select desired buttons to set alarm properties.

5.6.1 Setting Parameter Alarm Properties (Continuous Monitoring Mode)

For workflows under **Continuous Monitoring**, you can set the alarm properties of physiological alarms of each parameter. Every time you switch to a workflow, the alarm settings of the workflow are loaded. For details, see 3.9.1.4 *Changing Alarm Settings*.

You can also change the parameter alarm properties based on the condition of the current patient. To do so, follow this procedure:

1. Select the **Main Menu** quick key → from the **Alarm** column select **Limits**. Enter the password if required.
2. Select a parameter tab and set alarm properties as desired.

You can also change the alarm properties of individual parameter from corresponding parameter menu.

The alarm settings of workflow override the alarm settings under **Limits** menu and parameter menus. Every time you discharge a patient or switch to another workflow, the workflow settings are loaded.

NOTE

- **The monitor can be configured to require a password or login to change alarm settings. For more information, refer to 16.3.3 Selecting Password for Changing Alarm settings.**
-

5.6.2 Guard Limit

The monitor provide guard limits for HR/PR, SpO₂, RR, NIBP, Temp, and CO₂ to prevent alarm limits from being set too high or too low. Setting guard limits is password protected.

For more information on setting guard limits, see 16.5.4 *Setting Guard Limits*.

5.6.3 Changing the Alarm Volume

To change the alarm volume, follow this procedure:

1. Select the **Main Menu** quick key → from the **Alarm** column select **Setup**.
2. Set **Alarm Volume**. The alarm volume can be set from X to 10, in which X is the minimum volume allowed by your apartment, and 10 is the maximum volume.
3. Select **High Alarm Volume** to set the volume of the high priority alarm.
4. Select **Reminder Volume** to set the volume of the reminder tone.

NOTE

- **When the alarm volume is set to 0, the alarm sound is turned off and the audio off symbol appears on the screen.**
 - **You cannot set the volume of high priority alarms if Alarm Volume is set to 0.**
-

5.6.4 Setting the Apnea Delay Time

To set the apnea delay time, follow this procedure:

1. Select the **Main Menu** quick key → from the **Alarm** column select **Setup**.
2. Select **Apnea Delay** to set the apnea delay time.

5.6.5 Restoring the Default Alarm Settings

To reset all alarm settings to the defaults, follow this procedure:

1. Select the **Main Menu** quick key → from the **Alarm** column select **Setup**.
2. Select the **Limits** tab.
3. On the **Limits** page, select **Defaults** at the bottom.

5.7 Pausing Alarms/Pausing Alarm Tones

You can either pause alarms or pause alarm tones. This depends on the pause setting. To set the pause function, refer to *16.5.2.1 Defining the Pause Function*.

5.7.1 Pausing Alarms

If the pause function is configured to **Alarm Pause**, pressing the **Alarm Pause** quick key can temporarily disable alarm indicators. For the configuration of the pause function, see *16.5.2.1 Defining the Pause Function*. When alarms are paused, the following rules are followed:

- No physiological alarm will be presented.
- Except battery-related technical alarms, sounds of other technical alarms are paused, but alarm lamps and alarm messages continue to be presented.
- The remaining alarm pause time is displayed in the physiological alarm information area.
- The alarm pause symbol is displayed in the system information area.

When the alarm pause time expires, the alarm paused state is automatically deactivated. You can also cancel the alarm paused state by pressing the **Alarm Pause** quick key again.

5.7.1.1 Prolonging the Alarm Pause Time

If enabled, you can temporarily prolong the alarm pause time after the monitor enters the alarm paused state. This capability is disabled by default. To prolong the alarm pause time, follow this procedure:

1. In the physiological alarm information area, select the alarm pause countdown.
2. Select **Pause 5 min**, **Pause 10 min**, or **Pause 15 min**.

NOTE

-
- **Prolonging alarm pause time does not affect the setting of alarm pause time.**
-

5.7.1.2 Switching Off All Alarms

If **Pause Time** is set to **Permanent** (see 16.5.2.2 *Setting the Alarm Pause Time/Alarm Tone Pause Time*), pressing the **Alarm Pause** quick key permanently switches off all alarms. The alarm off state has the following features:

- Physiological alarms are switched off. The alarm lamp does not flash and alarm sound is not issued.
- Alarm sound of technical alarms is switched off, but alarm lamp flashes and alarm messages are presented.
- The message **Alarm Off** with red background is displayed in the physiological alarm information area.
- The alarm off symbol is displayed in the system status information area.

To exit the alarm off state, press the **Alarm Pause** quick key again.

WARNING

- **Pausing or switching off alarms may result in a hazard to the patient.**
-
-

5.7.2 Pausing Alarm Sound

If the pause function is configured to **Audio Pause**, pressing the **Audio Pause** key pauses alarm tone. For the configuration of the pause function, see 16.5.2.1 *Defining the Pause Function*. When alarm tones are paused, the following rules are followed:

- The sound of all physiological alarms and technical alarms are switched off.
- The remaining audio pause time is displayed in the physiological alarm information area.
- The audio pause symbol is displayed in the system information area.

When the audio pause time expires, the audio paused status is automatically deactivated. You can also cancel the audio paused status by pressing the **Alarm Pause** quick key.

5.7.2.1 Prolonging the Alarm Tone Pause Time

If enabled, you can temporarily prolong the alarm tone pause time after the monitor enters the alarm tone paused state. This capability is disabled by default. To prolong the alarm pause time, follow this procedure:

1. In the physiological alarm information area, select the alarm pause countdown.
2. Select the alarm tone pause time. Options may include **Pause 5 min**, **Pause 10 min**, or **Pause 15 min**.

NOTE

- **Prolonging alarm pause time does not affect the setting of alarm tone pause time.**
-

5.7.2.2 Switching Off Alarm Sound

If **Pause Time** is set to **Permanent** (see 16.5.2.2 *Setting the Alarm Pause Time/Alarm Tone Pause Time*), pressing the **Audio Pause** quick key permanently switches off all alarm sound. The audio off state has the following features:

- Alarm sound of both physiological alarms and technical alarms is switched off.
- The audio off symbol is displayed in the system information area.
- The **Audio Off** message is displayed in the physiological alarm information area with a red background.

To exit the audio off status, press the **Alarm Pause** quick key again.

WARNING

- **Pausing or switching off alarm sound may result in a hazard to the patient.**
-
-

5.8 Resetting Alarms

Press the **Alarm Reset** quick key to reset the alarm system. When the alarm system is reset, the alarm reset symbol displays in the system status information area for alarm symbols.

NOTE

- **If a new alarm is triggered after the alarm system is reset, the alarm reset icon will disappear and the alarm light and alarm tone will be reactivated.**
-

5.8.1 Resetting Physiological Alarms

For physiological alarms, when the alarm system is reset, the following occur:

- The alarm sound is silenced.
- A ✓ appears before the alarm message.
- The color of the parameter numeric background corresponds with the alarm priority, but the parameter numeric does not flash.

5.8.2 Resetting Technical Alarms

For technical alarms, when the alarm system is reset, the following occur:

- Some technical alarms are cleared. The monitor gives no alarm indications.
- Some technical alarms are changed to the prompt messages.
- For some technical alarms, the alarm is silenced and a ✓ appears before the alarm message.

For details about the indications of technical alarms when the alarm system is reset, see *D.2 Technical Alarm Messages*.

5.9 Latching Alarms

The latching setting for physiological alarms defines how alarm indicators behave if you do not reset the alarms.

- If you do not “latch” physiological alarms, their alarm indications disappear when the alarm condition ends.
- If you “latch” physiological alarms, all visual and audible alarm indications remain (if configured) until the alarms are reset. For latched alarms the time when the alarm is last triggered is displayed behind the alarm message.

The monitor can be set to separately latch visual indications or simultaneously latch the visual and the audible indications.

- When visual indications are latched, visual indications, including alarm lamp, alarm message and its background remain when the alarm condition ends and the time when the alarm last triggered is displayed behind the alarm message.
- When audible indications are latched, the monitor continues to issue alarm sounds when the alarm condition ends.

To set how you want to latch the physiological alarms, see section *16.5.3 Latching Physiological Alarms*.

NOTE

- **Changing alarm priority may affect the latching status of the corresponding alarm. Determine if you need to adjust the latching status for the specific alarm when you have changed its alarm priority.**
 - **When the alarm system is reset, latched physiological alarms are cleared.**
-

5.10 Nurse Call

The monitor provides a nurse call connector to output a nurse call signal when a user-defined alarm occurs. To obtain a nurse call signal, use the nurse call cable to connect the hospital nurse call system with the monitor’s nurse call connector.

Alarms are indicated on the nurse call device only when the following conditions are met:

- The nurse call system is enabled.

- A user-defined alarm occurs.
- Alarms are not paused or reset.

WARNING

- **Do not rely exclusively on the nurse call system for alarm notification. Remember that the most reliable alarm notification combines audible and visual alarm indications with the patient's clinical condition.**
-
-

5.11 Testing Alarms

The monitor automatically performs a selftest at startup. Check that an alarm tone is heard, and the alarm lamp illuminates, one after the other, in red, yellow, and cyan. This indicates that the visible and alarm indicators function correctly.

To further test individual measurement alarms, perform measurement on yourself or using a simulator. Adjust alarm limits and check that appropriate alarm behavior is observed.

6 Monitoring Pulse Oxygen Saturation (SpO₂)

6.1 SpO₂ Introduction

Pulse Oxygen Saturation (SpO₂) monitoring is a non-invasive technique used to measure the amount of oxygenated hemoglobin and pulse rate by measuring the absorption of selected wavelengths of light. The light generated in the emitter side of the probe is partly absorbed when it passes through the monitored tissue. The amount of transmitted light is detected in the detector side of the probe. When the pulsative part of the light signal is examined, the amount of light absorbed by the hemoglobin is measured and the pulse oxygen saturation can be calculated. This device is calibrated to display functional oxygen saturation.

SpO₂ monitoring is intended for adult, pediatric and neonatal patients.

The monitor can be configured with the following SpO₂ modules:

- Masimo SpO₂: the connector is purple and the logo of Masimo SET is on the monitor.
- Nellcor SpO₂: the connector is grey and the logo of Nellcor is on the monitor.

NOTE

- **The SpO₂ extension cable used must be compatible with the SpO₂ sensor connectors used. For example, only the Mindray SpO₂ extension cable can be connected to the Mindray SpO₂ sensor connectors.**
 - **Measurement accuracy verification: The SpO₂ accuracy has been verified in human experiments by comparing with arterial blood sample reference measured with a CO-oximeter. Pulse oximeter measurement are statistically distributed and about two-thirds of the measurements are expected to come within the specified accuracy range compared to CO-oximeter measurements.**
 - **A functional tester or SpO₂ simulator can be used to determine the pulse rate accuracy.**
 - **A functional tester or SpO₂ simulator cannot be used to assess the SpO₂ accuracy.**
-

6.2 SpO₂ Safety Information

WARNING

- When a trend toward patient deoxygenation is indicated, analyze the blood samples with a laboratory co-oximeter to completely understand the patient's condition.
 - Do not use SpO₂ sensors during magnetic resonance imaging (MRI). Induced current could potentially cause burns. The sensor may affect the MRI image, and the MRI unit may affect the accuracy of the oximetry measurements.
 - Prolonged continuous monitoring may increase the risk of undesirable changes in skin characteristics, such as irritation, reddening, blistering or burns. Inspect the sensor site every two hours and move the sensor if the skin quality changes. Change the application site every four hours. For neonates, or patients with poor peripheral blood circulation or sensitive skin, inspect the sensor site more frequently.
 - If the sensor is too tight because the application site is too large or becomes too large due to edema, excessive pressure for prolonged periods may result in venous congestion distal from the application site, leading to interstitial edema and tissue ischemia.
 - When patients are undergoing photodynamic therapy they may be sensitive to light sources. Pulse oximetry may be used only under careful clinical supervision for short time periods to minimize interference with photodynamic therapy.
 - Setting alarm limits to extreme values may cause the alarm system to become ineffective. For example, high oxygen levels may predispose a premature infant to retrolental fibroplasia. If this is a consideration, do not set the high alarm limit to 100%, which is equivalent to switching off the alarm.
 - SpO₂ is empirically calibrated in healthy adult volunteers with normal levels of carboxyhemoglobin (COHb) and methemoglobin (MetHb).
 - To protect from electric shock, always remove the sensor before bathing the patient.
 - The pulse oximetry function of the bedside monitor should not be used for apnea monitoring.
 - The pulse oximetry function of the bedside monitor should not be used for arrhythmia analysis.
-
-

CAUTION

- **Change the application site or replace the sensor and/or patient cable when a persistent SpO₂ Low Signal Quality message is displayed on the equipment. These messages may indicate that patient monitoring time is exhausted on the patient cable or sensor.**
- **Replace the cable or sensor when a “SpO₂ Sensor Off”, “SpO₂ No Sensor”, or “SpO₂ Low Signal Quality” message is consistently displayed while monitoring consecutive patients after completing troubleshooting steps listed in this manual.**
- **Variation in measurements may be profound and may be affected by sampling technique as well as the patient’s physiological conditions. Any results exhibiting inconsistency with the patient’s clinical status should be repeated and/or supplemented with additional test data. Blood samples should be analyzed by laboratory instruments prior to clinical decision making to completely understand the patient’s condition.**
- **Use only SpO₂ sensors specified in this manual. Follow the SpO₂ sensor’s instructions for use and adhere to all warnings and cautions.**
- **Do not place the monitor where the controls can be changed by the patient.**
- **If using patient monitor during full body irradiation, keep the sensor out of the radiation field. If the sensor is exposed to the radiation, the reading might be inaccurate or the device might read zero for the duration of the active irradiation period.**

NOTE

- **Additional information specific to the Masimo sensors compatible with the equipment, including information about parameter/measurement performance during motion and low perfusion, may be found in the sensor’s directions for use (DFU).**
 - **Masimo cables and sensors are provided with X-Cal™ technology to minimize the risk of inaccurate readings and unanticipated loss of patient monitoring. Refer to the Cable or Sensor DFU for the specified duration of the patient monitoring time.**
-

6.3 SpO₂ Measurement Limitations

The following factors may influence the accuracy of SpO₂ measurement:

- Patient physiological characteristics:
 - ◆ Cardiac arrest
 - ◆ Hypotension

- ◆ Darkly pigmented skin
- ◆ Shock
- ◆ Severe vasoconstriction
- ◆ Hypothermia
- ◆ Severe anemia
- ◆ Ventricular septal defects (VSDs)
- ◆ Venous pulsations
- ◆ Poor perfusion
- ◆ Dysfunctional hemoglobin, such as carboxyhemoglobin (COHb) and methemoglobin (MetHb)
- ◆ Elevated levels of bilirubin
- ◆ Vasospastic disease, such as Raynaud's, and peripheral vascular disease
- ◆ Hemoglobinopathies and synthesis disorders such as thalassemias, Hb s, Hb c, sickle cell, etc.
- ◆ Hypocapnic or hypercapnic conditions
- ◆ Birthmark(s), tattoos, skin discolorations, moisture on skin, deformed or abnormal fingers. etc.
- Interfering substances:
 - ◆ Intravascular dyes (such as indocyanine green, methylene blue, indigo carmine, etc.)
 - ◆ Dyes in the measure site, such as nail polish
- Environmental conditions:
 - ◆ Excessive ambient light
 - ◆ Electrosurgery equipment
 - ◆ Defibrillation (may cause inaccurate reading for a short amount of time)
 - ◆ Excessive patient/sensor motion
 - ◆ Electromagnetic field
 - ◆ Arterial catheters and intra-aortic balloon
- Others
 - ◆ Inappropriate positioning of the SpO₂ sensor, or use of incorrect SpO₂ sensor
 - ◆ Cuff or arterial blood pressure measurement device on the same limb as the SpO₂ sensor

6.4 SpO₂ Display

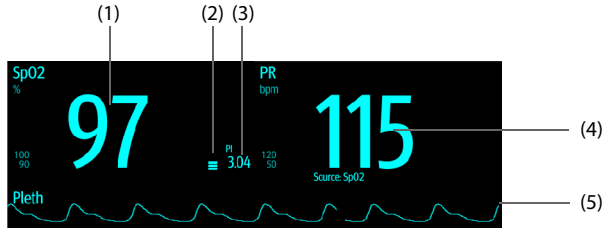

- (1) Oxygen saturation of arterial blood (SpO₂): percentage of oxygenated hemoglobin in relation to the sum of oxyhemoglobin and deoxyhemoglobin.
- (2) Perfusion indicator: the pulsatile portion of the measured signal caused by arterial pulsation.
- (3) Perfusion index (PI): gives the numerical value for the pulsatile portion of the measured signal caused by arterial pulsation. PI is an indicator of the pulsatile strength. You can also use it to assess the SpO₂ signal strength.
- (4) Pulse rate (derived from the pleth wave): detected pulsations per minute.
- (5) Pleth waveform (Pleth): visual indication of patient's pulse. The waveform is not normalized.

NOTE

- **PI is displayed for Masimo SpO₂.**

6.5 Preparing for SpO₂ Monitoring

To prepare to monitor SpO₂, follow this procedure:

1. Select an appropriate sensor according to the module type, patient category, weight, and measurement site.
2. Clean the contact surface of the reusable sensor.
3. Remove colored nail polish from the application site.
4. Apply the sensor to the patient according to the instruction for use of the sensor.
5. Select an appropriate extension cable according to the connector type and plug the cable into the SpO₂ connector.
6. Connect the sensor to the extension cable.

CAUTION

- Do not apply sensor too tightly as this results in venous pulsation which may severely obstruct circulation and lead to inaccurate measurements.
 - At elevated ambient temperatures, be careful with measurement sites that are not well perfused, because this can cause burns after prolonged application.
 - Avoid placing the sensor on extremities with an arterial catheter, an NBP cuff or an intravascular venous infusion line.
 - For neonatal patients, make sure that all sensor connectors and adapter cable connectors are outside the incubator. The humid atmosphere inside can cause inaccurate measurements.
-

6.6 Changing the SpO₂ Settings

NOTE

- Alarm related settings are available only when the monitoring is in Continuous Monitoring mode.
-

6.6.1 Changing the SpO₂ Alarm Settings

In **Continuous Monitoring** mode, you can change the SpO₂ alarm settings. Follow this procedure:

1. Select the SpO₂ numeric area or waveform area to enter the **SpO2** dialog.
2. Select the **Alarm** tab.
3. Enter the password if required. For more information, refer to *16.3.3 Selecting Password for Changing Alarm settings*.
4. Set the alarm properties as desired.

NOTE

- The **desat alarm** is a high level alarm notifying you of potentially life threatening drops in oxygen saturation. When the SpO₂ value is below the desat alarm limit and desat alarm switch is set on, the message "SpO2 Desat" is displayed.
 - You can switch off the SpO₂ Desat alarm only when SPO2 Desat Alarm Off is enabled. For more information, see section *16.5.6.4 Setting the Switch of the SpO₂ Desat Alarm Off*.
-

6.6.2 Nellcor SatSeconds™ Alarm Management

With traditional alarm management, high and low alarm limits are set for monitoring oxygen saturation. During monitoring, once an alarm limit is violated, an audible alarm immediately sounds. When the patient SpO₂ fluctuates near an alarm limit, the alarm sounds each time the limit is violated. Such frequent alarms can be distracting. Nellcor's SatSeconds alarm management technique is used to reduce these nuisance alarms.

The SatSeconds feature is available with the Nellcor SpO₂ to decrease the likelihood of false alarms caused by motion artifacts. With SatSeconds alarm management, high and low alarm limits are set in the same way as those with traditional alarm management. A SatSeconds limit is also set. The SatSeconds limit controls the amount of time that SpO₂ saturation may be outside the set limits before an alarm sounds.

The method of calculation is as follows: the percentage points of the SpO₂ saturation falling outside the alarm limit is multiplied by the number of seconds remaining outside the limit. This can be stated as the equation:

$$\text{SatSeconds} = \text{Points} \times \text{Seconds}$$

Only when the SatSeconds limit is reached, the monitor gives a SatSeconds alarm. For example, the figure below demonstrates the alarm response time with a SatSeconds limit set at 50 and a low SpO₂ limit set at 90%. In this example, the patient SpO₂ drops to 88% (2 points) and remains there for 2 seconds. Then it drops to 86% (4 points) for 3 seconds, and then to 84% (6 points) for 6 seconds. The resulting SatSeconds are:

% SpO ₂	Seconds	SatSeconds
2×	2=	4
4×	3=	12
6×	6=	36
Total SatSeconds=		52

After approximately 11 seconds, a Sat-Second alarm would sound, because the limit of 50 SatSeconds would have been exceeded.

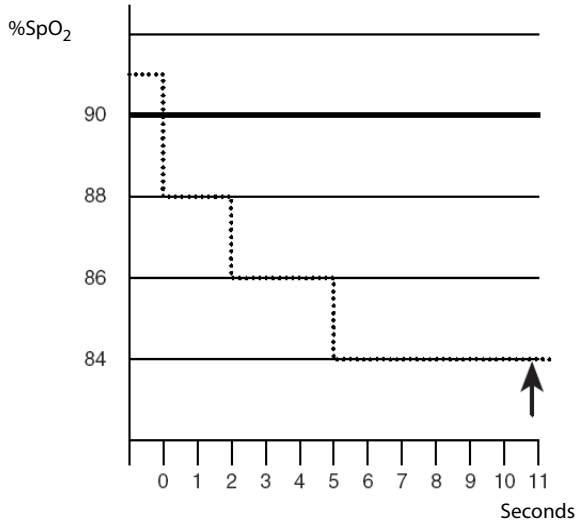

Saturation levels may fluctuate rather than remaining steady for a period of several seconds. Often, the patient SpO₂ may fluctuate above and below an alarm limit, re-entering the non-alarm range several times. During such fluctuation, the monitor integrates the number of SpO₂ points, both positive and negative, until either the SatSeconds limit is reached, or the patient SpO₂ re-enters the non-alarm range and remains there.

NOTE

- **The SpO₂ Too Low or SpO₂ Too High alarm is presented in the case that SpO₂ value violates the alarm limits 3 times within one minute even if the setting of SatSeconds is not reached.**

6.6.3 Setting the Nellcor SpO₂ SatSeconds

In **Continuous Monitoring** mode, you can set the SatSeconds. Follow this procedure:

1. Select the SpO₂ numeric area or waveform area to enter the **SpO₂** dialog.
2. Select the **Alarm** tab.
3. Set **Sat-Seconds**.

6.6.4 Setting SpO₂ Sensitivity (for Masimo SpO₂)

For Masimo SpO₂, select the **Sensitivity** as per signal quality and patient motion.

Normal sensitivity is the recommended for patients who are experiencing some compromise in blood flow or perfusion. It is advisable for care areas where patients are observed frequently, such as the intensive care unit (ICU).

Adaptive Probe Off Detection (APOD) sensitivity is the recommended sensitivity mode where there is a high probability of the sensor becoming detached. It is also the suggested mode for care areas where patients are not visually monitored continuously. This mode delivers enhanced protection against erroneous pulse rate and arterial oxygen saturation readings when a sensor becomes inadvertently detached from a patient due to excessive movement.

Maximum sensitivity is recommended for use on patients with weak signals (e.g. high ambient noise and/or patients with very low perfusion) and for use during procedures or when clinician and patient contact is continuous such as in higher acuity settings.

To set SpO₂ sensitivity, follow this procedure:

1. In **Continuous Monitoring** mode, select the SpO₂ numeric area or waveform area to enter the **SpO2** dialog. In **Spot Check** mode, select the **Main Menu** quick key → from the **Parameters** column select **Setup** → select **SpO2**.
2. Select the **Setup** tab.
3. Set **Sensitivity** to **Maximum, Normal, or APOD**.

CAUTION

- **When using the Maximum Sensitivity setting, performance of "Sensor Off" detection may be compromised. If the equipment and the sensor becomes detached from the patient, the potential for false readings may occur due to environmental noise such as light, and vibration.**
 - **Configuring the monitor to "Load Latest Configuration" as the default configuration may result in Masimo SpO2 being set to Maximum sensitivity mode on power up or after admitting a new patient. Maximum sensitivity is recommended for use during procedures or when clinician and patient contact is continuous, such as in higher acuity settings. Maximum sensitivity is not recommended for care areas where patients are not monitored visually as "Sensor Off" detection may be compromised.**
-

6.6.5 Enabling FastSAT (for Masimo SpO₂)

FastSAT enables rapid tracking of arterial oxygen saturation changes as may be required in urgent situations. When FastSAT is switched on, the averaging algorithm evaluates all the SpO₂ values and provides an averaged SpO₂ value that is a better representation of the patient's current oxygen saturation status.

The reliability of FastSAT is dependent on the setting for the averaging time and the input signal. FastSAT is disabled by default. To enable FastSAT, follow this procedure:

1. In **Continuous Monitoring** mode, select the SpO₂ numeric area or waveform area to enter the **SpO2** dialog. In **Spot Check** mode, select the **Main Menu** quick key → from the **Parameters** column select **Setup** → select **SpO2**.
2. Select the **Setup** tab.
3. Switch on **Fast SAT**.

6.6.6 Displaying SIQ (for Masimo SpO₂)

The signal quality indicator (SIQ) displays below the Pleth waveform. The SIQ is conveyed by vertical bars. The height of the bar provides an assessment of the confidence in the displayed SpO₂ value. The SpO₂ SIQ can also be used to identify the occurrence of a patient 's pulse.

The following picture shows the SpO₂ SIQ:

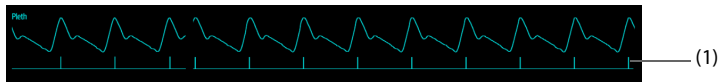

(1) Signal quality indicator (SIQ)

To show SpO₂ SIQ, follow this procedure:

1. In **Continuous Monitoring** mode, select the SpO₂ numeric area or waveform area to enter the **SpO2** dialog. In **Spot Check** mode, select the **Main Menu** quick key → from the **Parameters** column select **Setup** → select **SpO2**.
2. Select the **Setup** tab.
3. Switch on **Display SIQ**.

6.6.7 Changing Averaging Time (for Masimo SpO₂)

The SpO₂ value displayed on the monitor screen is the average of data collected within a specific time. The shorter the averaging time is, the quicker the monitor responds to changes in the patient's oxygen saturation level. Contrarily, the longer the averaging time is, the slower the monitor responds to changes in the patient's oxygen saturation level, but the SpO₂ measurement is more stable. For critically ill patients, selecting a shorter averaging time will help with understanding the patient's state.

To set the averaging time, follow this procedure:

1. In **Continuous Monitoring** mode, select the SpO₂ numeric area or waveform area to enter the **SpO2** dialog. In **Spot Check** mode, select the **Main Menu** quick key → from the **Parameters** column select **Setup** → select **SpO2**.
2. Select the **Setup** tab.
3. Set **Averaging**.

6.6.8 Showing/Hiding PI

You can set whether to display PI in the SpO₂ parameter area. To do so, follow this procedure:

1. In **Continuous Monitoring** mode, select the SpO₂ numeric area or waveform area to enter the **SpO2** dialog. In **Spot Check** mode, select the **Main Menu** quick key → from the **Parameters** column select **Setup** → select **SpO2**.
2. Select the **Setup** tab.
3. Switch on or off **Display PI**.

NOTE

- **This function is only available for Masimo SpO₂.**
-

6.6.9 Monitoring SpO₂ and NIBP Simultaneously

When monitoring SpO₂ and NIBP on the same limb simultaneously, you can switch on **NIBP Simul** to lock the SpO₂ alarm status until the NIBP measurement ends. If you switch off **NIBP Simul**, low perfusion caused by NIBP measurement may lead to inaccurate SpO₂ readings and therefore cause false physiological alarms.

In **Continuous Monitoring** mode, you can set the **NIBP Simul**. Follow this procedure:

1. Select the SpO₂ numeric area or waveform area to enter the **SpO2** dialog.
2. Select the **Alarm** tab.
3. Set **NIBP Simul**.

6.6.10 Changing the Sweep Speed of the Pleth Wave

To set the sweep speed of Pleth waveforms, follow this procedure:

1. In **Continuous Monitoring** mode, select the SpO₂ numeric area or waveform area to enter the **SpO2** dialog. In **Spot Check** mode, select the **Main Menu** quick key → from the **Parameters** column select **Setup** → select **SpO2**.
2. Select the **Setup** tab.
3. Set **Speed**.

6.7 SpO₂ Troubleshooting

This section lists the problems that might occur. If you encounter the problems when using the equipment or accessories, check the table below before requesting service. If the problem persists, contact your service personnel.

NOTE

- For the physiological and technical alarm messages, see *D Alarm Messages*.

Problem	Solution
Do not see SpO ₂ numeric area or waveform area on the main screen	Check that the SpO ₂ is set to display in the Edit Workflow menu. For more information, see 3.9.1.2 <i>Setting the Screen Layout</i> .
Dashes “-” display in place of numerics.	<ol style="list-style-type: none">1. Check that the cable connections of SpO₂ sensor and the extension cable are tight. Replace the SpO₂ sensor or the extension cable if needed.2. Reconnect the SpO₂ sensor if the alarm SpO2 Sensor Off appears.3. Check the PI value. If the PI value is too low, adjust the SpO₂ sensor, or apply the sensor to the site with better perfusion.4. Move the sensor to a place with weaker ambient light, or cover the sensor to minimize the ambient light if the alarm SpO2 Excess Light appears.
Low amplitude SpO ₂ signal	<ol style="list-style-type: none">1. The SpO₂ sensor and NIBP cuff are placed on the same limb. Change a monitoring site if necessary.2. Check the PI value. If the PI value is too low. Adjust the SpO₂ sensor, or apply the sensor to the site with better perfusion.3. Check the sensor and its application site.
SpO ₂ value is inaccurate	<ol style="list-style-type: none">1. Check the patient’s vital signs.2. Check for conditions that may cause inaccurate SpO₂ readings. For more information, see 6.3 <i>SpO₂ Measurement Limitations</i>.3. Check the monitor, the SpO₂ sensor for proper functioning.

6.8 Nellcor Information



Nellcor Patents

This posting serves as notice under 35 U.S.C. §287(a) for Covidien patents: <http://www.covidien.com/patents>.

No Implied License

Possession or purchase of this device does not convey any express or implied license to use the device with unauthorized replacement parts which would, alone, or in combination with this device, fall within the scope of one or more of the patents relating to this device.

6.9 Masimo Information



Masimo Patents

This posting serves as notice under 35 U.S.C. §287(a) for Masimo patents: <http://www.masimo.com/patents.htm>.

No Implied License

Possession or purchase of this device does not convey any express or implied license to use the device with unauthorized sensors or cables which would, alone, or in combination with this device, fall within the scope of one or more of the patents relating to this device.

6.10 Masimo End-User License Agreement

THIS DOCUMENT IS A LEGAL AGREEMENT BETWEEN YOU ("PURCHASER") AND SHENZHEN MINDRAY. IF YOU DO NOT AGREE TO THE TERMS OF THIS AGREEMENT, PROMPTLY RETURN THE ENTIRE PACKAGE, INCLUDING ALL ACCESSORIES, IN THEIR ORIGINAL PACKAGE, WITH YOUR SALES RECEIPT TO SHENZHEN MINDRAY FOR A FULL REFUND.

1. **Grant of License.** In consideration of payment of the license fee, which is part of the price paid for this product, Shenzhen Mindray grants to Purchaser a nonexclusive, nontransferable license, without right to sublicense, to use the copy of the incorporated software/firmware, and documentation in connection with Purchaser's use of the Masimo Products for their labeled purpose. Shenzhen Mindray reserves all rights not expressly granted to Purchaser.
2. **Ownership of Software/Firmware.** Title to, ownership of, and all rights and interests in, any Masimo software and/or firmware and the documentation, and all copies thereof, remain at all times vested in Masimo Corporation, licensor to Shenzhen Mindray, and they do not pass to Purchaser.
3. **Assignment.** Purchaser shall not assign or transfer this License, in whole or in part, by operation of law or otherwise, without Shenzhen Mindray's prior written consent; any attempt without such consent, to assign any rights, duties or obligations arising hereunder shall be void.

4. **Copy Restrictions.** The software/firmware, mask works, circuit board layouts, and accompanying written materials are copyrighted. Unauthorized copying of the software, including software that has been modified, merged, or included with other software, or other written materials is expressly forbidden. You may be held legally responsible for any copyright infringement that is caused or incurred by your failure to abide by the terms of this license. Nothing in this license provides any rights beyond those provided by 17 U.S.C. § 117.
5. **Use Restriction.** As the Purchaser, you may physically transfer the products from one location to another provided that the software/firmware is not copied. You may not electronically transfer the software/firmware from the products to any other device. You may not disclose, publish, translate, release, distribute copies of, modify, adapt, translate, reverse engineer, decompile, disassemble, or create derivative works based on the Masimo Product, the software/firmware, or the written materials without the prior written consent of Masimo. Masimo Sensors that are designated for single use are licensed under Masimo patents for use on a single patient only, and are not sold. There is no license, implied or otherwise, that would allow use of single use Masimo Sensors beyond their intended single use. After use of single use Masimo Sensors, there is no further license granted by Masimo to use the sensors and they must be discarded.
6. **Transfer Restrictions.** The software/firmware is licensed to the Purchaser, and may not be transferred to anyone, except other end-users, without the prior written consent of Shenzhen Mindray. In no event may you transfer, assign, rent, lease, sell, or otherwise dispose of the software/firmware or the products on a temporary basis.
7. **Masimo Corporation is a Beneficiary of this Agreement and has the right to enforce its provisions.**

U.S. Government Rights: If you are acquiring software (including the related documentation) on behalf of any part of the United States Government, the following provisions apply: the software is deemed to be “commercial software” and “commercial computer software documentation,” respectively pursuant to DFAR Section 227.7202 FAR 12.212, as applicable. Any use, modification, reproduction, release, performance, display or disclosure of the software (including the related documentation) by the U.S. Government or any of its agencies shall be governed solely by the terms of this Agreement and shall be prohibited except to the extent expressly permitted by the terms of this agreement.

7 Monitoring PR

7.1 PR Introduction

The pulse numeric counts the arterial pulsations that result from the mechanical activity of the heart. The pulse value can be from SpO₂ or NIBP. The PR parameter area displays its source.

7.2 PR Display



- (1) PR unit
- (2) PR high limit
- (3) PR low limit
- (4) PR Source: it can be sourced from SpO₂ or NIBP, with SpO₂ taking precedence.
- (5) Pulse rate (PR): detected pulsations per minute.
- (6) In **Spot Check** mode, select this area to mark the pulse as regular or irregular. It can be switched on or off. For details, see *7.3.3 Enabling Irregular PR*.

NOTE

- A functional tester or SpO₂ simulator can be used to determine the pulse rate accuracy.
-

7.3 Changing the PR Settings

7.3.1 Changing the PR Alarm Settings

In **Continuous Monitoring** mode, you can change the PR alarm settings. Follow this procedure:

1. Select the PR numeric area to enter the **PR** dialog.
2. Select the **PR Alarm** tab.
3. Set the alarm properties of PR.



7.3.2 Changing the Pulse Volume

To change the pulse volume, follow this procedure:

1. In **Continuous Monitoring** mode, select the PR numeric area to enter the **PR** dialog. In **Spot Check** mode, select the **Main Menu** quick key → from the **Parameters** column select **Setup** → select **PR**.
2. Select **PR Setup** tab.
3. Set the **Pulse Volume** to an appropriate level.

7.3.3 Enabling Irregular PR

To enable the Irregular PR function, follow this procedure:

1. Select the **Main Menu** quick key → from the **Configuration** column select **Workflow** → input the required password → select .
2. Select  on the right of the workflow to be set. Make sure the workflow is under **Spot Check**.
3. Select **Parameters Setup** → **PR**.
4. Switch on **Irr. PR Switch**.

8 Measuring Temperature (Temp)

8.1 Temp Introduction

The monitor can measure temperature with any one of the following temperature modules:

- Mindray TrueTemp™ module
- Exergen TemporalScanner™ thermometer

Below is a view of monitors configured with the above modules:

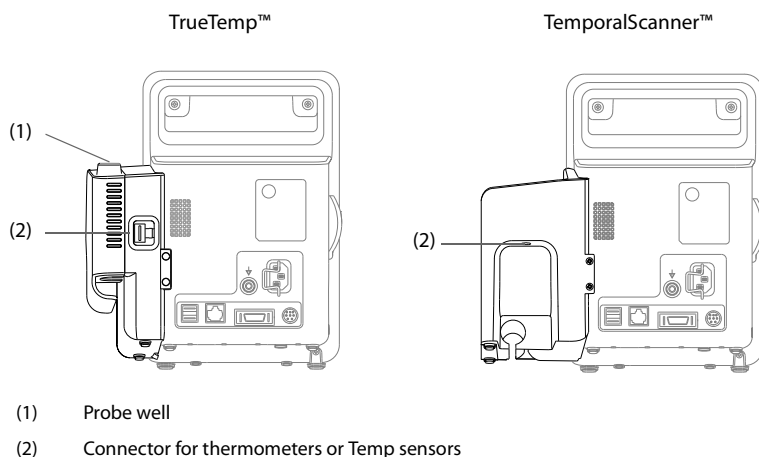

8.2 Temp Display

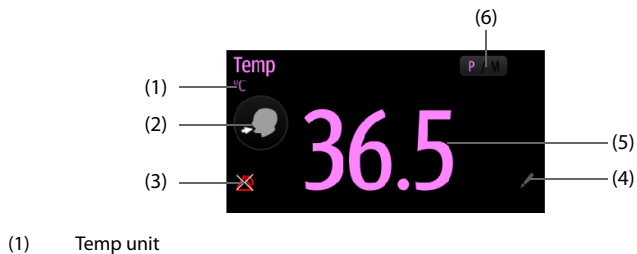

- (2) Measurement site: displays the current measurement site. You can select this area to select another measurement site.
- (3) Alarm off symbol if Temp alarm is off; alarm limit if Temp alarm is on
- (4) Select this area to manually input a measured Temp value
- (5) Temp value
- (6) Measurement mode (for TrueTemp™ only): displays the current mode, where “P” stands for **Predictive** and “M” stands for **Monitor**. You can select this area to switch to another mode.

8.3 Monitoring Temp with TrueTemp™ Module

The TrueTemp™ Temp modules are intended for monitoring oral, axillary and rectal temperature of adult and pediatric patients and axillary and rectal temperature of neonatal patients.

Temperature can be measured in either **Predictive** mode or **Monitor** mode. In **Monitor** mode, the thermal resistance in the probe reflects the patient’s temperature by sensing the temperature according to the thermal equilibrium principle. In the **Predictive** mode, the patient’s temperature is predicted by the temperature rise curve (which is obtained by collecting multiple temperature measurements) at the time the probe is applied to the patient. The default is **Predictive** mode.

Contra-indication

The TrueTemp™ module is not intended to be used at a site with unhealed wounds, lumps, or inflammation or any other symptoms that make the site unsuitable for temperature measurement.

WARNING

- **Do not take oral temperature on an infant (0-3 years).**
- **Do not take measurements on damaged skin.**
- **Use only the specified temperature probe and probe cover. Using other probe or probe cover, or not using probe cover may cause damage to the monitor or failure to meet the declared specifications in this manual.**
- **The temperature probe cover is disposable. Re-use of probe cover may result in patient cross-contamination.**
- **Use disposable probe covers for temperature measurement. Failure to use a probe cover can cause inaccurate temperature readings, and patient cross-contamination. Discard the probe if a probe cover is not used in the measurement.**
- **Check the disposable probe cover for damage before using. Never use any probe cover for temperature measurement in case of damage or contamination.**

- Be careful to avoid damaging the temperature probe. Place the temperature probe in the probe well if not in use.
- Prior to taking a temperature, instruct the patient not to bite down on the probe, as patient injury and damage to the probe may result.
- In the rectal mode, incorrect probe placement may result in bowel perforation.
- Wash hands after temperature is taken. This will significantly reduce the risk of cross contamination and nosocomial contamination.
- Ensure that probe covers are disposed of according to local regulations or hospital's requirements.
- Accuracy verification of the temperature module is required every two years or according to your hospital's policy. Please contact our Customer Service if accuracy verification is needed.

NOTE

- Patient actions may interfere with oral temperature readings. Ingesting hot or cold liquids, eating food, chewing gum, brushing teeth, smoking, or performing strenuous activities may affect temperature readings for up to 20 minutes after the activity has ended.
 - In the axillary mode, the probe shall directly contact with patient's skin. Measuring through patient's clothes or long-term exposure of patient's armpit to the air may result in inaccurate temperature reading.
 - Choose appropriate probe according to patient type and measurement site. Using the incorrect probe may cause patient's discomfort and inaccurate measurements.
 - The temperature taken by and displayed on this monitor is the temperature of the measurement site.
 - Improper use of probe may also cause patient's discomfort and inaccurate measurements.
-

8.3.1 Measuring Temp

8.3.1.1 Selecting Measuring Site

The temperature module can be configured with 2 types of temperature probe:

Type	Color	Patient Category	Measurement Site
Oral/axillary	Blue	Adult, pediatric	Oral, axillary
		Neonate	Axillary

Type	Color	Patient Category	Measurement Site
Rectal	Red	Adult, pediatric, neonate	Rectal

The blue oral/axillary probe shall only be used with blue probe well, while the red rectal probe shall only be used with red well.

Be sure to select correct probe according to the measurement site.

For adult and pediatric patients, when oral/axillary probe is used, the measurement site will automatically be set to **Oral**. You can change the site in **Temp** area.

For neonatal patients, when oral/axillary probe is used, the measurement site will automatically be set to **Axillary**. The measurement site cannot be changed.

8.3.1.2 Taking a Temperature in Predictive Mode

1. Verify that the probe is placed in the probe well.
2. Verify that the temperature measurement type and site are correct.
3. Unplug the probe from the probe well and the measurement mode changes to **Predictive** automatically.
4. Insert it into a cover in the probe cover pack and press the probe handle down firmly until the cover engages with the probe.

The temperature module starts to warm up when the probe is taken out. The message "Temp Warming Up" displays in Temp parameter area. The warming up time is about 2 seconds in room temperature. The monitor issues two beeps and provides the message "Temp Prediction Ready" on the screen when warm-up is complete. Then you can place the probe at measurement site.

5. Place the probe at measurement site and wait till the measurement stabilizes. When the dynamic symbol  appears, it indicates that the monitor starts to take the measurement.
 - ◆ When taking an oral temperature, apply the probe under the patient's tongue from either side of the mouth. Verify that the probe reaches the rear sublingual pocket. Have the patient close his/her lips to hold the probe. Hold the probe in place. Make sure that the probe contacts with the patient's oral tissue throughout the measurement.
 - ◆ When taking an axillary temperature, lift the patient's arm to expose the entire armpit. Apply the probe as high as possible in the armpit. Check that the probe tip is completely surrounded by the axillary tissue. Lower the patient's arm so that it is tightly placed at the patient side. Keep the patient's arm and the probe in place throughout the measurement.
 - ◆ When taking a rectal temperature, separate patient's buttocks with one hand, and insert the probe inside the rectum with the other hand. For adult patients, the depth of insertion is about 1.5 cm. For pediatric patients, the depth of insertion should be less than 1 cm. For neonatal patients, the depth

of insertion should be even less. Tilt the probe so that it always contacts with patient's tissue. Lubricant can be used in rectal mode.

The monitor will give a beep as the temperature measurement is complete. The temperature reading displays continuously until the probe is taken out from the probe well.

6. Withdraw the probe. Press firmly the ejection button on the top of the probe to eject the probe cover. Replace the probe into the probe well.
7. Clean and disinfect the temperature probe as described in section 8.3.2 *Cleaning and Disinfecting Temperature Probe*.

In **Predictive** mode, the monitor automatically enters **Monitor** mode in the following cases:

- Accurate temperature is not reached.
- Neither measurement is taken nor is the probe replaced in the probe well in 60 seconds after the probe is withdrawn from the well.

The temperature type automatically changes to Predictive mode when the probe returns to the probe well.

NOTE

- **In Predictive mode, temperature probe shall be placed to the measurement site as soon as probe warmup is complete; otherwise, inaccurate temperature reading may result.**
 - **In Predictive mode, if the probe has a high temperature due to the environmental temperature or other causes, cool the probe and then measure the patient's temperature.**
-

8.3.1.3 Taking a Temperature in Monitor Mode

To measure a temperature in the Monitor mode,

1. Verify that the probe is placed in the probe well.
2. Verify that the temperature measurement type and site are correct.
3. Select P/M on the screen to set the measurement mode to **Monitor**.
4. Unplug the probe from the probe well and insert it into a cover in the probe cover pack. Press the probe handle down firmly until the cover engages with the probe.
5. Place the probe to the measurement site and then start measuring. Refer to Step 4 in 8.3.1.2 *Taking a Temperature in Predictive Mode* for how to place a probe.
6. Withdraw the probe. Press firmly the ejection button on the top of the probe to eject the probe cover. Replace the probe into the probe well.
7. Clean and disinfect the temperature probe as described in section 8.3.2 *Cleaning and Disinfecting Temperature Probe*.

NOTE

- In Monitor mode, record the measured value prior to taking away the probe from measurement site. The monitor will automatically stop measuring temperature after 10 minutes from the start of the measurement.

8.3.2 Cleaning and Disinfecting Temperature Probe

The recommended cleaning and disinfecting agents include:

Product Name	Product Type	Manufacturer	Purpose	EPA No.
Water	Liquid	/	Cleaning	/
Ethanol, 70%	Liquid	/	Cleaning, disinfecting	/
1-Propanol, 50%	Liquid	/	Disinfecting	/
Alpet® D2 Surface Sanitizing Wipes	Wipes	BEST SANITIZERS INC™	Cleaning	73232-1
Clorox Dispatch® Hospital Cleaner Disinfectant Towels with Bleach	Wipes	Clorox professional products company	Cleaning	56392-8
Clorox Healthcare® Bleach Germicidal Wipes	Wipes	Clorox professional products company	Cleaning	67619-12
Clorox Healthcare® Hydrogen Peroxide Cleaner Disinfectant Wipes	Wipes	Clorox professional products company	Cleaning	67619-24
Diversey Oxivir® TB Wipes	Wipes	Diversey Inc	Cleaning	70627-60
Hydrogen peroxide, 3%	Liquid	/	Disinfecting	/
Isopropanol, 70%	Liquid	/	Disinfecting	/
Metrex CaviCide1™	Liquid, spray	METERX® RESEARCH	Cleaning, disinfecting	46781-12
Metrex CaviWipes™	Wipes	METERX® RESEARCH	Cleaning	46781-8
PDI Sani-Cloth® AF3 Germicidal Disposable Wipe	Wipes	PDI Inc.	Cleaning	9480-9

Product Name	Product Type	Manufacturer	Purpose	EPA No.
PDI Sani-Cloth® Bleach Germicidal Disposable Wipe	Wipes	PDI Inc.	Cleaning	9480-8
PDI Sani-Cloth® HB Germicidal Disposable Wipe	Wipes	PDI Inc.	Cleaning	61178-4-9480
PDI Sani-Cloth® Plus Germicidal Disposable Cloth	Wipes	PDI Inc.	Cleaning	9480-6
PDI Super Sani-Cloth® Germicidal Disposable Wipe	Wipes	PDI Inc.	Cleaning	9480-4
Rely+On™ Virkon® High Level surface Disinfectant, 1%	Powder	Antec International Ltd	Disinfecting	/
Sodium hypochlorite bleach 0.5%	Liquid	/	Disinfecting	/
Virex® II 256 (1:256)	Liquid	Diversey Inc	Cleaning, disinfecting	70627-24
Virex® TB	Liquid, spray	Diversey Inc	Cleaning, disinfecting	70627-2
mikrozid® Sensitive liquid	Liquid	Schülke & Mayr GmbH	Cleaning, disinfecting	/
Aniosurf ND premium, 0.25%	Liquid	ANIOS LABORATORIES	Disinfecting	/
Surfa 'safe	Liquid, spray	ANIOS LABORATORIES	Cleaning, disinfecting	/
Clinell® Universal Sanitising Wipes	Wipes	GAMA Healthcare Ltd	Cleaning, disinfecting	/
HEALTH ESSENCE Surface Disinfectant	Liquid, spray	Beijing ChangJiangMai Medical Science Technology Co. Ltd.	Disinfecting	/
DIAN'ERKANG® Surface Wipes	Wipes	Shanghai Likang Disinfectant Hi-Tech Co., Ltd.	Cleaning	/
Glutaraldehyde, 2%	Liquid	/	Disinfecting	/

Thoroughly clean and disinfect the probe before and after use. To clean and disinfect the temperature probe:

1. Disconnect the temperature probe from Temp connector.
2. Cleaning the probe using a soft, clean cloth dampened with a recommended cleaning agent.
3. Wipe off all the cleaning solution with a dry cloth after cleaning if necessary.
4. Disinfect the probe with a soft cloth dampened with the recommended disinfectant. Follow the disinfectants instructions, including contact time.
5. Wipe off all the remaining disinfectants from the probe with a soft cloth dampen with water.
6. Dry the probe in a cool place.
7. Check the probe and make sure there is no visible residue on the surface. Repeat the above steps to clean the main unit if necessary.

WARNING

- **Perform the decontamination or cleaning process with the monitor powered down and power cord removed.**
 - **The used soft cloth shall be properly disposed of.**
-
-

8.4 Monitoring Temp with Exergen TemporalScanner™ Thermometer

The TemporalScanner™ thermometer measures the temperature of the skin over the temporal artery. Operation is based on measuring the natural thermal infrared radiation emitted from the surface of the skin over the temporal artery.

The TemporalScanner™ is a handheld infrared thermometer used by medical professionals for the intermittent measurement of human body temperature of people of all ages, by scanning the forehead skin over the temporal artery.

8.4.1 Safety Information

WARNING

- **Use this product only for its intended use as described in this manual.**
- **Keep the TemporalScanner™ away from electromagnetic interference.**
- **Do not take temperature over scar tissue, open sores or abrasions.**
- **The thermometer is not shockproof. Do not drop it or expose it to electrical shocks.**

- Do not use this thermometer if it is not working properly, if it has been exposed to temperature extremes, damaged, been subject to electrical shocks or immersed in water.
- There are no parts that you can service yourself except for the battery, which you should replace when low by following the instructions in this manual. For service, repair, or adjustments, return your thermometer to Mindray.
- No modification of this equipment is allowed.
- Never drop or insert any object into any opening, unless stated in this manual.
- If your thermometer is not used regularly, remove the battery to prevent possible damage due to chemical leakage.
- The TemporalScanner™ thermometer is an adjusted mode clinical thermometer. Correction method is proprietary. Laboratory testing protocol for laboratory accuracy is available upon request.
- Follow the battery manufacturer's recommendations or your hospital policy for the disposal of used batteries.

8.4.2 Taking a Temperature with the TemporalScanner™

WARNING

- To avoid cross-contamination, disinfect the probe head or install a cap onto the probe head before taking measurement on a different patient.
-
-

8.4.2.1 Understanding the Measurement sites

Recommended measurement sites are: temperature at the temporal artery area or temperature behind the ear.

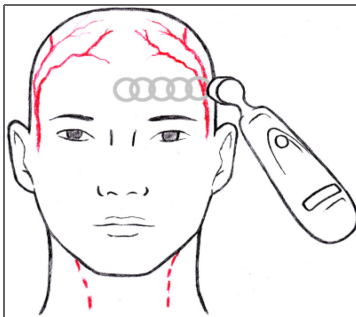

Temporal Artery Area

Behind the Ear

Alternate sites when temporal artery or behind ear are unavailable:

- Femoral artery: slowly slide the probe across groin.
- Lateral thoracic artery: slowly scan side-to-side in the area, midway between the axilla and the nipple.

8.4.2.2 Taking a Temperature on an Infant

To take a temperature on an infant, follow this procedure:

1. Place probe flush on center of forehead and depress button. Keeping button depressed, slowly slide probe mid-line across forehead to the hair line.
2. Release button remove from head and read measurement.

NOTE

- **The preferred site is the temporal artery area. Unless visibly diaphoretic, one measurement here is typically all that is required.**
 - **If the temporal artery is covered, then the area behind the ear, if exposed, can be an alternate site.**
 - **Measure straight across the forehead and not down side of face.**
 - **Brush the hair aside if covering the area to be measured. Measurement site must be exposed.**
-

8.4.2.3 Taking a Temperature on an Adult

To take a temperature on an adult, follow this procedure:

1. Slide across forehead. Place probe flush on center of forehead and depress button. Keeping button depressed slowly slide probe mid-line across forehead to the hair line.
2. Slide behind ear. Keeping button depressed, lift probe from forehead, touch behind ear halfway down the mastoid process and slide down to the soft depression behind the earlobe.
3. Release button and read measurement.

NOTE

- **Measure only the up-side on a patient in a lateral position. The down-side will be insulated preventing the heat from dissipating, resulting in falsely high readings.**

- **Think of a sweatband. Measure straight across the forehead and not down the side of the face. At mid-line, the temporal artery is about 2 mm below the surface, but can go deeply below the surface on the side of the face.**
- **Measure exposed skin. Brush the hair and bangs aside if covering the area to be measured.**

8.4.3 Understanding the TemporalScanner™ Thermometer LED Display

The following chart summarizes the conditions that may occur while the TemporalScanner™ is in use, and the associated indications:

Condition	Display	Solution/Range
High Target	HI	>110 °F(43 °C)
Low Target	LO	<61 °F(16 °C)
High Ambient	HI A	>104 °F (40 °C)
Low Ambient	LO A	<60 °F (16 °C)
Low Battery	bAtt	/
No or Very Low Battery	blank display	/
Processing Error	Err	Restart. Return to Mindray for repair if error message persists.
Scanning (Normal Operation)	----	/

8.4.4 Fahrenheit or Celsius Conversion

The TemporalScanner™ can be used in either °F or °C. To convert from one scale to the other, the only tools necessary are a paper clip and the tip of a small screwdriver.

To convert to Fahrenheit or Celsius:

1. Bend one leg of a paper clip and insert it into the hole in the side of the plastic housing.
2. Push to release the battery cover, and then remove the battery.
3. Slide the switch to left (Celsius) or right (Fahrenheit) with the tip of a screwdriver.
4. Replace battery and cover.

NOTE

- **After converting to Fahrenheit, the readings on TemporalScanner™ and the monitor might be slightly different. The readings on TemporalScanner™ would be more accurate.**

8.4.5 Replacing the Battery

To replace the battery, follow this procedure:

1. Bend one leg of a paper clip and insert it into the pinhole in the side of the plastic housing.
2. Push to release the battery cover, and then remove the battery.
3. Replace the battery into the compartment.
4. Reinstall the battery cover.

8.4.6 Troubleshooting

Message/Issue	Cause	Solution
Abnormally low Temperature	Dirty Lens	Clean lens of scanner every two weeks.
	Releasing the button before finished measuring	Release the button after finished measuring.
	Measuring when an ice pack or wet compress is on the forehead	Remove ice pack or wet compress, wait 2 minutes, and re-take temperature.
	Measuring a completely diaphoretic patient	Complete diaphoresis includes diaphoresis of area behind the ear and suggests that the temperature is rapidly dropping. Use an alternative method of temperature measurement in these cases until the patient is dry and the temporal artery measurement can be repeated.
	Improperly scanning down the side of the face	Scan straight across forehead. The temporal artery is closest to skin in that area.
Abnormally high temperature	Anything covering the area to be measured would insulate and prevent heat from dissipating, resulting in false high readings.	Confirm measurement site has not recently been in contact with heat insulators such as hats, blankets, and hair. Scan the area not covered or wait about 30 seconds for the previously covered area to equilibrate to the environment.

8.4.7 Cleaning the TemporalScanner™ Thermometer

WARNING

- **Never use abrasive materials (such as steel wool or silver polish), or erosive cleaners (such as acetone or acetone-based cleaners).**
 - **Never immerse any part of the product in liquids or allow liquid to enter the interior.**
 - **When cleaning or disinfecting the product, avoid pouring any liquid on the thermometer.**
-
-

You should clean the product as per your hospital's regulations after each use. Sterilization is not allowed for the product.

■ Cleaning the case

The TemporalScanner™ case can be wiped down using a cloth dampened with 70% isopropyl alcohol. The industrial grade housing and design of the electronic components allow for completely safe cleaning with 70% isopropyl alcohol but should not be immersed in fluid or autoclaved.

■ Cleaning the sensor lens



Dirt, greasy films or moisture on the lens will interfere with the passage of infrared heat and affect the accuracy of the product.

Clean the lens every two weeks with a cotton swab dipped in alcohol. Use only light force for cleaning, to avoid damaging the lens. Water can be used to remove any residual film left by the alcohol. Do not use bleach or other cleaning solutions on the sensor lens.

8.5 Manually Inputting Temp

You can manually input a Temp value and save the data for future reference.

Follow this procedure:

1. Select  in the Temp area. For monitors configured with Mindray TrueTemp™ module, to input Temp value in **Continuous Monitoring** mode, press and hold  in the Temp area.
2. Select a **Temp Measurement Site**. The options displayed in the menu is configurable. For details, refer to *16.8.3 Setting Temp Measurement Sites*.
3. Input a measured Temp value.
4. Select the **Save** quick key to save the data.

This page intentionally left blank.

9 Measuring Noninvasive Blood Pressure (NIBP)

9.1 NIBP Introduction

The monitor uses the oscillometric method for measuring the Non-Invasive Blood Pressure (NIBP). NIBP measurement is based on the principle that pulsatile blood flow through an artery creates oscillations of the arterial wall. The oscillometric device uses a blood pressure cuff to sense these oscillations that appear as tiny pulsations in cuff pressure.

Two algorithms can be used on the monitor:

- **Inflation:** at the inflation stage, the device creates a slow inflation of a cuff while simultaneously detecting oscillations. As soon as systolic pressure is determined, the cuff is deflated. The oscillations that appear during inflation increase in amplitude to a peak amplitude (which approximates to the mean pressure) with increasing cuff pressure and then decrease in amplitude. If the measurement fails at the inflation stage, the device will automatically continue the measurement at deflation stage.
- **Deflation:** the device measures the amplitude of pressure changes in the occluding cuff as the cuff deflates from above systolic pressure. The amplitude suddenly increases as the pulse breaks through the occlusion in the artery. As the cuff pressure decreases further, the pulsations increase in amplitude, reach a maximum (which approximates to the mean pressure), and then diminish.

The oscillometric method measures the mean pressure and determines the systolic and diastolic pressures.

NIBP measurement adopting inflation algorithm is intended for adult and pediatric patients, and NIBP measurement adopting deflation algorithm is intended for adult, pediatric, and neonatal patients.

NOTE

- **Blood pressure measurements determined with this device are equivalent to those obtained by a trained observer using the cuff/stethoscope auscultatory method or an intra-arterial blood pressure measurement device, within the limits prescribed by the American National Standard: manual, electronic, or automated sphygmomanometers.**
 - **NIBP measurement can be performed during electro-surgery and discharge of a defibrillator.**
-

9.2 NIBP Safety Information

WARNING

- **Be sure to select the correct patient category setting for your patient before NIBP measurement. Do not apply the higher adult settings for pediatric or neonatal patients. Otherwise, it may present a safety hazard.**
 - **Do not measure NIBP on patients with sickle-cell disease or on the limb where skin damage has occurred or is expected.**
 - **If your monitor is using inflation algorithm, select cuffs with the *TrueBP*[™] symbol. Using other cuffs may lead to incorrect or failed measurements.**
 - **Use clinical judgment to determine whether to perform frequent unattended blood pressure measurement on patients with severe blood clotting disorders because of the risk of hematoma in the limb fitted with the cuff.**
 - **Do not use the NIBP cuff on a limb with an intravenous infusion or arterial catheter in place. This could cause tissue damage around the catheter when the infusion is slowed or blocked during cuff inflation.**
 - **Do not apply cuff on the arm on the side of a mastectomy or lymph node clearance.**
 - **Continuous cuff pressure due to connection tubing kinking may cause blood flow interference and result in harmful injury to the patient.**
 - **NIBP reading can be affected by the measurement site, the position of the patient, exercise, or the patient's physiologic condition. If you doubt the NIBP measurements, determine the patient's vital signs by alternative means, and then verify that the monitor is working correctly.**
 - **Devices that exert pressure on tissue have been associated with purpura, ischemia, and neuropathy. Inspect the application site regularly to ensure skin quality and inspect the extremity of the cuffed limb for normal color, warmth and sensitivity. If the skin quality changes, or if the extremity circulation is being affected, move the cuff to another site or stop the blood pressure measurement immediately. Check more frequently when making automatic or STAT measurement. Auto NIBP measurement with one and two minute intervals is not recommended for extended periods of time.**
 - **Do not modify or replace connectors of the NIBP air hose except with Mindray-approved connectors.**
 - **Never connect intra-arterial or intra-venous lines, or any other incompatible connectors to the NIBP hose. This can cause serious injury or death.**
 - **NIBP diagnostic significance must be decided by the hospital's clinician staff.**
-
-

CAUTION

- **Measuring NIBP on patients connected to an Intra Aortic Balloon Pump (IABP) machine may result in the NIBP measurement, including PR, to be inaccurate or fail.**
 - **Only use parts and accessories specified in this manual. Follow the instructions for use and adhere to all warnings and cautions.**
 - **Accuracy of NIBP measurement depends on using a cuff of proper size. It is essential to measure limb circumference and choose a cuff with proper size.**
-

9.3 NIBP Measurement Limitations

Measurement is impossible with heart rate extremes of less than 30 bpm or greater than 300 bpm, or if the patient is on a heart-lung machine. The measurement may be inaccurate or impossible in the following situations:

- Regular arterial pressure pulses are hard to detect
- Excessive and continuous patient movement such as shivering or convulsions
- Cardiac arrhythmias
- Rapid blood pressure changes
- Severe shock or hypothermia that reduces blood flow to the peripheries
- On an edematous extremity
- Obesity, where a thick layer of fat surrounding a limb dampens the oscillations coming from the artery

NOTE

- **The effectiveness of this sphygmomanometer has not been established in pregnant women, including pre-eclamptic patients.**
-

9.4 Measurement Modes

In **Spot Check** mode, there are three NIBP measurement modes:

- Manual: measurement on demand.
- BP (Blood Pressure) Averaging: see *9.9 BP Averaging*.
- Orthostatic BP measurement: see *9.10 Orthostatic BP Measurement*.

In **Continuous Monitoring** mode, there are four NIBP measurement modes:

- Manual: measurement on demand.
- Auto: repeated measurement at set interval or an interval synchronized with the real time clock.

- STAT: continual rapid series of measurement over a five minute period.
- Sequence: continually automatic measurement at set durations and intervals.

9.5 NIBP Display

Below is an example of NIBP screen in **Spot Check** mode:

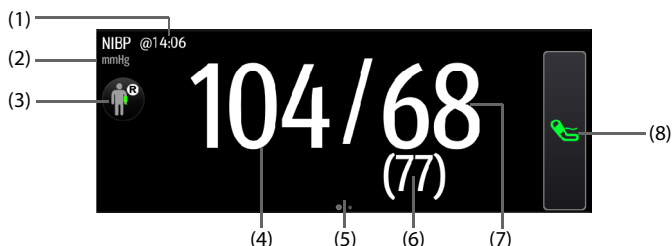

- (1) The last NIBP measurement time
- (2) NIBP unit: mmHg or kPa
- (3) Select this area to set the patient position and measurement site
- (4) Systolic pressure
- (5) Another measurement mode is available:
 - If the department is set to **Physician Office**, swipe on the NIBP area to the left or right to switch to BP averaging screen. For details, see [9.9 BP Averaging](#).
 - If orthostatic BP measurement is enabled, swipe on the NIBP area to the left or right to switch to orthostatic BP measurement screen. For details, see [9.10 Orthostatic BP Measurement](#).
- (6) Mean pressure (displayed after the measurement completes) or cuff pressure (displayed during the measurement)
- (7) Diastolic pressure
- (8) Start/Stop NIBP measurement

Below is an example of NIBP screen in **Continuous Monitoring** mode:

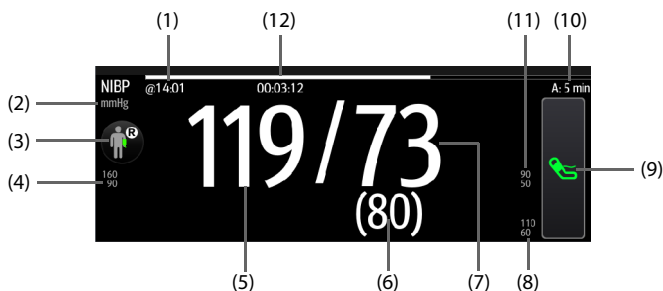

- (1) The last measurement time
- (2) NIBP unit: mmHg or kPa
- (3) Select this area to set the patient position and measurement site
- (4) Systolic pressure alarm limits
- (5) Systolic pressure
- (6) Mean pressure (displayed after measurement completed) or cuff pressure (displayed during the measurement)
- (7) Diastolic pressure
- (8) Mean pressure alarm limits
- (9) Start/Stop NIBP measurement
- (10) Sequence information (for Sequence mode): the capital letter indicates the current phase and the time indicates the current measurement interval
- (11) Diastolic pressure alarm limits
- (12) Time to the next measurement (for Auto mode and Sequence mode)

The display of pressure values can be configured. For details, see *9.8.6 Setting the NIBP Display Format*.

NOTE

- **If the measurement fails, “XX” is displayed; if measurement is not taken, “--” is displayed.**
 - **NIBP numerics in black color with a light outline indicate that the measurement is old and exceeds the configured NIBP Measurement Timeout time (see section *16.8.6 Setting Parameter Measurement Timeout*). These NIBP values are not recommended for reference.**
-

9.6 Preparing for NIBP Measurement

9.6.1 Preparing the Patient for NIBP Measurement

In normal use, perform NIBP measurement on a patient who is in the following position:

- Comfortably seated
- Legs uncrossed
- Feet flat on the floor
- Back, arm and feet supported

For patients taking orthostatic BP measurement, refer to *9.10 Orthostatic BP Measurement*.

NOTE

- **It is recommended that the patient remains calm and relaxes as much as possible before performing the measurement and that the patient do not talk during the measurement.**
 - **It is recommended to have the patient sit quietly for several minutes before taking the measurement.**
 - **For known hypertensive patients, set initial cuff pressure to a higher value to reduce the measurement time.**
 - **Do not touch the cuff or tubing during NIBP measurement.**
 - **Other factors that have been shown to result in an overestimation of blood pressure are labored breathing, full bladder, pain etc.**
-

9.6.2 Placing the NIBP Cuff

To place the NIBP cuff, follow this procedure:

1. Verify that the patient category setting is correct. If not, enter the Patient Management dialog to change patient category. For more information, see *4.2.2 Editing Patient Information*.
2. Connect the air tubing to the NIBP connector on the monitor.
3. Select an appropriate cuff for the patient, and then wrap it around the limb directly over the patient's skin as follows:
 - a If your monitor is using inflation algorithm, select cuffs with the **TrueBP™** symbol. Using other cuff may lead to incorrect or failed measurements.
 - b Determine the patient's limb circumference.
 - c Select an appropriate cuff by referring to the limb circumference marked on the cuff. The width of the cuff should be 40% (50% for neonates) of the limb circumference, or 2/3 of the length of the upper arm or the thigh. The inflatable part of the cuff should be long enough to encircle at least 50% to 80% of the limb.
 - d Apply the cuff to the patient's upper arm or leg and make sure the Φ marking on the cuff matches the artery location. The cuff should fit snugly, but with enough room for two fingers to be placed between the cuff and the patient's arm (on adults), and loosely on neonates with little or no air present within the cuff. Otherwise it may cause discoloration and ischemia of the extremities. Make sure that the cuff index line falls within the range markings on the cuff. If it does not, use a cuff that fits better.
 - e Middle of the cuff should be at the level of the right atrium of the heart. If it is not, use the measurement correction formula to correct the measurement. For more information, see *9.8.9 Correcting the NIBP Measurements*.

4. Connect the cuff to the air tubing. Avoid compression or restriction of pressure tubes. Air must pass unrestricted through the tubing.

CAUTION



- **A wrong cuff size and a folded or twisted bladder can cause inaccurate measurements.**
 - **Do not touch or apply external pressure against the cuff and air tubing during NIBP measurement. This may cause inaccurate blood pressure values.**
 - **Use care when placing the cuff on an extremity used for monitoring other patient parameters.**
-

9.7 Performing Measurement

This section describes the procedure to start manual, auto, STAT, and sequence measurement. For BP Averaging, see *9.9 BP Averaging*. For Orthostatic BP measurement, see *9.10 Orthostatic BP Measurement*.

9.7.1 Performing Manual Measurement

To perform manual measurement, follow this procedure:

1. Prepare the patient and place the cuff as instructed in *9.6 Preparing for NIBP Measurement*.
2. Select  to set the patient position and measurement site.
3. Select  to start the measurement.

In **Spot Check** mode, you can perform two times of measurement as a group for clinical evaluation. For setting of measurement times, see *9.8.8 Setting Measurement Times*.

Below is an example of NIBP screen if **Measurements** is set to **Twice**:

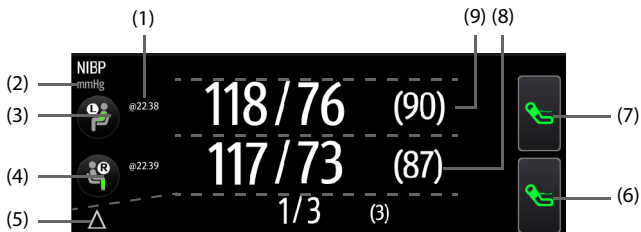

- (1) The last measurement time
- (2) NIBP unit: mmHg or kPa
- (3) Patient position and site of the first measurement
- (4) Patient position and site of the second measurement

- (5) Differences between the two groups of measurements: displayed in the form of Sys/Dia (Mean)
- (6) Start/Stop the second measurement
- (7) Start/Stop the first measurement
- (8) Values of the second measurement: displayed in the form of Sys/Dia (Mean)
- (9) Values of the first measurement: displayed in the form of Sys/Dia (Mean)

9.7.2 Performing Auto Measurement

To perform auto measurement, follow this procedure:

1. Prepare the patient and place the cuff as instructed in *9.6 Preparing for NIBP Measurement*.
2. Select a workflow under **Continuous Monitoring**.
3. Select  to set the patient position and measurement site.
4. Select the NIBP numeric area to enter the **NIBP** dialog.
5. Set **Interval** to an appropriate duration.
6. Set **Start Mode** to **Interval** or **Clock**.
 - ◆ **Clock**: after the first measurement, the monitor automatically synchronizes NIBP automatic measurement with the real time clock. For example, if **Interval** is set to **20 min**, and NIBP auto measurement is started at 14:03, the next measurement will be taken at 14:20, and then at 14:40, 15:00, and so on.
 - ◆ **Interval**: after the first measurement, the monitor automatically repeats measurement at set interval. For example, if **Interval** is set to **20 min**, and NIBP auto measurement is started at 14:03, the next measurement will be taken at 14:23, and then at 14:43, 15:03, and so on.
7. Select **Start NIBP**.

9.7.3 Performing STAT Measurement

To perform STAT measurement, follow this procedure:

1. Prepare the patient and place the cuff as instructed in *9.6 Preparing for NIBP Measurement*.
2. Select a workflow under **Continuous Monitoring**.
3. Select  to set the patient position and measurement site.
4. Select the NIBP numeric area to enter the **NIBP** dialog.
5. Select **STAT**.

9.7.4 Performing Sequence Measurement

To perform sequence measurement, follow this procedure:

1. Prepare the patient and place the cuff as instructed in *9.6 Preparing for NIBP Measurement*.
2. Select a workflow under **Continuous Monitoring**.
3. Select  to set the patient position and measurement site.
4. Select the NIBP numeric area to enter the **NIBP** dialog.
5. Select **Sequence** tab to set the duration and interval of phases in the sequence. For details, see *9.8.5 Setting NIBP Sequence*.
6. Select **Setup** tab, set **Interval** to **Sequence**.
7. Set **Start Mode** to **Interval**.
8. Select **Start NIBP**.

9.8 Changing NIBP Settings

9.8.1 Setting the NIBP Alarm Properties

In **Continuous Monitoring** mode, you can set the NIBP alarm properties. Follow this procedure:

1. Select the NIBP numeric area to enter the **NIBP** dialog.
2. Select the **Alarm** tab.
3. Enter the password if required. For more information, refer to *16.3.3 Selecting Password for Changing Alarm settings*.
4. Set alarm properties as desired.

9.8.2 Setting the NIBP Interval

For auto NIBP measurement, you need to set the interval between two times of NIBP measurement. In **Continuous Monitoring** mode, you can set the NIBP interval. Follow this procedure:

1. Select the NIBP numeric area to enter the **NIBP** dialog → **Setup** tab.
2. Set **Interval**. Selecting **Manual** switches to manual mode.

9.8.3 Selecting NIBP Start Mode

Start mode defines how NIBP auto mode works. In **Continuous Monitoring** mode, you can set the start mode. Follow this procedure:

1. Select the NIBP numeric area to enter the **NIBP** dialog.
2. Set **Start Mode**.

- ◆ **Clock:** after the first measurement, the monitor automatically synchronizes NIBP automatic measurement with the real time clock. For example, if **Interval** is set to **20 min**, and you start NIBP auto measurement at 14: 03, the next measurement will be taken at 14: 20, and then at 14:40, 15:00, and so on.
- ◆ **Interval:** after the first measurement, the monitor automatically repeats measurement at set interval. For example, if **Interval** is set to **20 min**, and you start NIBP auto measurement at 14:03, the next measurement will be taken at 14:23, and then at 14:43, 15:03, and so on.

9.8.4 Enabling the NIBP End Tone

The monitor can issue a reminder tone at the completion of NIBP measurement. The NIBP End Tone is off by default. You can switch on the NIBP tone in workflow setup dialog. After setting, every time you switch to the workflow, **NIBP End Tone** is switched on.

You can also switch on the NIBP end tone in the **NIBP** dialog. To do so, follow this procedure:

1. In **Continuous Monitoring** mode, select the NIBP numeric area to enter the **NIBP** dialog. In **Spot Check** mode, select the **Main Menu** quick key → from the **Parameters** column select **Setup** → select **NIBP**.
2. Switch on **NIBP End Tone**.

9.8.5 Setting NIBP Sequence

In **Continuous Monitoring** mode, you can set NIBP sequence. NIBP sequence measurement can have up to five phases: A, B, C, D, and E. The duration and interval of each phase can be set individually.

To set NIBP sequence, follow this procedure:

1. Select the NIBP numeric area to enter the **NIBP** dialog.
2. Select the **Sequence** tab.
3. Set **Duration** and **Interval** of each phase.

9.8.6 Setting the NIBP Display Format

To set the NIBP display format, follow this procedure:

1. In **Continuous Monitoring** mode, select the NIBP numeric area to enter the **NIBP** dialog. In **Spot Check** mode, select the **Main Menu** quick key → from the **Parameters** column select **Setup** → select **NIBP**.
2. Select the **Setup** tab.
3. Set **Display Format**.



9.8.7 Setting the NIBP Alarm Limits Display Switch

In **Continuous Monitoring** mode, you can set whether to display the alarm limits of diastolic NIBP and mean NIBP. Follow this procedure:

1. Select the NIBP numeric area to enter the **NIBP** dialog.
2. Select the **Setup** tab.
3. Switch on or off **Display Alarm Limits**.

9.8.8 Setting Measurement Times

To set the measurement times, follow this procedure:

1. Select the **Main Menu** quick key → from the **Configuration** column select **Workflow** → input the required password → select .
2. Select  on the right of the workflow to be set. Make sure the workflow is under **Spot Check**.
3. Select **Parameters Setup**.
4. Under **NIBP** tab, set **Measurements** to **Twice**.

9.8.9 Correcting the NIBP Measurements

The middle of the cuff should be at the level of right atrium. If the limb is not at the heart level, the measurement should be corrected as follows:

- Add 0.75 mmHg (0.10 kPa) to the displayed value for each centimetre higher.
- Deduct 0.75 mmHg (0.10 kPa) to the displayed value for each centimeter lower.

9.9 BP Averaging



In BP averaging mode, a group of BP measurement is performed on a patient automatically. At the completion of measurement, a group of averaged BP readings is displayed.

9.9.1 Enabling BP Averaging

BP averaging is available only when the **Department** is set to **Physician Office** and the monitor is working in **Spot Check** mode.

To change the department, see *15.2 Changing the Department*.

To enable BP averaging, follow this procedure:

1. Select the **Main Menu** quick key → from the **Configuration** column select **Workflow** → input the required password → select .
2. Select  on the right of the workflow to be set. Make sure the workflow is under **Spot Check**.
3. Select **Parameters Setup** → the **NIBP** tab.

- Under **Average**, enable **BP Averaging**.

9.9.2 BP Averaging Display

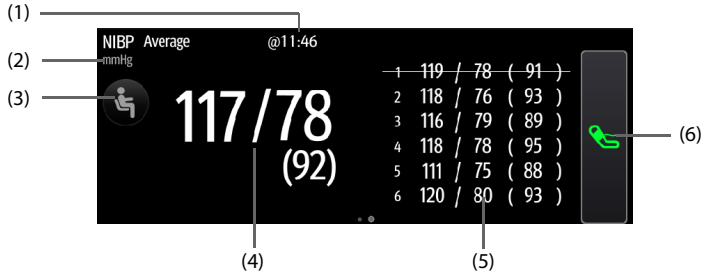

The following figure shows the BP averaging screen.



- (1) Time of last measurement
- (2) NIBP unit: mmHg or kPa
- (3) Select this area to set the patient position and measurement site
- (4) Averaged blood pressure: displayed in the form of Sys/Dia (Mean)
- (5) Measurements used for averaging: if the first group of measurements is displayed with a strikethrough, it is excluded in the averaging. For details, see *9.9.4.4 Excluding the First Group of Readings in the Calculation*.
- (6) Start NIBP measurement

9.9.3 Performing BP Averaging



Follow this procedure:

1. Prepare the patient and place the NIBP cuff as instructed in *9.6 Preparing for NIBP Measurement*.
2. Swipe on the NIBP area to the left or right to switch to BP averaging screen.
3. Select  to set the patient position and measurement site.
4. Select  to start the first measurement.
 - ◆ The monitor starts the first measurement immediately or after the set delay. For details, see *9.9.4.1 Setting the Delay before Starting the First Measurement*.
 - ◆ After the first measurement, the monitor automatically takes several times of BP measurement (see *9.9.4.2 Setting the Number of Measurement*) at the set interval (see *9.9.4.3 Setting Time between Readings*).
5. At the completion of automatic measurement, select **Return** to check the readings of each measurement and the averaged BP values.

9.9.4 Changing BP Averaging Settings



9.9.4.1 Setting the Delay before Starting the First Measurement

Follow this procedure:

1. Select the **Main Menu** quick key → from the **Configuration** column select **Workflow** → input the required password → select .
2. Select  on the right of the workflow to be set. Make sure the workflow is under **Spot Check**.
3. Select **Parameters Setup** → the **NIBP** tab.
4. Under **Average**, set **Delay Before Starting Measurement**.



9.9.4.2 Setting the Number of Measurement

Follow this procedure:

1. Select the **Main Menu** quick key → from the **Configuration** column select **Workflow** → input the required password → select .
2. Select  on the right of the workflow to be set. Make sure the workflow is under **Spot Check**.
3. Select **Parameters Setup** → the **NIBP** tab.
4. Under **Average**, set **Number of Measurements**.



9.9.4.3 Setting Time between Readings

You can set the time duration between the starts of two consecutive measurement. Follow this procedure:

1. Select the **Main Menu** quick key → from the **Configuration** column select **Workflow** → input the required password → select .
2. Select  on the right of the workflow to be set. Make sure the workflow is under **Spot Check**.
3. Select **Parameters Setup** → the **NIBP** tab.
4. Under **Average**, set **Time Between Readings**.

9.9.4.4 Excluding the First Group of Readings in the Calculation

You can choose to exclude the first group of readings in the averaging calculation. Follow this procedure:

1. Select the **Main Menu** quick key → from the **Configuration** column select **Workflow** → input the required password → select .
2. Select  on the right of the workflow to be set. Make sure the workflow is under **Spot Check**.

3. Select **Parameters Setup** → the **NIBP** tab.
4. Under **Average**, enable **Discard First Group of Readings**.

9.10 Orthostatic BP Measurement

Orthostatic blood pressure is important for the assessment of fall risks. On the monitor, you can measure the lying, sitting and standing blood pressure of a patient, and check the differences for clinical evaluation. Orthostatic BP measurement is only applicable for adult patient.

A license is required for the orthostatic BP measurement function. To check the license, see *3.9.6 Checking Software Licenses*.

9.10.1 Enabling Orthostatic BP Measurement

Orthostatic BP measurement is available only when the monitor is working in **Spot Check** mode.

To enable Orthostatic BP measurement, follow this procedure:

1. Select the **Main Menu** quick key → from the **Configuration** column select **Workflow** → input the required password → select ↩.
2. Select  on the right of the workflow to be set. Make sure the workflow is under **Spot Check**.
3. Select **Parameters Setup** → the **NIBP** tab.
4. Under **Orthostatic BP Measurement**, enable **Orthostatic BP Measurement**.

9.10.2 Orthostatic BP Measurement Display

The following figure shows the orthostatic BP measurement screen.

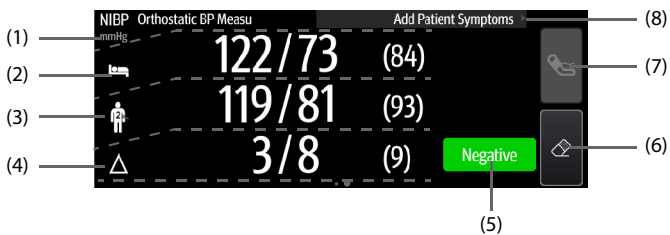



- (1) NIBP unit: mmHg or kPa
- (2) Lying or sitting blood pressure: displayed in the form of Sys/Dia (Mean)
- (3) Standing or sitting blood pressure: displayed in the form of Sys/Dia (Mean). The lowest values measured are used in contrasting.
- (4) Differences between the lying blood pressure and lowest standing or sitting blood pressure

- (5) Evaluation result based on the set criteria:
 - **Negative:** the differences are within the acceptable range as per the set criteria.
 - **Positive:** the differences are out of the acceptable range as per the set criteria.
For details, see 9.10.4.6 *Setting Orthostatic BP Evaluation Criterion*.
- (6) Start/Stop standing or sitting blood pressure measurement before measurement and clear data after measurement
- (7) Start/Stop lying or sitting blood pressure measurement
- (8) Add patient symptoms for result evaluation

9.10.3 Performing Orthostatic BP Measurement



Follow this procedure:

1. Place the NIBP cuff as instructed in 9.6.2 *Placing the NIBP Cuff*.
2. Swipe on the NIBP area to the left or right to switch to the orthostatic BP measurement screen.
3. Follow the instructions on the screen to perform measurements. Measurements should be performed in the sequence of the patient positions set in the current workflow. For more information, refer to 9.10.4.1 *Setting the Sequence for Orthostatic BP Measurement*. In this process, you may need to perform the following operations:
 - ◆ Ask the patient to adjust to the measurement position.
 - ◆ If needed, select  on the screen to start a count up timer. The lying or sitting duration is configurable. For details, refer to 9.10.4.2 *Setting the Lying or Sitting Duration of Patient*.
 - ◆ Select  on the right to start a measurement.
4. Select symptoms if necessary. The list of symptoms are configurable. For details, see 9.10.4.5 *Setting Orthostatic BP Symptoms*.
5. Upon completion of measurement, the evaluation result is displayed in the NIBP area. Select **Negative** or **Positive** to check for details.

9.10.4 Changing Orthostatic BP Measurement Settings

9.10.4.1 Setting the Sequence for Orthostatic BP Measurement

Follow this procedure:



1. Select the **Main Menu** quick key → from the **Configuration** column select **Workflow** → input the required password → select .
2. Select  on the right of the workflow to be set. Make sure the workflow is under **Spot Check**.
3. Select **Parameters Setup** → the **NIBP** tab.

- Under **Orthostatic BP Measurement**, set **Position**. The monitor will guide you to perform measurements in the following sequence:

Item	Measurement Sequence		
Lying-Standing	Lying	Standing (measurement time configurable, see 9.10.4.4 <i>Setting the Times of Standing or Sitting BP Measurement</i>)	
Lying-Sitting	Lying	Sitting (measurement time configurable, see 9.10.4.4 <i>Setting the Times of Standing or Sitting BP Measurement</i>)	
Lying-Sitting-Standing	Lying	Sitting	Standing (measurement time configurable, see 9.10.4.4 <i>Setting the Times of Standing or Sitting BP Measurement</i>)
Sitting-Standing	Sitting	Standing (measurement time configurable, see 9.10.4.4 <i>Setting the Times of Standing or Sitting BP Measurement</i>)	



9.10.4.2 Setting the Lying or Sitting Duration of Patient

Follow this procedure:

- Select the **Main Menu** quick key → from the **Configuration** column select **Workflow** → input the required password → select .
- Select  on the right of the workflow to be set. Make sure the workflow is under **Spot Check**.
- Select **Parameters Setup** → the **NIBP** tab.
- Under **Orthostatic BP Measurement**, set **Lying Duration** or **Sitting Duration**.

9.10.4.3 Setting Standing or Sitting BP Measurement Interval

Follow this procedure:

- Select the **Main Menu** quick key → from the **Configuration** column select **Workflow** → input the required password → select .
- Select  on the right of the workflow to be set. Make sure the workflow is under **Spot Check**.
- Select **Parameters Setup** → the **NIBP** tab.
- Under **Orthostatic BP Measurement**, set **Standing BP Measurement Interval** or **Sitting BP Measurement Interval**.

9.10.4.4 Setting the Times of Standing or Sitting BP Measurement



Follow this procedure:

- Select the **Main Menu** quick key → from the **Configuration** column select **Workflow** → input the required password → select .

2. Select  on the right of the workflow to be set. Make sure the workflow is under **Spot Check**.
3. Select **Parameters Setup** → the **NIBP** tab.
4. Under **Orthostatic BP Measurement**, set **Maximum Standing BP Measurements** or **Maximum Sitting BP Measurements**.

9.10.4.5 Setting Orthostatic BP Symptoms

Follow this procedure:

1. Select the **Main Menu** quick key → from the **System** column select **Maintenance** → input the required password → select  → **Module**.
2. Under **Orthostatic BP Symptoms**, select  to edit a symptom. You can also select **Add Symptom** to create a new symptom and then select  to edit it.



NOTE

- You can set up to ten symptoms.

9.10.4.6 Setting Orthostatic BP Evaluation Criterion

You can set criteria for evaluation of the pressure differences. Different criteria can be set for each measurement sequence. A negative/positive result displays on the screen at the completion of the measurement.

Follow this procedure:

1. In **Spot Check** mode, select the **Main Menu** quick key → from the **System** column select **Maintenance** → input the required password → select  → **Module**.
2. Under **Evaluation Criterion**, select **Position** and then a measurement sequence.
Then select  to edit an existing criterion or **Add Criterion** to create a new one.
3. Set the **Parameter, Type, Threshold**, and select **With Symptoms** to set whether to include symptoms in the criterion.
4. Select **Save**.

9.11 Assisting Venous Puncture

You can use the NIBP cuff to cause sub-diastolic pressure to block the venous blood vessel and therefore help venous puncture. To assist venous puncture, follow this procedure:

1. In **Continuous Monitoring** mode, select the NIBP numeric area to enter the **NIBP** dialog. In **Spot Check** mode, select the **Main Menu** quick key → from the **Parameters** column select **Setup** → select **NIBP**.

2. Set **Venipuncture Pressure**.
3. Select **Venipuncture** at the bottom of the dialog.
4. Puncture vein and draw blood sample.
5. Select **Venipuncture** again to deflate the cuff. If the cuff is not manually deflated, the cuff automatically deflates after a fixed period of time (170 seconds for adult and pediatric patient, 85 seconds for neonatal patient).

During venous puncture, pay attention to the cuff pressure and the remaining time displayed in the NIBP numerics area.

NOTE

- **This function is not available on VS 8A monitors.**
-

9.12 NIBP Troubleshooting

This section lists the problems that might occur. If you encounter the problems when using the equipment or accessories, check the table below before requesting for services. If the problem persists, contact your service personnel.

NOTE

- **For the physiological and technical alarm messages, see Appendix D Alarm Messages.**
-

Problem	Solution
Cannot see NIBP numeric area on the main screen	Check that the NIBP is set to display in the Edit Workflow menu. For more information, see 3.9.1.2 <i>Setting the Screen Layout</i> .

10 Monitoring Respiration

10.1 RR Display

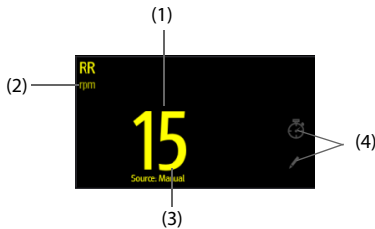

The RR parameter area displays its source.



- (1) RR: Respiration rate per minute
- (2) RR unit
- (3) RR Source
- (4) Select to manually input RR value

10.2 Manually Inputting RR Value

To manually input an RR value, follow this procedure:

1. Select  in the Resp area. A 60s timer is displayed and starts counting seconds.
2. Count the total number of Resp of the patient in the past minute.
3. Input the number and select .
4. Select the **Save** quick key to save the data.

10.3 Setting Timer Interval

A timer is provided when manually inputting RR value. A reminder is given at a set interval to assist in counting of Resp number. To set the timer reminding interval for manual RR, follow this procedure:

1. Select the **Main Menu** quick key → from the **Configuration** column select **Workflow** → input the required password → select .

2. Select  on the right of the workflow to be set.
3. Select **Parameters Setup** → **RR** tab.
4. Set **Timer Reminder Interval** as needed.

11 Manual Parameters

The monitor supports inputting physiological information of a patient manually for clinical evaluation and record. The information can be saved for future reviewing, printing, or sending to other devices.

11.1 Manual Input Parameters

Below is a list of manual parameters provided by default:

- Blood Sugar
- Height
- Weight
- FiO₂
- O₂ Flow Rate
- I/O Fluid
- LOC (GCS)
- LOC (AVPU)
- O₂ Source
- LOC (ACVPU)
- Supp. O₂

You can also add new types of parameters to the list. For details, refer to *16.8.4 Adding a New Manual Parameter*.

11.2 The Manual Input Display

The following figure shows the manual input area. Your display may be configured to look different.

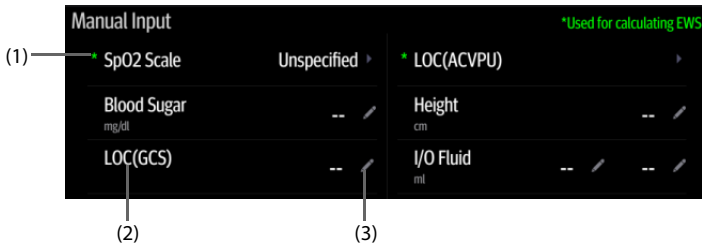



- (1) * symbol: indicates the parameter can be used for EWS calculation.
- (2) Parameter name
- (3) Parameter setup area: select to input a value, show the options, or a setup menu.

If you need to change the parameters to be displayed or their sequence in the list, refer to 11.4 *Changing the Display of Manual Parameters*.

11.3 Inputting/Editing Parameter Information

Follow this procedure:

1. Select a parameter in the list, and input the information as instructed below:
 - ◆  : input a value with the popup on-screen keyboard, or set the parameter in the displayed menu.
 - ◆  : select an option from the popup list.
 - ◆ The range or options of the parameters are shown below:

Parameter	Range
Blood Sugar	1.0 mg/dl -720.0 mg/dl (0.06 mmol/L -40.00 mmol/L)
Height	20.0 cm - 300.0 cm
Weight	0.1 kg -499.0 kg
FiO ₂	21% ~100%
O ₂ Flow Rate	0.1 L/min -20.0 L/min
I/O Fluid	1-10000 ml 0.001 - 10.000 L
LOC (GCS)	3-15
LOC (AVPU)	Alert, Reacting to voice, Reacting to pain, Unresponsive
O ₂ Source	Room Air, Aerosol Mask, Bi PAP, C PAP, Face Mask, Mask, Bnasal Cannula, Nonrebreather, Partial Rebreather, T-piece, Trach Collar, Ventilator, Venturi Mask, Oxymizer
LOC (ACVPU)	Alert, Confusion, Reacting to voice, Reacting to pain, Unresponsive
Supp. O ₂	Yes, No



2. Select the **Save** quick key to save the data.

NOTE

- **The input information can be reviewed, printed or sent to other devices only after being saved. If not saved, the information may be lost after a patient is discharged or workflow is switched.**
-

11.4 Changing the Display of Manual Parameters

To change the parameters to be displayed or their sequence in the list, follow this procedure:

1. Select the **Main Menu** quick key → from the **Configuration** column select **Workflow** → input the required password → select .
2. Select the  on the right of the workflow to be set. Select an area and from the popup list, select **Manual Param.**
3. Select **Parameters Setup** → **Manual Input** tab. Then select an item and from the popup list, select the parameter to be displayed.
4. Return to the main screen and switch workflows for the setting to take effect.

This page intentionally left blank.

12 Clinical Assistive Applications (CAA)

The Clinical Assistive Applications (CAA) function integrates some commonly used clinical guidelines and tools into the monitor. It puts the currently monitoring parameter measurements together and provides comprehensive analysis results.

CAA can improve the clinician's working efficiency. However, it is not directly used for diagnosis and cannot not replace the clinician's judgement.

12.1 Early Warning Score (EWS)

The Early Warning Scores (EWS) can help you recognize the early sign of deterioration in patients based on vital signs and clinical observations. It is based on the "Royal College of Physicians (2015) National Early Warning Score (NEWS2): Standardizing the assessment of acute illness severity in the NHS, Report of a Working Party. RCP, London. Depending on the score calculated, appropriate recommendations are displayed.

The monitor supports the following scores:

- MEWS (Modified Early Warning Score)
- NEWS (National Early Warning Score)
- NEWS2 (National Early Warning Score 2)
- Custom Score

Custom Score is based on user-defined parameters. It can be a total score or an IPS, depending on the configuration.

A subscore is given for each parameter based on the measured or entered value. When all the required parameters are entered or measured, the subscores are added together to calculate the total early warning score. Each subscore has a color coding to indicate associated level of risk. When the total score is outside of the thresholds, actions are recommended. MEWS, NEWS and NEWS2 can give total scores.

MEWS, NEWS and NEWS2 are intended for adult patients only. The patient category applied to the Custom Score is defined by Mindray Clinical Score Configuration Tool. For more information, see *Mindray Clinical Scoring Config Tool Instruction for Use (P/N: 046-012986-00)*.

WARNING

- **EWS is not intended for pediatric and neonatal patients.**
- **The EWS scores and recommended actions are for reference only and cannot be directly used for diagnostic interpretation.**

- **EWS cannot be used as an prognosis index. It is not a clinical judgement tool. Clinicians must use their clinical judgement in conjunction with the EWS tool at all times.**
- **MEWS and NEWS are intended for adult patients only. NEWS is not applicable to pregnant woman and COPD (Chronic Obstructive Pulmonary Disease) patients.**

12.1.1 The EWS Display

The following figure shows the EWS screen.

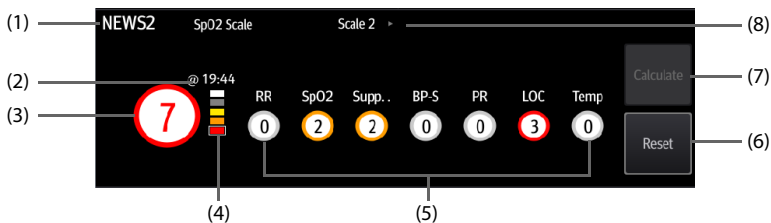

- (1) EWS protocol label
- (2) The scoring time
- (3) Total score. The color of the circle indicates the level of risk.
- (4) Risk level indicator. The level of risk increases from top down. The current level is enclosed by a white square frame.
- (5) Subscore area: displays the subscore of each parameter.
- (6) Reset: select this button to clear the previous score.
- (7) Calculate: select this button to calculate the total score. It is available when all parameter values used for scoring are obtained automatically.
- (8) SpO₂ scale (for NEWS2 only): displays the current SpO₂ scale used for scoring. Select this area to change to another scale.

12.1.2 Accessing the EWS Screen

Access the **EWS** window in any of the following ways:

- Select the **EWS** parameter area
- Select the **Main Menu** quick key → from the **CAA** column select **EWS**.

Take NEWS2 as an example, the EWS screen is shown as follows. Your screen may be slightly different due to the configuration.

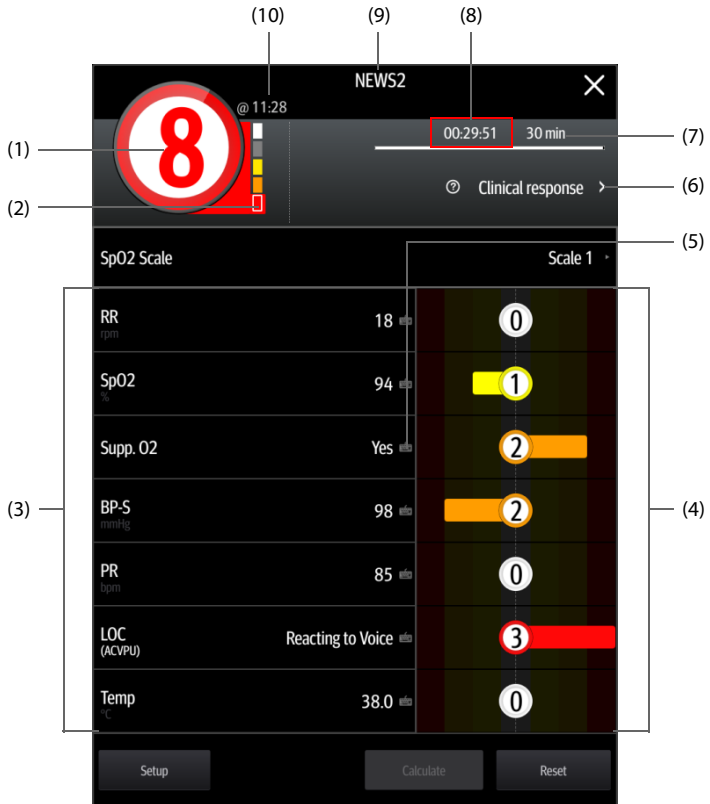

- (1) Total score. The color of the circle indicates the level of risk.
- (2) Risk level indicator. The level of risk increases from top down. The current level is enclosed by a white frame.
- (3) Parameter area: display the value of each parameter.
- (4) Subscore area: display the subscore of each parameter.
- (5) Keyboard symbol: indicates that the value is manually entered.
- (6) Select this button to see the clinical response to the current score.
- (7) Scoring interval
- (8) Scoring countdown: time to the next scoring.
- (9) EWS protocol label
- (10) The scoring time

12.1.3 Performing EWS Scoring

CAUTION

- **The decision to use Scale 2 of the SpO2 Scale should be made by a competent clinical decision maker and should be recorded in the patient's clinical notes.**
-

NOTE

- **Before calculating the score, select Reset to clear the previous score.**
 - **The keyboard symbol at the right of the parameter value indicates that the value is manually entered.**
 - **You can get the score only when all required parameters have been measured or entered.**
-

To perform scoring, follow this procedure:

1. Select **Reset** to clear the previous score and update values of currently monitored parameters and relevant subscores.
2. For NEWS2, set the **SpO2 Scale**.
 - ◆ **Scale 1:** for patient without hypercapnic respiratory failure.
 - ◆ **Scale 2:** for patients with a prescribed oxygen saturation requirement of 88–92% (for example, in patients with hypercapnic respiratory failure).
3. Measure or manually enter other required parameters and observations.
4. Select **Calculate** to get the total score.
5. If **Score Confirmation** is enabled, select **Confirm** to save current scoring, or select **Cancel** to give up current scoring. Refer to section 12.1.7.2 *Setting the Score Confirmation Switch* for more information.

12.1.4 Enabling Auto Scoring

In **Continuous Monitoring** mode, the monitor automatically starts scoring at the preset interval. To enable auto scoring, follow this procedure:

1. From the EWS page select **Setup**.
2. Set **Auto Scoring**:
 - ◆ **Interval:** the monitor automatically starts scoring at the preset interval.
 - ◆ **NIBP:** the monitor automatically starts scoring at the completion of each NIBP measurement.
 - ◆ **Alarm:** the monitor automatically starts scoring when an alarm occurs to the parameter for scoring.
 - ◆ If no option is selected, the monitor does not initiate auto scoring.

12.1.5 Setting Auto Scoring Interval

In **Continuous Monitoring** mode, you can set the auto scoring interval. Follow this procedure:

1. From the EWS page select **Setup**.
2. Set **Interval**:
 - ◆ **By Score**: the monitor automatically starts scoring as per the interval selected for corresponding total score.
 - ◆ **5 min - 24 hrs**: If **Auto Scoring** is set to **Interval**, the monitor automatically starts scoring as per the selected interval. If **Auto Scoring** is not set to **Interval**, the countdown timer of manual scoring is selected.
 - ◆ **Off**: the monitor does not automatically start scoring.

12.1.6 EWS Alarm

When working under **Continuous Monitoring** mode, if alarms are enabled, the monitor automatically gives alarms and refreshes the score.

12.1.6.1 Setting the EWS Alarm

In **Continuous Monitoring** mode, if **Alarm** is enabled, the monitor can automatically give alarms in the following cases:

- The total score exceeds the configured threshold
- The score of auto obtained parameter is 3.

To configure the EWS alarm, follow this procedure:

1. From the EWS page select **Setup**.
2. Select the **Alarm** tab.
3. Turn on the **Alarm** switch.
4. Set the alarm switches for the single parameters listed in the **3 in single parameter** area.
5. Set the alarm switch and threshold of the total score in the **EWS Score** area.

12.1.6.2 Auto Refreshing Scores

If **Auto Refresh Scores** is enabled, the monitor can automatically refresh the total score in the following cases:

- The total score reaches the configured threshold, or falls from the configured threshold to a lower score.
- The score of auto obtained parameter reaches 3, or falls from 3 to a lower score.

To enable the auto refreshing score function, follow this procedure:

1. From the EWS page select **Setup**.

2. Select the **Alarm** tab.
3. Turn on the **Auto Refresh Scores** switch.

12.1.7 Changing EWS Settings

12.1.7.1 Changing the Scoring Protocol

The monitor is configured with a default scoring protocol. To change the scoring protocol, follow this procedure:

1. From the EWS page select **Setup**.
2. Set **Score**.

12.1.7.2 Setting the Score Confirmation Switch

In **Continuous Monitoring** mode, you can select if confirmation is required before saving score. Follow this procedure:

1. From the EWS screen select **Setup**.
2. Set **Score Confirmation** switch.
 - ◆ **Off:** the monitor automatically saves the scoring result after the scoring is completed.
 - ◆ **On:** you need to confirm that whether the scoring result is saved or not after the scoring is completed.

12.1.7.3 Setting the Manual Data Timeout

The manually input parameter data can be configured become invalid after a preset time. To set the timeout period for the input data, follow this procedure:

1. From the EWS screen select **Setup**.
2. From the **Manual Data Timeout** area, select a desired parameter and set its timeout period.

NOTE

- **If the data is expired and not updated, the monitor displays the corresponding parameter score in outline font, and gives a timeout alarm.**
-

12.1.8 Viewing Historical Scores

To view the history scores, follow this procedure:

1. Select the **Review** quick key → select **Scoring Review** tab.
2. Select **PID** and from the popup list select the ID of which the scores are to be viewed.
3. Select Filter and choose a protocol if needed.

4. Select a record and then select **Detail**.

12.1.8.1 Managing the Scoring Tools

To manage the scoring tool, follow this procedure:

1. Select the **Main Menu** quick key → from the **System** column select **Maintenance** → input the required password → select .
2. Select the **CAA** tab → select **EWS** tab.
3. Select **Manage Score**.
 - ◆ Delete local scoring tools: from the **Local** page, delete the unnecessary scoring tools.
 - ◆ Import the desired scoring tools to the monitor: connect a USB drive to the monitor's USB port. From the **USB Drive** page, select the scoring tools on the USB drive, and then select **Import**.

NOTE

- **The monitor provides MEWS, NEWS, and NEWS2 by default. You cannot delete them.**
 - **For details about how to import scoring tools, refer to *Mindray Clinical Scoring Config Tool Instruction for Use (P/N: 046-012986-00)*.**
-

12.2 Glasgow Coma Scale (GCS)

The Glasgow Coma Scale (GCS) function is based on Teasdale's *Assessment of Coma and Impaired Consciousness-A Practical Scale (Lancet, 1974)*. Three aspects of behavior are independently measured: eye opening, verbal response, and motor response. The scores are added together to indicate that patient's level of consciousness.

GCS is intended for adults and pediatric patients.

CAUTION

- **GCS is intended as an adjunct in patient assessment and must be used in conjunction with observation of clinical signs and symptoms.**
 - **GCS is not applied to patients that are sedated, muscularly relaxed, with artificial airway, drunk, or in status epilepsies.**
 - **GCS is not applied to deaf people and patients having language barrier or with mental disorder.**
 - **When applied to children younger than five years old or the elderly, the GCS score may not reflect actual function.**
-

12.2.1 GCS Display

The GCS value displays in the Manual Input list, as shown below:

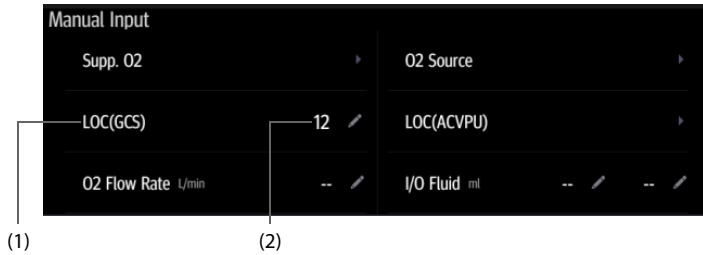

- (1) GCS label
- (2) GCS value: total score. Select this area to enter the GCS dialog.

Your display may look slightly different. If GCS is not displayed, you can follow the procedure in *11.4 Changing the Display of Manual Parameters* to add GCS to the list.

12.2.2 Accessing the GCS Dialog

Select the GCS value to enter the GCS dialog.

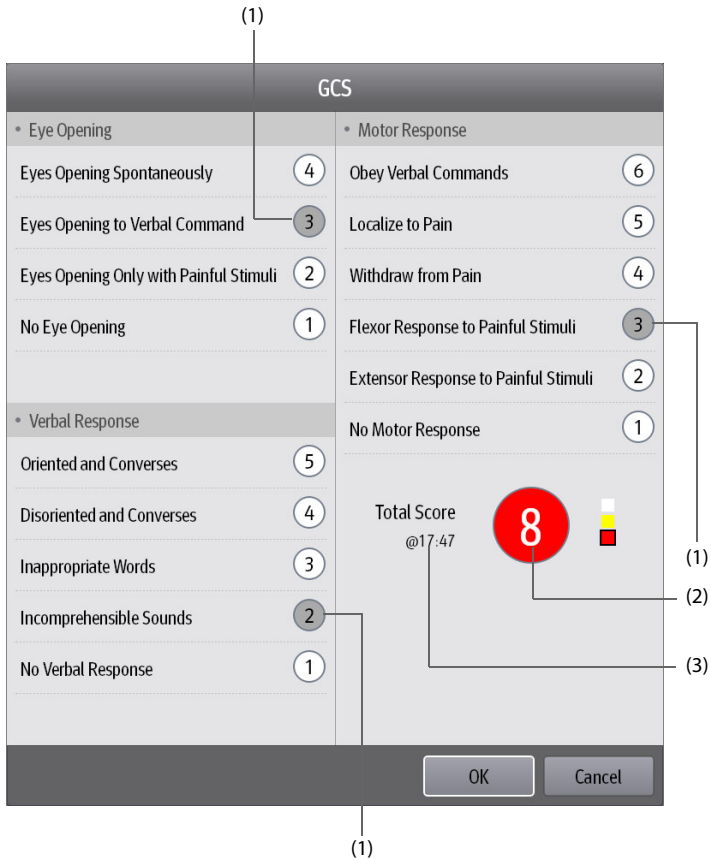

- (1) Subscores
- (2) Total score. The color of the circle indicates the level of risk.
- (3) Scoring time

12.2.3 Performing GCS Scoring

To perform scoring, follow this procedure:

1. From the **Eye Opening** area, **Verbal Response** area, and **Motor Response** area, respectively select an item that represents the patient's status.

2. Select **OK** to accept the total score.
3. Select the **Save** quick key to save GCS scoring.

The following table lists the default score range and color of relevant consciousness level.

Level	Range	Color
Mild damage	13 to 15	White
Moderate damage	9 to 12	Yellow
Severe damage	3 to 8	Red

NOTE

- **The GCS score range is adjustable. Refer to 16.7.3 Setting GCS Threshold for Each Consciousness Level for the method of changing the high limit and low limit of each consciousness level.**

12.2.4 Reviewing GCS Data

If the GCS data is correctly saved, you can review the GCS data following this procedure:

1. Select the **Review** quick key → select **Scoring Review** tab.
2. Select a record from the list, and then select **Detail**.
3. Check the **LOC(GCS)** value.

12.3 Pain Score

The monitor provides pain score functions to help assess a patient's pain. The following scales are provided by default:

- VAS-cm: a visual analog scale of 0 to 10 cm.
- VAS-mm: a visual analog scale of 0 to 100 mm.
- NRS: a numeric rating scale, using numbers to rate the pain.
- VRS-5: a verbal rating scale of 0 to 5.
- FPS-R: face pain scale revised.
- FLACC: stands for face, legs, activity, crying, and consolability.

You can also add custom pain scores to the list. For details, refer to 16.8.5.2 *Adding a Custom Pain Scale*.

Pain Score is applicable for adult, pediatric, and neonatal patients.

12.3.1 The Pain Score Display

The following figure shows the pain score screen. Your display may be configured to look different.

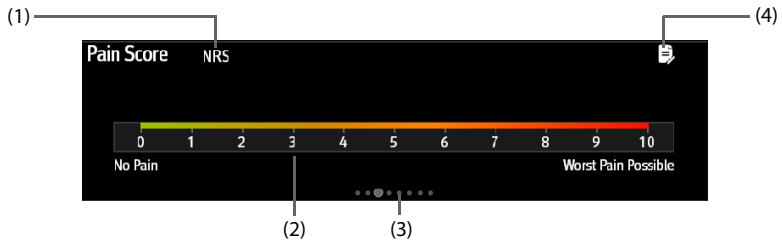

- (1) The name of currently used pain scale
- (2) Scoring area: selecting this area to select a value or an option from the popup list for total scoring.
- (3) Indicating the number of pain scales currently selectable
- (4) Adding pain description

12.3.2 Performing Pain Score

Follow this procedure:

1. Swipe on the **Pain Score** screen to the left or right to select a pain scale.
2. Set the pain description if needed.
3. Tap the scoring area to select a value or an option for scoring.
4. Select the **Save** quick key to save the data.

12.4 Targeted Goal

For patients under continuous monitoring, if you are concerned with specific parameters and their trends, you can use the **Targeted Goal** screen. The **Targeted Goal** screen focuses on the target parameter and displays parameter measurements in big numerics. You can easily identify whether parameter target is reached via a dashboard and review the statistics of the target parameter by sections.

The **Targeted Goal** screen displays parameter measurements and waveforms of SpO₂, PI, PR, NIBP, and Temp. The measurements of these parameters displays in big numerics.

12.4.1 Entering the Targeted Goal Screen

To enter the **Targeted Goal** screen, in **Continuous Monitoring** mode, select **Targeted Goal** quick key.

12.4.2 The Display of the Targeted Goal Screen

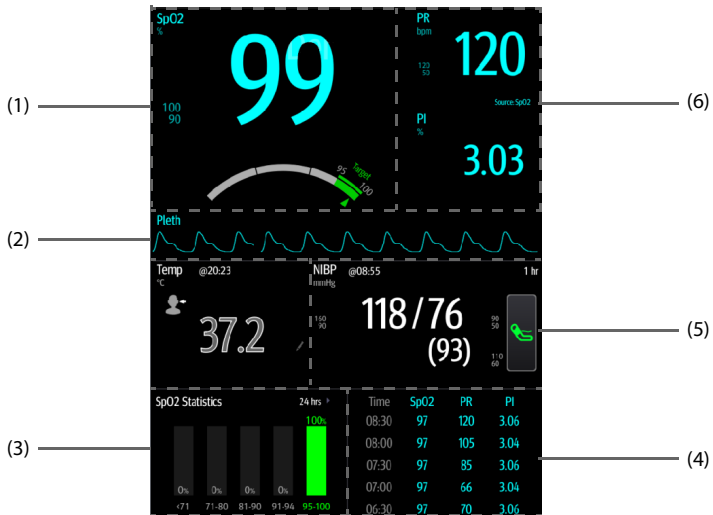

- (1) Target parameter area: displays the SpO₂ measurement in big numerics, as well as its target range, and alarm limits.
 - The dashboard shows the target range in green.
 - The Δ pointer below the dashboard indicates the current measurement value.
- (2) Target parameter waveform area: displays the SpO₂ waveform.
- (3) Target parameter statistics area: displays the SpO₂ statistics by sections.
- (4) Parameter trends area: displays trends of the target parameter and secondary parameters.
- (5) Other parameter area: displays parameter measurements and alarm limits of parameters other than the target parameter and secondary parameters.
- (6) Secondary parameters area: displays parameter measurement of PR and PI in big numerics, as well as parameter sources and alarm limits.

12.4.3 Operating the Targeted Goal Screen

You can access parameter setup and trends review from the **Targeted Goal** screen.

- Select the parameter trends area to enter the **Tabular Trends** review page.
- Select the target parameter statistics area to enter the parameter statistics setup menu. Set the range of each section and the target section.
- Select the desired waveform area, parameter numeric area, or dashboard to enter corresponding parameter setup menu.

12.4.3.1 SpO₂ Statistics Display

The following figure shows the SpO₂ statistics area:

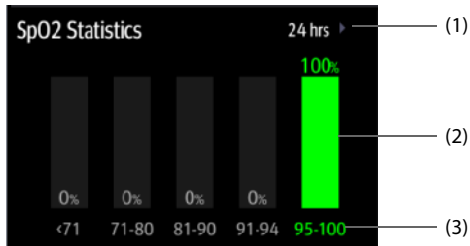

- (1) Duration of SpO₂ statistics
- (2) Results of SpO₂ statistics
- (3) Sections for statistics: The section in green indicates the target range.

12.4.3.2 Selecting the Range of each SpO₂ Section and the Target Section

To define the SpO₂ range of each section, follow this procedure:

1. Select the SpO₂ statistics area.
2. Select a value on the left of the scale.
3. Use the keyboard on the right to change the value.
4. Drag the section label on the right of the scale up or down to select a target section. The target section is highlighted in green in the SpO₂ statistics area.

12.4.3.3 Selecting the SpO₂ Statistics Length

The Duration of SpO₂ statistics is configurable. From the SpO₂ statistics area, select the duration to redefine the length of SpO₂ statistics.

This page intentionally left blank.

13 Recording

13.1 Recorder

The thermal recorder records patient information, measurement data, and up to two waveforms. The monitor can be configured with a built-in recorder.

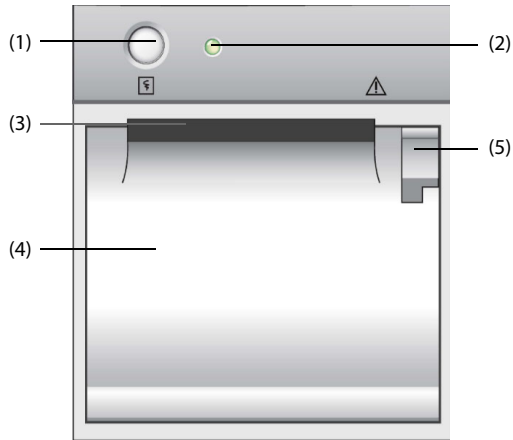



- (1) Start/Stop key: press to start a recording or stop the current recording.
- (2) Module status indicator
 - On: when the recorder is powered and ready for use.
 - Off: when the monitor is switched off.
 - Flashes: if an error has occurred with the recorder.
- (3) Paper outlet
- (4) Recorder door
- (5) Latch: pull it away from the recorder to open the recorder door.

13.2 Starting Recordings

Recordings can be started manually.

In **Continuous Monitoring** mode, to start a recording, you can either:

- Press the  hardkey on the front of the recorder.

- Select  on the current page.

In **Spot Check** mode, to start a recording:

1. Select the **Save** quick key.
2. Select  on the current page.

13.3 Stopping Recordings

Recordings can be stopped manually or automatically.

13.3.1 Stopping Recordings Manually

To manually stop a recording, choose either of the following method:

- Press the  hardkey again.
- Select the **Main Menu** quick key → from the **Device** column select **Record Setup**, and then select **Clear All Record Tasks**.

13.3.2 Stopping Recordings Automatically

Recordings stop automatically in the following conditions:

- The recording is completed.
- The recorder runs out of paper.
- The recorder has an alarm condition.
- The monitor is turned off.

13.4 Recording Related Flags

You can find the following flags on the recording reports:

- For automatically stopped recordings, there are two columns of asterisks "*" at the end of the report.
- For manually or abnormally stopped recordings, there is one column of asterisks "*" at the end of the report.

13.5 Setting up the Recorder

To configure the recorder, follow this procedure:

1. Select the **Main Menu** quick key → from the **Device** column select **Record Setup**.
2. In the **Record Setup** menu, select the desired waveform for **Waveform 1** and **Waveform 2** in turn. The recorder can record up to 2 waveforms at a time.
3. Select **Recording Duration** to set the duration of real-time recording.
4. Select **Recorder Paper Speed** to set the speed for recording waveforms.

13.6 Clearing Recording Tasks

To clear recording tasks, follow this procedure:

1. Select the **Main Menu** quick key → from the **Device** column select **Record Setup**.
2. In the **Record Setup** menu, select **Clear All Record Tasks**. This clears all queued recording tasks and stops the current recording.

13.7 Loading Paper

To load paper, follow this procedure:

1. Use the latch at the upper right of the recorder door to pull the door open.
2. Insert a new roll into the compartment as shown below. Feed the paper through and pull some paper out from the top of the roller.
3. Close the recorder door.

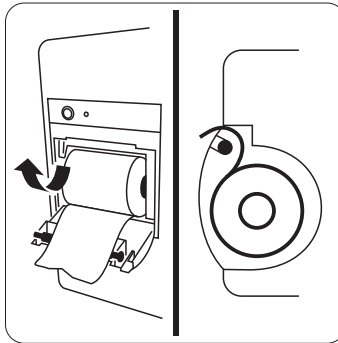

CAUTION

- Use only specified thermal paper. Otherwise, it may cause damage to the recorder's printhead, the recorder may be unable to print, or poor print quality may result.
 - Never pull the recorder paper with force when a recording is in process. Otherwise, it may cause damage to the recorder.
 - Do not leave the recorder door open unless you are reloading paper or cleaning a paper jam.
-

13.8 Removing Paper Jam

If the recorder works incorrectly or produces unusual sounds, check if there is a paper jam. If a paper jam is detected, follow this procedure to remove it:

1. Open the recorder door.
2. Take out the paper and tear off the draped part.
3. Reload the paper and close the recorder door.

13.9 List of Recording Reports

The recorder can output the following reports:

- Realtime reports
 - ◆ Realtime Segment Waveform Record (**Continuous Monitoring**)
- History reports
 - ◆ Spotcheck Record
 - ◆ EWS Record
 - ◆ Tabular Trend Report
 - ◆ Graphic Trend Report

14 Review

14.1 Review Overview

Trends are patient data collected over time and displayed in graphic, tabular, or other forms to give you a picture of how the patient's condition is developing. The **Review** dialog also enables access to review the events, scores, and so on.

14.2 Review Dialog

The **Review** dialog contains tabs to display trend data in tabular, graphic, or other forms.





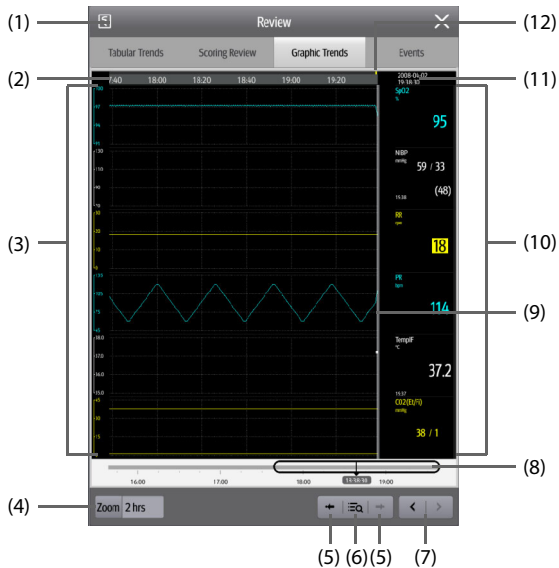

14.2.1 Accessing the Review Dialog

To enter the review dialog, select the **Review** quick key.

14.2.2 Example Review Dialog

The review dialogs have similar structure. The graphic trends review dialog is taken as an example:



- (1) Record button: select it to output patient information and data through the recorder.
- (2) Current window time line: indicates the time length of the current screen.
- (3) Waveform area: displays trend curves. The color of trend curves is consistent with the color of parameter labels.
- (4) Zoom: select the time duration of data to be viewed on one screen.
- (5)  or  : goes to the previous or next event.
- (6)  : displays events in a chronological order. The most recent event is displayed at the top. The number of exclamation marks before an event indicates alarm priority.
- (7)  or  : moves the cursor backward or forward
- (8)  : indicates the position of current screen time in the entire time length. Dragging the slider left or right enables you to locate the trend data at a specific time and also refreshes data in current window accordingly.
- (9) Cursor
- (10) Numeric area: displays numeric values at the cursor indicated time. The background color of numeric values indicates the alarm priority.
- (11) Event area: displays the event of the cursor time. Selecting the event accesses the event list. If there is no event at the cursor time, the cursor time is displayed.
- (12) Event type indicator: different color blocks match different types of events:
 - Red: high priority alarm event
 - Yellow: medium priority alarm event
 - Cyan: low priority alarm event
 - White: operation-related event

14.2.3 Reviewing the Tabular Trends

The **Tabular Trends** review dialog displays trend data in a tabular form. You can select a patient and trends of a certain period or type to be viewed. Follow this procedure:

1. Select the **Review** quick key → select **Tabular Trends** tab.
2. Set the filtering condition to **PID, Name, or Visit No.**. Then select the information of the patient to be viewed.
3. Set **Filter** to a period of time (30 seconds to 3 hours selectable), a parameter (Temp, Scoring etc.) or type of data (**Manually Saved** for example).
4. Select a record to be viewed and select **Detail** to check more information.

14.2.4 Reviewing Scores

The **Scoring Review** dialog displays scores in a tabular form. You can select a patient and a certain scoring protocol to be viewed. Follow this procedure:

1. Select the **Review** quick key → select **Scoring Review** tab.
2. Set the filtering condition to **PID, Name, or Visit No.**. Then select the information of the patient to be viewed.
3. Set **Filter** to **MEWS, NEWS** or **NEWS2**.
4. Select a record to be viewed and select **Detail** to check more information.

14.2.5 Reviewing the Graphics Trends

The **Graphic Trends** review dialog displays trend data in a visual form. To review the **Graphic Trends**, follow this procedure:

1. Select the **Review** quick key → select **Graphic Trends** tab.
2. Select **Zoom** to set the period of data to be displayed on one screen.
3. Move the slider  to the left or right to browse more trend data.

14.2.6 Reviewing Events

The monitor stores events in real time, including technical alarm events, physiological alarm events, and operational events. When an event occurs, all the measurement numerics and three event-related waveforms 16 seconds before and after the event are stored.

NOTE

- **Alarms are saved as events and will be maintained if the equipment is powered down. The time of equipment power down is not recorded as an event and cannot be reviewed.**
 - **Earlier events will be overwritten by later ones if the storage capacity is reached.**
 - **A total loss of power does not affect the events already stored.**
-

14.2.6.1 Viewing the Events Dialog

To enter the events review dialog, select **Review** quick key → select **Events** tab.

The **Events** dialog displays event list. Events are displayed in descending chronological order, with the most recent displayed at the top. The number of exclamation marks before an event indicates alarm priority as described in 5.3.3 *Alarm Indicators*.

Different color blocks are displayed on the left of each event to indicate different event types.

- Red: high priority alarm event

- Yellow: medium priority alarm event
- Cyan: low priority alarm event
- White: operation-related event

You can view operation events not related to parameters, such as system time change.

The number of currently selected events and the total number of events are displayed at the top right corner of the event list. For example, 2/4 indicates that the selected event is the second event in the events and the total number of events is 4.

NOTE



- **Pausing or switching off alarms will not be recorded as events. The time of these operations will not be recorded in the system log.**
-

14.2.6.2 Viewing Event Details

To view waveforms and parameter values at the event time, follow this procedure:

1. Select **Review** quick key → select **Events** tab.
2. Select an event to be viewed, and then select **Detail**.

On the **Detail** page, you can also view the details of other events by either:

- Selecting  and then the desired event.
- Selecting  or  to view the previous or next event.

15 Managing Configurations

15.1 Configuration Introduction

When performing measurement or continuously monitoring on a patient, the clinical professional often needs to adjust the monitor's settings according to the patient's condition. The collection of all these settings is called a configuration. The system configuration items can be classified as: parameter configuration items, conventional configuration items, and user maintenance items. Allowing you to configure the monitor more efficiently, the monitor provides different sets of configurations to accommodate the varying patient categories and departments. You can change some settings from a certain set of configuration and then save the changed configuration as a user configuration.

The default configurations provided for your monitor are department-oriented. You can choose any of the following department:

- **Med-surg**
- **Emergency Department**
- **Physician Office**
- **Ambulatory Surgery Center**

WARNING

- **The configuration management function is password protected. The configuration management tasks must be performed by clinical professionals.**
-

15.2 Changing the Department

If the current department configuration is not the one you want to view, you can change the department by following this procedure:

1. Select the **Main Menu** quick key → from the **Configuration** column select **Manage** → input the required password → select .
2. Select **Department Type**.
3. Select a department.
4. Select **OK**.

CAUTION

- **Changing the department will delete all current user configurations.**
-

15.3 Setting Default Patient Category

To set the default patient category when admitting a new patient, follow this procedure:

1. Select the **Main Menu** quick key → from the **Configuration** column select **Manage** → input the required password → select .
2. Set **Default Patient Category**.

15.4 Setting Workflows

For details, refer to 3.9.1 *Setting the Workflow*.

15.5 Transferring a Configuration

When installing several monitors with identical user configurations, it is not necessary to set each unit separately. Use a USB drive to transfer the configuration from monitor to monitor.

15.5.1 Exporting a Configuration

To export the current monitor's configuration, follow this procedure:

1. Connect a USB drive to the monitor's USB port.
2. Select the **Main Menu** quick key → from the **Configuration** column select **Manage** → input the required password → select .
3. Select **Export Configuration**.
4. Select the workflows and **User Maintenance Settings** to export.
5. Select **Export**.

15.5.2 Importing a Configuration

To import the configuration from the USB drive to the monitor, follow this procedure:

1. Connect the USB drive to the monitor's USB connector.
2. Select the **Main Menu** quick key → from the **Configuration** column select **Manage** → input the required password → select .
3. Select **Import Configuration**.
4. Select the workflows and **User Maintenance Settings** to import.
5. Select **Import**.

15.6 Modifying Configuration Password

To modify the configuration password, follow this procedure:

1. Select the **Main Menu** quick key → from the **Configuration** column select **Manage** → input the required password → select .
2. Select **Modify Password**.
3. Respectively input the old password and new password.
4. Select **OK**.

15.7 Restoring the Latest Configuration Automatically

During operation, you may make changes to some settings. However, these changes may not be saved as user configuration. To prevent the changes from losing in case of a sudden power failure, the equipment stores the configuration in real time. The saved configuration is the latest configuration.

In case of a temporary power failure, if the power is restored within 30 minutes, monitoring will resume with all active settings unchanged; if the monitor is without power for more than 30 minutes, the monitor behaves the same as it is normally turned off.

This page intentionally left blank.

16 Password-protected User Settings

This chapter describes the password-protected functions accessed in the **Maintenance** dialog.

16.1 Setting the Device Location

16.1.1 Setting Monitor Information

To set monitor information, follow this procedure:

1. Select the **Main Menu** quick key → from the **System** column select **Maintenance** → input the required password → select . The **Device Location** tab is displayed.
2. Input the **Monitor Name, Facility, Department, Room No, Bed No.**

16.1.2 Setting Monitor Location

To better locate and manage the monitor, you can set the location information. Follow this procedure:

1. Select the **Main Menu** quick key → from the **System** column select **Maintenance** → input the required password → select . The **Device Location** tab is displayed.
2. Set **Location**.
 - ◆ **Fixed:** the **Patient Management** menu displays **Bed No** and **Room No**, but you cannot change them. If your monitor is installed at a fixed position, or you do not need to frequently change the room number and bed number, set **Location** to **Fixed**.
 - ◆ **Unfixed:** you can change **Bed No** and **Room No** from the **Patient Management** menu. If **Location** is set to **Unfixed**, **Bed No** and **Room No** are cleared each time you discharge a patient.

16.1.3 Enabling the Auto Obtain Bed Number Function

If the monitor is connected to the wired network, the monitor can automatically set the patient's bed number according to the bed number information bonded to the bedside network connector.

To enable this function, follow this procedure:

1. Select the **Main Menu** quick key → from the **System** column select **Maintenance** → input the required password → select . The **Device Location** tab is displayed.
2. Select **Unfixed**.
3. Switch on **Auto Obtain Bed No.**

NOTE

- **The Auto Obtain Bed Number function is available only when the switch connected to the monitor supports the LLDP or CDP protocol, and the corresponding protocol is enabled.**
-

16.2 Changing Patient Management Settings

16.2.1 Selecting Displayed Patient Information

You can define which items can be displayed and edited from the **Patient Management** tab. To do so, follow this procedure:

1. Select the **Main Menu** quick key → from the **System** column select **Maintenance** → input the required password → select .
2. Select the **Patient Management** tab.
3. Select the fields you want to display in the **Patient Management** dialog.
4. If necessary, select the customized fields and input names for these fields.

NOTE

- **If the monitor is connected with the CMS, the patient information items and customized fields are loaded from the CMS.**
-

16.2.2 Selecting Query Criteria for Searching Patients in ADT Server

You can define which criteria can be used to search patients in the ADT server. To do so, follow this procedure:

1. Select the **Main Menu** quick key → from the **System** column select **Maintenance** → input the required password → select .
2. Select the **Patient Management** tab → **ADT Query** tab.
3. Select the query criteria as desired.

16.2.3 Auto Discharging a Patient after Monitor Power Off

For patients under **Continuous Monitoring** mode, you can set the monitor to automatically discharge a patient upon startup after being switched off for a period of time. To do so, follow this procedure:

1. Select the **Main Menu** quick key → from the **System** column select **Maintenance** → input the required password → select .
2. Select the **Patient Management** tab → **Discharge** tab.
3. Select a time for **Auto Discharge When Power Off**. The monitor will automatically discharge the patient at next startup after being switched off for the selected period of time. The default is **Never**. That is to say the monitor will not discharge a patient upon startup, regardless of how long the monitor has been switched off.

16.2.4 Auto Deleting Patient Data after Discharging a Patient

You can let the monitor automatically delete patient data after discharging a patient. To do so, follow this procedure:

1. Select the **Main Menu** quick key → from the **System** column select **Maintenance** → input the required password → select .
2. Select the **Patient Management** tab → **Discharge** tab.
3. Set **Auto Delete Patient Data if Discharged**.
 - ◆ **Right Now**: deletes patient data as soon as the patient is discharged.
 - ◆ **7 days**: deletes discharged patient data seven days after the patient was discharged.
 - ◆ **1 Month**: deletes discharged patient data one month after the patient was discharged.
 - ◆ **Auto**: patient data is not deleted when the patient is discharged. The oldest discharged patient data will be deleted when the storage space of the monitor is full.

16.2.5 Clearing All Patient Data

You can delete all patient information and data in the monitor. To do so, follow this procedure:

1. Select the **Main Menu** quick key → from the **System** column select **Maintenance** → input the required password → select .
2. Select the **Patient Management** tab → **Discharge** tab.
3. Select **Clear All Patient Data**.
4. Select **OK**. Select **OK** again for confirmation until a message indicating you that all data is cleared.

CAUTION

- **Clearing patient data will discharge the current patient. Make sure there is no patient is being monitored before you clear all data.**
-

16.2.6 Setting Patient Location Options for the Standby Screen

To set options for patient location, follow this procedure:

1. Select the **Main Menu** quick key → from the **System** column select **Maintenance** → input the required password → select .
2. Select the **Patient Management** tab → **Location** tab.
3. Input or edit patient location options.

16.3 Changing the Authorization Settings

16.3.1 Setting Clinician Login

You can select whether verification or authentication is required for clinician login. To do so, follow this procedure:

1. Select the **Main Menu** quick key → from the **System** column select **Maintenance** → input the required password → select .
2. Select the **Authorization Setup** tab.
3. Set **Clinician Login**.
 - ◆ **No Verification:** no verification is needed for clinician login.
 - ◆ **Clinician Verification:** the user name saved in the MLDAP server is required.
 - ◆ **Clinician Authentication:** the user name and password saved in the MLDAP server are required.
4. Set **Automatic Logout Time** and **Imprivata Domain** as needed.

16.3.2 Selecting Password for User Maintenance

You can select what password is used when accessing the Maintenance dialog. To do so, follow this procedure:

1. Select the **Main Menu** quick key → from the **System** column select **Maintenance** → input the required password → select .
2. Select the **Authorization Setup** tab → **Authorization Setup** tab.
3. From the **Maintenance** area, set **User Maintenance** to select the password for accessing the monitor's **Maintenance** dialog.

- ◆ **Local Password:** the monitor's password for accessing the **Maintenance** dialog is required.
- ◆ **Clinician Authentication:** the user name and password saved in the MLDAP server are required.

You can select **Modify Local Password** to change the monitor's password for accessing the **Maintenance** dialog.

16.3.3 Selecting Password for Changing Alarm settings

You can select what password is used when changing alarm settings, including setting alarm switch, alarm limit, and alarm priority. To do so, follow this procedure:

1. Select the **Main Menu** quick key → from the **System** column select **Maintenance** → input the required password → select .
2. Select the **Authorization Setup** tab → **Authorization Setup** tab.
3. From the **Clinic** area, set **Alarm Setup** to select the password for changing alarm settings.
 - ◆ **No Password:** changing alarm settings is not password protected.
 - ◆ **Local Password:** The monitor's password is required for changing alarm settings.
 - ◆ **Clinician Authentication:** The account and password in the MLDAP are required for changing alarm settings.

If **Alarm Setup** is password protected, you can set **Retention Time** to select the timeout period of password for accessing the alarm settings. If there is no operation after the specified timeout period is reached, you need to re-enter the password.

16.3.4 Selecting Password for Viewing Discharged Patient Data

You can select what password is used when viewing discharged data. To do so, follow this procedure:

1. Select the **Main Menu** quick key → from the **System** column select **Maintenance** → input the required password → select .
2. Select the **Authorization Setup** tab → **Authorization Setup** tab.
3. From the **Clinic** area, set **View Discharged Patients** to select the password for viewing discharged patient data.
 - ◆ **No Password:** no password is required for viewing discharged patient data.
 - ◆ **Clinician Login:** discharged patient data can be viewed only after clinician login succeeds.

16.4 Changing Settings about Saving and Sending Data

16.4.1 Setting Items about Saving Data

16.4.1.1 Setting Confirmation before Saving Physiological Data

You can set the monitor to require confirmation before saving physiological data. To do so, follow this procedure:

1. Select the **Main Menu** quick key → from the **System** column select **Maintenance** → input the required password → select .
2. Select the **Save&Send** tab.
3. Switch on **Confirm Before Saving**.

16.4.1.2 Setting Clinician and Patient Information as Required

You can set clinician and patient information as required for saving physiological data. To do so, follow this procedure:

1. Select the **Main Menu** quick key → from the **System** column select **Maintenance** → input the required password → select .
2. Select the **Save&Send** tab.
3. Switch on **Clinician And Patient info. Required**.

16.4.1.3 Enabling Automatic Sending after Saving Data

You can set the monitor to automatically send the data to preset destination after saving data. To do so, follow this procedure:

1. Select the **Main Menu** quick key → from the **System** column select **Maintenance** → input the required password → select .
2. Select the **Save&Send** tab.
3. Switch on **Send After Saving**.

16.4.1.4 Enabling Automatic Recording after Saving Data

You can set the monitor to automatically record the data after saving data. To do so, follow this procedure:

1. Select the **Main Menu** quick key → from the **System** column select **Maintenance** → input the required password → select .
2. Select the **Save&Send** tab.
3. Switch on **Record After Saving**.

16.4.1.5 Enabling Automatic Logout after Saving Data

You can set the monitor to automatically log out of the clinician account after saving data. To do so, follow this procedure:

1. Select the **Main Menu** quick key → from the **System** column select **Maintenance** → input the required password → select .
2. Select the **Save&Send** tab.
3. Switch on **Log Out After Saving**.

16.4.1.6 Setting whether to Discharge Patient Automatically after Saving Data

You can select whether to automatically discharge the patient after saving data in **Spot Check** mode. To do so, follow this procedure:

1. Select the **Main Menu** quick key → from the **System** column select **Maintenance** → input the required password → select .
2. Select the **Save&Send** tab.
3. Switch on or off **Discharge Patient After Saving**.

16.4.1.7 Setting whether to Automatically Save NIBP Measurements

You can select whether to automatically save the NIBP measurements after NIBP measurement completes. To do so, follow this procedure:

1. Select the **Main Menu** quick key → from the **System** column select **Maintenance** → input the required password → select .
2. Select the **Save&Send** tab.
3. Switch on or off **Auto Save After NIBP Measurement**.

16.4.2 Setting Items about Sending Data

16.4.2.1 Setting Clinician Login as Required for Sending Data

You can set clinician login as required for sending data. To do so, follow this procedure:

1. Select the **Main Menu** quick key → from the **System** column select **Maintenance** → input the required password → select .
2. Select the **Save&Send** tab.
3. Switch on **Clinician Required**.

16.4.2.2 Enabling Clinician Login Verification before Sending Data

You can set the monitor to verify if the clinician login information matches with the information in the database before sending data. To do so, follow this procedure:

1. Select the **Main Menu** quick key → from the **System** column select **Maintenance** → input the required password → select .
2. Select the **Save&Send** tab.
3. Switch on **Clinician Match Required**.

16.4.2.3 Setting whether to Automatically Clear Sent Data

You can select whether to clear the sent data after it is sent successfully. To do so, follow this procedure:

1. Select the **Main Menu** quick key → from the **System** column select **Maintenance** → input the required password → select .
2. Select the **Save&Send** tab.
3. Switch on or off **Clear Sent Data After Sending**.

16.4.2.4 Setting whether to Automatically Clear Local Patient List

You can select whether to clear the patient list saved on the monitor after the sending. To do so, follow this procedure:

1. Select the **Main Menu** quick key → from the **System** column select **Maintenance** → input the required password → select .
2. Select the **Save&Send** tab.
3. Switch on or off **Auto Clear Local Patient List**.

16.5 Changing the Alarm Settings

16.5.1 Setting Alarm Tone Properties

16.5.1.1 Setting the Minimum Alarm Volume

To set the minimum alarm volume, follow this procedure:

1. Select the **Main Menu** quick key → from the **System** column select **Maintenance** → input the required password → select .
2. Select the **Alarm** tab. The **Audio** tab is displayed.
3. Set **Minimum Alarm Volume**.

16.5.1.2 Setting the Interval between Alarm Sounds

If you choose the ISO pattern, you can change the interval between alarm tones. To change the interval between alarm tones, follow this procedure:

1. Select the **Main Menu** quick key → from the **System** column select **Maintenance** → input the required password → select .
2. Select the **Alarm** tab. The **Audio** tab is displayed.
3. Set **High Alarm Interval**, **Med Alarm Interval**, and **Low Alarm Interval**.

Item	Range	Default
High Alarm Interval	3 s to 15 s	10 s
Med Alarm Interval	3 s to 30 s	20 s

Item	Range	Default
Med Alarm Interval	16 s to 30 s	20 s

16.5.1.3 Setting Alarm Volume Escalation

The monitor provides the function of automatically escalating the alarm tone volume. When this function is enabled, if an alarm is not reset within the designated delay time after the alarm occurs, the volume of the alarm tone increases automatically.

To set the alarm volume escalation, follow this procedure:

1. Select the **Main Menu** quick key → from the **System** column select **Maintenance** → input the required password → select .
2. Select the **Alarm** tab. The **Audio** tab is displayed.
3. Set **Auto Increase Volume**.
 - ◆ **2 Steps:** if an alarm is not reset within the designated delay time after the alarm occurs, the alarm volume automatically increases by two levels.
 - ◆ **1 Step:** if an alarm is not reset within the designated delay time after the alarm occurs, the alarm volume automatically increases by one level.
 - ◆ **Off:** if an alarm is not reset within the designated delay time after the alarm occurs, the volume of the alarm tone does not change.
4. Select **Increase Volume Delay** to set the delay time of alarm volume escalation.

NOTE

- **The alarm volume escalation function is not applied to the latched alarms.**

16.5.2 Setting Alarm Pausing and Resetting Properties

16.5.2.1 Defining the Pause Function

You can either pause alarms or pause alarm tones. This depends on the pause setting. To set the pause function, follow this procedure:

1. Select the **Main Menu** quick key → from the **System** column select **Maintenance** → input the required password → select .
2. Select the **Alarm** tab → **Pause/Reset** tab.
3. Set **Pause** to **Alarm Pause** or **Audio Pause**.

16.5.2.2 Setting the Alarm Pause Time/Alarm Tone Pause Time

The alarm pause time or alarm tone pause time can be set to **1 min, 2 min, 3 min**, or **Permanent**. The default audio pause time is two minutes.

To set the alarm tone pause time, follow this procedure:

1. Select the **Main Menu** quick key → from the **System** column select **Maintenance** → input the required password → select .
2. Select the **Alarm** tab → **Pause/Reset** tab.
3. Set **Pause Time**.

16.5.2.3 Setting the Priority of Audio Paused Alarms

To select alarm of what priority can be paused or alarm sound of what priority can be paused, follow this procedure:

1. Select the **Main Menu** quick key → from the **System** column select **Maintenance** → input the required password → select .
2. Select the **Alarm** tab → **Pause/Reset** tab.
3. Set **Pause Priority**.
 - ◆ **All**: pressing the **Alarm Pause** quick key pauses all alarms.
 - ◆ **Med & Low**: pressing the **Alarm Pause** quick key pauses alarms of medium and low priority. The high priority alarms will not be paused.
 - ◆ **Disable**: the **Alarm Pause** quick key is disabled.

16.5.2.4 Disabling the Options of Prolonging Alarm Pause Time/Alarm Tone Pause Time

To disable specific options for the clinician when prolonging alarm pause time or the alarm tone pause time, follow this procedure:

1. Select the **Main Menu** quick key → from the **System** column select **Maintenance** → input the required password → select .
2. Select the **Alarm** tab → **Pause/Reset** tab.
3. Switch off **Pause 5 min**, **Pause 10 min**, or **Pause 15 min**.

16.5.2.5 Setting Alarm Light Status on Alarm Reset

When the alarm system is reset, the monitor presents the alarm light by default, but you can switch off the alarm light. To change the alarm light setting, follow this procedure:

1. Select the **Main Menu** quick key → from the **System** column select **Maintenance** → input the required password → select .
2. Select the **Alarm** tab → **Pause/Reset** tab.
3. Set **Alarm Light**.
 - ◆ **On When Reset**: when the alarm system is reset, the alarm tones of the current alarms are switched off, but the alarm lamp remains flashing.
 - ◆ **Off When Reset**: when the alarm system is reset, both the alarm tone and alarm lamp of the current alarms are switched off.

16.5.2.6 Setting the Reminder Tones

When the alarm volume is set to zero, or the alarm is reset or switched off, the monitor issues a periodical reminder tone. The reminder tone is enabled by default.

To set the reminder tone, follow this procedure:

1. Select the **Main Menu** quick key → from the **System** column select **Maintenance** → input the required password → select .
2. Select the **Alarm** tab → **Pause/Reset** tab.
3. Set **Alarm Reset Reminder** and **Alarm Off Reminder**.
 - ◆ **On:** the monitor issues reminder tones at a designated interval.
 - ◆ **Re-alarm:** if the alarm condition persists the alarms marked with "✓" will be re-generated after the designated reminder tone interval.
 - ◆ **Off:** the monitor does not issue reminder tones at a designated interval. The alarms marked with "✓" will be silenced.
4. Set **Reminder Interval** to **10 min, 5 min, 3 min, 2 min, or 1 min**.

16.5.3 Latching Physiological Alarms

To latch physiological alarms, follow this procedure:

1. Select the **Main Menu** quick key → from the **System** column select **Maintenance** → input the required password → select .
2. Select the **Alarm** tab → **Latching** tab.
3. Select how you want to latch the alarms.

Alarm latching rules are as follows:

- You can separately latch visible alarm signals and audible alarm signals.
- Latching audible alarm signals simultaneously latches the corresponding visible signals.
- Selecting alarms of lower priority simultaneously latches higher priority alarms.

16.5.4 Setting Guard Limits

To set guard limits, follow this procedure:

1. Select the **Main Menu** quick key → from the **System** column select **Maintenance** → input the required password → select .
2. Select the **Alarm** tab → **Guard Limits** tab.
3. Set **Patient Category**.
4. Set guard limits for the selected patient category:
 - ◆ **Disable Off:** if this switch is on, corresponding alarm cannot be switched off.
 - ◆ **Highest:** the high alarm limit cannot be higher than this setting.

- ◆ **Lowest:** the low alarm limit cannot be lower than this setting.
- ◆ **Priority:** the alarm priority cannot be lower than this setting.

If you need to restore default guard limits, select **Clear**.

16.5.5 Selecting Alarms to be Sent to the Nurse Call System

To set the type and priority of alarms that are sent to the nurse call system, follow this procedure:

1. Select the **Main Menu** quick key → from the **System** column select **Maintenance** → input the required password → select .
2. Select the **Alarm** tab → **Nurse Call** tab.
3. Select **Signal Type**.
 - ◆ **Pulse:** the nurse call signal is a pulse signal and each pulse lasts one second. When multiple alarms simultaneously occur, only one pulse signal is outputted. If an alarm occurs but the previous one is not cleared, a new pulse signal will also be outputted.
 - ◆ **Continuous:** the nurse call signal lasts until the alarm ends. That is to say the duration of a nurse call signal is equal to that of the alarm condition.
4. Select **Contact Type** to set the work mode of the nurse call relay.
5. Select **Alarm Priority** to set the priority of alarms sent to the nurse call system.
6. Select **Alarm Type** to set the type of alarms sent to the nurse call system.

16.5.6 Changing Alarm Priority Settings

16.5.6.1 Setting the Priority of the SpO₂ Sensor Off Alarm

To set the priority of the SpO₂ sensor off alarm, follow the procedure:

1. Select the **Main Menu** quick key → from the **System** column select **Maintenance** → input the required password → select .
2. Select the **Alarm** tab → **Other** tab.
3. Set the priority of **SpO2 Sensor Off**.

16.5.6.2 Setting the Switch of the CMS and eGateway Disconnection Alarm

You can choose whether to issue an alarm when the monitor is not connected or disconnected from the CMS/eGateway. To do so, follow this procedure:

1. Select the **Main Menu** quick key → from the **System** column select **Maintenance** → input the required password → select .
2. Select the **Alarm** tab → **Other** tab.

3. In the **Other** block, switch on or off **CMS/eGW Disconnected Alarm**. If **CMS/eGW Disconnected Alarm** is switched off, the “Offline” alarm is not presented when the monitor is not connected or disconnected from the CMS/eGateway.

16.5.6.3 Setting the Priority of the CMS and eGateway Disconnection Alarm

To set the priority of the CMS and eGateway disconnection alarm, follow this procedure:

1. Select the **Main Menu** quick key → from the **System** column select **Maintenance** → input the required password → select .
2. Select the **Alarm** tab → **Other** tab.
3. Set the priority of **CMS/eGW Disconnected**.

16.5.6.4 Setting the Switch of the SpO₂ Desat Alarm Off

You can choose whether switching off the SpO₂ Desat alarm is permissible or not. To do so, follow this procedure:

1. Select the **Main Menu** quick key → from the **System** column select **Maintenance** → input the required password → select .
2. Select the **Alarm** tab → **Other** tab.
3. Set **SPO2 Desat Alarm Off**.
 - ◆ **Disable:** the SpO₂ Desat alarm is always on. You cannot switch it off.
 - ◆ **Enable:** you can switch off the SpO₂ Desat alarm. For more information, see *6.6.1 Changing the SpO₂ Alarm Settings*.

WARNING

- **If a clinician switches off the SpO₂ Desat alarm, the monitor will not alarm when the patient’s SpO₂ is extremely low. This may result in a hazard to the patient.**
-
-

16.5.6.5 Setting the Switch of the Apnea Alarm Off

You can choose whether switching off the apnea alarm is permissible or not. To do so, follow this procedure:

1. Select the **Main Menu** quick key → from the **System** column select **Maintenance** → input the required password → select .
2. Select the **Alarm** tab → **Other** tab.
3. Set **Apnea Alarm Off**.
 - ◆ **Disable:** the apnea alarm is always on. The clinician cannot switch it off.
 - ◆ **Enable:** the clinician can switch off the apnea alarm. For more information, see *3.9.1.4 Changing Alarm Settings*.

WARNING

- **If a clinician switches off the apnea alarm, the monitor will not issue the apnea alarm when that situation occurs. This may result in a hazard to the patient. Keep the patient under close surveillance.**
-
-

16.5.7 Setting the Alarm Delay Time

For continuously measured parameters, you can set the alarm delay time. If the alarm condition is resolved within the delay time, the monitor does not present the alarm.

To set the alarm delay time, follow this procedure:

1. Select the **Main Menu** quick key → from the **System** column select **Maintenance** → input the required password → select .
2. Select the **Alarm** tab → **Other** tab.
3. Set **Alarm Delay**.
 - ◆ **Off**: an alarm is presented as soon as the alarm condition occurs.
 - ◆ **1 sec ~ 8 sec**: for continuously measured parameters, an alarm is not presented if the alarm condition is resolved within the designated delay time.

The setting of **Alarm Delay** is not applied to the apnea alarms. You can set apnea delay separately.

WARNING

- **The alarm delay time can be set to a maximum of 8 seconds. Changing this setting to an inappropriate level could result in a hazard to the patient.**
-
-

16.6 Changing the Standby Settings

16.6.1 Setting Prompt Message on Standby Screen

You can set the message to be displayed on the standby screen. To do so, follow this procedure:

1. Select the **Main Menu** quick key → from the **System** column select **Maintenance** → input the required password → select .
2. Select the **Standby** tab.
3. Select **Prompt On Standby Screen** and input the message as needed.

16.6.2 Setting Auto Standby

You can set the monitor to enter standby mode automatically if no operation is detected in a set time. To do so, follow this procedure:

1. Select the **Main Menu** quick key → from the **System** column select **Maintenance** → input the required password → select .
2. Select the **Standby** tab.
3. Switch on **Auto Enter Standby**.
4. Select **Auto Enter Standby Time** and select a time as needed. If no operation is detected in the selected time, the monitor enters standby mode automatically.

16.6.3 Enabling Black Standby Screen

The monitor provides a black screen function for standby mode. If enabled, the screen turns black after the monitor enters standby mode.

To do so, follow this procedure:

1. Select the **Main Menu** quick key → from the **System** column select **Maintenance** → input the required password → select .
2. Select the **Standby** tab.
3. Switch on **Black Screen On Standby**.

16.7 Changing CAA Settings

16.7.1 Selecting the Default Scoring Tool

To set the default scoring tool for different patient category, follow this procedure:

1. Select the **Main Menu** quick key → from the **System** column select **Maintenance** → input the required password → select .
2. Select the **CAA** tab. The **EWS** tab is displayed.
3. From the **Select Default Score** area, set **Default Adult Score**, **Default Ped Score**, and **Default Neo Score**.

16.7.2 Managing the Scoring Tools

To manage the scoring tool, follow this procedure:

1. Select the **Main Menu** quick key → from the **System** column select **Maintenance** → input the required password → select .
2. Select the **CAA** tab. The **EWS** tab is displayed.
3. Select the **Manage Score** button.
 - ◆ Delete local scoring tools: from the **Local** page, delete any unnecessary scoring tools.

- ◆ Import the desired scoring tools to the monitor: from the USB drive page, select the scoring tools on the USB drive, and then select **Import**.

NOTE

- **The monitor provides MEWS and NEWS by default. You cannot delete them.**
-

16.7.3 Setting GCS Threshold for Each Consciousness Level

You can configure the threshold and color of each consciousness level. To do so, follow this procedure:

1. Select the **Main Menu** quick key → from the **System** column select **Maintenance** → input the required password → select .
2. Select the **CAA** tab → **GCS** tab.
3. Set high limit, low limit and color for each level.

16.8 Changing Module Settings

16.8.1 Selecting NIBP Measurement Algorithm

You can change the NIBP measurement algorithm adopted on your monitor. To do so, follow this procedure:

1. Select the **Main Menu** quick key → from the **System** column select **Maintenance** → input the required password → select .
2. Select the **Module** tab. The NIBP tab is displayed.
3. Set **NIBP Measurement Algorithm**.
 - ◆ **Inflation**: the monitor measures blood pressure during cuff inflation. If succeeded, this measurement is completed. If the measurement fails at the inflation stage, the monitor will automatically continue the measurement at deflation stage.
 - ◆ **Deflation**: the monitor measures blood pressure during cuff deflation.

Affected by measurement factors or patient's physiological conditions, inflation algorithm might fail, be incorrect, or unavailable. Then the monitor automatically continues to perform the NIBP measurement at deflation stage. The measurement factors or patient's physiological conditions include:

- Excessive patient movement
- Using cuffs with no **TrueBP™** symbol
- Using cuffs of inappropriate size
- Cuffs being too tight or loose
- Using well-worn cuffs

- Patient blood pressure being too low
- Patient pulse rate being too low
- Patient having frequent arrhythmia
- Weak patient pulse

NOTE

- **The monitor always performs NIBP measurement at deflation stage if Patient Category is Neo.**
-

16.8.2 Selecting Temp Module

To select the type of Temp module of the monitor, follow this procedure:

1. Select the **Main Menu** quick key → from the **System** column select **Maintenance** → input the required password → select .
2. Select the **Module** tab → **Temp** tab.
3. Select the Temp module based on the configuration of the monitor.

16.8.3 Setting Temp Measurement Sites

You can set the measurement sites based on the Temp type of the monitor. To do so, follow this procedure:

1. Select the **Main Menu** quick key → from the **System** column select **Maintenance** → input the required password → select .
2. Select the **Module** tab → **Temp** tab.
3. Select the measurement sites as needed.

16.8.4 Adding a New Manual Parameter

If you need to add custom manual parameters to the **Manual Input** list, follow this procedure:

1. Select the **Main Menu** quick key → from the **System** column select **Maintenance** → input the required password → select .
2. Select **Module** → **Manual Input** tab, and then select **Add**.
3. Select **Name** and input the name of the new parameter with the on-screen keyboard.
4. Set **Type** to **Numeric** or **Text**.
 - ◆ The type of a parameter cannot be changed after saving.
5. For **Numeric** type, continue to set the **Unit** and **Resolution** of the parameter. For **Text** type, you need to set the options to be selected. At least 2 options need to be set. If needed, you can select **Add** to set more options.

6. Select **Save**.

After saving the setting, you can follow the procedure in *11.4 Changing the Display of Manual Parameters* to add the new parameter to the Manual Input list displayed on the screen.

16.8.5 Managing Pain Score

16.8.5.1 Enabling Pain Scales

You can enable or disable a provided pain score. To do so, follow this procedure:

1. Select the **Main Menu** quick key → from the **System** column select **Maintenance** → input the required password → select .
2. Select **Module** → **Pain Score** tab.
3. From the **Pain Score Method** area, switch on the pain scales as needed.

16.8.5.2 Adding a Custom Pain Scale

You can set up to 2 custom pain scales on the monitor. To do so, follow this procedure:

1. Select the **Main Menu** quick key → from the **System** column select **Maintenance** → input the required password → select .
2. Select **Module** → **Pain Score** tab.
3. Under **Custom Pain Score Method**, select corresponding area to edit the name of your scale, and change the upper limit of scoring value.
4. Enable **Display** on the right of the pain score for it to be displayed on the **Pain Score** screen.

16.8.5.3 Adding a Pain Description

You can add up to 15 descriptions on the monitor. To do so, follow this procedure:

1. Select the **Main Menu** quick key → from the **System** column select **Maintenance** → input the required password → select .
2. Select **Module** → **Pain Score** tab, and then select **Add Description**.
3. Select **Name** and input the name of the description with the on-screen keyboard.
4. Set **Type** to **Numeric** or **Text**.
 - ◆ The type of a description cannot be changed after saving.
5. For **Numeric** type, continue to set the **Unit** and **Resolution** of the parameter. For **Text** type, you need to set the options to be selected. At least 2 options need to be set. If needed, you can select **Add** to set more options.
6. Select **Save**.

16.8.6 Setting Parameter Measurement Timeout

NIBP and Temp measurements become outline fonts after a preset time. This feature prevents older values being misinterpreted as current measurements. To adjust the timeout period for NIBP and Temp, follow this procedure:

1. Select the **Main Menu** quick key → from the **System** column select **Maintenance** → input the required password → select .
2. Select **Module** → **Other** tab.
3. Set the timeout period for NIBP and Temp.

16.8.7 Enabling Outline Font for Suspected Values

You can set the monitor to display unreliable SpO₂ measurements in outline font. This prevents unreliable measurements from being misinterpreted as normal measurements. To do so, follow this procedure:

1. Select the **Main Menu** quick key → from the **System** column select **Maintenance** → input the required password → select .
2. Select **Module** → **Other** tab.
3. Switch on **Outline Font for Suspected Values**.

16.9 Setting Parameter Units

To set parameter units, follow this procedure:

1. Select the **Main Menu** quick key → from the **System** column select **Maintenance** → input the required password → select .
2. Select the **Unit** tab.
3. Select a parameter, and from the popup list, select the unit to be used.

Below is a list of the units you can set:

Parameter	Options	Default
Height Unit	cm, inch	cm
Weight Unit	kg, lb	kg
Glucose Unit	mg/dl, mmol/L	mg/dl
I/O Fluid Unit	ml, L	ml
CO2 Unit	mmHg, kPa, %	mmHg
Temp Unit	°C, °F	°C
Pressure Unit	mmHg, kPa	mmHg

16.10 Setting the Time

16.10.1 Setting the Time Synchronization

If the NTP Time Synchronization function is enabled, the monitor can automatically synchronize its time with a time server on which NTP (Network Time Protocol) is implemented. If there are many monitors connected within one network, you can enable the time synchronization to synchronize the time, and make it unnecessary to manually set the time for individual monitors.

16.10.1.1 Enabling NTP Time Synchronization

To enable the NTP Time Synchronization function, follow this procedure:

1. Select the **Main Menu** quick key → from the **System** column select **Maintenance** → input the required password → select .
2. Select the **Time** tab → **Time Synchronization** tab.
3. Switch on **Start NTP Time Sync**.

16.10.1.2 Setting the Time Server Address

To set the DNS name of the time server address, follow this procedure:

1. Select the **Main Menu** quick key → from the **System** column select **Maintenance** → input the required password → select .
2. Select the **Time** tab → **Time Synchronization** tab.
3. Input the name or IP address of the time server.

After configuring the NTP time server, select **Network Test** to verify that the NTP server is properly connected.

16.10.1.3 Setting the Time Synchronization Interval

To set the time synchronization interval, follow this procedure:

1. Select the **Main Menu** quick key → from the **System** column select **Maintenance** → input the required password → select .
2. Select the **Time** tab → **Time Synchronization** tab.
3. Set **Interval**.

16.10.2 Enabling Auto Daylight Savings Time

By default, daylight savings time is disabled. If this function is needed, you need to manually enable the daylight savings time. To auto start the daylight savings time, follow this procedure:

1. Select the **Main Menu** quick key → from the **System** column select **Maintenance** → input the required password → select .
2. Select the **Time** tab → **Daylight Savings Time** tab.

3. Switch on **Auto Daylight Savings Time**.
4. Adjust daylight savings time settings as necessary.

NOTE

- **If you enable Auto Daylight Savings Time you cannot manually switch it on or off from the System Time dialog. For more information, see 3.9.5 Setting the Date and Time.**
-

16.11 Viewing Version Information

To view the system software version, module hardware and software version, and firmware version, follow this procedure:

1. Select the **Main Menu** quick key → from the **System** column select **Maintenance** → input the required password → select .
2. Select the **Version** tab.

16.12 Checking Battery Information

To check the battery information, follow this procedure:

1. Select the **Main Menu** quick key → from the **System** column select **Maintenance** → input the required password → select .
2. Select the **Battery Information** tab.

16.13 Changing Scanner Settings

16.13.1 Setting Scanner Information

To set the scanner information on the monitor, follow this procedure:

1. Select the **Main Menu** quick key → from the **System** column select **Maintenance** → input the required password → select .
2. Select the **Scanner** tab. The **Scanner Info.** tab is displayed.
3. Set **Data Parse Mode** and then set other information as instructed below:
 - ◆ If you select **JADAK**, select **JADAK Barcode** tab and set the information of JADAK barcode.
 - ◆ If you select **Local**, continue to set the **Data Encoding Type**, patient barcode and clinician barcode.
 - ◆ If you select **DLL**, continue to set the **Data Encoding Type**.

16.13.2 Identifying the Barcode Reader (for the non-Mindray Custom 2D Barcode Reader)

When you are using barcode readers other than the JADAK Flexpoint HS-1R, HS-1RS or HS-1M, you should select the barcode reader from the USB device list, so that the monitor can identify the barcode reader. To do so, follow this procedure:

1. Select the **Main Menu** quick key → from the **System** column select **Maintenance** → input the required password → select .
2. Select the **Scanner** tab → **Identify Scanner** tab.
3. From the USB device list, select the barcode reader you are using.

16.13.3 Selecting Patient Information Read by the Barcode Reader (for the Mindray Custom 2D Barcode Reader)

To select desired patient information that will be read by the barcode reader, follow this procedure:

1. Select the **Main Menu** quick key → from the **System** column select **Maintenance** → input the required password → select .
2. Select the **Scanner** tab → **Field** tab.
3. Select the patient information. The selected information can be read by the barcode reader.

NOTE

- **The patient information read by the barcode reader is dependent on the patient information encoded in the hospital's barcodes.**
-

16.14 Setting the Report Layout

To set the patient information you want to display on general reports, follow this procedure:

1. Select the **Main Menu** quick key → from the **System** column select **Maintenance** → input the required password → select .
2. Select the **Record** tab. The **Report Layout** tab is displayed.
3. Select the desired items under **Report Name**. **N/A** indicates that this item is not displayed on a report.

16.15 Configuring the Network

You can connect the monitor to the central monitoring system (CMS), and eGateway through wired LAN or wireless LAN.

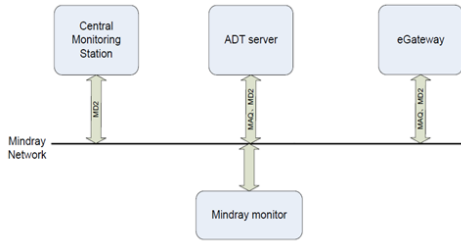

16.15.1 Network Safety Information

CAUTION

- **Wireless network designing, deploying, debugging, and maintenance should be executed by Mindray service personnel or authorized technicians.**
- **Always set the wireless network according to local wireless regulations.**
- **Using 5GHz frequency band is recommended whenever possible. There are more interference sources in 2.4GHz frequency band.**
- **Private APs and wireless routers are not allowed. These devices may cause radio interference and result in monitor and CMS data loss.**
- **Data communication must be performed within a closed network or within a virtually isolated network provided by a hospital for all network functions. The hospital is responsible for ensuring the security of the virtually isolated network.**
- **WPA2-PSK and WPA2-Enterprise verification and encryption should be used if possible. Otherwise, the equipment may not be able to work or patient information may be divulged. WPA2-Enterprise and a long password are recommended.**
- **Keep network authentication information, for example password, safe, to protect the network from being accessed by unauthorized users.**
- **Do not connect non-medical devices to the monitor network.**
- **If wireless network signal is poor, there may be a risk of CMS-destined data loss.**
- **Maximum number of monitors connected to a single AP is 16. Too many monitors connected to the same AP may result in network disconnection.**
- **RF interference may result in wireless network disconnection.**
- **Disconnecting from the network may result in CMS-destined data loss and function failure. Check the patient in case of network disconnection and solve the network problem as soon as possible.**

- **Ensure that the monitor IP address setting is correct. Changing the network settings may result in network disconnection. Contact your service personnel if there are any problems on the IP address.**
 - **If the device remains in service following the end of support, the cybersecurity risks for end-users can be expected to increase over time.**
 - **Network disconnection does not have an impact on local monitoring functions.**
 - **Contact Mindray service personnel if cybersecurity problems occur.**
-

16.15.2 Selecting a Network Type

To select network type, follow this procedure:

1. Select the **Main Menu** quick key → from the **System** column select **Maintenance** → input the required password → select .
2. Select the **Network Setup** tab. The **Network Type** tab is displayed.
3. Set **Monitor** to **Auto**, **LAN1 IP**, or **WLAN** according to your network type. The default is **Auto**, which means the monitor will automatically use LAN1 IP when detected and the available WLAN when LAN1 IP is not detected.

16.15.3 Managing TLS Certifications

You can check or delete local CA certificates or user certificates. You can also import certificates from a USB drive. To do so, follow this procedure:

1. Select the **Main Menu** quick key → from the **System** column select **Maintenance** → input the required password → select .
2. Select the **Network Setup** tab. The **Network Type** tab is displayed.
3. Select **TLS Certificate Management** button from the bottom left corner of the dialog.
 - ◆ Select **CA Certificate** or **User Certificate** to view either one type of certifications.
 - ◆ From the **Local Certificate** tab, select certifications you want to delete from the monitor, and then select **Delete**. You can also select **Delete All** to delete all the certifications in the list.
 - ◆ From the **Import Certificate** tab, select certifications you want to import from the USB memory device, and then select **Confirm**.

16.15.4 Setting the Wired Network

To set the wired network, follow this procedure:

1. Select the **Main Menu** quick key → from the **System** column select **Maintenance** → input the required password → select .

2. Select the **Network Setup** tab → **LAN1 IP** tab.
3. Select how the get the IP address.
 - ◆ **Obtain IP Address Automatically:** the monitor automatically gets the IP address.
 - ◆ **Use the Following Address:** you need to input the **IP Address, Subnet Mask, and Gateway.**
4. Select how to get the DNS address.
 - ◆ **Obtain DNS address automatically:** the monitor automatically gets the DNS address.
 - ◆ **Using the Following DNS Address:** you need to input the IP address of **Preferred DNS Server** and **Alternate DNS Server.**

16.15.5 Setting the Wireless Network

To add and set the wireless network, follow this procedure:

1. Select the **Main Menu** quick key → from the **System** column select **Maintenance** → input the required password → select .
2. Select the **Network Setup** tab → **WLAN** tab.
3. Select **Add WLAN**. In the popup dialog, input network name, SSID, and password. Set **Security**.
4. Select the **WLAN IP** tab and select how to get the IP address and DNS address.
 - ◆ **Obtain IP Address Automatically:** the monitor automatically gets the IP address.
 - ◆ **Use the Following Address:** you need to input the **IP Address, Subnet Mask, and Gateway.**
 - ◆ **Obtain DNS address automatically:** the monitor automatically gets the DNS address.
 - ◆ **Using the Following DNS Address:** you need to input the IP address of **Preferred DNS Server** and **Alternate DNS Server.**
5. Select the **WLAN Setup** tab and set **WLAN Band** and channels. The default is **Auto**, which means the monitor can automatically identify the WLAN band.

After configuring the wireless network, select **Network Test** to verify that the wireless network can be properly connected.

If you need to change network settings, select  beside the desired wireless network.

Selecting  deletes the wireless network.

16.15.6 Managing Certifications

You can delete certifications from the monitor, or import certifications from the USB memory device. To do so, follow this procedure:

1. Select the **Main Menu** quick key → from the **System** column select **Maintenance** → input the required password → select .
2. Select the **Network Setup** tab → **WLAN** tab.
3. Select **Certificate Management** button from the bottom left corner of the dialog.
 - ◆ From the **Local** tab, select certifications you want to delete from the monitor, and then select **Delete**.
 - ◆ From the **USB Drive** tab, select certifications you want to import from the USB memory device, and then select **Import**.

16.15.7 Enabling Selecting a CMS

To enable selecting a CMS, follow this procedure:

1. Select the **Main Menu** quick key → from the **System** column select **Maintenance** → input the required password → select .
2. Select the **Network Setup** tab → **Transfer Setup** tab.
3. Switch on **Select CMS**.

16.15.8 Adding CMSs

You can add up to 30 central monitoring systems (CMS) for your monitor. To add CMSs, follow this procedure:

1. Select the **Main Menu** quick key → from the **System** column select **Maintenance** → input the required password → select .
2. Select the **Network Setup** tab → **Transfer Setup** tab.
3. Set **Send Data** to **Central Station**.
4. Select **Add Central Station**, and then input the CMS name and IP address of this department.

16.15.9 Using the ADT Gateway

The ADT (admit-discharge-transfer) gateway is normally deployed in the eGateway. You can obtain patient information from the hospital ADT server through the ADT gateway.

To configure the ADT gateway, follow this procedure:

1. Select the **Main Menu** quick key → from the **System** column select **Maintenance** → input the required password → select .
2. Select the **Network Setup** tab → **Transfer Setup** tab.
3. Select **Server Address** to input the host name or IP address of the ADT gateway.
4. Select **Port** to input the port of the ADT gateway.

ADT Query is switched off by default. You can load patient information to the monitor from the ADT server only when this function is enabled.

After configuring the ADT gateway, select **Network Test** to verify that the ADT server is properly connected.

16.15.10 Sending Realtime Data, Waveforms and Alarms via HL7 Protocol

You can send the realtime data, waveforms, and alarms from the monitor to the hospital servers via HL7 protocol. To do so, follow this procedure:

1. Select the **Main Menu** quick key → from the **System** column select **Maintenance** → input the required password → select .
2. Select the **Network Setup** tab → **Transfer Setup** tab.
3. Set **Send Data** to **HL7**.
4. From the **Data + Waveforms** area, select **Server Address** to input the name or IP address for the server receiving the realtime data and waveform. Set **Port**.
5. Switch on **Send Data** and **Send Waveforms**, as needed. Set **Data Interval**.
6. From the **Alarms** area, select **Server Address** to input the name or IP address for the server receiving the alarm data. Set **Port**.
7. Switch on **Send Alarms** as needed.

This page also displays the server connection status.

NOTE

- **Licenses are required for sending realtime data, waveforms, and alarms via HL7. For more information on checking the licenses, see 3.9.6 Checking Software Licenses.**
-

16.15.11 Setting Multicast Parameters

Multicast helps device discovery between monitors and other devices on the network. Devices in the same multicast group can be mutually discovered.

To set multicast parameters, follow this procedure:

1. Select the **Main Menu** quick key → from the **System** column select **Maintenance** → input the required password → select .
2. Select the **Network Setup** tab → **Device Discover** tab.
3. Set **Multicast TTL**.
4. Set **Multicast Address**.

16.15.12 Setting the Network Service Quality Level

To set the quality of service (QoS), follow this procedure:

1. Select the **Main Menu** quick key → from the **System** column select **Maintenance** → input the required password → select .

2. Select the **Network Setup** tab → **QoS** tab.
3. Select **QoS Level For Realtime Monitoring** to set the service quality of network connection for realtime monitoring, for example parameter measurements and waveforms, alarms, etc.
4. Set **QoS Level For Others** to set the service quality of network connection for non-realtime monitoring, for example history data, printing, etc.

16.15.13 Setting MLDAP

To access the MLDAP server, set your monitor as follows:

1. Select the **Main Menu** quick key → from the **System** column select **Maintenance** → input the required password → select .
2. Select the **Network Setup** tab → **MLDAP** tab.
3. Set IP address and port of the MLDAP server.

16.15.14 Testing MLDAP Server Connection

To test whether the monitor is properly connected with the MLDAP server, follow this procedure:

1. Select the **Main Menu** quick key → from the **System** column select **Maintenance** → input the required password → select .
2. Select the **Network Setup** tab → **MLDAP** tab.
3. Select **Network Test**.

16.15.15 Setting VitalsLink

To set VitalsLink, follow this procedure:

1. Select the **Main Menu** quick key → from the **System** column select **Maintenance** → input the required password → select .
2. Select the **Network Setup** tab → **VitalsLink** tab.
3. Switch on **Enable**.
4. Set **Automatically Logout after** as needed.
5. From the **General Connectivity** area, set the **Master Server Address**, **Context Root**, and **Organization ID**. Enable **Local CSI** as needed.
6. From the **Security** area, set the **Auth Type**, **User Name**, **User Password**, **Tenant Type**, and **Transport Protocol**.
7. Set **Data Encoding Type** as needed.

16.16 Enabling Bluetooth

To enable the Bluetooth function, follow this procedure:

1. Select the **Main Menu** quick key → from the **System** column select **Maintenance** → input the required password → select .
2. Select the **Bluetooth**.
3. Switch on **Enable**.
4. Set **Auto Unpair On Disconnection** as needed.

16.17 Defining Other Functions

16.17.1 Setting the SpO₂ Tone Mode

The monitor adjusts the QRS tone (pitch tone) according to the SpO₂ values. To set the SpO₂ tone mode, follow this procedure:

1. Select the **Main Menu** quick key → from the **System** column select **Maintenance** → input the required password → select .
2. Select the **Other** tab.
3. Set **SpO₂ Tone** to Mode 1 or Mode 2. The pitch changes more rapidly in **Mode 2** than in **Mode 1**, as saturation levels change.

The SpO₂ tone mode chart for SpO₂ between 40% to 100% is as follows:

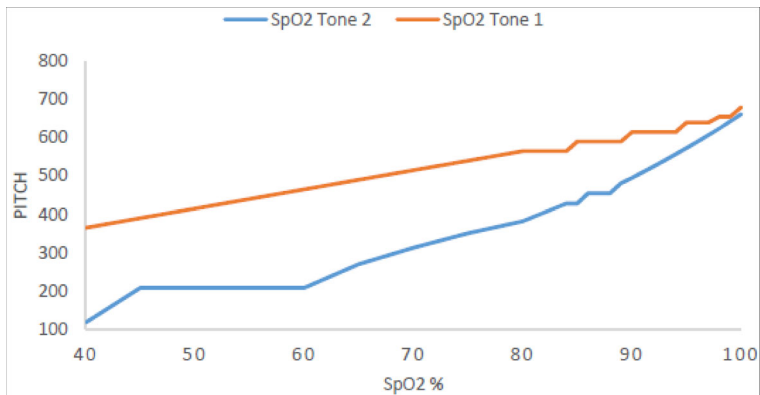

CAUTION

- It is highly recommended to use the same SpO₂ tone mode for the same monitors in a single area to prevent issues arising from inconsistent operation.

16.17.2 Selecting the Language

To set the user interface (UI) language, follow this procedure:

1. Select the **Main Menu** quick key → from the **System** column select **Maintenance** → input the required password → select .
2. Select the **Other** tab.
3. Select **Language**, and from the popup list, select the target language.

16.17.3 Browsing System Log

To browse the system log, follow this procedure:

1. Select the **Main Menu** quick key → from the **System** column select **Maintenance** → input the required password → select .
2. Select the **Other** tab.
3. Select **Browse System Log** → **OK** to enter the **System Log** page.
4. Select the log classifications you want to view, and then select **Search**. To view logs of certain date and time, select **Jump To** and define the date and time.

16.17.4 Exporting System Log

To export the system log, follow this procedure:

1. Select the **Main Menu** quick key → from the **System** column select **Maintenance** → input the required password → select .
2. Select the **Other** tab.
3. Select **Export System Log**.

16.17.5 Exporting Patient Data

To export patient data, follow this procedure:

1. Connect a USB drive to the monitor's USB port.
2. Select the **Main Menu** quick key → from the **System** column select **Maintenance** → input the required password → select .
3. Select the **Other** tab.
4. Select **Export Patient Data**.

17 Battery

17.1 Battery Introduction

This monitor is designed to operate on battery power when the mains power is not available. The monitor uses mains power as primary power source. In case of mains power failure, the monitor automatically runs on the battery power.

NOTE

- **If the mains power fails and the monitor runs on battery power, the display brightness automatically lowers to the value of Brightness on Battery (set in Main Menu → Device → Display). You can manually adjust the display brightness as required.**
-

17.2 Battery Safety Information

WARNING

- **Keep batteries out of the reach of children.**
- **Use only Mindray specified batteries. Use of a different battery may present a risk of fire or explosion.**
- **Keep the batteries in their original package until you are ready to use them.**
- **Do not expose batteries to liquid.**
- **Do not crush, drop or puncture the battery. Mechanical abuse can lead to internal damage and internal short circuits. If a battery has been dropped or banged against a hard surface, whether damage is externally visible or not, remove the battery from use and dispose of it properly.**
- **If the battery shows signs of damage or signs of leakage, replace it immediately. Use caution in removing the battery. Avoid contacting the leakage.**
- **Batteries should be charged only in this monitor.**
- **Extremely high ambient temperature may cause battery overheat protection, resulting in monitor shutdown.**
- **The lithium-ion battery has a service life of three years. Replace the battery when it reaches the end of its service life. Failure to replace the battery may cause serious damage to the equipment from battery overheating.**

- Do not open batteries, heat batteries above 60 °C, incinerate batteries, or short battery terminals. They may ignite, explode, leak or heat up, causing personal injury.

CAUTION

- Remove the battery before shipping the monitor or when it will not be used for an extended period of time.

NOTE

- It is recommended to always install a fully charged battery in the monitor to ensure normal monitoring in case of accidental power failure.

17.3 Battery Indications





The battery LED, on-screen battery power indicator, and related alarm messages indicate the battery status.

17.3.1 Battery LED

The battery LED is on the left bottom of the front panel of the monitor. For details, see 2.3.1 *Front View*.

17.3.2 Battery Symbols

The on-screen battery symbols indicate the battery status as follows:

-  indicates that the battery power is sufficient. The green portion represents the remaining charge.
-  indicates that the battery power is low and needs to be charged. The red portion represents the remaining charge.
-  indicates that the battery is almost depleted and needs to be charged immediately. Otherwise, the monitor will automatically shut down soon.
-  indicates that no battery is installed or the battery has failed.
-  indicates that the battery is being charged. An extra lightning symbol is displayed and the green portion is animated.

17.3.3 Battery-related Alarms

The capacity of the battery is limited. When the battery level is low, the monitor presents the **Low Battery** alarm, the alarm lamp flashes, and the monitor produces an alarm sound.

If the battery is almost depleted, the monitor presents the **Critically Low Battery** alarm. In this case, immediately connect the AC mains to power the monitor and charge the battery. Otherwise, the monitor will automatically shut down soon.

For more information on battery-related alarms, see **D.2.6 Power Supply Technical Alarm Messages**.

17.4 Replacing the Battery

To replace the battery, follow this procedure:

1. Turn off the monitor. Disconnect the power cable and other cables.
2. Lay the monitor down to have access to the bottom of the monitor.
3. Open the battery compartment door by turning the screw counterclockwise.

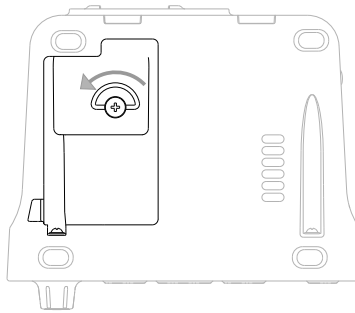

4. Disconnect the old battery from the connectors on the left of the battery compartment and take out the old battery.
5. Insert the new battery into the battery compartment with the battery terminal outwards. Then connect the battery to the connectors on the left of the battery compartment.
6. Close the battery door and turn the screw clockwise.

17.5 Connecting an External Battery

You can connect an external battery to the monitor via the connector on the back.

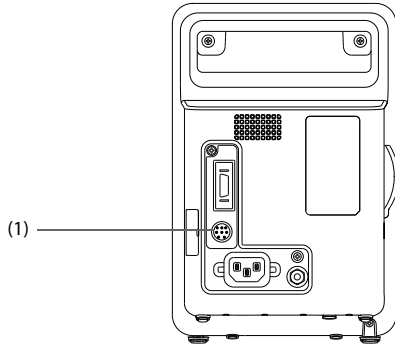

(1). Connector for an External Battery

The external battery is charged whenever the monitor is connected to an AC power source regardless of whether or not the monitor is currently on.

17.6 Charging a Battery

The battery is recharged automatically when the monitor is connected to AC mains power.

17.7 Maintaining the Battery

17.7.1 Conditioning the Battery

The performance of a rechargeable battery deteriorates over time. It is recommended that the batteries be conditioned every three months or when you notice a degradation in performance. If the battery is not conditioned for a prolonged time, its charge indication may not be accurate and you may wrongly evaluate the remaining battery runtime.

To condition a battery, follow this procedure:

1. Disconnect the monitor from the patient and stop all monitoring and measuring procedures.
2. Turn off the monitor. Install the battery to be conditioned.
3. Connect the monitor to AC power. Allow the battery to be charged uninterruptedly till it is fully charged.
4. Disconnect the monitor from the AC power and turn on the monitor.
5. Allow the monitor to run on the battery until the battery is completed and the monitor automatically shuts down.
6. Fully charge the battery again for use or charge it to 40 – 60% for storage.

NOTE

- **Do not use the monitor to monitor a patient during battery conditioning.**
 - **Do not interrupt battery conditioning. Interrupting battery conditioning to use the monitor will prevent completion of the conditioning cycle and require repeating the conditioning process completely to properly condition the battery.**
-

17.7.2 Checking Battery Performance

The performance of a rechargeable battery deteriorates over time. It is recommended that the battery performance be checked periodically or if you are concerned that the battery may fail.

See steps 1 to 5 of *17.7.1 Conditioning the Battery* to check battery performance. The operating time of the battery reflects their performance directly. If the operating time of a battery is noticeably shorter than that stated in the specifications, the battery may reach its service life or malfunction. If the battery performance meets the requirement, fully charge the battery again for use or charge it to 40 – 60% for storage.

NOTE

- **Battery operating time depends on equipment configuration and operation. For example, high display brightness or measuring NIBP repeatedly will shorten the battery operating time.**
-

17.8 Storing Batteries

When storing batteries, make sure that the battery terminals do not come into contact with metallic objects. If batteries are stored for an extended period of time, place the batteries in a cool place with a partial charge of 40% to 60% capacity.

Condition the stored batteries every three months. For more information, see *17.7.1 Conditioning the Battery*.

NOTE

- **Remove the battery from the equipment if the equipment is not used for a prolonged time (for example, several weeks). Otherwise the battery may overdischarge.**
 - **Storing batteries at high temperature for an extended period of time will significantly shorten their life expectancy.**
 - **Storing batteries in a cool place can slow the aging process. Ideally the batteries should be stored at 15 °C.**
-

17.9 Recycling Batteries

Discard a battery in the following situations:

- The battery has visual signs of damage.
- The battery fails.
- The battery is aged and its runtime significantly less than the specification.
- The battery service life is reached.

Properly dispose of batteries according to local regulations.

WARNING

- **Do not open batteries, heat batteries above 60 °C, incinerate batteries, or short the battery terminals. They may ignite, explode, leak or heat up, causing personal injury.**
-
-

18 Care and Cleaning

18.1 Care and Cleaning Introduction

In this chapter we only describe cleaning and disinfection of the monitor, and certain accessories. For the cleaning and disinfection of other reusable accessories, refer to their instructions for use of the corresponding accessories.

Keep your equipment and accessories clean. To avoid damage to the equipment, follow these guidelines:

- Always follow the manufacturer's instructions for each cleaning/disinfecting agent.
- Do not immerse any part of the equipment or accessories into liquid.
- Do not pour liquid onto the equipment or accessories.
- Do not allow liquid to enter the case.
- Never use abrasive materials (such as steel wool or silver polish), or erosive cleaners (such as acetone or acetone-based cleaners).

18.2 Care and Cleaning Safety Information

WARNING

- **Be sure to turn off the system and disconnect all power cables from the outlets before cleaning the equipment.**
 - **It is recommended that your equipment be thoroughly cleaned after use, to prevent possible infection to the patient.**
 - **Do not clean or disinfect the metal parts of the monitor and probe. Otherwise, metal part corrosion or product reliability deterioration could result.**
 - **Do not attempt to clean the device while monitoring a patient.**
-

CAUTION

- **If you spill liquid on the equipment or accessories, contact Mindray or your service personnel.**
- **Avoid wetting the pins and metal parts of the equipment, mounting kits or accessories during cleaning and disinfection.**

- Use only Mindray approved cleaners and disinfectants and methods listed in this chapter to clean or disinfect your equipment. Warranty does not cover damage caused by unapproved substances or methods.
- We make no claims regarding the efficacy of the listed chemicals or methods as a means for controlling infection. For the method to control infection, consult your hospital's Infection Control Officer or Epidemiologist.
- The responsible hospital or institution shall carry out all cleaning and disinfection procedures specified in this chapter.
- Refer to the respective instructions for use of the cleaning agents and disinfectants.
- Do not mix disinfecting solutions (such as bleach and ammonia) as hazardous gases may result.

NOTE

- To clean or disinfect reusable accessories, refer to the instructions delivered with the accessories.
-

18.3 Cleaning and Disinfecting the Equipment

Use approved cleaning and disinfecting agents for cleaning or disinfecting the main unit.

18.3.1 Approved Cleaning and Disinfecting Agents

The following table lists approved cleaning and disinfecting agents:

Product Name	Product Type	Active Ingredients	Purpose	EPA No.
Sodium hypochlorite bleach	Liquid	Sodium hypochlorite bleach 0.5%	Disinfecting	/
Hydrogen peroxide	Liquid	Hydrogen peroxide 3%	Disinfecting	/
Isopropanol	Liquid	Isopropanol 70%	Disinfecting	/
1-Propanol	Liquid	1-Propanol 50%	Disinfecting	/
Metrex CaviCide1™	Liquid	Diisobutylphenoxyethoxyethyl dimethyl benzyl ammonium chloride 0.28%, Isopropanol 17.2%	Cleaning, disinfecting	46781-12

Product Name	Product Type	Active Ingredients	Purpose	EPA No.
Virex® II 256 (1:256)	Liquid	Didecyl dimethyl ammonium chloride 8.704%, n-Alkydimethyl benzyl ammonium chloride 8.190%	Cleaning, disinfecting	70627-24
Virex® TB	Liquid	n-Alkyl dimethyl benzyl ammonium chlorides 0.105%, n-Alkyl dimethyl ethylbenzyl ammonium chlorides 0.105%	Cleaning, disinfecting	70627-2
Rely+On™ Virkon® High Level Surface Disinfectant	Powder	Used as 1% solution Biocidal active: Pentapotassium bis (peroxymonosulphate) bis (sulphate)(500g/kg), Contains dipotassium peroxodisulphate.	Disinfecting	/
Alpet® D2 Surface Sanitizing Wipes	Wipes	Isopropyl Alcohol 58.6000%, Octyl Decyl Dimethyl Ammonium chloride 0.0075%, Dioctyl Dimethyl Ammonium Chloride 0.0030%	Disinfecting	73232-1
Clorox Dispatch® Hospital Cleaner Disinfectant Towels with Bleach	Wipes	Sodium Hypochlorite 0.65%	Cleaning, disinfecting	56392-8
Clorox Healthcare® Bleach Germicidal Wipes	Wipes	Sodium Hypochlorite 0.55%	Cleaning, disinfecting	67619-12
Clorox Healthcare® Hydrogen Peroxide Cleaner Disinfectant Wipes	Wipes	Hydrogen Peroxide 1.4%	Cleaning, disinfecting	67619-24
Diversey Oxivir® TB Wipes	Wipes	Hydrogen Peroxide 0.5%	Cleaning, disinfecting	70627-60
Metrex CaviWipes™	Wipes	Diisobutylphenoxyethoxyethyl dimethyl benzyl ammonium chloride 0.28%, Isopropanol 17.2%	Cleaning, disinfecting	46781-8

Product Name	Product Type	Active Ingredients	Purpose	EPA No.
PDI Sani-Cloth® AF3 Germicidal Disposable Wipe	Wipes	n-Alkyl dimethyl ethylbenzyl ammonium chlorides 0.14%, n-Alkyl dimethyl benzyl ammonium chlorides 0.14%	Cleaning, disinfecting	9480-9
PDI Sani-Cloth® Bleach Germicidal Disposable Wipe	Wipes	Sodium Hypochlorite 0.63%, other ingredients 99.37%	Cleaning, disinfecting	9480-8
PDI Sani-Cloth® HB Germicidal Disposable Wipe	Wipes	n-Alkyl dimethyl ethylbenzyl ammonium chlorides 0.07%, n-Alkyl dimethyl benzyl ammonium chlorides 0.07%	Cleaning, disinfecting	61178-4- 9480
PDI Sani-Cloth® Plus Germicidal Disposable Cloth	Wipes	n-Alkyl dimethyl ethylbenzyl ammonium chlorides 0.125%, n-Alky dimethyl benzyl ammonium chlorides 0.125%	Cleaning, disinfecting	9480-6
PDI Super Sani-Cloth® Germicidal Disposable Wipe	Wipes	n-Alkyl dimethyl ethylbenzyl ammonium chlorides 0.25%, n-Alkyl dimethyl benzyl ammonium chlorides 0.25%, Isopropyl Alcohol 55.0%	Cleaning, disinfecting	9480-4
S-7 hospital grade disinfectant surface wipes	Wipes	Benzalkonium chloride 0.09% w/v Didecyl dimethyl ammonium chloride 0.147% w/v Poly (Hexamethylene Bisguanide) hydrochloride 0.09% w/v	Disinfecting	/
Neutral detergent wipes	Wipes	less than 1% non-ionic and cationic surfactants, DMDM hydantoin Iodopropynyl butylcarbamate	Cleaning, disinfecting	/
Premier disinfectant wips	Wipes	less than 5% - nonionic surfactant disinfectants, Iodopropynyl butylcarbamate	Disinfecting	/
V-wipes	Wipes	Benzalkonium chloride 9.63g/L	Cleaning, disinfecting	/

18.3.2 Cleaning the Equipment

Thoroughly clean your equipment after use on a patient. Before cleaning the equipment and mounting kits, consult your hospital's regulations for cleaning the equipment.

To clean your equipment, follow this procedure:

1. Shut down the monitor and disconnect it from the AC power.
2. Clean the display screen with wipes or a soft cloth moistened with one of the cleaning agents listed in *18.3.1 Approved Cleaning and Disinfecting Agents* only. Follow the cleaners/disinfectants instructions, including contact time.
3. Clean the exterior surface of the equipment with wipes or a soft cloth moistened with one of the cleaning agents listed in *18.3.1 Approved Cleaning and Disinfecting Agents* only.
4. Wipe off all the cleaning agent residue with a dry cloth.
5. Dry your equipment in a ventilated, cool place.
6. Check the monitor and make sure there is no visible residue on the surface. Repeat the above steps to clean the main unit if necessary.

18.4 Disinfecting the Equipment

Disinfect the monitor as required in your hospital's servicing schedule using the disinfecting agents listed in the table above. Cleaning the monitor before disinfecting is recommended.

18.5 Cleaning the Thermal Print Head

Dirty print head deteriorates printing quality. Check the printout to ensure the printing is legible and dark. Light printing may indicate a dirty print head.

To clean the thermal print head, follow this procedure:

1. Take measures against the static electricity, such as the wrist strap.
2. Open the recorder door and remove the recording paper.
3. Gently wipe the print head with cotton swabs dampened with ethanol to remove the dust and foreign particles.
4. Wipe off excess moisture with dry cotton swabs.
5. Allow the print head air dry.
6. Reload the recording paper and close the recorder door.

CAUTION

- **Do not use anything that may destroy the thermal element.**
- **Do not add unnecessary force to the thermal head**

- **The thermal print head gets hot when recording. Do not clean the print head immediately after recording.**

18.6 Cleaning and Disinfecting the Accessories

For the NIBP air hose and SpO₂ cable, you should clean and disinfect them using the cleaners and disinfectants and methods listed in this section. For other accessories, you should consult the instructions delivered with the accessories.

CAUTION

- **Fluids entering the NIBP air hose can damage the equipment. When cleaning and/or disinfecting the NIBP air hose, prevent liquid from entering the hose.**
- **Periodically inspect the NIBP air hose and connector for signs of wear or deterioration. Replace the NIBP air hose if you detect a leak. Dispose of damaged NIBP air hose according to local laws for disposal of hospital waste.**
- **Never immerse or soak the accessories in any liquid.**
- **Never clean or disinfect the metallic connectors at either end of the accessories.**
- **Use only Mindray approved cleaners and disinfectants and methods listed in this section to clean or disinfect the accessories. Warranty does not cover damage caused by unapproved substances or methods.**
- **To avoid long term damage, the accessories should be disinfected only when necessary as determined by your hospital's policy.**

18.6.1 Approved Accessories Cleaning and Disinfecting Agents

The following table lists approved NIBP air hose cleaning and disinfecting agents:

Product Name	Product Type	Active Ingredients	Purpose	EPA No.
Isopropanol	Liquid	Isopropanol 70%	Disinfecting	/
1-Propanol	Liquid	1-Propanol 50%	Disinfecting	/
Metrex CaviCide1™	Liquid	Diisobutylphenoxyethoxyethyl dimethyl benzyl ammonium chloride 0.28%, Isopropanol 17.2%	Cleaning, disinfecting	46781-12
Virex® TB	Liquid	n-Alkyl dimethyl benzyl ammonium chlorides 0.105%, n-Alkyl dimethyl ethylbenzyl ammonium chlorides 0.105%	Cleaning, disinfecting	70627-2

Product Name	Product Type	Active Ingredients	Purpose	EPA No.
Rely+On™ Virkon® High Level Surface Disinfectant	Powder	Used as 1% solution* Biocidal active: Pentapotassium bis (peroxymonosulphate) bis (sulphate) (500g/kg) Contains dipotassium peroxodisulphate.	Disinfecting	/
Alpet® D2 Surface Sanitizing Wipes	Wipes	Isopropyl Alcohol 58.6000%, Octyl Decyl Dimethyl Ammonium chloride 0.0075%, Dioctyl Dimethyl Ammonium Chloride 0.0030%	Disinfecting	73232-1
Clorox Dispatch® Hospital Cleaner Disinfectant Towels with Bleach	Wipes	Sodium Hypochlorite 0.65%	Cleaning, disinfecting	56392-8
Metrex CaviWipes™	Wipes	Diisobutylphenoxyethoxyethyl dimethyl benzyl ammonium chloride 0.28%, Isopropanol 17.2%	Cleaning, disinfecting	46781-8
PDI Sani-Cloth® AF3 Germicidal Disposable Wipe	Wipes	n-Alkyl dimethyl ethylbenzyl ammonium chlorides 0.14%, n-Alkyl dimethyl benzyl ammonium chlorides 0.14%	Cleaning, disinfecting	9480-9
PDI Sani-Cloth® Plus Germicidal Disposable Wipe	Wipes	n-Alkyl dimethyl ethylbenzyl ammonium chlorides 0.125%, n-Alky dimethyl benzyl ammonium chlorides 0.125%	Cleaning, disinfecting	9480-6
PDI Super Sani-Cloth® Germicidal Disposable Wipe	Wipes	n-Alkyl dimethyl ethylbenzyl ammonium chlorides 0.25%, n-Alkyl dimethyl benzyl ammonium chlorides 0.25%, Isopropyl Alcohol 55.0%	Cleaning, disinfecting	9480-4

The following table lists approved Masimo SpO₂ cable cleaning and disinfecting agents:

Product Name	Product Type	Active Ingredients	Purpose	EPA No.
Isopropanol	Liquid	Isopropanol 70%	Disinfecting	/

Product Name	Product Type	Active Ingredients	Purpose	EPA No.
Sodium hypochlorite bleach	Liquid	Sodium hypochlorite bleach, 0.5%	Disinfecting	/
PDI Super Sani-Cloth® Germicidal Disposable Wipe	Wipes	n-Alkyl dimethyl ethylbenzyl ammonium chlorides 0.25%, n-Alkyl dimethyl benzyl ammonium chlorides 0.25%, Isopropyl Alcohol 55.0%	Cleaning, disinfecting	9480-4
Glutaraldehyde	Liquid	Glutaraldehyde, 2%	Disinfecting	/

The following table lists approved disinfectants for the Nellcor SpO₂ cables:

Product Name	Product Type	Active Ingredients	Purpose	EPA No.
Sodium hypochlorite bleach	Liquid	Sodium hypochlorite bleach, 0.5%	Disinfecting	/
Isopropanol	Liquid	Isopropanol 70%	Disinfecting	/
1-Propanol	Liquid	1-Propanol 50%	Disinfecting	/
Virex® TB	Liquid	n-Alkyl dimethyl benzyl ammonium chlorides 0.105%, n-Alkyl dimethyl ethylbenzyl ammonium chlorides 0.105%	Cleaning, disinfecting	70627-2
Rely+On™ Virkon® High Level Surface Disinfectant	Powder	Used as 1% solution* Biocidal active: Pentapotassium bis (peroxymonosulphate) bis (sulphate) (500g/kg) Contains dipotassium peroxodisulphate.	Disinfecting	/
Clorox Dispatch® Hospital Cleaner Disinfectant Towels with Bleach	Wipes	Sodium Hypochlorite 0.65%	Cleaning, disinfecting	56392-8

Product Name	Product Type	Active Ingredients	Purpose	EPA No.
Clorox Healthcare® Bleach Germicidal Wipes	Wipes	Sodium Hypochlorite 0.55%	Cleaning, disinfecting	67619-12
Clorox Healthcare® Hydrogen Peroxide Cleaner Disinfectant Wipes	Wipes	Hydrogen Peroxide 1.4%	Cleaning, disinfecting	67619-24
Diversey Oxivir® TB Wipes	Wipes	Hydrogen Peroxide 0.5%	Cleaning, disinfecting	70627-60
PDI Super Sani-Cloth® Germicidal Disposable Wipe	Wipes	n-Alkyl dimethyl ethylbenzyl ammonium chlorides 0.25%, n-Alkyl dimethyl benzyl ammonium chlorides 0.25%, Isopropyl Alcohol 55.0%	Cleaning, disinfecting	9480-4

18.6.2 Cleaning the Accessories

Thoroughly clean the accessories (NIBP air hose, and SpO₂ cable) after use on a patient. Before cleaning the accessories, consult your hospital's regulations for cleaning the accessories.

To clean the accessories (NIBP air hose and SpO₂ cable), follow this procedure:

1. Clean the accessories with wipes or a soft cloth moistened with one of the cleaning agents listed in *18.3.1 Approved Cleaning and Disinfecting Agents* only.
2. Wipe off all the cleaning agent residue with a dry cloth.
3. Allow the accessories to air dry.

18.6.3 Disinfecting the Accessories

We recommend that the accessories (NIBP air hose and SpO₂ cable) should be disinfected only when necessary as determined by your hospital's policy, to avoid long term damage to the accessories. Cleaning the accessories before disinfecting is recommended.

18.7 Sterilization

Sterilization is not recommended for this monitor, related products, accessories, or supplies unless otherwise indicated in the Instructions for Use that accompany the products, accessories or supplies.

This page intentionally left blank.

19 Maintenance

19.1 Maintenance Introduction

Regular maintenance is essential to ensure that the equipment continues to function properly. This chapter contains information on periodic testing and maintenance.

19.2 Maintenance Safety Information

WARNING

- **To avoid electric shock, stop using the monitor if you find the housing is damaged, and contact the service personnel.**
 - **Failure on the part of the responsible individual hospital or institution using this equipment to implement a recommended maintenance schedule may cause undue equipment failure and possible health hazards.**
 - **No modification of this equipment is allowed.**
 - **This equipment contains no user serviceable parts.**
 - **Software upgrades to the monitor can only be done by Mindray service engineers with Mindray upgrading tools.**
 - **Do not open the equipment housings. All servicing and future upgrades must be carried out by the service personnel.**
 - **The safety checks or maintenance involving any disassembly of the equipment should be performed by professional service personnel. Otherwise, undue equipment failure and possible health hazards could result.**
 - **Do not open batteries, heat batteries to above 60 °C, incinerate batteries, or short the battery terminals. Batteries may ignite, explode, leak or heat up, causing personal injury.**
 - **Do not adjust, repair, open, disassemble, or modify the pulse oximeter or accessories. Injury to personnel or equipment damage could occur. Return the pulse oximeter for servicing if necessary.**
 - **The service personnel must be properly qualified and thoroughly familiar with the operation of the equipment.**
-
-

CAUTION

- **The equipment and accessories shall not be serviced or maintained while in use on a patient.**
 - **If you discover a problem with any of the equipment, contact your service personnel or Mindray.**
 - **Use and store the equipment within the specified temperature, humidity, and altitude ranges.**
 - **When disposing of the packaging material, be sure to observe the applicable waste control regulations and keep it out of the reach of children.**
 - **At the end of its service life, the equipment, as well as its accessories, must be disposed of in compliance with the guidelines regulating the disposal of such products. If you have any questions concerning disposal of the equipment, please contact Mindray.**
-

NOTE

- **If needed, contact the manufacture for circuit diagrams, component part lists, descriptions, calibration instructions, or other information concerning the repair of the equipment.**
-

19.3 Maintenance and Testing Schedule

Follow the maintenance and testing schedule or local regulations to perform testing and maintenance such as defined in section *19.5 Testing Methods and Procedures*. Follow your hospital policy on cleaning and disinfecting the equipment before testing and maintenance.

The following table lists the maintenance and testing schedule:

Test/Maintenance Item	Recommended Frequency
Performance Tests	
Visual inspection	Every day, before first use.
Measurement module performance test and calibration	<ol style="list-style-type: none">1. If you suspect that the measurement values are incorrect.2. Follow any repairs or replacement of relevant module.3. Once every two years for parameter module performance tests.

Test/Maintenance Item		Recommended Frequency
Performance Tests		
Nurse call test		If you suspect that the nurse call function does not work properly.
Electrical Safety Tests		
Electrical safety tests		Once every two years.
Other Tests		
Power-on test		Before use.
Recorder check		1. When the recorder is used for the first time. 2. Follow any repair or replacement of the recorder.
Battery check	Functionality test	1. When first installed. 2. When battery is replaced.
	Performance test	Every three months or if the battery runtime is reduced significantly.

19.4 Checking Version Information

To view system software version information, select the **Main Menu** quick key → from the **System** column select **Version**.

You can check system software version, module hardware and software version, and firmware version only from the **Maintenance** dialog.

19.5 Testing Methods and Procedures

Except the following maintenance tasks, all other test and maintenance tasks should be performed by Mindray-qualified service personnel only.

- Regular checks, including visual inspection and power-on test
- Recorder tests
- Battery check

If your monitor needs a safety test and performance test, contact the service personnel.

19.5.1 Performing Visual Inspection

Visually inspect the equipment before its first used every day. If you find any signs of damage, remove the monitor from use and contact the service personnel.

Verify that the equipment meets the following requirements:

- Environment and power supply specifications are met.
- The monitor housing and display screen are free from cracks or other damage.
- The power cord is not damaged and the insulation is in good condition.
- Connectors, plugs, and cables are not damaged and kinked.
- Power cord and patient cables are securely connected to the equipment.

19.5.2 Performing Power-on Test

The monitor automatically performs a power-on test at startup. Verify the following items for the power-on test:

- The equipment powers on properly.
- The alarm system works properly, denoted by alarm sounds and display of all three alarm light colors.
- The monitor displays properly.

19.5.3 Testing the Recorder

To test the recorder, follow this procedure:

1. Start a recording task to print waveforms and reports.
2. Check that the recorder functions correctly.
3. Check that the printout is clear without missing dots.

19.5.4 Checking the Battery

For information on battery check, see *17.7.2 Checking Battery Performance*.

19.6 NIBP Maintenance

19.6.1 NIBP Leakage Test

The NIBP leakage test checks the integrity of the system and of the valve. The NIBP leakage test should be performed once every two years or when you doubt the NIBP measurements. The NIBP leakage test should be performed by Mindray-qualified service personnel only.

19.6.2 NIBP Accuracy Test

The NIBP accuracy test should be performed once every two years or when you doubt the NIBP measurements. The NIBP accuracy test should be performed by Mindray-qualified service personnel only.

19.7 Disposing of the Monitor

Dispose of the monitor and its accessories when its service life is reached. Follow local regulations regarding the disposal of such product.

WARNING

- **For disposal of parts and accessories, where not otherwise specified, follow local regulations regarding disposal of hospital waste.**
-
-

This page intentionally left blank.

20 Accessories

The accessories listed in this chapter comply with the requirements of IEC 60601-1-2 when in use with the monitor. The accessory material that contacts the patients has undertaken the bio-compatibility test and is verified to be in compliance with ISO 10993-1. For details about the accessories, refer to the instructions for use provided with the accessory.

WARNING

- **Use accessories specified in this chapter. Using other accessories may cause damage to the equipment or not meet the claimed specifications.**
 - **Single-use accessories are not designed to be reused. Reuse may cause a risk of contamination and affect the measurement accuracy.**
-
-

CAUTION

- **The accessories may not meet the performance specifications if stored or used outside the specified temperature and humidity ranges. If accessory performance is degraded due to aging or environmental conditions, contact your service personnel.**
 - **Check the accessories and their packages for any sign of damage. Do not use them if any damage is detected.**
 - **Use the accessories before the expiry date if their expiry date is indicated.**
 - **The disposable accessories shall be disposed of according to hospital's regulations.**
-

20.1 SpO₂ Accessories

Wavelength emitted by the sensors is between 600 nm and 1000 nm. The maximum photic output consumption of the sensor is less than 18 mW.

The information about the wavelength range and maximum photic output consumption can be especially useful to clinicians, for example, when photodynamic therapy is performed.

20.1.1 Extension Cables and Adapter Cables Available for Purchase

Model	Part No.	Description	Usage	Applicable patient
572A	0010-20-42712	8-pin SpO ₂ extension cable, Nellcor	Reusable	/
583A	040-003310-00	8-pin, RD SET, Masimo	Reusable	/
4089	040-003381-00	RD to LNC adapter cable, Masimo	Reusable	/
4092	040-003426-00	LNCS to RD Adapter, Masimo	Reusable	/

20.1.2 Extension Cables and Adapter Cables Also Compatible

Model	Part No.	Description	Usage	Applicable patient
582A	115-020768-00	8-pin SpO ₂ extension cable, Masimo	Reusable	/

20.1.3 Masimo SpO₂ RD Set Sensors Available for Purchase

Model	Part No.	Description	Usage	Applicable patient
4050	040-003376-00	SpO ₂ sensor, RD SET DCI, finger-clip or toe-clip	Reusable	Adult (> 30 kg)
4051	040-003377-00	SpO ₂ sensor, RD SET DCI, finger-clip or toe-clip	Reusable	Pediatric (10-50 kg)
4053	040-003380-00	SpO ₂ sensor, RD Set TC-I, tip-clip ear sensor, 3ft	Reusable	Adult (> 30 kg)
4000	040-003382-00	SpO ₂ sensor, RD SET, adhesive, finger or toe	Disposable	Adult (> 30 kg)
4001	040-003383-00	SpO ₂ sensor, RD SET PDT, adhesive, finger or toe	Disposable	Pediatric (10 to 50 kg)
4002	040-003384-00	SpO ₂ sensor, RD Set, adhesive, thumb or great toe	Disposable	Infant (3 to 20 kg)

Model	Part No.	Description	Usage	Applicable patient
4003	040-003385-00	SpO ₂ sensor, RD Set, adhesive, hand or foot (for neonate), finger or toe (for adult)	Disposable	Neonatal / Adult (<3Kg or >40Kg)
4004	040-003386-00	SpO ₂ sensor, RD Set NeoPt, adhesive hand or foot	Disposable	Neonate (<1 kg)
4005	040-003387-00	SpO ₂ sensor, RD Set NeoPt-500, non-adhesive hand or foot	Disposable	Neonate (<1 kg)

20.1.4 Masimo SpO₂ LNCS Sensors Also Compatible

Model	Part No.	Description	Usage	Applicable patient
LNCS Amtx	0600-00-0121	SpO ₂ sensor, finger-clip, 20 pcs/box, adhesive, thumb or great toe	Disposable	Adult (>30 kg)
LNCS Pmtx	0600-00-0122	SpO ₂ sensor, finger-clip, 20 pcs/box, adhesive, finger or toe	Disposable	Pediatric (10-50 kg)
LNCS DCI	0600-00-0126	SpO ₂ sensor, finger-clip or toe-clip	Disposable	Adult (>30 kg)
LNCS DCIP	0600-00-0127	SpO ₂ sensor, finger-clip or toe-clip	Disposable	Pediatric (10-50 kg)
LNCS NeoPt	0600-00-0156	SpO ₂ sensor, adhesive, hand or foot	Disposable	Neonate (<1Kg)
LNCS Neo-L	0600-00-0157	SpO ₂ sensor, 20 pcs/box, adhesive, hand or foot (for neonate), finger or toe (for adult)	Disposable	Neonate / Adult (<3 kg or > 40 kg)
LNCS Inf	0600-00-0158	SpO ₂ sensor, 20 pcs/box, adhesive, thumb or great toe	Disposable	Infant (3-20 kg)

20.1.5 Nellcor SpO₂ Sensors Also Compatible

Model	Part No.	Description	Usage	Applicable patient
DS-100A	9000-10-05161	SpO ₂ sensor, finger-clip	Reusable	Adult
D-YS	0010-10-12476	SpO ₂ sensor, with wraps, foot (1-3 kg), toe (3-15 kg), or finger (>15 kg)	Reusable	Adult/ Pediatric/ Infant/ Neonate (>1 kg)
OXI-P/I	9000-10-07308	SpO ₂ sensor, finger, band	Reusable	Pediatric/ Infant
OXI-A/N	9000-10-07336	SpO ₂ sensor, finger/foot, band	Reusable	Adult/Neonate
MAX-AI	0010-10-12202	SpO ₂ sensor, 24 pcs/box, finger	Disposable	Adult (>30 kg)
MAX-PI	0010-10-12203	SpO ₂ sensor, 24 pcs/box, finger	Disposable	Pediatric (10-50 Kg)
MAX-II	0010-10-12204	SpO ₂ sensor, 24 pcs/box, toe	Disposable	Infant (3-20 kg)
MAX-NI	0010-10-12205	SpO ₂ sensor, 24 pcs/box, finger (for adult) or foot (for neonate)	Disposable	Adult/Neonate (<3 kg or >40 kg)

20.2 NIBP Accessories

20.2.1 NIBP Hoses Available for Purchase

Model	Part No.	Description	Usage	Applicable patient
CM1903	6200-30-09688	NIBP Hose, Inbuilt connector(3m)	Reusable	Adult/ Pediatric/ Neonate

20.2.2 Cuffs Available for Purchase

Model	Part No.	Description	Usage	Applicable patient
CM1301	115-027713-00	Cuff, 10-19 cm, bladderless	Reusable	Infant
CM1302	115-027714-00	Cuff, 18-26 cm, bladderless	Reusable	Small Adult
CM1303	115-027715-00	Cuff, 25-35 cm, bladderless	Reusable	Adult
CM1304	115-027716-00	Cuff, 33-47 cm, bladderless	Reusable	Adult
CM1305	115-027717-00	Cuff, 46-66 cm, bladderless	Reusable	Adult thigh
CM1306	115-027718-00	Cuff, 24-35 cm, bladderless	Reusable	Adult
CM1307	115-027719-00	Cuff, 33-47 cm, bladderless	Reusable	Adult
CM1501	115-027563-00	Cuff, 10-19 cm, bladderless, pkg of 10	Disposable	Infant
CM1502	115-027564-00	Cuff, 18-26 cm, bladderless, pkg of 10	Disposable	Pediatric
CM1503	115-027565-00	Cuff, 25-35 cm, bladderless, pkg of 10	Disposable	Adult
CM1504	115-027566-00	Cuff, 33-47 cm, bladderless, pkg of 10	Disposable	Adult
CM1505	115-027567-00	Cuff, 46-66 cm, bladderless, pkg of 5	Disposable	Adult thigh
CM1506	115-027568-00	Cuff, 25-35 cm, bladderless, pkg of 10	Disposable	Adult
CM1507	115-027569-00	Cuff, 33-47 cm, bladderless, pkg of 10	Disposable	Adult
CM1500A	125-000051-00	Cuff, 3.1-5.7 cm, pkg of 20	Disposable	Neonate
CM1500B	125-000052-00	Cuff, 4.3-8.0 cm, pkg of 20	Disposable	Neonate
CM1500C	125-000053-00	Cuff, 5.8-10.9 cm, pkg of 20	Disposable	Neonate
CM1500D	125-000054-00	Cuff, 7.1-13.1 cm, pkg of 20	Disposable	Neonate
CM1500E	125-000055-00	Cuff, 5#, 8-15 cm, pkg of 20	Disposable	Neonate
/	115-031807-00	Cuff starter kit, bladderless	Reusable	Child/Small adult/ Adult/ Adult thigh

20.3 Temp Accessories

20.3.1 TrueTemp™ Probes Available for Purchase

Model	PN	Description	Usage	Applicable patient
MR441	125-000155-00	Oral/Axillary temperature probe(blue)	Reusable	Adult, pediatric, neonate
MR442	125-000156-00	Rectal temperature probe(red)	Reusable	

20.3.2 TrueTemp™ Probe Wells Available for Purchase

Model	PN	Description	Usage	Applicable patient
MR493	125-000157-00	Probe well (blue, Oral/axillary)	Reusable	/
MR494	125-000158-00	Probe well (red, Rectal)	Reusable	/

20.3.3 TrueTemp™ Probe Covers Available for Purchase

Model	PN	Description	Usage	Applicable patient
ST-002	040-006486-00	Disposable probe cover (1 box of 20pcs)	Disposable	Adult, pediatric, neonate
ST-002	040-006506-00	Disposable probe cover pack(200pcs)	Disposable	Adult, pediatric, neonate

20.3.4 Exergen Temp Probe Available for Purchase

Model	Part No.	Description	Usage	Applicable patient
124237-AF-MR	040-003273-00	TAT-5000S Temporal Scanner	Reusable	Adult, pediatric, neonate

20.4 Mount and Mounting Accessories

PN	Description
045-004267-00	Rolling stand (Standard)
045-004269-00	Rolling stand (with workbench & battery)
045-004285-00	Bracket for hand sanitizer
045-002935-00	Bracket for sterile gauze
045-003427-00	Wall Mount Bracket
115-025386-00	Wall Mount for Kaiser - 6"
045-003424-00	Quick Release Tray
115-084841-00	Bedrail Clamp

20.5 Miscellaneous Accessories

PN	Description
DA8K-10-14452	U.S. Power Cord
0012-25-0001	U.S. Power Cord
009-003116-00	Nurse Call Cable
009-003436-00	Serial Port Cable
0198-00-0044	Welch Allyn SureTemp Plus Probe Covers
0992-00-0198	Welch Allyn SureTemp Plus Thermometer Module
0992-00-0213-02	Welch Allyn SureTemp Plus Oral Probe
040-002471-00	SURETEMP probe cover, WELCH ALLYN, QTY 7500
115-037896-00	Li-ion Battery (10.95V, 5200mAh, LI23S003H, VS 8)
115-008393-00	Barcode scanner kit (1D)
115-039575-00	2D Barcode reader, HS-1M, JADAK
115-039635-00	2D Barcode reader, HS-1R, JADAK
023-002111-00	2D Barcode reader, HS-1RS, JADAK

PN	Description
023-002134-00	2D Barcode reader, HH450
023-000218-00	USB Drive, 32GB, USB3.0
023-001673-00	USB Drive, 8GB, MLC, USB3.0
0683-00-0505-02	PAPER, PKG12ROLLS
A30-000001---	Recording paper, 50 mm*20 m

A Product Specifications

A.1 Monitor Safety Specifications

The equipment is classified, according to IEC60601-1:

Type of protection against electrical shock	CLASS I EQUIPMENT, equipment energized from an external and internal electrical power source.
Degree of protection against electrical shock	DEFIBRILLATION-PROOF TYPE CF APPLIED PART for SpO ₂ , NIBP, TrueTemp™ Temp DEFIBRILLATION-PROOF TYPE BF APPLIED PART for Exergen TemporalScanner™ Temp.
Mode of operation	Continuous
Degree of protection against harmful ingress of water	IPX2 (Protection against vertically falling water drops when ENCLOSURE tilted up to 15°)
Degree of safety of application in the presence of a FLAMMABLE ANAESTHETIC MIXTURE WITH AIR or WITH OXYGEN OR NITROUS OXIDE	EQUIPMENT not suitable for use in the presence of a FLAMMABLE ANAESTHETIC MIXTURE WITH AIR or WITH OXYGEN OR NITROUS OXIDE
Degree of mobility	Portable

A.2 Environmental Specifications

WARNING

- **The equipment may not meet the performance specifications if stored or used outside the specified temperature and humidity ranges. If the performance of the equipment is degraded due to aging or environmental conditions, contact your service personnel.**
 - **When the monitor and related products have differing environmental specifications, the effective range for the combined products is that range which is common to the specifications for all products.**
-
-

NOTE

- **The environmental specifications of unspecified parameter modules are the same as those of the main unit.**

Main Unit

Item	Operating conditions	Storage conditions
Temperature	0 to 40 °C	-20 to 60 °C
Relative humidity (non-condensing)	15% to 95%	10% to 95%
Barometric	427.5 mmHg to 805.5 mmHg (57.0 kPa to 107.4 kPa)	120 to 805.5 mmHg (16.0 kPa to 107.4 kPa)

TrueTemp™ Temperature Module

Item	Operating conditions	Storage conditions
Temperature	5 °C to 40 °C	Same as the main unit
Relative humidity (non-condensing)	Same as the main unit	Same as the main unit
Barometric	Same as the main unit	Same as the main unit

Exergen TemporalScanner Thermometer

Item	Operating conditions	Storage conditions
Temperature	15.5°C to 40 °C (60°F to 104°F)	-20°C to 50 °C (-4°F to 122°F)
Relative humidity (non-condensing)	up to 95%	up to 95%

A.3 Power Supply Specifications

AC Power

Line voltage	100 to 240 VAC (±10%)
Current	0.9 to 0.5 A
Frequency	50/60 Hz (±3 Hz)
Fuse	T2AL-250V

Battery

Battery Type	Chargeable non-Smart Lithium-Ion battery
Voltage	10.95 VDC
Capacity	5200 mAh
Run time	At least 8 hours when powered by a new fully-charged battery at 25 °C ±5 °C on standard configuration (SpO ₂ and NIBP), with SpO ₂ sensor connected, auto NIBP measurements at an interval of 15 minutes and screen brightness set to factory default.
Charge time	Monitor power off or standby: less than 4 hours to 100% (at 25 °C ±5 °C). Monitor power on (in non-standby mode): less than 11.5 hours to 100%.
Shutdown delay	At least 20 minutes (after a low battery alarm first occurs) at 25 °C ±5 °C with SpO ₂ sensor connected, and auto NIBP measurements at an interval of 15 minutes, and brightness set to factory default.

A.4 Physical Specifications

Size (H*W*D)	≤ 252mm x 170mm x150mm
Weight	≤2.7 kg (with Masimo SpO ₂ module, NIBP module, recorder module and a 5200 mAh battery; capacitive screen, without accessory)

A.5 Hardware Specifications

A.5.1 Display

Screen type	Capacitive touch screen
Screen Size (diagonal)	8"
Resolution	1024×768 pixels

A.5.2 Recorder

Method	Thermal dot array
Paper speed	25 mm/s
Number of waveform channels	1

A.5.3 LEDs

Alarm lamp	1 (three color coded: red, yellow and cyan)
Power on LED	1 (green)
AC power LED	1 (green)
Battery LED	1 (two color coded: yellow and green)

A.5.4 Audio Indicator

Speaker	Give alarm tones (45 to 85 dB), key tones, pulse tone; power-on self-check tone, support PITCH TONE and multi-level tone modulation; alarm tones comply with IEC60601-1-8.
---------	--

A.5.5 Monitor Interface Specifications

Power	1 AC power input connector
Wired network	1 RJ45 connector, 100 BASE-TX
USB	2 standard connectors, USB 2.0, type A
Equipotential Grounding Terminal	1
Multi-Functions Connector	1 MINI-D RIBBON connector
External battery connector	1

A.5.6 Outputs

Nurse Call Signal	
Amplitude	High level: 3.5 to 5 V, $\pm 5\%$, providing a minimum of 10 mA output current Low level: < 0.5 V, receiving a minimum of 5 mA input current
Rising and falling time	≤ 1 ms
Alarm output (Network connector)	
Alarm delay time from monitor to remote equipment	The alarm delay time from the monitor to remote equipment is ≤ 2 seconds, measured at the monitor's signal output connector.

A.5.7 Wireless Network

Standards	IEEE 802.11a/b/g/n/ac
Modulation mode	BPSK, QPSK, 16QAM, 64QAM, 256QAM
Operating frequency	2412MHz~2462MHz, 5180MHz~5320MHz, 5500MHz~5700MHz, 5745MHz~5825MHz
Wireless data rate	IEEE 802.11a: 6-54 Mbps IEEE 802.11b: 1-11 Mbps IEEE 802.11g: 6-54 Mbps IEEE 802.11n: MCS0-MCS7 IEEE 802.11ac: MCS0-MCS8
Output power	<20 dBm (CE requirements, detection mode: RMS) <30 dBm (FCC requirements, detection mode: peak power)
Working mode	Infrastructure
Data security	Standard: WPA/WPA2-PSK, WPA/WPA2-Enterprise, WPA/WPA2 CCKM EAP method: LEAP, EAP-TTLS, EAP-TLS, EAP-FAST, PEAP-MsChapV2, PEAP-GTC, PEAP-TLS Encryption: AES

A.5.8 Wi-Fi Performance Specifications

WARNING

- **All network functions of data communication are designed to operate on a private network.**
-

A.5.8.1 System Capacity

Number of the monitors supported by a single AP: ≤ 16

Testing conditions are as follows:

- Each monitor can communicate with the CMS.
- Only one monitor can transmit history data.
- The weakest strength of the AP signal where the monitor is located cannot be less than -65 dBm.

A.5.8.2 Resistance to Wireless Interference

The distance between the interfering devices and the monitor is greater than 20 cm. A Wi-Fi interference (no greater than -85 dBm) in the same channel and a Wi-Fi interference (no greater than -50 dBm) in an adjacent channel are presented synchronously. The interfering devices include 2.4 GHz wireless devices, cellular mobile networks, microwave ovens, intercoms, cordless phones, and ESU equipment. The interfering devices do not include Wi-Fi devices.

The monitoring network must support the following requirements:

- The total delay of data transmission from the monitor to the CMS: ≤ 2 seconds.
- The delay for monitor-related settings configured at the CMS to be effective: ≤ 2 seconds.

NOTE

- **When equipment works at 2.4GHz, in the application scenario, the most serious interference source is other 2.4GHz Wi-Fi devices that not sharing the same network with equipment and LTE devices. When equipment works at 5GHz, the most serious interference source is other 5GHz Wi-Fi devices that not sharing the same network with equipment.**
- **To make sure equipment works well, user should make sure the separation distance between equipment or the AP that equipment is connecting and the Unintended interference devices be longer than the distance showing below:**

Frequency band	Unintended signals	Separation distance between the monitor and the interference devices	Separation distance between the AP and the interference devices
2.4GHz WiFi (2412-2462MHz)	Adjacent channel 1 and 11(802.11n)	0.2m	1.0m
	Co-channel	2.5m	4.0m
	lower adjacent band LTE of 10MHz	0.2m	0.5m
	upper adjacent band LTE of 10MHz	0.2m	0.5m
	Adjacent channel 1 and 11 (802.11n), lower adjacent band LTE of 1.4MHz, upper adjacent band LTE of 1.4MHz	0.2m	1.0m
	lower adjacent band LTE of 10MHz, upper adjacent band LTE of 1.4MHz and Adjacent channel 6(802.11n)	0.2m	0.5m
5GHz WiFi (5190-5210MHz)	Adjacent	2.0m	4m
	Co-channel	7.0m	8.5m

Frequency band	Unintended signals	Separation distance between the monitor and the interference devices	Separation distance between the AP and the interference devices
5GHz WiFi (5270-5290MHz)	Adjacent	2.0m	4m
	Co-channel	7.0m	8.5m
5GHz WiFi (5590-5610MHz)	Adjacent	2.0m	4m
	Co-channel	7.0m	8.5m
5GHz WiFi (5755-5775MHz)	Adjacent	2.0m	4m
	Co-channel	7.0m	8.5m

A.5.8.3 Wi-Fi Network Stability

There is no communication data loss when the monitor moves at a speed not higher than 3.75 m/s in a 15 meter obstacle-free linear range.

16 monitors are connected to the same AP and each roams for 30 times, of which at least 3 monitors roam simultaneously. The ratio of the communication data loss on the CMS from any monitor does not exceed 0.1% over a 24-hour period.

A.5.8.4 Line of Sight Distance

The line of sight distance between the monitor and the AP is no less than 50 meters.

A.5.9 Bluetooth Specification

Protocol	Bluetooth 5
Modulation mode	GFSK
Operating frequency	2402 to 2480MHz
Wireless data rate	2Mbps, 1Mbps, 125kbps
Output power	≤ 8 dBm ± 4 dB
Data security	AES128

A.5.10 Bluetooth Performance Specifications

WARNING

- **Keep the monitor away from interference sources.**
 - **Do not use Bluetooth nodes to perform realtime vital signs monitoring.**
-

NOTE

- **When equipment using Bluetooth function, possible sources of interference include:**
 - ◆ IEEE 802.11b/g/n: 2.4GHz
 - ◆ LTE: Band 40: 2.3GHz, Band 41: 2.5GHz (Adjacent band)
- **To make sure equipment works well, user should make sure the separation distance between equipment or Bluetooth Node and the Unintended interference devices be longer than the distance showing below:**

Frequency band	Unintended signals	Put the monitors close to the interference devices		Put the Bluetooth Nodes close to the interference devices	
		Separation distance A	Operation distance B	Separation distance A	Operation distance B
Bluetooth mode (2402-2480MHz)	Wi-Fi (802.11n) channel 1 and 11, lower adjacent band LTE, upper adjacent band LTE	0.2m	10m	0.2m	10m
	Wi-Fi (802.11n) channel 6	0.2m	10m	0.2m	10m
	Wi-Fi (802.11n) channel 6, lower adjacent band LTE, upper adjacent band LTE	0.2m	10m	0.2m	10m

A.5.10.1 System Capacity

In a range of 10 m², there should be no more than 3 groups of paired monitors and bluetooth nodes working simultaneously.

A.5.10.2 Resistance to Interference

The distance between the interfering devices and the monitor is greater than 20 cm. The interfering devices include 2.4 GHz Wi-Fi devices, bluetooth communication devices, remote controls, microwave ovens, intercoms, cellular mobile networks, and cordless phones.

The monitoring network must support the following requirements:

- The total delay of data transmission from the monitor to the bluetooth node: ≤ 6 seconds.

- The success rate for transmission of vital signs data from the monitor to the bluetooth node: > 99%.

A.5.10.3 Line of Sight Distance

The line of sight distance between the monitor and the bluetooth node is no less than 10 meters.

A.6 Measurement Specifications

A.6.1 SpO₂ Specifications

Alarm limit	Range (%)	Step (%)
SpO ₂ High	(low limit + 2) to 100	1
SpO ₂ Low	Masimo: (Desat + 1) to (high limit - 2) Nellcor: (Desat+1) or 20 (whichever is greater) to (high limit - 2)	
Desat	0 to (low limit - 1)	

Masimo SpO₂ Module

Standards	meets the requirements of ISO 80601-2-61
SpO ₂ Measurement range	1% to 100%
PI measurement range	0.02 to 20%
SpO ₂ Resolution	1%
PI Resolution	PI < 10.0: 0.01 PI ≥ 10.0: 0.1
Accuracy ¹	70% to 100%: ±2% ABS (without motion in adult/pediatric mode) 70% to 100%: ±3% ABS (without motion in neonate mode) 70% to 100%: ±3% ABS (with motion) 1% to 69%: Not specified.
Refreshing rate	≤ 1 s
Response time	≤ 20 s (normal perfusion, no disturbance, SpO ₂ value sudden change within 70% – 100%)
SpO ₂ averaging time	2-4 s, 4-6 s, 8 s, 10 s, 12 s, 14 s, 16 s
Low perfusion conditions	Pulse amplitude: >0.02% Light penetration: >5%

Low perfusion SpO ₂ accuracy ²	±2%
<p>¹ The Masimo pulse oximeter with sensors have been validated for no motion accuracy in human blood studies on healthy adult volunteers in induced hypoxia studies in the range of 70% to 100% SpO₂ against a laboratory co-oximeter and ECG monitor. This variation equals plus or minus one standard deviation. Plus or minus one standard deviation encompasses 68% of the population. One percent was added to the accuracies for neonatal sensors to account for accuracy variation due to properties of fetal hemoglobin. The Masimo pulse oximeter with sensors has been validated for motion accuracy in human blood studies on healthy adult volunteers in induced hypoxia studies while performing rubbing and tapping motions at 2 to 4 Hz. At an amplitude of 1 to 2 cm and non-repetitive motion between 1 to 5 Hz. At an amplitude of 2 to 3 cm in induced hypoxia studies in the range of 70% to 100% SpO₂ against a laboratory co-oximeter and ECG monitor. This variation equals plus or minus one standard deviation. Plus or minus one standard deviation encompasses 68% of the population.</p> <p>² The Masimo pulse oximeter has been validated for low perfusion accuracy in bench top testing against a Biotek Index 2 simulator and Masimo's simulator with signal strengths of greater than 0.02% and a % transmission of greater than 5% for saturations ranging from 70 to 100%. This variation equals plus or minus one standard deviation. Plus or minus one standard deviation encompasses 68% of the population.</p>	

Nellcor SpO₂ Module

Standards	Meet standards of ISO 80601-2-61
Measurement range	0% to 100%
Resolution	1%
Accuracy	70% to 100%: ±2%ABS (adult/pediatric mode) 70% to 100%: ±3% ABS (neonate mode) 0% to 69%: Not specified.
Refreshing rate	≤ 1 s
Response time	≤ 30 s (normal perfusion, no disturbance, SpO ₂ value sudden change within 70% – 100%)
<p>* When the SpO₂ sensor is applied for neonatal patients as indicated, the specified accuracy range is increased by ±1%, to compensate for the theoretical effect on oximeter measurements of fetal hemoglobin in neonatal blood.</p>	

Information of the Test Subjects of the Clinical Study Report

Skin color	Gender	Number	Age (years)	Health
Black	Male	1	28.2±9.19	Healthy
	Female	1		
Yellow	Male	3		
	Female	9		

A.6.2 PR Specifications

Alarm limit	Range (bpm)	Step (bpm)
PR High	PR ≤ 40: (low limit +2) to 40 PR > 40: (low limit +5) to 300	PR ≤ 40: 1 PR > 40: 5
PR Low	PR ≤ 40: 15 to (high limit - 2) PR > 40: 40 to (high limit - 5)	

PR from Masimo SpO₂ Module

Measurement range	25 to 240 bpm
Resolution	1 bpm
Response time	≤ 20 s (normal perfusion, no disturbance, PR value sudden change within 25 – 220 bpm)
Accuracy	±3 bpm (without motion) ±5 bpm (with motion)
Low perfusion conditions	Pulse amplitude: >0.02% Light penetration: >5%
Low perfusion PR accuracy ¹	±3 bpm
Refreshing rate	≤ 1 s
<p>¹ The Masimo pulse oximeter has been validated for low perfusion accuracy in bench top testing against a Biotech Index 2 simulator and Masimo's simulator with signal strengths of greater than 0.02% and a % transmission of greater than 5% for saturations ranging from 70 to 100%. This variation equals plus or minus one standard deviation. Plus or minus one standard deviation encompasses 68% of the population.</p>	

PR from Nellcor SpO₂ Module

Measurement range	20 to 300 bpm
Resolution	1 bpm
Response time	≤30 s (normal perfusion, no disturbance, PR value sudden change within 25 – 250 bpm)
Accuracy	20 to 250 bpm: ±3 bpm 251 to 300 bpm: not specified
Refreshing rate	≤ 1 s

PR from NIBP Module

Measurement range	30 to 300 bpm (adult/pediatric/neonate)
Resolution	1 bpm
Accuracy	±3 bpm or ±3%, whichever is greater

A.6.3 NIBP Specifications

Standards	Meet standards of IEC 80601-2-30, ISO 81060-2			
Technique	Oscillometry			
Mode of operation	Manual, Auto, STAT, Sequence, and BP averaging			
Auto mode repetition intervals	1 min, 2 min, 2.5 min, 3 min, 5 min, 10 min, 15 min, 20 min, 30 min, 1 hour, 1.5 hours, 2 hours, 3 hours, 4 hours, 8 hours			
STAT mode cycle time	5 min			
Typical measurement time	Adult: ≤ 15 s (Inflation algorithm, measured with CM1203/CM1303/CM1503 cuff, PR within 60 to 200 bpm and systolic pressure within 80 to 120 mmHg)			
	Pediatric: ≤ 15 s (Inflation algorithm, measured with CM1202/CM1302/CM1502 cuff, PR within 60 to 200 bpm and systolic pressure within 80 to 120 mmHg)			
Max measurement time	Adult, pediatric:	180 s		
	Neonate:	90 s		
Heart rate range	30 to 300bpm			
Measurement ranges (mmHg)		Adult	Pediatric	Neonate
	Systolic:	25 to 290	25 to 240	25 to 140
	Diastolic:	10 to 250	10 to 200	10 to 115
	Mean:	15 to 260	15 to 215	15 to 125
Accuracy	Max average error: ± 5 mmHg Max standard deviation: 8 mmHg			
Static pressure measurement range	0 mmHg to 300 mmHg			
Static pressure measurement accuracy	± 3 mmHg			
Resolution	1 mmHg			
Initial cuff inflation pressure range (mmHg) (for Deflation algorithm)	Adult:	80 to 280		
	Pediatric:	80 to 210		
	Neonate:	60 to 140		
Default initial cuff inflation pressure (mmHg) (for Deflation algorithm)	Adult:	160		
	Pediatric:	140		
	Neonate:	90		

Software overpressure protection	Adult: Pediatric: Neonate:	297±3 mmHg 297±3 mmHg 147±3 mmHg
Hardware overpressure protection	Adult: Pediatric: Neonate:	≤330 mmHg ≤330 mmHg ≤165 mmHg
Alarm limit	Range (mmHg)	Step (mmHg)
Sys High	Adult: (low limit+5) to 290 Pediatric: (low limit+5) to 240 Neonate: (low limit+5) to 140	≤ 50: 1 > 50: 5
Sys Low	25 to (high limit-5)	
Mean High	Adult: (low limit+5) to 260 Pediatric: (low limit+5) to 215 Neonate: (low limit+5) to 125	
Mean Low	15 to (high limit-5)	
Dia High	Adult: (low limit+5) to 250 Pediatric: (low limit+5) to 200 Neonate: (low limit+5) to 115	
Dia Low	10 to (high limit-5)	

* Measurement accuracy verification: In adult and pediatric modes, the blood pressure measurements measured with this device are in compliance with the American National Standard for Electronic or Automated Sphygmomanometers (ANSI/AAMI SP10) in terms of mean error and standard deviation by comparing with intra-arterial or auscultatory measurements (depending on the configuration) in a typical patient population. For auscultatory reference, the 5th Korotkoff sound was used to determine the diastolic pressure. In neonatal mode, the blood pressure measurements measured with this device are in compliance with the American National Standard for Electronic or Automated Sphygmomanometers (ANSI/AAMI SP10) in terms of mean error and standard deviation by comparing with intra-arterial measurements (depending on the configuration) in a typical patient population.

A.6.4 Temp Specifications

TrueTemp™ Temperature Module

Standards	Meets standards of ASTM E1112, ASTM E1104, ISO 80601-2-56
Technique	Thermal resistance (use thermistor to measure temperature)

Operating mode	Adjusted mode (predictive mode) Direct mode (monitor mode)	
Measurement range	Monitor mode: 25 °C to 44 °C (77 °F to 111.2 °F) Predictive mode: 34 °C to 42 °C (93.2 °F to 107.6 °F)	
Laboratory accuracy (Monitor mode)	±0.1 °C (±0.2 °F)	
Resolution	0.1 °C	
Minimum measurement time for accurate readings	Monitor mode: <60 s Predictive mode (condition: room temperature 24 °C - 26 °C, no motion interference, patient temperature within 37 °C ± 0.2 °C): 4 s - 6 s (oral) 12 s - 15 s (axillary, adult) 10 s - 13 s (axillary, pediatric and neonate) 4 s - 8 s (rectal)	
Alarm limit	Range	Step
Temp High	(low limit +1) °C to 44 °C	0.1 °C
Temp Low	25 °C to (high limit -1) °C	

Statistical Results of Clinical Investigation Data (Predictive Mode)

	Clinical BIAS (Δ cb)	Limits of Agreement (LA)	Clinical Repeatability (σ)
Oral	0.03°C	0.37°C	0.14°C
Axilla	0.03°C	0.32°C	0.12°C
Rectum	-0.06°C	0.38°C	0.14°C

ASTM E1104 Standard Conformance Statement

This thermometer conforms to all of the requirements established in ASTM standard E1104. Full responsibility for the conformance of this product to the specification is assumed by **Shenzhen Mindray Bio-Medical Electronics Co., Ltd** at the following address:

Mindray Building, Keji 12th Road South, High-tech industrial park, Nanshan, Shenzhen 518057, P.R.China

Exergen TemporalScanner™ Thermometer

Operating mode	Adjusted mode
Response time	Approximately 0.04s
Measurement range	15.5°C to 42.0 °C (60.0°F to 107.6°F)
Temperature display range	15.5°C to 42.0 °C (60.0°F to 107.6°F)
Measurement accuracy	± 0.2 °C or ± 0.4 °F
Resolution	0.1 °C or 0.1 °F
Sensor type	Infrared thermopile sensor
Display type	Bright LEDs
Communication type	RS232
Battery Specifications	
Type	Alkaline battery
Voltage	9V
Run time	Approximately one hour continuous use or 15000 readings

B EMC and Radio Regulatory Compliance

B.1 EMC

The device meets the requirements of IEC 60601-1-2: 2014.

NOTE

- **Use of accessories, transducers and cables other than those specified or provided by the manufacturer of this equipment could result in increased electromagnetic emissions or decreased electromagnetic immunity of this equipment and result in improper operation.**
 - **The non-ME EQUIPMENT (e.g. information technology equipment (ITE)) that is a part of an ME SYSTEM may be disrupted by the electromagnetic interference of nearby equipment. It may be necessary to take mitigation measures, such as re-orienting or relocating the non-ME EQUIPMENT or shielding the location.**
 - **The device or its components should not be used adjacent to or stacked with other equipment. If adjacent or stacked use is necessary, the device or its components should be observed to verify normal operation in the configuration in which it will be used.**
 - **This equipment is intended for use in professional healthcare facility environment only. If it is used in a special environment, such as magnetic resonance imaging environment, the equipment/system may be disrupted by the operation of nearby equipment.**
 - **Portable RF communications equipment (including peripherals such as antenna cables and external antennas) should be used no closer than 30 cm (12 inches) to any part of the this device, including cables specified by the manufacturer. Otherwise, degradation of the performance of this device could result.**
-

Guidance and Declaration – Electromagnetic Emissions		
The device is intended for use in the electromagnetic environment specified below. The customer or the user of the device should assure that it is used in such an environment.		
Emission tests	Compliance	Electromagnetic environment – guidance
Conducted and radiated RF EMISSIONS CISPR 11	Group 1	The device uses RF energy only for its internal function. Therefore, its RF emissions are very low and are not likely to cause any interference in nearby electronic device.
Conducted and radiated RF EMISSIONS CISPR 11	Class A	The device is suitable for use in all establishments other than domestic and those directly connected to the public low-voltage power supply network that supplies buildings used for domestic purposes.
Harmonic distortion EMISSIONS IEC 61000-3-2	N/A	The device is suitable for use in all establishments, including domestic establishments and those directly connected to the public low-voltage power supply network that supplies buildings used for domestic purposes.
Voltage fluctuations/Flicker EMISSIONS IEC 61000-3-3	N/A	

If the system is operated within the electromagnetic environment listed in Table **Guidance and Declaration — Electromagnetic Immunity**, the system will remain safe and provide the following essential performance:

- Operating mode
- Accuracy
- Function
- Accessories identification
- Data stored
- Alarm
- Detect for connection

NOTE

- **If the essential performance is lost or degraded, it may be necessary to take mitigation measures, such as re-orienting or relocating the ME EQUIPMENT or ME SYSTEM or shielding the location. During this time, the user should stop using the monitor and contact the service personnel.**
- **The device needs special precautions regarding EMC and needs to be installed and put into service according to the EMC information provided below.**
- **Other devices may interfere with this device even though they meet the requirements of CISPR.**
- **When an input signal is below the minimum amplitude provided in technical specifications, erroneous measurements could result.**
- **The EMISSIONS characteristics of this device make it suitable for use in industrial areas and hospitals (CISPR 11 class A). If it is used in a residential environment (for which CISPR 11 class B is normally required) this device might not offer adequate protection to radio-frequency communication services. The user might need to take mitigation measures, such as relocating or re-orienting the device.**

Guidance and Declaration – Electromagnetic Immunity			
The device is intended for use in the electromagnetic environment specified below. The customer or the user of the device should assure that it is used in such an environment.			
Immunity test	IEC60601 test level	Compliance level	Electromagnetic environment – guidance
Electrostatic discharge (ESD) IEC 61000-4-2	±8 kV contact ±15 kV air	±8 kV contact ±15 kV air	Floors should be wood, concrete or ceramic tile. If floors are covered with synthetic material, the relative humidity should be at least 30%.
Electrical fast transient/burst IEC 61000-4-4	±2 kV for power supply lines ±1 kV for input/output lines	±2 kV for power supply lines ±1 kV for input/output lines	Mains power quality should be that of a typical commercial or hospital environment.
Surge IEC 61000-4-5	±1 kV line(s) to line(s) ±2 kV line(s) to earth	±1 kV line(s) to line(s) ±2 kV line(s) to earth	

Voltage dips and Voltage interruptions IEC 61000-4-11	<p>0% U_T for 0.5 cycle: at 0°, 45°, 90°, 135°, 180°, 225°, 270° and 315°</p> <p>0% U_T for 1 cycle and 70% U_T for 25/30 cycles: at 0°</p> <p>0% U_T for 250/300 cycles</p>	<p>0% U_T for 0.5 cycle: at 0°, 45°, 90°, 135°, 180°, 225°, 270° and 315°</p> <p>0% U_T for 1 cycle and 70% U_T for 25/30 cycles: at 0°</p> <p>0% U_T for 250/300 cycles</p>	Mains power quality should be that of a typical commercial or hospital environment. If the user of our product requires continued operation during power mains interruptions, it is recommended that our product be powered from an uninterruptible power supply or a battery.
RATED power frequency magnetic fields IEC 61000-4-8	30 A/m 50 Hz/60 Hz	30 A/m 50 Hz/60 Hz	Power frequency magnetic fields should be at levels characteristic of a typical location in a typical commercial or hospital environment.
Note: U_T is the AC mains voltage prior to application of the test level.			

Guidance and Declaration – Electromagnetic Immunity

The device is intended for use in the specified electromagnetic environment. The customer or the user of the device should assure that it is used in such an environment as described below.

Immunity test	IEC60601 test level	Compliance level	Electromagnetic environment – guidance
Conducted disturbances induced by RF fields IEC61000-4-6	3 Vrms 150 kHz to 80 MHz	3 Vrms	Portable and mobile RF communications equipment should be used no closer to any part of the device, including cables, than the recommended separation distance calculated from the equation applicable to the frequency of the transmitter. Recommended separation distance: 150k to 80 MHz $d = \left[\frac{3.5}{V} \right] \sqrt{P}$ 80 MHz to 800 MHz $d = \left[\frac{3.5}{E} \right] \sqrt{P}$ 800 MHz to 2.7GHz $d = \left[\frac{7}{E} \right] \sqrt{P}$
	6 Vrms in ISM bands and amateur radio bands ^a between 0,15 MHz and 80 MHz	6 Vrms	
Radiated RF EM fields IEC61000-4-3	3 V/m 80 MHz to 2.7 GHz	3 V/m	
Proximity fields from RF wireless communications equipment IEC61000-4-3	134,2 kHz 65 A/m	65 A/m	where P is the maximum output power rating of the transmitter in watts (W) according to the transmitter manufacturer and d is the recommended separation distance in meters (m). Field strengths from fixed RF transmitters, as determined by an electromagnetic site survey ^b , should be less than the compliance level in each frequency range ^c . Interference may occur in the vicinity of equipment marked with the following symbol: 
	13,56 MHz 7,5 A/m	7,5 A/m	
	27 V/m 380–390 MHz	27 V/m	
	28 V/m 430–470 MHz, 800–960 MHz, 1700–1990 MHz, 2400–2570 MHz	28 V/m	
	9 V/m 704–787 MHz, 5100–5800 MHz	9 V/m	

Note 1: At 80 MHz and 800 MHz, the higher frequency range applies.

Note 2: These guidelines may not apply in all situations. Electromagnetic propagation is affected by absorption and reflection from structures, objects and people.

^a The ISM (industrial, scientific, and medical) bands between 150 kHz and 80 MHz are 6.765 MHz to 6.795 MHz; 13.553 MHz to 13.567 MHz; 26.957 MHz to 27.283 MHz; and 40.66 MHz to 40.70 MHz. The amateur radio bands between 0,15 MHz and 80 MHz are 1,8 MHz to 2,0 MHz, 3,5 MHz to 4,0 MHz, 5,3 MHz to 5,4 MHz, 7 MHz to 7,3 MHz, 10,1 MHz to 10,15 MHz, 14 MHz to 14,2 MHz, 18,07 MHz to 18,17 MHz, 21,0 MHz to 21,4 MHz, 24,89 MHz to 24,99 MHz, 28,0 MHz to 29,7 MHz and 50,0 MHz to 54,0 MHz.

^b Field strengths from fixed transmitters, such as base stations for radio (cellular/cordless) telephones and land mobile radios, amateur radio, AM and FM radio broadcast and TV broadcast cannot be predicted theoretically with accuracy. To assess the electromagnetic environment due to fixed RF transmitters, an electromagnetic site survey should be considered. If the measured field strength in the location in which the device is used exceeds the applicable RF compliance level above, the device should be observed to verify normal operation. If abnormal performance is observed, additional measures may be necessary, such as re-orienting or relocating the device.

^c Over the frequency ranges 150 kHz to 80 MHz, field strengths should be less than 3V/m.

WARNING

- **The device is configured with a wireless network connector to receive wireless signal. Other devices may interfere with this device even though they meet the requirements of CISPR.**
 - **The equipment/system may be disrupted by the electromagnetic interference of nearby equipment, such as CISPR 11 group 2 medical equipment of diathermy, magnetic resonance imaging, heat penetration, Wireless Power Transfer (WPT), electrocautery, Electronic Article Surveillance (EAS), and microwave therapy. It may be necessary to take mitigation measures, such as re-orienting, relocating or shielding the location.**
-
-

Recommended Separation Distances between Portable and Mobile RF Communications Equipment and This Equipment

The equipment is intended for use in an electromagnetic environment in which radiated RF disturbance are controlled. The customer or the user of the device can help prevent electromagnetic interference by maintaining a minimum distance between portable and mobile RF communications equipment (transmitters) and the device as recommended below, according to the maximum output power of the communication equipment.

Rated Maximum Output power of Transmitter Watts (W)	Separation Distance According to Frequency of Transmitter (m)		
	150 kHz to 80 MHz $d = \left[\frac{3.5}{V} \right] \sqrt{P}$	80 MHz to 800 MHz $d = \left[\frac{3.5}{E} \right] \sqrt{P}$	800 MHz to 2.7 GHz $d = \left[\frac{7}{E} \right] \sqrt{P}$
0.01	0.12	0.12	0.23
0.1	0.38	0.38	0.73
1	1.2	1.2	2.3
10	3.8	3.8	7.3
100	12	12	23

For transmitters at a maximum output power not listed above, the recommended separation distance in meters (m) can be determined using the equation applicable to the frequency of the transmitter, where P is the maximum output power rating of the transmitter in watts (W) according to the transmitter manufacturer.

Note 1: At 80 MHz and 800 MHz, the higher frequency range applies.

Note 2: These guidelines may not apply in all situations. Electromagnetic propagation is affected by absorption and reflection from structures, objects and people.

B.2 Radio Regulatory Compliance

This device complies with Part 15 of the FCC Rules and RSS-210 of Industry Canada. Operation is subject to the following two conditions: (1) this device may not cause harmful interference, and (2) this device must accept any interference received, including interference that may cause undesired operation.

Any changes or modifications to this equipment not expressly approved by Mindray may cause harmful radio frequency interference and void your authority to operate this equipment.

The maximum antenna gain permitted complies with the e.i.r.p. limits as stated in RSS-210.

The maximum antenna gain permitted complies with the e.i.r.p. limits specified for point-to-point operation, as stated in RSS-210.

WARNING

- **Changes or modifications not expressly approved by the party responsible compliance could void the user's authority to operate the equipment.**
-
-

This page intentionally left blank.

C Default Settings

C.1 Parameters Default Settings

C.1.1 SpO2 Default Settings

Item		Default Setting	
Alarm	SpO2	On/Off	On
		High	Adult and pediatric: 100% Neonate: 95%
		Low	90%
		Priority	Med
	SpO2 Desat	On/Off	On
		Low	80%
		Priority	High
	NIBP Simul		Off
	Sat-Seconds (for Nellcor SpO ₂)		Off
	Setup	Sensitivity (for Masimo SpO ₂)	
Display PI (for Masimo SpO ₂)		On	
Speed		25 mm/sec	
Averaging (for Masimo SpO ₂)		8 s	
Display SIQ (for Masimo SpO ₂)		Off	
Fast SAT (for Masimo SpO ₂)		Off	

C.1.2 PR Default Settings

Item			Default Setting
PR Alarm	PR	On/Off	On
		High	Adult: 120 Pediatric: 160 Neonate: 200
		Low	Adult: 50 Pediatric: 75 Neonate: 100
		Priority	Med
PR Setup	Pulse Volume		2

C.1.3 Temp Default Settings (TrueTemp™)

Item			Default Setting
Alarm	Temp	On/Off	Off
		High	38.0 °C
		Low	35.0 °C
		Priority	Med

C.1.4 NIBP Default Settings

Item			Default Setting
Alarm	NIBP-S	On/Off	On
		High	Adult: 160 mmHg Pediatric: 120 mmHg Neonate: 90 mmHg
		Low	Adult: 90 mmHg Pediatric: 70 mmHg Neonate: 40 mmHg
		Priority	Med

Item			Default Setting
Alarm	NIBP-D	On/Off	On
		High	Adult: 90 mmHg Pediatric: 70 mmHg Neonate: 60 mmHg
		Low	Adult: 50 mmHg Pediatric: 40 mmHg Neonate: 20 mmHg
		Priority	Med
	NIBP-M	On/Off	On
		High	Adult: 110 mmHg Pediatric: 90 mmHg Neonate: 70 mmHg
		Low	Adult: 60 mmHg Pediatric: 50 mmHg Neonate: 25 mmHg
		Priority	Med
	NIBP-S Extreme	On/Off	Off
		High	Adult: 175 mmHg Pediatric: 130 mmHg Neonate: 95 mmHg
		Low	Adult: 75 mmHg Pediatric: 60 mmHg Neonate: 35 mmHg
		Priority	High
	NIBP-D Extreme	On/Off	Off
		High	Adult: 105 mmHg Pediatric: 80 mmHg Neonate: 65 mmHg
		Low	Adult: 35 mmHg Pediatric: 30 mmHg Neonate: 15 mmHg
		Priority	High

Item			Default Setting
Alarm	NIBP-M Extreme	On/Off	Off
		High	Adult: 125 mmHg Pediatric: 100 mmHg Neonate: 75 mmHg
		Low	Adult: 45 mmHg Pediatric: 40 mmHg Neonate: 20 mmHg
		Priority	High
Setup	Initial Pressure		Adult: 160 mmHg Pediatric: 140 mmHg Neonate: 90 mmHg
	Interval		Sequence
	Start Mode		Clock
	NIBP End Tone		Off
	Venipuncture Pressure		Auto
	Display Format		Sys/Dia(Mean)
	Display Alarm Limits		Off
	Patient Position		Lying
	Measurement Site		Unspecified
Sequence	Phase A	Duration	1 hr
		Interval	5 min
	Phase B	Duration	4 hrs
		Interval	15 min
	Phase C	Duration	4 hrs
		Interval	30 min
	Phase D	Duration	Continuous
		Interval	1 hr
	Phase E	Duration	Off
		Interval	1 hr

C.1.5 EWS Default Settings

Item		Default Setting	
EWS	Score		NEWS2
	Score Confirmation		On
	Auto Scoring	/	Off
		Interval	By Score
			4 hrs (Score: 0)
			2 hrs (Score: 1~4)
			1 hr (Score: 5~6)
	30 min (Score: 7~20)		
	Manual Data Timeout	SpO2	4 hrs
		Supp. O2	24 hrs
		PR	1 hr
LOC		24 hrs	
Alarm	Auto Refresh Scores		On
	Alarm		Off
	EWS Score	Priority	Med
		On/Off	On
		High	5
		Priority	High
		On/Off	On
High	7		
Alarm	3 in single parameter	RR	Off, Med
		SpO2	Off, Med
		BP-S	Off, Med
		PR	Off, Med
		Temp	Off, Med

C.2 Routine Default Settings

C.2.1 Alarm Default Settings

Item	Default Setting
Alarm Volume	2
High Alarm Volume	Alarm Volume+3
Reminder Volume	2
Apnea Delay	Adult and pediatric: 20 sec Neonate: 15 sec

C.2.2 Parameter Color Default Settings

Item	Default Setting
SpO2	Cyan
NIBP	White
Temp	White
RR	Yellow

C.2.3 Display Default Settings

Item	Default Setting
Screen Lock Duration	10 sec
Brightness	5
Brightness On Battery	5

C.2.4 Volume Default Settings

Item	Default Setting
Alarm Volume	2

Item	Default Setting
High Alarm Volume	Alarm Volume+3
Reminder Volume	2
Key Volume	2

C.2.5 Record Setup

Item	Default Setting
Waveform 1	Off
Waveform 2	Off
Recording Duration	8 sec
Recorder Paper Speed	25 mm/sec

C.2.6 System Time Default Settings

Item	Default Setting
Date Format	yyyy-mm-dd
24-Hour Time	On
Daylight Savings Time	Off

This page intentionally left blank.

D Alarm Messages

This chapter lists only the physiological and technical alarm messages. Some messages appearing on your monitor may not be included. In the “Cause and solution” column, corresponding solutions are given instructing you to troubleshoot problems. If the problem persists, contact your service personnel.

NOTE

- **The gas analyzer is not an apnea monitor. The safety and effectiveness of the respiration measurement method in the detection of apnea, particularly the apnea of prematurity and apnea of infancy, has not been established.**

D.1 Physiological Alarm Messages

D.1.1 General Physiological Alarm Messages

Alarm messages	Default priority	Cause and solution
XX High	Med	XX value has risen above the high alarm limit or fallen below the low alarm limit. Check the patient’s condition and check if the patient category and alarm limit settings are correct.
XX Low	Med	

Note:XX represents a measurement or parameter label, such as NIBP, RR, SpO₂, PR, and so on.

D.1.2 SpO₂ Physiological Alarm Messages

Alarm message	Default priority	Cause and solution
SpO ₂ Low (YY hrs YY min YY sec)	High	The SpO ₂ value falls below the alarm limit. Check the patient’s condition and check if the alarm limit settings are correct.
SpO ₂ Desat (YY hrs YY min YY sec)	High	The SpO ₂ value falls below the desaturation alarm limit. Check the patient’s condition and check if the alarm limit settings are correct.

Note: YY hrs YY min YY sec represents the period of time that the SpO₂ alarm has lasted.

D.1.3 PR Physiological Alarm Messages

Alarm message	Default priority	Cause and solution
No Pulse	High	The pulse signal was so weak that the monitor cannot perform pulse analysis. Check the patient's condition and the source of the PR, such as SpO ₂ sensor, and measurement site.

D.1.4 NIBP Physiological Alarm Messages

Alarm message	Default priority	Cause and solution
NIBP-S Extremely High/NIBP-D Extremely High/ NIBP-M Extremely High	High	The NIBP value is higher than the NIBP Extreme alarm high limit. Check the patient's condition and check if the alarm limit settings are correct.
NIBP-S Extremely Low/NIBP-D Extremely Low/ NIBP-M Extremely Low	High	The NIBP value is lower than the NIBP Extreme alarm low limit. Check the patient's condition and check if the alarm limit settings are correct.

D.2 Technical Alarm Messages

This section lists technical alarms, their default priority, responses on alarm reset, and the actions that can be taken when an alarm occurs. Some of alarms may not be included.

Various technical alarms respond differently when the alarm system is reset. For easy clarification, in this section the technical alarms are classified into three categories of response when the alarm system is reset:

- A: technical alarms are cleared. The monitor gives no alarm indications.
- B: technical alarms are changed to the prompt messages.
- C: the alarm is silenced and a ✓ appears before the alarm message.

In the following tables, A, B, and C are used to refer to the responses on alarm reset.

D.2.1 General Technical Alarm Messages

Alarm message	Default priority	Indication on alarm reset	Cause and solution
XX Module Error	High	C	XX module does not work properly. Contact your service personnel.

Note:XX represents a measurement or parameter label, such as SpO₂, NIBP and so on.

D.2.2 SpO₂ Technical Alarm Messages

Alarm message	Default priority	Indication on alarm reset	Cause and solution
SpO ₂ Sensor Off	Low	B	The SpO ₂ sensor has become detached from the patient or the module. Check the sensor connection. If the alarm persists, replace the sensor.
SpO ₂ No Sensor	Low	A	The SpO ₂ extension cable is detached from the SpO ₂ module, or the SpO ₂ sensor is detached from the SpO ₂ extension cable. Check the SpO ₂ cable and the sensor connection. If the alarm persists, replace the sensor.
SpO ₂ Excess Light	Low	C	Ambient light is too strong. Move the sensor to a place with lower level of ambient light or cover the sensor to minimize the ambient light.
SpO ₂ No Pulse	Low	C	The SpO ₂ sensor failed to obtain pulse signal. Check the patient's condition and replace the sensor application site. If the alarm persists, replace the sensor.
SpO ₂ Sensor Incompatible	Low	C	Incompatible or an unspecified SpO ₂ sensor is used. Use specified sensors.

Alarm message	Default priority	Indication on alarm reset	Cause and solution
SpO2 Low Signal Quality	Low	C	<ol style="list-style-type: none"> 1. Check the sensor and sensor position. 2. Make sure the patient is not shivering or moving. 3. The patient's pulse may be too low to be measured.
SpO2 Interference	Low	C	The SpO ₂ signal has interference. Check for any possible sources of signal noise and check the patient for excessive motion.
SpO2 Sensor Error	Low	C	Replace the sensor and measure again.
SpO2 Searching Pulse	Prompt	/	SpO ₂ is searching for pulse.
SpO2 Low Perfusion	Prompt	/	<p>The SpO₂ sensor is not properly placed or the patient's perfusion index is too low.</p> <ol style="list-style-type: none"> 1. Check the sensor and sensor position. 2. Reposition the sensor if necessary.
Replace SpO2 Cable	Low	C	The SpO ₂ cable expired, cannot be recognized, or failed. Replace the SpO ₂ cable.
	Prompt		The SpO ₂ cable is about to expire. Replace the SpO ₂ cable.
Incompatible SpO2 Cable	Low	C	The SpO ₂ cable connected is not compatible with the equipment. Replace the SpO ₂ cable.
Replace SpO2 Sensor	Low	C	The SpO ₂ sensor expired. Replace the SpO ₂ sensor.
	Prompt		The SpO ₂ sensor is about to expire. Replace the SpO ₂ sensor.
Check SpO2 Sensor Connection	Low	C	No SpO ₂ sensor is connected. Connect an SpO ₂ sensor.

Alarm message	Default priority	Indication on alarm reset	Cause and solution
SpO ₂ No Cable Connected	Low	C	No SpO ₂ cable is connected. Connect an SpO ₂ cable.

D.2.3 Temp Technical Alarm Messages

Alarm message	Default priority	Indication on alarm reset	Cause and solution
Temp No Probe (for TureTemp™)	Med	B	The Temp probe is disconnected or damaged. Reconnect the probe. If the problem persists, change for another probe.
Temp Probe Misplaced (for TureTemp™)	Med	A	The measured value is invalid. Replace the probe and check the value.
Temp Measuring Timeout (for TureTemp™)	Med	B	The measurement has exceeded regular measurement time. Try another measurement.
Ambient Temp Overrange (for TureTemp™)	Low	A	The ambient temperature is too low. Move the patient to a warmer place and take temperature measurement again if necessary.
Temp Overrange (for TureTemp™)	Low	C	The temperature measurement exceeds the measurement range. Check the patient's condition.
Thermal Resistor Err (for TureTemp™)	Med	C	The Temp module may fail. Take temperature measurement again. If the alarm persists, contact your service personnel.

D.2.4 NIBP Technical Alarm Messages

Alarm message	Default priority	Indication on alarm reset	Cause and solution
NIBP Cuff Loose	Low	A	There is a leak in the cuff or air tubing. Use a cuff of correct type based on the patient size. Apply the cuff and connect the air tubing as instructed in the manual.
NIBP Timeout	Low	A	The measurement time exceeds 120 seconds in the adult or pediatric mode, or exceeds 90 seconds in the neonatal mode, and the BP value cannot be obtained. Check the patient's condition and NIBP connections, or replace the cuff and measure again.
NIBP Cuff or Airway Leak	Low	A	Check the NIBP cuff and pump for leakages.
NIBP Airway Leak	Low	A	Airway leakage is found during the NIBP leakage test. Check the NIBP cuff and pump for leakages.
NIBP Airway Error	Low	A	The air tubing may be occluded. Check the air tubing for an occlusion or kinking. If the alarm persists, contact your service personnel.
NIBP Weak Signal	Low	A	The patient's pulse is weak or the cuff is loose. Check the patient's condition and replace the cuff application site.
NIBP Excessive Motion	Low	A	Check the patient's condition and reduce patient motion.
NIBP Cuff and Patient Mismatch	Low	A	The cuff type mismatches the patient category. Verify the patient category or replace the cuff if necessary. If patient category is correct, check that the tubing is not bent and the airway is not occluded.

Alarm message	Default priority	Indication on alarm reset	Cause and solution
NIBP Cuff Overpressure	Low	A	The NIBP airway may be occluded. Check the airway and measure again. If the alarm persists, contact your service personnel.
NIBP Overrange	Low	A	The measured NIBP value exceeds the module measurement range. Check the patient's condition.

D.2.5 EWS Technical Alarms

Alarm message	Default priority	Indication on alarm reset	Cause and solution
EWS param XX is timeout	Low	A	The manually input parameter is timeout. Input a parameter numeric again.
EWS score needs to be confirmed	Low	A	Confirm to save or give up current score.

Note: XX represents RR, SpO₂, Supp. O₂, Temp, BP, Consciousness, Blood Sugar etc.

D.2.6 Power Supply Technical Alarm Messages

Alarm message	Default priority	Indication on alarm reset	Cause and solution
Low Battery	Med	C	Connect the monitor to an AC power source and allow the batteries to charge.
Critically Low Battery	High	C	Connect the monitor to an AC power source and allow the batteries to charge.
Battery Service Required	Low	B	The battery has reached its lifetime. Replace the battery.
Power Board Comm Error	High	C	Shutdown and restart the monitor. If the alarm persists, contact your service personnel.

Alarm message	Default priority	Indication on alarm reset	Cause and solution
Battery Error	High	C	The battery may have failed. Contact your service personnel.
Battery Charging Error	High	C	The charging circuit fails or the battery fails. Contact your service personnel.
Battery Temperature Too High	High	C	Stop using the monitor after this alarm appears, and contact your service personnel.
Battery Off	High	C	Shutdown and restart the monitor. If the alarm persists, contact your service personnel.
RT Clock Need Reset	High	C	Contact your service personnel.
RT Clock Not Exist	High	C	The embedded button cell is out of power.* Contact your service personnel.
*: The lifecycle of the embedded button cell is at least three years. But it does not consume power when the monitor is on.			

D.2.7 Technical Alarm Messages Related to Networked Monitoring

Alarm message	Default priority	Indication on alarm reset	Cause and solution
CMS/eGW Disconnected	Low	B	The monitor is disconnected from the CMS. Check the network connection.
WLAN IP Address Conflict	Low	C	There is a wireless network IP address conflict. Check the network settings.
LAN1 IP Address Conflict	Low	C	There is a wired network IP address conflict. Check the network settings.
Fail To Get WLAN IP Address	Low	C	Unable to automatically obtain the wireless network IP address. Check the network settings.

Alarm message	Default priority	Indication on alarm reset	Cause and solution
Fail To Get LAN1 IP Address	Low	C	Unable to automatically obtain the wired network LAN1 IP address. Check the network settings.

D.2.8 Other System Technical Alarm Messages

Alarm message	Default priority	Indication on alarm reset	Cause and solution
Storage Error	High	C	The storage card fails or files are damaged. Shutdown and restart the monitor. Format the storage card (CAUTION: this will clear all patient data stored on this monitor). If the alarm persists, contact your service personnel.
The patient data storage space is nearly full. Please delete some discharged patients.	Med	B	The storage space of the monitor is full. Delete unnecessary discharged patient.

This page intentionally left blank.

E SpO₂ Sensor Accuracy

E.1 The Accuracy of Masimo SpO₂ Sensors

Table information for the plots below show A_{RMS} values measured with Masimo Set Oximetry Technology in a clinical study.

Adtx/Pdtx/4000/4001

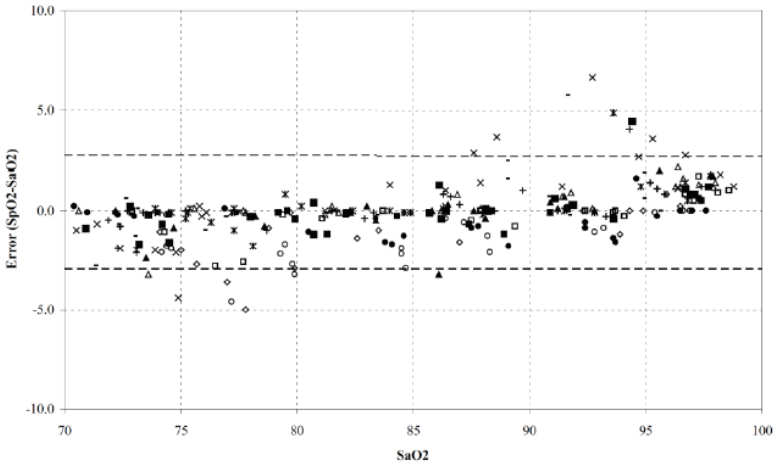

MEASURED A_{RMS} VALUES	
Range	A_{RMS}
90-100%	1.64%
80-90%	1.07%
70-80%	1.55%

Range	A_{RMS}
70-100%	± 2 %
Overall Claimed Accuracy Value	

Inf/Neo/NeoPt/4002/4003/4004/4005

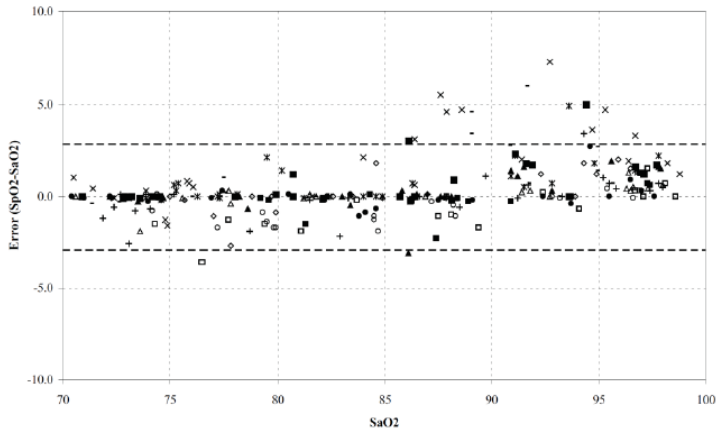

MEASURED ARMS VALUES	
Range	ARMS
90-100%	1.85%
80-90%	1.44%
70-80%	0.89%

Range	ARMS		
	Inf	Neo*	Neo Pt*
70-100%	± 2 %	±2 % Adult ±3 % Neonatal	±3 %
Overall Claimed Accuracy Value			

*The saturation accuracy of the Neonate and Preterm sensors were validated on adult volunteers and 1% was added to account for the properties of fetal hemoglobin.

DCI/DCIP/4050/4051

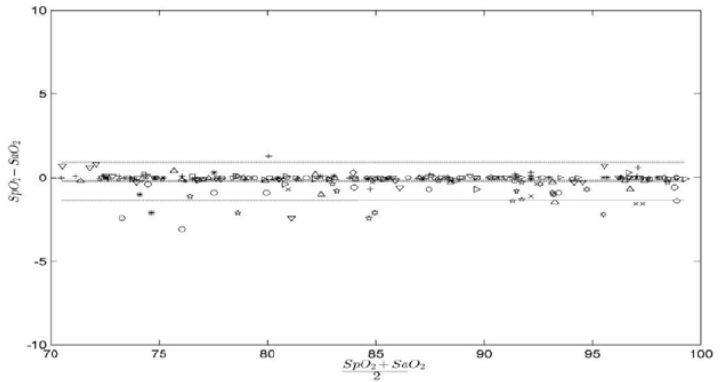

MEASURED A_{RMS} VALUES	
Range	A_{RMS}
90-100%	0.60%
80-90%	0.54%
70-80%	0.67%
Range	A_{RMS}
70-100%	2 %
Overall Claimed Accuracy Value	

LNCSY

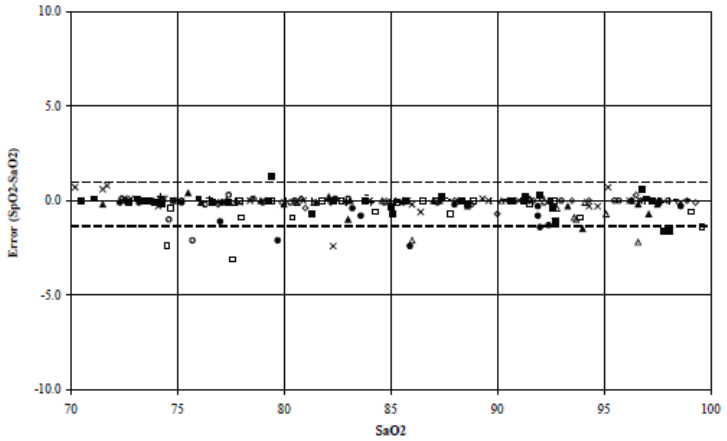

MEASURED ARMS VALUES	
RANGE	ARMS
90-100%	0.6%
80-90%	0.5%
70-80%	0.7%
OVERALL CLAIMED ACCURACY VALUE	
70-100%	± 2%

4053

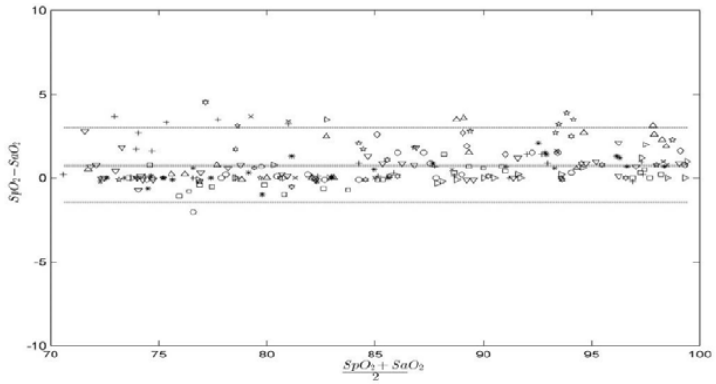

MEASURED ARMS VALUES	
Range	ARMS
90-100%	1.45%
80-90%	1.22%
70-80%	1.41%

Range	ARMS
70-100%	2 %
Overall Claimed Accuracy Value	

E.2 The Accuracy of Nellcor SpO₂ Sensors

SpO₂ Accuracy for Nellcor Sensors vs. Co-Oximeters (Arms)

SpO ₂ Range	100% to 70%	100% to 90%	90% to 80%	80% to 70%
DS-100A	1.64%	1.16%	1.67%	2.25%
D-YS, OXI-P/I, OXI-A/N	2.41%	1.38%	2.50%	3.60%
MAXAI, MAXPI, MAXII	1.62%	1.49%	1.57%	2.50%
MAXNI	1.85%	1.71%	1.51%	1.59%

Modified Bland-Altman for SpO₂ - MAXAI, MAXPI, MAXII, MAXNI Sensors: (SpO₂ - SaO₂) vs.SaO₂

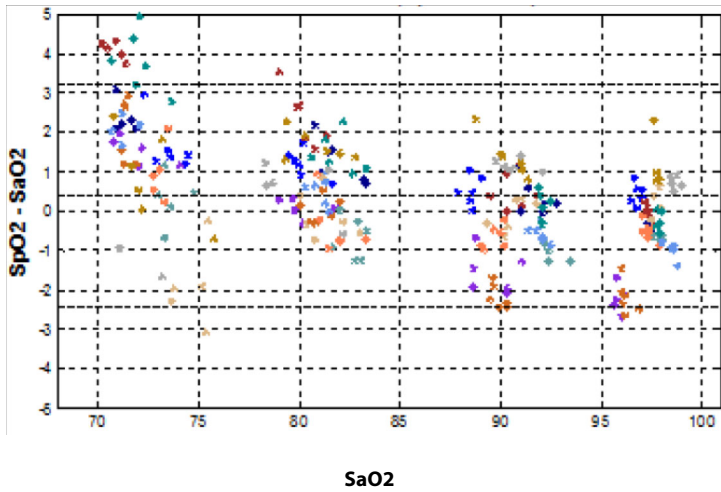

Modified Bland-Altman for SpO₂ - DS-100A Sensors: (SpO₂ - SaO₂) vs.SaO₂

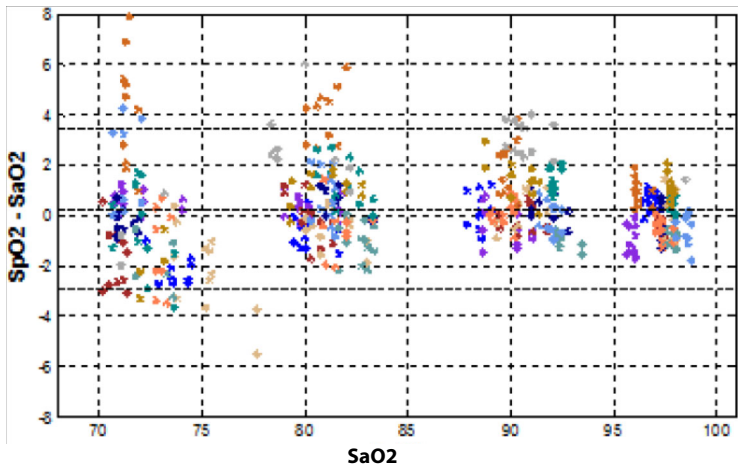

Modified Bland-Altman for SpO₂ - D-YS, OXI-A/N, OXI-P/I Sensors: (SpO₂ - SaO₂) vs.SaO₂

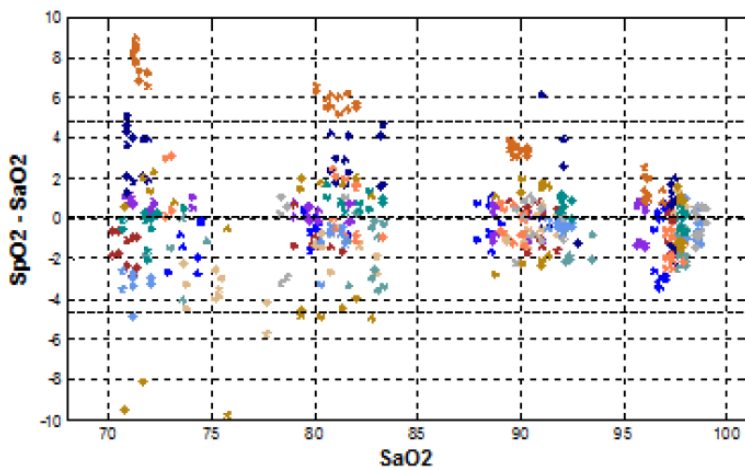

This page intentionally left blank.

F Units, Symbols and Abbreviations

F.1 Units

Abbreviation	In Full
A	Ampere
Ah	Ampere hour
bpm	beat per minute
bps	bits per second
°C	Celsius
cm	centimeter
dB	decibel
°F	Fahrenheit
g	gram
GHz	gigahertz
h	hour
Hz	hertz
in	inch
k	kilo
kg	kilogram
kPa	kilopascal
L	litre
lb	pound
m	meter
mAh	milliampere hour

Abbreviation	In Full
Mb	mega byte
mg	milligram
min	minute
ml	milliliter
mm	millimeter
mmHg	millimeters of mercury
cmH ₂ O	centimeters of water
ms	millisecond
mV	millivolt
mW	milliwatt
nm	nanometer
rpm	breaths per minute
s	second
V	volt
VA	volt ampere
W	watt

F.2 Symbols

Symbol	Explanation
-	negative, minus
%	percent
/	per; divide; or
~	to
+	plus
=	equal to

Symbol	Explanation
<	less than
>	greater than
≤	less than or equal to
≥	greater than or equal to
±	plus or minus
×	multiply
©	copyright

F.3 Abbreviations

Abbreviation	In Full
AC	alternating current
Adu	adult
AHA	American Heart Association
awRR	airway respiratory rate
BTPS	body temperature and pressure, saturated
CA	Certificate Authority
CAA	Clinical Assistive Application
CE	Conformité Européenne
CISPR	International Special Committee on Radio Interference
CMS	central monitoring system
CO ₂	carbon dioxide
COHb	carboxyhemoglobin
COPD	chronic obstructive pulmonary disease
DC	direct current

Abbreviation	In Full
Des	desflurane
Dia	diastolic
EEC	European Economic Community
EMC	electromagnetic compatibility
EMI	electromagnetic interference
ESU	electrosurgical unit
Et	end-tidal
EtCO ₂	end-tidal carbon dioxide
EWS	Early Warning Score
FCC	Federal Communication Commission
FDA	Food and Drug Administration
Fi	fraction of inspired
FICO ₂	fraction of inspired carbon oxygen
GCS	Glasgow Coma Scale
Hb	hemoglobin
IBW	ideal body weight
ICU	intensive care unit
ID	identification
I:E	inspiratory time: expiratory time ratio
IEC	International Electrotechnical Commission
IEEE	Institute of Electrical and Electronic Engineers
IP	internet protocol
LCD	liquid crystal display
LDAP	Lightweight Directory Access Protocol
LED	light emitting diode
Mb	myoglobin

Abbreviation	In Full
MetHb	methemoglobin
MEWS	Modified Early Warning Score
MLDAP	Mindray LDAP, Mindray lightweight directory access protocol
MRI	magnetic resonance imaging
MV	minute volume
N/A	not applied
Neo	neonate
NEWS	National Early Warning Score
NIBP	noninvasive blood pressure
O ₂	oxygen
O ₂ %	oxygen concentration
OR	operating room
Ped	pediatric
PI	perfusion index
Pleth	plethysmogram
PR	pulse rate
Rec	record, recording
Resp	respiration
RR	respiration rate
SpO ₂	arterial oxygen saturation from pulse oximetry
Sync	synchronization
Sys	systolic pressure
TD	temperature difference
Temp	temperature
TFT	thin-film technology

Abbreviation	In Full
TLS	Transport Layer Security
UPS	uninterruptible power supply
USB	universal serial bus

