

ePM 10M/ePM 12M

Patient Monitor

Operator's Manual

© Copyright 2020-2023 Shenzhen Mindray Bio-Medical Electronics Co., Ltd. All rights reserved.

Release time: May 2023

Revision: 9.0

WARNING

- **Federal Law (USA) restricts this device to sale by or on the order of a physician or other practitioner licensed by U.S. state law to use or order the use of this device.**
-
-

Intellectual Property Statement

SHENZHEN MINDRAY BIO-MEDICAL ELECTRONICS CO., LTD. (hereinafter called Mindray) owns the intellectual property rights to this Mindray product and this manual. This manual may refer to information protected by copyright or patents and does not convey any license under the patent rights or copyright of Mindray, or of others.

Mindray intends to maintain the contents of this manual as confidential information. Disclosure of the information in this manual in any manner whatsoever without the written permission of Mindray is strictly forbidden.

Release, amendment, reproduction, distribution, rental, adaptation, translation or any other derivative work of this manual in any manner whatsoever without the written permission of Mindray is strictly forbidden.

mindray is the trademark, registered or otherwise, of Mindray in China and other countries. All other trademarks that appear in this manual are used only for informational or editorial purposes. They are the property of their respective owners.

This posting serves as notice under 35 U.S.C. §287(a) for Mindray patents: <http://www.mindrayna.com/patents>.

Manufacturer's Responsibility

Contents of this manual are subject to changes without prior notice.

Mindray is responsible for the effects on safety, reliability and performance of this product, only if:

- all installation operations, expansions, changes, modifications and repairs of this product are conducted by Mindray authorized personnel;
- the electrical installation of the relevant room complies with the applicable national and local requirements;
- the product is used in accordance with the instructions for use.

WARNING

- **Only skilled/trained clinical professionals should operate this equipment.**
 - **It is important for the hospital or organization that uses this equipment to perform a recommended service/maintenance plan. Neglect of this may result in machine breakdown or personal injury.**
-
-

Service

Mindray maintains a network of service representatives and factory-trained distributors. Prior to requesting service, perform a complete operational check of the instrument to verify proper control settings. If operational problems continue to exist, contact Mindray service.

In North America contact the Service Department at (800) 288-2121, ext: 8116 for Technical Support or (201) 995-8000 for assistance in determining the nearest field service location.

Please include the instrument model number, the serial number, and a description of the problem with all requests for service.

Any questions regarding the warranty should be directed to the local sales or service representative.

Company Contact

Manufacturer: Shenzhen Mindray Bio-Medical Electronics Co., Ltd.
Address: Mindray Building, Keji 12th Road South, High-tech industrial park, Nanshan, Shenzhen 518057, P.R.China
Website: www.mindray.com
E-mail Address: service@mindray.com
Tel: +86 755 81888998
Fax: +86 755 26582680

Distributor: Mindray DS USA, Inc.
Address: 800 MacArthur Boulevard, Mahwah, New Jersey, 07430 USA
Tel: 1.800.288.2121, 1.201.995.8000
Website: www.mindray.com

Preface

Manual Purpose

This manual contains the instructions necessary to operate the product safely and in accordance with its function and intended use. Observance of this manual is a prerequisite for proper product performance and correct operation and ensures patient and operator safety.

This manual is based on the maximum configuration and therefore some contents may not apply to the product. If you have any question, please contact Mindray.

This manual is an integral part of the product. It should always be kept close to the equipment so that it can be obtained conveniently when needed.

Intended Audience

This manual is geared for clinical professionals who are expected to have a working knowledge of medical procedures, practices and terminology as required for monitoring of patients.

Illustrations

All illustrations in this manual serve as examples only. They may not necessarily reflect the setup or data displayed on the patient monitor.

Conventions

- ***Italic text*** is used in this manual to quote the referenced manuals, chapters, sections and formulas.
- **Bold text** is used to indicate the screen texts and names of hard keys.
- → is used to indicate operational procedures.

Contents

1 Safety	1 - 1
1.1 Safety Information	1 - 1
1.1.1 Warnings	1 - 1
1.1.2 Cautions	1 - 2
1.1.3 Notes	1 - 3
1.2 Equipment Symbols	1 - 3
2 Equipment Introduction	2 - 1
2.1 Indications for Use	2 - 1
2.2 Applied Parts	2 - 1
2.3 System Components	2 - 1
2.3.1 Main Unit	2 - 2
2.3.2 External Modules	2 - 5
2.3.3 Input Devices	2 - 6
2.3.4 Printing Devices	2 - 6
3 Getting Started	3 - 1
3.1 Equipment Preparation Safety Information	3 - 1
3.2 Monitor Installation	3 - 2
3.2.1 Unpacking and Checking	3 - 2
3.2.2 Environmental Requirements	3 - 2
3.3 Setting Up the Equipment	3 - 2
3.3.1 Connecting the AC Mains	3 - 2
3.3.2 Connecting the Input Devices	3 - 3
3.3.3 Connecting the Parameter Module	3 - 3
3.3.4 Removing the Parameter Module	3 - 4
3.4 Turning on the Monitor	3 - 4
3.5 Operation and Navigation	3 - 4
3.5.1 Using the Touchscreen	3 - 4
3.5.2 Using the On-Screen Keyboard	3 - 5
3.5.3 Using the Barcode Reader	3 - 5
3.5.4 Using the Remote Controller	3 - 6
3.6 Screen Display	3 - 6
3.6.1 On-screen Symbols	3 - 7
3.6.2 Dialogs	3 - 8
3.6.3 Quick Keys	3 - 8
3.7 Operating Modes	3 - 10
3.7.1 Monitoring Mode	3 - 10
3.7.2 Privacy Mode	3 - 11
3.7.3 Night Mode	3 - 11
3.7.4 Standby Mode	3 - 13
3.7.5 Discharge Mode	3 - 13
3.8 Configuring the Monitor	3 - 13
3.8.1 Setting the Date and Time	3 - 14
3.8.2 Adjusting the Screen Brightness	3 - 14

3.8.3 Adjusting the Volume	3 - 14
3.9 General Operation	3 - 14
3.9.1 Switching On or Off a Parameter	3 - 14
3.9.2 Displaying Parameter Numerics and Waveforms	3 - 15
3.9.3 Displaying the Parameter List	3 - 15
3.9.4 Accessing Parameter Setup Dialogs	3 - 15
3.9.5 Accessing the On-screen Guide	3 - 15
3.9.6 Changing Measurement Colors	3 - 16
3.10 Initiating a Manual Event	3 - 16
3.11 Freezing Waveforms	3 - 16
3.11.1 Freezing Waveforms	3 - 16
3.11.2 Viewing Frozen Waveforms	3 - 16
3.11.3 Unfreezing Waveforms	3 - 16
3.11.4 Printing Frozen Waveforms	3 - 17
3.12 Capturing the Screen	3 - 17
3.13 Connecting the CMS	3 - 17
3.14 Connecting the eGateway	3 - 17
3.15 Connecting the Wireless Network	3 - 18
3.16 Disconnecting the Wireless Network	3 - 18
3.17 Turning Off the Monitor	3 - 18

4 User Screens 4 - 1

4.1 Choosing a Screen	4 - 1
4.2 Setting Screens Switched by Swiping Across the Screen	4 - 1
4.3 Normal Screen	4 - 1
4.3.1 Entering the Normal Screen	4 - 1
4.3.2 Configuring the Normal Screen	4 - 1
4.4 The Big Numerics Screen	4 - 2
4.4.1 Entering the Big Numerics Screen	4 - 2
4.4.2 Configuring the Big Numerics Screen	4 - 2
4.5 Minitrends Screen	4 - 2
4.5.1 Entering the Minitrends Screen	4 - 2
4.5.2 The Display of Minitrends Screen	4 - 3
4.5.3 Viewing the Long Trends	4 - 3
4.5.4 Setting Minitrends Parameters	4 - 3
4.5.5 Setting the Minitrend Length	4 - 4
4.5.6 Setting the Alarm Statistics Switch	4 - 4
4.5.7 Setting the Alarm Statistics Duration	4 - 4
4.5.8 Routine Vital/Baseline	4 - 4
4.6 The OxyCRG Screen	4 - 5
4.6.1 Entering the OxyCRG Screen	4 - 5
4.6.2 The Display of the OxyCRG Screen	4 - 5
4.6.3 OxyCRG Events	4 - 6
4.6.4 The Display of the ABD Event Area	4 - 6
4.6.5 Setting OxyCRG Parameters	4 - 6
4.6.6 Setting the Threshold of ABD Events	4 - 6
4.6.7 Editing ABD Events	4 - 6

4.7 The Targeted Goal Screen	4 - 7
4.7.1 Entering the Targeted Goal Screen	4 - 7
4.7.2 The Display of the Targeted Goal Screen	4 - 7
4.7.3 Configuring the Targeted Goal Screen Layout	4 - 8
4.7.4 Setting Parameter Statistics	4 - 8
4.7.5 Selecting the Range of Each Parameter Section and the Target Section	4 - 9
4.7.6 Selecting the Statistics Duration of the Target Parameter	4 - 9
4.8 Remote View Screen	4 - 9
4.8.1 Entering the Remote View Screen	4 - 9
4.8.2 Adding a Bed	4 - 10
4.8.3 Removing a Bed	4 - 11
4.8.4 Displaying the Main Bed	4 - 11
4.8.5 Saving a Manual Event	4 - 11
4.8.6 Resetting Alarms for Remote Devices	4 - 11
4.8.7 Alarm Watch	4 - 11
4.8.8 Auto Displaying the New Alarm Bed	4 - 12
5 Managing Patients	5 - 1
5.1 Starting Monitoring a Patient	5 - 1
5.2 Admitting a Patient	5 - 1
5.2.1 Entering the Patient Management Dialog	5 - 1
5.2.2 Editing Patient Information	5 - 1
5.2.3 Loading Patient Information from the CMS	5 - 2
5.2.4 Loading Patient Information from the ADT Server	5 - 2
5.3 Exporting Patient Data	5 - 2
5.4 Deleting Patient Data	5 - 3
5.5 Stopping a Parameter Measurement	5 - 3
5.6 Discharging a Patient	5 - 3
6 Interfacing with External Devices	6 - 1
6.1 Introduction to Interfacing with External Devices	6 - 1
6.2 Interfacing Safety Information	6 - 1
6.3 Differences in Displayed Values	6 - 1
6.4 Connecting an External Device	6 - 2
6.5 Accessing the Integrated Devices Screen	6 - 2
6.5.1 Setting Parameters from External Devices for Display	6 - 3
6.5.2 Setting Alarms from External Devices	6 - 3
6.6 Displaying Data from External Devices on the Main Screen	6 - 3
6.6.1 Setting Waveform Properties for Parameters from External Devices	6 - 4
6.6.2 Selecting Measured Parameters from the Anesthesia System for Display	6 - 4
6.6.3 Setting Units for Parameters from External Devices	6 - 4
6.7 Viewing Alarms from External Devices	6 - 4
6.8 Viewing Parameter Trends from External Devices	6 - 4
6.9 Recording and Printing Parameter Trends from External Devices	6 - 4
7 Alarms	7 - 1
7.1 Alarm Introduction	7 - 1
7.2 Alarm Safety Information	7 - 1

7.3 Understanding the Alarms	7 - 1
7.3.1 Alarm Categories	7 - 1
7.3.2 Alarm Priorities	7 - 1
7.3.3 Alarm Indicators	7 - 2
7.3.4 Alarm Status Symbols	7 - 3
7.3.5 Highlighted Display of Alarm Messages	7 - 3
7.4 Alarm Limits	7 - 3
7.4.1 Guard Limit	7 - 3
7.4.2 Auto Alarm Limits	7 - 3
7.4.3 Initiating Auto Alarm Limits	7 - 6
7.5 Accessing On-screen Help for Technical Alarms (AlarmSight)	7 - 6
7.6 Checking the Physiological Alarms List	7 - 7
7.7 Changing Alarm Settings	7 - 7
7.7.1 Setting Parameter Alarm Properties	7 - 7
7.7.2 Changing the Alarm Volume	7 - 8
7.7.3 Setting the Apnea Delay Time	7 - 8
7.7.4 Switching On or Off V-Tach Latching	7 - 8
7.7.5 Restoring the Default Alarm Settings	7 - 8
7.7.6 Setting the Length of Printed Waveforms	7 - 9
7.8 Pausing Alarms/Pausing Alarm Tones	7 - 9
7.8.1 Pausing Alarms	7 - 9
7.8.2 Pausing Alarm Sound	7 - 10
7.9 Resetting Alarms	7 - 10
7.9.1 Resetting Physiological Alarms	7 - 10
7.9.2 Resetting Technical Alarms	7 - 11
7.10 Latching Alarms	7 - 11
7.11 Nurse Call	7 - 11
7.12 Calling for Help	7 - 11
7.12.1 Issuing the Call Help Signal	7 - 12
7.13 CPB Mode	7 - 12
7.13.1 Entering the CPB Mode	7 - 12
7.13.2 Exiting the CPB Mode	7 - 12
7.14 Intubation Mode	7 - 12
7.14.1 Entering the Intubation Mode	7 - 12
7.14.2 Exiting the Intubation Mode	7 - 12
7.15 Testing Alarms	7 - 13
8 Monitoring ECG, Arrhythmia, ST and QT	8 - 1
8.1 ECG Introduction	8 - 1
8.2 ECG Safety Information	8 - 1
8.3 ECG Display	8 - 1
8.4 Preparing for ECG Monitoring	8 - 2
8.4.1 Preparing the Patient Skin	8 - 2
8.4.2 Applying Electrodes and Connecting the Patient	8 - 2
8.4.3 Lead Wire Color Code	8 - 3
8.4.4 ECG Electrode Placements	8 - 3
8.4.5 Choosing the ECG Lead Type	8 - 5

8.4.6	Checking Paced Status	8 - 5
8.4.7	Enabling Pacer Rejection	8 - 5
8.5	Changing ECG Settings	8 - 6
8.5.1	Choosing an ECG Screen	8 - 6
8.5.2	Setting ECG Alarm Properties	8 - 6
8.5.3	Changing ECG Wave Settings	8 - 6
8.5.4	Disabling the Smart Lead Off Function	8 - 8
8.5.5	Adjusting the QRS Volume	8 - 8
8.5.6	Adjusting the Minimum QRS Detection Threshold	8 - 8
8.6	Monitoring Arrhythmia	8 - 9
8.6.1	Arrhythmia Safety Information	8 - 9
8.6.2	Arrhythmia Events	8 - 9
8.6.3	Displaying Arrhythmia Information	8 - 10
8.6.4	Changing Arrhythmia Settings	8 - 11
8.6.5	Intelligent Arrhythmia Alarm	8 - 12
8.7	ST Segment Monitoring	8 - 14
8.7.1	ST Safety Information	8 - 14
8.7.2	Enabling ST Monitoring	8 - 14
8.7.3	Displaying ST Deviation Numerics	8 - 14
8.7.4	Displaying ST Segments in the Waveform Area	8 - 15
8.7.5	Entering the ST View	8 - 16
8.7.6	Saving the Current ST Deviation and Segment as Baseline	8 - 16
8.7.7	Entering the ST Graphic	8 - 16
8.7.8	Changing ST Settings	8 - 17
8.7.9	Adjusting ST Measurement Points	8 - 18
8.8	QT/QTc Interval Monitoring	8 - 19
8.8.1	QT/QTc Monitoring Limitations	8 - 19
8.8.2	Enabling QT/QTc Monitoring	8 - 19
8.8.3	Displaying QT Numerics and Segments	8 - 19
8.8.4	Entering the QT View	8 - 20
8.8.5	Saving the Current QTc as Baseline	8 - 21
8.8.6	Changing QT Settings	8 - 21
8.9	ECG Relearning	8 - 21
8.9.1	Auto ECG Relearning	8 - 21
8.9.2	Initiating an ECG Relearning Manually	8 - 21
8.10	Defibrillation Synchronization Pulse Output	8 - 22
8.11	ECG Troubleshooting	8 - 22
9	Monitoring Impedance Respiration (Resp)	9 - 1
9.1	Resp Introduction	9 - 1
9.2	Impedance Resp Safety Information	9 - 1
9.3	Resp Display	9 - 1
9.4	Preparing for Impedance Resp Monitoring	9 - 2
9.4.1	Preparing the Patient	9 - 2
9.4.2	Placing the Electrodes	9 - 2
9.5	Changing Resp Settings	9 - 3
9.5.1	Setting the Resp Alarm Properties	9 - 3
9.5.2	Setting the RR Source	9 - 3

9.5.3	Choosing the Respiration Lead	9 - 3
9.5.4	Setting the Resp Waveform Size	9 - 4
9.5.5	Setting the Resp Waveform Speed	9 - 4
9.5.6	Setting the Auto Detection Switch	9 - 4
9.5.7	Adjusting the Resp Waveform Detection Threshold	9 - 4
10	Monitoring Pulse Oxygen Saturation (SpO₂)	10 - 1
10.1	SpO ₂ Introduction	10 - 1
10.2	SpO ₂ Safety Information	10 - 1
10.3	SpO ₂ Measurement Limitations	10 - 2
10.4	SpO ₂ Display	10 - 3
10.5	Preparing for SpO ₂ Monitoring	10 - 3
10.6	Changing the SpO ₂ Settings	10 - 4
10.6.1	Changing the SpO ₂ Alarm Settings	10 - 4
10.6.2	Nellcor SatSeconds™ Alarm Management	10 - 4
10.6.3	Setting SpO ₂ Sensitivity (for Masimo SpO ₂)	10 - 5
10.6.4	Enabling FastSAT (for Masimo SpO ₂)	10 - 6
10.6.5	Displaying SIQ (for Masimo SpO ₂)	10 - 6
10.6.6	Changing Averaging Time (for Masimo SpO ₂)	10 - 6
10.6.7	Monitoring SpO ₂ and NIBP Simultaneously	10 - 7
10.6.8	Changing the Sweep Speed of the Pleth Waveform	10 - 7
10.7	Changing the PR Settings	10 - 7
10.7.1	Changing the PR Alarm Settings	10 - 7
10.7.2	Changing the QRS Volume	10 - 7
10.7.3	Setting the PR Source	10 - 8
10.7.4	Showing/Hiding PR	10 - 8
10.8	Displaying SpO ₂ Statistics	10 - 8
10.9	SpO ₂ Troubleshooting	10 - 8
10.10	Nellcor Information	10 - 9
10.11	Masimo Information	10 - 9
10.12	Masimo End-User License Agreement	10 - 10
11	Monitoring Temperature (Temp)	11 - 1
11.1	Temperature Introduction	11 - 1
11.2	Temperature Safety Information	11 - 1
11.3	Temperature Display	11 - 1
11.4	Preparing for Temperature Monitoring	11 - 1
11.5	Changing Temperature Settings	11 - 2
11.5.1	Setting the Temperature Alarm Properties	11 - 2
11.5.2	Selecting the Temperature Label	11 - 2
11.5.3	Displaying the Temperature Difference	11 - 2
11.6	Temperature Troubleshooting	11 - 2
12	Monitoring Noninvasive Blood Pressure (NIBP)	12 - 1
12.1	NIBP Introduction	12 - 1
12.2	NIBP Safety Information	12 - 1
12.3	NIBP Measurement Limitations	12 - 2

12.4 Measurement Modes	12 - 2
12.5 NIBP Display	12 - 3
12.6 Preparing for NIBP Measurements	12 - 3
12.6.1 Preparing the Patient for NIBP Measurements	12 - 3
12.6.2 Placing the NIBP Cuff	12 - 4
12.7 Starting and Stopping NIBP Measurements	12 - 4
12.8 Viewing NIBP Analysis	12 - 5
12.9 Changing NIBP Settings	12 - 5
12.9.1 Setting the NIBP Alarm Properties	12 - 5
12.9.2 Setting the Initial Cuff Inflation Pressure	12 - 5
12.9.3 Setting the NIBP Interval	12 - 5
12.9.4 Selecting NIBP Start Mode	12 - 5
12.9.5 Enabling the NIBP End Tone	12 - 6
12.9.6 Setting NIBP Sequence	12 - 6
12.9.7 Setting the NIBP Display Format	12 - 6
12.9.8 Setting the NIBP Alarm Limits Display Switch	12 - 6
12.9.9 Showing/Hiding PR	12 - 6
12.9.10 Correcting the NIBP Measurements	12 - 6
12.10 Assisting Venous Puncture	12 - 7
12.11 NIBP Troubleshooting	12 - 7
13 Monitoring Invasive Blood Pressure (IBP)	13 - 1
13.1 IBP Introduction	13 - 1
13.2 IBP Safety Information	13 - 1
13.3 Preparing for IBP Monitoring	13 - 2
13.3.1 IBP Equipment to Patient Connection	13 - 2
13.3.2 Measuring an Invasive Blood Pressure	13 - 2
13.3.3 Zeroing the IBP transducer	13 - 3
13.4 Measuring ICP Using the Codman ICP Transducer	13 - 3
13.4.1 Zeroing the Codman ICP transducer	13 - 3
13.4.2 Measuring ICP	13 - 3
13.5 IBP Display	13 - 4
13.5.1 Overlapping IBP Waveforms	13 - 4
13.6 Changing IBP Settings	13 - 5
13.6.1 Changing the IBP Alarm Settings	13 - 5
13.6.2 Changing the Pressure Label	13 - 5
13.6.3 Setting the Pressure Type for Display	13 - 6
13.6.4 Changing the Sensitivity	13 - 6
13.6.5 Setting the IBP Waveform	13 - 6
13.6.6 Setting the Display Format of Artery Pressure	13 - 6
13.6.7 Showing/Hiding the Alarm Limits of Artery Pressure	13 - 6
13.6.8 Enabling PPV Measurement	13 - 7
13.7 PAWP	13 - 7
13.7.1 PAWP Equipment to Patient Connection	13 - 8
13.7.2 Preparing to Measure PAWP	13 - 8
13.7.3 Measuring PAWP	13 - 9
13.7.4 Setting the Waveforms of the PAWP Screen	13 - 10
13.7.5 Setting the Use PA-D as PAWP Switch	13 - 10

13.7.6 Performing Hemodynamic Calculation	13 - 10
13.8 Connecting a Camino Device	13 - 10
13.9 IBP Troubleshooting	13 - 11
14 Monitoring Cardiac Output (C.O.)	14 - 1
14.1 C.O. Introduction	14 - 1
14.2 C.O. Safety Information	14 - 1
14.3 C.O. Measurement Limitations	14 - 2
14.4 C.O. Display	14 - 2
14.5 C.O. Equipment to Patient Connection	14 - 3
14.6 Performing C.O. Measurement	14 - 3
14.6.1 Preparing for C.O. Measurement	14 - 3
14.6.2 Setting C.O. Measurement	14 - 3
14.6.3 Performing C.O. Measurement	14 - 4
14.7 Changing C.O. Settings	14 - 5
14.7.1 Setting C.O. Alarm Properties	14 - 5
14.8 C.O. Troubleshooting	14 - 5
15 Monitoring Carbon Dioxide (CO₂)	15 - 1
15.1 CO ₂ Introduction	15 - 1
15.2 Identifying CO ₂ Modules	15 - 1
15.3 CO ₂ Safety Information	15 - 2
15.4 CO ₂ Measurement Limitations	15 - 2
15.5 CO ₂ Display	15 - 2
15.6 Measuring CO ₂ Using the Sidestream/Microstream CO ₂ Module	15 - 3
15.6.1 Preparing to Measure CO ₂ Using the Sidestream CO ₂ Module	15 - 3
15.6.2 Preparing to Measure CO ₂ Using the Microstream CO ₂ Module	15 - 4
15.6.3 Zeroing the Sidestream/Microstream CO ₂ Module	15 - 5
15.7 Changing Settings for All CO ₂ Modules	15 - 5
15.7.1 Changing CO ₂ Alarm Settings	15 - 5
15.7.2 Setting the CO ₂ Waveform	15 - 5
15.7.3 Setting the RR Source	15 - 6
15.7.4 Entering the Standby Mode	15 - 6
15.7.5 Entering the Intubation Mode	15 - 6
15.7.6 Setting the Auto Standby	15 - 6
15.7.7 Setting Humidity Compensation	15 - 6
15.8 Setting the Gas Compensation	15 - 7
15.9 Choosing a Time Interval for Peak-Picking	15 - 7
15.10 Performing the Leakage Test	15 - 7
15.11 CO ₂ Calibration	15 - 8
15.12 Test Method Used to Determine the Respiration Rate Measuring Range	15 - 8
15.13 CO ₂ Troubleshooting	15 - 8
15.13.1 Troubleshooting the Sidestream/Microstream CO ₂ Module	15 - 8
15.14 Oridion Information	15 - 9
16 Monitoring Anesthetic Gas (AG)	16 - 1

16.1 AG Introduction	16 - 1
16.2 AG Safety Information	16 - 2
16.3 AG Measurement Limitations	16 - 2
16.4 AG Display	16 - 2
16.5 AG Equipment to Patient Connection	16 - 3
16.6 Preparing for AG Monitoring	16 - 3
16.7 Zeroing the AG Module	16 - 4
16.8 MAC Values	16 - 4
16.9 Changing AG Settings	16 - 5
16.9.1 Changing AG Alarm Settings	16 - 5
16.9.2 Setting the O ₂ Compensation	16 - 5
16.9.3 Entering the Standby Mode	16 - 5
16.9.4 Setting Auto Standby	16 - 6
16.9.5 Setting the Gas Waveform	16 - 6
16.9.6 Setting the RR Source	16 - 6
16.9.7 Entering the Intubation Mode	16 - 6
16.9.8 Enabling or Disabling MAC Display	16 - 6
16.10 Changing the Anesthetic Agent	16 - 7
16.11 Performing AG Leakage Test	16 - 7
16.12 Calibrating the AG Module	16 - 7
16.13 AG Troubleshooting	16 - 7
17 Review	17 - 1
17.1 Review Overview	17 - 1
17.2 Review Dialog	17 - 1
17.2.1 Accessing the Review Dialog	17 - 1
17.2.2 Example Review Dialog	17 - 1
17.2.3 Symbols on Review Pages	17 - 2
17.2.4 Common Operations	17 - 2
17.2.5 Tabular Trends Review Page	17 - 3
17.2.6 Graphics Trends Review Page	17 - 4
17.2.7 Events Review Page	17 - 5
17.2.8 Full Disclosure Review Page	17 - 7
17.2.9 OxyCRG Review Page	17 - 8
17.2.10 ST Review Page	17 - 10
17.3 Reviewing Discharged Patients	17 - 10
17.3.1 Checking the Data of a Discharged Patient	17 - 10
17.3.2 Checking the Information of a Discharged Patient	17 - 11
18 Clinical Assistive Applications (CAA)	18 - 1
18.1 Checking Software Licenses	18 - 1
18.2 Early Warning Score (EWS)	18 - 1
18.2.1 Displaying the EWS Numerics Area	18 - 2
18.2.2 Accessing the EWS Screen	18 - 2
18.2.3 Performing EWS Scoring	18 - 4
18.2.4 Changing EWS Settings	18 - 4
18.2.5 Viewing Historical Scores	18 - 5
18.2.6 Viewing Parameter Trends	18 - 5

18.3 Glasgow Coma Scale (GCS)	18 - 6
18.3.1 Displaying the GCS Parameter Area	18 - 6
18.3.2 Accessing the GCS Dialog	18 - 7
18.3.3 Performing GCS Scoring	18 - 7
18.3.4 Setting GCS Scoring Interval	18 - 7
18.3.5 Reviewing GCS Trend Data	18 - 7
18.4 ECG 24h Summary	18 - 8
18.4.1 Opening the ECG 24h Summary Window	18 - 8
18.4.2 The Display of ECG 24h Summary	18 - 8
18.4.3 Selecting Typical ECG Strips	18 - 9
18.4.4 Setting the Statistical Duration of the ECG 24h Summary	18 - 9
18.4.5 Reviewing the ECG Summary	18 - 9
18.5 OxyCRG Expand Screen	18 - 9
18.5.1 Accessing the OxyCRG Expand Screen	18 - 9
18.5.2 Change Parameter Settings	18 - 10
18.5.3 Starting the Timer	18 - 10
18.5.4 Printing the OxyCRG Report	18 - 10
18.5.5 Reviewing the OxyCRG Events	18 - 10
19 Calculation	19 - 1
19.1 Calculation Overview	19 - 1
19.2 Calculation Safety Information	19 - 1
19.3 Drug Calculations	19 - 1
19.3.1 Performing Drug Calculations	19 - 1
19.3.2 Checking the Titration Table	19 - 2
19.3.3 Drug Calculation Formula	19 - 2
19.3.4 Titration Table Calculation Formula	19 - 2
19.4 Hemodynamic Calculations	19 - 3
19.4.1 Performing Hemodynamic Calculations	19 - 3
19.4.2 Input Parameters for Hemodynamic Calculations	19 - 3
19.4.3 Calculated Parameters and Formulas for Hemodynamic Calculations	19 - 3
19.5 Oxygenation Calculations	19 - 4
19.5.1 Performing Oxygenation Calculations	19 - 4
19.5.2 Input Parameters for Oxygenation Calculations	19 - 5
19.5.3 Calculated Parameters and Formulas for Oxygenation Calculations	19 - 5
19.6 Ventilation Calculations	19 - 6
19.6.1 Performing Ventilation Calculations	19 - 6
19.6.2 Input Parameters for Ventilation Calculations	19 - 6
19.6.3 Calculated Parameters and Formulas for Ventilation Calculations	19 - 6
19.7 Renal Calculations	19 - 7
19.7.1 Performing Renal Calculations	19 - 7
19.7.2 Calculated Parameters and Formulas for Renal Calculations	19 - 7
19.7.3 Calculated Parameters and Formulas for Renal Calculations	19 - 8
20 Recording	20 - 1
20.1 Recorder	20 - 1
20.2 Starting Recordings	20 - 1
20.2.1 Manually Starting Recordings	20 - 1

20.2.2 Automatic Recordings	20 - 1
20.3 Stopping Recordings	20 - 2
20.3.1 Stopping Recordings Manually	20 - 2
20.3.2 Stopping Recordings Automatically	20 - 2
20.4 Recording Related Flags	20 - 2
20.5 Setting Up the Recorder	20 - 2
20.6 Clearing Recording Tasks	20 - 2
20.7 Loading Paper	20 - 3
20.8 Removing Paper Jam	20 - 3
20.9 List of Recording Reports	20 - 3
21 Printing	21 - 1
21.1 Supported Printer	21 - 1
21.2 End Case Reports	21 - 1
21.2.1 Printing the End Case Report	21 - 1
21.2.2 Setting a Report as An End Case Report	21 - 1
21.2.3 Configuring the End Case Reports	21 - 2
21.2.4 Setting the End Case Report Period	21 - 2
21.3 Manually Starting a Printing Task	21 - 2
21.3.1 Printing from the Screen	21 - 2
21.3.2 Printing Realtime Reports	21 - 2
21.3.3 Printing Most Common Reports	21 - 2
21.4 Automatically Printing Reports	21 - 3
21.5 Stopping a Printing Task	21 - 3
21.6 Configuring Reports	21 - 3
21.6.1 Configuring ECG Reports	21 - 3
21.6.2 Configuring Realtime Reports	21 - 3
21.6.3 Configuring Tabular Trends Reports	21 - 4
21.6.4 Configuring Graphic Trends Reports	21 - 4
21.7 Viewing Printer Status	21 - 5
21.8 Printer Out of Paper	21 - 5
21.9 List of Reports	21 - 5
22 Using the On-Screen Timers	22 - 1
22.1 Displaying Timers	22 - 1
22.2 Controlling the Timer	22 - 1
22.3 Setting the Timer	22 - 1
23 Managing Configurations	23 - 1
23.1 Configuration Introduction	23 - 1
23.2 Changing the Department	23 - 1
23.3 Setting Default Patient Category	23 - 1
23.4 Setting Default Configuration	23 - 2
23.5 Defining Age Segments	23 - 2
23.6 Saving Current Settings	23 - 2
23.7 Deleting a Configuration	23 - 2

23.8 Transferring a Configuration	23 - 3
23.8.1 Exporting a Configuration	23 - 3
23.8.2 Importing a Configuration	23 - 3
23.8.3 Loading a Configuration	23 - 3
23.9 Printing Configurations	23 - 4
23.10 Modifying Configuration Password	23 - 4
24 Password-protected User Settings	24 - 1
24.1 Setting the Device Location	24 - 1
24.1.1 Setting Monitor Information	24 - 1
24.1.2 Setting Monitor Location	24 - 1
24.1.3 Enabling the Auto Obtain Bed Number Function	24 - 1
24.2 Changing Patient Management Settings	24 - 2
24.2.1 Selecting Displayed Patient Information	24 - 2
24.2.2 Setting the Range of Finding a Patient	24 - 2
24.2.3 Auto Discharging a Patient after Monitor Power Off	24 - 2
24.2.4 Configuring Alarms for Auto Deleting Discharged Patients	24 - 2
24.2.5 Configuring Discharged Patients Data	24 - 3
24.2.6 Clearing All Patient Data	24 - 3
24.2.7 Selecting Query Criteria for Searching Patients in ADT Server	24 - 3
24.2.8 Setting Patient Location Options for the Discharge Screen	24 - 3
24.2.9 Hiding Patient Name	24 - 3
24.3 Changing the Alarm Settings	24 - 4
24.3.1 Setting Alarm Tone Properties	24 - 4
24.3.2 Setting Alarm Pausing and Resetting Properties	24 - 5
24.3.3 Latching Physiological Alarms	24 - 6
24.3.4 Setting Guard Limits	24 - 6
24.3.5 Changing Remote Alarm Settings	24 - 7
24.3.6 Setting Nurse Call Properties	24 - 8
24.3.7 Changing Alarm Priority Settings	24 - 9
24.3.8 Changing Alarm Delay Settings	24 - 10
24.3.9 Changing Other Alarm Settings	24 - 10
24.4 Changing CAA Settings	24 - 12
24.4.1 Enabling Inputting the Clinician ID	24 - 12
24.4.2 Selecting the Default Scoring Tool	24 - 12
24.4.3 Managing the Scoring Tools	24 - 12
24.4.4 Setting GCS Threshold for Each Consciousness Level	24 - 12
24.5 Changing Module Settings	24 - 13
24.5.1 Selecting the ECG Standard	24 - 13
24.5.2 Changing the QTc Formula	24 - 13
24.5.3 Calibrating ECG	24 - 13
24.5.4 Manually Zeroing the CO ₂ Module	24 - 13
24.5.5 Hiding the Invalid Display after Zeroing the CO ₂ Module	24 - 13
24.5.6 Manually Zeroing the AG Module	24 - 14
24.5.7 Hiding the Invalid Display after Zeroing the AG Module	24 - 14
24.5.8 Selecting the Gas Type for Measurement	24 - 14
24.5.9 Setting IBP Filter	24 - 14
24.5.10 Setting Parameter Measurement Timeout	24 - 14
24.5.11 Setting Flow Rate	24 - 15

24.6 Changing the Review Settings	24 - 15
24.6.1 Hiding Undesired Review Tabs	24 - 15
24.6.2 Renaming Events	24 - 15
24.6.3 Exporting Patient Data	24 - 15
24.7 Setting the Printer	24 - 15
24.7.1 Setting the Printer Properties	24 - 15
24.7.2 Setting the Report Type	24 - 16
24.7.3 Setting the Report Layout	24 - 16
24.7.4 Configuring the Name of PDF Files	24 - 16
24.7.5 Showing the Second Mark	24 - 17
24.7.6 Setting the Arrhythmia Information to Output by the Recorder	24 - 17
24.7.7 Setting Parameter Unit	24 - 17
24.8 Setting the Time	24 - 17
24.8.1 Setting the Time Synchronization	24 - 17
24.8.2 Enabling Auto Daylight Savings Time	24 - 18
24.9 Viewing Version Information	24 - 18
24.10 Checking Battery Information	24 - 18
24.11 Changing Scanner Settings	24 - 18
24.11.1 Establishing the Relationship between Patient Demographics and 2D Barcode Fields (for the Mindray Custom 2D Barcode Reader)	24 - 19
24.11.2 Setting the Barcode Reader Information	24 - 19
24.11.3 Identifying the Barcode Reader (for the non-Mindray Custom 2D Barcode Reader)	24 - 19
24.11.4 Selecting Patient Information Read by the Barcode Reader (for the Mindray Custom 2D Barcode Reader)	24 - 19
24.12 Configuring the Network	24 - 19
24.12.1 Network Safety Information	24 - 20
24.12.2 Selecting a Network Type	24 - 20
24.12.3 Setting the Wired Network	24 - 21
24.12.4 Setting the Wireless Network	24 - 21
24.12.5 Managing Certifications	24 - 21
24.12.6 Enabling Selecting a CMS	24 - 22
24.12.7 Adding CMSs	24 - 22
24.12.8 Setting Multicast Parameters	24 - 22
24.12.9 Setting the Master Server Address	24 - 22
24.12.10 Setting the Network Service Quality Level	24 - 22
24.12.11 Using the ADT Gateway	24 - 22
24.12.12 Sending Realtime Data, Waveforms and Alarms via HL7 Protocol	24 - 23
24.12.13 Selecting Data Encryption Type	24 - 23
24.12.14 Disabling the Broadcasting Patient Demographics Function	24 - 23
24.12.15 Managing TLS Certificates	24 - 24
24.13 MLDAP	24 - 24
24.13.1 Setting MLDAP	24 - 24
24.13.2 Testing MLDAP Server Connection	24 - 24
24.13.3 Selecting Password for User Authentication	24 - 24
24.13.4 Setting the Password Timeout Period	24 - 25
24.14 Defining Other Functions	24 - 25
24.14.1 Setting Notch Filter Frequency	24 - 25
24.14.2 Setting Mouse Sensitivity	24 - 25
24.14.3 Setting the Manual Event Edit Switch	24 - 25

24.14.4	Setting the SpO ₂ Tone Mode	24 - 26
24.14.5	Selecting the Language	24 - 26
24.14.6	Switching On or Off a Parameter	24 - 26
24.14.7	Setting If Setting Parameter Switches is Protected	24 - 27
24.14.8	Setting If Parameter Switch is Influenced by Configuration	24 - 27
24.14.9	Setting Parameter Output Properties	24 - 27
24.14.10	Browsing System Log	24 - 27
24.14.11	Exporting System Log	24 - 27
25	Battery	25 - 1
25.1	Battery Introduction	25 - 1
25.2	Battery Safety Information	25 - 1
25.3	Installing the Battery	25 - 2
25.4	Battery Indications	25 - 2
25.4.1	Battery LED	25 - 2
25.4.2	Battery Symbols	25 - 2
25.4.3	Battery-related Alarms	25 - 3
25.5	Charging the Battery	25 - 3
25.6	Maintaining the Battery	25 - 3
25.6.1	Conditioning the Battery	25 - 3
25.6.2	Checking Battery Performance	25 - 3
25.7	Storing Batteries	25 - 3
25.8	Recycling Batteries	25 - 4
26	Care and Cleaning	26 - 1
26.1	Care and Cleaning Introduction	26 - 1
26.2	Care and Cleaning Safety Information	26 - 1
26.3	Cleaning and Disinfecting the Equipment and Mounting Kits	26 - 2
26.3.1	Approved Cleaning and Disinfecting Agents	26 - 2
26.3.2	Cleaning the Equipment and Mounting Kits	26 - 3
26.3.3	Disinfecting the Equipment and Mounting Kits	26 - 3
26.4	Cleaning and Disinfecting the Accessories	26 - 3
26.4.1	Approved Accessories Cleaning and Disinfecting Agents	26 - 4
26.4.2	Cleaning the Accessories	26 - 5
26.4.3	Disinfecting the Accessories	26 - 5
26.5	Sterilization	26 - 5
27	Maintenance	27 - 1
27.1	Maintenance Introduction	27 - 1
27.2	Maintenance Safety Information	27 - 1
27.3	Maintenance and Testing Schedule	27 - 2
27.4	Checking System Software Version	27 - 2
27.5	Testing Methods and Procedures	27 - 2
27.5.1	Performing Visual Inspection	27 - 3
27.5.2	Performing Power-on Test	27 - 3
27.5.3	Testing the Recorder	27 - 3
27.5.4	Testing the Network Printer	27 - 3
27.5.5	Checking the Battery	27 - 3

27.6 NIBP Maintenance	27 - 3
27.6.1 NIBP Leakage Test	27 - 3
27.6.2 NIBP Accuracy Test	27 - 3
27.7 Disposing of the Monitor	27 - 4
28 Accessories	28 - 1
28.1 ECG Accessories	28 - 1
28.1.1 ECG Electrodes Available for Purchase	28 - 1
28.1.2 ECG Electrodes Also Compatible	28 - 1
28.1.3 12-Pin Trunk Cables Available for Purchase	28 - 2
28.1.4 3-lead ECG Leadwires Available for Purchase	28 - 2
28.1.5 3-lead ECG Leadwires Also Compatible	28 - 2
28.1.6 5-lead ECG Leadwires Available for Purchase	28 - 2
28.1.7 5-lead ECG Leadwires Also Compatible	28 - 3
28.2 SpO ₂ Accessories	28 - 3
28.2.1 Extension Cables and Adapter Cables Available for Purchase	28 - 3
28.2.2 Extension Cables and Adapter Cables Also Compatible	28 - 3
28.2.3 Masimo SpO ₂ RD Set Sensors Available for Purchase	28 - 3
28.2.4 Masimo SpO ₂ LNCS Sensors Also Compatible	28 - 4
28.2.5 Nellcor SpO ₂ Sensors Also Compatible	28 - 4
28.3 Temp Accessories	28 - 4
28.3.1 Temp Cable Available for Purchase	28 - 4
28.3.2 Temp Probes Available for Purchase	28 - 4
28.4 NIBP Accessories	28 - 5
28.4.1 NIBP Hoses Available for Purchase	28 - 5
28.4.2 NIBP Hoses Also Compatible	28 - 5
28.4.3 Cuffs Available for Purchase	28 - 5
28.5 IBP Accessories	28 - 6
28.5.1 IBP Accessories Available for Purchase	28 - 6
28.5.2 ICP Accessories Available for Purchase	28 - 6
28.6 C.O. Accessories Available for Purchase	28 - 6
28.7 CO ₂ Accessories	28 - 6
28.7.1 Sidestream CO ₂ Accessories Available for Purchase	28 - 6
28.7.2 Microstream CO ₂ Accessories Also Compatible	28 - 7
28.8 AG Accessories	28 - 7
28.9 External Modules	28 - 8
28.10 Mount and Mounting Accessories	28 - 8
28.11 Miscellaneous Accessories	28 - 9
A Product Specifications	A - 1
A.1 Monitor Safety Specifications	A - 1
A.2 Physical Specifications	A - 1
A.3 Environmental Specifications	A - 1
A.4 Power Supply Specifications	A - 2
A.4.1 External Power Supply Specifications	A - 2
A.4.2 Battery Specifications	A - 3
A.5 Display Specifications	A - 3

A.6 Recorder Specifications	A - 3
A.7 LEDs	A - 3
A.8 Audio Indicator	A - 4
A.9 Monitor Interface Specifications	A - 4
A.10 Signal Outputs Specifications	A - 4
A.11 Data Storage	A - 5
A.12 Wi-Fi Specifications	A - 5
A.12.1 Wi-Fi Technical Specifications (MSD45N)	A - 5
A.12.2 Wi-Fi Technical Specifications (SX-SDMAC-2832S+)	A - 6
A.12.3 Wi-Fi Performance Specifications	A - 6
A.13 Measurement Specifications	A - 7
A.13.1 ECG Specifications	A - 7
A.13.2 Resp Specifications	A - 10
A.13.3 SpO ₂ Specifications	A - 10
A.13.4 PR Specifications	A - 11
A.13.5 Temp Specifications	A - 12
A.13.6 NIBP Specifications	A - 12
A.13.7 IBP Specifications	A - 14
A.13.8 C.O. Specifications	A - 16
A.13.9 CO ₂ Specifications	A - 16
A.13.10 AG Specifications	A - 18
B EMC and Radio Regulatory Compliance	B - 1
B.1 EMC	B - 1
B.2 Radio Regulatory Compliance	B - 4
C Default Settings	C - 1
C.1 ECG, Arrhythmia, ST and QT Default Settings	C - 1
C.1.1 ECG Default Settings	C - 1
C.1.2 Arrhythmia Default Settings	C - 2
C.1.3 ST Default Settings	C - 3
C.1.4 QT Default Settings	C - 4
C.2 Respiration Default Settings	C - 4
C.3 SpO ₂ Default Settings	C - 5
C.4 Temperature Default Settings	C - 6
C.5 NIBP Default Settings	C - 6
C.6 IBP Default Settings	C - 8
C.7 C.O. Default Settings	C - 11
C.8 CO ₂ Default Settings	C - 11
C.8.1 General Settings	C - 11
C.8.2 Sidestream CO ₂ Default Settings	C - 12
C.8.3 Microstream CO ₂ Default Settings	C - 12
C.9 Gas Default Settings	C - 12
C.10 Alarm Default Settings	C - 14
C.11 Display Default Settings	C - 15
D Alarm Messages	D - 1

D.1 Physiological Alarm Messages	D - 1
D.1.1 General Physiological Alarm Messages	D - 1
D.1.2 Arrhythmia Alarm Messages	D - 1
D.1.3 ST Physiological Alarm Messages	D - 2
D.1.4 Resp Physiological Alarm Messages	D - 2
D.1.5 SpO ₂ Physiological Alarm Messages	D - 2
D.1.6 PR Physiological Alarm Messages	D - 3
D.1.7 NIBP Physiological Alarm Messages	D - 3
D.1.8 IBP Physiological Alarm Messages	D - 3
D.1.9 AG Physiological Alarm Messages	D - 3
D.2 Technical Alarm Messages	D - 3
D.2.1 General Technical Alarm Messages	D - 4
D.2.2 ECG Technical Alarm Messages	D - 4
D.2.3 Resp Technical Alarm Messages	D - 4
D.2.4 SpO ₂ Technical Alarm Messages	D - 5
D.2.5 Temp Technical Alarm Messages	D - 5
D.2.6 NIBP Technical Alarm Messages	D - 5
D.2.7 IBP Technical Alarm Messages	D - 6
D.2.8 C.O. Technical Alarm Messages	D - 6
D.2.9 CO ₂ Technical Alarm Messages	D - 7
D.2.10 AG Technical Alarm Messages	D - 8
D.2.11 EWS Technical Alarms	D - 8
D.2.12 Power Supply Technical Alarm Messages	D - 9
D.2.13 Recorder Technical Alarm Messages	D - 9
D.2.14 Printer Technical Alarm Messages	D - 10
D.2.15 Technical Alarm Messages Related to Networked Monitoring	D - 10
D.2.16 Other System Technical Alarm Messages	D - 11
E SpO₂ Sensor Accuracy	E - 1
E.1 The Accuracy of Masimo SpO ₂ Sensors	E - 1
E.2 The Accuracy of Nellcor SpO ₂ Sensors	E - 3
F Units, Symbols and Abbreviations	F - 1
F.1 Units	F - 1
F.2 Symbols	F - 2
F.3 Abbreviations	F - 3

This page intentionally left blank.

1 Safety

1.1 Safety Information

WARNING

- Indicates a potential hazard or unsafe practice that, if not avoided, could result in death or serious injury.
-
-

CAUTION

- Indicates a potential hazard or unsafe practice that, if not avoided, could result in minor personal injury or product/property damage.
-

NOTE

- Provides application tips or other useful information that does not involve patient or user risk.
-

1.1.1 Warnings

WARNING

- Patient with a pacemaker – on ventricular paced patients, episodes of Ventricular Tachycardia may not always be detected. Do not rely entirely upon the system's automated arrhythmia detection algorithm. Keep pacemaker patients under close surveillance.
- This equipment is used for a single patient at a time.
- To avoid explosion hazards, do not use the equipment in the presence of oxygen-rich atmospheres, flammable anesthetics, or other flammable agents.
- Do not touch the equipment's metal parts or connectors when in contact with the patient; otherwise patient injury may result.
- Never mix patient electrode types or brands. Dissimilar metals or other incompatibilities may cause considerable baseline drift and may increase trace recovery time after defibrillation.
- To reduce the hazard of burns during high-frequency surgical procedure, ensure that the monitor's cables and transducers never come into contact with the electro-surgery unit (ESU).
- The neutral electrode of the electro-surgery unit (ESU) shall properly contact the patient. Otherwise, burns may result.
- MR unsafe: the ePM Series monitors are not intended to be used within the Magnetic Resonance (MR) environment.
- Before connecting the equipment to the mains power, ensure that the voltage and frequency ratings of the power line are the same as those indicated on the equipment's label or in this manual.
- Before putting the system into operation, the operator must verify that the equipment, connecting cables, and accessories are in correct working order and operating condition.
- To avoid risk of electric shock, the equipment must only be connected to mains power with protective earth, or operated on battery power.
- Do not touch the patient and live parts simultaneously. Otherwise patient injury may result.
- Do not touch the patient or metal parts in contact with the patient during defibrillation. Otherwise serious injury or death could result.
- Do not open the equipment housings. All servicing and future upgrades must be carried out by trained and authorized personnel.

- Do not rely exclusively on the audible alarm system for patient monitoring. Turning the alarm volume to a low level or off may result in a hazard to the patient. Always keep the patient under close surveillance.
 - Alarm settings should be customized according to patient situations.
 - Do not place the equipment or accessories in any position that might cause it to fall on the patient.
 - Do not start or operate the equipment unless the setup was verified to be correct.
 - To avoid inadvertent disconnection, route all cables in a way to prevent a stumbling hazard. Wrap and secure excess cabling to reduce risk of entanglement by patients or personnel. The physiological data and alarm messages displayed on the equipment are for reference only and cannot be directly used for diagnostic interpretation. The equipment should not be used as the sole basis for medical decisions. It must be used in conjunction with clinical signs and symptom. If any measurement seems questionable, first check the patient's vital signs by alternate means and then check the equipment for proper functioning.
-
-

1.1.2 Cautions

CAUTION













- Use only parts and accessories specified in this manual.
 - Disposable accessories are not designed to be reused. Reuse may cause a risk of contamination and affect the measurement accuracy.
 - Ensure that the equipment is supplied with continuous electric power during operation from the mains power or batteries. Sudden power failure may cause data loss.
 - When no battery is installed, ensure that the monitor is supplied with continuous electric power during operation. Sudden power failure may lead to data loss.
 - Store and use the equipment in specified environmental condition. The monitor and accessories may not meet the performance specification due to aging, stored or used outside the specified temperature and humidity range.
 - Magnetic and electrical fields are capable of interfering with the proper performance of the equipment. For this reason make sure that all external devices operated in the vicinity of the equipment comply with the relevant EMC requirements. Mobile phones, X-ray equipment, and MRI devices are possible sources of interference as they may emit higher levels of electromagnetic radiation.
 - Always install or carry the equipment properly to avoid damage caused by drops, impacts, strong vibrations or other mechanical forces.
 - Dry the equipment immediately in case of rain or water spray.
 - Some settings are password protected and can only be changed by authorized personnel. Contact your department manager or biomedical engineering department for the passwords used at your facility.
 - Do not loop the patient cabling into a tight coil or wrap around the device, as this can damage the patient cabling.
 - Dispose of the package material as per the applicable waste control regulations. Keep it out of children's reach.
 - At the end of its service life, the equipment, as well as its accessories, must be disposed of in compliance with the guidelines regulating the disposal of such products. If you have any questions concerning disposal of the equipment, please contact Mindray.
-



















1.1.3 Notes

NOTE

- The equipment software copyright is solely owned by Mindray. No organization or individual shall resort to modifying, copying, or exchanging it or to any other infringement on it in any form or by any means without due permission.
- Put the equipment in a location where it can be easily viewed and operated.
- The equipment uses a mains plug as isolation means to the mains power. Do not locate the equipment in a place difficult to access the mains plug.
- During normal use, the operator is expected to face the front of the equipment.
- Remove the battery before shipping the monitor or if it will not be used for an extended period of time.
- Remove the battery before transporting the equipment or if the equipment will not be used for a long time.
- The software was developed in compliance with IEC62304.
- This manual is based on the maximum configuration and therefore some contents may not apply to the product. If you have any question, please contact Mindray.
- Observance of this manual is a prerequisite for proper product performance and correct operation and ensures patient and operator safety.
- Keep this manual in the vicinity of the equipment so that it can be referenced when needed.

1.2 Equipment Symbols

Symbol	Description	Symbol	Description
	General warning sign		Refer to instruction manual/booklet
	Serial number	REF	Catalogue number
	Date of manufacture		Manufacturer
	USB connector	IPX1	Protected against vertically falling water drops per IEC 60529
	Battery indicator		Computer network
	Equipotentiality		Alternating current
	Defibrillation-proof type CF applied part		Defibrillation-proof type BF applied part

Symbol	Description	Symbol	Description
	Stop USB		Plastic identification symbol
	NIBP start/stop		Calibration
	Batch code		Menu
	Stand-by		Graphical record
	Gas outlet		Gas inlet
	Output		Input/output
	IBP zero key		Pushing prohibited (wheels locked, no pushing)
	Non-ionizing electromagnetic radiation		Authorised representative in the European Community
	Dispose of in accordance to local requirements		
<p>ETL CLASSIFIED</p>  <p>Intertek 3179617</p>	<p>The presence of this label indicates the machine was certified by ETL with the statement: Conforms to AAMI Std. ES 60601-1, IEC Std. 60601-1-6, IEC Std. 60601-1-8, IEC Std. 60601-2-25, IEC Std. 60601-2-27, IEC Std. 60601-2-34, IEC Std. 80601-2-49, IEC Std. 80601-2-30, ISO Std. 80601-2-55, ISO Std. 80601-2-56, ISO Std. 80601-2-61 Certified to CSA Std. C22.2 NO. 60601-1, NO. 60601-1-6, NO. 60601-1-8, NO. 60601-2-25, NO. 60601-2-27, NO. 60601-2-34, IEC Std. 80601-2-49, NO. 80601-2-30, NO. 80601-2-55, NO. 80601-2-56, NO. 80601-2-61</p>		

2 Equipment Introduction

2.1 Indications for Use

The ePM 10M/ePM 12M patient monitors are intended for monitoring, displaying, reviewing, storing, alarming, and transferring of multiple physiological parameters including ECG (3-lead, 5-lead, 6-lead or 12-lead selectable, Arrhythmia Detection, ST Segment Analysis, QT Analysis, and Heart Rate (HR)), Respiration Rate (Resp), Temperature (Temp), Pulse Oxygen Saturation (SpO₂), Pulse Rate (PR), Non-invasive Blood Pressure (NIBP), Invasive Blood Pressure (IBP), Pulmonary Artery Wedge Pressure (PAWP), Cardiac Output (C.O.), Carbon Dioxide (CO₂), Oxygen (O₂), Anesthetic Gas (AG). The system also provides an interpretation of resting 12-lead ECG.

All the parameters can be monitored on single adult, pediatric, and neonatal patients except for the following:

- The PAWP monitoring is intended for adult and pediatric patients only.
- C.O. monitoring is intended for adult patients only.

The monitors are to be used in healthcare facilities by clinical professionals or under their guidance. They should only be used by persons who have received adequate training in their use. The ePM 10M/ePM 12M monitors are not intended for helicopter transport, hospital ambulance, or home use.

NOTE

- **This manual is based on the maximum configuration and therefore some contents may not apply to the product. If you have any question, please contact Mindray.**
-

2.2 Applied Parts

The applied parts of the monitor are:

- ECG electrode and leadwire
- SpO₂ sensor
- Temp probe
- NIBP cuff
- IBP transducer
- C.O. sensor
- CO₂ sampling line/nasal sampling cannula, water trap, and mask
- AG sampling line, water trap, airway adapter, and mask

2.3 System Components

The monitor consists of the main unit, display, external modules, input devices, and output devices.

NOTE

- **The monitor may not include all these components. Contact the local service personnel for available components.**
-

2.3.1 Main Unit

The main unit processes data from modules and sends information to displays and, optionally, among networked devices.

2.3.1.1 Front View

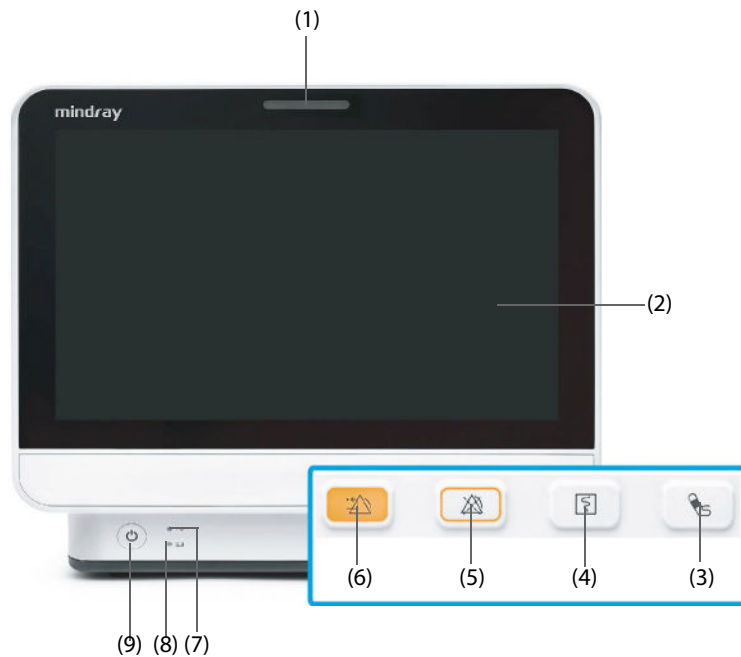

- (1) Alarm lamp
When a physiological alarm or technical alarm occurs, this lamp lights and flashes corresponding with the alarm priority:
- ◆ High priority alarms: the lamp quickly flashes red.
 - ◆ Medium priority alarms: the lamp slowly flashes yellow.
 - ◆ Low priority alarms: the lamp lights in cyan without flashing.
- (2) Display
- (3) NIBP Start/Stop hard key: starts an NIBP measurement or stops the current NIBP measurement.
- (4) Record Start/Stop hard key: starts a recording or stops the current recording.
- (5) Alarm Pause hard key: pauses the physiological alarm system.
- (6) Alarm Reset hard key: resets the alarm system.
- (7) AC Power indicator
- ◆ On: when the AC power is connected.
 - ◆ Off: when the AC power is not connected.
- (8) Battery indicator
- ◆ Yellow: the battery is being charged.
 - ◆ Green: the battery is fully charged.
 - ◆ Flashing green: the monitor operates on battery power.
 - ◆ Off: no battery is installed, or the battery is malfunctioning, or the monitor is powered off and no power is connected.
- (9) Power switch
- ◆ Pressing this switch turns on the monitor.
 - ◆ When the monitor is on, pressing and holding this switch turns off the monitor.

2.3.1.2 Left View



- (1) Temperature probe connector
- (2) SpO₂ probe connector
- (3) IBP cable connector
- (4) ECG cable connector
- (5) CO₂ watertrap seat
- (6) NIBP cuff connector
- (7) Gas outlet

2.3.1.3 Right View

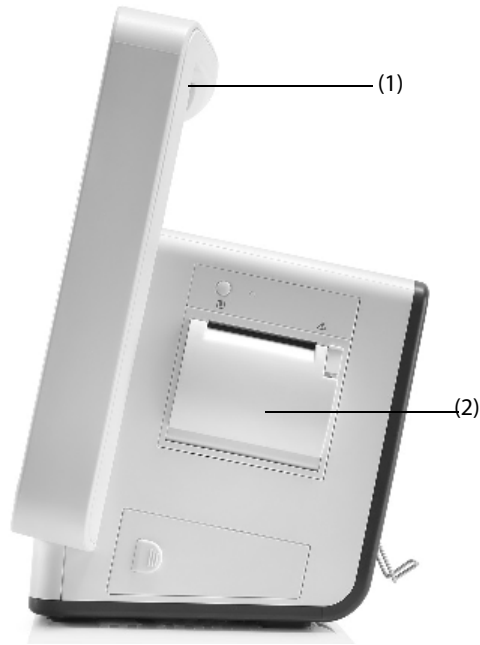

(1) Handle

(2) Recorder

2.3.1.4 Rear View

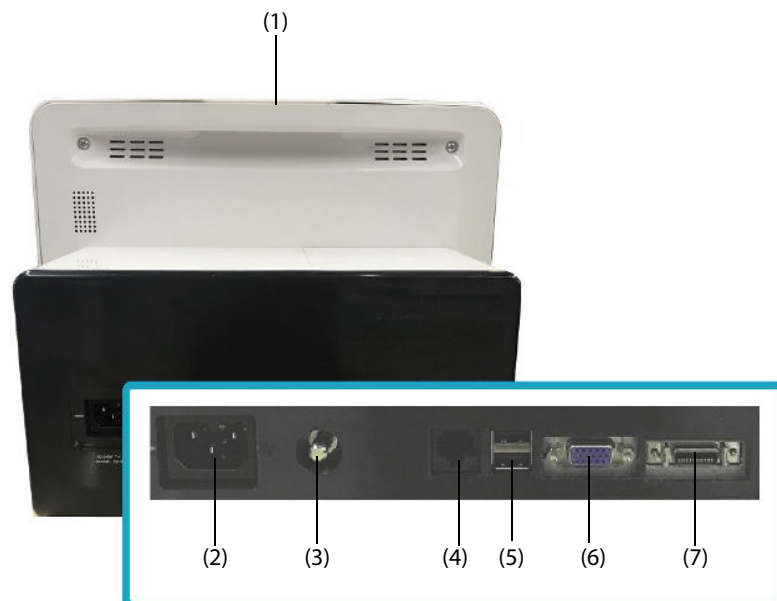

- (1) Alarm lamp
When a physiological alarm or technical alarm occurs, this lamp lights and flashes corresponding with the alarm priority:
 - ◆ High priority alarms: the lamp quickly flashes red.
 - ◆ Medium priority alarms: the lamp slowly flashes yellow.
 - ◆ Low priority alarms: the lamp lights in cyan without flashing.
- (2) AC Power input
- (3) Equipotential Grounding Terminal
When using the monitor together with other devices, connect their equipotential grounding terminals together to eliminate the potential difference between them.

- (4) Network Connector
It is a standard RJ45 connector which connects the monitor to the central monitoring system (CMS) or other network devices.
- (5) USB connectors
Connect approved USB devices, for example the barcode reader.
- (6) VGA connector
Connects a mirrored external display.
- (7) Multifunctional connector
Outputs analog ECG, IBP and defibrillator synchronization signals, also provides RS232 communication for interfacing with external devices, DIAP, etc..

2.3.2 External Modules

The external modules are used to monitor the patient's physiological parameters, and record patient information and data, and connect external devices. The monitor provides the following modules:

- Parameter modules: acquires and processes the patient's data and sends the data to the main unit. For details, see the relevant parameter chapters.

2.3.2.1 Available Modules

Refer to *28.9 External Modules* for available modules.

The monitor can simultaneously use maximum of two IBP modules (besides the built-in IBP modules). The other modules can only be used one at a time. Otherwise, the monitor will issue a module conflict prompt.

For example, if a CO₂ module is already loaded and then another CO₂ module is inserted, the monitor will then prompt module conflict. To solve the problem of module conflict, just remove one of the modules.

2.3.2.2 Example Module

The parameter modules have similar structure:

- The parameter label is marked at the upper left corner.
- Hard keys are located on the upper part.
- Patient cable connectors are located at the lower part.

Take the IBP module as an example:

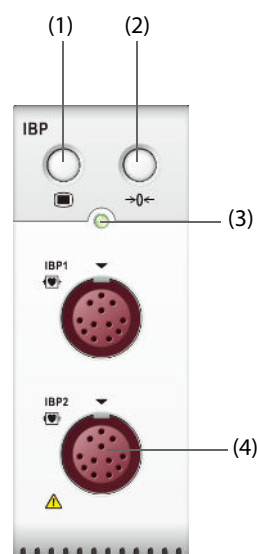

- (1) IBP dialog hard key: enters or exits the IBP dialog.
- (2) Zero IBP hard key: enters the **Zero IBP** dialog.
- (3) Module status indicator
 - ◆ On: the module works properly.
 - ◆ Flashing: the module is initializing.
 - ◆ Off: the module is not connected or the module fails.
- (4) IBP cable connectors

2.3.3 Input Devices

The monitor allows data entry through touchscreen, remote controller, hard key, and barcode reader.

Only Mindray specified input devices should be used.

2.3.4 Printing Devices

The monitor can use Mindray specified printer and/or recorder to output patient information and data.

The monitor is configured with a built-in recorder.

The printer can be connected to the monitor through the network to output patient reports.

3 Getting Started

3.1 Equipment Preparation Safety Information

WARNING

- Use only installation accessories specified by Mindray.
 - Connect only approved devices to this equipment. Devices connected to the equipment must meet the requirements of the applicable IEC standards (e.g. IEC 60950 safety standards for information technology equipment and IEC 60601-1 safety standards for medical electrical equipment). The system configuration must meet the requirements of the IEC 60601-1 medical electrical systems standard. Any personnel who connect devices to the equipment's signal input/output port are responsible for providing evidence that the safety certification of the devices has been performed in accordance to the IEC 60601-1. If you have any questions, please contact Mindray.
 - The monitor and parameter monitoring accessories are suitable for use within the patient environment. For other equipment and accessories connected to the monitor, consult corresponding manufacturers for the suitability within the patient environment.
 - If it is not evident from the equipment specifications whether a particular combination with other devices is hazardous, for example, due to summation of leakage currents, please consult the manufacturer or an expert in the field. A determination must be made that the proposed combination will not negatively affect the devices themselves or the patient's safety.
-

CAUTION

- The equipment should be installed by Mindray authorized personnel.
 - When disposing of the packaging material, be sure to observe the applicable waste control regulations and keep it out of children's reach.
 - Before use, verify whether the packages are intact, especially the packages of single use accessories. In case of any damage, do not apply it to the patient.
 - Make sure that the equipment operating environment meets the specific requirements. Otherwise unexpected consequences, e.g. damage to the equipment, could result.
 - Avoid rough handling during transport.
-

NOTE

- This manual is based on the maximum configuration and therefore some contents may not apply to the product. If you have any question, please contact Mindray.
 - Put the equipment in a location where it can be easily viewed and operated.
 - Keep this manual in the vicinity of the equipment so that it can be referenced when needed.
 - Save the packing case and packaging material as they can be used if the equipment must be reshipped.
 - Many settings in the patient monitor are password protected. It is recommended to change the default passwords and keep the passwords safe. Passwords should only be changed by authorized personnel. Contact the department manager or biomedical engineering department for the passwords used at the facility.
-

3.2 Monitor Installation

The monitor can be installed in various ways as required.

- Wall mount
- Placed on desk
- Trolley tray
- Bedrail clamp
- Bedrail hook

3.2.1 Unpacking and Checking

Before unpacking, examine the packaging carefully for signs of damage. If any damage is detected, contact the carrier, distributor, or Mindray.

If the packing case is intact, open the package and remove the equipment and accessories carefully. Check all materials against the packing list and check for any mechanical damage. Contact Mindray in case of any problems.

3.2.2 Environmental Requirements

The operating environment of the equipment must meet the requirements specified in this manual.

The environment where the equipment is used shall be reasonably free from noises, vibration, dust, corrosive, flammable and explosive substances. Moreover, to maintain good ventilation, the equipment shall be at least 2 inches (5cm) away from the walls of the cabinet.

When the equipment is moved from one place to another, condensation may occur as a result of temperature or humidity difference. In this case, never start the system before the condensation evaporates.

3.3 Setting Up the Equipment

Observance of this manual is a prerequisite for proper product performance and correct operation. It ensures patient and operator safety.

3.3.1 Connecting the AC Mains

The monitor is powered by an AC power supply. Before connecting the equipment to the AC mains, check that the voltage and frequency ratings of the power line are the same as those indicated beside the AC power input.

To use the AC power source, follow this procedure:

1. Connect the female end of the power cord with the AC power input.
2. Connect the male end of the power cord with a wall AC outlet.
3. Check that the AC indicator is on.

The AC indicator is off if the AC mains is not connected. When AC mains is connected, the AC indicator is illuminated in green.

WARNING

- **Operate the equipment on battery power if the integrity of the protective earth conductor or the protective earthing system in the installation is in doubt.**
-
-

CAUTION

- **Always use the accompanying power cord delivered with the monitor.**
 - **Before connecting the equipment to the AC mains, ensure that the voltage and frequency ratings of the power line are the same as those indicated beside the AC power input.**
-

NOTE

- Use the cable retainer to secure the power cord to prevent it from falling off.

3.3.2 Connecting the Input Devices

Connect the barcode reader to the USB ports if necessary.

3.3.3 Connecting the Parameter Module

To connect the parameter module, follow this procedure:

1. Push the module rack door open, and then push it up until there is a click.

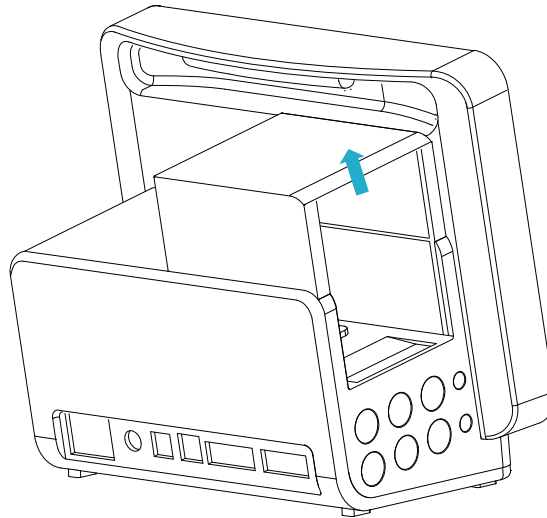

2. With the module properly oriented, align the module insertion guide slot with the module rack insertion guide. Push the module into the module rack until there is a click.
3. Push the lock at the bottom of the module inwards to lock the module.

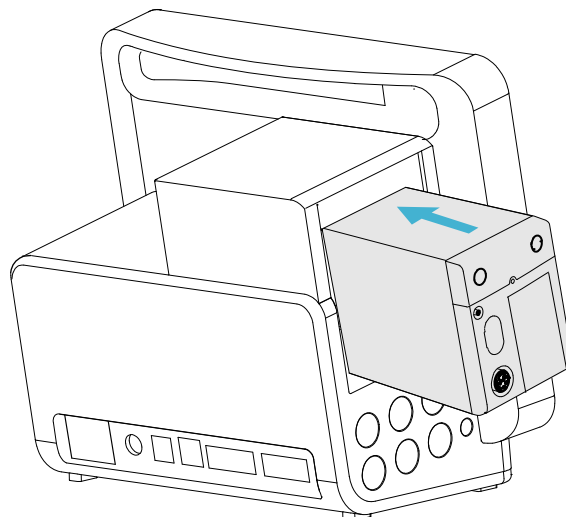

3.3.4 Removing the Parameter Module

To remove the parameter module, follow this procedure:

1. Pull outwards the lock at the bottom of the module to unlock the module.
2. Lift the latches at the bottom of the module to release it and slide the module out of the module rack. Hold on the module to make sure it does not drop when it comes out.

CAUTION

- **When removing the module, be careful not to drop it. Always support the module with one hand while pulling out with the other.**
-

3.4 Turning on the Monitor

Before beginning measurements, turn on the monitor. Perform the following inspections:

1. Check the monitor and modules for any mechanical damage. Make sure that all external cables, plug-ins and accessories are properly connected.
2. Connect the power cord to the AC power source.

Pressing the power switch turns on the monitor. When the monitor is turned on, the alarms are paused for two minutes. Then the alarm system is activated.

CAUTION

- **Check that visual and auditory alarm signals are presented correctly when the equipment is powered on.**
 - **Do not use the monitor for any monitoring procedure on a patient if you suspect it is not working properly, or if it is mechanically damaged. Contact the service personnel or Mindray.**
-

3.5 Operation and Navigation

Everything needed to operate the monitor is on its screen. Almost every element on the screen is interactive. Screen elements include parameter values, waveforms, quick keys, information fields, alarms fields, dialogs, and menus. Often you can access the same element in different ways. For example, you can access a parameter dialog by selecting the corresponding numeric area or waveform area through the Menu hard key  on the parameter module, or through the **Parameters Setup** quick key.

3.5.1 Using the Touchscreen

You can use the touchscreen to select a screen element by pressing directly on the monitor's screen.

3.5.1.1 Tapping or Swiping across the Screen

- Tapping the screen
 - ◆ To select an item from menus or lists or select a quick key, tap on it with your finger.
 - ◆ To enter a parameter menu, tap the corresponding numeric area or waveform area. For example, select the ECG numeric area or waveform area to enter the **ECG** menu.
- Swiping the screen with a single finger
 - ◆ To scroll through a list or a menu, swipe up or down.
 - ◆ To show or expand the Minitrends screen or the EWS screen, swipe right across the corresponding screen.
 - ◆ To contract or hide the Minitrends screen or the EWS screen, swipe left across the corresponding screen.
- Swiping across the screen with two fingers
 - ◆ To switch to another screen, swipe left or right across the screen. For example, on the Normal screen, swipe with two fingers from left to right to switch to the Minitrends screen.

- ◆ To discharge a patient, swipe from top to bottom.

3.5.1.2 Locking the Touchscreen

To avoid accidental use, you can temporarily disable the touchscreen by holding and pressing the **Main Menu** quick key and sliding as directed by the arrow. A padlock symbol  displays at the top of the main menu quick key if the touchscreen is disabled.

The touchscreen lock period is configurable. To do so, follow this procedure:

1. Access **Display** in either of the following ways:
 - ◆ Select the **Screen Setup** quick key → select the **Display** tab.
 - ◆ Select the **Main Menu** quick key → from the **Display** column select **Display**.
2. Set **Screen Lock Duration**.





The touchscreen is enabled when the preset time is reached. To manually enable the touchscreen, hold and press the **Main Menu** quick key and slide as directed by the arrow.

CAUTION

- **Check that the touchscreen is not damaged, broken, or loose. If there is any sign of damage, stop using the monitor and contact the service personnel.**
-

3.5.2 Using the On-Screen Keyboard

The on-screen keyboard enables information entry:

- Enter the information by selecting one character after another.
- Select the Backspace key  to delete single characters or select  to delete the entire entry.
- Select the Caps Lock key  to access uppercase letters.
- Select the Enter key  to confirm the entry and close the on-screen keyboard.

If a conventional keyboard is connected to the monitor, you can use it instead of, or in combination with, the on-screen keyboard.

3.5.3 Using the Barcode Reader

The monitor supports both a linear (1D) barcode reader and two-dimensional (2D) barcode reader. The barcode reader is connected to the monitor's USB connector.

NOTE

- **The Mindray custom barcode reader can scan both 2D and 1D barcodes. Other barcode readers can only output the patient's medical record number (MRN) and visit number.**
-

3.5.3.1 Clearing Old Data Formats (for the Mindray Custom 2D Barcode Reader)

If you are using the Mindray custom 2D barcode reader (Model HS-1R or HS-1M), before using it for the first time, clear old data formats and configure the barcode reader. To do so, follow this procedure:

1. Scan the engineering barcode to clear the previous data format.
2. Scan the 2D engineering barcode which contains the hospital's data format.

NOTE

- **Contact the scanner manufacturer or Mindray to obtain the barcodes for clearing data formats and programming the hospital's data format.**
-

3.5.4 Using the Remote Controller

The remote controller can control the monitor by connecting the receiver of the remote controller to the monitor's USB connector. For more information on how to use the remote controller, see the Instructions for Use delivered with the remote controller.

3.6 Screen Display



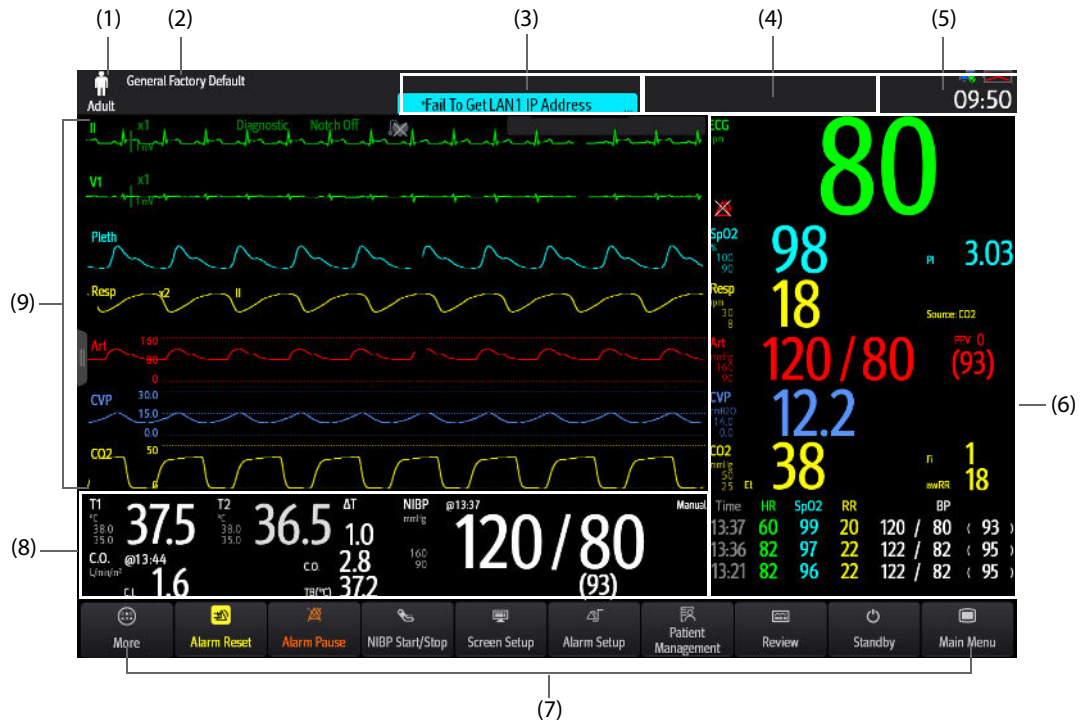

















The following figure shows the normal screen:



- (1) Patient information area: displays patient information, including patient category, gender, department, room number, bed number, and so on. The displayed patient information is configurable. Selecting this area enters the **Patient Management** dialog. For more information, see 5.2.1 *Entering the Patient Management Dialog*.
- (2) The current configuration: displays the name of the configuration that can be loaded from the main menu.
- (3) Technical alarm information area: displays prompt messages at the top; displays technical alarm messages at the bottom.
- (4) Physiological alarm information area: displays high priority physiological alarms at the top; displays medium and low priority physiological alarms at the bottom.
- (5) System status information area: displays alarm symbol, battery status, network status, currently connected CMS, storage device status, and system time. For more information, see 3.6.1 *On-screen Symbols*.
- (6) Parameter numerics area: displays parameter values, alarm limits, and alarm status. This area can also display the parameter list. For more information, see 3.9.3 *Displaying the Parameter List*. Selecting a parameter numeric area enters the corresponding parameter dialog. Selecting the parameter list enters Tabular Trends review.
- (7) Quick key area: displays quick keys.
- (8) Parameter numeric/waveform area: unique area of the screen that can be configured to display either parameter numerics or parameter waveforms. Depending on the configuration, the tiles take on the characteristics of either area (6) or area (9).
- (9) Parameter waveform area: displays parameter waveforms, measurement ranges, and magnifications. Selecting a waveform enters the corresponding parameter dialog.

3.6.1 On-screen Symbols

The following table lists the on-screen symbols displayed on the system status information area:

Symbol	Description	Symbol	Description
	Adult, male		Adult, female
	Pediatric, male		Pediatric, female
	Neonate, male		Neonate, female
	All the alarms are paused.		Individual physiological alarms are turned off or the monitor is in the alarm off status.
	Audible alarm tones are paused.		Audible alarm tones are turned off.
	The alarm system is reset.		The battery is working correctly. The green portion represents the remaining charge.
	The battery has low power and needs to be charged.		The battery has critically low charge and needs to be charged immediately. Otherwise, the monitor will soon automatically shut down soon.
	The battery is being charged.		No battery is installed.
	Wired network is connected.		Wired network is not connected.
	Wireless network is connected. The solid part indicates network signal strength.		Wireless network is not connected.
	Wireless network is disabled.		

3.6.2 Dialogs

All dialogs have similar style and structure, see the figure below:



- (1) Dialog heading
- (2) Tabs
- (3) Operation buttons
- (4) Exit button: closes the current dialog.
- (5) Main body area: includes dialog items and options.
- (6) Switch:
 - ◆ Green: the switch is on.
 - ◆ Gray: the switch is off.

3.6.3 Quick Keys

The monitor provides quick keys for you to quick access to some functions. The quick key area is located at the bottom of the screen. The **Main Menu** key is permanently located the right, and the **More** key is permanently located at the left. Selecting the **More** quick key shows more quick keys. The quick keys displayed on the screen are configurable.

3.6.3.1 Available Quick Keys

The following table shows available quick keys.

Symbol	Label	Function	Symbol	Label	Function
	Main Menu	Enters the main menu.		More	Shows more quick keys.
	Alarm Setup	Enters the Alarm dialog.		Alarm Reset	Resets the alarm system.
	Alarm Pause	Pauses the physiological alarm system (Availability depends on configuration of Pause in Maintenance → Alarm → Pause/Reset dialog).		Audio Pause	Pauses alarm tone (Availability depends on configuration of Pause in Maintenance → Alarm → Pause/Reset dialog).
	Review	Enters the Review dialog to review historical data.		Standby	Enters the standby mode.
	Patient Management	Enters the Patient Management dialog.		Screen Setup	Enters the Screen Setup dialog.
	NIBP Start/ Stop	Starts an NIBP measurement or stops the current NIBP measurement.		NIBP Stop All	Stops all NIBP measurements.
	NIBP STAT	Starts a five-minute continuous NIBP measurement.		NIBP Measure	Opens the NIBP Measure interval options.
	Intubation Mode	Enters the intubation mode.		Venipuncture	Inflates the NIBP cuff to help venous puncture.
	Zero IBP	Enters the Zero IBP dialog.		PAWP	Opens the PAWP screen.
	C.O. Measure	Opens the C.O. Measure screen.		CPB Mode	Enters the CPB mode.
	Integrated Devices	Enters the Integrated Device screen		Call Help	Sends the Call Help signal over the network.
	Parameters Setup	Enters the Parameters Setup dialog.		Remote View	Opens the Remote View screen to view other patients.
	Manual Event	Manually saves an event into the Events list.		Minitrends	Opens the Minitrends screen.

Symbol	Label	Function	Symbol	Label	Function
	ECG Lead/Gain	Enters the ECG Lead/Gain dialog.		Night Mode	Enters the night mode.
	Volume	Enters the Volume dialog.		Freeze	Freezes waveforms.
	Calculations	Enters the Calculations dialog.		Load Config	Enters the Load Config dialog.
	Print	Starts printing a real-time report.		Record	Starts/Stops a recording.
	End Case Report	Prints the selected end case reports.		GCS	Enters the GCS dialog.
	Discharge Patient	Enters the Discharge Patient dialog to discharge the patient and restore pre-configured default settings.		Discharged Patients	Enters the Discharged Patients dialog and displays previously discharged patients.
	ECG Full-Screen	Opens the ECG full screen.		OxyCRG	Opens the OxyCRG screen.
	Privacy Mode	Enters Privacy mode.		ECG 24h Sum	Views the 24-hour ECG summary.
	EWS	Opens the EWS screen.		Targeted Goal	Opens the Targeted Goal screen.

3.6.3.2 Configuring the Displayed Quick Keys

To select the quick keys for display, follow this procedure:

1. Access **Quick Keys** in either of the following ways:
 - ◆ Select the **Screen Setup** quick key → the **Select Quick Keys** tab.
 - ◆ Select the **Main Menu** quick key → from the **Display** column select **Quick Keys**.
2. Select the **Current** tab to configure the quick keys for display on the screen: From the top of this page, select a block location to show a certain quick key, and then select the quick key from the quick key list. For example, to show the **Screen Setup** quick key at the first block, select the first block, and then select **Screen Setup** from the list.
3. Select the **More** tab to configure the quick keys for display when the **More** quick key is selected.

3.7 Operating Modes

The monitor provides different operating modes.

3.7.1 Monitoring Mode

The monitoring mode is the most frequently used clinical mode for patient monitoring. When the monitor is turned on, it automatically enters the monitoring mode.

3.7.2 Privacy Mode

The privacy mode is a special clinical monitoring mode. In the privacy mode, the monitor does not display patient information and monitoring data. This provides controlled access to patient data and ensures confidentiality.

The privacy mode is only available when the patient admitted by the monitor is also monitored by the CMS. The monitor continues monitoring the patient, but patient data is only visible at the CMS.

3.7.2.1 Entering the Privacy Mode

To enter the privacy mode, choose either of the following ways:

- Select the **Privacy Mode** quick key → select **OK**.
- Select the **Main Menu** quick key → from the **Display** column select **Privacy Mode** → select **OK**.

The monitor has the following features after entering the privacy mode:

- The screen turns blank.
- Except for the low battery alarm, the monitor inactivates alarm tones and alarm lights for all other alarms.
- The monitor suppresses all system sounds, including heart beat tone, pulse tone, and prompt tone.

WARNING

- **In the privacy mode, all audible alarms are suppressed and the alarm light is deactivated at the monitor. Alarms are presented only at the CMS. Pay attention to potential risk.**
-

NOTE

- **The privacy mode is not available if the Department is set to OR.**
 - **You cannot enter the privacy mode if a low battery alarm is active.**
-

3.7.2.2 Exiting the Privacy Mode

The monitor automatically exit the privacy mode in any of the following situations:

- The monitor disconnects from the CMS.
- The low battery alarm occurs.

You can also operate the touchscreen, mouse, or keyboard to manually exit the privacy mode.

3.7.3 Night Mode

The night mode is a special clinical monitoring mode. To avoid disturbing the patient, you can use the night mode.

You can disable the night mode feature. This is password protected. For more information, see **Disable Night Mode** in 24.3.9.4 *Setting the Night Mode Switch*.

3.7.3.1 Entering the Night Mode

Select the **Night Mode** quick key to enter the night mode. You can also follow this procedure to enter the night mode:

1. Access night mode setup in either of the following ways:
 - ◆ Select the **Main Menu** quick key → from the **Display** column select **Night Mode**.
 - ◆ Select the **Alarm Setup** quick key → select the **Night Mode** tab.
2. Change the night mode settings if necessary.
3. Select **Enter Night Mode**.

CAUTION

- **Verify the night mode settings before entering the night mode. Pay attention to potential risk in case of improper settings.**
-

NOTE

- **If the night mode feature is disabled, the Night Mode option is not available.**
-

3.7.3.2 Setting the Auto Night Mode Switch

You can configure the monitor to automatically enter and exit the night mode. To do so, follow this procedure:

1. Access night mode setup in either of the following ways:
 - ◆ Select the **Main Menu** quick key → from the **Display** column select **Night Mode**.
 - ◆ Select the **Alarm Setup** quick key → select the **Night Mode** tab.
2. Switch on or off **Auto Night Mode**.
 - ◆ **On:** the monitor automatically enters the night mode when the night mode period starts and exits the night mode when the night mode period ends. For more information on setting the night time period, see *24.8.1.4 Defining the Night Time Period*.
 - ◆ **Off:** the monitor will not automatically enter the night mode. To manually enter the night mode, see **Nighttime** from *3.7.3.1 Entering the Night Mode*.

The Auto Night Mode switch is Off by default.

3.7.3.3 Changing Night Mode Settings

To change night mode settings, follow this procedure:

1. Access night mode setup in either of the following ways:
 - ◆ Select the **Main Menu** quick key → from the **Display** column select **Night Mode**.
 - ◆ Select the **Alarm Setup** quick key → select the **Night Mode** tab.
2. Change the following settings as necessary.
 - ◆ Screen brightness
 - ◆ Alarm volume, QRS volume, key-striking volume, and reminder volume
 - ◆ NIBP End Tone switch and Stop NIBP switch

3.7.3.4 Muting All Monitor Sounds

If the monitor is connected with the CMS, you can silence the monitor in the Night mode. To do so, switch on **All Mute** from the **Night Mode Setup** dialog. Local password for accessing the Maintenance dialog is required for switching on **All Mute**.

After the monitor is silenced, the monitor will not generate the alarm tone, QRS tone, key tone, reminder tone, or NIBP end tone.

NOTE

- **Alarms at the bedside monitor will be restored if connection to the CMS is interrupted.**
-

3.7.3.5 Exiting the Night Mode

Exit the night mode in any of the follow ways:

- Select the Exit Night Mode quick key → select **OK**.
- Select the **Main Menu** quick key → from the **Display** column select **Exit Night Mode** → select **OK**.
- Select the **Alarm Setup** quick key → select the **Night Mode** tab → select **Exit Night Mode** → select **OK**.

NOTE

- **If your monitor is connected to the CMS, it automatically exits the night mode if the connection to the CMS is interrupted.**
 - **The monitor reverts to the previous settings after exiting the night mode.**
-

3.7.4 Standby Mode

You can temporarily stop patient monitoring without switching off the monitor by entering the standby mode.

3.7.4.1 Entering the Standby Mode

1. Select the **Standby** quick key, or select the **Main Menu** quick key → from the **Patient Management** column select **Standby**.
2. Define where the patient is by selecting a location in the drop down list when the monitor enters the standby mode.
3. Select **OK**.

The monitor behaves as follows after entering the standby mode:

- Stops all parameter measurements.
- Disables all the alarms and prompt messages, except for the battery low alarm.
- Turns screen brightness to the dimmest after entering the standby mode for 30 seconds.

WARNING

- **Pay attention to the potential risk of placing the monitor to standby. In the standby mode, the monitor stops all parameter measurements and disable all the alarm indications, except for the battery low alarm.**
-

3.7.4.2 Changing the Patient Location at Standby

To change the patient's location, select patient location from the Standby screen.

3.7.4.3 Exiting the Standby Mode

To exit the standby mode, choose any of the following ways:

- Select **Resume monitor** to exit the standby mode and resume monitoring the current patient.
- Select **Discharge Patient** to discharge the current patient.

If the monitor automatically enters the standby mode after a patient is discharged, choose any of the following ways to exit the standby mode:

- Select **Monitor** to exit the standby mode and admit a new patient.
- Select **Patient Management** to enter the patient information for preparing to admit a new patient.

When the monitor exits the standby mode and resumes monitoring, the alarms are paused for two minutes, after which the alarm system is activated.

3.7.5 Discharge Mode

The discharge mode is a special standby mode after a patient is discharged.

3.8 Configuring the Monitor

Configure the monitor before putting it in use.

3.8.1 Setting the Date and Time

To set the system time, follow this procedure:

1. Select the **Main Menu** quick key → from the **System** column select **Time**.
2. Set **Date** and **Time**.
3. Set **Date Format**.
4. If you want to use the 12-hour mode, switch off **24-Hour Time**.
5. If you want to use daylight savings time, switch on **Daylight Savings Time**. You can manually switch on or off daylight saving time only when the auto daylight savings time function is disabled. For more information, see 24.8.2 *Enabling Auto Daylight Savings Time* for details.

If the monitor is connected to a central monitoring system (CMS) or hospital clinical system (HIS), the date and time are automatically taken from the CMS. In this case, you cannot change the date and time on the monitor.

CAUTION

- **Changing the date and time affects the storage of trends and events and may result in loss of data.**
-

3.8.2 Adjusting the Screen Brightness

To adjust the screen brightness, follow this procedure:

1. Access **Display** in either of the following ways:
 - ◆ Select the **Screen Setup** quick key → select the **Display** tab.
 - ◆ Select the **Main Menu** quick key → from the **Display** column select **Display**.
2. Set **Brightness**. If **Brightness** is set to **Auto**, the monitor automatically adjusts the screen brightness according to the ambient light.

NOTE

- **Screen brightness automatically changes with ambient light level when Brightness is set to Auto.**
-

3.8.3 Adjusting the Volume

- Set **Alarm Volume** in either of the following ways:
 - ◆ Select the **Volume** quick key.
 - ◆ Select the **Main Menu** quick key → from the **Alarm** column select **Setup**.
- Set **Reminder Volume** by selecting the **Main Menu** quick key → from the **Alarm** column select **Setup**.
- Set **QRS Volume** in any of the following ways:
 - ◆ Select the **Volume** quick key.
 - ◆ From the ECG dialog select **Setup**.
 - ◆ From the SpO₂ dialog select **PR Setup**.
- Select the **Volume** quick key to set **Key Volume**.

3.9 General Operation

This section describes the operations that are generally used when monitoring a patient.

3.9.1 Switching On or Off a Parameter

You can manually switch on or off a parameter when its module is connected. If setting parameter switches is not password protected, follow this procedure to set parameter switches:

1. Access **Parameters On/Off** in either of the following ways:
 - ◆ Select the **Screen Setup** quick key → select the **Parameters On/Off** tab.
 - ◆ Select the **Main Menu** quick key → from the **Parameters** column select **Parameters On/Off**.

2. Switch on or off the desired parameters.

When a parameter is switched off, the monitor stops data acquisition and alarming for this measurement.

NOTE

- **When a parameter is manually switched off, you cannot monitor this parameter even if the corresponding parameter module is plugged in and related accessories of this parameter are connected.**
-

3.9.2 Displaying Parameter Numerics and Waveforms

You can configure the parameter numerics, waveforms, and their sequence displayed on the normal screen. To do so, follow this procedure:

1. Access **Tile Layout** in either of the following ways:
 - ◆ Select the **Screen Setup** quick key → select the **Tile Layout** tab.
 - ◆ Select the **Main Menu** quick key → from the **Display** column select **Tile Layout**.
2. Select a parameter numeric area or waveform area, and then from the popup list select an element to display in this area. The parameters and waveforms not selected you did not select will not be displayed.

3.9.3 Displaying the Parameter List

You can display the trends of HR, SpO₂, RR, and NIBP/IBP in the parameter numerics area. To do so, follow this procedure:

1. Access **Tile Layout** in either of the following ways:
 - ◆ Select the **Screen Setup** quick key → select the **Tile Layout** tab.
 - ◆ Select the **Main Menu** quick key → from the **Display** column select **Tile Layout**.

Select the parameter numerics area where you want to display the parameter list, and then from the popup list select **Parameter List**.

3.9.4 Accessing Parameter Setup Dialogs

Each parameter has a setup dialog in which you can adjust the alarm and parameter settings. To enter a parameter setup dialog, choose any of the following ways:

- Select the parameter numeric area or waveform area.
- Press the setup hard key  on the module front.
- Select the **Parameters Setup** quick key, and then select the desired parameter.
- Select the **Main Menu** quick key → from the **Parameters** column select **Setup** → select the desired parameter.

NOTE

- **In this manual, the first method is normally used to enter the setup dialog. But you can use any method you prefer.**
-

3.9.5 Accessing the On-screen Guide

The monitor provides the on-screen guide to help you understand parameter monitoring functions. On-screen guide provides measurement principle, points to note, accessory connection, operating procedure, and so on.

To access the on-screen guide, follow this procedure:

1. Select the desired numerics area or waveform area to enter the parameter menu.
2. Select the **Introduction** tab.
3. Select a tab as required.

NOTE

- **The on-screen guide is not available for Respiration, temperature, and C.O. monitoring.**
-

3.9.6 Changing Measurement Colors

You can set the color of measurement values and waveforms for each parameter. To do so, follow this procedure:

1. Select **Main Menu** quick key → from the **Parameters** column select **Parameter Color**.
2. Select the **Current** tab and set the colors of the currently monitoring measurement values and waveforms.
3. Select the **All** tab and set the colors of measurement values and waveforms for all parameters.

3.10 Initiating a Manual Event

To save a manual event, follow this procedure:

1. Select the **Manual Event** quick key to enter the **Manual Event** menu.
2. Select a name for this event, for example **Intubated**, or input a name.
3. Select **OK**.

To edit the name of preset event names, select  to enter the **Manual Event Setup** menu.

Selecting or editing manual event name functionality is available only if the **Manual Event Edit** switch is turned on. For more information, see *24.14.3 Setting the Manual Event Edit Switch*.

You can review the manual events. For more information, see *17.2.7 Events Review Page*.

3.11 Freezing Waveforms

During patient monitoring, the freeze feature allows you to freeze the currently displayed waveforms on the screen so that you can have a close examination of the patient's status. Additionally, you can select any frozen waveform for recording.



3.11.1 Freezing Waveforms

To freeze waveforms, select the **Freeze** quick key. Except waveforms of the following screens, all displayed waveforms stop refreshing and scrolling after you select the **Freeze** quick key:

- **Minitrends** screen
- **OxyCRG** screen
- **Remote View** screen
- **EWS** screen

3.11.2 Viewing Frozen Waveforms

To view the frozen waveforms, follow this procedure:

- Select the  or  button in the **Freeze** screen.
- Slide the frozen waveform leftward or rightward.

At the lower right corner of the bottom-most waveform displays the freeze time. The initial frozen time is **0 s**. With the waveforms scrolling, the freeze time changes at an interval of 1 second. For example, **-2 s** means two seconds before the frozen time. This change will be applied for all waveforms on the screen.

NOTE

- **You can view the frozen waveforms of up to 120 seconds.**
-

3.11.3 Unfreezing Waveforms

To unfreeze the frozen waveforms, select the  button at the upper right corner of the **Freeze** screen.

3.11.4 Printing Frozen Waveforms

To print the frozen waveforms, select the  button at the upper left corner of the **Freeze** screen.

3.12 Capturing the Screen

The monitor provides the function of screen capture. To capture the current screen display, follow this procedure:

1. Connect the USB drive to the monitor's USB connector.
2. Press and hold the **More** quick key. Wait until it turns from blue to grey.

The screen capture function is disabled default. If you need this function, contact the service personnel.

3.13 Connecting the CMS

You can connect the monitor to the BeneVision CMS through wired LAN or wireless LAN. When connected to the CMS, the system provides the following function.

- The monitor can transmit parameter values, waveforms, alarms, and events to the CMS. From the CMS, you can check the patient's monitoring data and alarms.
- The monitor can transmit parameter values and alarms from the connected external devices to the CMS. From the CMS you can check the patient's monitoring data and alarms obtained from the connected external devices.
- Patient information, alarm settings, and alarm status can be synchronized between the monitor and the CMS.
- You can start or stop NIBP measurements from the CMS.
- In case of network disconnection, the monitor can transmit the offline data to the CMS when the network is reconnected.

For more information on the CMS, see the operator's manual of corresponding central monitoring system.

To select a CMS, select the system status information area at the top right corner of the main screen. Select the desired CMS from the popup CMS list.

NOTE

-
- **You can select CMS only when the Select CMS switch is on. For more information, see 24.12.6 *Enabling Selecting a CMS.***
-

3.14 Connecting the eGateway

You can connect the monitor to the eGateway through wired LAN or wireless LAN to implement interaction between the monitor and external devices. When connected to the eGateway, the system provides the following functions:

- The monitor can transmit parameter values, waveforms, alarm settings, and events to the eGateway.
- The monitor can transmit parameter values and alarm settings received from the external devices to the eGateway.
- Clock can be synchronized between the monitor and the eGateway.

3.15 Connecting the Wireless Network

You can add up to five wireless networks for the monitor. For more information, see *24.12.4 Setting the Wireless Network*.

If connecting the current wireless network fails, the monitor automatically connects other wireless networks in the order when they were added.

To manually switch the wireless network, from the system status information area on the top right corner of the screen select , and select the desired wireless network.

3.16 Disconnecting the Wireless Network

To disconnect the wireless network manually, follow this procedure:

1. Swipe the screen from top down with a single finger.
2. Select .

To reconnect the wireless network after it is disconnected manually, follow this procedure:

1. Swipe the screen from top down with a single finger.
2. Select .

3.17 Turning Off the Monitor

Before turning off the monitor, perform the following check:

1. Ensure that monitoring of the patient has been completed.
2. Disconnect the cables and sensors from the patient.
3. Save or clear the patient data as required.

To turn off the monitor, press and hold the power switch for 3 seconds.

CAUTION

- **Press and hold the power switch for 10 seconds to forcibly shut down the monitor if it could not be shut down normally. This may cause loss of patient data.**

NOTE

- **Turning off the monitor does not disconnect the monitor from the AC mains. To completely disconnect the power supply, unplug the power cord.**
 - **In case of a temporary power failure, if the power is restored within 30 minutes, monitoring will resume with all active settings unchanged. If the monitor is without power for more than 30 minutes, it behaves the same as if it were normally turned off.**
-

4 User Screens

The monitor provides different user screens to facilitate patient monitoring in different departments and clinical applications.

4.1 Choosing a Screen

The monitor enters the normal screen after it is powered on. The normal screen is most frequently used for patient monitoring. To select other screens, follow this procedure:

1. Access the **Choose Screen** tab in either of the following ways:
 - ◆ Select the **Screen Setup** quick key.
 - ◆ Select the **Main Menu** quick key → from the **Display** column select **Choose Screen**.
2. Select the desired screen.

You can also quickly choose a screen by swiping across the screen with two fingers.

- For adult and pediatric patients:
 - ◆ From the minitrends screen, swiping left or right across the touchscreen can switch screens between the normal screen, the big numeric screen, and the minitrends screen.
 - ◆ From the EWS screen, swiping left or right across the touchscreen can switch screens between the normal screen, the big numeric screen, and the EWS screen.
- For neonatal patients, swiping left or right across the touchscreen can switch screens between the Targeted Goal screen, the OxyCRG screen, and the big numeric screen.

4.2 Setting Screens Switched by Swiping Across the Screen

You can select maximum of four screens that can be switched by swiping across the screen with two fingers. To do so, follow this procedure:

1. Access **Screen Setup** in either of the following ways:
 - ◆ Select the **Screen Setup** quick key.
 - ◆ Select the **Main Menu** quick key → from the **Display** column select **Choose Screen**.
2. Select the **Switch Screen** tab
3. Respectively set **Screen 1**, **Screen 2**, **Screen 3**, and **Screen 4**.

4.3 Normal Screen

The normal screen is most frequently used for patient monitoring. For general department, ICU, and CCU, normal screen is used by default.

4.3.1 Entering the Normal Screen

To enter the normal screen, choose any of the following ways:

- Swipe left or right across the touchscreen with two fingers until you switch to the normal screen.
- Select the **Screen Setup** quick key → select the **Choose Screen** tab → select **Normal Screen**.
- Select the **Main Menu** quick key → from the **Display** column select **Choose Screen** → select **Normal Screen**.

4.3.2 Configuring the Normal Screen

You can configure the parameter numerics, waveforms, and their sequence displayed on the normal screen. To do so, follow this procedure:

1. Access **Tile Layout** in either of the following ways:
 - ◆ Select the **Screen Setup** quick key.
 - ◆ Select the **Main Menu** quick key → from the **Display** column select **Tile Layout**.
2. Select a parameter numeric area or waveform area, and then from the popup list select an element you want to display in this area. The parameters and waveforms you did not select will not be displayed.

4.4 The Big Numerics Screen

The Big Numerics screen displays parameter numerics in big font size. The Big Numerics screen displays measurement values and waveforms of up to six parameters. You can configure the parameters and their layout on the big numeric screen.

4.4.1 Entering the Big Numerics Screen

To enter the big numerics screen, choose any of the following ways:

- Swipe left or right across the touchscreen with two fingers until you switch to the big numerics screen.
- Select the **Screen Setup** quick key → select the **Choose Screen** tab → select **Big Numerics**.
- Select the **Main Menu** quick key → from the **Display** column select **Choose Screen** → select **Big Numerics**.

4.4.2 Configuring the Big Numerics Screen

To configure the big numerics screen, follow this procedure:

1. Access **Choose Screen** in either of the following ways:
 - ◆ Select the **Screen Setup** quick key.
 - ◆ Select the **Main Menu** quick key → from the **Display** column select **Choose Screen**.
2. Select the **Big Numerics** tab
3. Select a parameter numeric area or waveform area, and then from the popup list select an element to display in this area.

4.5 Minitrends Screen

The Minitrends screen shows the recent graphic trends of parameters.

4.5.1 Entering the Minitrends Screen

Choose one of the following methods to enter the Minitrends screen:

- Select the **Minitrends** quick key.
- Select the **Screen Setup** quick key → Select the **Choose Screen** tab → select **Minitrends**.
- Select the **Main Menu** quick key → from the **Display** column select **Choose Screen** → select **Minitrends**.

For adult and pediatric patients, when the Minitrends screen is hidden as , you can also choose one of the following methods to quickly enter the Minitrends screen.

- Swipe left or right across the touchscreen with two fingers until you switch to the Minitrends screen.
- Swipe right across the touchscreen with a single finger.
- Select the  button.

4.5.2 The Display of Minitrends Screen

The following figure shows the minitrends screen. Your display may be configured to look slightly different.

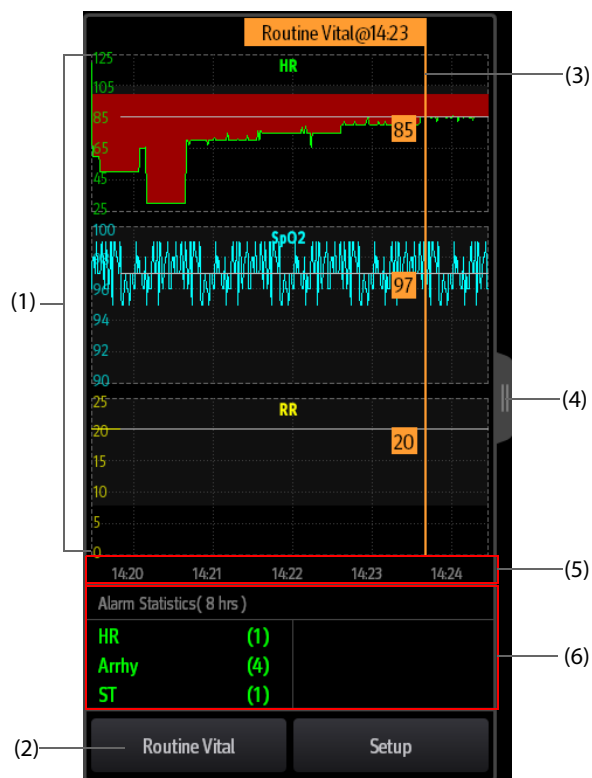

- (1) Scale
- (2) **Routine Vital/Baseline** button. If the department is set to **OR**, then the **Baseline** button is available. For other departments, the **Routine Vital** button is available.
- (3) Routine Vital/Baseline
- (4) Select this button to view the long trends, or contract the long trends screen to the Minitrends screen.
- (5) Time line
- (6) Alarm statistic area

4.5.3 Viewing the Long Trends

To expand the Minitrends screen to view the long trends, choose either of the following ways:

- Select the  button.
- Swipe right across the Minitrends screen with a finger.

4.5.4 Setting Minitrends Parameters

To set parameters, follow this procedure:

1. Enter the Minitrends screen.
2. Select the **Setup** button.
3. Set parameters. If you want to use the default parameters, select **Default Parameter**.

4.5.5 Setting the Minitrend Length

To set the Minitrend length, follow this procedure:

1. Enter the Minitrends screen.
2. Select the **Setup** button.
3. Set the **Minitrend Length**.

4.5.6 Setting the Alarm Statistics Switch

The Minitrends screen can be configured to display the statistic number of physiological alarms in its lower half screen. To set the alarm statistics switch, follow this procedure:

1. Enter the Minitrends screen.
2. Select the **Setup** button.
3. Switch on or off the **Alarm Statistics** switch.

4.5.7 Setting the Alarm Statistics Duration

The time length within which the alarms statistics are made is configurable. To set the alarm statistics length, follow this procedure:

1. Enter the Minitrends screen.
2. Select the **Setup** button.
3. Set **Alarm Statistics Duration**.

4.5.8 Routine Vital/Baseline

The Routine vital/Baseline function is used for marking the parameter measurements of certain moment for later reference. If the department is set to **OR**, then the **Baseline** button is available. For other departments, the **Routine Vital** button is available.

4.5.8.1 Manually Marking the Routine Vital/Baseline

To manually mark the Routine Vital/Baseline, follow this procedure:

1. Enter the Minitrends screen.
2. Select the **Routine Vital** button or **Baseline** button.

NOTE

- **If you do not see the Baseline button or Routine Vital button in the Minitrends screen, you can select the Setup button and switch on the Baseline switch, or set the Routine Vital to Manual or Auto.**
-

4.5.8.2 Configuring Automatic Routine Vital Settings

The monitor can automatically mark the routine vital sign values. To enable this function, follow this procedure:

1. Enter the Minitrends screen.
2. Select the **Setup** button.
3. Select **Auto** from the dropdown list of **Routine Vital**.
4. Select **Time** to set the time for marking the first routine vital sign values.
5. Select **Interval** to set the interval for marking the routine vital sign values.

4.6 The OxyCRG Screen

The monitor displays the OxyCRG screen by default when the neonatology department is selected. The OxyCRG screen is available in any department setting, but only when **Patient Category** is set to **Neo**. This screen displays 6-minute HR, SpO₂ trends, CO₂/Resp compressed waveform, ABD parameters, and the latest ABD events.

The OxyCRG function is intended for neonatal patients only.

4.6.1 Entering the OxyCRG Screen

To enter the OxyCRG screen, choose any of the following ways:

- Swipe left or right on the touchscreen with two fingers to switch to the OxyCRG screen.
- Select the **OxyCRG** quick key.
- Select the **Screen Setup** quick key → select the **Choose Screen** tab → select **OxyCRG**.
- Select the **Main Menu** quick key → from the **Display** column select **Choose Screen** → select **OxyCRG**.

4.6.2 The Display of the OxyCRG Screen

The following figure shows the OxyCRG screen. Your display may be configured to look slightly different.

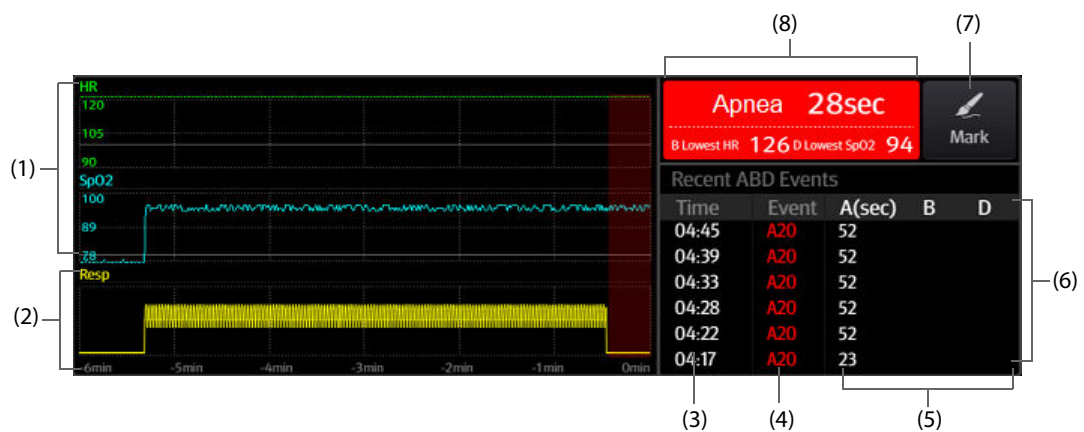

- (1) HR, SpO₂ trend
- (2) Resp/CO₂ compressed waveform
- (3) Event time
- (4) Event type
- (5) Parameter values of ABD events
- (6) ABD event list: displays the latest red ABD events. Selecting the ABD event list area enters the OxyCRG review page.
- (7) Mark button: opens the **Mark** dialog to edit the events.
- (8) ABD event prompt area: displays parameter values of currently active OxyCRG events.

4.6.3 OxyCRG Events

The following table lists the ABD events and their criteria:

Event type	Description	Remarks
A	Apnea event: the apnea duration exceeds the threshold. <ul style="list-style-type: none">• A20: the apnea duration is greater or equal to 20 seconds.• A15: the apnea duration is between 15 to 20 seconds (excluding 20 seconds).• A10: the apnea duration is between 10 to 15 seconds (excluding 15 seconds).	A20 is a red event
B	Low Heart Rate event: the duration of low heart rate exceeds the threshold.	/
D	Low SpO ₂ event: the duration of SpO ₂ Desat exceeds the threshold.	/
BD	Low Heart Rate and low SpO ₂ happen at the same time.	/
AB	Apnea and Low Heart Rate happens at the same time.	Red event
AD	Apnea and low SpO ₂ happen at the same time.	Red event
ABD	Apnea, Low Heart Rate, and low SpO ₂ happen at the same time.	Red event

NOTE

- **The monitor records all ABD events for OxyCRG review, but only red events displays in the ABD list of the OxyCRG screen.**

4.6.4 The Display of the ABD Event Area

The ABD event area displays parameter values of currently active OxyCRG events and lists the latest red ABD events.

4.6.5 Setting OxyCRG Parameters

Select parameter trends or compressed waveform to set parameters and the compressed waveform you want to display. The selected parameters will be used for ABD event calculation.

4.6.6 Setting the Threshold of ABD Events

Select any parameter trend or the compressed waveform to perform the following setup:

- Set the threshold of ABD events.
- Set **Event Storage Format**:
 - ◆ **1 min+3 min**: stores data one minute before and three minutes after the event.
 - ◆ **3 min+1 min**: stores data three minutes before and one minute after the event.
 - ◆ **2 min+2 min**: stores data two minutes before and two minutes after the event.

The stored data includes the trends of the OxyCRG parameters, compressed waveform, alarm thresholds, NIBP, and Temp measurements.

4.6.7 Editing ABD Events

To edit ABD events, follow this procedure:

1. Select the **Mark** button to enter the **Mark** dialog box.
2. Drag the event list upwards and downwards to select the desired event.
3. Select the patient's status when the event happened.
4. Select **Save**.

4.7 The Targeted Goal Screen

If you are concerned with specific parameters and their trends, you can use the Targeted Goal screen. The Targeted Goal screen focuses on the target parameter and displays parameter measurements in big numerics. You can easily identify whether parameter target is reached via a dashboard and review the statistics of the target parameter by sections.

The Targeted Goal screen displays parameter measurements and waveforms of ECG, SpO₂, IBP, PI, PR, CO₂, Resp, NIBP, and Temp. You can define the target parameter and secondary parameters. The measurements of these parameters displays in big numerics.

4.7.1 Entering the Targeted Goal Screen

To enter the Targeted Goal screen, choose any of the following ways:

- Select the **Targeted Goal** quick key.
- Select the **Screen Setup** quick key → select the **Choose Screen** tab → select **Targeted Goal**.
- Select the **Main Menu** quick key → from the **Display** column select **Choose Screen** → select **Targeted Goal**.
- If **Patient Category** is set to **Neo**, swipe left or right on the touchscreen with two fingers to switch to the Targeted Goal screen.

4.7.2 The Display of the Targeted Goal Screen

The following figure shows the Targeted Goal screen. Your display may be configured to look slightly different.

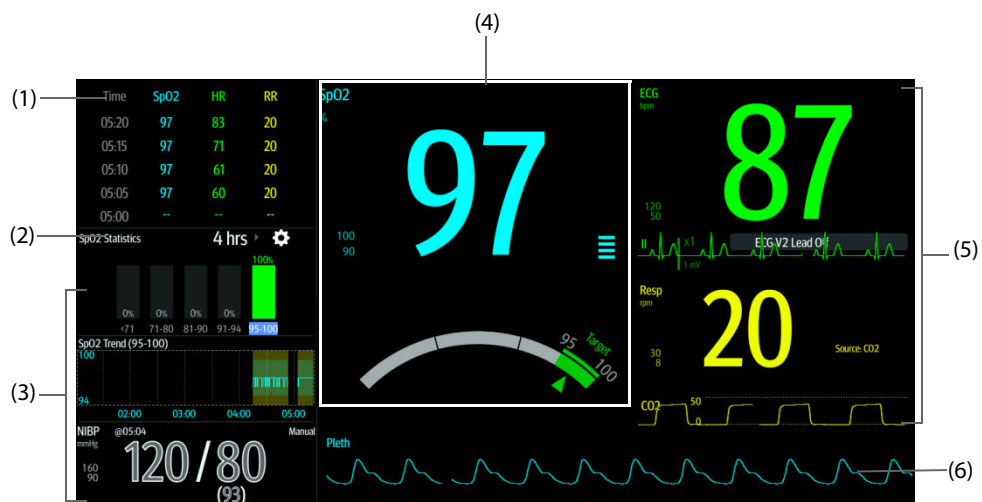

- (1) Parameter trends area: displays trends of the target parameter and secondary parameters. If the target parameter is Art, this area only lists the trend of arterial pressure. Selecting this area enters the **Tabular Trends** review page.
- (2) Target parameter statistics area: displays the statistics of the target parameter by sections.
- (3) Target parameter trends area: displays the graphic trends of the target parameter. If this area is not configured to display the trends of the target area, other selected parameter is displayed.
- (4) Other parameter area: displays parameter measurements and alarm limits of parameters other than the target parameter and secondary parameters.
- (5) Target parameter area: displays the measurement of the target parameter in big numerics, as well as its target range, and alarm limits.
 - If the target parameter is Resp or PR, parameter source is also displayed.
 - The dashboard shows the target range in green.
 - The Δ pointer below the dashboard indicates the current measurement value.
 - Selecting this area enters the corresponding parameter setup menu.
- (6) Secondary parameters area: displays parameter measurement of secondary parameters in big numerics, as well as waveforms and alarm limits. If secondary parameters are Resp and PR, parameter sources are also displayed.

- (7) Target parameter waveform area: displays the waveform of the target parameter.
 - If the target parameter is Resp or PR, the waveform of the source parameter is displayed.
 - If the target parameter is ECG, the fist ECG waveform is displayed by default.

4.7.3 Configuring the Targeted Goal Screen Layout

To configure the parameter numerics, waveforms, and their sequence displayed on the Targeted Goal screen, follow this procedure:

1. Access the Targeted Goal screen in either of the following ways:
 - ◆ Select the **Screen Setup** quick key → select the **Choose Screen** tab → select **Targeted Goal**.
 - ◆ Select the **Main Menu** quick key → from the **Display** column select **Choose Screen** → select Targeted Goal Screen.
2. Select a parameter numeric area or waveform area, and then from the popup list select an element to display in this area. The parameters and waveforms not selected will not be displayed.

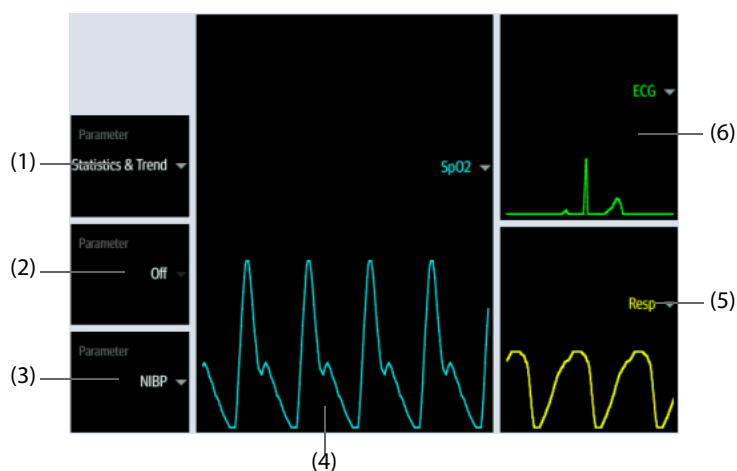

- (1) Select this area to define items to be displayed for the target area:
 - Statistics: this area displays the statistics of the target parameter by sections.
 - Statistics & Trend: this area displays the statistics of the target parameter by sections and the area below displays the graphic trends of the target parameter.
- (2) If the graphic trends of the target parameter is not displayed, select this area to define other parameter to be displayed.
- (3) Select this area to define other parameter (other than the target parameter and the secondary parameter) to be displayed.
- (4) Select this area to define the target parameter.
- (5) Select this area to define the secondary parameter.
- (6) Select this area to define the secondary parameter.

4.7.4 Setting Parameter Statistics

You can show the statistics of the target parameter for a defined period of time. To do so, follow this procedure:

1. Select  from the target parameter statistics area to enter the parameter statistics menu.
2. Select the range of each section: from the **To** column select the SpO2 value at which corresponding section ends.
3. From the **Target** column select the target section. The target section is highlighted in green in the SpO₂ statistics area.
4. From the target parameter statistics area, select the duration to redefine the statistics duration.

The following figure shows the target parameter statistics area when SpO₂ is set as the target parameter:

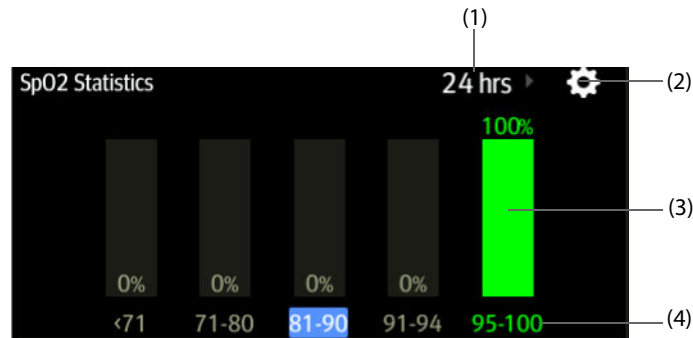

- (1) Statistics duration: select here to change the statistics duration.
- (2) Statistics setup icon: select  to enter the parameter statistics menu.
- (3) Statistics results: the percentage of parameter measurements falling into the corresponding section.
- (4) Sections for statistics: the section in green indicates the target range.

4.7.5 Selecting the Range of Each Parameter Section and the Target Section

For the target parameter, to define the range of each parameter section, follow this procedure:

1. Select  from the target parameter statistics area.
2. From the **To** column select the target parameter value at which corresponding section ends.
3. From the **Target** column select the target section. The target section is highlighted in green in the target parameter statistics area.

4.7.6 Selecting the Statistics Duration of the Target Parameter

The statistics duration of the target parameter is configurable. From the target parameter statistics area, select the duration to redefine its statistics duration.

4.8 Remote View Screen

On your monitor, you can observe alarm conditions and view real time physiological data from patients on other networked monitoring devices.

A device from a remote site is called a remote device or bed, for example, a bedside monitor. You can simultaneously watch up to 12 remote devices. You can also view the realtime screen of one remote device (the main bed) on your monitor.

You can watch the remote devices on the **Remote View** screen or the alarm watch tiles on the main screen.

From the **Remote View** screen you can watch the following information:

- The alarm status and alarm messages of up to 12 remote devices.
- The realtime parameter values and waveforms from the main bed.

NOTE

- **You can also view this monitor from remote devices. This monitor can be viewed by at most 32 remote devices at the same time, in which eight remote devices can watch this monitor's waveforms.**

4.8.1 Entering the Remote View Screen

To enter the **Remote View** screen, choose one of the following ways:

- Select the **Remote View** quick key.
- Select the bed at the alarm watch tile on the main screen. For more information, see 4.8.7.2 *Displaying the Alarm Watch Tile on the Main Screen* for configuring to display the tile on the main screen.

- Select the **Screen Setup** quick key → select the **Choose Screen** tab → select **Remote View**. The **Remote View** screen displays parameter measurements and waveforms of the remote device. The following figure shows the **Remote View** screen.

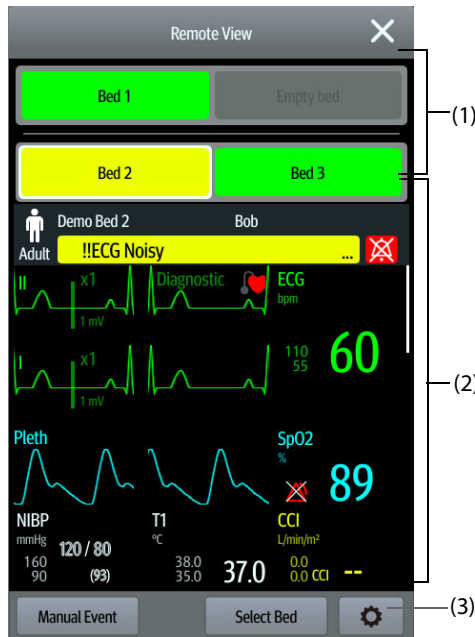

- (1) Alarm watch area
- ◆ Displays the room number and bed number of the remote bed if only one remote device is watched.
 - ◆ Each bed cyclically displays room number, bed number, and alarm of the highest priority if multiple remote beds are watched.
 - ◆ The background color of each bed indicates the status of this bed as follows:

Background Color	Description
Green	No alarm is occurring to the bed.
Red	The remote device is disconnected or a high priority alarm is occurring. The high priority alarm currently is the highest alarm level on the bed. If the remote device is disconnected,  is displayed.
Yellow	The medium priority alarm is occurring. The medium priority alarm currently is the highest alarm level on the bed.
Cyan	The low priority alarm is occurring. The low priority alarm currently is the highest alarm level on the bed.
Grey	The remote device is in the standby mode.
Black	The remote device is powered off.

- (2) Main area: displays the realtime parameters and waveforms from the main bed. Scrolling up and down can view more parameters and waveforms.
- (3) Remote view setup button: select it to enter the **Remote View** setup menu.

4.8.2 Adding a Bed

You need to add the desired remote devices, and then the alarms from these devices can be watched on your monitor. To add a remote device, follow this procedure:

1. Enter the **Select Bed** menu. To do so, choose either of the following ways:
 - ◆ On the **Remote View** screen, select **Select Bed**. For more information, see 4.8.1 *Entering the Remote View Screen* for entering the **Remote View** screen.

- ◆ Select the  icon at the alarm watch tile if the tile is configured to display on the main screen.
- 2. In the **Select Bed** menu, select a desired department. All the beds under this department will be listed. To select beds in the same care group during the shift of care groups in the CMS, select **Select Beds By Care Group**.
- 3. Select a desired tile at the A-W1 or A-W2 areas and then select a bed from the bed list. The selected bed will appear in the alarm watch area and the alarm watch tile if configured.

NOTE

- **The added bed is indicated by a check mark (✓) at the left of the bed list.**
-

4.8.3 Removing a Bed

If you do not want to monitor a remote device any longer, you can remove it. To remove a remote device, follow this procedure:

1. Enter the **Select Bed** menu. Choose either of the following ways:
 - ◆ In the **Remote View** screen, select **Select Bed**. For more information, see *4.8.1 Entering the Remote View Screen* for entering the **Remote View** screen.
 - ◆ Select the  icon in the alarm watch tile if the tile is configured to display on the main screen.
2. In the **Select Bed** menu, select a bed at the A-W1 or A-W2 area, and then select **Clear Bed**. If you want remove all beds, select **Clear All Beds**.

4.8.4 Displaying the Main Bed

To watch the real time monitoring screen of a remote bed, select the bed from the alarm watch area. This bed is called the main bed.

4.8.5 Saving a Manual Event

You can initiate a manual event by selecting **Manual Event** in the **Remote View** screen.

The manual event stores in the event review of the corresponding remote device.

4.8.6 Resetting Alarms for Remote Devices

To reset remote device alarms, from the **Remote View** screen, select **Alarm Reset**.

NOTE

- **You can reset remote device alarms only if the Alarm Reset by Other Bed switch is on at the remote devices. For more information, see *24.3.5.1 Resetting Alarms for Remote Devices*.**
-

4.8.7 Alarm Watch

The alarm watch function provides the alarm notification by color and sound.

- The monitor sounds the highest priority alarm tone from all the monitored remote devices.
- The monitor displays the highest priority alarm in corresponding background color for each bed in the following areas:
 - ◆ At the top of the **Remote View** screen. For more information, see *4.8.1 Entering the Remote View Screen*.
 - ◆ In the Alarm Watch tile on the main screen. For more information, see *4.8.7.1 About Alarm Watch Tile*.

4.8.7.1 About Alarm Watch Tile

The main screen can display up to two alarm watch tiles, namely A-W1 and A-W2. Each tile can accommodate up to six beds.

The following figure shows the alarm watch tiles.

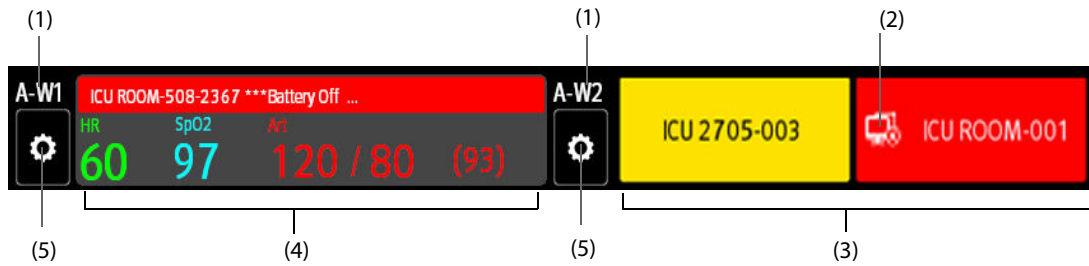

- (1) Alarm watch tile label
- (2) Disconnection icon: this icon displays when the remote device is disconnected and the background color of this tile turns red.
- (3) Bed area (multiple beds): if more than one bed is assigned to an alarm watch tile, each bed cyclically displays the bed number, room number, and the alarm of the highest priority. The background color of each bed indicates the status of that bed.
- (4) Bed area (one bed): if only one bed is assigned to an alarm watch area, this area displays the bed number, room number, parameter value, and alarm message from this bed, etc.
- (5) Bed selection button: select it to enter the **Select Bed** menu.

The alarm watch tile on the main screen is similar to the alarm watch area on the **Remote View** screen. For more information, see 4.8.1 *Entering the Remote View Screen*.

4.8.7.2 Displaying the Alarm Watch Tile on the Main Screen

To configure the alarm watch tile to be displayed on the monitor's main screen, follow this procedure:

1. Select the **Main Menu** quick key → from the **Display** column select **Choose Screen** to enter the **Screen Setup** menu.
2. Select the **Tile Layout** tab.
3. Select the numeric area where you want to display the alarm watch tile, and then in the drop-down list, select **Alarm Watch** → **A-W1** or **A-W2**.

4.8.8 Auto Displaying the New Alarm Bed

The monitor provides the function of automatically displaying the remote alarm bed. If this function is enabled, when a remote bed issues an alarm, the monitor automatically displays this bed as the main bed on the **Remote View** screen.

If multiple remote beds issue alarms, the monitor cyclically displays the alarm beds as per the preset interval and in the order of alarm time.

The auto displaying alarm bed function is disabled by default. To enable this function, follow this procedure:

1. From the **Remote View** screen, select  to enter the **Remote View** setup menu.
2. Switch on **Rollup Alarm Beds**.
3. Set **Rollup Interval**:
 - ◆ **Off**: do not cyclically display the remote alarm beds. Once a new alarm is issued, the monitor automatically switches to the new alarm bed.
 - ◆ **10 sec, 20 sec, or 30 sec**: If multiple remote beds issue alarms, the monitor cyclically displays the alarm beds as per the preset interval and alarm priority in the order of alarm time.
4. Set **Alarm Priority**:

- ◆ **High Only:** Only when a high priority alarm is issued, the monitor automatically switches to the alarm bed.
 - ◆ **High & Med:** If **Rollup Interval** is set to **Off** and when a high priority alarm or medium priority alarm is issued, the monitor automatically switches to the alarm bed. If **Rollup Interval** is set to **10 sec, 20 sec, or 30 sec** and multiple remote beds issue alarms, the monitor cyclically displays the alarm beds with higher priority in the order of alarm time. For example, if both high priority alarms and medium priority alarms are issued, only beds with high priority alarms are cyclically displayed.
5. Set **Switch Bed Prompt Voice**. If this function is enabled, the monitor issues a reminding sound each time the main bed switches.

This page intentionally left blank.

5 Managing Patients

5.1 Starting Monitoring a Patient

After turning on the monitor, follow this procedure to monitor a patient:

1. Admit the patient.
2. Check patient settings. Make sure that alarm limits, patient category and paced status, and so on, are appropriate for the patient. Change them if necessary.
3. Perform desired measurements. For more information, see corresponding measurement chapters.

5.2 Admitting a Patient

The monitor admits a new patient in the following situations:

- After a patient is manually discharged, the monitor automatically admits a new patient.
- After being switched off for the selected time period, the monitor automatically discharges the previous patient and admits a new patient at startup.
- If the monitor has not detected certain patient vital signs (ECG, SpO₂, PR, RR, NIBP) for 30 minutes, it will prompt whether to start monitoring a new patient if any of the above vital signs are detected again.

Always input patient information as soon as the patient is admitted. For more information, see *5.2.2 Editing Patient Information* for details.

WARNING

- **The default Patient Category setting is Adult, and Paced setting is Unspecified. Set Paced and check if the Patient Category setting is correct for the patient.**
 - **For paced patients, set Paced to Yes. If it is incorrectly set to No, the monitor could mistake a pace pulse for a QRS and fail to alarm when the ECG signal is too weak.**
 - **For non-paced patients, set Paced to No.**
-

5.2.1 Entering the Patient Management Dialog

Use any of the following methods to enter the **Patient Management** dialog:

- Select the patient information area at the top left corner of the screen.
- Select **Patient Management** from the **Discharged** screen.
- Select the **Patient Management** quick key.
- Select the **Main Menu** quick key → from the **Patient Management** column select **Patient Management**.

5.2.2 Editing Patient Information

Edit patient information after a patient has been admitted, or when patient information is incomplete, or when it is necessary to change patient information:

To edit patient information, follow this procedure:

1. Enter the **Patient Management** dialog. For more information, see *5.2.1 Entering the Patient Management Dialog*.
2. Edit patient information as required.

If a barcode reader is connected to the monitor, scanning the patient's barcode will enter the patient's information.

NOTE

- **The monitor will reload the configuration if you change the patient category.**
-

5.2.3 Loading Patient Information from the CMS

If the monitor is connected to the central monitoring system (CMS). You can load patient information from the CMS to the monitor. To do so, follow this procedure:

1. Enter the **Find Patient** dialog in either of the following ways:
 - ◆ Select the **Main Menu** quick key → from the **Patient Management** column select **Find Patient**.
 - ◆ From the **Patient Management** dialog select **Find Patient**.
2. Input query criteria.
3. Select **Search**. Then a list pops up, including all the patients that meet the query criteria.
4. Select a patient from the patient list, and then select **Admit**. Corresponding patient information in the monitor will be updated.

Patients that can be searched for are configurable based on location. For more information, see *24.2.2 Setting the Range of Finding a Patient*.

NOTE

- **If a monitor with system software version before V01.28.00.01 is connected to the CMS with system software version V05.01.00.01 and above, you cannot search patients from the CMS.**
 - **If ADT Query is switched on, input query criteria from the Discharged Patients page.**
-

5.2.4 Loading Patient Information from the ADT Server

If the monitor is connected with the Admit-Discharge-Transfer (ADT) server through the eGateway. You can load patient information from ADT server to the monitor.

To do so, follow this procedure:

1. Enter the **Find Patient** dialog in either of the following ways:
 - ◆ Select the **Main Menu** quick key → from the **Patient Management** column select **Find Patient**.
 - ◆ Select **Find Patient** from the **Patient Management** dialog.
2. Input query criteria.
3. Select **Search**. Then a list pops up, including all the patients that meet the query criteria.
4. Select a patient from the patient list, and then select **Admit**. Corresponding patient information in the monitor will be updated.

Where you can search for a patient is configurable. For more information, see *24.2.2 Setting the Range of Finding a Patient*.

NOTE

- **You can load patient information from the ADT server only when ADT Query is enabled. For more information, see *24.12.11 Using the ADT Gateway*.**
 - **The monitor can automatically upload the patient information from the ADT server when:**
 - ◆ The configured keywords of the monitor and the eGateway are the same.
 - ◆ The IP address of the monitor is added to the eGateway configuration dialog.
 - **Loading patient information from the ADT server updates only patient information in the monitor. The patient's monitoring data is not changed and the patient is not discharged.**
-

5.3 Exporting Patient Data

You can export the demographic information and monitoring data of the current and discharged patients via a USB drive. For more information, see *24.6.3 Exporting Patient Data*.

5.4 Deleting Patient Data

To delete the data of discharged patients, follow this procedure:

1. Access the **Discharged Patients** dialog box by either of the following ways:
 - ◆ Select the **Discharged Patients** quick key.
 - ◆ Select the **Main Menu** quick key → from the **Patient Management** column select **Discharged Patients**.
2. From the patient list select desired patients.
3. Select **Delete**.

5.5 Stopping a Parameter Measurement

To stop monitoring a parameter, follow this procedure:

1. Remove corresponding sensor from the patient.
2. Disconnect the sensor from the patient cable.
3. Disconnect the patient cable from the parameter module.

5.6 Discharging a Patient

Before monitoring a new patient, discharge the previous patient. The technical alarms are reset, and monitor settings return to their defaults. For more information, see *23.3 Setting Default Patient Category*.

After a patient is discharged, the monitor automatically admits a new patient.

WARNING

- **Always discharge the previous patient before starting to monitor a new patient. Failure to do so can lead to data being associated with the wrong patient.**
-

To manually discharge a patient, use any of the following methods to access the **Discharge Patient** dialog:

- Swipe down the touchscreen with two fingers.
- Select the **Discharge Patient** quick key.
- Select the patient information area at the top left corner of the screen → **Discharge Patient**.
- Select the **Patient Management** quick key → **Discharge Patient**.
- Select the **Main Menu** quick key → from the **Patient Management** column select **Discharge**.

Select a button in the **Discharge Patient** dialog:

- **Print End Case Report:** prints the end case report when the patient is discharged.
- **Discharge:** clears the waveform data of the current patient. The monitor loads the default configuration and goes to the standby mode. The current patient becomes a discharged patient.
- **Clear Patient Data:** discharges the current patient and clears the waveform data. The monitor loads the default configuration and does not go to the standby mode. The current patient becomes a discharged patient.

This page intentionally left blank.

6 Interfacing with External Devices

6.1 Introduction to Interfacing with External Devices

External devices, including Draeger Apollo Anesthesia Machine, Masimo Rainbow SET Intellivue Module Pulse CO-Oximeter, Hamilton G5 Ventilator, Radiometer TCM4 Gas Monitor, TOF-Watch SX NMT Monitor, B Braun Perfusor Space Infusion Pump, can be connected to the monitor through the multifunctional connector. Information (patient data, alarms, etc.) from external devices can be displayed, saved, recorded, or printed through the monitor. If the monitor is connected with the CMS or eGateway, information from external devices can also be transmitted to the CMS or eGateway.

6.2 Interfacing Safety Information

WARNING

- **The parameter labels used on the patient monitor may be different from those used on the external device.**
- **The alarms from external devices may be delayed before transmission to the patient monitor.**
- **There can be differences between the alarm messages and alarm priorities displayed on the monitors and those displayed on the connected external devices.**

NOTE

- **The alarm messages from external devices are derived from the open protocol of the corresponding external device. For more information about these alarms, please see the operator's manual for the corresponding devices.**

6.3 Differences in Displayed Values

In certain cases, there may be differences between the numerics displayed on the monitor and those on external devices. The table below lists some situations and possible reasons.

Situation	Possible Reasons
Some parameter values are displayed as invalid values on the monitor.	The patient monitor and the external device may have different parameter configuration or displaying range of values. If the patient monitor displays a parameter not configured in the external device, or a parameter value from the external device exceeds the displaying range of the monitor, then the corresponding parameter value is displayed on the monitor as an invalid value.
The monitor and external device display parameter values with different numbers of places of decimals.	The monitor displays parameter values from the external device based on the monitor displaying rules. Same parameter value is displayed differently when the monitor and the external device display numbers with different precision.
Non-continuously measured values and continuously measured values have the same displaying mode in the patient monitor.	For non-continuously measured values, the monitor displays the latest measured values until a new measurement is transmitted by the external device.
Parameter values displayed on the patient monitor and those displayed in the external device are slightly different.	Some parameter values are converted to different units when transmitted to the monitor. Sometimes, values from the external device may be delayed before transmission to the patient monitor.

NOTE

- When the pressure units are converted among cmH₂O, hPa and mbar, the parameter values remain unchanged, for example, 1cmH₂O=1hPa=1mbar, which may differ from some external devices.

6.4 Connecting an External Device

To connect an external device, follow this procedure:

1. Connect one end of the serial port cable with the multifunctional connector of the monitor.
2. Connect the other end of the serial port cable with an external device.
3. Switch on the external device.

CAUTION

- First installation and debugging should be executed by Mindray service personnel or authorized technician.

6.5 Accessing the Integrated Devices Screen

You can view the information of external devices in the **Integrated Devices** screen of the monitor. The **Integrated Devices** screen provides information of both individual device and multi devices. To access the **Integrated Devices** screen, follow this procedure:

- Select the **Integrated Devices** quick key.
- Select the **Screen Setup** quick key → select **Integrated Devices**.
- Select the **Main Menu** quick key → from the **Display** column select **Choose Screen** →select **Integrated Devices**.
- Select the numeric area or waveform area of any parameter from the external device →select **Integrated Devices** button.

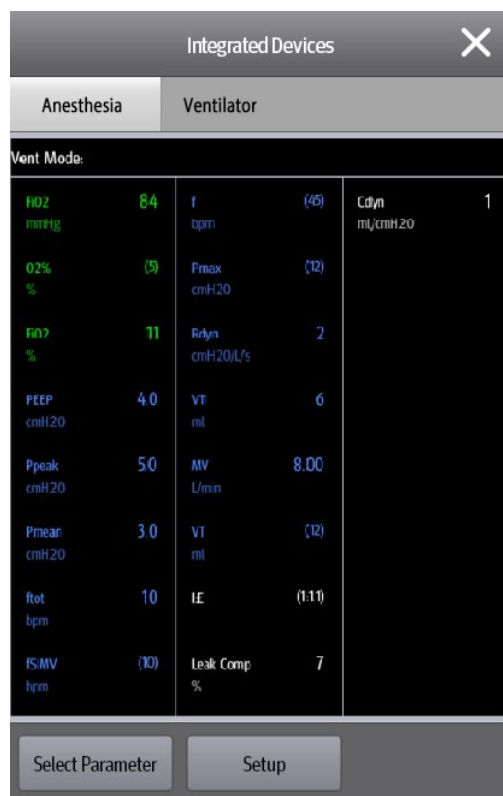

Anesthesia		Ventilator			
Vent Mode:					
FIO2 mmHg	8.4	f rpm	(45)	Cdyn ml/cmH2O	1
O2% %	(5)	Pmax cmH2O	(12)		
FIO2 %	11	Rides cmH2O/L/s	2		
PEEP cmH2O	4.0	VT ml	6		
Ppeak cmH2O	5.0	MV L/min	8.00		
Pmean cmH2O	3.0	VT ml	(12)		
ftot bpm	10	IE (111)			
fSIMV bpm	(10)	Leak Comp %	7		

The **Integrated Devices** screen has the following features:

- For the parameters measured by the external device, the measurements display directly after the parameter labels.
- For the parameters input on the external device, the settings are enclosed in parenthesis after parameter labels.
- For the measured parameters and input parameters that have the same label, parameter measurements and settings are displayed after parameter labels with the settings are also enclosed in parenthesis. For example, PEEP 18 (20), in which PEEP is parameter label, 18 is the measurement, and (20) is the setting.

NOTE

- **Parameters in the Integrated Devices screen are displayed in the order as shown in the selection dialog. If the screen cannot display all the selected parameters, the parameter with higher positions (from top to bottom and from left to right) in the Select Parameter dialogue are displayed.**

6.5.1 Setting Parameters from External Devices for Display

To select parameters displayed in the **Integrated Devices** screen, follow this procedure:

1. From the **Integrated Devices** screen select **Select Parameter**.
2. Select desired parameters.

6.5.2 Setting Alarms from External Devices

To enable or disable the storage, display, and sound of the external device alarms of a certain priority and category, follow this procedure:

1. From the **Integrated Devices** screen select **Setup**.
2. Set switches as desired.

If the storage, display, or audio settings of a specific alarm are different from its category or priority, set them individually by adding the Alarm ID to the alarm list. To do so, follow this procedure:

1. From the **Integrated Devices** screen select **Setup**.
2. Input the Alarm ID for this alarm, and select **Add**.

To delete a specific external device alarm, select the desired Alarm ID, and select **Delete**.

6.6 Displaying Data from External Devices on the Main Screen

This monitor can display data from external devices on the main screen:

- Display waveforms from external devices in the waveform area.
- Display labels and measurements of parameters from external devices in the numeric area.
- If an anesthesia system is connected, display its set parameters (+Anes set) in the numeric area

To display data from external devices on the main screen, follow this procedure:

1. Access **Tile Layout** in either of the following ways:
 - ◆ Select the **Screen Setup** quick key → select the **Tile Layout** tab.
 - ◆ Select the **Main Menu** quick key → from the **Display** column select **Tile Layout**.
2. Select a parameter numeric area or waveform area, and then from the popup list select the external device element you want to display in this area.

NOTE

- **When displayed in the monitor main screen, parameter labels of external devices are prefixed with the plug sign "+". For example, if SpO₂ is from an external device, its label is displayed as "+SpO₂", and its waveform label is displayed as "+Pleth".**
- **If a parameter can be obtained either from the monitor or an external device, the measured value, waveform or loops coming from the monitor will be displayed preferentially.**

6.6.1 Setting Waveform Properties for Parameters from External Devices

To set the waveform properties for parameters from external devices, follow this procedure:

1. Access the parameter setup dialog by selecting its waveform area or numeric area.
2. Set **Speed** or **Scale**.

6.6.2 Selecting Measured Parameters from the Anesthesia System for Display

On the main screen, the numeric area of some parameters from an external device, for example the +Paw parameter, can display multiple parameters. To select parameters for display, follow this procedure:

1. On the main screen select the numeric area of the parameter from the anesthesia system.
2. Select the **Select Parameter** tab.
3. Follow the on-screen instruction to select parameters for display.

6.6.3 Setting Units for Parameters from External Devices

To set units for parameters from external devices, follow this procedure:

1. Select the numeric area or waveform area of any parameter from the external device.
2. Select the **Unit** tab.
3. Set the unit for **O2**, **CO2**, **Pressure** or **Temp**.

6.7 Viewing Alarms from External Devices

If the patient monitor is configured to do so, the monitor displays alarms from external devices in the physiological and technical alarm information areas. A plus sign "+" is added before each alarm message from external devices.

6.8 Viewing Parameter Trends from External Devices

If the patient monitor is configured to do so, the monitor saves parameters trends and alarm events from external devices. You can review these data in the **Tabular Trends**, **Graphic Trends**, **Events** and **Full Disclosure** pages in the **Review** screen. The monitor adds a "+" before the parameter label of external devices.

For more information, see *17 Review*.

NOTE

- **Parameters from external devices are saved and displayed according to the time on the monitor.**
-

6.9 Recording and Printing Parameter Trends from External Devices

You can record or print parameter trends from external devices. For more information, see *17 Review*, *20 Recording*, and *21 Printing*.

7 Alarms

7.1 Alarm Introduction

This chapter describes alarm functions and alarm settings.

7.2 Alarm Safety Information

WARNING

- **A potential hazard can exist if different alarm presets and default configuration settings are used for the same or similar equipment in the same care area, for example an intensive care unit or cardiac operating room.**
 - **If the monitor is connected to the central monitoring system (CMS) or other monitors, alarms can be presented and controlled remotely. Remote suspension, inhibition, or reset of monitor alarms via the CMS or other monitors may cause a potential hazard. For more information, see the operator's manuals for the CMS and the other monitors.**
 - **The monitors in the care area may each have different alarm settings to suit different patients. Always check that the alarm settings are appropriate for the patient before starting the monitoring. Always make sure that necessary alarm limits are active and set according to the patient's clinical condition.**
 - **Setting alarm limits to extreme values may cause the alarm system to become ineffective. For example, setting the SpO₂ high alarm limit to 100%, is equivalent to switching the alarm off.**
 - **When the alarm sound is switched off, the monitor gives no alarm tones even if a new alarm occurs. Be careful when considering to switch off the alarm sound. When the alarms are off or while alarm audio is paused either temporarily or indefinitely, observe the patient frequently.**
 - **When monitoring patients that are not continuously attended by a clinical operator, properly configure the alarm system and adjust alarm settings as per the patient's condition.**
 - **Do not rely exclusively on the audible alarm system for monitoring. Adjustment of alarm volume to a low level may result in a hazard to the patient.**
-

7.3 Understanding the Alarms

7.3.1 Alarm Categories

The monitor has two different types of alarms: physiological alarms and technical alarms.

- Physiological alarms are triggered by patient measurement exceeding the parameter limits, or by an abnormal patient conditions.
- Technical alarms are triggered by an electrical, mechanical, connectivity, or other monitor abnormal operation, or by failure of a sensor or component. Technical alarm conditions may also be caused when an algorithm cannot classify or interpret the available data.

Apart from the physiological and technical alarms, the monitor can also prompt with some messages describing the system status or patient status.

7.3.2 Alarm Priorities

By severity, the alarms are classified into the following priority levels:

- High priority alarms: indicate a life threatening situation or a severe device malfunction. High priority alarms require an immediate response.
- Medium priority alarms: indicate abnormal vital signs or a device malfunction. Medium priority alarms require a timely response.

- Low priority alarms: indicate a discomfort condition, a device malfunction, or an improper operation. Low priority alarms require you to be aware of this condition.
- Messages: provides additional information on the patient or the equipment.

7.3.3 Alarm Indicators

When an alarm occurs, the monitor indicates it through visual or audible alarm indications. For more information, see the following table.





Alarm Indicator		High Priority Alarm	Medium Priority Alarm	Low Priority Alarm	Message	Comments
Alarm lamp		Red Flashing frequency: 1.4 - 2.8 Hz Duty cycle: 20 - 60% on	Yellow Flashing frequency: 0.4 - 0.8 Hz Duty cycle: 20 - 60% on	Cyan No flashing Duty cycle: 100% on	None	None
Audible tone pattern	ISO	Repeat pattern of triple + double + triple + double beeps	Repeat pattern of triple beeps	Repeat pattern of single beep	None	None
	ISO3	Repeat pattern of triple + double + triple + double beeps	Repeat pattern of triple beeps	Repeat pattern of double beeps	None	
Alarm message		White text inside a red box	Black text inside a yellow box	Black text inside a cyan box	White text	Alarm messages are displayed in the alarm information area at the top of the screen. You can select the alarm messages to show the alarm list.
Alarm priority indicator		!!!	!!	!	None	The indicator appears in front of the corresponding alarm message.
Parameter value		White text inside a flashing red box	Black text inside a flashing yellow box	Black text inside a flashing cyan box	None	None

NOTE

- **When multiple alarms of different priority levels occur simultaneously, the monitor selects the highest priority alarm to light the alarm lamp and issue the alarm tone.**
- **When multiple alarms of different priority levels occur simultaneously and should be displayed in the same area, the monitor only displays the messages from the highest priority alarm.**
- **When multiple alarms of the same priority levels occur simultaneously alarm messages are displayed cyclically.**
- **Some physiological alarms, such as Asystole, are exclusive. They have identical alarm tones and alarm lights with normal high level physiological alarms, but their alarm messages are displayed exclusively. That is, when an exclusive physiological alarm and a normal high level physiological alarm are triggered simultaneously, only exclusive physiological alarm message will be displayed.**

7.3.4 Alarm Status Symbols

Apart from the alarm indicators as described in 7.3.3 *Alarm Indicators*, the monitor uses the following symbols to indicate the alarm status:

-  Alarm pause: indicates that all the alarms are paused.
-  Alarm off: indicates that individual measurement alarms are turned off or the system is in the alarm off status.
-  Audio pause: indicates that audible alarm tones are paused.
-  Audio off: indicates that audible alarm tones are turned off.
-  Alarm reset: indicates that the alarm system is reset.

7.3.5 Highlighted Display of Alarm Messages

When any of the following alarms is triggered, alarm messages are highlighted to indicate that the patient may be in a critical condition.

- Arrhythmia alarms, including Asystole, V-Fib/V-Tach, V-Tach, Vent Brady, Extreme Tachy, and Extreme Brady.
- SpO2 Desat
- Apnea

When an alarm is highlighted, the alarm message covers both the physiological alarm area and the technical alarm area with enlarged word size. Messages of technical alarms and other physiological alarms are displayed at the left of the highlighted alarm.

7.4 Alarm Limits

When a parameter measurement exceeds the alarm limit, the monitor generates an alarm according to the alarm priority setting.

7.4.1 Guard Limit

The monitor provides guard limits for HR, Sp₂, RR, NIBP, IBP, Temp, CO₂, and some arrhythmia thresholds to prevent alarm limits from being set too high or too low. Setting guard limits is password protected.

For more information on setting guard limits, see 24.3.4 *Setting Guard Limits*.

7.4.2 Auto Alarm Limits

The monitor can automatically calculate alarm limits based on the latest measured values. Before applying automatically created alarm limits, confirm if they are appropriate for the patient. If not, you can adjust them manually. These alarm limits remain unchanged until you select auto limits again or adjust them manually.

The monitor calculates auto limits based on the following rules

Module	Parameter	Patient Category	Lower Limit	Upper Limit	Auto Limit Range
ECG	HR/PR (bpm)	Adult	HR × 0.8 or 40, or guard limit (whichever is greater, no greater than 70)	HR × 1.25 or 240, or guard limit (whichever is smaller, no less than 100)	35 to 240
		Pediatric	HR × 0.8 or 40, or guard limit (whichever is greater, no greater than 80)	HR × 1.25 or 240, or guard limit (whichever is smaller, no less than 120)	35 to 240
		Neonate	(HR - 30) or 90 (whichever is greater, no greater than 100)	(HR + 40) or 200 (whichever is smaller, no less than 160)	5 to 225

Module	Parameter	Patient Category	Lower Limit	Upper Limit	Auto Limit Range
Resp	RR (rpm)	Adult/ Pediatric	$RR \times 0.5$ or 6 (whichever is greater, no greater than 12)	$(RR \times 1.5)$ or 30, or guard limit (whichever is smaller, no less than 20)	6 to 55
		Neonate	$(RR - 10)$ or 30 (whichever is greater)	$(RR + 25)$ or 85 or guard limit (whichever is smaller, no less than 70)	10 to 90
SpO ₂	SpO ₂ (%)	All	Same as the default alarm limit	Same as the default alarm limit	Same as the measurement range
NIBP	NIBP-S (mmHg)	Adult	$(SYS \times 0.68 + 10)$ or guard limit (whichever is greater, no greater than 110)	$(SYS \times 0.86 + 38)$, or guard limit (whichever is smaller, no less than 140)	45 to 270
		Pediatric	$(SYS \times 0.68 + 10)$ or guard limit (whichever is greater, no greater than 90)	$(SYS \times 0.86 + 38)$, or guard limit (whichever is smaller, no less than 100)	45 to 185
		Neonate	$(SYS - 15)$ or 45 (whichever is greater, no greater than 60)	$(SYS + 15)$ or 105 (whichever is smaller, no less than 80)	35 to 115
	NIBP-D (mmHg)	Adult	$(Dia \times 0.68 + 6)$ or guard limit (whichever is greater, no greater than 60)	$(Dia \times 0.86 + 32)$, or guard limit (whichever is smaller, no less than 80)	25 to 225
		Pediatric	$(Dia \times 0.68 + 6)$ or guard limit (whichever is greater, no greater than 50)	$(Dia \times 0.86 + 32)$, or guard limit (whichever is smaller, no less than 60)	25 to 150
		Neonate	$(Dia - 15)$ or 20 (whichever is greater, no greater than 30)	$(Dia + 15)$ or 80 (whichever is smaller, no less than 50)	20 to 90
	NIBP-M (mmHg)	Adult	$(Mean \times 0.68 + 8)$ or guard limit (whichever is greater, no greater than 80)	$(Mean \times 0.86 + 35)$, or guard limit (whichever is smaller, no less than 100)	30 to 245
		Pediatric	$(Mean \times 0.68 + 8)$ or guard limit (whichever is greater, no greater than 60)	$(Mean \times 0.86 + 35)$, or guard limit (whichever is smaller, no less than 80)	30 to 180
		Neonate	$(Mean - 15)$ or 35 (whichever is greater, no greater than 40)	$(Mean + 15)$ or 95 (whichever is smaller, no less than 60)	25 to 105
Temp (xx refers to temperature site)	Txx (°C)	All	$(Txx - 0.5)$	$(Txx + 0.5)$	1 to 49
	ΔT (°C)	All	Same as the default alarm limit	Same as the default alarm limit	Same as the measurement range

Module	Parameter	Patient Category	Lower Limit	Upper Limit	Auto Limit Range
IBP: ART/ Ao/UAP/ BAP/FAP/ LV/P1-P4 (Arterial pressure)	IBP-S (mmHg)	Adult	$SYS \times 0.68 + 10$ or guard limit (whichever is greater, no greater than 110)	$SYS \times 0.86 + 38$ or guard limit (whichever is smaller, no less than 140)	45 to 270
		Pediatric	$SYS \times 0.68 + 10$ or guard limit (whichever is greater, no greater than 90)	$SYS \times 0.86 + 38$ or guard limit (whichever is smaller, no less than 100)	45 to 185
		Neonate	$(SYS - 15)$ or 45 (whichever is greater, no greater than 60)	$(SYS + 15)$ or 105 (whichever is smaller, no less than 80)	35 to 115
	IBP-D (mmHg)	Adult	$(Dia \times 0.68 + 6)$ or guard limit (whichever is greater, no greater than 60)	$(Dia \times 0.86 + 32)$ or guard limit (whichever is smaller, no less than 80)	25 to 225
		Pediatric	$(Dia \times 0.68 + 6)$ or guard limit (whichever is greater, no greater than 50)	$(Dia \times 0.86 + 32)$ or guard limit (whichever is smaller, no less than 60)	25 to 150
		Neonate	$(Dia - 15)$ or 20 (whichever is greater, no greater than 30)	$(Dia + 15)$ or 80 (whichever is smaller, no less than 50)	20 to 90
	IBP-M (mmHg)	Adult	$Mean \times 0.68 + 8$ or guard limit (whichever is greater, no greater than 80)	$Mean \times 0.86 + 35$ or guard limit (whichever is smaller, no less than 100)	30 to 245
		Pediatric	$Mean \times 0.68 + 8$ or guard limit (whichever is greater, no greater than 60)	$Mean \times 0.86 + 35$ or guard limit (whichever is smaller, no less than 80)	30 to 180
		Neonate	$(Mean - 15)$ or 35 (whichever is greater, no greater than 40)	$(Mean + 15)$ or 95 (whichever is smaller, no less than 60)	25 to 105
IBP: PA	PA-S (mmHg)	All	$SYS \times 0.75$, no less than guard limit and no greater than 15	$SYS \times 1.25$, no greater than guard limit and no less than 25	3 to 120
	PA-M (mmHg)	All	$Mean \times 0.75$, no less than guard limit and no greater than 5	$Mean \times 1.25$, no greater than guard limit and no less than 10	3 to 120
	PA-D (mmHg)	All	$Dia \times 0.75$, no less than guard limit and no greater than 5	$Dia \times 1.25$, no greater than guard limit and no less than 6	3 to 120
IBP: CVP, LAP, RAP, UVP, P1-P4 (venous pressure)	IBP-M (mmHg)	All	$Mean \times 0.75$, no less than guard limit and no greater than 5	$Mean \times 1.25$, no greater than guard limit and no less than 10	3 to 40
IBP: CPP	CPP-M (mmHg)	Adult	$CPP \times 0.68 + 8$, no less than 60	$CPP \times 0.86 + 35$, no greater than 90	20 to 235
		Pediatric	$CPP \times 0.68 + 8$, no less than 50	$CPP \times 0.86 + 35$, no greater than 70	25 to 175
		Neonate	$(CPP - 15)$ or 35, (whichever is greater, no less than 40)	$(CPP + 15)$ or 95, (whichever is smaller, no greater than 70)	25 to 100
CO ₂	EtCO ₂ (mmHg)	All	0 to 32: remains the same 33 to 35: 29 36 to 45: (EtCO ₂ - 6) 46 to 48: 39 >48: remains the same	0 to 32: remains the same 33 to 35: 41 36 to 45: (EtCO ₂ + 6) 46 to 48: 51 >48: remains the same	Same as the measurement range
	FiCO ₂	All	None	Same as the default alarm limit	Same as the measurement range
	awRR (rpm)	Adult/ Pediatric	$awRR \times 0.5$ or 6 (whichever is greater)	$awRR \times 1.5$ or 30 (whichever is smaller)	6 to 55
		Neonate	$(awRR - 10)$ or 30 (whichever is greater)	$(awRR + 25)$ or 85 rpm (whichever is smaller)	10 to 90

Module	Parameter	Patient Category	Lower Limit	Upper Limit	Auto Limit Range
AG	EtCO ₂	All	Same as the CO ₂ module		
	FiCO ₂	All	Same as the CO ₂ module		
	awRR (rpm)	Adult/ Pediatric	awRR × 0.5 or 6 (whichever is greater)	awRR × 1.5 or 30 (whichever is smaller)	6 to 55
		Neonate	(awRR - 10) or 30 (whichever is greater)	(awRR+25) or 85 rpm (whichever is smaller)	10 to 90
	FiAA/EtAA	All	Same as the default alarm limit	Same as the default alarm limit	Same as the measurement range
	FiO ₂ /EtCO ₂	All	Same as the default alarm limit	Same as the default alarm limit	Same as the measurement range
FiN ₂ O/ EtN ₂ O	All	Same as the default alarm limit	Same as the default alarm limit	Same as the measurement range	
C.O.	TB (°C)	Adult	TB - 1)	TB + 1	Same as the measurement range

7.4.3 Initiating Auto Alarm Limits

The monitor provides the auto alarm limits function to automatically adjust alarm limits according to the patient's vital signs. When auto limits are selected, the monitor calculates safe auto limits based on the latest measured values. To get accurate auto alarm limits, collect a set of measured vital signs as a baseline.

To initiate auto alarm limits, follow this procedure:

1. Access the **Limits** page in either of the following ways:
 - ◆ Select the **Alarm Setup** quick key.
 - ◆ Select the **Main Menu** quick key → from the **Alarm** column select **Limits**.
2. From the **Limits** page, select **Auto Limits** at the left bottom.
3. Select **OK** from the popup dialog box.

7.5 Accessing On-screen Help for Technical Alarms (AlarmSight)

In the technical alarm list, alarm messages followed by **Detail** include help messages or pictures to help you identify the problem. This function is called AlarmSight. To access AlarmSight, follow this procedure:

1. Select an alarm displaying in the technical alarm information area to enter the **Alarms** dialog.
2. From the alarm list select the desired alarm.

NOTE

- **If there are no displayed alarms, then selecting the technical alarm area will not open any dialogs.**

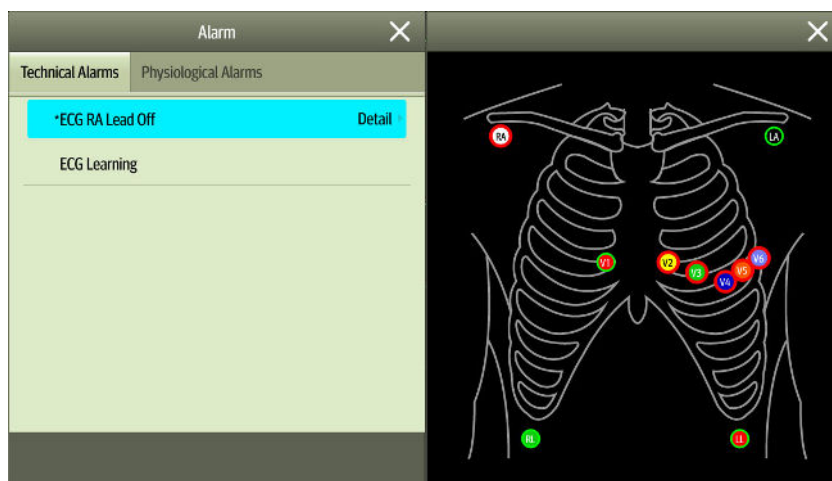

7.6 Checking the Physiological Alarms List

If the patient monitor has more than one physiological alarm, you can see the physiological alarm list by selecting the physiological alarm information area to enter the **Alarms** dialog. If there is only one physiological alarm, selecting the physiological alarm information area enters the **Review** dialog for the event created by this alarm.

7.7 Changing Alarm Settings

Alarms settings can be changed by selecting Main Menu and choosing from the list in the Alarm column.

7.7.1 Setting Parameter Alarm Properties

To set parameter alarm properties, follow this procedure:

1. Access the **Limits** page in either of the following ways:
 - ◆ Select the **Alarm Setup** quick key.
 - ◆ Select the **Main Menu** quick key → from the **Alarm** column select **Limits**.
2. Select a parameter tab and set alarm properties as desired. Enter the password if required. For more information, see 24.13.3 *Selecting Password for User Authentication*.

You can also change the alarm properties of individual parameter from the corresponding parameter dialog.

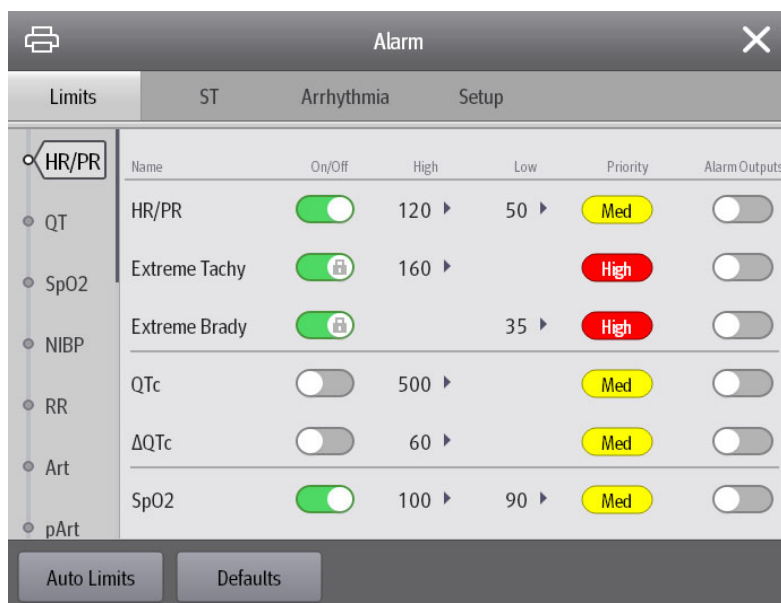

NOTE

- **The monitor can be configured to require a password or login to change alarm settings. For more information, refer to 24.13.3 Selecting Password for User Authentication.**
-

7.7.2 Changing the Alarm Volume

To change the alarm volume, follow this procedure:

1. Access the **Setup** page in either of the following ways:
 - ◆ Select the **Alarm Setup** quick key → select the **Setup** tab.
 - ◆ Select the **Main Menu** quick key → from the **Alarm** column select **Setup**.
2. Set **Alarm Volume**. The alarm volume can be set from X to 10, in which X is the minimum volume allowed by your department, and 10 is the maximum volume.
3. Select **High Alarm Volume** to set the volume of the high priority alarm.
4. Select **Reminder Volume** to set the volume of the reminder tone.

NOTE

- **Alarm volume can only be set to 0 if the monitor is connected to a CMS System.**
 - **When the alarm volume is set to 0, the alarm sound is turned off and the audio off symbol appears on the screen.**
 - **You can set the Alarm Volume to 0 only when your monitor is connected to the CMS. If your monitor is not connected to the CMS, the lowest setting of Alarm Volume is 1.**
 - **When the monitor is connected to the CMS and Alarm Volume is set to 0, Alarm Volume automatically changes to 2 if the CMS is disconnected.**
 - **You cannot set the volume of high priority alarms if Alarm Volume is set to 0.**
-

7.7.3 Setting the Apnea Delay Time

To set the apnea delay time, follow this procedure:

1. Access the **Setup** page in either of the following ways:
 - ◆ Select the **Alarm Setup** quick key → select the **Setup** tab.
 - ◆ Select the **Main Menu** quick key → from the **Alarm** column select **Setup**.
2. Select **Apnea Delay** to set the apnea delay time.

7.7.4 Switching On or Off V-Tach Latching

When **V-Tach Latching Lock** is switched on, you can switch on or off **V-Tach Latching**. To do so, follow this procedure:

1. Access the **Setup** page in either of the following ways in either of the following ways:
 - ◆ Select the **Alarm Setup** quick key → select the **Setup** tab.
 - ◆ Select the **Main Menu** quick key → from the **Alarm** column select **Setup**.
2. Switching on or off **V-Tach Latching**.

7.7.5 Restoring the Default Alarm Settings

To reset all alarm settings to the defaults, follow this procedure:

1. Access the **Alarm** page in either of the following ways:
 - ◆ Select the **Alarm Setup** quick key.
 - ◆ Select the **Main Menu** quick key → from the **Alarm** column select **Limits**.
2. On the **Limits** page, select **Defaults** at the bottom.

7.7.6 Setting the Length of Printed Waveforms

You can define the length of printed waveforms when an alarm is triggered. To do so, follow this procedure:

1. Access the **Setup** page in either of the following ways:
 - ◆ Select the **Alarm Setup** quick key → select the **Setup** tab.
 - ◆ Select the **Main Menu** quick key → from the **Alarm** column select **Setup**.
2. Set **Printing Duration On Alarm**.

7.8 Pausing Alarms/Pausing Alarm Tones

You can either pause alarms or pause alarm tones. This depends on the pause setting. To set the pause function, refer to *24.3.2.1 Defining the Pause Function*.

7.8.1 Pausing Alarms

If the Pause function is configured to alarm pause, pressing the **Alarm Pause** quick key can temporarily disable alarm indicators. For the configuration of the pause function, see *24.3.2.1 Defining the Pause Function*. When alarms are paused, the following rules are followed:

- No physiological alarm will be presented.
- Except battery-related technical alarms, sounds of the other technical alarms are paused, but alarm lamps and alarm messages continue to be presented.
- The remaining alarm pause time is displayed in the physiological alarm information area.
- The alarm pause symbol is displayed in the system information area.

When the alarm pause time expires, the alarm paused state is automatically deactivated. You can also cancel the alarm paused state by pressing the **Alarm Pause** quick key again.

7.8.1.1 Prolonging the Alarm Pause Time

If enabled, you can temporarily prolong the alarm pause time after the monitor enters the alarm paused state. This capability is disabled by default. To prolong the alarm pause time, follow this procedure:

1. In the physiological alarm information area, select the alarm pause countdown.
2. Select **Pause 5 min**, **Pause 10 min**, or **Pause 15 min**.

NOTE

- **Prolonging alarm pause time does not affect the setting of alarm pause time.**

7.8.1.2 Switching Off All Alarms

If **Pause Time** is set to **Permanent** (see section *24.3.2.2 Setting the Alarm Pause Time/Alarm Tone Pause Time*), pressing the **Alarm Pause** quick key permanently switches off all alarms. The alarm off state has the following features:

- Physiological alarms are switched off. The alarm lamp does not flash and alarm sound is not issued.
- Alarm sound of technical alarms is switched off, but alarm lamp flashes and alarm messages are presented.
- The message **Alarm Off** with red background is displayed in the physiological alarm information area.
- The alarm off symbol is displayed in the system status information area.

To exit the alarm off state, press the **Alarm Pause** quick key again.

WARNING

- **Pausing or switching off alarms may result in a hazard to the patient.**

7.8.2 Pausing Alarm Sound

If the Pause function is configured to Audio Pause, pressing the **Audio Pause** quick key pauses alarm tone and sets the quick key to be highlighted. For the configuration of the pause function, see section 24.3.2.1 *Defining the Pause Function*. When alarm tones are paused, the following rules are followed:

- The sound of all physiological alarms and technical alarms are switched off.
- The remaining audio pause time is displayed in the physiological alarm information area.
- The audio pause symbol is displayed in the system information area.

When the audio pause time expires, the audio paused state is automatically deactivated. You can also cancel the audio paused state by pressing the highlighted **Audio Pause** quick key.

7.8.2.1 Prolonging the Alarm Tone Pause Time

If enabled on the machine, you can temporarily prolong the alarm tone pause time after the monitor enters the alarm tone paused state. This capability is disable by default. To prolong the audio pause time, follow this procedure:

1. In the physiological alarm information area, select the alarm pause countdown.
2. Select the alarm tone pause time. Options may include **Pause 5 min**, **Pause 10 min**, or **Pause 15 min**.

NOTE

- **Prolonging alarm pause time does not affect the setting of alarm tone pause time.**
-

7.8.2.2 Switching Off Alarm Sound

If **Pause Time** is set to **Permanent** (see section 24.3.2.2 *Setting the Alarm Pause Time/Alarm Tone Pause Time*), pressing the **Audio Pause** quick key permanently switches off all alarm sound. The audio off state has the following features:

- Alarm sound of both physiological alarms and technical alarms is switched off.
- The audio off symbol is displayed in the system information area.

To exit the audio off state, press the **Audio Pause** quick key again.

WARNING

- **Pausing or switching off alarm sound may result in a hazard to the patient.**
-

7.9 Resetting Alarms

Press the **Alarm Reset** quick key to reset the alarm system. When the alarm system is reset, the alarm reset symbol displays in the system status information area for alarm symbols.

NOTE

- **If a new alarm is triggered after the alarm system is reset, the alarm reset icon will disappear and the alarm light and alarm tone will be reactivated.**
-

7.9.1 Resetting Physiological Alarms

For physiological alarms, when the alarm system is reset, the following occur:

- The alarm sound is silenced.
- A check mark  appears before the alarm message.
- The color of the parameter numeric background corresponds with the alarm priority, but the parameter numeric does not flash.

7.9.2 Resetting Technical Alarms

For technical alarms, when the alarm system is reset, the following occur:

- Some technical alarms are cleared. The monitor gives no alarm indications.
- Some technical alarms are changed to prompt messages.
- For some technical alarms, the alarm is silenced and a check mark  appears before the alarm message.

For details about the indications of technical alarms when the alarm system is reset, see *D.2 Technical Alarm Messages*.

7.10 Latching Alarms

The latching setting for physiological alarms defines how alarm indicators behave if you do not reset the alarms.

- If you do not “latch” physiological alarms, their alarm indications disappear when the alarm condition ends.
- If you “latch” physiological alarms, all visual and audible alarm indications remain (if configured) until the alarms are reset. For latched alarms the time when the alarm is last triggered is displayed behind the alarm message.

The monitor can be set to separately latch visual indications or simultaneously latch the visual and the audible indications.

- When visual indications are latched, visual indications, including alarm lamp, alarm message and its background remain when the alarm condition ends and the time when the alarm last triggered is displayed behind the alarm message.
- When audible indications are latched, the monitor continues to issue alarm sounds when the alarm condition ends.

To set how you want to latch the physiological alarms, see section *24.3.3 Latching Physiological Alarms*.

NOTE

- **Changing alarm priority may affect the latching status of the corresponding alarm. Determine if you need to adjust the latching status for the specific alarm when you have changed its alarm priority.**
- **When the alarm system is reset, latched physiological alarms are cleared.**

7.11 Nurse Call

The monitor provides a nurse call connector to output a nurse call signal when a user-defined alarm occurs. To obtain a nurse call signal, use the nurse call cable to connect the hospital nurse call system with the monitor's nurse call connector.

Alarms are indicated on the nurse call device only when the following conditions are met:

- The nurse call system is enabled.
- A user-defined alarm occurs.
- Alarms are not paused or reset.

WARNING

- **Do not rely exclusively on the nurse call system for alarm notification. Remember that the most reliable alarm notification combines audible and visual alarm indications with the patient's clinical condition.**

7.12 Calling for Help

This monitor can be configured to call monitors in the same department and the CMS system so that nearby doctors and nurses can come for help.

7.12.1 Issuing the Call Help Signal

To call help, select the **Call Help** quick key and select **OK** from the popup dialog box. If **OK** is not selected within 5 seconds then the monitor will automatically send out the call help signal.

After the call help signal is sent out, the **Call Help** quick key flashes in red. Select the **Call Help** quick key again to stop the call help signal.

Monitors receiving the call help signal issue a sound and a dialog box pops up indicating which monitor is calling. Select **OK** to acknowledge the call and stop the sound at this monitor.

NOTE

- **The call help function works only when the monitor is connected to the network.**
 - **The call help sound may disturb patients in the same department.**
-

7.13 CPB Mode

The CPB (Cardiopulmonary Bypass) mode is activated only if you set the department to **OR**.

In the CPB mode, all the physiological alarms and technical alarms are switched off. So when performing CPB, you can put the monitor in the CPB mode to inactivate unnecessary alarms.

7.13.1 Entering the CPB Mode

To enter the CPB mode, choose either of the following ways:

- Select the **CPB Mode** quick key.
- Select the **Main Menu** quick key → from the **Alarm** column select **CPB Mode**.

In the CPB mode, **CPB Mode** is displayed in the physiological alarm area with a red background color.

NOTE

- **When the CPB mode is entered, the monitor stops all NIBP measurements. You can restart NIBP measurements after entering the CPB mode.**
-

7.13.2 Exiting the CPB Mode

To exit the CPB mode, choose either of the following ways:

- Select the **CPB Mode** quick key.
- Select the **Main Menu** quick key → from the **Alarm** column select **Exit CPB Mode**.

7.14 Intubation Mode

Intubation mode is available for Resp, CO₂, and AG monitoring. When performing intubation during general anesthesia, you can put the monitor in the intubation mode in order to inactivate unnecessary alarms.

In the intubation mode, Resp, CO₂, and AG related physiological alarms are switched off.

7.14.1 Entering the Intubation Mode

To enter the intubation mode, choose either of the following ways:

- Select the **Intubation Mode** quick key.
- From the bottom of the **Resp**, **CO2**, or **AG** dialog, select **Intubation Mode**.
- Select the **Main Menu** quick key → from the **Alarm** column select **Intubation Mode**.

7.14.2 Exiting the Intubation Mode

To exit the intubation mode, choose either of the following ways:

- Select the **Intubation Mode** quick key.

- From the bottom of the **Resp**, **CO2**, or **AG** dialog, select **Exit Intubation Mode**.
- Select the **Main Menu** quick key from the **Alarm** column → select **Exit Intubation Mode**.

7.15 Testing Alarms

The monitor automatically performs a selftest at startup. Check that an alarm tone is heard, the alarm lamp illuminates, one after the other, in red, yellow, and cyan. This indicates that the visible and audible alarm indicators function correctly.

To further test individual measurement alarms, perform measurements on yourself or using a simulator. Adjust alarm limits and check that appropriate alarm behavior is observed.

This page intentionally left blank.

8

Monitoring ECG, Arrhythmia, ST and QT

8.1 ECG Introduction

The electrocardiogram (ECG) measures the electrical activity of the heart and displays it on the monitor as waveforms and numerics. ECG monitoring provides 3-, 5-lead ECG monitoring, ST-segment analysis, arrhythmia analysis, QT/QTc measurements.

The associated monitor incorporating ST analysis has the ST label.

8.2 ECG Safety Information

WARNING

- **This equipment is not intended for direct cardiac application.**
- **Ensure that the conductive parts of ECG electrodes and associated connectors, including the neutral electrode, do not come into contact with any other conductive parts including earth.**
- **Always use defibrillation-proof ECG cables during defibrillation.**
- **Do not touch the patient, or metal devices connected to the patient, during defibrillation.**
- **To minimize the hazard of burns during high-frequency surgical procedures, ensure that the monitor's cables and transducers never come into contact with the electrosurgery unit (ESU).**
- **To minimize the hazard of burns during use of high-frequency surgical unit (ESU), the ECG electrodes should not be located between the surgical site and the ESU return electrode.**



CAUTION

- **Only use parts and accessories specified in this manual. Follow the instructions for use and adhere to all warnings and cautions.**
- **Periodically inspect the electrode application sites to ensure skin integrity. If the skin quality changes, replace the electrodes or change the application site.**
- **Interference from an ungrounded instrument near the patient or electrosurgery usage can induce noise and artifact into the waveforms.**

8.3 ECG Display

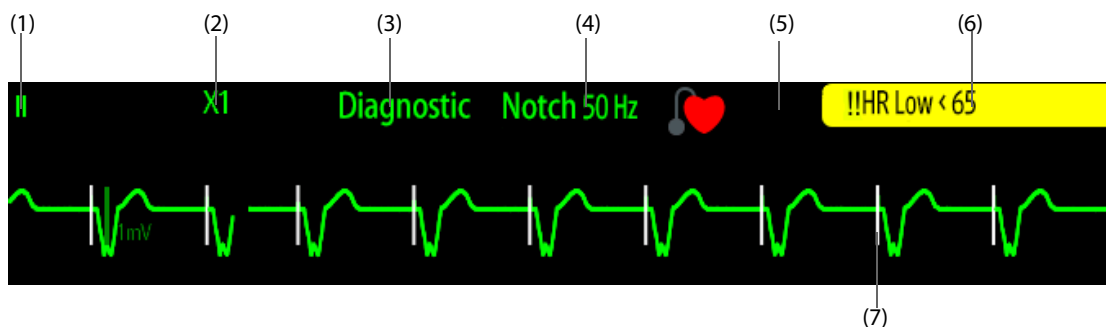
The following figures show the ECG waveform and numeric areas. The display may be configured to look slightly different.



- (1) ECG lead label of the displayed waveform
- (2) ECG waveform gain
- (3) ECG filter mode
- (4) Notch filter status
- (5) Paced status: If **Paced** is set to **Yes**,  is displayed. If **Paced** is set to **No**,  is displayed.
- (6) HR/PR alarm message
- (7) Pace pulse marker: If **Paced** is set to **Yes**, pace pulse markers “|” are displayed corresponding to detected pacer for each beat.

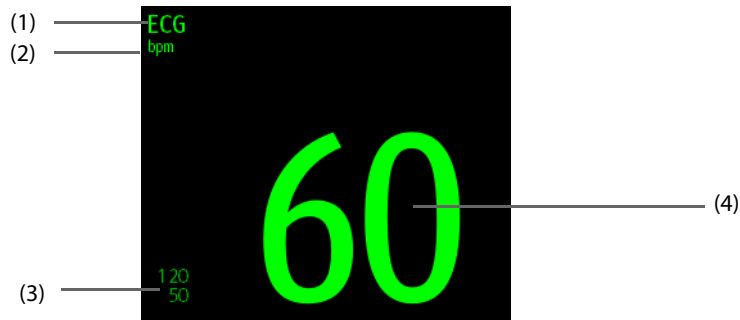

- (1) Parameter label
- (2) HR measurement unit
- (3) HR alarm limits
- (4) HR value

8.4 Preparing for ECG Monitoring

8.4.1 Preparing the Patient Skin

Proper skin preparation is necessary to ensure good signal quality at the electrode sites, as the skin is a poor conductor of electricity. To properly prepare the skin, choose flat areas and then follow this procedure:

1. Shave hair from skin at chosen electrode sites.
2. Gently rub skin surface at sites to remove dead skin cells.
3. Thoroughly cleanse the site with a mild soap and water solution. We do not recommend using ether or pure alcohol, because this dries the skin and increases the resistance.
4. Dry the skin completely before applying electrodes.

8.4.2 Applying Electrodes and Connecting the Patient

To connect ECG cables, follow this procedure:

1. Check that electrode packages are intact and the electrodes are not past the expiry date. Ensure the electrode gel is moist. If you are using snap electrodes, attach the snaps to the electrodes before placing electrodes on the patient.
2. Place the electrodes on the prepared sites. Ensure that all electrodes have good skin contact.
3. Connect the leadwires to the patient cable if not already connected.
4. Plug the patient cable into the ECG connector.

CAUTION

- **Never mix patient electrode types or brands. This may lead to impedance mismatches issues.**
-

NOTE

- **When applying the electrodes, avoid bony area, obvious layers of fat, and major muscles. Muscle movement can result in electrical interference. Applying electrodes on major muscles, for example on muscles of the thorax, may lead to erroneous arrhythmia alarms due to excessive muscle movement.**

8.4.3 Lead Wire Color Code

The following table lists the color coding of leadwires for AHA standards:

Lead	Label	Color
Right arm	RA	White
Left arm	LA	Black
Right leg (neutral)	RL	Green
Left leg	LL	Red
Chest	V1	Brown

8.4.4 ECG Electrode Placements

In this section, electrode placement is illustrated using the AHA naming convention.

8.4.4.1 3-leadwire Electrode Placement

The following is the electrode configuration when a 3-leadwire cable is used:

- RA placement: directly below the clavicle and near the right shoulder.
- LA placement: directly below the clavicle and near the left shoulder.
- LL placement: on the left lower abdomen.

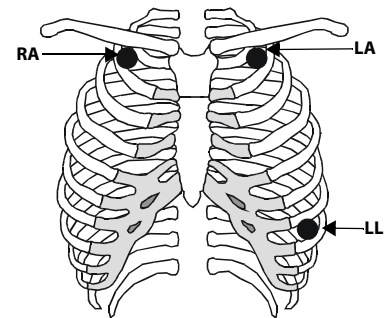

8.4.4.2 5-leadwire Electrode Placement

The following is the electrode configuration for a 5-leadwires cables:

- RA placement: directly below the clavicle and near the right shoulder.
- LA placement: directly below the clavicle and near the left shoulder.
- RL placement: on the right lower abdomen.
- LL placement: on the left lower abdomen.
- V placement: on the chest in any of the V1 to V6 positions.

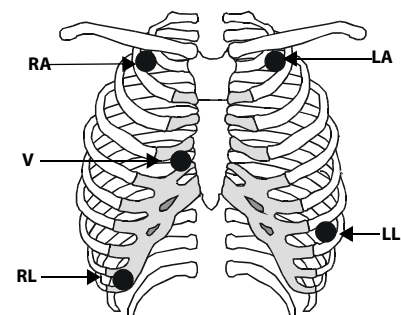

8.4.4.3 Chest Electrode Placement

The chest electrode can be placed at the following positions:

- V1 placement: on the fourth intercostal space to the right of the sternum.
- V2 placement: on the fourth intercostal space to the left of the sternum.
- V3 placement: midway between the V2 and V4 electrode positions.
- V4 placement: on the fifth intercostal space at the left midclavicular line.
- V5 placement: on the left anterior axillary line, horizontal with the V4 electrode position.
- V6 placement: on the left midaxillary line, horizontal with the V4 electrode position.
- V3R-V6R placement: on the right side of the chest in positions corresponding to those on the left.

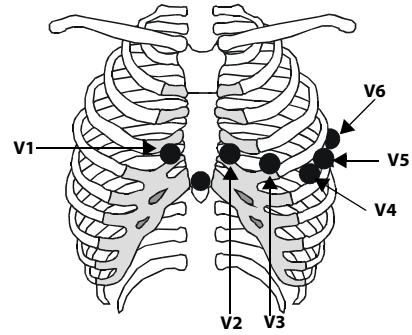

NOTE

- For the 5-leadwire placement, place the precordial electrode according to the physician's preference.

8.4.4.4 Lead Placement for Pacemaker Patients

The recommended lead placement for monitoring a pacemaker patient is as follows.

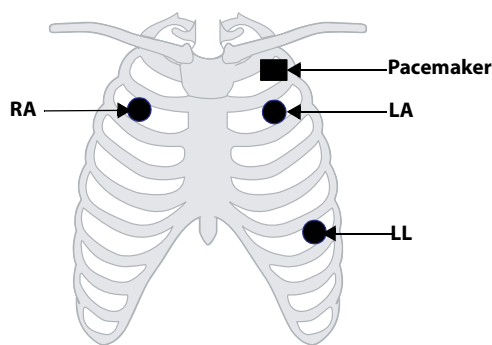

3-leadwire Electrode Placement

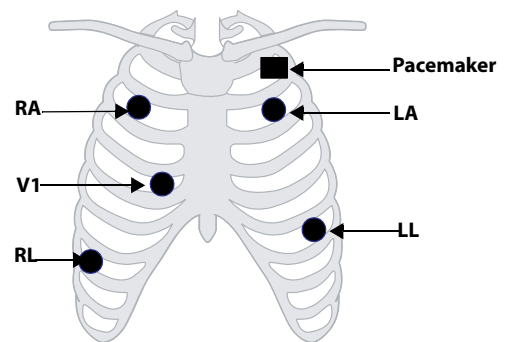

5-leadwire Electrode Placement

A pacemaker patient usually requires a different electrode patch placement configuration than a non-pacemaker patient.

Do not place an ECG electrode directly over the pacemaker generator. Place the electrode patches 2 to 3 inches away from the pacemaker generator area. For example, if the pacemaker generator is located in the right subclavian area, relocate the Right Arm electrode closer in towards the center of the chest.

8.4.4.5 Lead Placement for Surgical Patients

The surgical site should be taken into consideration when placing electrodes on a surgical patient. For example, for open-chest surgery, the chest electrodes can be placed on the lateral chest or back. To reduce artifacts and interference from electrosurgical units, you can place the limb electrodes close to the shoulders and lower abdomen and the chest electrodes on the left side of the mid-chest. Do not place the electrodes on the upper arm. Otherwise, the ECG waveform will be very small.

WARNING

- To reduce the hazard of burns during use of electrosurgical units (ESU), the ECG electrodes should not be located between the surgical site and the ESU return electrode.
- Never entangle the ESU cable and the ECG cable together.



- **When using ESU, never place ECG electrodes near the grounding plate of the ESU, as this can cause a lot of interference on the ECG signal.**
 - **When using ESU, ensure proper contact of the ESU return electrode to the patient to avoid burns at monitor measurement sites. Also ensure that the ESU return electrode is near the operating area.**
-
-

8.4.5 Choosing the ECG Lead Type

To choose ECG lead type, follow this procedure:

1. Select the ECG numeric area or waveform area to enter the **ECG** dialog.
2. Select the **Setup** tab.
3. Set **Lead Set** according to the lead type you are going to use. The default lead type is **Auto**. In this case, the monitor automatically detects the lead type.

8.4.6 Checking Paced Status

It is important to correctly set the patient's paced status before you start monitoring ECG. The paced symbol  is displayed when **Paced** is set to **Yes**. Pace pulse markers "P" are displayed on each ECG waveform whenever a pacer signal is detected. If **Paced** is set to **No** or unspecified, the symbol  will be shown in the ECG waveform area.

To change the paced status, follow this procedure:

1. Select the ECG numeric area or waveform area to enter the **ECG** dialog.
2. Select the **Pacer** tab.
3. Set **Paced** to **Yes** or **No**.

You can also change the patient's paced status from the **Patient Management** dialog. For more information, see *5.2.1 Entering the Patient Management Dialog*.

If you did not set the paced status, the monitor issues a prompt tone when pace pulse is detected. At the same time, the paced symbol  flashes and the message **Please check if the patient has a pacemaker.** appears in the ECG waveform area. Check and set the patient's paced status.

WARNING

- **For paced patients, you must set Paced to Yes. If it is incorrectly set to No, the monitor could mistake a pace pulse for a QRS complex and fail to alarm when the ECG signal is too weak. On ventricular paced patients, episodes of ventricular tachycardia may not always be detected. Do not rely entirely upon the system's automated arrhythmia detection algorithm.**
 - **False low heart rate or false asystole alarms may result with certain pacemakers because of pacemaker artifacts, such as electrical overshoot of the pacemaker overlapping the true QRS complexes.**
 - **Do not rely entirely on rate meter alarms when monitoring patients with pacemakers. Always keep these patients under close surveillance.**
 - **The auto pacer recognition function is not applicable to pediatric patients, neonatal patients, and patients with NMT monitoring.**
-
-

8.4.7 Enabling Pacer Rejection

To eliminate the pacing pulse from the ECG waveform of paced patients, it is recommended to enable the pace pulse rejection function. The pace pulse rejection function is disabled by default. To enable this function, follow this procedure:

1. Select the ECG numeric area or waveform area to enter the **ECG** dialog.
2. Select the **Pacer** tab.
3. Switch on **Pacer Reject**.

NOTE

- When pace pulses are detected, the pace pulse markers “|” are shown on the ECG waveforms. Pacer Rejection setting has no impact on the display of pace pulse markers “|”.
 - You can switch on Pacer Reject only when Paced is set to Yes. If Paced is set to No, the Pacer Reject function is disabled.
-

8.5 Changing ECG Settings

8.5.1 Choosing an ECG Screen

When monitoring ECG, several display options are available.

- For 3-lead ECG monitoring, only normal screen is available.
- For 5-lead ECG monitoring, besides the normal screen, you can also choose Full-screen (7-lead) or Half Screen (7-lead).

To choose the desired screen configuration, follow this procedure:

1. Select the ECG numeric area or waveform area to enter the **ECG** dialog.
2. Select **Full-Screen** or **Half-Screen**.

To return to the normal screen, press the highlighted button to unselect that screen.

Alternately you can choose the desired screen configuration as follows:

1. Select the **Screen Setup** quick key → **Choose Screen** or select the **Main Menu** quick key → from the **Display** column select **Choose Screen**.
2. Select **ECG Full-Screen** or **ECG Half-Screen**.

8.5.2 Setting ECG Alarm Properties

To select the desired ECG alarm options, follow this procedure:

1. Select the ECG numeric area or waveform area to enter the **ECG** dialog.
2. Select the **Alarm** tab.
3. Select the desired alarm options.

8.5.3 Changing ECG Wave Settings

8.5.3.1 Selecting the Leads of Displayed ECG Waveforms

To select the desired ECG waveforms to be displayed, follow this procedure:

1. Select the ECG numeric area or waveform area to enter the **ECG** dialog.
2. Select the **Setup** tab.
3. Select **ECG** to set the lead of each displayed ECG waveform.
4. If more than three ECG waveforms are to be displayed, select the **More Leads** tab, and then select **ECG** to set leads of other ECG waveforms.

For optimal ECG analysis, select leads with the following characteristics:

- The QRS complex should be either completely above or below the baseline and it should not be biphasic.
- The QRS complex should be tall and narrow.
- The P waves and T waves should be less than 0.2mV.

CAUTION

- **Ensure that you have selected the optimal leads with the best waveform amplitude and the highest signal-to-noise ratio. Selecting the optimal leads is important for detecting beats, classifying beats, and detecting ventricular fibrillation.**
-

8.5.3.2 Changing ECG Waveform Size

If the ECG waveform is too small or clipped, you can change its size by selecting the appropriate **Gain** setting. To do so, follow this procedure:

1. Select the ECG numeric area or waveform area to enter the **ECG** dialog.
2. Select the **Setup** tab.
3. Select **ECG Gain** to set the size of each ECG waveform.
4. If more than three ECG waveforms are displayed, select the **More Leads** tab, and then select **ECG Gain** to change the sizes of other ECG waveforms. If you select **Auto**, the monitor automatically adjusts the size of the ECG waveforms for all the leads.

8.5.3.3 Changing ECG Waveform Speed

To change ECG waveform speed, follow this procedure:

1. Select the ECG numeric area or waveform area to enter the **ECG** dialog.
2. Select the **Setup** tab.
3. Set the desired **Speed**.

8.5.3.4 Setting the ECG Filter

To set the appropriate ECG waveform filter mode, follow this procedure:

1. Select the ECG numeric area or waveform area to enter the **ECG** dialog.
2. Select the **Setup** tab.
3. Set **Filter**.
 - ◆ **Diagnostic:** use when diagnostic quality ECG is required. The unfiltered ECG waveform is displayed so that changes such as R-wave notching or discrete elevation or depression of the ST segment are visible.
 - ◆ **Monitor:** use under normal monitoring conditions.
 - ◆ **Surgery:** use when the signal is distorted by high frequency or low frequency interference. High frequency interference usually results in large amplitude spikes making the ECG signal look irregular. Low frequency interference usually leads to wandering or rough baseline. The surgery filter reduces artifacts and interference from electrosurgical units. Under normal measurement conditions, selecting **Surgery** may suppress certain features or details of the QRS complexes.
 - ◆ **ST:** recommended for ST monitoring.

8.5.3.5 Switching On or Off the Notch Filter

The notch filter removes the line frequency interference. To switch on or off the notch filter, follow this procedure:

1. Select the ECG numeric area or waveform area to enter the **ECG** dialog.
2. Select the **Setup** tab.
3. Switch on or off **Notch Filter**.

NOTE

- **The notch filter can only be switched on or off when ECG Filter is set to Diagnostic. In other filter modes, the notch filter is always on.**
-

8.5.4 Disabling the Smart Lead Off Function

The monitor provides the smart lead off function. When the lead corresponding to the first ECG wave gets detached but another lead is available, the monitor automatically switches to the available lead to recalculate heart rate, and to analyze and detect arrhythmias. When you reconnect the detached leads, the monitor automatically switches back to the original lead.

The smart lead off function is enabled by default. To disable this function, follow this procedure:

1. Select the ECG numeric area or waveform area to enter the **ECG** dialog.
2. Select the **Setup** tab.
3. Switch off **Smart Lead**.

8.5.5 Adjusting the QRS Volume

To adjust the QRS volume, follow this procedure:

1. Select the ECG numeric area or waveform area to enter the **ECG** dialog.
2. Select the **Setup** tab.
3. Set **QRS Volume**.

When valid SpO₂ measurements are available, the monitor adjusts the pitch of QRS tone based on the SpO₂ value.

8.5.6 Adjusting the Minimum QRS Detection Threshold

To avoid false asystole alarm due to low R wave amplitude, and to avoid tall T waves and P waves being mistaken for QRS complexes, the monitor provides a means to manually adjust the minimum QRS detection threshold.

To adjust the minimum QRS detection threshold, follow this procedure:

1. Select the ECG numeric area or waveform area to enter the **ECG** dialog.
2. Select the **Setup** tab and set **Filter** to **Monitor**.
3. Select the **QRS Threshold** tab.
4. Select up or down arrow buttons to adjust the minimum threshold for QRS detection. Selecting **Default** resets the QRS threshold to the default value (0.16 mV).

CAUTION

- **The setting of the QRS detection threshold can affect the sensitivity for arrhythmia, ST, QT/QTc detection, and heart rate calculation.**
- **If the QRS amplitude is low, the monitor might not be able to detect the beats and false asystole calls may occur.**

NOTE

- **The minimum QRS detection threshold can only be adjusted when the ECG filter is set to Monitor.**
-

8.6 Monitoring Arrhythmia

Arrhythmia monitoring is intended for adult, pediatric and neonatal patients.

8.6.1 Arrhythmia Safety Information

WARNING

- **Heart rate reading may be affected by cardiac arrhythmias. Do not rely entirely on heart rate alarms when monitoring patients with arrhythmias. Always keep these patients under close surveillance.**
 - **The arrhythmia analysis program is intended to detect ventricular arrhythmias and atrial fibrillation. It is not designed to detect all the atrial or supraventricular arrhythmias. It may incorrectly identify the presence or absence of an arrhythmia. Therefore, a physician must analyze the arrhythmia information with other clinical findings.**
 - **Atrial fibrillation (A-Fib) detection function is not intended for pediatric patients.**
 - **Atrial fibrillation (A-Fib), Pacer Not Capture, and Pacer Not Pacing detection functions are not intended for neonatal patients.**
-

CAUTION

- **Since the arrhythmia detection algorithm sensitivity and specificity are less than 100%, it is possible for false arrhythmias to be detected and true arrhythmia events to not be detected. The possibility increases when the signal is noisy.**
 - **The ECG size and minimum QRS detection threshold settings affect arrhythmia detection and heart rate calculation sensitivity.**
 - **If QRS amplitude is low, the monitor might be unable to calculate heart rate and thus create false asystole calls. During the learning phase of the algorithm, arrhythmia detection may not be available. It is recommended to closely monitor patient condition during, and for several minutes after, the learning phase to allow the algorithm to reach optimal detection performance.**
-

8.6.2 Arrhythmia Events

This section lists all arrhythmia events and their criteria.

8.6.2.1 Lethal Arrhythmia Events

Arrhythmia message	Description
Asystole	No QRS complex detected within the set time interval in the absence of ventricular fibrillation or chaotic signal.
V-Fib/V-Tach	A fibrillatory wave for 6 consecutive seconds. A dominant rhythm of adjacent PVCs and the ventricular rate is greater than the V-tach rate limit.
V-Tach	The number of consecutive PVCs is greater than or equal to the V-Tach PVCs limit, and the ventricular rate is greater than or equal to the V-Tach rate limit.

8.6.2.2 Nonlethal Arrhythmia Events

Arrhythmia message	Description
Vent Brady	The number of consecutive PVCs is greater than or equal to V brady PVC limit and the ventricular rate is less than the V-Brady Rate limit.
Extreme Tachy	The heart rate is greater than the extreme tachycardia limit.
Extreme Brady	The heart rate is less than the extreme bradycardia limit.
R on T	R on T PVC is detected.

Arrhythmia message	Description
Run PVCs	More than two consecutive PVCs, but lower than the V-Brady PVCs limit, and the ventricular rate is lower than the V-Tach rate limit.
Couplet	A Pair of PVCs detected in between normal beats.
Multiform PVC	Multiform PVCs detected in Multif. PVC's Window (which is adjustable).
PVC	One PVC detected in between normal beats.
Bigeminy	A dominant rhythm of N, V, N, V, N, V*.
Trigeminy	A dominant rhythm of N, N, V, N, V, N, V*.
Tachy	The heart rate is greater than the tachycardia limit.
Brady	The heart rate is lower than the bradycardia limit.
Pacer Not Capture	No QRS complex detected for 300 ms following a pace pulse (for paced patients only).
Pacer Not Pacing	No pace pulse detected for 1.75 x average R-to-R intervals following a QRS complex (for paced patients only).
Missed Beat	At least 3 consecutive Ns*, and The current RR interval is greater than 1.5 x previous RR interval, and The next RR interval is lower than 1.5 x average RR interval, and HR lower than 100 and the current RR interval is greater than 1.75 x average RR interval, or HR is greater than or equal to 100 and the current RR interval is greater than 1000 ms.
Nonsus V-Tach	The number of consecutive PVCs is lower than the V-Tach PVCs limit but greater than 2, and the ventricular rate is greater than or equal to the V-Tach Rate limit.
Vent Rhythm	The number of consecutive PVCs is greater than or equal to the V-Brady PVCs limit, and ventricular rate is greater than or equal to the V-Brady Rate limit but lower than V-Tach Rate limit.
Pause	No QRS complex is detected within the set pause time threshold.
Irr Rhythm	Consistently irregular rhythm (N*, irregular RR interval change is greater than 12.5%)
A-Fib (for adult only)	P wave is absent and normal beat RR intervals are irregular.
PVCs/min	PVCs/min exceeds high limit.
Pauses/min	Pauses/min exceeds high limit.
Irr Rhythm End	Irregular rhythm no longer detected for the irregular rhythm end delay time.
A-Fib End (for adult only)	Atrial fibrillation no longer detected for the A-Fib end delay time.

*N: normal beat; V: ventricular beat

8.6.3 Displaying Arrhythmia Information

You can display the arrhythmia information in the numeric area. To do so, follow this procedure:

1. Access **Tile Layout** using either of the following ways:
 - ◆ Select the **Screen Setup** quick key → select the **Tile Layout** tab.
 - ◆ Select **Main Menu** quick key → from the **Display** column select **Tile Layout**.
2. Click the numeric area where you want to display the arrhythmia information, and then select ECG → **Arrhythmia**.

8.6.4 Changing Arrhythmia Settings

8.6.4.1 Changing Arrhythmia Alarm Settings

To set the arrhythmia alarm properties, follow this procedure:

1. Select the ECG numeric area or waveform area to enter the **ECG** dialog.
2. Select the **Arrhythmia** tab → **Alarm** tab.
3. Set alarm properties as desired.

NOTE

- You can switch off lethal arrhythmia alarms only when you have configured the monitor to allow lethal arrhythmia alarms to be turned off. For more information, see 24.3.4 *Setting Guard Limits*.
- The priority of lethal arrhythmia alarms is always high. It cannot be altered.

8.6.4.2 Changing Arrhythmia Alarm Threshold Settings

You can change threshold settings for certain arrhythmia alarms. When an arrhythmia exceeds its threshold, an alarm will be triggered. To do so, follow this procedure:

1. Select the ECG numeric area or waveform area to enter the **ECG** dialog.
2. Select the **Arrhythmia** tab → select the **Threshold** tab.
3. Enter the password if required. For more information, refer to 24.13.3 *Selecting Password for User Authentication*.
4. Set the threshold for the desired arrhythmia alarms.

NOTE

- The asystole delay time relates to ECG relearning. When heart rate is less than 30 bpm, it is recommended to set Asystole Delay to 10 sec.

8.6.4.3 Arrhythmia Threshold Range

Arrhythmia	Threshold Range
Asystole Delay	3 sec to 10 sec
Tachy (HR High)	60 bpm to 295 bpm
Brady (HR Low)	16 bpm to 120 bpm
Extreme Tachy	65 bpm to 300 bpm
Extreme Brady	15 bpm to 115 bpm
Multif PVCs Window	3 beats to 31 beats
V-Tach Rate	100 bpm to 200 bpm
V-Brady Rate	15 bpm to 60 bpm
V-Tach PVCs	3 beats to 99 beats
V-Brady PVCs	3 beats to 99 beats
PVCs/min	1 to 100
Pauses/min	1 to 15
Pause Threshold	1.5 sec, 2.0 sec, 2.5 sec, 3.0 sec
AF/Irr Rhy End Time	0 min, 1 min, 2 min, 3 min, 4 min, 5 min, 10 min, 15 min, 30 min

8.6.4.4 Setting Thresholds for PVC-Related Alarms

PVC-related alarms are detected on the basis of the current PVC rate and the number of consecutive PVCs.

To set the required thresholds for PVC-related alarms, follow this procedure:

1. Select the ECG numeric area or waveform area to enter the **ECG** dialog.
2. Select the **Arrhythmia** tab → select the **More Threshold** tab.
3. Enter the password if required. For more information, refer to 24.13.3 *Selecting Password for User Authentication*.

Adjust **V-Tach PVCs**, **V-Tach Rate**, **V-Brady PVCs**, and **V-Brady Rate** as necessary to set the thresholds for the desired PVC-related alarms.

The following figure illustrates the conditions under which PVC alarms will be generated if **V-Tach PVCs** is set to 6, **V-Tach Rate** is set to 130, **V-Brady PVCs** is set to 5, and **V-Brady Rate** is set to 40.

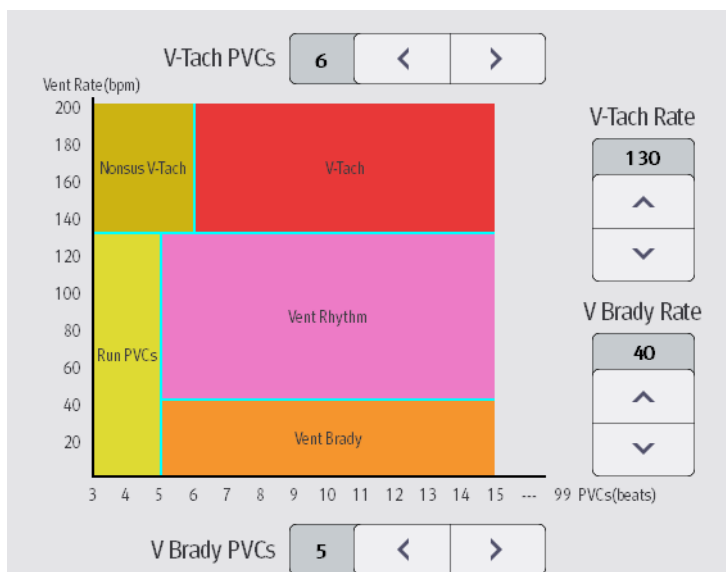

- If the number of consecutive PVCs is greater than or equal to the V-Tach PVCs limit (6), and the ventricular rate (Vent Rate) is greater than or equal to the V-Tach Rate limit (130), a V-Tach alarm is generated.
- If the number of consecutive PVCs is lower than the V-Tach PVCs limit (6) but greater than 2, and the ventricular rate is greater than or equal to the V-Tach Rate limit (130), a Nonsus V-Tach alarm is generated.
- If the number of consecutive PVCs is greater than or equal to the V-Brady PVCs limit (5), and the ventricular rate is lower than the V-Tach Rate limit (130) but greater than or equal to the V-Brady Rate limit (40), a Vent Rhythm alarm is generated.
- If the number of consecutive PVCs is lower than the V-Brady PVCs limit (5) but greater than 2, and the ventricular rate is lower than the V-Tach Rate limit (130), a Run PVCs alarm is generated.
- If the number of consecutive PVCs is greater than or equal to the V-Brady PVCs limit (5), and the ventricular rate is lower than the V-Brady Rate limit (40), a Vent Brady alarm is generated.

8.6.5 Intelligent Arrhythmia Alarm

Normally, an arrhythmia alarm is presented when an alarm condition is detected. However, there are certain situations that can inhibit audible and visible alarm indications even though an alarm condition was detected. For more information, see 8.6.4.3 *Arrhythmia Threshold Range* and 8.6.5.2 *Arrhythmia Alarm Shielding Rules*.

8.6.5.1 Arrhythmia Alarm Chains

If multiple alarms overlap, announcing all of the detected alarm conditions would be confusing, and a more serious condition might be overlooked. So arrhythmia alarms are prioritized by alarm “chains”.

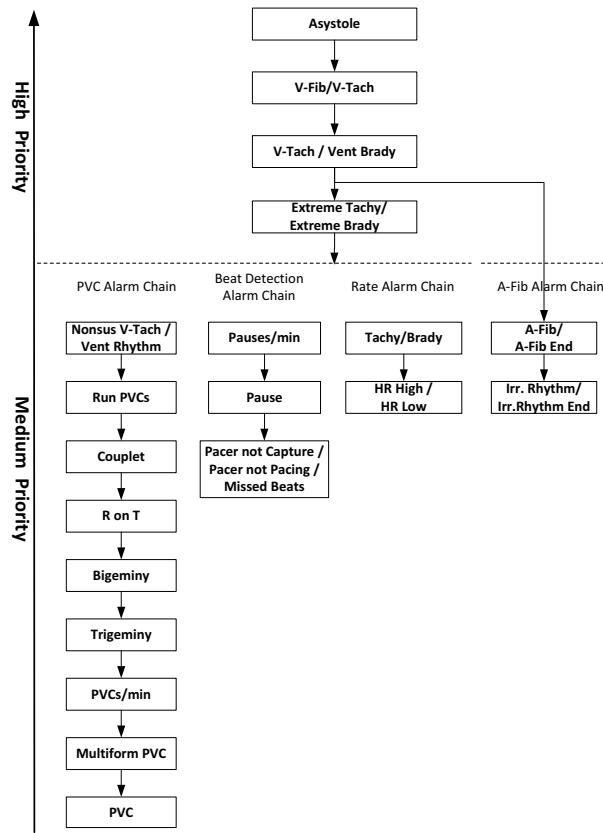

8.6.5.2 Arrhythmia Alarm Shielding Rules

The following table explains how audible and visual alarms are indicated during arrhythmia alarm shielding period.

Previous alarm	Current alarm	Alarm indication
Alarm in high priority chain	Alarm in high priority chain	Alarm light and alarm tone
	Alarm in medium priority chain	During the shielding period, alarm light and alarm tone are disabled. When the shielding period is reached, alarm light and alarm tone are reactivated.
Alarm in medium priority chain	Alarm in high priority chain	Alarm light and alarm tone
	Alarm in the same medium priority chain, but with higher priority	Alarm light and alarm tone
	The same alarm reoccurs	During the shielding period, alarm light and alarm tone are disabled. When the shielding period is reached, alarm light and alarm tone are reactivated.
	Alarm in the same medium priority chain, but with lower priority	During the shielding period, alarm light and alarm tone are disabled. When the shielding period is reached, alarm light and alarm tone are reactivated.
	Alarm in other medium priority chain	Alarm light and alarm tone

8.6.5.3 Arrhythmia Alarm Refractory Period

For the following eight alarms in medium priority chain, there is a 30-second refractory period. That is to say, if the same alarm is not presented within 30 seconds after the previous alarm disappears.

- Couplet
- R on T
- PVCs/min High
- Multiform PVCs
- PVC
- Missed Beat
- Pacer Not Capture
- Pacer Not Pacing

8.7 ST Segment Monitoring

ST segment analysis is intended for adult, pediatric and neonatal patients. To use this feature, the monitor must be labeled to support ST analysis.

8.7.1 ST Safety Information

WARNING

- **ST segment deviation values may be affected by such factors as certain drugs or metabolic and conduction disturbances.**
 - **ST deviation is often calculated at a fixed offset from the J point. Changes in heart rate may affect ST.**
 - **The significance of the ST segment changes need to be determined by a clinician.**
 - **This monitor provides information regarding changes in ST deviation levels. The clinical significance of the ST level change information should be determined by a physician.**
-
-

8.7.2 Enabling ST Monitoring

The ST monitoring function is disabled by default. Before you start ST monitoring, enable the ST function. To do so, follow this procedure:

1. Select the ECG numeric area or waveform area to enter the **ECG** dialog.
2. Select the **ST** tab → select the **Setup** tab.
3. Switch on **ST Analysis**.

Reliable ST monitoring cannot be ensured under the following situations:

- You are unable to get a lead that is not noisy.
- Arrhythmias, such as atrial fibrillation or atrial flutter, which may cause an irregular baseline.
- The patient is continuously ventricularly paced.
- The patient has left bundle branch block.

In these cases, you may consider switching off ST monitoring.

8.7.3 Displaying ST Deviation Numerics

To display ST numerics, follow this procedure:

1. Access **Tile Layout** by either of the following ways:
 - ◆ Select the **Screen Setup** quick key → select the **Tile Layout** tab.
 - ◆ Select **Main Menu** quick key → from the **Display** column select **Tile Layout**.
2. Click the numeric area where you want to display the ST numerics, and then select **ECG** → **ST**.

The ST parameter display area is configured differently according to the ECG cable used:

- When you are using the 3-lead ECG leadwires, a separate ST numeric area does not appear on the display. The ST deviation value displays in the ECG numeric area.
- When you are using the 5-lead ECG leadwires, the ST numeric area displays 7 ST deviation values: ST-I, ST-II, ST-III, ST-aVR, ST-aVL, ST-aVF, ST-V.

This example shows the ST numeric area when 5-lead ECG cable is used. The monitor screen may look slightly different:

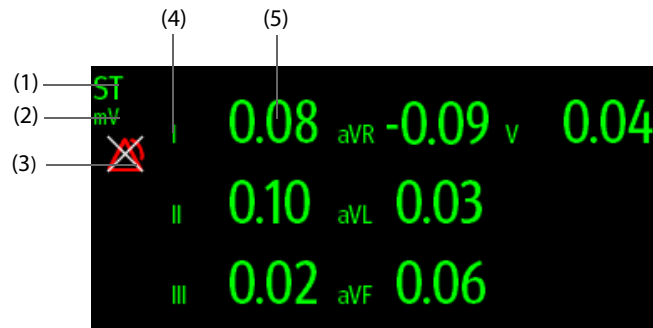

- (1) Parameter label
- (2) ST measurement unit
- (3) ST alarm off symbol
- (4) Lead labels
- (5) ST numerics: a positive value indicates ST segment elevation, and a negative value indicates ST segment depression.

8.7.4 Displaying ST Segments in the Waveform Area

You can display ST segments in the waveform area. To do so, follow this procedure:

1. Access **Tile Layout** by either of the following ways:
 - ◆ Select the **Screen Setup** quick key → select the **Tile Layout** tab.
 - ◆ Select **Main Menu** quick key → from the **Display** column select **Tile Layout**.
2. Select the waveform area where you want to display the ST segments, and then select **ECG** → **ST Segment**.

ST segment shows a QRS complex segment for each measured ST lead. The current ST segment is drawn in the same color as the ECG wave, usually green, superimposed over the stored reference segment, drawn in a different color. The information is updated once every ten seconds.

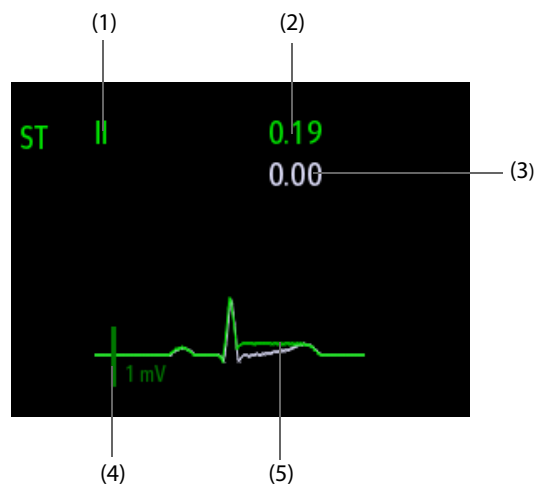

- (1) ST lead
- (2) Current ST deviation value
- (3) Baseline ST deviation value
- (4) 1 mV scale
- (5) Current ST segment (green) and baseline ST segment (white)

8.7.5 Entering the ST View

In ST View mode a complete QRS segment for each ST lead is displayed. The color of the current ST segments and ST deviation values is consistent with the color of the ECG waveforms, normally green. The color of the baseline ST segments and ST deviation values is white.

To enter the ST View, follow this procedure:

1. Select the ECG numeric area or waveform area to enter the **ECG** dialog.
2. Select the **ST** tab.
3. From the bottom of the dialog, select **ST View**.

8.7.6 Saving the Current ST Deviation and Segment as Baseline

ST deviation is typically monitored as a relative change from a baseline value. Set an ST baseline when ST deviation values become stable. If you did not set the ST baseline, the monitor automatically saves the baseline when valid ST deviation values appear for 5 minutes. To set the ST baseline, follow this procedure:

1. From the **ST View**, select **Set Baseline**.
2. From the pop-up dialog box, select **OK** to set the current ST segments and values as the baseline.

From the **ST View**, you can also perform the following operations:

- Display or hide ST baseline by selecting **Display Baseline** or **Hide Baseline**.
- Display or hide the position of ISO point, J point and ST point by selecting **Display Marker** or **Hide Marker**.

CAUTION

- **Updating ST baseline affects ST alarms.**
-

8.7.7 Entering the ST Graphic

To display **ST Graphic**, follow this procedure:

1. Select the ECG numeric area or waveform area to enter the **ECG** dialog.
2. Select the **ST** tab.
3. Select **ST Graphic**.

The following figure shows the ST Graphic when **ST Alarm Mode** is set to **Absolute**. The height of the bar indicates the ST deviation value of corresponding ST lead. The color of the bar indicates ST alarm status: green indicates that corresponding ST deviation value is within alarm limits; cyan, yellow and red indicate that the ST deviation value exceeds the alarm limits. The color matches ST alarm priority.

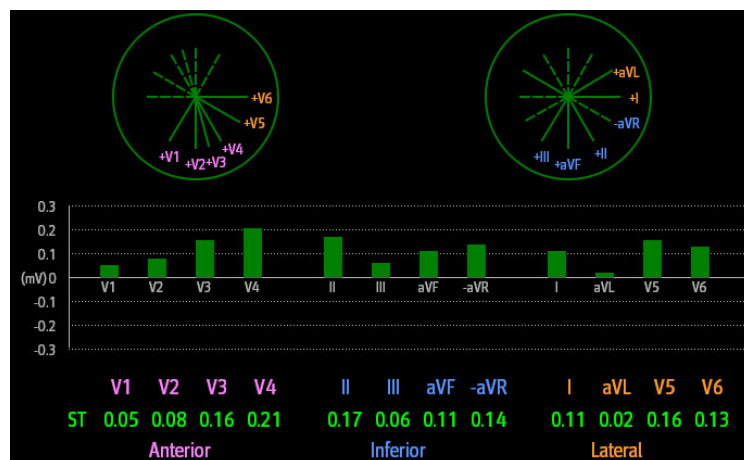

The following figure shows the ST Graphic when **ST Alarm Mode** is set to **Relative**. The height of grey bar indicates the baseline ST deviation value and the green bar (cyan, yellow or red if an alarm occurs) indicates relative ST from that baseline.

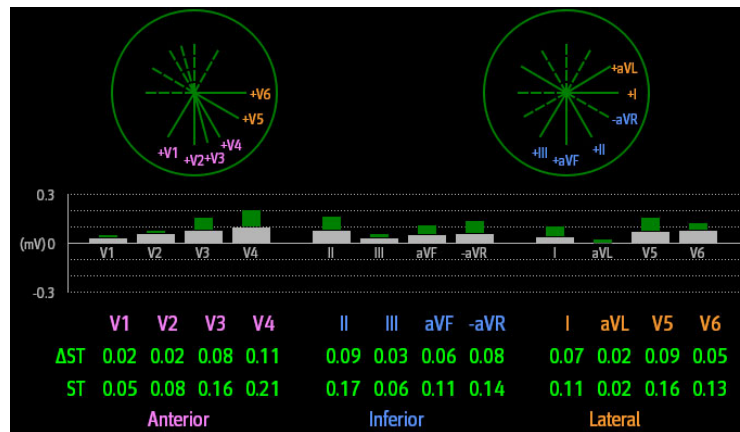

8.7.8 Changing ST Settings

8.7.8.1 Setting ST Alarm Properties

To set ST alarm properties, follow this procedure:

1. Select the ECG numeric area or waveform area to enter the **ECG** dialog.
2. Select the **ST** tab → **Alarm** tab.
3. Set **ST Alarm Mode** to **Absolute** or **Relative**.
 - ◆ **Absolute**: you can separately set the alarm properties for each ST alarm for each lead.
 - ◆ **Relative**: you can set the alarm properties for **ST Single** and **ST Dual** alarms.
4. Set ST alarm properties.

8.7.8.2 Changing Leads for ST Display

The monitor automatically selects the three most deviated leads for ST display. You can also manually select the leads. To do so, follow this procedure:

1. Select the ECG numeric area or waveform area to enter the **ECG** dialog.
2. Select the **ST** tab → select the **Setup** tab.
3. Set **ST Segment**. You can select up to 3 leads.

8.7.8.3 Showing ISO Point, J Point, and ST Point Markers

In the waveform area, the ISO point, J point, and ST point marker do not display on the ST segments by default. To display these markers, follow this procedure:

1. Select the ECG numeric area or waveform area to enter the **ECG** dialog.
2. Select the **ST** tab → select the **Setup** tab.
3. Switch on **Show Markers**.

8.7.9 Adjusting ST Measurement Points

8.7.9.1 About ST Point, ISO Point, and J Point

The ST deviation value for each beat is the potential difference between the isoelectric (ISO) point and the ST point. The ISO point provides the baseline. The ST point is located between the J point and the start of the T-wave. The J point is the end of the QRS complex. As the ST point is at a fixed distance away from the J point (40, 60, 80 etc msec), manually adjusting the J point helps you correctly position the ST point.

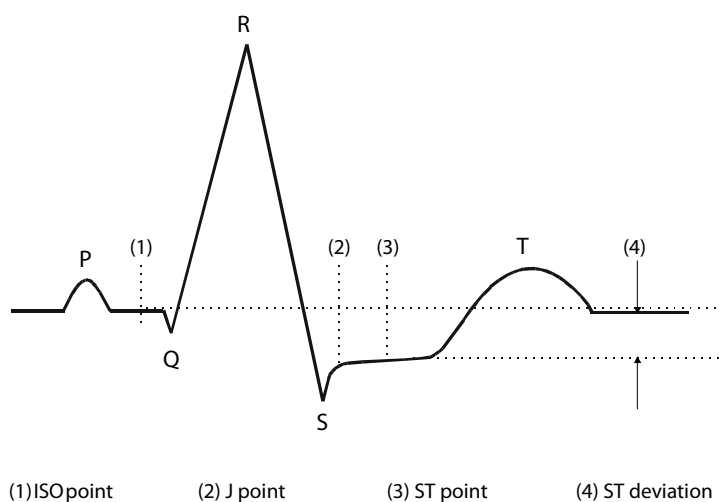

8.7.9.2 Setting ST Point, ISO Point, and J Point

CAUTION

- If **Auto Adjust** is Off, or if the patient's heart rate or ECG morphology changes significantly, the **ISO** and **ST** points need to be occasionally adjusted because this may affect the **QT** interval and thus the location of the **ST** point. False **ST** segment depression or elevation may occur if the isoelectric point or the **ST** point is incorrectly set.
- Always ensure that the locations of **ST** points are appropriate for the patient.

To set the ST point, ISO point, and J point, follow this procedure:

1. Select the ECG numeric area or waveform area to enter the **ECG** dialog.
2. Select the **ST** tab→ select the **Adjust** tab.
3. Set **ST Point**.

The setting for **Auto Adjust** defines the method of adjusting the ISO and J point locations. **Auto Adjust** is enabled by default. In this case, the locations of the ISO point and J point are automatically determined by the algorithm. When **Auto Adjust** is disabled, you need to manually adjust the position of the ISO point and J point using the arrows at the right sides of **ISO** and **J**.

- The ISO point (isoelectric) location shown is relative to the R-wave peak. Position the ISO point in the middle of the flattest part of the waveform (between the P and Q waves).
- The J point location is indicated relative to the R-wave peak. Position the J point at the end of the QRS complex and the beginning of the ST segment.
- The ST point is positioned a fixed distance from the J point. Position the ST point relative to the J point at **J+60/80ms**, **J+40ms**, **J+60ms** or **J+80ms**. When **J+60/80ms** is selected, the ST point will be positioned 80 ms (heart rate 120 bpm or less) or 60 ms (heart rate more than 120 bpm) from the J point.

8.8 QT/QTc Interval Monitoring

The QT interval is the time between the beginning of the Q-wave and the end of the T-wave. It represents the total duration of the depolarization (QRS duration) and repolarization (ST-T) phases of the ventricles. QT interval monitoring can assist in the detection of long QT syndrome.

The QT interval has an inverse relationship to heart rate. Faster heart rates shorten QT interval and slower heart rates prolong QT interval. Therefore, several formulas are commonly used to correct the QT interval for heart rate. The heart rate corrected QT interval is abbreviated as QTc.

QT/QTc interval monitoring is intended for adult, pediatric, and neonatal patients.

8.8.1 QT/QTc Monitoring Limitations

Some conditions may make it difficult to achieve reliable QT/QTc monitoring, for example:

- R-wave amplitudes are too low
- The presence of frequent ventricular ectopic beats
- RR intervals are unstable
- P-waves tending to encroach on the end of the previous T-wave at high heart rates
- The T-wave is very flat or T-wave are not well defined
- The end of the T-wave is difficult to delineate because of the presence of U-waves
- QTc measurements are not stable
- In the presence of noise, asystole, ventricular fibrillation, atrial fibrillation, or ECG lead off

For reliable QT/QTc monitoring, choose lead with good T-wave amplitude and no visible flutter activity, and without a predominant U-wave or P-wave.

Some conditions such as left or right bundle branch block or ventricular hypertrophy can lead to a widened QRS complex. If a long QTc is observed you should verify it to ensure that it is not caused by QRS widening.

Because normal beats followed by ventricular beats are not included in the analysis, no QT measurement will be generated in the presence of a bigeminy rhythm.

If the heart rate is extremely high (over 150 bpm for adults and over 180 bpm for pediatrics and neonates), QT will not be measured. When the heart rate changes, it can take several minutes for the QT interval to stabilize. For reliable QTc calculation it is important to avoid measurements when the heart rate is changing.

8.8.2 Enabling QT/QTc Monitoring

The QT monitoring function is disabled by default. Before you start QT monitoring, enable the QT function. To do so, follow this procedure:

1. Select the ECG numeric area or waveform area to enter the **ECG** dialog.
2. Select the **QT** tab → select the **Setup** tab.
3. Switch on **QT Analysis**.

8.8.3 Displaying QT Numerics and Segments

To display QT numerics and Segments, follow this procedure:

1. Access **Tile Layout** by either of the following ways:
 - ◆ Select the **Screen Setup** quick key → select the **Tile Layout** tab.
 - ◆ Select **Main Menu** quick key → from the **Display** column select **Tile Layout**.
2. Click the parameter numeric area where you want to display the QT numerics, and then select **ECG** → **QT/QTc**.

NOTE

- **QTc values are calculated based on the QT-HR, not the ECG HR. To view the QT-HR, open the QT View. For more information, see 8.8.4 Entering the QT View.**

The following picture shows the QT numeric area. The monitor screen may look slightly different:

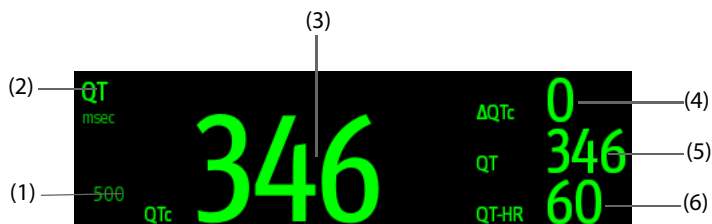

- (1) QTc alarm limit (if QTc alarm is off, the alarm off symbol is displayed)
- (2) Parameter label
- (3) QTc value
- (4) ΔQTc value (the difference between the current and baseline QTc values)
- (5) QT value
- (6) QT-HR value

8.8.4 Entering the QT View

QT View shows the current and baseline QT parameter values and waveforms. To enter QT View, follow this procedure:

1. Select the ECG numeric area or waveform area to enter the **ECG** dialog.
2. Select the **QT** tab.
3. Select **QT View**.

The following picture shows a typical QT view.

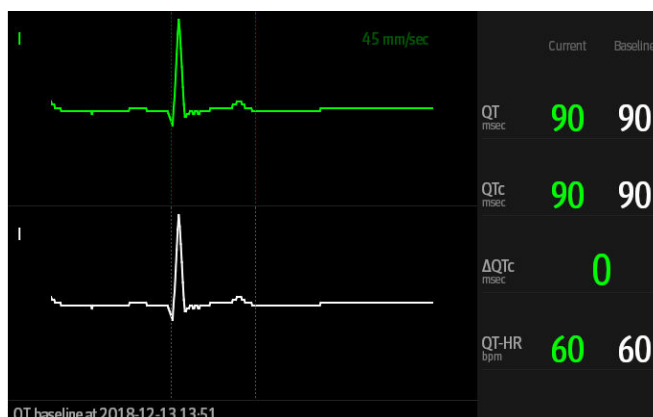

- The current waveform is shown in the upper half in green.
- The baseline waveform is shown below in white.
- The waveform of selected lead is highlighted, while the waveforms of other leads are in light green or light gray.
- The start of the QRS complex and the end of the T wave are marked with a vertical line.
- In some conditions, no QT measurement can be made. Then the cause of failed QT measurement is shown at the bottom of the QT numerics area and the message "Cannot Analyze QT" is shown in the technical alarm area.

Select the left or right arrow to switch leads, and the corresponding waveform will be highlighted.

8.8.5 Saving the Current QTc as Baseline

In order to quantify changes in the QTc value, you can set a QTc baseline. If no baseline has been set for this patient within the first five minutes after getting valid QT values, the monitor will automatically set a baseline. To set the current values as baseline, follow this procedure:

1. From the **QT View**, select **Set Baseline**.
2. From the pop-up dialog box, select **OK**. This baseline will then be used to calculate Δ QTc.

If you set a new baseline the previous baseline is discarded.

From the **QT View**, you can also perform the following operations:

- Select the left or right arrow to select a lead label to highlight corresponding waveform.
- Select **Display Baseline** or **Hide Baseline** to display or hide the baseline waveform.

CAUTION

- **Updating QTc baseline affects the Δ QTc value and alarm.**
-

8.8.6 Changing QT Settings

8.8.6.1 Setting QT Alarm Properties

To set QT alarm properties, follow this procedure:

1. Select the ECG numeric area or waveform area to enter the **ECG** dialog.
2. Select the **QT** tab→ select the **Alarm** tab.
3. Set QTc and Δ QTc alarm properties.

8.8.6.2 Selecting Leads for QT Calculation

You can select one lead or all leads for QT calculation. To do so, follow this procedure:

1. Select the ECG numeric area or waveform area to enter the **ECG** dialog.
2. Select the **QT** tab→ select the **Setup** tab.
3. Set **QT Leads**. **All** is selected by default. This means all leads are used for QT calculation.

8.9 ECG Relearning

Changes in ECG beat morphology could result in incorrect arrhythmia alarms and/or inaccurate heart rate. ECG relearning allows the monitor to learn the new dominant beat morphology and thus reduce false arrhythmia alarms and inaccurate HR values. Once learning is complete, the dominant QRS complex is stored as a reference template. The reference template is used as the normal morphology of that patient and it is compared with incoming beats to identify possible arrhythmias.

8.9.1 Auto ECG Relearning

Auto arrhythmia relearning happens in the following situation:

- The ECG lead type or lead label is changed.
- ECG leads are off and are not reconnected within 60 seconds.
- The patient's paced status is changed.

8.9.2 Initiating an ECG Relearning Manually

If you suspect that false arrhythmia alarms are presented, you may need to manually initiate an ECG relearn. To do so, follow this procedure:

1. Select the ECG numeric area or waveform area to enter the **ECG** dialog.

2. Select **Relearn**.

CAUTION

- **Initiate ECG relearning only during periods of predominantly normal rhythm and when the ECG signal is relatively noise-free. If ECG learning takes place during arrhythmias, the ectopic beats may be incorrectly learned as normal QRS complexes. This may result in missed detection of subsequent arrhythmia events.**
-

8.10 Defibrillation Synchronization Pulse Output

The monitor provides an analog out connector to output synchronization pulses for defibrillators. If a defibrillator is connected, it receives a synchronization pulse (100 ms, +5 V) through the analog out connector each time an R-wave is detected.

WARNING

- **According to IEC 60601-2-4: 2010, the peak of the synchronized defibrillator discharge should be delivered within 60 ms of the peak of the R wave. The signal at the ECG output (sync pulse) on the monitor is delayed by maximum of 30 ms. the biomedical engineer should verify that the ECG/ Defibrillator combination does not exceed recommended maximum delay of 60 ms.**
 - **Before defibrillation, ensure that both defibrillator and monitor have passed the system test and can be safely used together.**
-

8.11 ECG Troubleshooting

This section lists some of the problems that might be encountered during ECG monitoring. If you encounter problems when using the monitor or accessories, check the table below before requesting for services. If the problem persists after you have taken corrective actions, contact the service personnel.

NOTE

- **For the physiological and technical alarm messages, see Appendix D Alarm Messages.**
-

Problem	Corrective Actions
Noisy ECG traces	<ol style="list-style-type: none"> 1. Check that the electrodes are not detached or dry. Replace with fresh and moist electrodes if necessary. 2. Check that leadwires are not defective. Replace leadwires if necessary. 3. Check that the patient cable or leadwires are not routed too close to other electrical devices. Move the patient cable or leadwires away from electrical devices and their cables if necessary.
Excessive electrosurgical Interference	Use ESU-proof ECG cables. For more information, see <i>28.1 ECG Accessories</i> .
Muscle Noise	<p>Inadequate skin preparation, tremors, tense subject, and/or poor electrode placement.</p> <ol style="list-style-type: none"> 1. Perform skin preparation again and re-place the electrodes. For more information, see <i>8.4.1 Preparing the Patient Skin</i> and <i>8.4.2 Applying Electrodes and Connecting the Patient</i>. 2. Apply fresh, moist electrodes. Avoid muscular areas.
Intermittent Signal	<ol style="list-style-type: none"> 1. Check that cables are properly connected. 2. Check that electrodes are not detached or dry. Perform skin preparation again as described in <i>8.4.1 Preparing the Patient Skin</i> and apply fresh and moist electrodes. 3. Check that the patient cable or leadwires are not damaged. Change them if necessary.

Problem	Corrective Actions
Excessive alarms: heart rate, lead fault	<ol style="list-style-type: none"> 1. Check that electrodes are not dry. Perform skin preparation again and re-place the electrodes. For more information, see <i>8.4.1 Preparing the Patient Skin</i> and <i>8.4.2 Applying Electrodes and Connecting the Patient</i>. 2. Check for excessive patient movement or muscle tremor. Reposition the electrodes. Replace with fresh and moist electrodes if necessary.
Low Amplitude ECG Signal	<ol style="list-style-type: none"> 1. Check that the ECG gain is not set too low. Adjust the gain as required. For more information, see <i>8.5.3.2 Changing ECG Waveform Size</i>. 2. Perform skin preparation again and re-place the electrodes. For more information, see <i>8.4.1 Preparing the Patient Skin</i> and <i>8.4.2 Applying Electrodes and Connecting the Patient</i>. 3. Check electrode application sites. Avoid bone or muscular area. 4. Check that electrodes are not dry or used for a prolonged time. Replace with fresh and moist electrodes if necessary.
No ECG Waveform	<ol style="list-style-type: none"> 1. Check that the ECG gain is not set too low. Adjust the gain as required. For more information, see <i>8.5.3.2 Changing ECG Waveform Size</i>. 2. Check that the leadwires and patient cables are properly connected. 3. Change cable and lead wires if necessary. 4. Check that the patient cable or leadwires are not damaged. Change them if necessary.
Base Line Wander	<ol style="list-style-type: none"> 1. Check for excessive patient movement or muscle tremor. Secure leadwires and cable. 2. Check that electrodes are not detached or dry and replace with fresh and moist electrodes if necessary. For more information, see <i>8.4.1 Preparing the Patient Skin</i> and <i>8.4.2 Applying Electrodes and Connecting the Patient</i>. 3. Check for ECG filter setting. Set ECG Filter mode to Monitor to reduce baseline wander on the display.

This page intentionally left blank.

9 Monitoring Impedance Respiration (Resp)

9.1 Resp Introduction

Impedance respiration is measured across the thorax. When the patient is breathing or ventilated, the volume of air changes in the lungs, resulting in impedance changes between the electrodes. Impedance respiration rate (RR) is calculated from the signal representing these impedance changes, and a respiration waveform is displayed on the patient monitor screen.

Impedance respiration monitoring is intended for adult, pediatric and neonatal patients.

Respiration may also be measured using a CO₂ module or anesthetic gas (AG) module. See *15 Monitoring Carbon Dioxide (CO₂)* and *16 Monitoring Anesthetic Gas (AG)* for respiration information specific to those modules.

9.2 Impedance Resp Safety Information

WARNING

- When monitoring the patient's impedance respiration, do not use ESU-proof ECG cables. The monitor cannot measure impedance respiration with ESU-proof ECG cables.
- If you do not set the detection level for the respiration correctly in manual detection mode, it may not be possible for the monitor to detect apnea. If you set the detection level too low, the monitor is more likely to detect cardiac activity, and to falsely interpret cardiac activity as respiratory activity in case of apnea.
- The respiration measurement does not recognize the cause of apneas. It only indicates an alarm if a pre-adjusted time has elapsed without a breath being detected since the last detected breath. Therefore, it cannot be used for diagnostic purpose.
- If operating under conditions according to the EMC Standard IEC 60601-1-2 (Radiated Immunity 3V/m), field strengths above 3V/m may cause erroneous measurements at various frequencies. Therefore, it is recommended to avoid the use of electrically radiating equipment in close proximity to the impedance respiration measurement unit.
- The current used to measure impedance respiration may cause rate changes in Minute Ventilation Rate Responsive Pacemakers. If you suspect the patient monitor is affecting the pacemaker rate then replace the ECG cable with an ECG cable that contains ESU filters.

CAUTION

- Only use parts and accessories specified in this manual.
- Impedance respiration monitoring is not for use on patients while they are active, as this can cause false alarms.

9.3 Resp Display

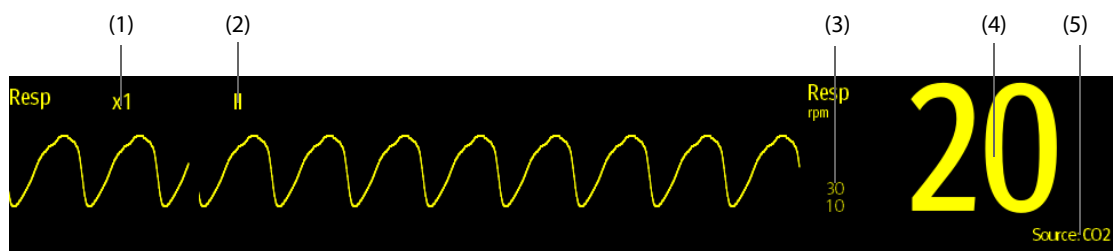

- (1) Resp waveform gain (2) Resp lead label (3) Alarm limits
- (4) Respiration rate (RR) (5) RR source

NOTE

- **If ESU-proof ECG cables are used, the Resp waveform area will display the message “Check Leads”. Replace the ECG cable if necessary.**

9.4 Preparing for Impedance Resp Monitoring

9.4.1 Preparing the Patient

Follow this procedure to prepare the patient:

1. Shave hair from skin at chosen sites.
2. Gently rub skin surface at sites to remove dead skin cells.
3. Thoroughly cleanse the site with a mild soap and water solution.
4. Dry the skin completely before applying the electrodes.

CAUTION

- **Proper skin preparation is necessary for good signal quality at the electrode site, as the skin is a poor conductor of electricity.**

9.4.2 Placing the Electrodes

Impedance respiration is acquired using standard ECG electrodes and cables. Either lead I (RA-LA) or lead II (RA-LL) can be used.

For more information, see 8.4.4 ECG Electrode Placements.

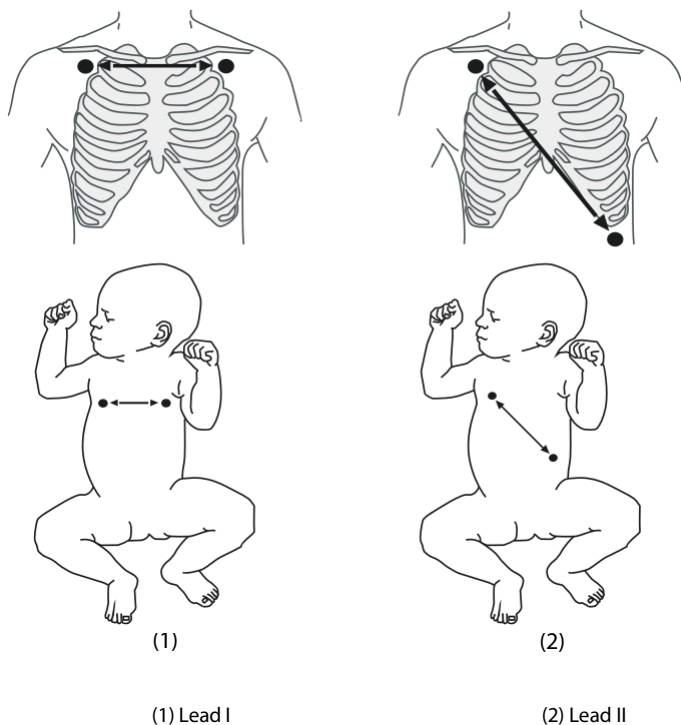

CAUTION

- **Correct electrode placement can help to reduce interference from cardiac related impedance changes: avoid including the liver area and the ventricles of the heart between the respiratory electrodes. This is particularly important for neonates.**
 - **Some patients with restricted movements breathe mainly abdominally. In these cases, you may need to place the left leg electrode on the left abdomen at the point of maximum abdominal expansion to optimize the respiratory waveform.**
 - **Some patients (especially neonates) expand their chests laterally, causing a negative intrathoracic pressure. In these cases, it is better to place the two respiration electrodes in the right midaxillary and the left lateral chest areas at the patient's maximum point of the breathing movement to optimize the impedance respiration waveform.**
 - **To optimize the impedance respiration waveform, place the RA and LA electrodes horizontally when monitoring respiration with ECG Lead I; place the RA and LL electrodes diagonally when monitoring respiration with ECG Lead II.**
 - **Periodically inspect electrode application sites to ensure skin integrity. If the skin quality changes, replace the electrodes or change the application site.**
-

NOTE

- **Store the electrodes at room temperature. Open the electrode package immediately prior to use.**
 - **Check that the electrode packages are intact and that the electrodes are not past the expiration date. Ensure the electrode gel is moist.**
-

9.5 Changing Resp Settings

9.5.1 Setting the Resp Alarm Properties

To set the Resp alarm properties, follow this procedure:

1. Select the Resp numeric area or waveform area to enter the **Resp** dialog.
2. Select the **Alarm** tab.
3. Enter the password if required. For more information, refer to *24.13.3 Selecting Password for User Authentication*.
4. Set alarm properties as desired.

9.5.2 Setting the RR Source

To set RR source, follow this procedure:

1. Select the Resp numeric area or waveform area to enter the **Resp** dialog.
2. Select the **Setup** tab.
3. Choose **RR Source** from the dropdown list.

When you select **Auto**, the monitor automatically selects the RR source following order of priority: first **CO₂**, and then **ECG**. When the manually selected RR source is not available, the monitor automatically switches the **RR Source** to **Auto**.

9.5.3 Choosing the Respiration Lead

To set the respiration lead, follow this procedure:

1. Select the Resp numeric area or waveform area to enter the **Resp** dialog.
2. Select the **Setup** tab.
3. Set **Resp Lead**.

If you cannot get an acceptable impedance Resp waveform or you suspect the veracity of the Resp value after choosing the Resp lead, you may need to adjust the electrode placement.

9.5.4 Setting the Resp Waveform Size

To set the Resp waveform size, follow this procedure:

1. Select the Resp numeric area or waveform area to enter the **Resp** dialog.
2. Select the **Setup** tab.
3. Set **Gain**.

9.5.5 Setting the Resp Waveform Speed

To set the Resp waveform speed, follow this procedure:

1. Select the Resp numeric area or waveform area to enter the **Resp** dialog.
2. Select the **Setup** tab.
3. Set **Speed**.

9.5.6 Setting the Auto Detection Switch

To set the auto detection switch, follow this procedure:

1. Select the Resp numeric area or waveform area to enter the **Resp** dialog.
2. Select the **Setup** tab.
3. Switch on or off **Auto Threshold Detection**.
 - ◆ If **Auto Threshold Detection** is switched on, the monitor automatically adjusts the Resp waveform detection level, or threshold.
 - ◆ If **Auto Threshold Detection** is switched off, you have to manually adjust the Resp waveform threshold. For more information, see 9.5.7 *Adjusting the Resp Waveform Detection Threshold*.

In the auto threshold detection mode, if you are monitoring Resp and the ECG parameter is switched off, the monitor cannot compare the heart rate and Resp rates to detect cardiovascular artifact. The respiration detection level is automatically set higher to prevent the detection of cardiovascular artifact as respiration.

In the manual detection mode (where auto threshold detection is off), cardiovascular artifact can, in certain situations, trigger the respiration rate counter. This may lead to a false indication of a high respiration or an undetected apnea condition. If you suspect that cardiovascular artifact is being registered as respiratory activity, raise the detection level above the zone of cardiovascular artifact. If the Resp wave is so small that raising the detection level is not possible, you may need to optimize the electrode placement.

9.5.7 Adjusting the Resp Waveform Detection Threshold

Use the manual detection mode (where auto threshold detection is off) in the following situations:

- The respiration rate and the heart rate are close.
- Patients have intermittent mandatory ventilation.
- Respiration is weak. Try repositioning the electrodes to improve the signal.

To set the Resp waveform threshold to the desired level, follow this procedure:

1. Select the Resp numeric area or waveform area to enter the **Resp** dialog.
2. Select the **Threshold** tab.
3. Select the up and down arrows below **Upper Line** and **Lower Line** to define the Resp waveform threshold.

Once set, the detection level will not adapt automatically to different respiration depths. It is important to remember that if the depth of breathing changes, you may need to change the detection level.

10 Monitoring Pulse Oxygen Saturation (SpO₂)

10.1 SpO₂ Introduction

Pulse Oxygen Saturation (SpO₂) monitoring is a non-invasive technique used to measure the amount of oxygenated hemoglobin and pulse rate by measuring the absorption of selected wavelengths of light. The light generated in the emitter side of the probe is partly absorbed when it passes through the monitored tissue. The amount of transmitted light is detected in the detector side of the probe. When the pulsative part of the light signal is examined, the amount of light absorbed by the hemoglobin is measured and the pulse oxygen saturation can be calculated. This device is calibrated to display functional oxygen saturation.

SpO₂ monitoring is intended for adult, pediatric and neonatal patients.

The monitor can be configured with Masimo or Nellcor SpO₂ module:

- Masimo SpO₂: the connector is purple and the logo of Masimo SET.
- Nellcor SpO₂: the connector is grey and the logo of Nellcor.

NOTE

- **The SpO₂ extension cable used must be compatible with the SpO₂ sensor connectors used. For example, only the Masimo SpO₂ extension cable can be connected to the Masimo SpO₂ sensor connectors.**
 - **Measurement accuracy verification: The SpO₂ accuracy has been verified in human experiments by comparing with arterial blood sample reference measured with a CO-oximeter. Pulse oximeter measurements are statistically distributed and about two-thirds of the measurements are expected to come within the specified accuracy range compared to CO-oximeter measurements.**
 - **A functional tester or SpO₂ simulator can be used to determine the pulse rate accuracy.**
 - **A functional tester or SpO₂ simulator cannot be used to assess the SpO₂ accuracy.**
-

10.2 SpO₂ Safety Information

WARNING

- **When a trend toward patient deoxygenation is indicated, analyze the blood samples with a laboratory co-oximeter to completely understand the patient's condition.**
- **Do not use SpO₂ sensors during magnetic resonance imaging (MRI). Induced current could potentially cause burns. The sensor may affect the MRI image, and the MRI unit may affect the accuracy of the oximetry measurements.**
- **Prolonged continuous monitoring may increase the risk of undesirable changes in skin characteristics, such as irritation, reddening, blistering or burns. Inspect the sensor site every two hours and move the sensor if the skin quality changes. Change the application site every four hours. For neonates, or patients with poor peripheral blood circulation or sensitive skin, inspect the sensor site more frequently.**
- **If the sensor is too tight because the application site is too large or becomes too large due to edema, excessive pressure for prolonged periods may result in venous congestion distal from the application site, leading to interstitial edema and tissue ischemia.**
- **When patients are undergoing photodynamic therapy they may be sensitive to light sources. Pulse oximetry may be used only under careful clinical supervision for short time periods to minimize interference with photodynamic therapy.**
- **Setting alarm limits to extreme values may cause the alarm system to become ineffective. For example, high oxygen levels may predispose a premature infant to retrolental fibroplasia. If this is a consideration, do not set the high alarm limit to 100%, which is equivalent to switching off the alarm.**

- SpO₂ is empirically calibrated in healthy adult volunteers with normal levels of carboxyhemoglobin (COHb) and methemoglobin (MetHb).
- To protect from electric shock, always remove the sensor before bathing the patient.
- The pulse oximetry function of the bedside monitor should not be used for apnea monitoring.
- The pulse oximeter function of the bedside monitor should not be used for arrhythmia analysis.

CAUTION

- Change the application site or replace the sensor and/or patient cable when a persistent SpO₂ Low Signal Quality message is displayed on the equipment. These messages may indicate that patient monitoring time is exhausted on the patient cable or sensor.
- Replace the cable or sensor when a “SpO₂ Sensor Off”, “SpO₂ No Sensor”, or “SpO₂ Low Signal Quality” message is consistently displayed while monitoring consecutive patients after completing troubleshooting steps listed in this manual.
- Variation in measurements may be profound and may be affected by sampling technique as well as the patient’s physiological conditions. Any results exhibiting inconsistency with the patient’s clinical status should be repeated and/or supplemented with additional test data. Blood samples should be analyzed by laboratory instruments prior to clinical decision making to completely understand the patient’s condition.
- Use only SpO₂ sensors specified in this manual. Follow the SpO₂ sensor’s instructions for use and adhere to all warnings and cautions.
- Do not place the bedside monitor where the controls can be changed by the patient.
- If using pulse oximetry during full body irradiation, keep the sensor out of the radiation field. If the sensor is exposed to the radiation, the reading might be inaccurate or the device might read zero for the duration of the active irradiation period.

NOTE

- Additional information specific to the Masimo sensors compatible with the equipment, including information about parameter/measurement performance during motion and low perfusion, may be found in the sensor’s directions for use (DFU).
- Masimo cables and sensors are provided with X-Cal™ technology to minimize the risk of inaccurate readings and unanticipated loss of patient monitoring. Refer to the Cable or Sensor DFU for the specified duration of the patient monitoring time.

10.3 SpO₂ Measurement Limitations

The following factors may influence the accuracy of SpO₂ measurement:

- Patient physiological characteristics:
 - ◆ Cardiac arrest
 - ◆ Hypotension
 - ◆ Darkly pigmented skin
 - ◆ Shock
 - ◆ Severe vasoconstriction
 - ◆ Hypothermia
 - ◆ Severe anemia
 - ◆ Ventricular septal defects (VSDs)
 - ◆ Venous pulsations
 - ◆ Poor perfusion
 - ◆ Dysfunctional hemoglobin, such as carboxyhemoglobin (COHb) and methemoglobin (MetHb)
 - ◆ Elevated levels of bilirubin
 - ◆ Vasospastic disease, such as Raynaud’s, and peripheral vascular disease

- ◆ Hemoglobinopathies and synthesis disorders such as thalassemias, Hb s, Hb c, sickle cell, etc.
- ◆ Hypocapnic or hypercapnic conditions
- ◆ Birthmark(s), tattoos, skin discolorations, moisture on skin, deformed or abnormal fingers. etc.
- Interfering substances:
 - ◆ Intravascular dyes (such as indocyanine green, methylene blue, indigo carmine, etc.)
 - ◆ Dyes in the measure site, such as nail polish
- Environmental conditions:
 - ◆ Excessive ambient light
 - ◆ Electrosurgery equipment
 - ◆ Defibrillation (may cause inaccurate reading for a short amount of time)
 - ◆ Excessive patient/sensor motion
 - ◆ Electromagnetic field
 - ◆ Arterial catheters and intra-aortic balloon
- Others
 - ◆ Inappropriate positioning of the SpO₂ sensor, or use of incorrect SpO₂ sensor
 - ◆ Cuff or arterial blood pressure measurement device on the same limb as the SpO₂ sensor

10.4 SpO₂ Display

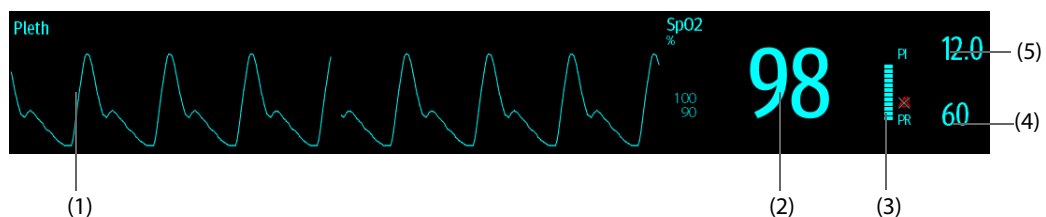

- (1) Pleth waveform (Pleth/Plethb): visual indication of patient's pulse. The waveform is not normalized.
- (2) Oxygen saturation of arterial blood (SpO₂): percentage of oxygenated hemoglobin in relation to the sum of oxyhemoglobin and deoxyhemoglobin.
- (3) Perfusion indicator: the pulsatile portion of the measured signal caused by arterial pulsation.
- (4) Pulse rate (derived from the pleth wave): detected pulsations per minute.
- (5) Perfusion index (PI): gives the numerical value for the pulsatile portion of the measured signal caused by arterial pulsation. PI is an indicator of the pulsatile strength. You can also use it to assess the SpO₂ signal strength.

NOTE

- **PI is displayed for Masimo SpO₂.**

10.5 Preparing for SpO₂ Monitoring

To prepare to monitor SpO₂, follow this procedure:

1. Select an appropriate sensor according to the module type, patient category and weight.
2. Clean the contact surface of the reusable sensor.
3. Remove colored nail polish from the application site.
4. Apply the sensor to the patient according to the instruction for use of the sensor.
5. Select an appropriate extension cable according to the connector type and plug the cable into the SpO₂ connector.
6. Connect the sensor to the extension cable.

CAUTION

- **Do not apply sensor too tightly as this results in venous pulsation which may severely obstruct circulation and lead to inaccurate measurements.**
 - **At elevated ambient temperatures, be careful with measurement sites that are not well perfused, because this can cause burns after prolonged application.**
 - **Avoid placing the sensor on extremities with an arterial catheter, an NIBP cuff or an intravascular venous infusion line.**
 - **For neonatal patients, make sure that all sensor connectors and adapter cable connectors are outside the incubator. The humid atmosphere inside can cause inaccurate measurements.**
-

10.6 Changing the SpO₂ Settings

10.6.1 Changing the SpO₂ Alarm Settings

To change the SpO₂ alarm settings, follow this procedure:

1. Select the SpO₂ numeric area or waveform area to enter the **SpO2** dialog.
2. Select the **Alarm** tab.
3. Enter the password if required. For more information, refer to *24.13.3 Selecting Password for User Authentication*.
4. Set the alarm properties as desired.

NOTE

- **The desat alarm is a high level alarm notifying you of potentially life threatening drops in oxygen saturation. When the SpO₂ value is below the desat alarm limit and desat alarm switch is set on, the message "SpO2 Desat" is displayed.**
 - **You can switch off the SpO2 Desat alarm only when you have configured the monitor to allow the SpO2 Desat alarm to be turned off. see section *24.3.4 Setting Guard Limits*.**
-

10.6.2 Nellcor SatSeconds™ Alarm Management

With traditional alarm management, high and low alarm limits are set for monitoring oxygen saturation. During monitoring, once an alarm limit is violated, an audible alarm immediately sounds. When the patient SpO₂ fluctuates near an alarm limit, the alarm sounds each time the limit is violated. Such frequent alarms can be distracting. Nellcor's SatSeconds alarm management technique is used to reduce these nuisance alarms.

The SatSeconds feature is available with the Nellcor SpO₂ to decrease the likelihood of false alarms caused by motion artifacts. With SatSeconds alarm management, high and low alarm limits are set in the same way as those with traditional alarm management. A SatSeconds limit is also set. The SatSeconds limit controls the amount of time that SpO₂ saturation may be outside the set limits before an alarm sounds.

The method of calculation is as follows: the percentage points of the SpO₂ saturation falling outside the alarm limit is multiplied by the number of seconds remaining outside the limit. This can be stated as the equation:

$$\text{SatSeconds} = \text{Points} \times \text{Seconds}$$

Only when the SatSeconds limit is reached, the monitor gives a SatSeconds alarm. For example, the figure below demonstrates the alarm response time with a SatSeconds limit set at 50 and a low SpO₂ limit set at 90%. In this example, the patient SpO₂ drops to 88% (2 points) and remains there for 2 seconds. Then it drops to 86% (4 points) for 3 seconds, and then to 84% (6 points) for 6 seconds. The resulting SatSeconds are:

% SpO ₂	Seconds	SatSeconds
2×	2=	4
4×	3=	12
6×	6=	36
Total SatSeconds=		52

After approximately 11 seconds, a Sat-Second alarm would sound, because the limit of 50 SatSeconds would have been exceeded.

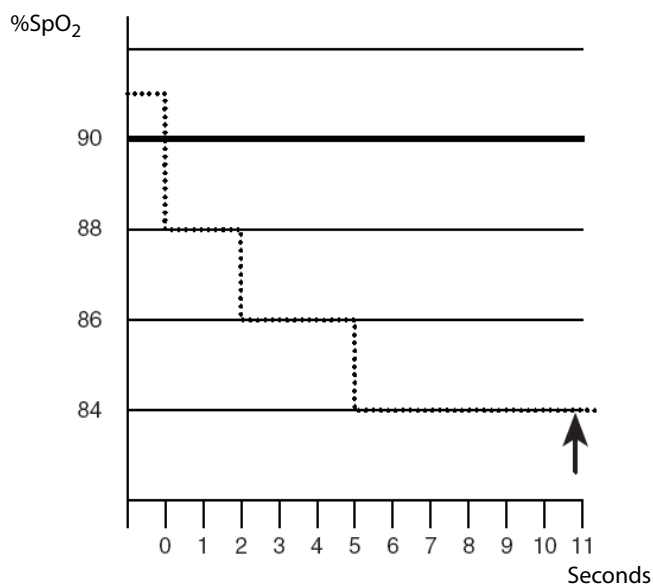

Saturation levels may fluctuate rather than remaining steady for a period of several seconds. Often, the patient SpO₂ may fluctuate above and below an alarm limit, re-entering the non-alarm range several times. During such fluctuation, the monitor integrates the number of SpO₂ points, both positive and negative, until either the SatSeconds limit is reached, or the patient SpO₂ re-enters the non-alarm range and remains there.

NOTE

- **The SpO₂ Too Low or SpO₂ Too High alarm is presented in the case that SpO₂ value violates the alarm limits 3 times within one minute even if the setting of SatSeconds is not reached.**

To set the SatSeconds, follow this procedure:

1. Select the SpO₂ numeric area or waveform area to enter the **SpO₂** dialog.
2. Select the **Alarm** tab.
3. Set **Sat-Seconds**.

10.6.3 Setting SpO₂ Sensitivity (for Masimo SpO₂)

For Masimo SpO₂, select the **Sensitivity** as per signal quality and patient motion.

Normal sensitivity is the recommended for patients who are experiencing some compromise in blood flow or perfusion. It is advisable for care areas where patients are observed frequently, such as the intensive care unit (ICU).

Adaptive Probe Off Detection (APOD) sensitivity is the recommended sensitivity mode where there is a high probability of the sensor becoming detached. It is also the suggested mode for care areas where patients are not visually monitored continuously. This mode delivers enhanced protection against erroneous pulse rate and arterial oxygen saturation readings when a sensor becomes inadvertently detached from a patient due to excessive movement.

Maximum sensitivity is recommended for use on patients with weak signals (e.g. high ambient noise and/or patients with very low perfusion) and for use during procedures or when clinician and patient contact is continuous such as in higher acuity settings.

To set SpO₂ sensitivity, follow this procedure:

1. Select the SpO₂ numeric area or waveform area to enter the **SpO2** dialog.
2. Select the **Setup** tab.
3. Set **Sensitivity** to **Maximum, Normal, or APOD**.

CAUTION

- **When using the Maximum Sensitivity setting, performance of “Sensor Off” detection may be compromised. If the equipment and the sensor becomes detached from the patient, the potential for false readings may occur due to environmental noise such as light, and vibration.**
 - **Configuring the monitor to “Load Latest Configuration” as the default configuration may result in Masimo SpO₂ being set to Maximum sensitivity mode on power up or after admitting a new patient. Maximum sensitivity is recommended for use during procedures or when clinician and patient contact is continuous, such as in higher acuity settings. Maximum sensitivity is not recommended for care areas where patients are not monitored visually as “Sensor Off” detection may be compromised. Refer to Section 6.3 Setting Default Configuration for managing configuration.**
-

10.6.4 Enabling FastSAT (for Masimo SpO₂)

FastSAT enables rapid tracking of arterial oxygen saturation changes as may be required in urgent situations. When FastSAT is switched on, the averaging algorithm evaluates all the SpO₂ values and provides an averaged SpO₂ value that is a better representation of the patient’s current oxygen saturation status.

The reliability of FastSAT is dependent on the setting for the averaging time and the input signal. FastSAT is disabled by default. To enable FastSAT, follow this procedure:

1. Select the SpO₂ numeric area or waveform area to enter the **SpO2** dialog.
2. Select the **Setup** tab.
3. Switch on **FastSAT**.

10.6.5 Displaying SIQ (for Masimo SpO₂)

The signal quality indicator (SIQ) displays below the Pleth waveform. The SIQ is conveyed by vertical bars. The height of the bar provides an assessment of the confidence in the displayed SpO₂ value. The SpO₂ SIQ can also be used to identify the occurrence of a patient’s pulse.

The following picture shows the SpO₂ SIQ:

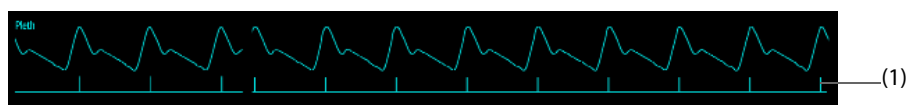

(1) Signal quality indicator (SIQ)

To show SpO₂ SIQ, follow this procedure:

1. Select the SpO₂ numeric area or waveform area to enter the **SpO2** dialog.
2. Select the **Setup** tab.
3. Switch on **Display SIQ**.

10.6.6 Changing Averaging Time (for Masimo SpO₂)

The SpO₂ value displayed on the monitor screen is the average of data collected within a specific time. The shorter the averaging time is, the quicker the monitor responds to changes in the patient’s oxygen saturation level. Contrarily, the longer the averaging time is, the slower the monitor responds to changes in the patient’s oxygen saturation level, but the SpO₂ measurement is more stable. For critically ill patients, selecting a shorter averaging time will help with understanding the patient’s state.

To set the averaging time, follow this procedure:

1. Select the SpO₂ numeric area or waveform area to enter the **SpO2** dialog.
2. Select the **Setup** tab.
3. Set **Averaging**.

10.6.7 Monitoring SpO₂ and NIBP Simultaneously

When monitoring SpO₂ and NIBP on the same limb simultaneously, you can switch on **NIBP Simul** to lock the SpO₂ alarm status until the NIBP measurement ends. If you switch off **NIBP Simul**, low perfusion caused by NIBP measurement may lead to inaccurate SpO₂ readings and therefore cause false physiological alarms.

To set the **NIBP Simul**, follow this procedure:

1. Select the SpO₂ numeric area or waveform area to enter the **SpO2** dialog.
2. Select the **Alarm** tab.
3. Set **NIBP Simul**.

10.6.8 Changing the Sweep Speed of the Pleth Waveform

To set the sweep speed of Pleth waveform, follow this procedure:

1. Select the SpO₂ numeric area or waveform area to enter the **SpO2** dialog.
2. Select the **Setup** tab.
3. Set **Speed**.

10.7 Changing the PR Settings

10.7.1 Changing the PR Alarm Settings

To change the PR alarm settings, follow this procedure:

1. Select the SpO₂ numeric area or waveform area to enter the **SpO2** dialog.
2. Select the **PR** tab.
3. Enter the password if required. For more information see *24.13.3 Selecting Password for User Authentication*.
4. Set the alarm properties as desired.

10.7.2 Changing the QRS Volume

If the **Alarm Source** is set to **PR**, the QRS tone is derived from PR measurements. To set the QRS volume, follow this procedure:

1. Select the SpO₂ numeric area or waveform area to enter the **SpO2** dialog.
2. Select the **PR** tab.
3. Select the **Setup** tab.
4. Set **QRS Volume**.

If the SpO₂ value is valid, the monitor also adjusts the QRS tone (pitch tone) according to the SpO₂ value. For information, see *24.14.4 Setting the SpO₂ Tone Mode*.

NOTE

- **Changing the QRS volume settings in the PR Setup page also changes the QRS volume settings in the Setup page of the ECG dialog.**

10.7.3 Setting the PR Source

Current pulse source is displayed in the PR numeric area if current PR source is not SpO₂. The PR from current pulse source has the following characteristics:

- PR is stored in the monitor's database and can be reviewed in the graphic and tabular trends. In graphic trends, as the PR curve has the same color as that of current PR source.
- PR is sent via the network to the CMS, if available.

To set which parameter is used as a PR source, follow this procedure:

1. Select the SpO₂ numeric area or waveform area to enter the **SpO2** dialog.
2. Select the **PR** tab.
3. Select the **Setup** tab.
4. Set **PR Source**.

The dropdown list of the **PR Source** displays the currently available PR sources from top to bottom by priority. When you select **Auto**, the system will automatically select the first option as the PR source. If the current PR source is unavailable, the system will automatically switch **PR Source** to **Auto**. When you select **IBP**, the system will automatically select the first pressure label as the PR source.

10.7.4 Showing/Hiding PR

You can set whether to display the PR value in the SpO₂ parameter area. To do so, follow this procedure:

1. Select the SpO₂ numeric area or waveform area to enter the **SpO2** menu.
2. Select the **PR** tab.
3. Select the **Setup** tab.
4. Switch on or off **Display PR**.

10.8 Displaying SpO₂ Statistics

You can show SpO₂ statistics for a defined period of time on the normal screen and the Target Goal screen.

To display SpO₂ statistics on the normal screen, follow this procedure:

1. Access the **Tile Layout** in either of the following ways:
 - ◆ Select the **Screen Setup** quick key → select the **Tile Layout** tab.
 - ◆ Select the **Main Menu** quick key → from the **Display** column select **Tile Layout**.
2. Select the parameter numeric area where you want to display SpO₂ statistics, and then from the popup list select **SpO2** → **SpO2 Statistics**.

For details on displaying SpO₂ statistics on the Target Goal screen, see *4.7.3 Configuring the Targeted Goal Screen Layout*.

Operations of setting SpO₂ statistics on the normal screen and the Target Goal screen are the same. For details, see *4.7.4 Setting Parameter Statistics*, *4.7.5 Selecting the Range of Each Parameter Section and the Target Section* and *4.7.6 Selecting the Statistics Duration of the Target Parameter*.

10.9 SpO₂ Troubleshooting

This section lists the problems that might occur. If you encounter the problems when using the equipment or accessories, check the table below before requesting service. If the problem persists, contact your service personnel.

NOTE

- For the physiological and technical alarm messages, see **Appendix D Alarm Messages**.

Problem	Solution
Do not see SpO ₂ numeric area or waveform area on the main screen	<ol style="list-style-type: none"> 1. Check that the SpO₂ is set to display in the Screen Setup → Tile Layout page. For more information, see 3.9.2 <i>Displaying Parameter Numerics and Waveforms</i>. 2. Check that the SpO₂ parameter switch is enabled. If not, enable the SpO₂ measurement. For more information, see 3.9.1 <i>Switching On or Off a Parameter</i>. 3. Check that the cable connections of the SpO₂ sensor and the extension cable are tight. Replace the SpO₂ sensor or the extension cable if needed.
Dashes “- -” display in place of numerics	<ol style="list-style-type: none"> 1. Check that the cable connections of SpO₂ sensor and the extension cable are tight. Replace the SpO₂ sensor or the extension cable if needed. 2. Reconnect the SpO₂ sensor if the alarm SpO2 Sensor Off appears. 3. Check the PI value. If the PI value is too low, adjust the SpO₂ sensor, or apply the sensor to a site with better perfusion. 4. Move the sensor to a place with weaker ambient light, or cover the sensor to minimize the ambient light if the alarm SpO2 Too Much Light appears.
Low amplitude SpO ₂ signal	<ol style="list-style-type: none"> 1. The SpO₂ sensor and NIBP cuff are placed on the same limb. Change the monitoring site if necessary. 2. Check the PI value. If the PI value is too low. Adjust the SpO₂ sensor, or apply the sensor to a site with better perfusion.
SpO ₂ value is inaccurate	<ol style="list-style-type: none"> 1. Check the patient’s vital signs. 2. Check for conditions that may cause inaccurate SpO₂ readings. For more information, see 10.3 <i>SpO₂ Measurement Limitations</i>. 3. Check the monitor or the SpO₂ module for proper functioning.

10.10 Nellcor Information



Nellcor Patents

This posting serves as notice under 35 U.S.C.§287(a) for Covidien patents: <http://www.covidien.com/patents>.

No Implied License

Possession or purchase of this device does not convey any express or implied license to use the device with unauthorized replacement parts which would, alone, or in combination with this device, fall within the scope of one or more of the patents relating to this device.

10.11 Masimo Information



Masimo Patents

This posting serves as notice under 35 U.S.C.§287(a) for Masimo patents: <http://www.masimo.com/patents.htm>.

No Implied License

Possession or purchase of this device does not convey any express or implied license to use the device with unauthorized sensors or cables which would, alone, or in combination with this device, fall within the scope of one or more of the patents relating to this device.

10.12 Masimo End-User License Agreement

THIS DOCUMENT IS A LEGAL AGREEMENT BETWEEN YOU ("PURCHASER") AND SHENZHEN MINDRAY. IF YOU DO NOT AGREE TO THE TERMS OF THIS AGREEMENT, PROMPTLY RETURN THE ENTIRE PACKAGE, INCLUDING ALL ACCESSORIES, IN THEIR ORIGINAL PACKAGE, WITH YOUR SALES RECEIPT TO SHENZHEN MINDRAY FOR A FULL REFUND.

1. **Grant of License.** In consideration of payment of the license fee, which is part of the price paid for this product, Shenzhen Mindray grants to Purchaser a nonexclusive, nontransferable license, without right to sublicense, to use the copy of the incorporated software/firmware, and documentation in connection with Purchaser's use of the Masimo Products for their labeled purpose. Shenzhen Mindray reserves all rights not expressly granted to Purchaser.
2. **Ownership of Software/Firmware.** Title to, ownership of, and all rights and interests in, any Masimo software and/or firmware and the documentation, and all copies thereof, remain at all times vested in Masimo Corporation, licensor to Shenzhen Mindray, and they do not pass to Purchaser.
3. **Assignment.** Purchaser shall not assign or transfer this License, in whole or in part, by operation of law or otherwise, without Shenzhen Mindray's prior written consent; any attempt without such consent, to assign any rights, duties or obligations arising hereunder shall be void.
4. **Copy Restrictions.** The software/firmware, mask works, circuit board layouts, and accompanying written materials are copyrighted. Unauthorized copying of the software, including software that has been modified, merged, or included with other software, or other written materials is expressly forbidden. You may be held legally responsible for any copyright infringement that is cause or incurred by your failure to abide by the terms of this license. Nothing in this license provides any rights beyond those provided by 17 U.S.C. §117.
5. **Use Restriction.** As the Purchaser, you may physically transfer the products from one location to another provided that the software/firmware is not copied. You may not electronically transfer the software/firmware from the products to any other device. You may not disclose, publish, translate, release distribute copies of, modify, adapt, translate, reverse engineer, decompile, disassemble, or create derivative works based on the Masimo Product, the software/firmware, or the written materials without the prior written consent of Masimo. Masimo Sensors that are designated for single use are licensed under Masimo patents for use on a single patient only, and are not sold. There is no license, implied or otherwise, that would allow use of single use Masimo Sensors beyond their intended single use. After use of single use Masimo Sensors, there is no further license granted by Masimo to use the sensors and they must be discarded.
6. **Transfer Restrictions.** The software/firmware is licensed to the Purchaser, and may not be transferred to anyone, except other end-users, without the prior written consent of Shenzhen Mindray. In no event may you transfer, assign, rent, lease, sell, or otherwise dispose of the software/firmware or the products on a temporary basis.
7. **Beneficiary.** Masimo Corporation is a Beneficiary of this Agreement and has the right to enforce its provisions.

U.S. Government Rights: If you are acquiring software (including the related documentation) on behalf of any part of the United States Government, the following provisions apply: the software is deemed to be "commercial software" and "commercial computer software documentation," respectively pursuant to DFAR Section 227.7202 FAR 12.212, as applicable. Any use, modification, reproduction, release, performance, display or disclosure of the software (including the related documentation) by the U.S. Government or any of its agencies shall be governed solely by the terms of this Agreement and shall be prohibited except to the extent expressly permitted by the terms of this agreement.

11 Monitoring Temperature (Temp)

11.1 Temperature Introduction

The monitor can continuously monitor the patient's skin temperature and core temperature. Thermally sensitive resistors (thermistors) are used, and are based on the principle that electrical resistance of the thermistor changes as temperature changes. The resistance change of the thermistors is used to calculate the temperature.

Up to two temperature sites can be monitored simultaneously and the difference between two measured sites is calculated.

Temperature monitoring is intended for adult, pediatric and neonatal patients.

11.2 Temperature Safety Information

CAUTION

- **Verify that the probe detection program works correctly before monitoring. Remove the temperature probe cable from the temperature probe connector, and check that the monitor can display the alarm messages and give alarm tones correctly.**

11.3 Temperature Display

The following figure shows the Temp numeric area for temperature monitoring. Your display may be configured to look different.

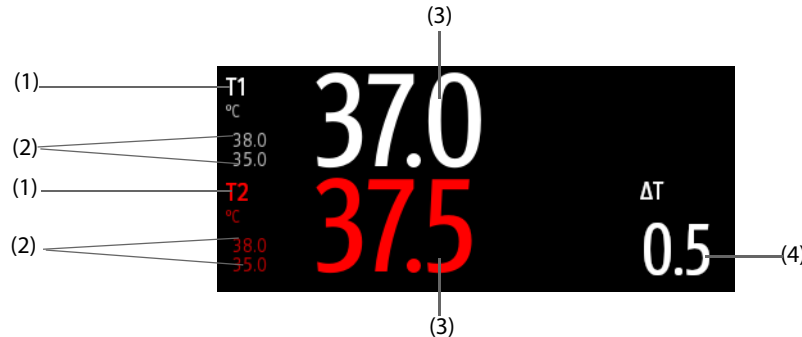

(1) Temperature site

(2) Temperature alarm limits

(3) Temperature value

(4) Temperature difference (ΔT): Difference between two temperature sites. It displays only when ΔT is switched on.

11.4 Preparing for Temperature Monitoring

To prepare temperature monitoring, follow this procedure:

1. Select an appropriate probe for your patient according to patient category and measured site.
2. Plug the probe or temperature cable to the temperature connector. If using a disposable probe, connect the probe to the temperature cable.
3. Follow the probe manufacturer's instructions to connect the probe to the patient.

11.5 Changing Temperature Settings

11.5.1 Setting the Temperature Alarm Properties

To set the temperature alarm properties, follow this procedure:

1. Select the temperature numeric area to enter the **Temp** dialog.
2. Select the **Alarm** tab.
3. Enter the password if required. For more information, see 24.13.3 *Selecting Password for User Authentication*.
4. Set the alarm properties as desired.

11.5.2 Selecting the Temperature Label

Select the temperature label according to the measurement site. To do so, follow this procedure:

1. Select the temperature numeric area to enter the **Temp** dialog.
2. Select the **Setup** tab.
3. Set the temperature label.

Label	Description	Label	Description
T1	Temperature of application site 1	T amb	Ambient temperature
T2	Temperature of application site 2	T airw	Airway temperature
T skin	Skin temperature	T vesic	Vesical temperature
T core	Core temperature	T blood	Blood temperature
T axil	Axillary temperature	T myo	Myocardial temperature
T naso	Nasopharyngeal temperature	T tymp	Tympanic temperature
T eso	Esophageal temperature	T cereb	Cerebral temperature
T rect	Rectal temperature		

11.5.3 Displaying the Temperature Difference

To display the temperature difference between two measurement sites, switch on ΔT . To do so, follow this procedure:

1. Select the temperature numeric area to enter the **Temp** dialog.
2. Select the **Setup** tab.
3. Switch on ΔT .

11.6 Temperature Troubleshooting

This section lists the problems that might occur. If you encounter the problems when using the equipment or accessories, check the table below before requesting service. If the problem persists, contact your service personnel.

NOTE

- For the physiological and technical alarm messages, see **Appendix D Alarm Messages**.

Problem	Solution
Do not see Temp numeric area on the main screen	<ol style="list-style-type: none"> 1. Check that if the Temp parameter switch is enabled. If not, enable the Temp measurement. For more information, see <i>3.9.1 Switching On or Off a Parameter</i>. 2. Check that the connections of the temperature probe and the temperature cable are tight.
Measurement fails/“--” is displayed in the Temp numeric area	<ol style="list-style-type: none"> 1. If using a disposable probe, check the connection between the probe and the temperature cable. 2. Try using a known good probe in case the sensor is damaged.

This page intentionally left blank.

12 Monitoring Noninvasive Blood Pressure (NIBP)

12.1 NIBP Introduction

The monitor uses the oscillometric method for measuring Non-Invasive Blood Pressure (NIBP). NIBP measurement is based on the principle that pulsatile blood flow through an artery creates oscillations of the arterial wall. The oscillometric device uses a blood pressure cuff to sense these oscillations that appear as tiny pulsations in cuff pressure. The oscillometric devices measure the amplitude of pressure changes in the occluding cuff as the cuff deflates from above systolic pressure. The amplitude suddenly increases as the pulse breaks through the occlusion in the artery. As the cuff pressure decreases further, the pulsations increase in amplitude, reach a maximum (which approximates to the mean pressure), and then diminish. The oscillometric method measures the mean pressure and determines the systolic and diastolic pressures.

NIBP monitoring is intended for adult, pediatric, and neonatal patients.

NOTE

- **Blood pressure measurements determined with this device are equivalent to those obtained by a trained observer using the cuff/stethoscope auscultatory method or an intra-arterial blood pressure measurement device, within the limits prescribed by the American National Standard: manual, electronic, or automated sphygmomanometers.**
- **NIBP measurement can be performed during electro-surgery and discharge of a defibrillator.**

12.2 NIBP Safety Information

WARNING

- **Be sure to select the correct patient category setting for your patient before NIBP measurement. Do not apply the higher adult settings for pediatric or neonatal patients. Otherwise, it may present a safety hazard.**
- **Do not measure NIBP on patients with sickle-cell disease or on the limb where skin damage has occurred or is expected.**
- **Use clinical judgment to determine whether to perform frequent unattended blood pressure measurements on patients with severe blood clotting disorders because of the risk of hematoma in the limb fitted with the cuff.**
- **Do not use the NIBP cuff on a limb with an intravenous infusion or arterial catheter in place. This could cause tissue damage around the catheter when the infusion is slowed or blocked during cuff inflation.**
- **Do not apply cuff on the arm on the side of a mastectomy or lymph node clearance.**
- **Continuous cuff pressure due to connection tubing kinking may cause blood flow interference and result in harmful injury to the patient.**
- **NIBP reading can be affected by the measurement site, the position of the patient, exercise, or the patient's physiologic condition. If you doubt the NIBP measurements, determine the patient's vital signs by alternative means, and then verify that the monitor is working correctly.**
- **Devices that exert pressure on tissue have been associated with purpura, ischemia, and neuropathy. Inspect the application site regularly to ensure skin quality and inspect the extremity of the cuffed limb for normal color, warmth and sensitivity. If the skin quality changes, or if the extremity circulation is being affected, move the cuff to another site or stop the blood pressure measurements immediately. Check more frequently when making automatic or STAT measurements. Auto NIBP measurements with one and two minute intervals are not recommended for extended periods of time.**
- **Do not modify or replace connectors of the NIBP air hose except with mindray-approved connectors. Use neonatal and infant cuffs with CM1901 hoses only. Use pediatric/adult cuffs with CM1903 hoses only.**

- **Never connect intra-arterial or intra-venous lines, or any other incompatible connectors to the NIBP hose. This can cause serious injury or death.**
 - **NIBP diagnostic significance must be decided by the hospital's clinician staff.**
-
-

CAUTION

- **Measuring NIBP on patients connected to an Intra Aortic Balloon Pump (IABP) machine may result in the NIBP measurement, including PR, to be inaccurate or fail.**
 - **Only use parts and accessories specified in this manual. Follow the instructions for use and adhere to all warnings and cautions.**
 - **Accuracy of NIBP measurement depends on using a cuff of proper size. It is essential to measure limb circumference and choose a cuff with proper size.**
-

12.3 NIBP Measurement Limitations

Measurements are impossible with heart rate extremes of less than 30 bpm or greater than 300 bpm, or if the patient is on a heart-lung machine. The measurement may be inaccurate or impossible in the following situations:

- Regular arterial pressure pulses are hard to detect
- Excessive and continuous patient movement such as shivering or convulsions
- Cardiac arrhythmias
- Rapid blood pressure changes
- Severe shock or hypothermia that reduces blood flow to the peripheries
- On an edematous extremity
- Obesity, where a thick layer of fat surrounding a limb dampens the oscillations coming from the artery

NOTE

- **The effectiveness of this sphygmomanometer has not been established in pregnant women, including pre-eclamptic patients.**
-

12.4 Measurement Modes

The monitor provides the following NIBP measurement modes:

- Manual: measurement on demand.
- Auto: repeated measurements at set interval.
- STAT: continual rapid series of measurements over a five-minute period.
- Sequence: continually automatic measurement at set durations and intervals.

12.5 NIBP Display

The NIBP display shows only numerics.

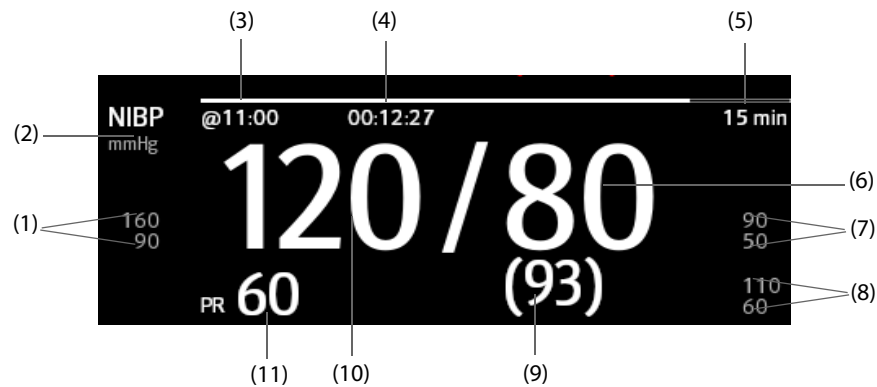

- (1) Systolic pressure alarm limits (2) NIBP unit: mmHg or kPa (3) The last NIBP measurement time
- (4) Time to the next measurement (for Auto mode and Sequence mode)
- (5) Measurement mode: for Auto NIBP, interval is displayed; for Sequence mode, the current phase and interval are displayed
- (6) Diastolic pressure (7) Diastolic pressure alarm limits (8) Mean pressure alarm limits
- (9) Mean pressure (displayed after measurement completed) or cuff pressure (displayed during the measurement)
- (10) Systolic pressure (11) Pulse Rate

NOTE

- If NIBP measurement fails, "XX" is displayed; if NIBP measurement is not taken or NIBP measurement exceeds its measurement ranges, "--" is displayed.
- NIBP numerics in black color with a light outline indicate that the measurement is old and exceeds the configured NIBP Measurement Timeout time (see 24.5.10 Setting Parameter Measurement Timeout). These NIBP values are not recommended for reference.

12.6 Preparing for NIBP Measurements

12.6.1 Preparing the Patient for NIBP Measurements

In normal use, perform NIBP measurement on a patient who is in the following position:

- Comfortably seated
- Legs uncrossed
- Feet flat on the floor
- Back, arm and feet supported

NOTE

- It is recommended that the patient remains calm and relaxes as much as possible before performing the measurement and that the patient does not talk during the measurement.
- Other factors that have been shown to result in an overestimation of blood pressure are labored breathing, full bladder, pain etc.

12.6.2 Placing the NIBP Cuff

To place the NIBP cuff, follow this procedure:











1. Verify that the patient category setting is correct.
2. Connect the air tubing to the NIBP connector.
3. Select an appropriately sized cuff for the patient, and then wrap it around the limb directly over the patient's skin as follows:
 - a Determine the patient's limb circumference.
 - b Select an appropriate cuff by referring to the limb circumference marked on the cuff. The width of the cuff should be 40% (50% for neonates) of the limb circumference, or 2/3 of the length of the upper arm or the thigh. The inflatable part of the cuff should be long enough to overlap at least 50% to 80% of the limb.
 - c Apply the cuff to the patient's upper arm or leg and make sure the Φ marking on the cuff matches the artery location. The cuff should fit snugly, but with enough room for two fingers to be placed between the cuff and the patient's arm (on adults), and loosely on neonates with little or no air present within the cuff. Otherwise it may cause discoloration and ischemia of the extremities. Make sure that the cuff index line falls within the range markings on the cuff. If it does not, use a cuff that fits better.
 - d Middle of the cuff should be at the level of the right atrium of the heart. If it is not, use the measurement correction formula to correct the measurement. For more information, see 12.9.7 *Setting the NIBP Display Format*.
4. Connect the cuff to the air tubing. Avoid compression or restriction of pressure tubes. Air must pass unrestricted through the tubing.

CAUTION

- **Do not touch or apply external pressure against the cuff and air tubing during NIBP measurement. This may cause inaccurate blood pressure values.**
- **Use care when placing the cuff on an extremity used for monitoring other patient parameters.**

12.7 Starting and Stopping NIBP Measurements

Start and stop NIBP measurement by selecting the NIBP quick keys or from the NIBP dialog.

Task	By Quick Key	From NIBP dialog
Start a manual measurement	NIBP Start/Stop quick key 	Start NIBP button
Start auto NIBP series	NIBP Start/Stop quick key 	Setup tab → set Interval → Start NIBP button
	NIBP Measure quick key  → select Interval	
Start NIBP sequence measurement	NIBP Measure quick key  → Sequence	Sequence tab → set NIBP sequence → Start NIBP button
Start STAT measurement	NIBP STAT quick key 	STAT button
	IBP Measure quick key  → STAT	
Stop the current NIBP measurements	NIBP Start/Stop quick key 	Stop NIBP button
End auto NIBP series or NIBP Sequence	NIBP Stop All quick key 	NIBP Stop All button
Stop STAT measurement and end series	NIBP Start/Stop quick key 	Stop NIBP or NIBP Stop All button
	NIBP Stop All quick key 	

12.8 Viewing NIBP Analysis

NIBP analysis provides a dynamic analysis of NIBP changes and distribution over the time scale. It provides information on the patient's condition over the latest 24 hours before entering the NIBP Analysis window.

To view NIBP analysis, follow this procedure:

1. Select the NIBP numeric area to enter the **NIBP** menu.
2. Select the **Analysis >>** tab.

You can also select anywhere in the **NIBP Analysis** window to enter the tabular trends review page. For more information, see *17 Review*.

12.9 Changing NIBP Settings

12.9.1 Setting the NIBP Alarm Properties

To set the NIBP alarm properties, follow this procedure:

1. Select the NIBP numeric area to enter the **NIBP** dialog.
2. Select the **Alarm** tab.
3. Enter the password if required. For more information, see *24.13.3 Selecting Password for User Authentication*.
4. Set the alarm properties as desired.

12.9.2 Setting the Initial Cuff Inflation Pressure

To set initial cuff inflation pressure, follow this procedure:

1. Select the NIBP numeric area to enter the **NIBP** dialog.
2. Select **Initial Pressure**, and then select the appropriate setting.

NOTE

- **For known hypertensive patients, you need to set initial cuff pressure to a higher value to reduce the measurement time.**
-

12.9.3 Setting the NIBP Interval

For auto NIBP measurement, you need to set the interval between two NIBP measurements. To set the NIBP interval, follow this procedure:

1. Select the NIBP numeric area to enter the **NIBP** dialog.
2. Set **Interval**. Selecting **Manual** switches to manual mode.

NOTE

- **NIBP Measure dialog gives quick access to starting and setting the interval. Selecting an option from the NIBP Measure dialog will change the NIBP interval to that selection and start the NIBP measurement.**
-

12.9.4 Selecting NIBP Start Mode

Start mode defines how future NIBP measurements are initiated with automatic measurement mode. To set the start mode, follow this procedure:

1. Select the NIBP numeric area to enter the **NIBP** dialog.
2. Select **Start Mode**.
 - ◆ **Clock:** after the first measurement, the monitor automatically synchronizes NIBP automatic measurements with the real time clock. For example, if **Interval** is set to **20 min**, and NIBP auto

measurement is started at 14:03, the next measurement will be taken at 14:20, and then at 14:40, 15:00, and so on.

- ◆ **Interval:** after the first measurement, the monitor automatically repeats measurements at set interval. For example, if **Interval** is set to **20 min**, and NIBP auto measurement is started at 14:03, the next measurement will be taken at 14:23, and then at 14:43, 15:03, and so on.

12.9.5 Enabling the NIBP End Tone

The monitor can issue a reminder tone at the completion of NIBP measurement. The NIBP End Tone is off by default. To switch on the NIBP end tone, follow this procedure:

1. Select the NIBP numeric area to enter the **NIBP** dialog.
2. Switch on **NIBP End Tone**.

12.9.6 Setting NIBP Sequence

NIBP sequence measurement can have up to five phases: A, B, C, D, and E. The duration and interval of each phase can be set individually.

To set NIBP sequence, follow this procedure:

1. Select the NIBP numeric area to enter the **NIBP** dialog.
2. Select the **Sequence** tab.
3. Set **Duration** and **Interval** of each phase.

12.9.7 Setting the NIBP Display Format

To set the NIBP display format, follow this procedure:

1. Select the NIBP numeric area to enter the **NIBP** menu.
2. Select the **Setup** tab.
3. Set **Display Format**.

12.9.8 Setting the NIBP Alarm Limits Display Switch

To set whether to display the alarm limits of diastolic NIBP and mean NIBP, follow this procedure:

1. Select the NIBP numeric area to enter the **NIBP** menu.
2. Select the **Setup** tab.
3. Switch on or off **Display Alarm Limits**.

12.9.9 Showing/Hiding PR

You can set whether to display the PR value in the NIBP parameter area. To do so, follow this procedure:

1. Select the NIBP numeric area to enter the **NIBP** menu..
2. Select the **Setup** tab.
3. Switch on or off **Display PR**.

12.9.10 Correcting the NIBP Measurements

The middle of the cuff should be at the level of right atrium. If the limb is not at the heart level, the measurement should be corrected as follows:

- Add 0.75 mmHg (0.10 kPa) to the displayed value for each centimetre higher.
- Deduct 0.75 mmHg (0.10 kPa) to the displayed value for each centimeter lower.

12.10 Assisting Venous Puncture

You can use the NIBP cuff to cause sub-diastolic pressure to block the venous blood vessel and therefore help venous puncture. To assist venous puncture, follow this procedure:

1. Select the **VeniPuncture** quick key or select the NIBP numeric area → **Setup** tab.
2. Set **Venipuncture Pressure**.
3. Select **VeniPuncture** at the bottom of the dialog.
4. Puncture vein and draw blood sample.
5. Select the **NIBP Start/Stop** quick key to deflate the cuff. If the cuff is not manually deflated, the cuff automatically deflates after a fixed period of time (170 seconds for adult and pediatric patient, 85 seconds for neonatal patient).

During venous puncture, pay attention to the cuff pressure and the remaining time displayed in the NIBP numerics area.

12.11 NIBP Troubleshooting

This section lists the problems that might occur. If you encounter the problems when using the equipment or accessories, check the table below before requesting for services. If the problem persists, contact your service personnel.

NOTE

- For the physiological and technical alarm messages, see **Appendix D Alarm Messages**.

Problem	Solution
Cannot see NIBP numeric area on the main screen	<ol style="list-style-type: none">1. Check that the NIBP is set to display in the Screen Setup → Tile Layout page. For more information, see <i>3.9.2 Displaying Parameter Numerics and Waveforms</i>2. Check that if the NIBP parameter switch is enabled. If not, enable the NIBP measurement. For more information, see <i>3.9.1 Switching On or Off a Parameter</i>.

This page intentionally left blank.

13 Monitoring Invasive Blood Pressure (IBP)

13.1 IBP Introduction

IBP monitoring is intended for adult, pediatric, and neonatal patients. PAWP monitoring is only intended for adult and pediatric patients.

You can monitor up to 4 invasive blood pressures (using the built-in IBP module and the external IBP module together).

The following picture shows the external IBP module.

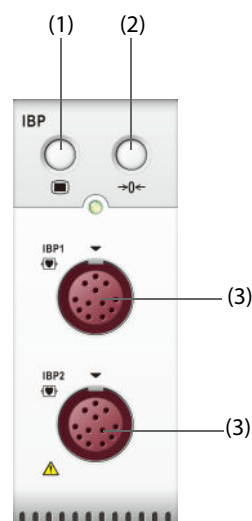

(1) IBP dialog hard key

(2) Zero IBP hard key

(3) IBP cable connector

13.2 IBP Safety Information

WARNING

- **Use only pressure transducers specified in this manual. Never reuse disposable pressure transducers. See chapter 28 Accessories for specified pressure transducers.**
 - **Make sure that the applied parts never contact other conductive parts.**
 - **To reduce the hazard of burns during high-frequency surgical procedures, ensure that the monitor's cables and transducers never come into contact with the high-frequency surgical units.**
 - **When using accessories, their operating temperature should be taken into consideration. For more information, see instructions for use of accessories.**
 - **All invasive procedures involve risks to the patient. Use aseptic technique. Follow catheter manufacturer's instructions.**
 - **Mechanical shock to the invasive blood pressure transducer may cause severe shifts in zero balance and calibration, and cause erroneous readings.**
 - **The neutral electrode of the electro-surgery unit (ESU) shall properly contact the patient. Otherwise, burns may result.**
-

CAUTION

- **Measuring IBP on patients connected to an Intra Aortic Balloon Pump (IABP) machine may result in the IBP measurement, including PR, to be inaccurate or fail.**
-

13.3 Preparing for IBP Monitoring

13.3.1 IBP Equipment to Patient Connection

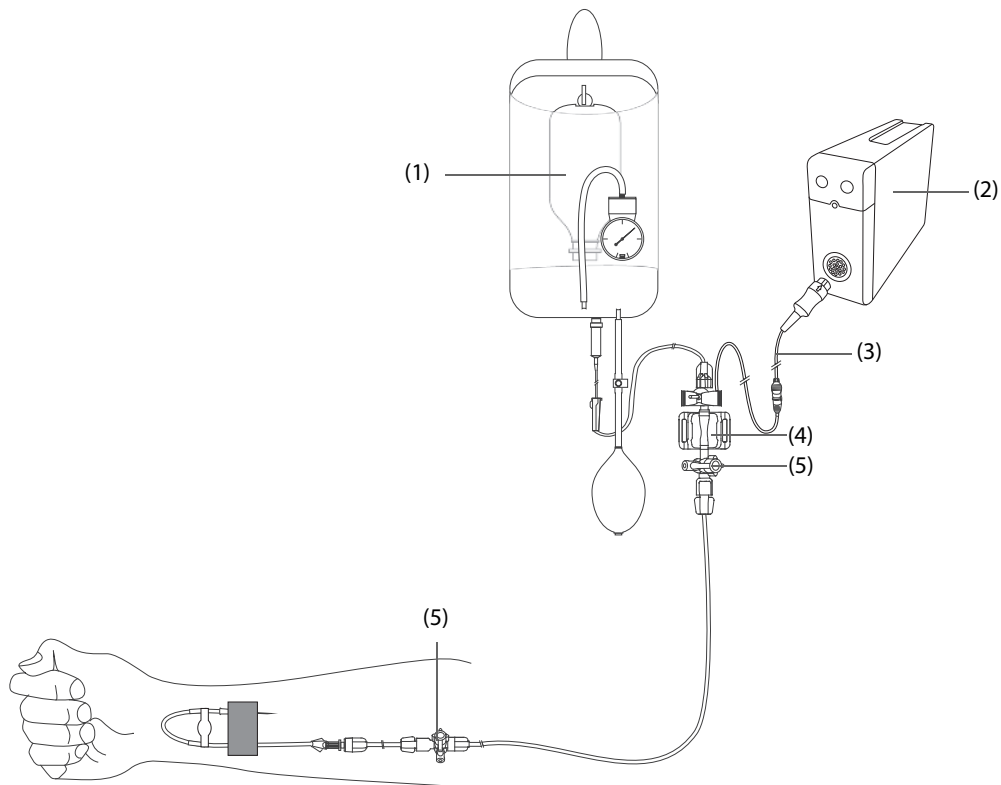

(1) Pressure bag

(2) IBP module

(3) IBP cable

(4) IBP transducer

(5) Three-way valve

13.3.2 Measuring an Invasive Blood Pressure

To monitor IBP, follow this procedure:

1. Connect one end of the IBP cable to the IBP cable connector, and the other end to the IBP transducer.
2. Flush the IBP transducer system to exhaust all air from the tubing according to the manufacturer's instructions. Ensure that the system is free of air bubbles.
3. Connect the IBP transducer to the patient, making sure that the transducer is at the same horizontal level as the heart.
4. Select the proper pressure label for currently measured pressure. For more information, see [13.6.2 Changing the Pressure Label](#).
5. Zero the IBP transducer. For more information, see [13.3.3 Zeroing the IBP transducer](#). After a successful zeroing, turn off the three-way valve to the air and turn on the three-way valve to the patient.

CAUTION

- **Make sure that all the transducers are zeroed correctly before making IBP measurements.**
 - **Make sure that all air bubbles have been flushed from the IBP transducer system before making IBP measurements.**
 - **If measuring intracranial pressure (ICP) with a sitting patient, level the transducer with the top of the patient's ear. Incorrect leveling may give incorrect values (not applicable if measuring ICP with the Codman ICP transducer).**
-

13.3.3 Zeroing the IBP transducer

To avoid inaccurate pressure readings, the monitor requires a valid zero. Zero the transducer in accordance with your hospital policy. The IBP transducer should be zeroed in the following conditions:

- The IBP transducer, adapter cable or module is reconnected.
- The monitor restarts.
- The readings are in doubt.
- The monitor displays the prompt message **Zero Required**.

To zero the transducer, follow this procedure:

1. Connect the IBP transducer, the IBP adapter cable and the monitor.
2. Turn off the three-way valve (the one near the transducer) to the patient, in order to vent the transducer to the atmospheric pressure.
3. Zero the transducer by one of the following methods:
 - ◆ Press the **Zero** hard key on the module. In the **Zero IBP** dialog, select to zero an IBP, or select to zero all IBP.
 - ◆ Select the numeric area (such as the Art numeric area), and then select **Zero** button.
 - ◆ Select the **Zero IBP** quick key. In the **Zero IBP** dialog, select to zero an IBP, or select to zero all IBP.
4. After the zero calibration is completed, close the three-way valve to the air and open the three-way valve to the patient.

Zero calibration may fail in case of pressure fluctuation or pressure exceeding the calibration range. If zero calibration fails, follow this procedure:

1. Check that the three-way valve (the one near the transducer) is open to the air.
2. Perform zero calibration again. Do not sway the IBP transducer and tubing during zero calibration.

13.4 Measuring ICP Using the Codman ICP Transducer

13.4.1 Zeroing the Codman ICP transducer

The Codman ICP transducer (Model: 82-6653) must be zeroed before use. To zero the ICP transducer, follow this procedure:

1. Connect the ICP transducer, the ICP adapter cable and the monitor.
2. Follow the manufacturer's instructions to prepare the ICP transducer.
3. Zero the ICP transducer: when the message **Zero Reference** is displayed in the ICP numeric area, select the ICP waveform area or numeric area to enter the **ICP** dialog → select the **Zero** tab → select the **Zero** button.
4. Record the zero reference value on the blank area of the ICP transducer for reference.

If the ICP transducer zero calibration failed or the zero reference value is in doubt, perform the zero calibration again.

13.4.2 Measuring ICP

To perform the ICP measurement, follow this procedure:

1. Zero the Codman ICP transducer. For more information, see section *13.4.1 Zeroing the Codman ICP transducer*.
2. Disconnect the ICP transducer and ICP adapter cable. Follow the manufacturer's instructions to apply the ICP transducer to the patient.
3. Reconnect the ICP transducer and ICP adapter cable.
4. Check that the zero reference value displayed on the monitor is consistent with that recorded on the ICP transducer.
 - ◆ Consistent: select **Accept**.
 - ◆ Inconsistent: input the zero reference value recorded on the ICP transducer, and select **Accept**.

If the patient being monitored for ICP must be transported, check that the target monitor supports the Codman ICP transducer. For more information, see 13.4.1 *Zeroing the Codman ICP transducer*. If the target monitor does not support the Codman ICP transducer, do not use it for ICP monitoring.

If the target monitor supports the Codman ICP transducer, follow this procedure to transport the patient:

1. Disconnect the ICP adapter cable from the measurement module, or remove the module from the monitor.
2. Connect the ICP adapter cable, measurement module, and the target monitor, or insert the measurement module into the target monitor.
3. Check that the zero reference value displayed on the monitor is consistent with that recorded on the ICP transducer.
 - ◆ Consistent: select **Accept**.
 - ◆ Inconsistent: input the zero reference value recorded on the ICP transducer, and select **Accept**.

CAUTION

- **If monitors of different brands are used to zero the Codman ICP transducer, the zero reference values can be different. Use a Mindray monitor to Zero the Codman ICP transducer if you will take ICP measurement using a Mindray monitor. Otherwise the ICP measurement could be inaccurate.**
-

13.5 IBP Display

The IBP measurement is displayed on the monitor as a waveform and numeric pressures. For arterial pressure, the IBP numeric area displays systolic pressure, diastolic pressure and mean pressure. For venous pressure, the IBP numeric area displays only the mean pressure. The figure below shows the waveform and numerics for the Art pressure.

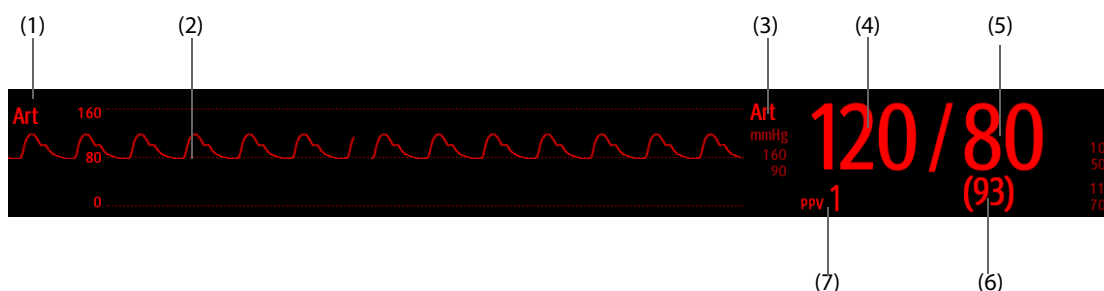

- | | |
|------------------------|-----------------------|
| (1) Pressure label | (2) Waveform |
| (3) Pressure Unit | (4) Systolic pressure |
| (5) Diastolic pressure | (6) Mean pressure |
| (7) PPV measurement | |

For some pressures, the parameter window may show the mean pressure only. For different pressures, their defaults unit may be different. If the Art and ICP pressures are measured simultaneously, the ICP parameter area will display numeric CPP, which is obtained by subtracting ICP from the Art mean.

13.5.1 Overlapping IBP Waveforms

The IBP waveforms can be displayed together. To combine IBP waveforms, follow this procedure:

1. Access **Tile Layout** by either of the following ways:
 - ◆ Select the **Screen Setup** quick key → select the **Tile Layout** tab.
 - ◆ Select **Main Menu** quick key → from the **Display** column select **Tile Layout**.
2. Select the waveform area where you want to display the overlapped IBP waveforms, and then select the IBP waves to be overlapped on the left side of the same line.
3. Repeat step 2 in another waveform area if needed.
4. Select  to save the setting and exit the screen. The main screen will display the overlapped IBP waves.

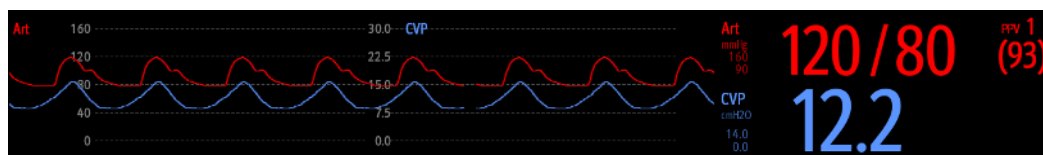

Selecting the overlapped IBP waveforms on the main screen opens the **Overlapping Waveform Setup** dialog, where you can make the following settings:

- Scale
 - ◆ Set **Left Scale** for the arterial pressure.
 - ◆ Set **Right Scale** for the venous pressure.
 - ◆ Set **CVP Scale** individually if the CVP waveform is combined and CVP unit is different from IBP unit.
 - ◆ Set **ICP Scale** individually if the ICP waveform is combined and ICP unit is different from IBP unit.
 - ◆ Set **PA Scale** individually if the PA waveform is combined.
- Switch on or off **Gridlines** to show or hide gridlines in the overlapped waveform area.
- Set **Speed** for the overlapped waveforms.

NOTE

- The unit of CVP scale is consistent with the CVP parameter unit.

13.6 Changing IBP Settings

13.6.1 Changing the IBP Alarm Settings

To change the IBP alarm settings, follow this procedure:

1. Select the IBP numeric area or waveform area to enter the corresponding pressure dialog.
2. Select the **Alarm** tab.
3. Enter the password if required. For more information, see 24.13.3 *Selecting Password for User Authentication*.
4. Set the alarm properties of pressure.

13.6.2 Changing the Pressure Label

The pressure label is a unique identifier for each type of pressure. Therefore, it is recommended to select the proper pressure label for the source of the pressure being monitored.

To select the pressure label, follow this procedure:

1. Select the IBP numeric area or waveform area to enter the corresponding pressure dialog.
2. Select the **Setup** tab.
3. Set **IBP1 Label** or **IBP2 Label**.

Label	Description	Label	Description
Art	Arterial blood pressure	PA	Pulmonary artery pressure
Ao	Aortic pressure	UAP	Umbilical arterial pressure
BAP	Brachial arterial pressure	FAP	Femoral arterial pressure
CVP	Central venous pressure	LAP	Left atrial pressure
RAP	Right atrial pressure	ICP	Intracranial pressure
UVP	Umbilical venous pressure	LV	Left ventricular pressure
P1 to P4	Non-specific pressure label		

NOTE

- **The same label cannot be selected for different pressures. When two pressures are detected having the same label, the monitor automatically changes one pressure label to a currently unused one.**
-

13.6.3 Setting the Pressure Type for Display

For the non-specific pressure (P1, P2, P3 or P4), the displayed pressure type is configurable. To set the displayed pressure type, follow this procedure:

1. Select the numeric area or waveform area of the non-specific pressure to enter the corresponding pressure dialog.
2. Select the **Setup** tab.
3. Set **Measure**:
 - ◆ If this non-specific pressure is arterial pressure, set the **Measure** to **All**. In this case, its corresponding numeric area displays systolic pressure, diastolic pressure and mean pressure.
 - ◆ If this non-specific pressure is venous pressure, set the **Measure** to **Mean Only**. In this case, its corresponding numeric area displays only the mean pressure.

13.6.4 Changing the Sensitivity

The IBP value displayed on the monitor screen is the average of data collected within a specific time. The shorter the averaging time is, the quicker the monitor responds to changes in the patient's blood pressure, and the higher the sensitivity. Contrarily, the longer the averaging time is, the slower the monitor responds to changes in the patient's blood pressure, the lower the sensitivity, but the measurement accuracy will be improved. For critically ill patients, selecting higher sensitivity will help with understanding the patient's state.

To set the sensitivity, follow this procedure:

1. Select the IBP numeric area or waveform area to enter the corresponding pressure dialog.
2. Select the **Setup** tab.
3. Set **Sensitivity**.

13.6.5 Setting the IBP Waveform

To set the IBP waveform, follow this procedure:

1. Select the IBP numeric area or waveform area to enter the corresponding pressure dialog.
2. Select the **Setup** tab.
3. Set the following properties of the IBP waveform:
 - ◆ **Speed**
 - ◆ **Scale**: if **Auto** is selected, the size of the pressure's waveform will be adjusted automatically.

13.6.6 Setting the Display Format of Artery Pressure

To set the display format of the artery pressure, follow this procedure:

1. Select the numeric area or waveform area of any arterial pressure to enter the corresponding menu.
2. Select the **Setup** tab.
3. Set **Display Format**.

13.6.7 Showing/Hiding the Alarm Limits of Artery Pressure

To set whether to display the alarm limits of the arterial pressure, follow this procedure:

1. Select the numeric area or waveform area of any arterial pressure to enter the corresponding menu.
2. Select the **Setup** tab.
3. Switch on or off **Display Alarm Limits**.

13.6.8 Enabling PPV Measurement

PPV indicates pulse pressure variation. When measuring the arterial pressure (except PA), the PPV measurement is available. To enable the PPV measurement, follow this procedure:

1. Select the IBP numeric area or waveform area to enter the corresponding pressure dialog.
2. Select the **PPV Setup** tab.
3. Switch on **PPV Measure**.

You can select PPV source after enabling the PPV measurement.

WARNING

- **This monitor can calculate PPV from beat-to-beat values of any arterial pulsatile pressure. The circumstances under which the calculation of a PPV value is clinically meaningful, appropriate and reliable must be determined by a physician.**
 - **The clinical value of the derived PPV information must be determined by a physician. According to recent scientific literature, the clinical relevance of PPV information is restricted to sedated patients receiving controlled mechanical ventilation and mainly free from cardiac arrhythmia.**
 - **PPV calculation may lead to inaccurate values in the following situations:**
 - ◆ **at respiration rates below 8 rpm**
 - ◆ **during ventilation with tidal volumes lower than 8 ml/kg**
 - ◆ **for patients with acute right ventricular dysfunction (cor pulmonale).**
 - **The PPV measurement has been validated only for adult patients.**
-
-

13.7 PAWP

Pulmonary Artery Wedge Pressure (PAWP) values, used to assess cardiac function, are affected by fluid status, myocardial contractility, and valve and pulmonary circulation integrity.

Obtain the measurement by introducing a balloon-tipped pulmonary artery flotation catheter into the pulmonary artery. When the catheter is in one of the smaller pulmonary arteries, the inflated balloon occludes the artery allowing the monitor to record changes in the intrathoracic pressures that occur throughout the respiration cycle.

The pulmonary wedge pressure is the left ventricular end diastolic pressure when the airway pressure and valve function are normal. The most accurate PAWP values are obtained at the end of the respiration cycle when the intrathoracic pressure is fairly constant and the artifact caused by respiration is minimal.

WARNING

- **PAWP monitoring is not intended for neonatal patients.**
-
-

13.7.1 PAWP Equipment to Patient Connection

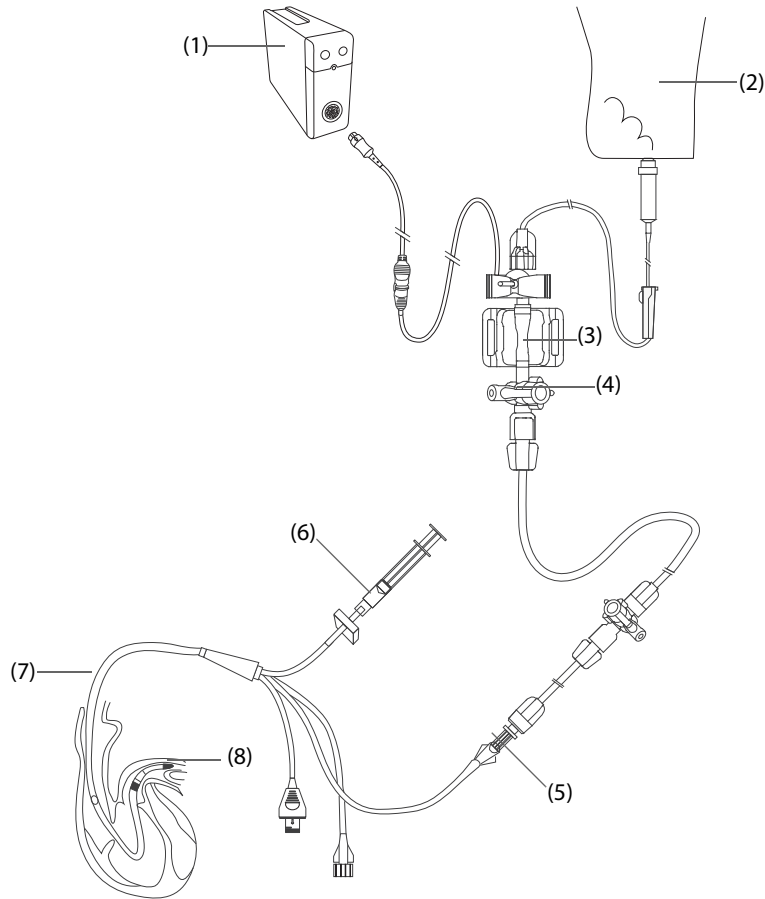

- | | |
|-----------------------------|-------------------------------|
| (1) IBP module | (2) Flush bag |
| (3) IBP transducer | (4) Three-way valve |
| (5) PA distal port | (6) Balloon inflation syringe |
| (7) Thermodilution catheter | (8) Balloon |

13.7.2 Preparing to Measure PAWP

To prepare to monitor PAWP, follow this procedure:

1. Connect the IBP transducer, the IBP cable and the monitor. For more information, see *13.3.2 Measuring an Invasive Blood Pressure*.
2. Follow the manufacturer's instructions to connect the PA port of the thermodilution catheter and the patient end of the IBP transducer.
3. Zero the IBP transducer. For more information, see *13.3.3 Zeroing the IBP transducer*.
4. Set the IBP label to **PA** since the PAWP is measured on PA. For more information, see *13.6.2 Changing the Pressure Label*.

13.7.3 Measuring PAWP

To measure the PAWP, follow this procedure:

1. Select the PA numeric area or waveform area to enter the **PA** dialog, and then select **PAWP**.

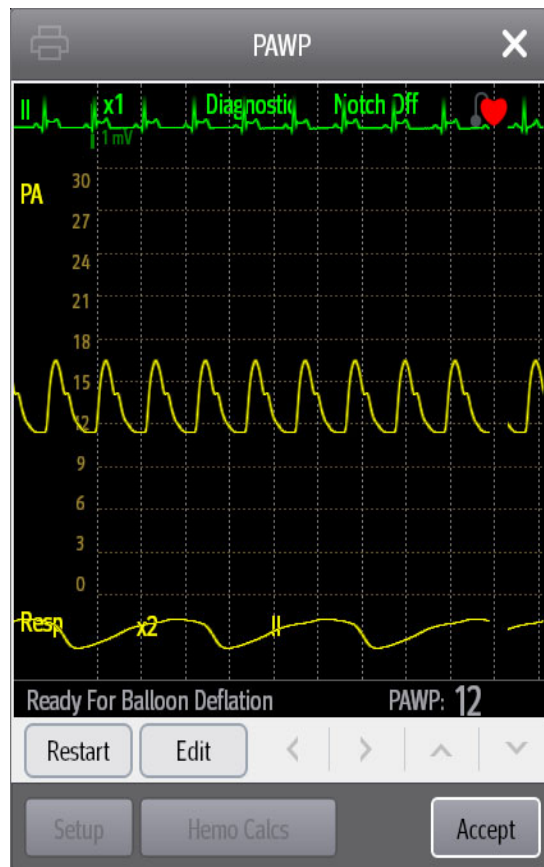

2. Wedge the flotation catheter into the pulmonary artery by observing the PA waveform changes on the screen, referring to the following figure.

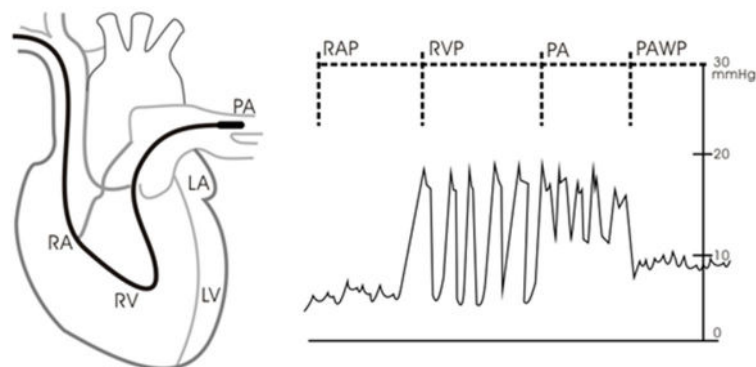

3. Select **Start**.
4. Inflate the balloon and pay attention to PA waveform changes on the screen when the prompt message **Ready For Balloon Deflation** appears.
5. Deflate the balloon when the prompt message **Ready For Balloon Deflation** appears. If the PA waveform is stable, but the monitor is still not showing the prompt message **Ready For Balloon Deflation**, select **Freeze** to freeze the waveform, and deflate the balloon.
6. Select **Accept** to save the PAWP value.
7. If you need to start a new measurement, repeat step 3 to step 6.

If the measurement fails or you need to adjust the PAWP value, you can use the following buttons to adjust the PAWP waveform and measurement.

- Select the up or down arrow button to adjust the PAWP value.
- Select the left or right arrow button to view the frozen waveforms of 40 seconds.
- Select **Accept** to save the PAWP value.

WARNING

- **Prolonged inflation can cause pulmonary hemorrhage, infarction or both. Inflate the balloon for the minimum time necessary to get an accurate measurement.**
 - **If the PAWP is greater than the PA (systolic), deflate the balloon and report the incident in accordance with hospital policy. Because the pulmonary artery could be accidentally ruptured, and the PAWP value derived will not reflect the patient's hemodynamic state, but will merely reflect the pressure in the catheter or balloon.**
 - **If the flotation/thermodilution catheter drifts into the wedge position without inflation of the balloon, the PA waveform assumes a wedged appearance. Take appropriate action, in accordance with standard procedures, to correct the situation.**
-

NOTE

- **The PA alarm is turned off automatically when the monitor enters the PAWP screen.**
-

13.7.4 Setting the Waveforms of the PAWP Screen

On the **PAWP** screen, select **Setup** to enter the **PAWP Setup** dialog. In the **PAWP Setup** dialog, you can make the following settings:

- Select **Reference Waveform 1** to set an ECG lead wave as the first reference wave.
- Select **Reference Waveform 2** to set a respiration wave as the second reference wave.
- Select **Speed** to set a sweep speed for the displayed waveforms on the **PAWP** screen.
- Select **Scale** to set the size of the PA waveform on the **PAWP** screen.

13.7.5 Setting the Use PA-D as PAWP Switch

The PA-D value can be configured to replace the PAWP value for hemodynamic calculation. To do so, follow this procedure:

1. Select the PA numeric area or waveform area to enter the **PA** dialog.
2. Select the **Setup** tab.
3. Switch on or off **Use PA-D as PAWP**.

For more information on hemodynamic calculation, see *19.4 Hemodynamic Calculations*.

13.7.6 Performing Hemodynamic Calculation

On the **PAWP** screen, select **Hemo Calcs** to enter the **Calculations** dialog. For more information, see *19.4 Hemodynamic Calculations*.

13.8 Connecting a Camino Device

The IBP module can interface with the Camino multi-parameter monitor (Model: MPM-1) to measure intracranial pressure (ICP).

To connect the Camino, follow this procedure:

1. Plug the IBP module into the module rack.
2. Connect the Camino ICP cable to the IBP module.
3. Connect the Camino ICP cable to the ICP adapter.
4. Connect the ICP connector to the ICP adapter.
5. Connect the Camino cable to the Camino monitor.

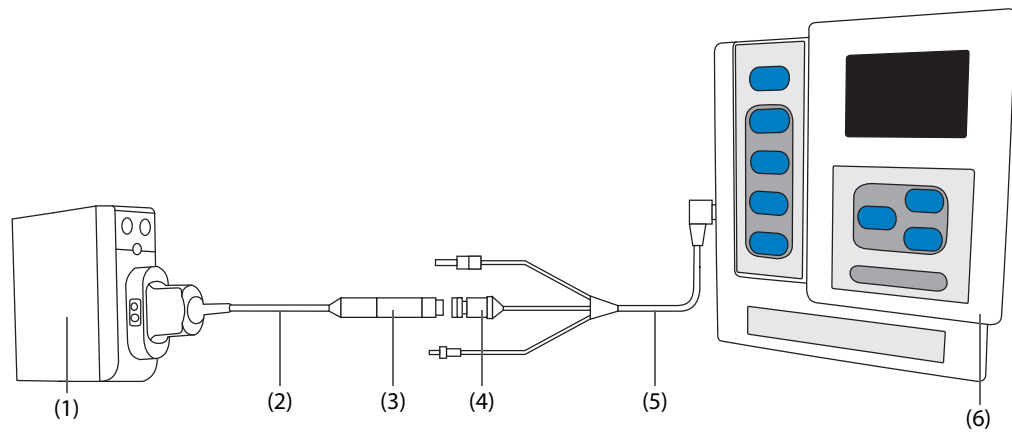

- | | |
|------------------|----------------------|
| (1) IBP module | (2) Camino ICP cable |
| (3) ICP adapter | (4) ICP connector |
| (5) Camino cable | (6) Camino monitor |

WARNING

- Refer to the Camino Operator's Manual to adjust settings and connect the monitor with the patient.
 - ICP alarm settings on the Mindray patient monitor are independent of the Camino monitor alarm settings, and thus may be different. Please pay special attention to the alarms on the Camino monitor.
-
-

13.9 IBP Troubleshooting

This section lists the problems that might occur. If you encounter the problems when using the equipment or accessories, check the table below before requesting service. If the problem persists, contact your service personnel.

NOTE

- For the physiological and technical alarm messages, see Appendix D Alarm Messages.
-

Problem	Solution
Cannot see IBP numeric area or waveform area on the main screen	<ol style="list-style-type: none"> 1. Check that the IBP is set to display in the Screen Setup dialog. For more information, see 3.9.2 <i>Displaying Parameter Numerics and Waveforms</i>. 2. Check that if the IBP parameter switch is enabled. If not, enable the IBP measurement. For more information, see 3.9.1 <i>Switching On or Off a Parameter</i>. 3. Check the connection of IBP cable, IBP transducer and the monitor. 4. Check that the three-way valve is turned to the correct position. 5. Check that the IBP transducer has been zeroed. For more information, see 13.3.3 <i>Zeroing the IBP transducer</i>.
Cannot see systolic pressure and diastolic pressure for P1/P2/P3/P4	Set Measure to All in the P1/P2/P3/P4 setup page. For more information, see 13.6.3 <i>Setting the Pressure Type for Display</i> .
IBP readings seem unstable	<ol style="list-style-type: none"> 1. Make sure there are no air bubbles in the transducer systems. 2. Check that the transducer is properly fixed. 3. Zero the transducer again. 4. Replace the transducer.

Problem	Solution
Zeroing of IBP channel(s) fails.	<ol style="list-style-type: none"><li data-bbox="683 221 1070 248">1. Ensure that the channels are open to air.<li data-bbox="683 255 1382 331">2. Perform zero calibration again. Do not sway the IBP transducer and tubing during zero calibration. For more information, see <i>13.3.3 Zeroing the IBP transducer</i>.<li data-bbox="683 338 1158 365">3. If zero calibration still fails, replace the transducer.

14 Monitoring Cardiac Output (C.O.)

14.1 C.O. Introduction

The cardiac output (C.O.) measurement invasively measures cardiac output and other hemodynamic parameters using the right heart (atria) thermodilution method. A cold solution of known volume and temperature is injected into the right atrium through the proximal port of a pulmonary artery (PA) catheter. The cold solution mixes with the blood in the right ventricle and the change in blood temperature is measured with a thermistor at the distal end of the catheter in the pulmonary artery. The temperature change is displayed as a curve on the C.O. split screen, and the monitor calculates the C.O. value from this curve. The C.O. value is inversely proportional to the area under the curve. As cardiac output varies continuously, a series of measurements must be carried out to achieve a reliable C.O. average value. Always use the average of multiple thermodilution measurements for therapy decisions. The monitor is capable of storing 6 measurements.

C.O. monitoring is intended for adult patients only.

You can monitor C.O. using the built-in C.O. module or the external C.O. module.

The following picture shows the external C.O. module.

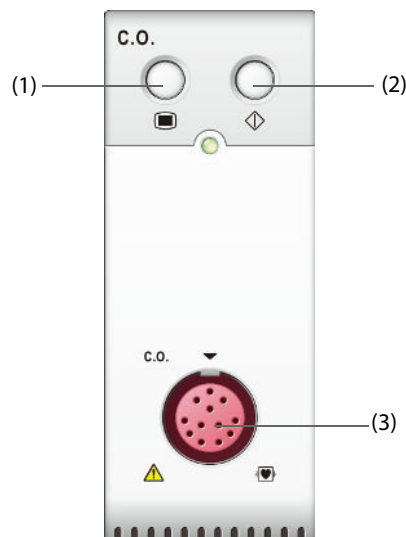

(1) C.O. dialog hard key

(2) C.O. measure dialog hard key

(3) C.O. cable connector

14.2 C.O. Safety Information

WARNING

- **The C.O. measurement results may be erroneous during electrosurgery.**
 - **All invasive procedures involve risks to the patient. Use aseptic technique and follow catheter manufacturer's instructions.**
 - **Use only accessories specified in this manual. Make sure that the accessories never come into contact with conductive parts.**
 - **C.O. monitoring is not intended for pediatric and neonatal patients.**
-

14.3 C.O. Measurement Limitations

The following factors may influence the accuracy of C.O. measurement:

- temperature of injectate solution
- volume of injectate solution
- baseline of patient's blood temperature
- patient's inspiratory/expiratory cycle
- placement of catheter with relation to proximity of lung field
- the catheter itself
- patient's heart rate and hemodynamic status
- any solution infused with intravenous injection during the C.O. measurement

To obtain accurate C.O. measurements, follow these recommendations:

- Temperature of injectate solution must be at least 10 °C cooler than that of the patient's blood.
- Inject solution at end of expiration.
- Inject solution rapidly and smoothly.
- Finish injection within four to five seconds.

14.4 C.O. Display

The C.O. display shows only C.O., C.I. (cardiac index), and TB (blood temperature) in the C.O. numeric area.



(1) C.O. label

(2) Primary parameter unit

(3) Labels and values for primary parameters

(4) Labels and values for secondary parameters

NOTE

- The C.O. value is invalid if it is displayed in outline font.

14.5 C.O. Equipment to Patient Connection

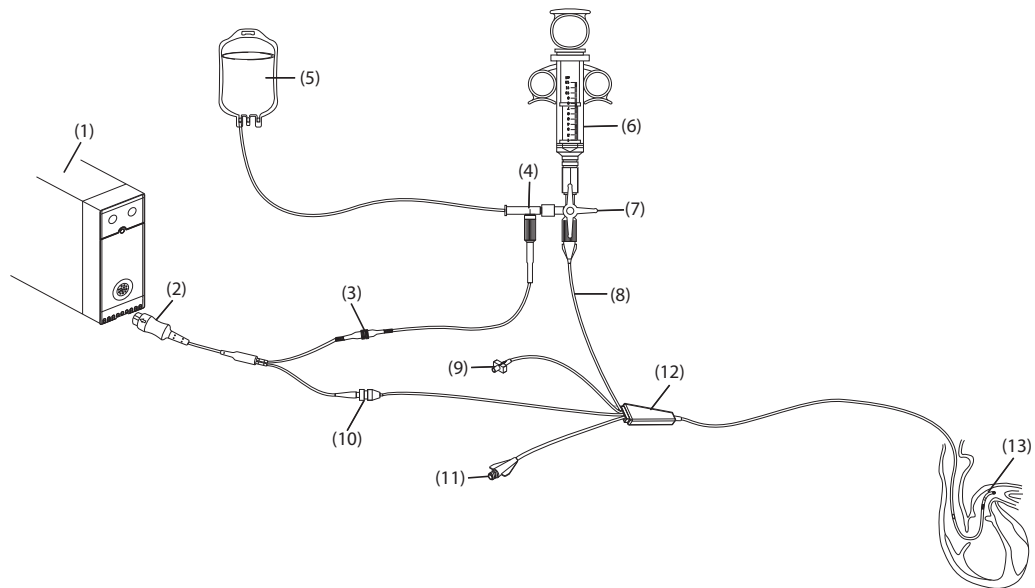

- | | | |
|---------------------------|---------------------------------------|------------------------------|
| (1) C.O. module | (2) 12-pin C.O. cable (Model: CO7702) | (3) TI cable connector |
| (4) In-line probe | (5) Injectate solution | (6) Injectate syringe |
| (7) Three-way valve | (8) Proximal injectate port | (9) Balloon inflation valve |
| (10) Thermistor connector | (11) PA distal port | (12) Thermodilution catheter |
| (13) Thermistor | | |

14.6 Performing C.O. Measurement

14.6.1 Preparing for C.O. Measurement

1. Connect the C.O. cable to the C.O. connector and thermistor connector, making sure the C.O. numeric area is displayed on the monitor's main screen.
2. Follow the hospital's policy and procedures to prepare the patient for the C.O. measurement.
3. Follow the manufacturer's instructions to set up the catheter and other accessories.
4. Check that all the accessories are properly connected.

NOTE

- **For an in-line probe setup, make sure the in-line sensor is securely connected to the tubing. For the bath probe setup, make sure the bath probe is correctly sensing the injectate temperature.**

14.6.2 Setting C.O. Measurement

Before performing the C.O. measurement, follow this procedure:

1. Select the C.O. numeric area to enter the **C.O. Measure** dialog.
2. Select the **Setup**.
3. Perform the following check or setup:
 - ◆ Check if the height and weight are appropriate for your patient. Change if necessary. The patient's height and weight values are required for determining cardiac index (C.I.).
 - ◆ Check that the correct computation constant is entered. The computation constant has a close relationship with the entered injectate volume, injectate probe type (in-line probe or bath probe) and temperature. See the Instructions for Use of the pulmonary artery catheter to determine correctness.

To change the computation constant, select **Comp Const** and then input the correct value. When a new catheter is used, the computation constant should be adjusted in accordance with the manufacturer's instructions for use.

- ◆ Switch on or off **Auto TI**. If **Auto TI** is switched on, the system automatically detects the injectate temperature, and **TI** setting is disabled. If **Auto TI** is switched off, you need to input the injectate temperature at **TI**.
- ◆ Switch on or off **Auto Start**. If **Auto Start** is switched on, the monitor automatically takes the C.O. measurement after establishing a baseline of blood temperature. If **Auto Start** is switched off, you need to click the **Start** button in the **C.O. Measure** dialog for a new measurement.

14.6.3 Performing C.O. Measurement

To perform the C.O. measurement, follow this procedure:

1. Select the C.O. numeric area to enter the **C.O. Measure** dialog.

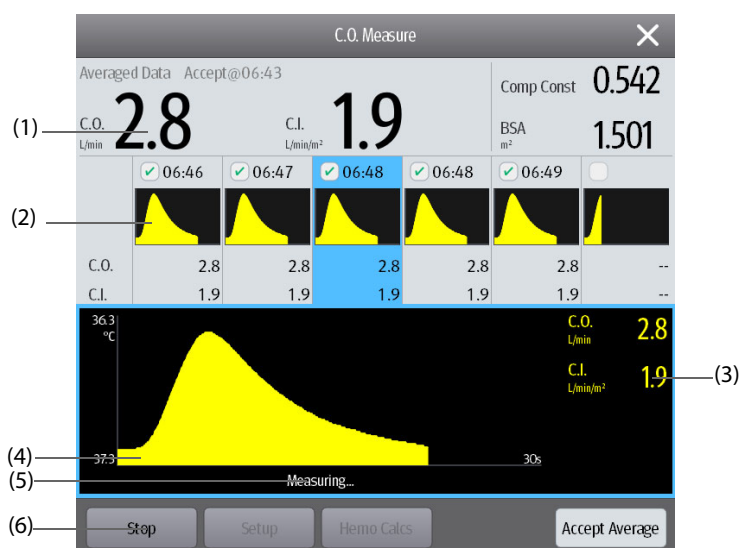

- | | |
|--------------------------------|------------------------------------|
| (1) Average values | (2) Historical measurement dialogs |
| (3) Current measurement values | (4) Current C.O. curve |
| (5) Prompt message area | (6) Buttons |

2. Proceed as follows to perform the C.O. measure:

- ◆ If **Auto Start** is switched off, select the **Start** button, and then inject the solution quickly when you see the message **Please Wait**. As shown in the figure above, during the measurement, the currently measured thermodilution curve is displayed. At the end of the measurement, the thermodilution curve is transferred to one of the 6 measurement areas and the monitor prompts you to wait for a certain period of time before starting a new measurement.
- ◆ If **Auto Start** is switched on, inject the solution quickly when you see the message **Ready For New Set Of Measurement**. The monitor consecutively takes C.O. measurements automatically without the need for pressing the **Start** button between two measurements. A new thermodilution measurement is possible as soon as the message **Inject Now!** is displayed on the screen. The monitor automatically detects further thermodilution measurements.

3. Acquire the average value of C.O. and C.I. A maximum of 6 measurements can be stored. If you perform more than six measurements without rejecting any, the oldest will automatically be deleted when a seventh curve is stored. Select from the 6 measurement curves and the system will automatically calculate and display the averaged C.O. and C.I. values. Then select the **Accept Average** button to accept and store the averaged values.

When injecting, the stopcock to the thermodilution catheter is open and the stopcock to the injectate solution is closed. After completing the measurement, turn off the stopcock to the thermodilution catheter and turn on the stopcock to the injectate solution, and then draw the injectate solution into the injectate syringe.

The button area also provides you with the following functions:

- Select **Stop** to stop the current measurement. Select **Setup** to enter the **C.O.** dialog.
- Select **Hemo Calcs** to enter the **Calculations** dialog.

NOTE

- **Starting a measurement without blood temperature being stable may cause measurement failure.**
- **The TB alarms are inactivated during a C.O. measurement, and will be reactivated automatically after the completion of C.O. measurement.**
- **Please see the Instructions for Use of thermodilution catheter to determine the Comp Const and the volume of injectate solution.**

14.7 Changing C.O. Settings

14.7.1 Setting C.O. Alarm Properties

To set the C.O. alarm properties, follow this procedure:

1. Select the C.O. numeric area to enter the **C.O. Measure** dialog.
2. Select **Setup** to enter the **C.O.** dialog.
3. Select the **Alarm** tab.
4. Enter the password if required. For more information, see 24.13.3 *Selecting Password for User Authentication*.
5. Set the alarm properties as desired.

14.8 C.O. Troubleshooting

This section lists the problems that might occur. If you encounter the problems when using the equipment or accessories, the table below may help with troubleshooting before requesting a service personnel visit. If the problem persists, contact your service personnel.

NOTE

- **For the physiological and technical alarm messages, see Appendix D Alarm Messages.**

Problem	Solution
Do not see C.O. numeric area on the main screen	<ol style="list-style-type: none"> 1. Check that the C.O. is set to display in the Screen Setup dialog. For more information, see 3.9.2 <i>Displaying Parameter Numerics and Waveforms</i>. 2. Check that if the C.O. parameter switch is enabled. If not, enable the C.O. measurement. For more information, see 3.9.1 <i>Switching On or Off a Parameter</i>. 3. Check that the patient type is adult. 4. Check the connection of C.O. cable, thermodilution catheter and TI sensor.
C.O. value is inaccurate	<ol style="list-style-type: none"> 1. Check that the thermodilution catheter is positioned properly. 2. Check that the computational constant is proper for current injectate temperature, injectate volume and injectate probe type. 3. Inject solution rapidly and smoothly. 4. Finish injection within four to five seconds. 5. Inject more volume, or inject colder solution. 6. Check that the height and weight of patient is properly configured. 7. If Auto TI is switched off, check that the entered temperature is correct.
C.O. measurement fails	<ol style="list-style-type: none"> 1. Inject more volume, or inject colder solution. Make sure that the injectate temperature is at least 10°C colder than the patient blood temperature. 2. Finish injection within four to five seconds. 3. Check the connection of C.O. cable, thermodilution catheter and TI sensor.

This page intentionally left blank.

15 Monitoring Carbon Dioxide (CO₂)

15.1 CO₂ Introduction

CO₂ monitoring is a continuous, non-invasive technique for determining the concentration of CO₂ in the patient's airway by measuring the absorption of infrared (IR) light of specific wavelengths. CO₂ has its own absorption characteristic and the amount of light passing the gas probe depends on the concentration of the measured CO₂. When a specific band of IR light passes through respiratory gas samples, some of IR light will be absorbed by the CO₂ molecules. The amount of IR light transmitted after it has been passed through the respiratory gas sample is measured with a photodetector. From the amount of IR light measured, the concentration of CO₂ is calculated.

CO₂ measurement is used to monitor the patient's respiratory status. The Sidestream/Microstream CO₂ measurement takes a sample of the respiratory gas with a constant sample flow from the patient's airway and analyzes it with a remote CO₂ sensor built into the Sidestream or Microstream CO₂ module.

The sidestream and microstream CO₂ measurement can be used, with specified accessories, with intubated and non-intubated adult, pediatric, and neonatal patients. With intubated patients, a sample of the respiratory gas is drawn from the patient's breathing circuit through an airway adapter and a gas sampling line. With non-intubated patients, the gas sample is drawn through a nasal cannula.

CO₂ monitoring is intended for adult, pediatric and neonatal patients.

15.2 Identifying CO₂ Modules

For ePM 12M, you can monitor CO₂ using the built-in CO₂ module or the external CO₂ module. For ePM 10M, you can monitor CO₂ using the external CO₂ module only.

The following figures show the controls and connectors of different CO₂ module.

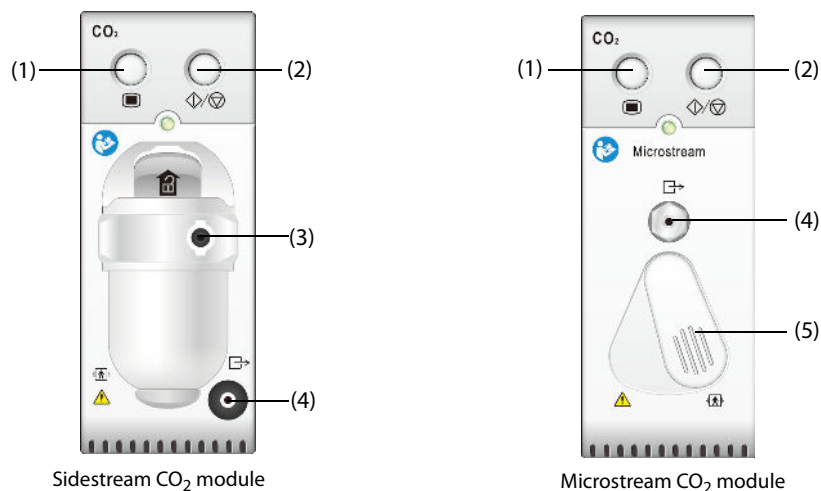

(1) CO₂ dialog hard key

(2) CO₂ Measure/standby hard key

(3) CO₂ watertrap seat

(4) Gas outlet

(5) Sample line connector

To measure CO₂ using the AG module, see *16 Monitoring Anesthetic Gas (AG)*.

15.3 CO₂ Safety Information

WARNING

- Route all tubing away from the patient's throat to avoid strangulation.
-

CAUTION

- Remove the airway sample line from the patient's airway while nebulized medications are being delivered. Measuring CO₂ during nebulization may lead to inaccurate CO₂ readings.
 - EtCO₂ values measured from the CO₂ module may differ from those from the blood gas analysis.
 - Avoid mechanical shock to the sidestream CO₂ module.
-

NOTE

- The CO₂ module automatically suppresses physiological alarms until breathing waves have been detected. Ensure that the patient is properly connected when using the CO₂ module.
-

15.4 CO₂ Measurement Limitations

The following factors may influence the measurement accuracy:

- Leaks or internal venting of sampled gas
- Mechanical shock
- Cyclic pressure up to 10 kPa (100 cmH₂O)
- Other sources of interference, if any

For more information, see *A.13.9 CO₂ Specifications*.

CAUTION

- Measurement accuracy of the sidestream CO₂ module may be affected by the breath rate and inspiration/expiration (I/E) ratio.
 - Measurement accuracy of the microstream CO₂ module may be affected by the breath rate.
-

15.5 CO₂ Display

The CO₂ numeric and waveform areas provide FiCO₂ measurement, EtCO₂ measurement, awRR measurement, and a CO₂ waveform.

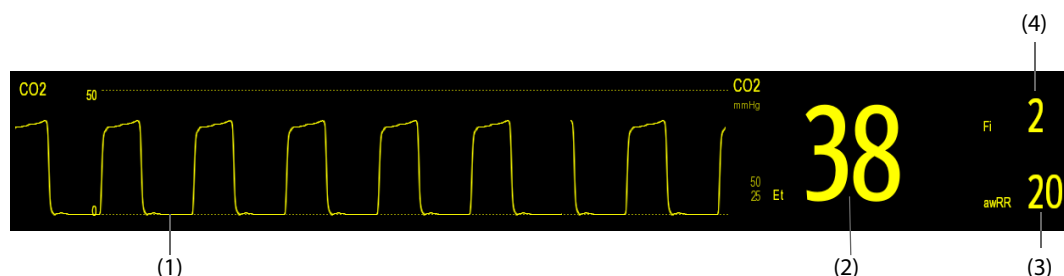

(1) CO₂ waveform

(2) Fraction of inspired CO₂ (FiCO₂)

(3) End tidal CO₂ value (EtCO₂)

(4) Airway respiration rate (awRR)

15.6 Measuring CO₂ Using the Sidestream/Microstream CO₂ Module

15.6.1 Preparing to Measure CO₂ Using the Sidestream CO₂ Module

To prepare the CO₂ measurement, follow this procedure:

1. Select the appropriate gas sample line and watertrap according to the patient category.
2. Connect the watertrap to the CO₂ module, and connect the gas sample line to the watertrap.

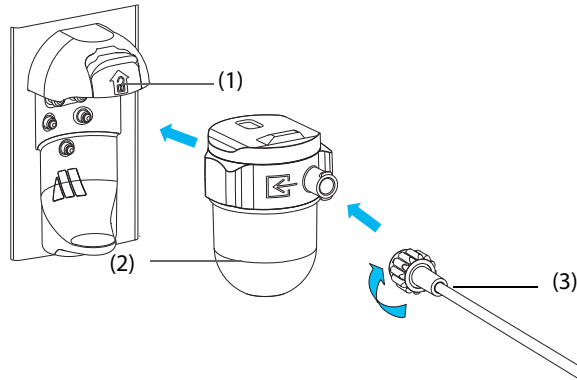

(1) Watertrap receptacle (2) DRYLINE II watertrap (3) Gas sample line

3. Connect the other end of the gas sample line to the patient.
 - ◆ For intubated patients requiring an airway adapter, install the airway adapter between the patient circuit and the ventilator Y-piece.

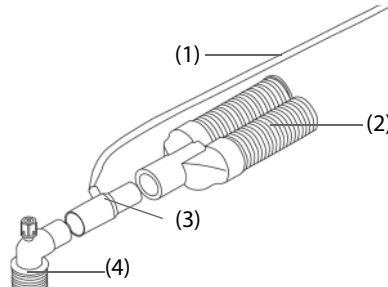

(1) Sample line (2) Connection to the ventilator
(3) Airway adapter (4) Connection to the patient

- ◆ For non-intubated patients, place the nasal cannula onto the patient.



4. If the equipment is used in the presence of anesthetic gases, nitrous oxide or high concentrations of oxygen, connect the gas outlet to the scavenging system using an exhaust tube.

After the watertrap is connected, it enters measure mode by default and the monitor displays **CO₂ Starting**. CO₂ can be measured after the start-up sequence is complete.

WARNING

- Do not use the adult or pediatric watertrap with a neonate patient. Otherwise, patient injury could result.
 - Connect the gas outlet to the scavenging system when measuring CO₂ using the sidestream CO₂ module.
-
-

CAUTION

- Leakage in the breathing or sampling system may cause the displayed EtCO₂ values to be significantly low. Always make sure that all components are securely connected.
 - Inspect the airway adapter for a tight connection and proper operation before attaching it to the patient.
 - Squeezing or bending the sample line during sidestream or microstream CO₂ measurement may cause inaccurate CO₂ readings or no reading.
 - To avoid blocking the airway, empty the DRYLINE II watertrap container whenever half full. Replacing the DRYLINE II watertrap once a month is recommended. Dispose of accumulated fluids in accordance with hospital policy or your local regulations.
 - The DRYLINE II watertrap has a filter preventing bacterium, water and secretions from entering the module. Extended use could destroy the filter in watertrap and fail to stop the bacterium, water and secretions entering the module, result in damaging the gas module and having infection risk.
-

NOTE

- To extend the lifetime of the watertrap and module, disconnect the watertrap from the module and set the operating mode to Standby mode when CO₂ monitoring is not required.
 - The sample rates are different when different types of watertraps are used.
 - The emptying interval of the DRYLINE II adult/pediatric watertrap is 26 hours @ 120 ml/min, sample gas of 37 °C, room temperature of 23 °C, and 100% RH.
 - The emptying interval of the DRYLINE II neonatal watertrap is 35 hours @ 90 ml/min, sample gas of 37 °C, room temperature of 23 °C, and 100% RH.
-

15.6.2 Preparing to Measure CO₂ Using the Microstream CO₂ Module

To prepare the CO₂ module for measurement, follow this procedure:

1. Connect one end of the sample line to the microstream CO₂ module.

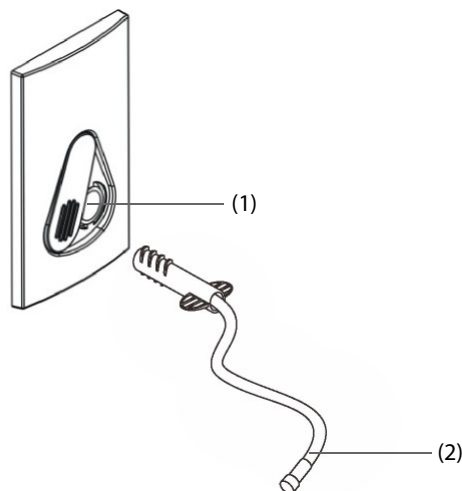

(1) Sample line connector

(2) Sample line

2. Connect the other end of the sample line to the patient.

- ◆ For intubated patient requiring an airway adapter, install the airway adapter between the patient circuit and the ventilator Y-piece.
 - ◆ For non-intubated patient, place the nasal cannula onto the patient.
 - ◆ For patient prone to mouth breathing, place the oral-nasal cannula onto the patient.
3. Connect the gas outlet to the a scavenging system using an exhaust tube.

After the sample line is connected, it enters measure mode by default and the monitor displays **CO2 Sensor Warmup**. CO₂ can be measured after the start-up sequence is complete.

WARNING

- **Connect the gas outlet to the scavenging system when measuring CO₂ using the microstream CO₂ module.**
-

NOTE

- **Disconnect the sample line from the module when CO₂ monitoring is not required.**
-

15.6.3 Zeroing the Sidestream/Microstream CO₂ Module

The sidestream and microstream CO₂ modules perform a zero calibration automatically when needed. Once the zero calibration is started, the CO₂ module stops measuring and **“Zeroing”** is displayed in the CO₂ numeric area.

After the zero calibration is completed, the CO₂ module reacquires the CO₂ readings. During the reacquisition period, **“Zero Recovering”** is displayed in the CO₂ numeric area. Valid data will reappear 30 seconds after the zero calibration is started. You can hide the display of the **“Zero Recovering”** message, but values displayed during the reacquisition period may not be accurate. See *24.5.5 Hiding the Invalid Display after Zeroing the CO₂ Module* for more information.

The automatic zero calibration will not start under the following conditions:

- Physiological alarms related to CO₂ or AG are active.
- An apnea alarm is active.
- No breath has been detected for over 30 seconds.

You can also perform the zero calibration manually. For more information, see *24.5.4 Manually Zeroing the CO₂ Module*.

15.7 Changing Settings for All CO₂ Modules

15.7.1 Changing CO₂ Alarm Settings

To change the CO₂ alarm settings, follow this procedure:

1. Select the CO₂ numeric area or waveform area to enter the **CO2** dialog.
2. Select the **Alarm** tab.
3. Enter the password if required. For more information, see *24.13.3 Selecting Password for User Authentication*.
4. Set alarm properties as desired.

15.7.2 Setting the CO₂ Waveform

To set the CO₂ waveform, follow this procedure:

1. Select the CO₂ numeric area or waveform area to enter the **CO2** dialog.
2. Select the **Setup** tab.
3. Set **Waveform Type**, **Speed**, **Scale** or **CO2 Scale** of the CO₂ waveform.

15.7.3 Setting the RR Source

To set the respiration rate (RR) source, follow this procedure:

1. Select the CO₂ numeric area or waveform area to enter the **CO2** dialog.
2. Select the **Setup** tab.
3. Set **RR Source**.

When you select **Auto**, the system automatically selects the RR source according to the priority. The priority of RR source is first CO₂, and then ECG. When the current RR source does not have valid measurement, the system automatically switches the **RR Source** to **Auto**.

15.7.4 Entering the Standby Mode

Set the CO₂ module to one of the following modes according to the module status:

- Select **Measure** mode when using the CO₂ module for monitoring.
- Select **Standby** mode to prolong the CO₂ module service life when not using the CO₂ module.

The default operating mode is **Measure**. When not using the CO₂ module, proceed as follows to enter the Standby mode:

1. Select the CO₂ numeric area or waveform area to enter the **CO2** dialog.
2. Select the **Setup** tab.
3. Set **Operating Mode** to **Standby**.

15.7.5 Entering the Intubation Mode

When performing intubation during general anesthesia, enter the intubation mode to reduce unnecessary alarms. To enter the intubation mode, follow this procedure:

1. Select the CO₂ numeric area or waveform area to enter the **CO2** dialog.
2. Select **Intubation Mode**.

To exit the intubation mode, choose either of the following ways:

- From the bottom of the **CO2** dialog, select **Exit Intubation Mode**.
- Select the **Main Menu** quick key →from the **Alarm** column select **Exit Intubation Mode**.

For the details of the intubation mode, see 7.14 *Intubation Mode*.

NOTE

- **When the configured intubation period is over, the monitor automatically exits the intubation mode and gives two alert sounds.**

15.7.6 Setting the Auto Standby

The monitor enters standby mode automatically if no breath is detected after the configured period of time. To set the auto standby, follow this procedure:

1. Select the CO₂ numeric area or waveform area to enter the **CO2** dialog.
2. Select the **Setup** tab.
3. Set **Auto Standby**.

15.7.7 Setting Humidity Compensation

Sidestream and microstream CO₂ modules are configured to compensate CO₂ readings for either Body Temperature and Pressure, Saturated Gas (BTPS), to account for humidity in the patient's breath, or Ambient Temperature and Pressure, Dry Gas (ATPD).

- ATPD: $P_{CO_2}(mmHg) = CO_2(vol\%) \times P_{amb}/100$
- BTPS (sidestream): $P_{CO_2}(mmHg) = CO_2(vol\%) \times (P_{amb} - 47)/100$

- BTPS (microstream): $P_{CO_2}(mmHg) = CO_2(vol\%) \times (1 - 0.03) \times P_{amb} / 100$

Where, $P_{CO_2}(mmHg)$ = partial pressure, $vol\%$ = CO_2 concentration, P_{amb} = ambient pressure, and unit is mmHg.

For the sidestream and microstream CO_2 module, set the humidity compensation on or off according to the actual condition.

To set the humidity compensation, follow this procedure:

1. Select the CO_2 numeric area or waveform area to enter the **CO2** dialog.
2. Select the **Setup** tab.
3. Set **BTPS Compensation**.
 - ◆ Switch on for BTPS.
 - ◆ Switch off for ATPD.

15.8 Setting the Gas Compensation

The presence of interfering gas affects the CO_2 measurement. To get the best possible measurement result, it is recommended to set the gas compensation. The configured concentration of the interfering gas should be in accordance with its actual proportion.

For the microstream CO_2 module, gas compensations are not required.

CAUTION

- **Make sure to use the appropriate compensations. Inappropriate compensations may cause inaccurate measurement values and result in misdiagnosis.**
-

For the sidestream CO_2 module, follow this procedure to set the gas compensation:

1. Select the CO_2 numeric area or waveform area to enter the **CO2** dialog.
2. Select the **Setup** tab.
3. Set the compensation according to the actual condition.

15.9 Choosing a Time Interval for Peak-Picking

For microstream CO_2 modules, select a time interval for picking the highest CO_2 as the $EtCO_2$ and the lowest as the $FiCO_2$.

To set the time interval, follow this procedure:

1. Select the CO_2 numeric area or waveform area to enter the **CO2** dialog.
2. Select the **Setup** tab.
3. Set **Maximum Hold**.
4. Toggle between **Single Breath, 10 s** and **20 s**.
 - ◆ **Single Breath:** $EtCO_2$ and $FiCO_2$ are calculated for every breath.
 - ◆ **10 s or 20 s:** $EtCO_2$ and $FiCO_2$ are calculated using 10 or 20 seconds of data.

15.10 Performing the Leakage Test

When measuring CO_2 using the internal CO_2 module or the sidestream CO_2 module. The leakage test is required every time before the CO_2 measurement. To perform the CO_2 leakage test, follow this procedure:

1. Connect the measuring accessories as per section 15.6.1 *Preparing to Measure CO_2 Using the Sidestream CO_2 Module*.
2. Wait until the startup finishes. Completely block the gas inlet on the sidestream CO_2 module. The alarm message "**CO2 Airway Occluded**" will appear on the screen.
3. Continue to block the gas inlet for another one minute.
4. Select the **Main Menu** quick key → from the **System** column select **Maintenance** → input the required password → select .

5. Select the **Module** tab → **CO2** tab.
6. Check that the current flow rate is less than 10ml/min, and the alarm message “**CO2 Airway Occluded**” does not disappear.

This indicates that the module does not leak. If the alarm message disappears, or the flow rate is equal to 10ml/min or greater, it indicates that the module leaks. Perform the leakage test again. If the problem remains, contact your service personnel for help.

15.11 CO₂ Calibration

For sidestream and microstream CO₂ modules, a calibration is needed every year or when the measured values have a great deviation.

To calibrate the CO₂ module, contact your service personnel.

CAUTION

- **Connect the gas outlet to the scavenging system when calibrating the CO₂ module.**
-

15.12 Test Method Used to Determine the Respiration Rate Measuring Range

To determine the RR measurement range, follow this procedure:

1. Connect the 5% CO₂ + N₂ (BAL) gas cylinder, reduction valve, rhythm generator and gas sampling path of a monitor.
2. Respectively set the rhythm generator to generate a respiration rate of 0 rpm, 6 rpm, 20 rpm, 60 rpm, 120rpm, and 150 rpm.
3. Verify that it meets the specifications.

NOTE

- **The rhythm generator mentioned above is a sensor/sampling site in Figure 201.101 – Test apparatus for the TOTAL SYSTEM RESPONSE TIME of an RGM of ISO 80601-2-55.**
-

15.13 CO₂ Troubleshooting

This section lists the problems that might occur. If you encounter the problems when using the equipment or accessories, check the table below before requesting service. If the problem persists, contact your service personnel.

NOTE

- **For the physiological and technical alarm messages, see Appendix D Alarm Messages.**
-

15.13.1 Troubleshooting the Sidestream/Microstream CO₂ Module

Problem	Solution
EtCO ₂ measurements too low	<ol style="list-style-type: none"> 1. Check the patient status. 2. Check the sample line and connectors for leakage. 3. Ventilate the room if the environmental CO₂ concentration is too high.

15.14 Oridion Information

Microstream

Oridion Patents

This posting serves as notice under 35 U.S.C. §287(a) for Covidien patents: <http://www.covidien.com/patents>.

No Implied License

Possession or purchase of this device does not convey any express or implied license to use the device with unauthorized CO₂ sampling consumables which would, alone, or in combination with this device, fall within the scope of one or more of the patents relating to this device and/or CO₂ sampling consumable.

This page intentionally left blank.

16 Monitoring Anesthetic Gas (AG)

16.1 AG Introduction

The anesthetic gas (AG) module measures the patient's anesthetic and respiratory gases by connecting to the airway of intubated patients or collecting the gases with specified accessories. It also incorporates the features of the O₂ module.

The AG module determines the concentration of certain gases using the infrared (IR) light absorption measurement. The gases that can be measured by the AG module absorbing IR light. Each gas has its own absorption characteristic. The gas is transported into a sample cell, and an optical IR filter selects a specific band of IR light to pass through the gas. For multiple gas measurements, there are multiple IR filters. The higher the concentration of gas in a given volume, the more IR light is absorbed. This means that higher concentration of IR absorbing gas causes a lower transmission of IR light. The amount of IR light transmitted after it has been passed through an IR absorbing gas is measured. From the amount of IR light measured, the concentration of gas present can be calculated.

Oxygen does not absorb IR light as other breathing gases and is therefore measured relying on its paramagnetic properties. Inside the O₂ sensor are two nitrogen-filled glass spheres mounted on a strong rare metal taut-band suspension. This assembly is suspended in a symmetrical non-uniform magnetic field. In the presence of paramagnetic oxygen, the glass spheres are pushed further away from the strongest part of the magnetic field. The strength of the torque acting on the suspension is proportional to the oxygen concentration. From the strength of the torque, the concentration of oxygen is calculated.

AG monitoring is intended for adult, pediatric and neonatal patients.

You can monitor AG using the external AG module with the eGM label.

The following picture shows the external AG module.

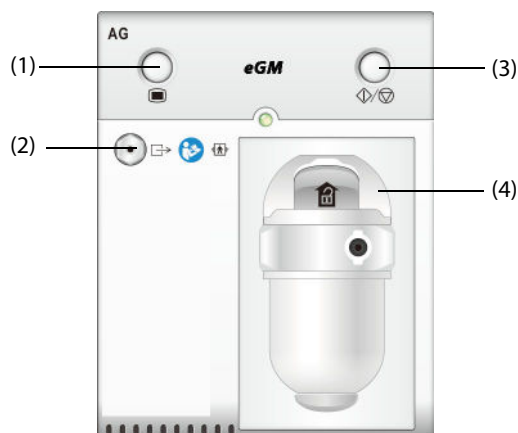

(1) AG dialog hard key

(2) Gas outlet

(3) AG Measure/standby hard key

(4) Watertrap seat

WARNING

- **The AG module with the eGM label can be used only on the ePM 10M/ePM 12M monitor. Using this AG module on other monitors could result serious patient injury or product damage.**

NOTE

- **The AG module is configured with automatic barometric pressure compensation function.**

16.2 AG Safety Information

WARNING

- To avoid explosion hazard, do not use flammable anesthetic agent such as ether and cyclopropane for this equipment.
- The presence of other substances in the patient's breathing circuit, such as ethanol, acetone, methanol, isopropanol, freon, asthma medication carrier gases, and other infrared absorbing gases, can influence the anesthesia agent identification and lead to incorrect measurements and identification.
- Using high-frequency electrosurgical units may increase the risk of skin burn. In this case, do not use antistatic or conductive respiratory tubing.
- Route all tubing away from the patient's throat to avoid strangulation.

CAUTION

- Perform the measurement in a well-ventilated environment.
- EtCO₂ values measured from the AG module may differ from that of from the blood gas analysis.

NOTE

- At startup, the AG module automatically suppresses physiological alarms until breaths have been detected. Make sure that a patient is properly connected when monitoring with the AG module.

16.3 AG Measurement Limitations

The following factors may influence the measurement accuracy:

- Leaks or internal venting of sampled gas
- Mechanical shock
- Cyclic pressure up to 10 kPa (100 cmH₂O)
- Other sources of interference, if any

16.4 AG Display

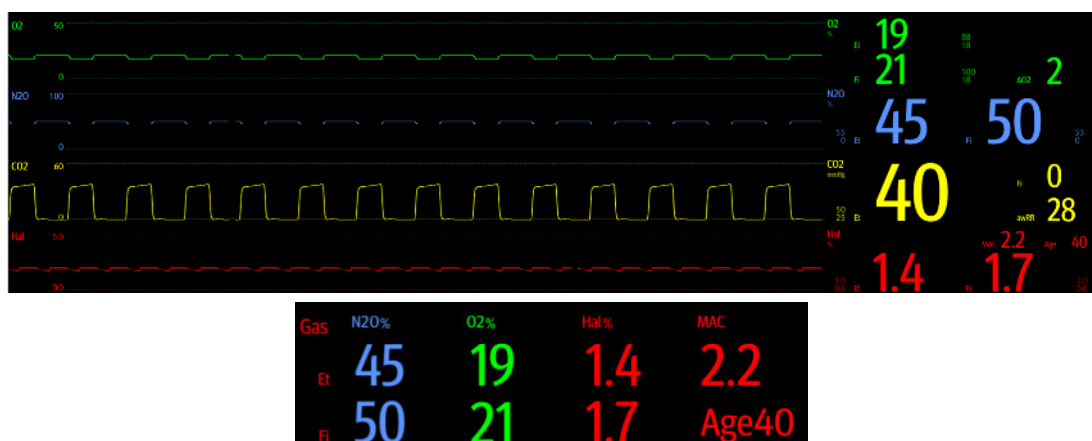

The AG module can send waves and numerics for all measured anesthetic gases for display on the monitor, including:

- CO₂, O₂, N₂O and AA waves
- awRR: airway respiratory rate
- MAC: minimum alveolar concentration
- End tidal (Et) and fraction of inspired (Fi) numerics for CO₂, O₂, N₂O and AA

AA represents one of the following agents: Des (desflurane), Iso (isoflurane), Enf (enflurane), Sev (sevoflurane), or Hal (halothane).

If only one anesthetic agent is used, the AA waveform area displays the waveform of this anesthetic agent. If several anesthetic agents are used, the AA waveform area displays the waveform of the primary anesthetic agent.

16.5 AG Equipment to Patient Connection

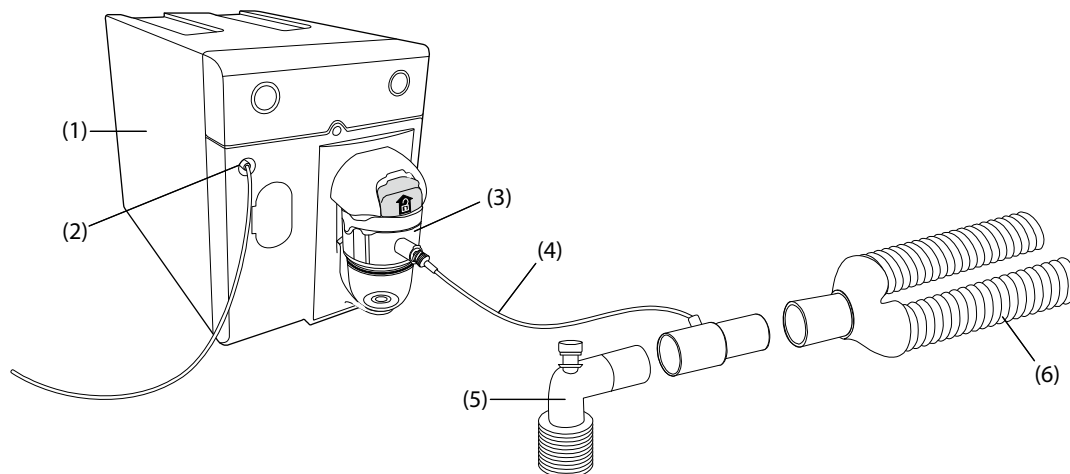

(1) AG module

(2) Gas outlet

(3) Watertrap

(4) Gas sample line

(5) Airway adapter (connected to patient)

(6) Y-piece (connected to the anesthesia machine)

16.6 Preparing for AG Monitoring

To prepare to monitor AG, follow this procedure:

1. Select the appropriate gas sample line and watertrap according to the patient category.
2. Connect the watertrap to the AG module, and connect the gas sample line to the watertrap.
3. Connect the other end of the gas sample line to the patient via the airway adapter.
4. Connect the gas outlet to a scavenging system or the patient respiration circuit using an exhaust tube.
5. Check that the connections are tight.

After the AG module is connected to the monitor, the AG module enters the measurement mode by default and the monitor prompts **AG Starting**. AG measurement is available after the start-up is completed.

WARNING

- **If the sampled gas is returned to the breathing system, there may be a risk of patient cross-infection.**
 - **If the sampled gas is returned to the breathing system, install a breathing system filter compliant with the ISO 23328-1 and ISO 23328-2 standards on the patient end.**
 - **Make sure that the connections are tight. Any leak in the system can result in erroneous readings due to ambient air mixing with patient gases.**
 - **Always inspect the airway adapter for a tight connection and proper operation before attaching it to the patient.**
 - **Squeezing or bending the gas sample line during AG measurement may cause erroneous readings or no readings.**
-

CAUTION

- **Position the airway adapter so that the part connecting to the gas sample line is pointing upwards. This prevents condensed water from passing into the gas sample line and causing an occlusion.**
 - **The watertrap collects water drops condensed in the sample line and therefore prevents them from entering the module. To avoid blocking the airway, empty the watertrap container whenever half full.**
 - **The watertrap has a filter preventing bacterium, water and secretions from entering the module. After long-term use, dust or other substances may compromise the performance of the filter or even block the airway. In this case, replace the watertrap. Replacing the watertrap once a month is recommended.**
-

NOTE

- **Do not apply adult watertrap to the neonatal patient. Otherwise, patient injury could result.**
 - **To extend the lifetime of the watertrap and module, disconnect the watertrap from the module and set the operating mode to Standby when AG monitoring is not required.**
-

16.7 Zeroing the AG Module

The AG module performs a zero calibration automatically when needed. Once the zero calibration is started, the AG module stops measuring and **"Zeroing"** is displayed in the AG numeric area.

After the zero calibration is completed, the AG module reacquires the AG readings. During the reacquisition period, **"Zero Recovering"** is displayed in the AG numeric area. Valid data will reappear 30 seconds after the zero calibration is started. You can hide the display of the **"Zero Recovering"** message, but values displayed during the reacquisition period may not be accurate. See *24.5.7 Hiding the Invalid Display after Zeroing the AG Module* for more information.

The automatic zero calibration will not start under the following conditions:

- Physiological alarms related to CO₂ or AG are active.
- An apnea alarm is active.
- No breath has been detected for over 30 seconds.

You can also perform the zero calibration manually. For more information, see *24.5.6 Manually Zeroing the AG Module*.

16.8 MAC Values

Minimum alveolar concentration (MAC) is the minimum concentration of the agent in the alveoli. It is a basic index to indicate the depth of anesthesia. The standard ISO 80601-2-55 defines MAC as this: alveolar concentration of an inhaled anesthetic agent that, in the absence of other anesthetic agents and at equilibrium, prevents 50% of patients from moving in response to a standard surgical stimulus.

MAC values are listed below:

Agent	Des	Iso	Enf	Sev	Hal	N ₂ O
1 MAC	6%	1.15%	1.7%	2.1%	0.77%	105%*

* indicates 1 MAC nitrous oxide can only be reached in hyperbaric chamber.

NOTE

- **The types of gases used for calculating the MAC value can be selected. For more information, see *24.5.8 Selecting the Gas Type for Measurement*.**
 - **The MAC values shown in the table above are those published by the U.S. Food and Drug Administration for a healthy 40-year-old adult male patient.**
 - **In actual applications, the MAC value may be affected by age, weight and other factors.**
-

The formula to calculate the MAC value is as follows:

$$MAC = \sum_{i=0}^{N-1} \frac{EtAgent_i}{AgentVol_{age}^i}$$

Where N is the number of all agents (including N₂O) that the AG module can measure, EtAgent_i is the concentration of each agent, and AgentVol_{age}ⁱ is the concentration of each agent at 1 MAC with age correction.

The formula for calculating age correction of 1 MAC is:

$$MAC_{age} = MAC_{40} \times 10^{(-0.00269 \times (age - 40))}$$

For example, the Des concentration at 1 MAC of a 60-year old patient is.

$$6\% \times 10^{(-0.00269 \times (60 - 40))} = 6\% \times 0.88$$

The AG module measures 4% of Des, 0.5% of Hal and 50% of N₂O in the patient's end-tidal gas:

$$MAC = \frac{4.0\%}{6\% \times 0.88} + \frac{0.5\%}{0.77\% \times 0.88} + \frac{50\%}{105\% \times 0.88} = 2.04$$

NOTE

- **The formula above is only suitable for patients who are older than one year. If the patient is less than one year, the system uses one year old to do age correction.**

16.9 Changing AG Settings

16.9.1 Changing AG Alarm Settings

To change the AG alarm settings, follow this procedure:

1. Select the AG numeric area or waveform area to enter the **Gas** dialog.
2. Select the desired gas tab.
3. Select the **Alarm** tab.
4. Enter the password if required. For more information, see 24.13.3 *Selecting Password for User Authentication*.
5. Set alarm properties as desired.

16.9.2 Setting the O₂ Compensation

If the AG module does not incorporate the O₂ module, you need to set the amount of O₂ in the ventilation gas mixture. To set the O₂ compensation, follow this procedure:

1. Select the AG numeric area or waveform area to enter the **Gas** dialog.
2. Select the **Setup** tab.
3. Set **O₂ Compensation**:
 - ◆ Select **Off** when the amount of O₂ is less than 30%.
 - ◆ Select the other options in accordance with the O₂ concentration in the gas mixture.

The **O₂ Compensation** setting is available only when the AG module does not incorporate the O₂ module. If the AG module incorporates the O₂ module, the system directly uses the O₂ concentration detected by the O₂ module to make compensation.

16.9.3 Entering the Standby Mode

Set the AG module to one of the following modes according to the module status:

- Select **Measure** mode when using the AG module for monitoring.
- Select **Standby** mode when not using the AG module.

The default operating mode is **Measure**. If not using the AG module, follow this procedure to enter the Standby mode:

1. Select the AG numeric area or waveform area to enter the **Gas** dialog.
2. Select the desired gas tab.
3. Select the **Setup** tab.
4. Set **Operating Mode** to **Standby**.

16.9.4 Setting Auto Standby

The monitor enters the standby mode automatically after the configured period of time if no breath is detected since the last detected breath. To set the auto standby, follow this procedure:

1. Select the AG numeric area or waveform area to enter the **Gas** dialog.
2. Select the desired gas tab.
3. Select the **Setup** tab.
4. Set **Auto Standby**.

16.9.5 Setting the Gas Waveform

To set the gas waveform, follow this procedure:

1. Select the AG numeric area or waveform area to enter the **Gas** dialog.
2. Select the desired gas tab.
3. Select the **Setup** tab.
4. Set the speed and scale of gas waveforms. For CO₂, set **Waveform Type**.

16.9.6 Setting the RR Source

To set the RR (respiration rate) source, follow this procedure:

1. Select the AG numeric area or waveform area to enter the **Gas** dialog.
2. Select the desired gas tab.
3. Select the **Setup** tab.
4. Set **RR Source**.

When the current RR source does not have valid measurement, the system will automatically switch **RR Source** to **Auto**.

16.9.7 Entering the Intubation Mode

When performing intubation during general anesthesia, enter the intubation mode to reduce unnecessary alarms. To enter the intubation mode, follow this procedure:

1. Select the AG numeric area or waveform area to enter the **Gas** dialog.
2. Select **Intubation Mode** from the bottom of the dialog.

For the details of the intubation mode, see *7.14 Intubation Mode*.

16.9.8 Enabling or Disabling MAC Display

Set whether MAC value is displayed in the AG numeric area by following this procedure:

1. Select the AG numeric area or waveform area to enter the **Gas** dialog.
2. Select the desired anesthetic agent tab.
3. Switch on or off **MAC**.

16.10 Changing the Anesthetic Agent

When the anesthetic agent used on the patient is changed, the AG module detects the mixed anesthetic gas during the transition of two anesthetic agents. The time required for completing the replacement of anesthetic agent depends on anesthesia type (low flow or high flow) and the characteristics of anesthetic agents (pharmacokinetics). During the transition of two anesthetic agents, the monitor gives no prompt messages and the MAC value displayed may be inaccurate.

The AG module can identify two anesthetic agents automatically. When the proportion of primary and secondary anesthetic agents in the mixture changes, the AG module can distinguish between them according to their contributions to the MAC value. Then primary and secondary anesthetic agents will be exchanged for display.

16.11 Performing AG Leakage Test

The AG leakage test is required every time before the AG measurement. To perform the AG leakage test, follow this procedure:

1. Plug the AG module into the module rack.
2. Wait for about one minute until the AG module warms up. Completely block the gas inlet of the AG module. Then the alarm message "**AG Airway Occluded**" will appear on the screen.
3. Block the gas inlet for another one minute.
4. Select the **Main Menu** quick key → from the **System** column select **Maintenance** → input the required password → select .
5. Select the **Module** tab → **AG** tab.
6. Check that the current flow rate is less than 10 ml/min, and the alarm message "**AG Airway Occluded**" does not disappear.

This indicates that the module does not leak. If the alarm message disappears, or the flow rate is equal to 10ml/min or greater, it indicates that the module leaks. Perform the leakage test again. If the problem remains, contact your service personnel for help.

16.12 Calibrating the AG Module

Calibrate the AG module every year or when the measured value is outside the specification. To calibrate the AG module, contact the service personnel.

CAUTION

- **Connect the gas outlet to the scavenging system when calibrating the AG module.**
-

16.13 AG Troubleshooting

If the AG airway is occluded, the message **AG Airway Occluded** appears. In this case, check for the follows until the message disappears:

1. Check the airway adapter for occlusion and replace if necessary.
2. Check the sample line for occlusion or kinking and replace if necessary.
3. Check the watertrap for water or occlusion. Empty the watertrap, or replace the watertrap if necessary.
4. Check the gas outlet and the exhaust tube for any occlusion.

If the message does not disappear, it is probably the module fault. Contact the service personnel in this case.

NOTE

- **For the physiological and technical alarm messages, see Appendix D Alarm Messages.**
-

This page intentionally left blank.

17 Review

17.1 Review Overview

Trends are patient data collected over time and displayed in graphic, tabular, or other forms to give you a picture of how the patient's condition is developing. The **Review** dialog enables access to review the events, full disclosure waveforms, and so on.

17.2 Review Dialog

The **Review** dialog contains tabs to display trend data in tabular, graphic, or other forms.

17.2.1 Accessing the Review Dialog

To enter the review dialog, choose any of the following ways:

- Select the **Review** quick key → select the desired tab. If reviewing patient data is password protected, input the monitor's clinical password (local password)..
- Select the **Main Menu** quick key → from the **Review** column select the desired option. If reviewing patient data is password protected, input the monitor's clinical password (local password).

17.2.2 Example Review Dialog

The review pages have a common structure. The graphic trends review page is taken as an example:

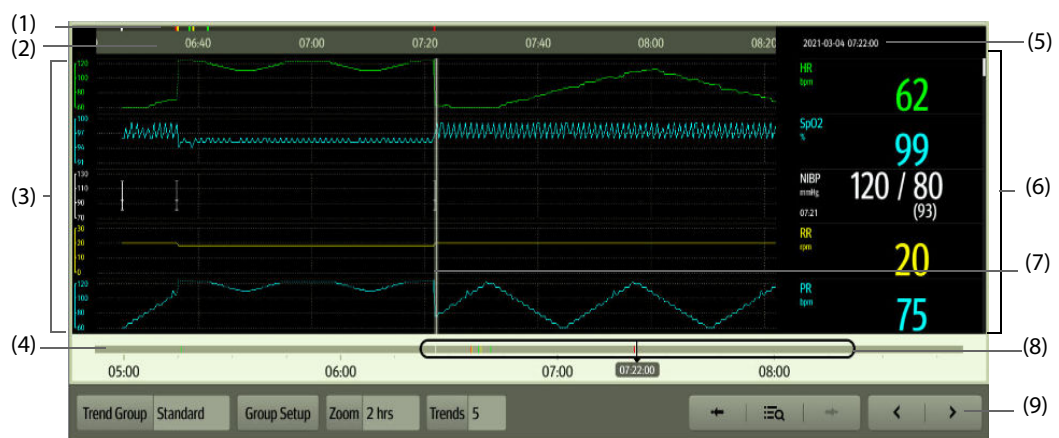





- (1) Event type indicator: different color blocks match different types of events:
 - Red: high priority alarm event
 - Yellow: medium priority alarm event
 - Cyan: low priority alarm event
 - Green: manual event
 - White: operation-related event
- (2) Current screen time line: indicates the time length of the current screen.
- (3) Waveform area: displays trend curves. The color of trend curves is consistent with the color of parameter labels.
- (4) Time line: indicates the entire time length.
 - : indicates the time length of trend data. can be moved within this time length.
 - : indicates the time length of no trend data. cannot be moved within this time length.
 - Different color blocks along the time line indicate events of different types. See the color definition for the event type indicator.

- (5) Event area: displays the event of the cursor time. Selecting the event accesses the event list. If there is no event at the cursor time, the cursor time is displayed.
- (6) Numeric area: displays numeric values at the cursor indicated time. The background color of numeric values matches the alarm priority.
- (7) Cursor: this is adjusted by touching different locations. Adjusting this changes the data displayed in the Event area and Numeric area.
- (8) Slider: indicates the position of current screen time in the entire time length. Dragging this button left or right enables you to locate the trend data at a specific time and also refreshes trend data in current screen accordingly.
- (9) Button area.

17.2.3 Symbols on Review Pages

The following table lists the symbols on review pages.

Symbol	Description
	Slider: indicates the position of current screen time in the entire time length. Dragging the slider left or right enables you to locate the trend data at a specific time and also refreshes data in current screen accordingly.
	Goes to the previous or next event.
	Event list: displays events in a chronological order. The most recent event is displayed at the top. The number of asterisk symbols before an event indicates alarm priority.
	Record button: select it to output patient information and data through the recorder.
	Print button: select it to output patient information and data through the printer.
+	Indicates that the followed parameter is from an external device connected to the monitor.

17.2.4 Common Operations

This section describes common operations for all review pages.

17.2.4.1 Browsing Trend Data

To browse trend data, choose any of the following ways:



- Move the cursor.
- Move the slider .
- Slide your finger on the screen.

17.2.4.2 Viewing Events

You can view the following types of events:

- Manually triggered events
- Parameter-related operation events and alarm-related events, such as starting C.O. measurement
- Operation events not related to parameters, such as system time change

To view events, choose either of the following ways:

- Select  and select the desired event.
- Select  or  to jump to the previous event or next event.

Events are displayed in a chronological order. The most recent event is displayed at the top. The number of asterisk symbols before an event indicates alarm priority as follows:

- !!!: high priority alarm
- !!: medium priority alarm
- !: low priority alarm

17.2.5 Tabular Trends Review Page

The tabular trends review page displays trend data in a tabular form.

17.2.5.1 Entering the Tabular Trends Review Page

To enter the tabular trends review page, choose any of the following ways:

- Select the **Review** quick key → select the **Tabular Trends** tab.
- Select the **Main Menu** quick key → from the **Review** column select **Tabular Trends**.



17.2.5.2 Changing the Tabular Trend Group

To change the tabular trend group, follow this procedure:

1. Enter the tabular trends review page.
2. Set **Trend Group**.

17.2.5.3 Editing the Tabular Trend Group

The setting of the **Trend Group** defines the contents of displayed and printed trends. It is possible to edit any trend group except for the **All** and **Standard** trend groups. To do so, follow this procedure:

1. Enter the tabular trends review page:
2. Select **Group Setup** → select the desired tab.
 - ◆ Rename the trend group (optional): select the  symbol at the upper left corner and input the desired name.
 - ◆ Add parameters: select desired parameters from the **Choices** column, and then select **Add**. Selecting **Add All** adds all parameters (up to the maximum of 83).
 - ◆ Delete parameters: select desired parameters from the **Selected** column, and then select **Delete**. Selecting **Delete All** deletes all parameters except for HR.
 - ◆ Move the position of parameters displayed on the trend page: select desired parameters from the **Selected** column, and then select **Move up**, **Move Down**, **Move to Top**, or **Move to Bottom**.
 - ◆ Display two parameters side by side: select two parameters from the **Selected** column, and then select **Overlap**. Then, the symbol  appears at the right of the overlapped parameters. The overlapped parameters will be displayed side by side in one numerics area and waveform area.
 - ◆ Unoverlap two parameters: select the overlapped parameters from the **Selected** column, and then select **Unoverlap**.

Selecting **Default** will restore the trend group settings to factory defaults.

NOTE

-
- **Trend groups labeled All or Standard cannot be edited.**
 - **The HR parameter and waveform are always displayed in the first row on the trend page. It cannot be deleted or moved.**
-

17.2.5.4 Changing the Resolution of Tabular Trend Data

The interval of tabular trends defines the interval of displaying trend data. A short interval is especially suited for neonatal applications, where the clinical situation may change very quickly. In adult monitoring, where the patient's status typically changes more gradually, a longer interval may be more informative.

To change the interval of trend data, follow this procedure:

1. Enter the tabular trends review page.
2. Select **Interval**.
 - ◆ **5 sec** or **30 sec**: select to view up to 4 hours of tabular trends at an interval of 5 seconds or 30 seconds.
 - ◆ **1 min, 5 min, 10 min, 15 min, 30 min, 1 hr, 2 hrs, or 3 hrs**: select to view up to 120 hours of tabular trends at selected interval.

- ◆ Select parameters, such as NIBP, or C.O., to view the tabular trends when these parameter measurements are acquired.

NOTE

- **Changing between intervals does not typically change the position of the slider or cursor except to round it to the nearest interval, however changing intervals to be 30 seconds or less will move any cursor position more than 4 hours ago to the oldest data less than 4 hours ago.**
-

17.2.5.5 Printing a Tabular Trends Report

To print a tabular trends report, follow this procedure:

1. Enter the tabular trends review page.
2. Select  to enter the **Print Setup** dialog.
3. Set the tabular trends report as described in *21.6.3 Configuring Tabular Trends Reports*.
4. Select **Print** or **Print (All)**.
 - ◆ **Print**: the trend data before the above set **Time**, for the above set **Period**, and at the above set **Interval** will be printed.
 - ◆ **Print (All)**: all the stored trend data will be printed at the review interval.

17.2.5.6 Recording Tabular Trends

To print tabular trends with the recorder, follow this procedure:

1. Enter the tabular trends review page.
2. Select  to enter the **Record Setup** dialog.
3. Respectively set **Start Time** and **End Time** of the tabular trends data.
4. Select **Record** or **Record (All)**.
 - ◆ **Record**: the trend data between the **Start Time** and **End Time** will be recorded.
 - ◆ **Record (All)**: all the stored trend data at the review interval will be recorded.

17.2.6 Graphics Trends Review Page

The graphic trends review page displays trend data in a visual format.

17.2.6.1 Entering the Graphic Trends Review Page

Choose one of the following methods to enter the graphic trends review page:

- Select the **Review** quick key → select the **Graphic Trends** tab.
- Select the **Main Menu** quick key → from the **Review** column select **Graphic Trends**.

17.2.6.2 Changing the Graphic Trend Group

To change the graphic trend group, follow this procedure:

1. Enter the graphic trends review page.
2. Set **Trend Group**.

17.2.6.3 Editing the Graphic Trend Group

1. Enter the graphic trends review page.
2. Select  and select **Group Setup**.
3. Select the desired tab.

For more information, see *17.2.5.3 Editing the Tabular Trend Group* for detail on how to edit the group.

17.2.6.4 Changing the Resolution of Trend Data

To change the length of trend data displayed on the current screen, follow this procedure:

1. Enter the graphic trends review page.
2. Select **Zoom**.
 - ◆ **8 min:** the screen displays 8 minutes of trend data. You can view the most recent one hour of data.
 - ◆ **30 min, 1 hr, 2 hrs, 4 hrs:** the screen displays 30 minutes, one hour, two hours, or four hours of trend data. You can view the most recent four hours of data.
 - ◆ **8 hrs, 12 hrs, 24 hrs, 48 hrs:** the screen displays 8 hours, 12 hours, 24 hours, or 48 hours of trend data. You can view the most recent 120 hours of data.

17.2.6.5 Changing the Number of Waveforms

To change the number of waveforms displayed on the trend review page, follow this procedure:

1. Enter the graphic trends review page.
2. Select  and select **Trends**.
3. Set **Trends**.

17.2.6.6 Printing a Graphic Trends Report

To print a graphic trends report, follow this procedure:

1. Enter the graphic trends review page.
2. Select  to enter the **Print Setup** dialog.
3. Set the graphic trends report as described in *21.6.4 Configuring Graphic Trends Reports*.
4. Select **Print** to print the graphic trend data before the above set **Time** and for the above set **Period**.

17.2.7 Events Review Page

The monitor stores events in real time, including technical alarm events, physiological alarm events, manual events, and operational events. When an event occurs, all the measurement numerics and three event-related waveforms 16 seconds before and after the event are stored.

NOTE

- **Alarms are saved as events and will be maintained if the equipment is powered down. The time of equipment power down is not recorded as an event and cannot be reviewed.**
 - **Earlier events will be overwritten by later ones if the storage capacity is reached.**
 - **A total loss of power does not affect the events already stored.**
-

17.2.7.1 Entering the Events Review Page

To enter the events review page, choose any of the following ways:

- Select the **Review** quick key → select the **Events** tab.
- Select the **Main Menu** quick key → from the **Review** column select **Events**.

The **Event** page displays the event list. Events are displayed in descending chronological order, with the most recent displayed at the top. The number of asterisk symbols before an event indicate alarm priority as described in *7.3.3 Alarm Indicators*.

Different color blocks are displayed on the left of each event to indicate different event types.

- Red: high priority alarm event
- Yellow: medium priority alarm event
- Cyan: low priority alarm event
- Green: manual event
- White: operation-related event

The number of currently selected events and the total number of events are displayed at the top right corner of the event list. For example, 2/4 indicates that the selected event is the second event in the filtered events and the total number of filtered events is 4. **Total** indicates the total number of events. For example: **Total: 28** means that there are a total of 28 events.

17.2.7.2 Configuring the Filter

You can filter events to facilitate event review. To configure the filter, follow this procedure:

1. Enter the **Events** page.
2. Select **Filter**. From the drop-down list, select the desired filter item.

You can create up to two sets of custom filter. To do so, follow this procedure:

1. From the **Filter** drop-down list, select **Custom 1** or **Custom 2** to enter the **Filter Setup** menu.
2. Select the **Name** field to edit the name of the custom filter criterion.
3. Select the desired items.

If you want to review events which happened around certain time, select  → set the time → select **OK**. The cursor then jumps to the event happened closest to the time entered.

17.2.7.3 Editing Events

To edit events, follow this procedure:

1. Enter the **Events** page and tick off the desired events.
2. Select  to edit the selected events.
 - ◆ **Lock**: manually lock the event. Locked events cannot be deleted.
 - ◆ **Note**: enter comments for the event.
 - ◆ **Rename**: allow renaming an event name. Only manual events and arrhythmia events can be renamed if enabled by the hospital's settings. For more information, see 24.6.2 *Renaming Events*.

17.2.7.4 Viewing Event Details

To view waveforms and parameter values at the event time, follow this procedure:

1. Enter the **Events** page.
2. Select **Detail**.

To display beat labels on the first ECG waveform, switch on **Beat Anno**. The white beat labels indicate heart beats classification and may explain suspected, missed, or false arrhythmia calls. Heart beats are classified as follows:

- N = Normal
- V = Ventricular ectopic
- S = Supraventricular premature
- P = Paced
- L = Learning
- ? = Insufficient information to classify beat
- I = Inoperative (for example, Lead Off)
- M = Missed beat

If you switch on **Beat Anno** on the **Events** page, beat labels will also be displayed on the **Full Disclosure** page, and vice versa. Beat labels can be printed out.

17.2.7.5 Printing Event Reports

To print event reports via a printer, follow this procedure:

1. Enter the events review page.
2. Select  to enter the **Print Setup** dialog.

3. Select the desired options.
 - ◆ **Print All Event List:** print the entire event list.
 - ◆ **Print List of Selected Events:** print the list of selected events.
 - ◆ **Print Detail of Selected Events:** print the details of selected events.
 - ◆ **Print Displayed Event Detail:** print the waveforms and parameters of the currently displayed event.
4. Select **Print**.

17.2.7.6 Recording Event Details

To print events details via a recorder, follow this procedure:

1. Enter the events review page.
2. Select the **Detail** button.
3. Select  to print the details of the event.

NOTE

- **When a parameter label is prefixed with the plus sign (+) on a printout, it indicates that the data is from an external device.**

17.2.8 Full Disclosure Review Page

You can review up to 48 hours of waveform data on the full disclosure review page. You can view both the compressed waveforms and numeric values.

17.2.8.1 Entering the Full Disclosure Review Page

To enter the full disclosure review page, choose any of the following ways:

- Select the **Review** quick key → select the **Full Disclosure** tab.
- Select the **Main Menu** quick key → from the **Review** column select **Full Disclosure**.

17.2.8.2 Selecting Waveforms

You can select the waveforms to be displayed and stored. Up to 48 hours of waveforms for all parameters can be stored. When closing the **Select Waveform** dialog, a prompt will inform you of the duration of waveforms that can be saved if the amount is less than 48 hours. To save and display the desired waveforms, follow this procedure:

1. Enter the full disclosure review page.
2. Select **Setup** to enter the **Select Waveform** page.
3. Select the **Storage** tab and set the desired waveforms to be stored in the monitor. Select the **Display (Maximum: 3)** tab and set the desired waveforms to be displayed on the **Full Disclosure** page.

NOTE

- **Parameter labels from external devices are prefixed with the plus sign (+).**
- **Storing more waveforms may shorten the storage time to less than 48 hours. Please adjust the waveforms stored with this consideration.**

In case of alarms, the background of the compressed waveform is highlighted with a colored block during the alarm time:

- Red: high alarm priority
- Yellow: medium alarm priority
- Cyan: low alarm priority

17.2.8.3 Setting the Scale and Duration

To set the length and size of displayed compressed waveforms, follow this procedure:

1. Enter the full disclosure review page.
2. Set the waveforms scale in either of the following ways:
 - ◆ Select  and select the **Scale** button.
 - ◆ Select the waveform label.
3. Select **Duration** to set the length of displayed waveforms.
4. Select the parameter label beside the waveforms to set scale for each parameter.

17.2.8.4 Viewing Details of Compressed Waveforms

To view the full waveforms and numeric values, follow this procedure:

1. Enter the full disclosure review page.
2. Select **Detail**.

You can perform the following operations on the this page:

- Switch on **Beat Anno**. For more information, see *17.2.7.4 Viewing Event Details*.
- Select  and select **Speed, ECG Gain, or Save As Event**.
- Select **Overview** to switch to the compressed waveform view.

17.2.8.5 Printing the Full Disclosure Waveform Report

To print a compressed waveform report, follow this procedure:

1. Enter the full disclosure review page.
2. Select  to enter the **Print Setup** dialog.
3. Select waveform type you want to print:
 - ◆ **Print Waveform Overview**: compressed waveform of selected period will be printed. This option is only available when printing from the Overview or compressed waveform view.
 - ◆ **Print Displayed Waveform Detail**: parameter values and all stored waveforms around the cursor time will be printed. This option is only available when printing from the Detail view.
4. Select **Print**.

17.2.8.6 Recording the Details of the Compressed Waveform

To record a Full Disclosure Detail Record Report, follow this procedure:

1. Enter the **Full Disclosure** page.
2. Select **Detail**.
3. Select .

17.2.9 OxyCRG Review Page

You can review up to 48 hours worth of 4 minute trend curves on the OxyCRG review page. The OxyCRG review functionality is available for neonatal monitoring only.

NOTE

-
- **OxyCRG Review Page is available only when Patient Category is set to Neo.**
-

17.2.9.1 Entering the OxyCRG Review Page

To enter the OxyCRG review page, choose any of the following ways:

- From the OxyCRG screen, select the ABD events list area.
- Select the **Review** quick key → select the **OxyCRG** tab.
- Select the **Main Menu** quick key → from the **Review** column select **OxyCRG**.

17.2.9.2 The Display of the OxyCRG Review Page

The following figure shows the OxyCRG screen:

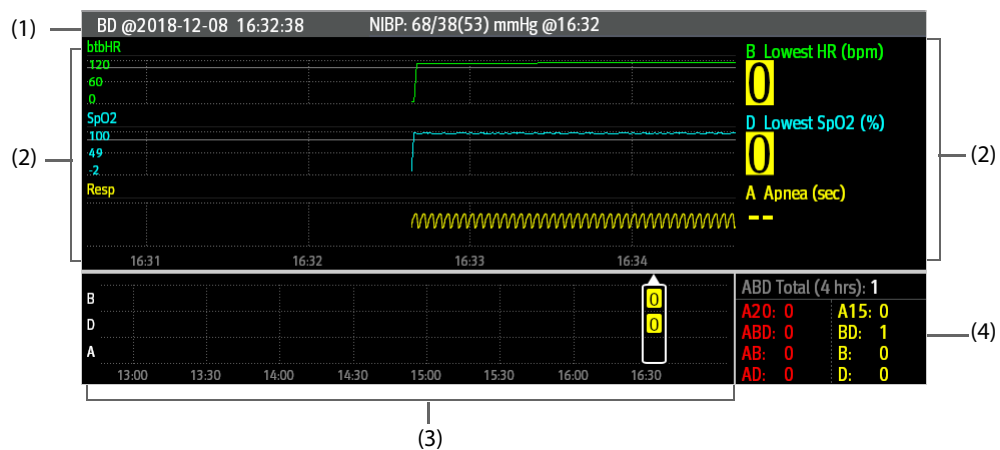

- (1) Event title area: displays information of the selected event, such as the event type and time.
- (2) Event detail area: displays 4 minutes of parameter trends and compressed waveform, and parameter values of the selected event.
- (3) Event summary area: displays ABD events within the **Zoom** period. The selected event is enclosed in a white frame.
- (4) Event statistics area: displays the total number of ABD events and the numbers of each event within the **Zoom** period.

17.2.9.3 Changing the Resolution of Trend Curves

To set the resolution of trend curves, follow this procedure:

1. Enter the OxyCRG review page.
2. Set **Zoom**.

NOTE

- If the **Zoom** is set for a large duration (for example, 8 hrs), the screen may show "No Patient Data" for the first several minutes of data collection (for example, 6 minutes), but data will be shown after enough data has been collected.

17.2.9.4 Printing an OxyCRG Review Report

To print an OxyCRG review report, follow this procedure:

1. Enter the OxyCRG review page.
2. Select  to enter the **Print Setup** dialog.
3. Select **Print**. The report duration corresponds to the duration of data shown on the screen.

17.2.10 ST Review Page

When ST analysis is enabled, the monitor saves ST segments and values at an interval of one minute. You can review the latest 120 hours of ST data.

17.2.10.1 Entering the ST Review Page

To enter the ST review page, choose either of the following ways:

- Select the **Review quick key** → select the **ST** tab.
- Select the **Main Menu** quick key → from the **Review** column select **ST**.

17.2.10.2 Setting the ST Reference

You can set the currently displayed ST as reference. To do so, follow this procedure:

1. Enter the ST review page.
2. Select **Set Reference**.

NOTE

- **The ST baseline is used as ST reference by default.**
-

17.2.10.3 Displaying/Hiding the ST Reference

To display or hide ST reference, follow this procedure:

1. Enter the ST review page.
2. Select **Display Reference** or **Hide Reference**.

17.2.10.4 Displaying/Hiding Markers

To display or hide markers, follow this procedure:

1. Enter the ST review page.
2. Select **Display Marker** or **Hide Marker**.

17.2.10.5 Printing ST Data

To print ST data, follow this procedure:

1. Enter the ST review page.
2. Select .

17.3 Reviewing Discharged Patients

For discharged patients, you can review the trend data in the review page.

17.3.1 Checking the Data of a Discharged Patient

1. Access the **Discharged Patients** dialog box by either of the following ways:
 - ◆ Select the **Discharged Patients** quick key. If viewing discharged patients is password protected, input the user name and password (the user password saved in the MLDAP server).
 - ◆ Select the **Main Menu** quick key → from the **Patient Management** column select **Discharged Patients**. If viewing discharged patients is password protected, input the user name and password (the user password saved in the MLDAP server).
2. From the patient list select the desired patient.
3. Select **Detail**. If reviewing patient data is password protected, input the monitor's clinical password (local password).

17.3.2 Checking the Information of a Discharged Patient

1. Access the **Discharged Patients** dialog box by either of the following ways:
 - ◆ Select the **Discharged Patients** quick key. If viewing discharged patients is password protected, input the user name and password (the user password saved in the MLDAP server).
 - ◆ Select the **Main Menu** quick key → from the **Patient Management** column select **Discharged Patients**. If viewing discharged patients is password protected, input the user name and password (the user password saved in the MLDAP server).
2. From the patient list select the desired patient.
3. Select **Detail**. If reviewing patient data is password protected, input the monitor's clinical password (local password).
4. Select  to enter the **Patient Management** dialog box.

This page intentionally left blank.

18 Clinical Assistive Applications (CAA)

The Clinical Assistive Applications (CAA) function integrates some commonly used clinical guidelines and tools into the monitor. It puts the currently monitoring parameter measurements together and provides comprehensive analysis results.

CAA is not intended to replace the competent judgment of a clinician. It must be used in conjunction with observation of clinical signs and symptoms.

18.1 Checking Software Licenses

A license is required to run Early Warning Score (EWS) in the monitor:

To check the licenses, select the **Main Menu** quick key → select **License** → **Local**.

To install the licenses, follow this procedure:

1. Connect the USB drive with the licenses in to the monitor's USB connector.
2. Select the **Main Menu** quick key → select **License** → select **External**.
3. Select **Install**.

18.2 Early Warning Score (EWS)

The Early Warning Scores (EWS) can help you recognize the early sign of deterioration in patients based on vital signs and clinical observations. It is based on the "Royal College of Physicians (2015) National Early Warning Score (NEWS2): Standardizing the assessment of acute illness severity in the NHS, Report of a Working Party. RCP, London. Depending on the score calculated, appropriate recommendations are displayed.

The monitor supports the following scores:

- MEWS (Modified Early Warning Score)
- NEWS (National Early Warning Score)
- NEWS2 (National Early Warning Score 2)
- Custom Score

A subscore is given for each parameter based on the measured or entered value. When all the required parameters are entered or measured, the subscores are added together to calculate the total early warning score. Each subscore has a color coding to indicate associated level of risk. When the total score is outside of the thresholds, actions are recommended. MEWS, NEWS and NEWS2 can give total scores.

Custom Score is based on user-defined parameters.

MEWS, NEWS and NEWS2 are intended for adult patients only. The patient category applied to the Custom Score is defined by Mindray Clinical Score Configuration Tool. For more information, see *Mindray Clinical Scoring Config Tool Instruction for Use (P/N: 046-012986-00)*.

WARNING

- **The EWS function is not intended for pediatric and neonatal patients.**
 - **EWS should not be used as the sole basis for diagnosis or therapy decisions. It is not intended to replace the competent judgment of a clinician. The EWS scores and recommended actions must be used in conjunction with observation of clinical signs and symptoms.**
 - **MEWS and NEWS are intended for adult patients only. NEWS is not applicable to pregnant woman and COPD (Chronic Obstructive Pulmonary Disease) patients.**
-

NOTE

- **The EWS scores does not trigger any alarms and cannot used for continuous monitoring.**
-

18.2.1 Displaying the EWS Numerics Area

To display the EWS numerics area, follow this procedure:

1. Access **Tile Layout** in either of the following ways:
 - ◆ Select the **Screen Setup** quick key → select the **Tile Layout** tab.
 - ◆ Select the **Main Menu** quick key → from the **Display** column select **Tile Layout**.
2. Select the parameter area where you want to display the EWS score, and then from the popup list select **EWS**.

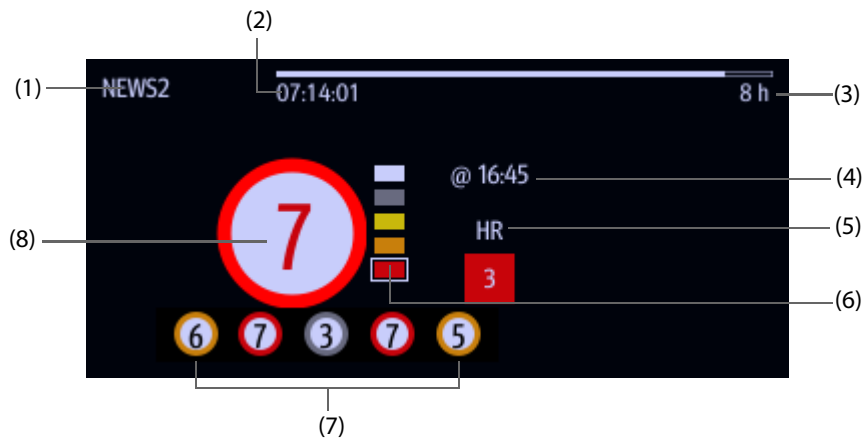



- (1) EWS protocol label
- (2) Scoring countdown: time to the next scoring.
- (3) Scoring interval
- (4) The current scoring time
- (5) Single parameter whose score reaches 3
- (6) Risk level indicator. The level of risk increases from top down. The current level is enclosed by a white square frame.
- (7) History total score. The rightmost one is the latest history score.
- (8) Total score. The color of the circle indicates the level of risk.

18.2.2 Accessing the EWS Screen

Access the EWS window in any of the following ways:

- Select the EWS parameter area
- Select the **EWS** quick key.
- Select the **Screen Setup** quick key → select the **Choose Screen** tab → select **EWS**.
- Select the **Main Menu** quick key → from the **CAA** column select **EWS**.

When the EWS screen is hidden as , you can also choose one of the following methods to quickly enter the EWS screen.

- Swipe left or right across the touchscreen with two fingers until you switch to the EWS screen.
- Swipe right across the touchscreen with a single finger,
- Select the  button.

Take NEWS2 as an example, the EWS screen is shown as follows. Your screen may be slightly different due to the configuration.

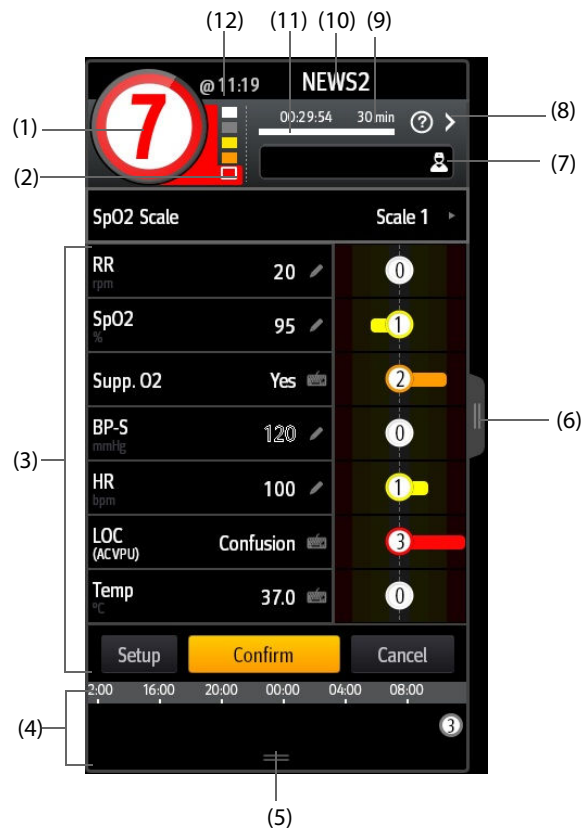

- (1) Total score. The color of the circle indicates the level of risk.
- (2) Risk level indicator. The level of risk increases from top down. The current level is enclosed by a white frame.
- (3) Parameter area: displays the subscore and parameter value of each parameter. The keyboard symbol indicates that the parameter value is manually entered.
- (4) History total scores area: selecting this area or swiping up with one finger can review the trends of total score and each subscore.
- (5) Selecting this button expands the History Total Scores area where you can review the trends of the total score and each subscore.
- (6) Selecting this button or swiping right across the screen with one finger displays the trends of total score and parameter values for scoring.
- (7) Clinician ID (displays only when the Clinician ID is enabled): allows inputting the Clinician ID to associate with the EWS score. For more information, see *24.4.1 Enabling Inputting the Clinician ID*.
- (8) Select this button to see the clinical response to the current score
- (9) Scoring interval
- (10) EWS protocol label
- (11) Scoring countdown: time to the next scoring.
- (12) The scoring time

18.2.3 Performing EWS Scoring

To perform scoring, follow this procedure:

1. Select **Reset** to clear the previous score and update values of currently monitored parameters and relevant subscores.
2. For NEWS2, set the **SpO2 Scale**.
 - ◆ **Scale 1:** for patient without hypercapnic respiratory failure.
 - ◆ **Scale 2:** for patients with a prescribed oxygen saturation requirement of 88–92% (for example, in patients with hypercapnic respiratory failure).
3. Measure or manually enter other required parameters and observations.
4. If the clinician ID is enabled, input the clinician information by selecting , and then manually entering the information, or by scanning the clinician's barcode.
5. Select **Calculate** to get the total score.
6. If **Score Confirmation** is enabled, select **Confirm** to save current scoring, or select **Cancel** to give up current scoring. Refer to section 18.2.4.2 *Setting the Scoring Confirmation Switch* for more information.

CAUTION

- **The decision to use Scale 2 of the SpO2 Scale should be made by a competent clinical decision maker and should be recorded in the patient's clinical notes.**

NOTE

- **Before calculating the score, select Reset to clear the previous score.**
- **The keyboard symbol at the right of the parameter value indicates that the value is manually entered.**
- **You can get the score only when all required parameters have been measured or entered.**
- **When a patient is discharged or the monitor is turned off, the clinician ID is cleared.**

18.2.4 Changing EWS Settings

18.2.4.1 Changing the Scoring Protocol

The monitor is configured with a default scoring protocol. To change the scoring protocol, follow this procedure:

1. From the EWS page select **Setup**.
2. Set **Score**.

18.2.4.2 Setting the Scoring Confirmation Switch

To select if confirmation is required before saving score, follow this procedure:

1. From the EWS page select **Setup**.
2. Set **Score Confirmation** switch.
 - ◆ **Off:** the monitor automatically saves the scoring result after the scoring is completed.
 - ◆ **On:** you need to confirm that whether the scoring result is saved or not after the scoring is completed.

18.2.4.3 Setting the Manual Data Timeout

The manually input parameter data can be configured to become invalid after a preset time. To set the timeout period for the input data, follow this procedure:

1. From the EWS screen select **Setup**.
2. From the **Manual Data Timeout** area, select a desired parameter and set its timeout period.

NOTE

- **If the data is expired and not updated, the monitor displays the corresponding parameter score in outline font, and gives a timeout alarm.**
-

18.2.4.4 Setting Auto Scoring

The monitor automatically starts scoring at the preset interval. To set auto scoring, follow this procedure:

1. From the EWS page select **Setup**.
2. Set **Auto Scoring**:
 - ◆ **Interval**: the monitor automatically starts scoring at the preset interval.
 - ◆ **NIBP**: the monitor automatically starts scoring at the completion of each NIBP measurement.
 - ◆ **Alarm**: the monitor automatically starts scoring when an alarm occurs to the parameter for scoring.
 - ◆ If no option is selected, the monitor does not initiate auto scoring.

18.2.4.5 Setting Auto Scoring Interval

1. From the EWS page select **Setup**.
2. Set **Interval**:
 - ◆ **By Score**: the monitor automatically starts scoring as per the interval selected for corresponding total score.
 - ◆ **5 min - 24 h**: If **Auto Scoring** is set to **Interval**, the monitor automatically starts scoring as per the selected interval. If **Auto Scoring** is not set to **Interval**, the countdown timer of manual scoring is selected.

18.2.5 Viewing Historical Scores

From the EWS screen, you can view the total score or subscores of the past 24 hours. To do so, choose either of the following ways:

- Select the history total score area.
- From the history total score area, swipe up with a finger.

To return to the EWS screen, select  from the top of the historical score screen. Refer to *18.2.2 Accessing the EWS Screen* for the position of the history total score area.

18.2.6 Viewing Parameter Trends

From the EWS screen, you can view the 24-hour graphic trends of each parameter used for scoring. To do so, choose either of the following ways:

- Select the  button.
- Swipe right across the EWS screen with a finger.

From the screen of parameter trends, selecting the  button or swiping left across the screen with a finger can return to the EWS screen.

Refer to *18.2.2 Accessing the EWS Screen* for the position of the  button.

18.3 Glasgow Coma Scale (GCS)

The Glasgow Coma Scale (GCS) function is based on Teasdale's *Assessment of Coma and Impaired Consciousness-A Practical Scale (Lancet, 1974)*. Three aspects of behavior are independently measured: eye opening, verbal response, and motor response. The scores are added together to indicate that patient's level of consciousness.

GCS is intended for adults and pediatric patients.

CAUTION

- **GCS is intended as an adjunct in patient assessment and must be used in conjunction with observation of clinical signs and symptoms.**
 - **GCS is not applied to patients that are sedated, muscularly relaxed, with artificial airway, drunk, or in status epilepsies.**
 - **Please refer to hospital policy regarding acceptable use of GCS.**
 - **When applied to children younger than five years old or elder people who are slow, the GCS score might be low.**
-

18.3.1 Displaying the GCS Parameter Area

To display the GCS parameter area, follow this procedure:

1. Access **Tile Layout** in either of the following ways:
 - ◆ Select the **Screen Setup** quick key → select the **Tile Layout** tab.
 - ◆ Select the **Main Menu** quick key → from the **Display** column select **Tile Layout**.
2. Select the parameter area where you want to display the GCS score, and then from the popup list select **GCS**.

The following figure shows the GCS parameter area. The display may be configured to look slightly different.

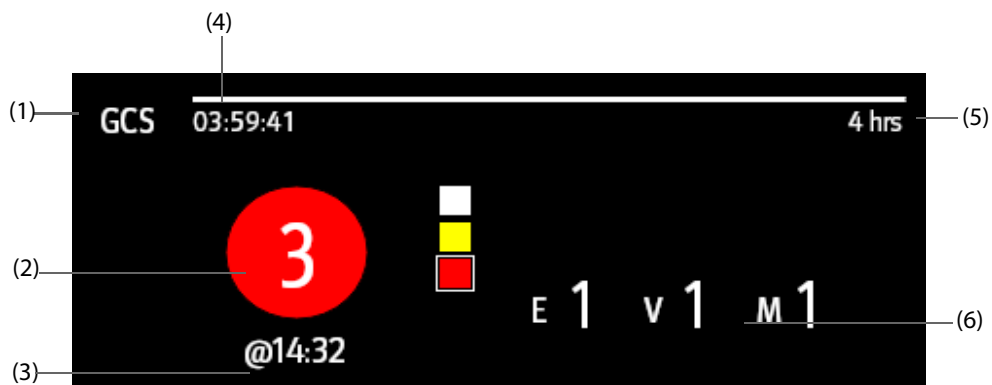

- (1) GCS label
- (2) Total score and level of consciousness. The color of the circle indicates the level of risk.
- (3) Scoring time
- (4) Scoring countdown: time to the next scoring
- (5) Scoring interval
- (6) Subscores
 - ◆ E: eye opening
 - ◆ V: verbal response
 - ◆ M: motor response

18.3.2 Accessing the GCS Dialog

Enter the GCS dialog in any of the following ways:

- Select the GCS parameter area.
- Select the **GCS** quick key.
- Select the **Main Menu** quick key → from the **CAA** column select **GCS**.

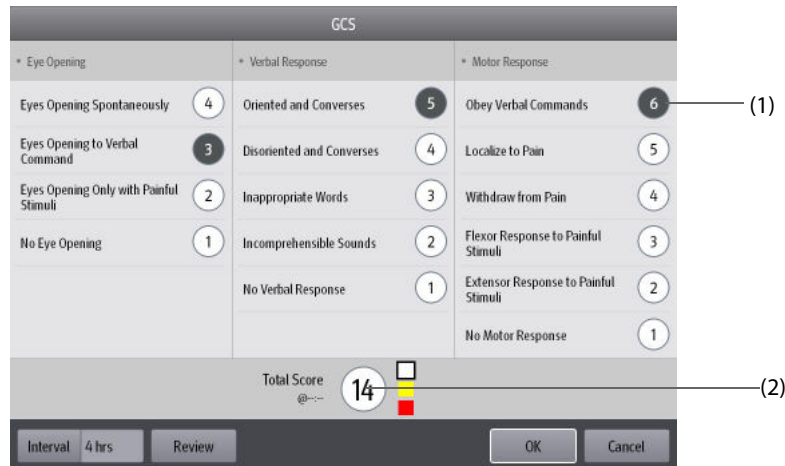

(1) Subscore

(2) Total score

18.3.3 Performing GCS Scoring

To perform scoring, follow this procedure:

1. From the **Eye Opening** area, **Verbal Response** area, and **Motor Response** area, respectively select an item that represents the patient’s status.
2. Select **OK** to accept the total score.

The following table lists the default score range and color of relevant consciousness level.

Level	Range	Color
Mild damage	13-15	White
Moderate damage	9 - 12	Yellow
Severe damage	3 - 8	Red

NOTE

- The GCS score range is adjustable. Refer to 24.4.4 *Setting GCS Threshold for Each Consciousness Level* for the method of changing the high limit and low limit of each consciousness level.

18.3.4 Setting GCS Scoring Interval

From the **GCS** dialog, select **Interval** to set GCS scoring interval. When the scoring interval is reached and you do not perform another scoring, the score will be invalidated and displayed as outline fonts.

18.3.5 Reviewing GCS Trend Data

From the **GCS** dialog, select **Review** to enter the **Review** dialog and view the GCS trend data from the **Tabular Trends**.

18.4 ECG 24h Summary

The ECG 24h Summary provides ECG statistics of the current patient over the latest 24 hours. It also displays the patient's typical ECG strips.

NOTE

- The ECG 24h Summary function is intended for the current patient. It is not intended for discharged patients.
- Pacer statistics is intended for paced patients. Pacer statistics is available only when the Paced setting is Yes.
- ST statistics is available only when ST analysis is switched on.
- QT statistics is available only when QT analysis is switched on.
- Data displayed in the ECG 24h Summary is not recalculated.
- A License is required for the ECG 24h Summary function.

18.4.1 Opening the ECG 24h Summary Window

To open the ECG 24h Summary window, choose either of the following ways:

- Select the **ECG 24h Sum** quick key.
- Select the **Main Menu** quick key → from the **Summary** column select **ECG 24h Summary**.

18.4.2 The Display of ECG 24h Summary

The following figure is an example of the ECG 24h Summary window:

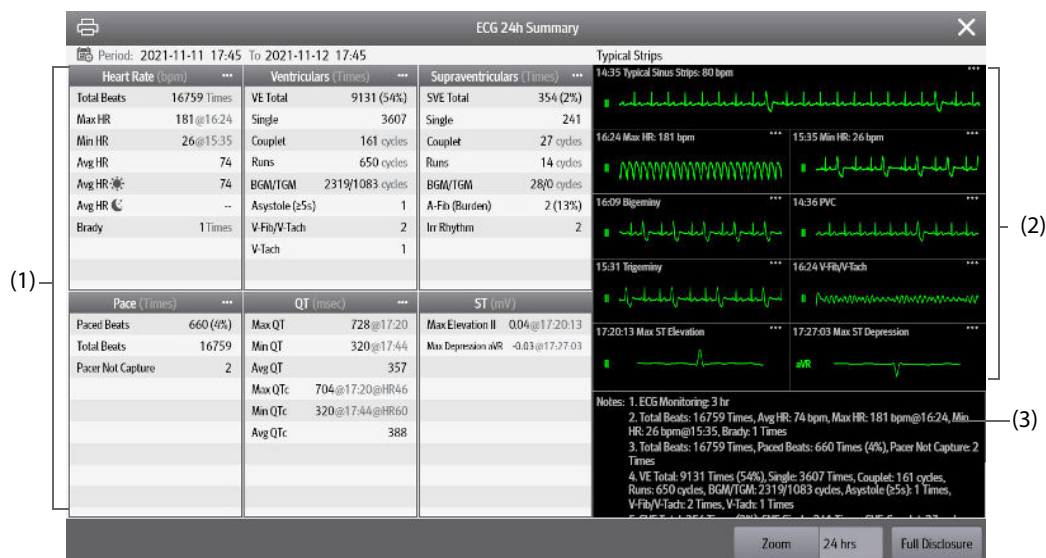

- (1) ECG statistics, including the following items:
 - Statistics of heart rates
 - Statistics of ventricular beats and ventricular events
 - Statistics of supraventricular beats and supraventricular events
 - Statistics of QT/QTc measurements
 - Statistics of maximum ST elevations and depressions
 - Statistics of pace
- (2) Typical ECG strips
- (3) Notes: includes additional information on the ECG 24h Summary

18.4.3 Selecting Typical ECG Strips

Taking V-Tach as an example, to select typical V-Tach waveform, select the currently displayed V-Tach waveform, from the popup list select the desired waveform as typical V-Tach waveform.

If no V-Tach occurs to the patient within 24 hours, an add symbol **+** is displayed in the V-Tach area. You can select the add symbol to display a typical ECG waveform of other event in this area.

18.4.4 Setting the Statistical Duration of the ECG 24h Summary

You can view a maximum of 24 hours of ECG statistics through the ECG 24h Summary. To select the statistical duration, select **Zoom**.

18.4.5 Reviewing the ECG Summary

Selecting any of the statistic area can access corresponding trends and events review. Selecting **Full Disclosure** can review ECG full disclosure waveforms. For more information, see 15.2.8 *Full Disclosure Review Page*.

18.5 OxyCRG Expand Screen

The OxyCRG Expand screen displays the following information:

- Realtime values and waveforms of ECG, Resp, and SpO₂.
- Realtime OxyCRG
- A timer
- SpO₂ statistics

The OxyCRG Expand screen facilitates viewing the result of neonatal monitoring.

NOTE

- **The OxyCRG Expand screen is not intended for adult and pediatric patients.**

18.5.1 Accessing the OxyCRG Expand Screen

Access the OxyCRG Expand screen in any of the following ways:

- Select the OxyCRG Expand quick key.
- Select the **Screen Setup** quick key → select the **Choose Screen** tab → select OxyCRG Expand.
- Select the **Main Menu** quick key → from the **CAA** column select OxyCRG Expand.

The following figure shows the OxyCRG Expand screen. Your screen may be slightly different due to the configuration.

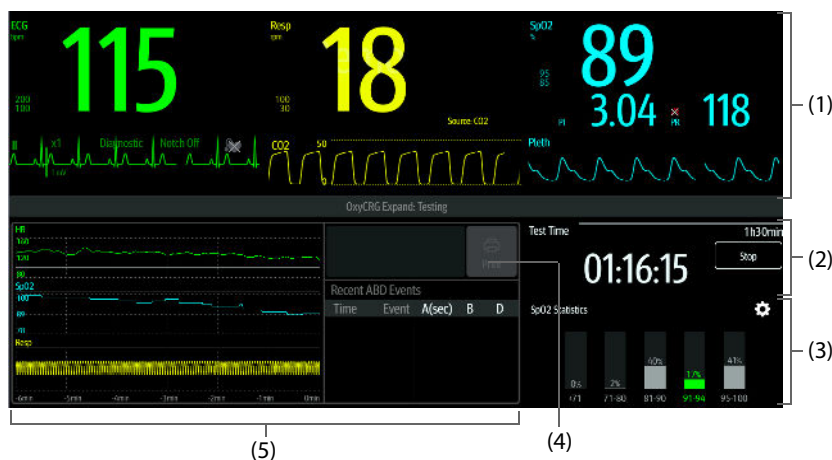

- (1) Parameter numerics and waveforms area
- (2) Timer area

- (3) SpO₂ statistics area: for more information, see *4.4.4 Setting Parameter Statistics*.
- (4) The printer icon: select it to print the OxyCRG Expand report.
- (5) OxyCRG: for more information, see *4.3 The OxyCRG Screen*.

18.5.2 Change Parameter Settings

To change parameter settings, select corresponding parameter numerics or waveform area.

18.5.3 Starting the Timer

A timer is used to record the neonatal monitoring time. The monitoring time is 90 minutes by default. For more information on changing the timer settings, see *22.3 Setting the Timer*.

To start the timer, from the Timer area select **Start**.

18.5.4 Printing the OxyCRG Report

After the neonatal monitoring is finished, select the **Print** icon at the top right corner of the OxyCRG to preview or print the monitoring report.

18.5.5 Reviewing the OxyCRG Events

To review the OxyCRG Expand events, select the ABD events area of the OxyCRG to enter the OxyCRG review page.

For more information on OxyCRG review, see *17.2.9 OxyCRG Review Page*.

19 Calculation

19.1 Calculation Overview

The monitor provides calculation functions. The calculated values, which are not directly measured, are computed based on the values you provide. The calculation function is independent of other monitoring functions and can therefore be used for patients being monitored by other monitors. Any operation in a calculation dialog does not affect the patient monitored by the current monitor.

You can perform the following calculations:

- Drug calculations
- Hemodynamic calculations
- Oxygenation calculations
- Ventilation calculations
- Renal calculations

19.2 Calculation Safety Information

WARNING

- **Decisions on the choice and dosage of drugs administered to patients must always be made by the physician in charge. The drug calculations are based on the values input; it does not check the plausibility of the calculation performed.**
 - **Check that the entered values are correct and the calculated values are appropriate. Mindray assumes no responsibility for any consequences caused by wrong entries and improper operations.**
-

19.3 Drug Calculations

19.3.1 Performing Drug Calculations

To perform drug calculations, follow this procedure:

1. Access the drug calculator by either of the following ways:
 - ◆ Select the **Calculations** quick key → select the **Drug** tab.
 - ◆ Select the **Main Menu** quick key → from the **Calculations** column select **Drug**.
2. Set **Drug Name** and **Patient Category**. If the dose of drug is weight dependent, you must input the patient's weight. The dose calculation program has a library of commonly used drugs, while Drug A through Drug E are user defined.
3. Enter the known values, for example **Drug Amount** and **Solution Volume**.
4. Select **Calculate**. The calculated values are indicated by red arrows.

NOTE

- **If available, the patient category and weight from the Patient Management dialog are automatically entered when you first access drug calculation. You can change the patient category and weight. This will not change the patient category and weight stored in the patient demographic information.**
-

19.3.2 Checking the Titration Table

The titration table shows information on the currently used drugs. Use the titration table to see what dose of a drug your patient will receive at different infusion rates. To access the titration table, follow this procedure:

1. Access drug calculator by either of the following ways:
 - ◆ Select the **Calculations** quick key.
 - ◆ Select the **Main Menu** quick key → from the **Calculations** column select **Drug**.
2. Select the **Titration Table** tab.
3. Select **Dose Type** to set the type of dose unit in the titration table.
4. Select **Interval** to set the interval between two adjacent titration table items.

You can select how to display the titration table:

- **Dose:** the titration table is listed in the sequence of increased drug dose.
- **Infusion Rate:** the titration table is listed in the sequence of increased infusion rate. By default the resolution of the infusion rate is one (1). By selecting **Exact Rate** the resolution of the infusion rate can reach 0.01 so that you can display the infusion rate more accurately.

19.3.3 Drug Calculation Formula

Description	Unit	Formula
Dose	Dose/hr Dose/min	$\text{Dose} = \text{Infusion Rate} \times \text{Concentration}$
Dose (weight based)	Dose/kg/hr Dose/kg/min	$\text{Dose (weight based)} = \text{Infusion Rate} \times \text{Concentration} / \text{Weight}$
Drug Amount	g series: mcg, mg, g unit series: Unit, KU, MU mEq series: mEq	$\text{Drug Amount} = \text{Dose} \times \text{Duration}$
Drug Amount (weight based)	g series: mcg, mg, g unit series: Unit, KU, MU mEq series: mEq	$\text{Drug Amount (weight based)} = \text{Dose} \times \text{Duration} \times \text{Weight}$
Duration	hr	$\text{Duration} = \text{Amount} / \text{Dose}$
Duration (weight based)	hr	$\text{Duration (weight based)} = \text{Amount} / (\text{Dose} \times \text{Weight})$
Concentration	mcg/ml, mg/ml, g/ml, Unit/ml, KU/ml, MU/ml, mEq/ml	$\text{Concentration} = \text{Drug Amount} / \text{Solution Volume}$
Solution volume	ml	$\text{Volume} = \text{Infusion Rate} \times \text{Duration}$
Infusion rate	ml/hr	$\text{Infusion Rate} = \text{Dose} / \text{Concentration}$
Infusion rate (weight based)	g·ml/hr	$\text{Infusion Rate} = \text{Dose} \times \text{Weigh} / \text{Concentration}$

19.3.4 Titration Table Calculation Formula

Description	Unit	Formula
Infusion Rate	ml/hr	$\text{Infusion Rate} = \text{Dose} / \text{Concentration}$
Infusion Rate (weight based)	ml/hr	$\text{Infusion Rate} = \text{Weight} \times \text{Dose} / \text{Concentration}$
Dose	Dose/hr Dose/min	$\text{Dose} = \text{Infusion Rate} \times \text{Concentration}$
Dose (weight based)	Dose/kg/hr Dose/kg/min	$\text{Dose (weight based)} = \text{INF Rate} \times \text{Concentration} / \text{Weight}$

19.4 Hemodynamic Calculations

The monitor provides the hemodynamic calculation function and can save the results of up to 10 calculations, which are displayed in groups.

19.4.1 Performing Hemodynamic Calculations

To perform hemodynamic calculation, follow this procedure:

1. Access hemodynamic calculation by either of the following ways:
 - ◆ Select the **Calculations** quick key → **Hemodynamics** tab.
 - ◆ Select the **Main Menu** quick key → from the **Calculations** column select **Hemodynamics**.
2. Enter the known values. For a patient who is being monitored, the currently measured values are automatically entered.
3. Select **Calculate**.

A calculated value greater than the normal upper limit is indicated by an up arrow “↑”. A calculated value lower than the normal lower limit is indicated by a down arrow “↓”.

You can select **Range** to show the normal range of each parameter.

19.4.2 Input Parameters for Hemodynamic Calculations

Input Parameter	Label	Unit
cardiac output	C.O.	L/min
heart rate	HR	bpm
pulmonary artery wedge pressure	PAWP	mmHg
artery mean pressure	PMAP	mmHg
pulmonary artery mean pressure	PA Mean	mmHg
central venous pressure	CVP	mmHg
end-diastolic volume	EDV	ml
height	Height	cm
weight	Weight	kg

NOTE

- If you enable Use PA-D as PAWP, PA-D value will be used to replace PAWP value for hemodynamic calculation. For more information, refer to 13.7.5 Setting the Use PA-D as PAWP Switch.

19.4.3 Calculated Parameters and Formulas for Hemodynamic Calculations

Calculated Parameters	Label	Unit	Formula
cardiac index	C.I.	L/min/m ²	C.I. (L/min/m ²) = C.O. (L/min)/BSA (m ²)
body surface area	BSA	m ²	BSA (m ²) = Wt ^{0.425} (kg) × Ht ^{0.725} (cm) × 0.007184
stroke volume	SV	ml	SV (ml) = 1000 × C.O. (L/min)/HR (bpm)
stroke index	SVI	ml/m ²	SVI (ml/m ²) = SV (ml)/BSA (m ²)
systemic vascular resistance	SVR	DS/cm ⁵	SVR (DS/cm ⁵) = 79.96 × [PAMAP (mmHg) - CVP (mmHg)]/C.O. (L/min)
systemic vascular resistance index	SVRI	DS·m ² /cm ⁵	SVRI (DS·m ² /cm ⁵) = SVR (DS/cm ⁵) × BSA (m ²)

Calculated Parameters	Label	Unit	Formula
pulmonary vascular resistance	PVR	DS/cm ⁵	$PVR (DS/cm^5) = 79.96 \times [PAMAP (mmHg) - PAWP (mmHg)]/C.O. (L/min)$
pulmonary vascular resistance index	PVRI	DS·m ² /cm ⁵	$PVRI (DS \cdot m^2/cm^5) = PVR (DS/cm^5) \times BSA (m^2)$
left cardiac work	LCW	kg·m	$LCW (kg \cdot m) = 0.0136 \times PAMAP (mmHg) \times C.O. (L/min)$
left cardiac work index	LCWI	kg·m/m ²	$LCWI (kg \cdot m/m^2) = LCW (kg \cdot m)/BSA (m^2)$
left ventricular stroke work	LVSW	g·m	$LVSW (g \cdot m) = 0.0136 \times PAMAP (mmHg) \times SV (ml)$
left ventricular stroke work index	LVSWI	g·m/m ²	$LVSWI (g \cdot m/m^2) = LVSW (g \cdot m)/BSA (m^2)$
right cardiac work	RCW	kg·m	$RCW (kg \cdot m) = 0.0136 \times PAMAP (mmHg) \times C.O. (L/min)$
right cardiac work index	RCWI	kg·m/m ²	$RCWI (kg \cdot m/m^2) = RCW (kg \cdot m)/BSA (m^2)$
right ventricular stroke work	RVSW	g·m	$RVSW (g \cdot m) = 0.0136 \times PAMAP (mmHg) \times SV (ml)$
right ventricular stroke work index	RVSWI	g·m/m ²	$RVSWI (g \cdot m/m^2) = RVSW (g \cdot m)/BSA (m^2)$
ejection fraction	EF	%	$EF (\%) = 100 \times SV (ml)/EDV (ml)$
End-diastolic volume index	EDVI	ml/m ²	$EDVI (ml/m^2) = EDV (ml)/BSA (m^2)$
End-systolic Volume	ESV	ml	$ESV (ml) = EDV (ml) - SV (ml)$
End-systolic Volume index	ESVI	ml/m ²	$ESVI (ml/m^2) = ESV (ml)/BSA (m^2)$

19.5 Oxygenation Calculations

The monitor provides the oxygenation calculation function and can save the results of up to 10 calculations, which are displayed in groups.

19.5.1 Performing Oxygenation Calculations

To perform oxygenation calculations, follow this procedure:

1. Access oxygenation calculation by either of the following ways:
 - ◆ Select the **Calculations** quick key → **Oxygenation** tab.
 - ◆ Select the **Main Menu** quick key → from the **Calculations** column select **Oxygenation**.
2. Enter the known values. For a patient who is being monitored, the currently measured values are automatically entered.
3. Select **Calculate**.

A calculated value greater than the normal upper limit is indicated by an up arrow "↑". A calculated value lower than the normal lower limit is indicated by a down arrow "↓".

In the **Oxygenation** page, you can also perform the following operations:

- Select **OxyCont Unit**, **Hb Unit**, and **Pressure Unit**. Then corresponding parameter values will be automatically converted and updated accordingly.
- Select **Range** to show the normal range of each parameter.

19.5.2 Input Parameters for Oxygenation Calculations

Input Parameter	Label	Unit
cardiac output	C.O.	L/min
percentage fraction of inspired oxygen	FiO ₂	%
partial pressure of oxygen in the arteries	PaO ₂	mmHg, kPa
partial pressure of carbon dioxide in the arteries	PaCO ₂	mmHg, kPa
arterial oxygen saturation	SaO ₂	%
partial pressure of oxygen in venous blood	PvO ₂	mmHg, kPa
venous oxygen saturation	SvO ₂	%
hemoglobin	Hb	g/L, g/dl, mmol/L
respiratory quotient	RQ	None
atmospheric pressure	ATMP	mmHg, kPa
height	Height	cm, inch
weight	Weight	kg, lb

19.5.3 Calculated Parameters and Formulas for Oxygenation Calculations

Calculated Parameters	Label	Unit	Formula
body surface area	BSA	m ²	$BSA (m^2) = Wt^{0.425} (kg) \times Ht^{0.725} (cm) \times 0.007184$
oxygen consumption	VO ₂	ml/min	$VO_2 (ml/min) = C(a-v)O_2 (ml/L) \times C.O. (L/min)$
arterial oxygen content	CaO ₂	ml/L, ml/dL	$CaO_2 (ml/L) = 10 \times (0.0134 \times Hb (g/dl) \times SaO_2 (\%)) + 0.031 \times PaO_2 (mmHg)$
venous oxygen content	CvO ₂	ml/L, ml/dL	$CvO_2 (ml/L) = 10 \times (0.0134 \times Hb (g/dl) \times SvO_2 (\%)) + 0.031 \times PvO_2 (mmHg)$
arteriovenous oxygen content difference	C(a-v)O ₂	ml/L, ml/dl	$C(a-v)O_2 (ml/L) = CaO_2 (ml/L) - CvO_2 (ml/L)$
oxygen extraction ratio	O ₂ ER	%	$O_2ER (\%) = 100 \times C(a-v)O_2 (ml/L) / CaO_2 (ml/L)$
oxygen transport	DO ₂	ml/min	$DO_2 (ml/min) = C.O. (L/min) \times CaO_2 (ml/L)$
partial pressure of oxygen in the alveoli	PAO ₂	mmHg, kPa	$PAO_2 (mmHg) = [ATMP (mmHg) - 47 mmHg] \times FiO_2 (\%)/100 - PaCO_2 (mmHg) \times [FiO_2 (\%)/100 + (1 - FiO_2 (\%)/100)/RQ]$
alveolar-arterial oxygen difference	AaDO ₂	mmHg, kPa	$AaDO_2 (mmHg) = PAO_2 (mmHg) - PaO_2 (mmHg)$
capillary oxygen content	CcO ₂	ml/L, ml/dl	$CcO_2 (ml/L) = Hb (g/L) \times 1.34 + 0.031 \times PAO_2 (mmHg)$
venous admixture	QS/QT	%	$QS/QT (\%) = 100 \times [1.34 \times Hb (g/L) \times (1 - SaO_2 (\%)/100) + 0.031 \times (PAO_2 (mmHg) - PaO_2 (mmHg))] / [1.34 \times Hb (g/L) \times (1 - SvO_2 (\%)/100) + 0.031 \times (PAO_2 (mmHg) - PvO_2 (mmHg))]$
oxygen transport index	DO ₂ I	ml/min/m ²	$DO_2I (ml/min/m^2) = CaO_2 (ml/L) \times (C.O. (L/min) / BSA (m^2))$
oxygen consumption	VO ₂ I	ml/min/m ²	$VO_2I (ml/min/m^2) = C(a-v)O_2 (ml/L) \times (C.O. (L/min) / BSA (m^2))$

19.6 Ventilation Calculations

The monitor provides the ventilation calculation function and can save the results of up to 10 calculations, which are displayed in groups.

19.6.1 Performing Ventilation Calculations

To perform ventilation calculations, follow this procedure:

1. Access ventilation calculation by either of the following ways:
 - ◆ Select the **Calculations** quick key → **Ventilation** tab.
 - ◆ Select the **Main Menu** quick key → from the **Calculations** column select **Ventilation**.
2. Enter the known values. For a patient who is being monitored, the currently measured values are automatically taken. If the anesthesia machine or ventilator is connected, measured values for ventilation calculation are also automatically entered.
3. Select **Calculate**.

A calculated value greater than the normal upper limit is indicated by an up arrow "↑". A calculated value lower than the normal lower limit is indicated by a down arrow "↓".

On the **Ventilation** page, you can also perform the following operations:

- Select **Pressure Unit**. Then corresponding parameter values will be automatically converted and updated accordingly.
- Select **Range** to show the normal range of each parameter.

19.6.2 Input Parameters for Ventilation Calculations

Input Parameter	Label	Unit
percentage fraction of inspired oxygen	FiO ₂	%
respiration rate	RR	rpm
partial pressure of mixed expiratory CO ₂	PeCO ₂	mmHg, kPa
partial pressure of carbon dioxide in the arteries	PaCO ₂	mmHg, kPa
partial pressure of oxygen in the arteries	PaO ₂	mmHg, kPa
tidal volume	TV	ml
respiratory quotient	RQ	None
atmospheric pressure	ATMP	mmHg, kPa

19.6.3 Calculated Parameters and Formulas for Ventilation Calculations

Calculated Parameters	Label	Unit	Formula
partial pressure of oxygen in the alveoli	PAO ₂	mmHg, kPa	$PAO_2 \text{ (mmHg)} = [ATMP \text{ (mmHg)} - 47 \text{ mmHg}] \times FiO_2 \text{ (\%)/100} - PaCO_2 \text{ (mmHg)} \times [FiO_2 \text{ (\%)/100} + (1 - FiO_2 \text{ (\%)/100})/RQ]$
alveolar-arterial oxygen difference	AaDO ₂	mmHg, kPa	$AaDO_2 \text{ (mmHg)} = PAO_2 \text{ (mmHg)} - PaO_2 \text{ (mmHg)}$
oxygenation ratio	Pa/FiO ₂	mmHg, kPa	$Pa/FiO_2 \text{ (mmHg)} = 100 \times PaO_2 \text{ (mmHg)}/FiO_2 \text{ (\%)}$
arterial to alveolar oxygen ratio	a/AO ₂	%	$a/AO_2 \text{ (\%)} = 100 \times PaO_2 \text{ (mmHg)}/PAO_2 \text{ (mmHg)}$
minute volume	MV	L/min	$MV \text{ (L/min)} = [TV \text{ (ml)} \times RR \text{ (rpm)}]/1000$

Calculated Parameters	Label	Unit	Formula
volume of physiological dead space	Vd	ml	$Vd (ml) = TV (ml) \times [1 - PeCO_2 (mmHg)/PaCO_2 (mmHg)]$
physiologic dead space in percent of tidal volume	Vd/Vt	%	$Vd/Vt (\%) = 100 \times Vd (ml)/TV (ml)$
alveolar volume	VA	L/min	$VA (L/min) = [TV (ml) - Vd (ml)] \times RR (rpm)/1000$

19.7 Renal Calculations

The monitor provides the renal calculation function and can save the results of up to 10 calculations, which are displayed in groups.

19.7.1 Performing Renal Calculations

To perform renal calculations, follow this procedure:

- Access renal calculation by either of the following ways:
 - Select the **Calculations** quick key → select the **Renal** tab.
 - Select the **Main Menu** quick key → from the **Calculations** column select **Renal**.
- Enter the known values.
- Select **Calculate**.

A calculated value greater than the normal upper limit is indicated by an up arrow “↑”. A calculated value lower than the normal lower limit is indicated by a down arrow “↓”.

You can select **Range** to show the normal range of each parameter.

19.7.2 Calculated Parameters and Formulas for Renal Calculations

Input Parameter	Label	Unit
urine potassium	URK	mmol/L
urinary sodium	URNa	mmol/L
urine	Urine	ml/24 hrs
plasm osmolality	Posm	mOsm/kgH ₂ O
urine osmolality	Uosm	mOsm/kgH ₂ O
serum sodium	SerNa	mmol/L
creatinine	Cr	μmol/L
urine creatinine	UCr	μmol/L
blood urea nitrogen	BUN	mmol/L
height	Height	cm
weight	Weight	kg

19.7.3 Calculated Parameters and Formulas for Renal Calculations

Calculated Parameters	Label	Unit	Formula
urine sodium excretion	URNaEx	mmol/24 hrs	$URNaEx \text{ (mmol/24 hrs)} = \text{Urine (ml/24 hrs)} \times URNa \text{ (mmol/L)} / 1000$
urine potassium excretion	URKEx	mmol/24 hrs	$URKEx \text{ (mmol/24 hrs)} = \text{Urine (ml/24 hrs)} \times URK \text{ (mmol/L)} / 1000$
sodium potassium ratio	Na/K	%	$Na/K \text{ (\%)} = 100 \times URNa \text{ (mmol/L)} / URK \text{ (mmol/L)}$
clearance of sodium	CNa	ml/24 hrs	$CNa \text{ (ml/24 hrs)} = URNa \text{ (mmol/L)} \times \text{Urine (ml/24 hrs)} / SerNa \text{ (mmol/L)}$
creatinine clearance rate	ClCr	ml/min	$ClCr \text{ (ml/min)} = Ucr \text{ (\mu mol/L)} \times \text{Urine (ml/24 hrs)} / [Cr \text{ (\mu mol/L)} \times (BSA \text{ (m}^2\text{)} / 1.73) \times 1440]$
fractional excretion of sodium	FENa	%	$FENa \text{ (\%)} = 100 \times URNa \text{ (mmol/L)} \times Cr \text{ (\mu mol/L)} / [SerNa \text{ (mmol/L)} \times Ucr \text{ (\mu mol/L)}]$
osmolar clearance	Cosm	ml/min	$Cosm \text{ (ml/min)} = Uosm \text{ (mOsm/kgH}_2\text{O)} \times \text{Urine (ml/24 hrs)} / (Posm \text{ (mOsm/kgH}_2\text{O)} \times 1440)$
free water clearance	CH2O	ml/hr	$CH2O \text{ (ml/hr)} = \text{Urine (ml/24 hrs)} \times [1 - Uosm \text{ (mOsm/kgH}_2\text{O)} / Posm \text{ (mOsm/kgH}_2\text{O)}] / 24$
urine to plasma osmolality ratio	U/P osm	None	$U/P \text{ osm} = Uosm \text{ (mOsm/kgH}_2\text{O)} / Posm \text{ (mOsm/kgH}_2\text{O)}$
blood urea nitrogen creatinine ratio	BUN/Cr*	Mmol/L	$BUN/Cr = 1000 \times BUN \text{ (mmol/L)} / Cr \text{ (\mu mol/L)}$
urine-serum creatinine ratio	U/Cr	None	$U/Cr \text{ (mmol/L)} = Ucr \text{ (\mu mol/L)} / Cr \text{ (\mu mol/L)}$

*: BUN/Cr is a ratio under the unit of mol.

20 Recording

20.1 Recorder

The thermal recorder records patient information, measurement data, and up to three waveforms.

The monitor can be configured with a built-in recorder.

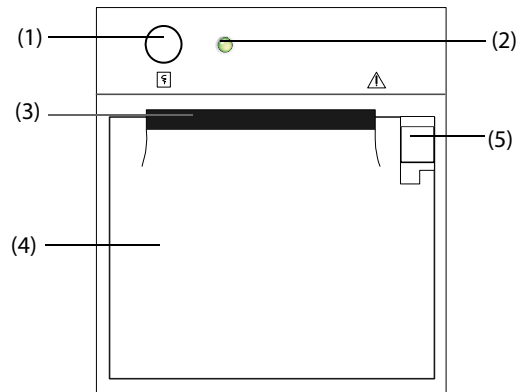



- (1) Start/Stop key: press to start a recording or stop the current recording.
- (2) Module status indicator
 - ◆ On: when the recorder works correctly.
 - ◆ Off: when the monitor is switched off.
 - ◆ Flashes: if an error occurred to the recorder.
- (3) Paper outlet
- (4) Recorder door
- (5) Latch: pull it backward to open the recorder door.

20.2 Starting Recordings

Recordings can be started manually or automatically.

20.2.1 Manually Starting Recordings

To manually start a recording, you can either:

- Press the  hardkey on the front of the recorder to start a Realtime Segment Waveform Recording.
- Select  on the current dialog to start a recording corresponding to that dialog or page.

20.2.2 Automatic Recordings

In the following conditions, you can set the recorder to automatically start recording:

- At a preset interval. For more information, see *20.5 Setting Up the Recorder*.
- When a parameter alarm is triggered. For more information, see *24.3.9.2 Enabling Automatic Recordings on an Alarm*.

20.3 Stopping Recordings

Recordings can be stopped manually or automatically.

20.3.1 Stopping Recordings Manually

To manually stop a recording, press the  hardkey while the recorder is creating a strip or select **Clear All Record Tasks** in the **Record Setup** menu.

20.3.2 Stopping Recordings Automatically

Recordings stop automatically in the following conditions:

- The recording is completed.
- The recorder runs out of paper.
- The recorder has an alarm condition.
- The monitor is turned off.

20.4 Recording Related Flags

You can find the following flags on the recording reports:

- For automatically stopped recordings, there are two columns of asterisks "*" at the end of the report.
- For manually or abnormally stopped recordings, there is one column of asterisks "*" at the end of the report.
- If the parameter data is from external devices connected to the monitor, the parameter label is prefixed with the plus sign "+".

20.5 Setting Up the Recorder

To configure the recorder for waveforms and printing intervals, follow this procedure:

1. Select the **Main Menu** quick key → from the **Report** column select **Record Setup**.
2. In the **Record Setup** dialog, select the desired waveform for **Waveform 1**, **Waveform 2** and **Waveform 3** in turn. The recorder can record up to 3 waveforms at a time.
3. Switch on or off **IBP Overlap** to enable or disable IBP recordings in the overlapping format.
 - ◆ When the **IBP Overlap** is enabled: If two or more waveforms in the selected waveforms for recording are IBP waveforms, the IBP waveforms will be recorded in the overlapping format.
 - ◆ When the **IBP Overlap** is disabled: IBP waveforms will be recorded without overlap.
4. Select **Recording Duration** to set the duration of real-time recording.
5. Select **Interval** to set the time interval for automatic recording.
6. Select **Recorder Paper Speed** to set the speed for recording waveforms.

20.6 Clearing Recording Tasks

To clear recording tasks, follow this procedure:

1. Select the **Main Menu** quick key → from the **Report** column select **Record Setup**.
2. In the **Record Setup** dialog, select **Clear All Record Tasks**. This clears all queued recording tasks and stops the current recording.

20.7 Loading Paper

To load paper, follow this procedure:

1. Use the latch at the upper right of the recorder door to pull the door open.
2. Insert a new roll into the compartment as shown below. Feed the paper through and pull some paper out from the top of the roller.
3. Close the recorder door.

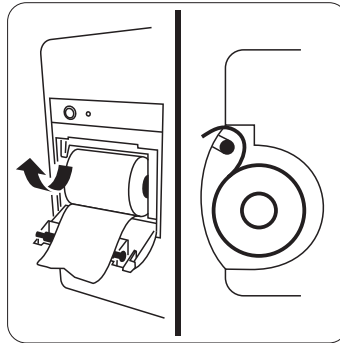

CAUTION

- **Use only specified thermal paper. Otherwise, it may cause damage to the recorder's printhead, the recorder may be unable to print, or poor print quality may result.**
 - **Never pull the recorder paper with force when a recording is in process. Otherwise, it may cause damage to the recorder.**
 - **Do not leave the recorder door open unless you are reloading paper or cleaning a paper jam.**
-

20.8 Removing Paper Jam

If the recorder works incorrectly or produces unusual sounds, check if there is a paper jam. If a paper jam is detected, follow this procedure to remove it:

1. Open the recorder door.
2. Take out the paper and tear off the draped part.
3. Reload the paper and close the recorder door.

20.9 List of Recording Reports

The recorder can output the following reports:

- Realtime reports
 - ◆ Realtime Segment Waveform Record
 - ◆ Realtime Continuous Waveform Record
 - ◆ Auto Realtime Record
 - ◆ ST Record
 - ◆ QT Record
 - ◆ Record on Alarm Report
- History reports
 - ◆ Event Detail
 - ◆ Full Disclosure Detail Record
 - ◆ ST Review Record
 - ◆ Tabular Trend Report
 - ◆ Graphic Trend Report

This page intentionally left blank.

21 Printing

21.1 Supported Printer

The monitor can output patient reports via a connected network printer. The monitor supports the following printers:

- HP LaserJet Pro M202dw
- HP LaserJet Pro 400 M401n
- HP LaserJet P4015n
- HP LaserJet 600 M602
- HP LaserJet Enterprise M605
- HP LaserJet Enterprise M608n

NOTE

- **For more details about the printer, refer to the document accompanying the printer. With product upgrades, the monitor may support additional printers without prior notice. If you have any doubts about the compatibility of the printer used with this monitor, contact Mindray.**
-

21.2 End Case Reports

21.2.1 Printing the End Case Report

To print the end case report, choose one of the following ways:

- Select **Print** from the **End Case Report** menu.
- Select **Print End Case Report** when you discharge a patient.
- Select the **End Case Report** quick key.

21.2.2 Setting a Report as An End Case Report

The following reports can be set as end case reports:

- Tabular Trends Report
- Graphic Trends Report
- Event Report
- Alarm Limits Report
- Realtime Report
- ECG Report

To set a report as an end case report, follow this procedure:

1. Select the **Main Menu** quick key → from the **Report** column select **End Case Report**.
2. From the **Select Reports** page, select the desired report tab, for example **ECG Report**.

21.2.3 Configuring the End Case Reports

To configure end case reports, follow this procedure:

1. Select the **Main Menu** quick key → from the **Report** column select **End Case Report**.
2. From the **Report Setup** page, set the following end case reports:
 - ◆ Select the **Tabular Trends Report**, **Graphic Trends Report**, **Realtime Report**, and **ECG Report** tab, and set these end case report by referring to section 21.6 *Configuring Reports*.
 - ◆ Select the **Event Report** tab, and select the event that needs to be printed.

21.2.4 Setting the End Case Report Period

To set the end case report print period, follow this procedure:

1. Select the **Main Menu** quick key → from the **Report** column select **End Case Report**.
2. From the **Select Reports** page, set the **Period**.

NOTE

- **End case report print period is calculated from the patient discharged time to the configured period.**
- **Period setting is applicable to all of the end case reports.**

21.3 Manually Starting a Printing Task

This section describes different methods for manually printing a report.

21.3.1 Printing from the Screen

The  button will be shown at the top of dialogs that have associated reports. If the button is gray, then there is not enough information to begin the report, or the printer has not been set up.

When the icon is white, pressing it opens a **Print Setup** dialog or starts printing a report. If the **Print Setup** dialog is entered, configure the report and press **Print** to start printing.

21.3.2 Printing Realtime Reports

Select the **Print** quick key to print a realtime report. You can also print a realtime report from the **Report Setup** dialog. For more information, see 21.3.3 *Printing Most Common Reports*.

21.3.3 Printing Most Common Reports

The following most common reports can be printed:

- ECG Report
- Realtime Report
- Tabular Trends Report
- Graphic Trend Report.

To print these reports, follow this procedure:

1. Select the **Main Menu** quick key → from the **Report** column select **Report Setup**.
2. Select the desired report tab.
3. Check the settings.
4. Select **Print**.

21.4 Automatically Printing Reports

When a parameter alarm switch is set to on and an alarm is triggered for this parameter, you can set the monitor to automatically print a Print on Alarm Report.

To do so, follow this procedure:

1. Access alarm related tabs such as the **Alarm** tab for a parameter in one of the following ways:
 - ◆ Select the **Alarm Setup** quick key.
 - ◆ Select the parameter or waveform area of the desired parameter → select the **Alarm** tab.
 - ◆ Select the **Parameters Setup** quick key → select the desired parameter → select the **Alarm** tab.
 - ◆ Select the **Main Menu** quick key → from the **Parameters** column select **Setup** → select the desired parameter → select the **Alarm** tab.
2. Switch on **Alarm Outputs** for desired parameters.

21.5 Stopping a Printing Task

To stop a printing task, follow this procedure:

1. Select the **Main Menu** quick key → from the **Report** column select **Print Queue**.
2. Select desired printing tasks and then select **Delete**. Alternately, select **Delete All** to stop all the printing tasks.

21.6 Configuring Reports

This section focuses on how to configure ECG reports, realtime reports, tabular trends reports, and graphic trends reports.

21.6.1 Configuring ECG Reports

To configure ECG reports, follow this procedure:

1. Select the **Main Menu** quick key → from the **Report** column select **Report Setup**.
2. Select the **ECG Report** tab.
3. Set the desired options. The following table explains some of the less familiar options.

Menu item	Function	Description
Speed	Set the print speed of ECG waveforms	25 mm/sec: prints 25 mm of ECG waveform per second. 50 mm/sec: prints 50 mm of ECG waveform per second.

NOTE

- **When ECG Lead Set is set to 3-Lead, the ECG report cannot be printed.**

21.6.2 Configuring Realtime Reports

To configure tabular realtime reports, follow this procedure:

1. Select the **Main Menu** quick key → from the **Report** column select **Report Setup**.
1. Select the **Realtime Report** tab.
2. Set the desired options. The following table explains some of the options.

Menu item	Function	Description
Select Waveform	Select the desired waveform to print	Current Waveforms: prints the realtime report for the currently displayed waveforms and all the currently measured parameter values. Selected Waveforms: prints the realtime report for the waveforms configured in the Select Waveform dialog, accessed by clicking the Select Waveform button.

21.6.3 Configuring Tabular Trends Reports

To configure tabular trends reports, follow this procedure:

1. Select the **Main Menu** quick key → from the **Report** column select **Report Setup**.
2. Select the **Tabular Trends Report** tab.
3. Set the desired options.

The following table explains some of the options.

Menu Item	Function	Description
Time	Select the time before which a tabular trends report will be printed	/
Period	Select the period during which a tabular trends report will be printed.	Auto: one page of a tabular trends before the current time will be printed at the selected Interval . All: all stored tabular trends will be printed at the selected Interval . 30 min to 96 hrs: 30 min to 96 hrs of tabular trends before the selected Time will be printed at the selected Interval .
Interval	Select the resolution of the tabular trends printed on a report.	NIBP, EWS, GCS, C.O: at an interval of acquiring the values of selected parameter. Auto: using the Interval setting of the Tabular Trends review page. 5 sec to 3 hrs: the tabular trends will be printed at the interval of 5 sec to 3 hrs .
Report Format	Select the printing principle.	Parameter Oriented: print one page span of report with parameters listed by row and time listed by column when Interval is set to Auto . Time Oriented: print one page span of report with time listed by row and parameter listed by column when Interval is set to Auto . Note that Interval on Auto only limits the number of rows or columns for Time. The report may have multiple pages to accommodate the number of parameters. To limit the parameters, change the Trend Group .

21.6.4 Configuring Graphic Trends Reports

To set graphic trends reports, follow this procedure:

1. Select the **Main Menu** quick key →from the **Report** column select **Report Setup**.
2. Select the **Graphic Trends Report** tab.
3. Set the desired options.

Menu Item	Function	Description
Period	Select the period during which a graphic trends report will be printed.	Auto: one page of a graphic trends before the current time will be printed. All: all stored graphic trends will be printed.. 30 min to 96 hrs: 30 min to 96 hrs of graphic trends before the selected Time will be printed.

21.7 Viewing Printer Status

You can view the status of the most recent ten printing tasks in the **Print Queue** dialog. To view the status of printing tasks, follow this procedure:

1. Select the **Main Menu** quick key → from the **Report** column select **Print Queue**.
2. View the status of printing tasks in the **Print Queue** dialog.

Each printing task includes the following information:

- Print time
- Report title
- Printer name (when using the printer server) or IP address (when using the network printer)
- Printing status, for example, printing, failed, retrying, and waiting.

21.8 Printer Out of Paper

When the printer runs out of paper, the print request will remain incomplete. If there are too many print jobs that remain incomplete, then a printer error may occur. To resolve the error, install paper. Some print requests may be lost if the incomplete tasks overflow the printer buffer. Missing or lost reports must be recreated and printed.

To reduce risks of printer errors, maintain enough paper in the printer.

21.9 List of Reports

The monitor can output the following reports to the printer:

- Realtime reports
 - ◆ Realtime Report
 - ◆ Freeze Report
 - ◆ ECG Report (5-lead)
 - ◆ Print on Alarm Report
 - ◆ Alarm Limits Report
 - ◆ Titration Table Report
 - ◆ Hemodynamic Calculation Report
 - ◆ Oxygenation Calculation Report
 - ◆ Ventilation Calculation Report
 - ◆ Renal Calculation Report
 - ◆ ST Report (Realtime)
 - ◆ QT Report (Realtime)
 - ◆ OxyCRG Report
 - ◆ C.O. Measure Report
 - ◆ PAWP Report
 - ◆ Device Integration - Loops Report
 - ◆ History reports
 - ◆ Tabular Trends Report
 - ◆ Graphic Trends Report
 - ◆ Event List Report
 - ◆ Event Detail Report
 - ◆ Full Disclosure Overview Report
 - ◆ Full Disclosure Detail Report
 - ◆ ST Report (review)
 - ◆ OxyCRG Report (review)
 - ◆ End Case Report
 - ◆ End Case Report - Realtime Report

- ◆ End Case Report -ECG Report
- ◆ End Case Report - Tabular Trends Report
- ◆ End Case Report - Graphic Trends Report

22 Using the On-Screen Timers

The monitor has a Timer function to notify you when a preset time period is expired or how much time has elapsed. You can simultaneously display up to four timers.

22.1 Displaying Timers

To display a timer, follow this procedure:

1. Access **Tile Layout** in either of the following ways:
 - ◆ Select the **Screen Setup** quick key → select the **Tile Layout** tab.
 - ◆ Select the **Main Menu** quick key → from the **Display** column select **Tile Layout**.
2. Click the numeric tile area where the timer is to be displayed, and then select a timer from the popup list.

22.2 Controlling the Timer

The timer provides the following controls, depending on the state and settings of the timer:

- **Start:** starts the timer.
- **Pause:** pauses the timer.
- **Resume:** resumes the timer.
- **Reset:** clears the timer.

22.3 Setting the Timer

You can set each timer independently. To set the timer, follow this procedure:

1. Select the timer area to enter the **Timer Setup** dialog.
2. Set **Timer Type**:
 - ◆ **Normal:** The timer has a single and defined run time, and stops with a notification beep when the run time is reached.
 - ◆ **Advanced:** The timer has a single and defined run time. When the run time is reached, the timer makes a notification beep and continuously displays the time beyond the end of run time.
 - ◆ **Cycled:** The timer has a single and defined run time. When the run time is reached, the timer makes a notification beep and restarts automatically. The number of elapsed cycles is also displayed on the left of the Timer tile.
 - ◆ **Unlimited:** The timer displays the time elapsed since the timer was started.
 - ◆ **Clock:** The timer displays the system time.
3. Set **Direction**.
 - ◆ **Up:** the timer counts up, from zero to Run Time.
 - ◆ **Down:** the timer counts down, from Run Time to zero.
4. Set **Run Time**.
5. Set **Reminder Volume**.

A progress bar is shown with the run time. When the remaining time is 10 seconds, the monitor issues a reminder tone and the timer flashes in red, prompting you that the run time is about to expire.

NOTE

- **You cannot change timer settings, other than Reminder Volume when a timer is running.**
 - **You can set Direction, Run Time, and Reminder Volume only for normal, advanced, and cycled timers.**
-

This page intentionally left blank.

23 Managing Configurations

23.1 Configuration Introduction

When performing continuous monitoring on a patient, the clinical professional often needs to adjust the monitor's settings according to the patient's condition. The collection of all these settings is called a configuration. The system configuration items can be classified as: parameter configuration items, conventional configuration items, and user maintenance items. Allowing you to configure the monitor more efficiently, the monitor provides different sets of configurations to accommodate the varying patient categories and departments. You can change some settings from a certain set of configuration and then save the changed configuration as a user configuration.

The default configurations provided for your monitor are department-oriented. You can choose either from:

- General
- OR
- ICU
- Neonatology
- CCU

Each department has three different sets of configurations tailored for adult, pediatric and neonatal patients respectively.

WARNING

- **The configuration management function is password protected. The configuration management tasks must be performed by clinical professionals.**
-

23.2 Changing the Department

If the current department configuration is not the one you want to view, you can change the department by following this procedure:

1. Select the **Main Menu** quick key → from the **Configuration** column select **Manage** → input the required password → select .
2. Select **Change Department**.
3. Select a department.
4. Select **OK**.

CAUTION

- **Changing the department will delete all current user configurations.**
-

23.3 Setting Default Patient Category

To set the default patient category when admitting a new patient, follow this procedure:

1. Select the **Main Menu** quick key → from the **Configuration** column select **Manage** → input the required password → select .
2. Set **Default Patient Category**.

23.4 Setting Default Configuration

The monitor will load the pre-set default configuration in the following cases:



- A patient is admitted.
- A patient is discharged.
- Patient category is changed.

To set the default configuration, follow this procedure:

1. Select the **Main Menu** quick key → from the **Configuration** column select **Manage** → input the required password → Select .
2. Select **Select Default Config.**
3. Select **Load the Latest Config** or **Load Specified Config.**
 - ◆ When you select **Load the Latest Config**, the latest configuration is loaded when the monitor is started or a patient is admitted.
 - ◆ When you select **Load Specified Config**, the selected configuration of **Default Adult Config**, **Default Ped Config**, or **Default Neo Config** is loaded when the monitor is started or a patient is admitted. The specified configuration can be the factory default configuration, the age segments configuration, or a saved user defined configuration. As an example, select **Default Neo Config** and then select **Factory Default**, **Neo GA Segments**, or a user configuration. For more information on defining age segments, see *23.5 Defining Age Segments*.

23.5 Defining Age Segments

You must define age segments for any patient category you want to load configurations based on the patient's age. To do so, follow this procedure:

1. Select the **Main Menu** quick key → from the **Configuration** column select **Manage** → input the required password → Select .
2. Select **Select Default Config.**
3. Respectively select the edit icons  followed by **Customize Configurations for Adult Age Segments**, **Customize Configurations for Ped Age Segments**, **Customize Configurations for Neo Gestational Age Segments** to define the age segments for each patient category. The age segment of the neonatal patient is based on the baby's gestational age.

23.6 Saving Current Settings

Current settings can be saved as a user configuration. Up to 25 user configurations can be saved.

To save current settings, follow this procedure:

1. Select the **Main Menu** quick key → from the **Configuration** column select **Manage** → input the required password → Select .
2. Select **Save Current Settings.**
3. Input the configuration name.
4. Select **OK** to save current settings as a user configuration.

23.7 Deleting a Configuration

To delete a configuration, follow this procedure:

1. Select the **Main Menu** quick key → from the **Configuration** column select **Manage** → input the required password → Select .
2. Select **Delete Configuration.**
3. Select the configuration you want to delete:
 - ◆ In the **Delete Configuration** dialog, selecting **Local** tab shows the existing user configurations on the monitor.

- ◆ In the **Delete Configuration** dialog, selecting **USB Drive** tab shows the existing user configurations on the USB drive.

4. Select **Delete**.
5. Select **OK**.

23.8 Transferring a Configuration

When installing several monitors with identical user configurations, it is not necessary to set each unit separately. Use a USB drive to transfer the configuration from monitor to monitor.

23.8.1 Exporting a Configuration

To export the current monitor's configuration, follow this procedure:

1. Connect the USB drive to the monitor's USB port.
2. Select the **Main Menu** quick key → from the **Configuration** column select **Manage** → input the required password → Select .
3. Select **Export Configuration**.
4. Select the configurations and **User Maintenance Settings** to export.
5. Select **Export**.

23.8.2 Importing a Configuration

To import the configuration from the USB drive to the monitor, follow this procedure:

1. Connect the USB drive to the monitor's USB port.
2. Select the **Main Menu** quick key → from the **Configuration** column select **Manage** → input the required password → Select .
3. Select **Import Configuration**.
4. Select the configurations and **User Maintenance Settings** to import.
5. Select **Import**.

23.8.3 Loading a Configuration

You may make changes to some settings during operation. However, these changes or the pre-selected configuration may not be appropriate for the newly admitted patient. Therefore, the monitor allows you to load a desired configuration to ensure that all the settings are appropriate for your patient.

To load a configuration, follow this procedure:

1. Select the **Main Menu** quick key → from the **Configuration** column select **Load**.
2. Select the desired configuration.
 - ◆ Select the configuration on this monitor in the **Local** page.
 - ◆ Select the configuration on the USB drive in the **USB Drive** page.
3. Select **Load**.

NOTE

- **The monitor may configure some settings by default when you load a configuration of different software version with the current configuration.**

23.9 Printing Configurations

To print both factory configurations and user configurations, follow this procedure:

1. Select the **Main Menu** quick key → from the **Configuration** column select **Manage** → input the required password → select .
2. Select **Print Configuration**.
3. Select desired configurations.
4. Select **Print**.

23.10 Modifying Configuration Password

To modify the configuration password, follow this procedure:

1. Select the **Main Menu** quick key → from the **Configuration** column select **Manage** → input the required password → Select .
2. Select **Modify Password**.
3. Respectively input the old password and new password.
4. Select **OK**.

24 Password-protected User Settings

This chapter describes the password-protected functions accessed in the **Maintenance** dialog.

24.1 Setting the Device Location

24.1.1 Setting Monitor Information

To set monitor information, follow this procedure:

1. Select the **Main Menu** quick key → from the **System** column select **Maintenance** → input the required password → select .
2. Select the **Device Location** tab.
3. Input monitor name, facility name and department name.

24.1.2 Setting Monitor Location

If your monitor is installed at a fixed position, or you do not need clinicians to change the room number and bed number, you can set **Monitor Location** to **Fixed**. To set the monitor location, follow this procedure:

1. Select the **Main Menu** quick key → from the **System** column select **Maintenance** → input the required password → select .
2. Select the **Device Location** tab.
3. Set **Location**.
 - ◆ **Fixed**: the **Patient Management** dialog displays **Bed No.** and **Room No.**, but you cannot change them.
 - ◆ **Unfixed**: you can change **Bed No.** and **Room No.** from the **Patient Management** dialog.
4. Input the room number and bed number.

NOTE

- If **Location** is set to **Unfixed**, **Bed No.** and **Room No.** are cleared from the **Device Location** tab each time you discharge a patient.
-

24.1.3 Enabling the Auto Obtain Bed Number Function

If the monitor is connected to the wired network, the monitor can automatically set the patient's bed number according to the bed number information bonded to the bedside network connector.

To enable the function, follow this procedure:

1. Select the **Main Menu** quick key → from the **System** column select **Maintenance** → input the required password → select .
2. Select the **Device Location** tab.
3. Select **Unfixed**.
4. Switch on **Auto Obtain Bed No.**

NOTE

- The **Auto Obtain Bed Number** function is available only when the switch connected to the monitor supports the **LLDP** or **CDP** protocol, and the corresponding protocol is enabled.
-

24.2 Changing Patient Management Settings

24.2.1 Selecting Displayed Patient Information

You can define which items can be displayed and edited from the **Patient Management** tab. To do so, follow this procedure:

1. Select the **Main Menu** quick key → from the **System** column select **Maintenance** → input the required password → select .
2. Select the **Patient Management** tab → select the **Field** tab.
3. Select the fields you want to display in the **Patient Management** dialog.
4. If necessary, select the customized fields and input names for these fields.

NOTE

- **If the monitor is connected with the CMS, the patient information items and customized fields are loaded from the CMS.**
-

24.2.2 Setting the Range of Finding a Patient

You can configure which patient can be found in the CMS or the ADT server. To do so, follow this procedure:

1. Select the **Main Menu** quick key → from the **System** column select **Maintenance** → input the required password → select .
2. Select the **Patient Management** tab → select **Find Patient** tab.
3. Select **Find Patient**.
 - ◆ **All Patients:** search from all patients in the CMS or ADT server.
 - ◆ **Current Department Patients:** only searches from the current department in the CMS or ADT server.

24.2.3 Auto Discharging a Patient after Monitor Power Off

You can let the monitor automatically discharge after the monitor has been switched off for a period of time.

To set the time period of discharging a patient, follow this procedure:

1. Select the **Main Menu** quick key → from the **System** column select **Maintenance** → input the required password → select .
2. Select the **Patient Management** tab → select the **Discharge** tab.
3. Select a time for **Auto Discharge When Power Off**. The monitor will automatically discharge the patient when it is turned off for the designated period of time. The default is **Never**. That is to say the monitor will not automatically discharge a patient, regardless of how long the monitor has been switched off.

24.2.4 Configuring Alarms for Auto Deleting Discharged Patients

The monitor automatically deletes earlier discharged patients when the memory is limited. You can select whether an alarm is issued when discharged patients are automatically deleted and the monitor memory is very low.

1. Select the **Main Menu** quick key → from the **System** column select **Maintenance** → input the required password → select .
2. Select the **Patient Management** tab → **Discharge** tab.
3. Configure the alarms as needed:
 - ◆ **Prompt on patient auto deleted:** an alarm is issued when the monitor automatically deletes earlier discharged patients.
 - ◆ **Prompt Alarm When Storage Is Nearly Full:** selects whether an alarm is issued when the monitor memory is very low and the priority of this alarm.

24.2.5 Configuring Discharged Patients Data

To configure discharged patient data, follow this procedure:

1. Select the **Main Menu** quick key → from the **System** column select **Maintenance** → input the required password → select .
2. Select the **Patient Management** tab → **Discharge** tab.
3. Switch on **Include Patient Demographics When Exporting Patient Data** if you want to include patient demographics when exporting the patient data.
4. Select **Auto Delete Patient Data If Discharged** to specify whether patient data is deleted when the patient is discharged.
 - ◆ **Auto:** patient data is not deleted when the patient is discharged. The oldest discharged patient data will be deleted when the storage space of the monitor is full.
 - ◆ **Right Now:** deletes patient data as soon as the patient is discharged.
 - ◆ **7 days:** deletes discharged patient data seven days after the patient was discharged.
 - ◆ **1 Month:** deletes discharged patient data one month after the patient was discharged.

24.2.6 Clearing All Patient Data

You can delete all patient information and data in the monitor. To do so, follow this procedure:

1. Select the **Main Menu** quick key → from the **System** column select **Maintenance** → input the required password → select .
2. Select the **Patient Management** tab → select the **Discharge** tab.
3. Select **Clear All Patient Data**.
4. Select **OK**. Select **OK** again for confirmation until a message indicating you that all data is cleared.

CAUTION

- **Clearing patient data will discharge the current patient. Make sure there is no patient monitoring before you clear all data.**
-

24.2.7 Selecting Query Criteria for Searching Patients in ADT Server

You can define which criteria can be used to search patients in the ADT server. To do so, follow this procedure:

1. Select the **Main Menu** quick key → from the **System** column select **Maintenance** → input the required password → select .
2. Select the **Patient Management** tab → select the **ADT Query** tab.
3. Select the query criteria as desired.

24.2.8 Setting Patient Location Options for the Discharge Screen

To set options for patient location, follow this procedure:

1. Select the **Main Menu** quick key → from the **System** column select **Maintenance** → input the required password → select .
2. Select the **Patient Management** tab → select the **Location** tab.
3. Input or edit patient location options.

24.2.9 Hiding Patient Name

To hide patient name on specific screens, follow this procedure:

1. Select the **Main Menu** quick key → from the **System** column select **Maintenance** → input the required password → select .
2. Select the **Patient Management** tab → select the **Display** tab.
3. Set the following switches as desired:

- ◆ Switch off **Primary Screen Display Full Name**: does not display patient name in the patient information area on the primary display.
- ◆ Switch off **Remote View Display Full Name**: does not display patient name in the patient information area on the remote monitors when this monitor is viewed by other monitors.
- ◆ Switch off **Remote View Bedlist Display Full Name**: does not display patient name in bed list on the remote monitors when this monitor is viewed by other monitors.

24.3 Changing the Alarm Settings

24.3.1 Setting Alarm Tone Properties

24.3.1.1 Setting the Minimum Alarm Volume

To set the minimum alarm volume, follow this procedure:

1. Select the **Main Menu** quick key → from the **System** column select **Maintenance** → input the required password → select .
2. Select the **Alarm** tab → select the **Audio** tab.
3. Set **Minimum Alarm Volume**.

24.3.1.2 Setting the Audible Alarm Tone Pattern

You can distinguish the heart beat tone, pulse tone, and keystroke tone by frequency. For more information, see *7.3.3 Alarm Indicators*.

To set the alarm tone pattern, follow this procedure:

1. Select the **Main Menu** quick key → from the **System** column select **Maintenance** → input the required password → select .
2. Select the **Alarm** tab → select the **Audio** tab.
3. Set **Alarm Sound**.

24.3.1.3 Setting the Interval between Alarm Sounds

If you choose the ISO pattern, you can change the interval between alarm tones. To change the interval between alarm tones, follow this procedure:

1. Select the **Main Menu** quick key → from the **System** column select **Maintenance** → input the required password → select .
2. Select the **Alarm** tab → select the **Audio** tab.
3. Set **High Alarm Interval**, **Med Alarm Interval**, and **Low Alarm Interval**.

24.3.1.4 Setting Alarm Volume Escalation

The monitor provides the function of automatically escalating the alarm tone volume. When this function is enabled, if an alarm is not reset within the designated delay time after the alarm occurs, the volume of the alarm tone increases automatically.

To set the alarm volume escalation, follow this procedure:

1. Select the **Main Menu** quick key → from the **System** column select **Maintenance** → input the required password → select .
2. Select the **Alarm** tab → select the **Audio** tab.
3. Set **Auto Increase Volume**.
 - ◆ **2 Steps**: if an alarm is not reset within the designated delay time after the alarm occurs, the alarm volume automatically increases by two levels.

- ◆ **1 Step:** if an alarm is not reset within the designated delay time after the alarm occurs, the alarm volume automatically increases by one level.
 - ◆ **Off:** if an alarm is not reset within the designated delay time after the alarm occurs, the volume of the alarm tone does not change.
4. Select **Increase Volume Delay** to set the delay time of alarm volume escalation.

NOTE

- **The alarm volume escalation function is not applied to the latched alarms.**

24.3.2 Setting Alarm Pausing and Resetting Properties

24.3.2.1 Defining the Pause Function

You can either pause alarms or pause alarm tones. This depends on the pause setting. To set the pause function, follow this procedure:

1. Select the **Main Menu** quick key → from the **System** column select **Maintenance** → input the required password → select .
2. Select the **Alarm** tab → select the **Pause/Reset** tab.
3. Set **Pause** to **Alarm Pause** or **Audio Pause**.

24.3.2.2 Setting the Alarm Pause Time/Alarm Tone Pause Time

The alarm pause time or alarm tone pause time can be set to **1 min**, **2 min**, **3 min**, or **Permanent**. The default audio pause time is two minutes.

To set the alarm tone pause time, follow this procedure:

1. Select the **Main Menu** quick key → from the **System** column select **Maintenance** → input the required password → select .
2. Select the **Alarm** tab → select the **Pause/Reset** tab.
3. Set **Pause Time**.

24.3.2.3 Setting the Priority of Audio Paused Alarms

To select alarm of what priority can be paused or alarm sound of what priority can be paused, follow this procedure:

1. Select the **Main Menu** quick key → from the **System** column select **Maintenance** → input the required password → select .
2. Select the **Alarm** tab → select the **Pause/Reset** tab.
3. Set **Pause Priority**.
 - ◆ **All:** pressing the **Alarm Pause** quick key pauses all alarms.
 - ◆ **Med & Low:** pressing the **Alarm Pause** quick key pauses alarms of medium and low priority. The high priority alarms will not be paused.
 - ◆ **Disable:** the **Alarm Pause** quick key is disabled.

24.3.2.4 Disabling the Options of Prolonging Alarm Pause Time/Alarm Tone Pause Time

To disable specific options for the clinician when prolonging alarm pause time or the alarm tone pause time, follow this procedure:

1. Select the **Main Menu** quick key → from the **System** column select **Maintenance** → input the required password → select .
2. Select the **Alarm** tab → select the **Pause/Reset** tab.
3. Switch off **Pause 5 min**, **Pause 10 min**, or **Pause 15 min**.

24.3.2.5 Setting Alarm Light Status on Alarm Reset

When the alarm system is reset, the monitor presents the alarm light by default, but you can switch off the alarm light. To change the alarm light setting, follow this procedure:

1. Select the **Main Menu** quick key → from the **System** column select **Maintenance** → input the required password → select .
2. Select the **Alarm** tab → select the **Pause/Reset** tab.
3. Set **Alarm Light**.
 - ◆ **On When Reset:** when the alarm system is reset, the alarm tones of the current alarms are switched off, but the alarm lamp remains flashing.
 - ◆ **Off When Reset:** when the alarm system is reset, both the alarm tone and alarm lamp of the current alarms are switched off.

24.3.2.6 Setting the Reminder Tones

When the alarm volume is set to zero, or the alarm is reset or switched off, the monitor issues a periodical reminder tone. The reminder tone is enabled by default.

To set the reminder tone, follow this procedure:

1. Select the **Main Menu** quick key → from the **System** column select **Maintenance** → input the required password → select .
2. Select the **Alarm** tab → select the **Pause/Reset** tab.
3. Set **Alarm Reset Reminder** and **Alarm Off Reminder**.
 - ◆ **On:** the monitor issues reminder tones at a designated interval.
 - ◆ **Re-alarm:** if the alarm condition persists the alarms marked with “√” will be re-generated after the designated reminder tone interval.
 - ◆ **Off:** the monitor does not issue reminder tones at a designated interval. The alarms marked with “√” will be silenced.
4. Set **Reminder Interval** to **10 min, 5 min, 3 min, 2 min, or 1 min**.

24.3.3 Latching Physiological Alarms

To latch physiological alarms, follow this procedure:

1. Select the **Main Menu** quick key → from the **System** column select **Maintenance** → input the required password → select .
2. Select the **Alarm** tab → select the **Latching** tab.
3. Select how you want to latch the alarms.

Alarm latching rules are as follows:

- You can separately latch visible alarm signals and audible alarm signals.
- Latching audible alarm signals simultaneously latches the corresponding visible signals.
- Selecting alarms of lower priority simultaneously latches higher priority alarms.
- Switching **V-Tach Latching Lock** off allows you to switch on or off **V-Tach Latching**.
- When **V-Tach Latching Lock** is switched on, V-Tach latching follows the setting of **Lethal** alarm latching and you cannot control **V-Tach Latching**.

24.3.4 Setting Guard Limits

To set guard limits, follow this procedure:

1. Select the **Main Menu** quick key → from the **System** column select **Maintenance** → input the required password → select .
2. Select the **Alarm** tab → **Guard Limits** tab.
3. Set **Patient Category**.

4. Set guard limits for the selected patient category:
 - ◆ **Disable Off:** if this switch is on, corresponding alarm cannot be switched off.
 - ◆ **Highest:** the high alarm limit cannot be higher than this setting.
 - ◆ **Lowest:** the low alarm limit cannot be lower than this setting.
 - ◆ **Priority:** the alarm priority cannot be lower than this setting.

Selecting **Clear** restores default guard limits.

WARNING

- **For Lethal Arrhy, SpO2 Desat, and Apnea alarms, the default setting of the Disable Off switch is on. If you set the Disabled Off switch to Off, lethal arrhythmia alarms, SpO2 Desat alarm, and apnea alarm can be switched off. Thus, the monitor does not present the corresponding alarm when an alarm condition occurs. This may result in a hazard to the patient. Keep the patient under close surveillance.**
-

24.3.5 Changing Remote Alarm Settings

24.3.5.1 Resetting Alarms for Remote Devices

You can reset the alarms occurring on the remote devices that are viewed on the **Remote View** screen of the monitor. To enable this function, follow this procedure:

1. Select the **Main Menu** quick key → from the **System** column select **Maintenance** → input the required password → select .
2. Select the **Alarm** tab → select the **Remote View** tab.
3. Switch on **Reset Remote Bed Alarms**. Then the **Alarm Reset** button appears on the bottom left of the **Remote View** screen.

To reset any remote device alarms, the clinician may now select the **Alarm Reset** button at the bottom of the **Remote View** screen.

NOTE

- **You can reset remote device alarms only if the Alarm Reset By Other Bed switch is on at the remote devices and alarms are occurring on the remote device.**
-

24.3.5.2 Authorizing the Alarm Reset to Other Devices

Alarms on your monitor can be reset by remote devices if you enable this function. To do so, follow this procedure:

1. Select the **Main Menu** quick key → from the **System** column select **Maintenance** → input the required password → select .
2. Select the **Alarm** tab → select the **Remote View** tab.
3. Switch on **Alarm Reset By Other Bed**.

24.3.5.3 Selecting the Alarm Reminder for Remote Devices

You can configure what alarm indicators are necessary for the remote devices. To do so, follow this procedure:

1. Select the **Main Menu** quick key → from the **System** column select **Maintenance** → input the required password → select .
2. Select the **Alarm** tab → select the **Remote View** tab.
3. Select **Alarm Reminder**:
 - ◆ **Visible + Audible:** the monitor provides visual alarm indication, and continuous audible alarm indication if the alarm persists at the remote device.
 - ◆ **Visible + Single Tone:** the monitor provides visual alarm indication, and a single tone when the alarm occurs at the remote device.

- ◆ **Visible Only:** the monitor only provides visual alarm indication.

24.3.5.4 Presenting Alarm Sound for Remote Devices as per Alarm Priority

You can configure what priority of remote device alarms are presented for audible notification. To do so, follow this procedure:

1. Select the **Main Menu** quick key → from the **System** column select **Maintenance** → input the required password → select .
2. Select the **Alarm** tab → select the **Remote View** tab.
3. Select **Alarm Priority:**
 - ◆ **All:** the monitor sounds if an alarm occurs.
 - ◆ **High & Med:** the monitor sounds if a high or medium priority alarm occurs.
 - ◆ **High Only:** the monitor sounds only if a high priority alarm occurs.

24.3.5.5 Setting the Tone Pattern for Alarms from Remote Devices

The monitor provides the same alarm tone pattern for the remote device alarms as those for your monitor alarms. For more information on alarm tone pattern, see *7.3.3 Alarm Indicators*.

To set the alarm tone pattern for the remote device alarms, follow this procedure:

1. Select the **Main Menu** quick key → from the **System** column select **Maintenance** → input the required password → select .
2. Select the **Alarm** tab → select the **Remote View** tab.
3. Set **Alarm Sound**.

24.3.5.6 Switching Off the Remote Device Disconnection Alarm

The monitor can provide an alarm if remote devices, for example, a bedside monitor or a telemetry, are disconnected. By default, the function is enabled. To disable the alarm, follow this procedure:

1. Select the **Main Menu** quick key → from the **System** column select **Maintenance** → input the required password → select .
2. Select the **Alarm** tab → select the **Remote View** tab.

Switch off **Remote Disconnected Alarm**.

24.3.6 Setting Nurse Call Properties

24.3.6.1 Selecting Alarms to be Sent to the Nurse Call System

To set the type and priority of alarms that are sent to the nurse call system, follow this procedure:

1. Select the **Main Menu** quick key → from the **System** column select **Maintenance** → input the required password → select .
2. Select the **Alarm** tab → select the **Nurse Call** tab.
3. Select **Signal Type**
 - ◆ **Pulse:** the nurse call signal is a pulse signal and each pulse lasts one second. When multiple alarms simultaneously occur, only one pulse signal is outputted. If an alarm occurs but the previous one is not cleared, a new pulse signal will also be outputted.
 - ◆ **Continuous:** the nurse call signal lasts until the alarm ends. That is to say the duration of a nurse call signal is equal to that of the alarm condition.
4. Select **Contact Type** to set the work mode of the nurse call relay.
5. Select **Alarm Priority** to set the priority of alarms sent to the nurse call system.
6. Select **Alarm Type** to set the type of alarms sent to the nurse call system.

24.3.6.2 Disabling the Receiving Call Help Function

If a monitor in the same department calls for help, you can receive the calling signal. This function is enabled by default. To disable this function, follow this procedure:

1. Select the **Main Menu** quick key → from the **System** column select **Maintenance** → input the required password → select .
2. Select the **Alarm** tab → select the **Nurse Call** tab.
3. Switch off **Receive Call Help**.

24.3.6.3 Selecting the Source of Call Help Signals

You can choose which calling for help signals the monitor can receive. To do so, follow this procedure:

1. Select the **Main Menu** quick key → from the **System** column select **Maintenance** → input the required password → select .
2. Select the **Alarm** tab → **Nurse Call** tab.
3. Set the switch of **Only Beds from Remote View**.
 - ◆ **On:** The monitor can only receive the calling for help signals from the remote monitors being viewed.
 - ◆ **Off:** The monitor can receive the calling for help signals from all the monitors in the same department.

24.3.7 Changing Alarm Priority Settings

24.3.7.1 Setting the Priority of the ECG Lead Off Alarm

To set the priority of the ECG lead off alarm, follow this procedure:

1. Select the **Main Menu** quick key → from the **System** column select **Maintenance** → input the required password → select .
2. Select the **Alarm** tab → select the **Other** tab.
3. Set the priority of **ECG Lead Off**.

24.3.7.2 Setting the Priority of the SpO₂ Sensor Off Alarm

To set the priority of the SpO₂ sensor off alarm, follow this procedure:

1. Select the **Main Menu** quick key → from the **System** column select **Maintenance** → input the required password → select .
2. Select the **Alarm** tab → select the **Other** tab.
3. Set the priority of **SpO₂ Sensor Off**.

24.3.7.3 Setting the Priority of the IBP No Sensor Alarm

To set the priority of the IBP no sensor alarm, follow this procedure:

1. Select the **Main Menu** quick key → from the **System** column select **Maintenance** → input the required password → select .
2. Select the **Alarm** tab → select the **Other** tab.
3. Set the priority of **IBP No Sensor**.

24.3.7.4 Setting the Switch of the CMS and eGateway Disconnection Alarm

You can choose whether to issue an alarm when the monitor is not connected or disconnected from the CMS/eGateway. To do so, follow this procedure:

1. Select the **Main Menu** quick key → from the **System** column select **Maintenance** → input the required password → select .
2. Select the **Alarm** tab → select the **Other** tab.

3. In the Other block, switch on or off **CMS/eGW Disconnected Alarm**. If **CMS/eGW Disconnected Alarm** is switched off, the “Offline” alarm is not presented when the monitor is not connected or disconnected from the CMS/eGateway.

24.3.7.5 Setting the Priority of the Integrated Device Disconnected Alarm

To set the priority of the alarm when the external device is disconnected, follow this procedure:

1. Select the **Main Menu** quick key → from the **System** column select **Maintenance** → input the required password → select .
2. Select the **Alarm** tab → select the **Other** tab.
3. Set the priority of **Integrated Device Disconnected**.

24.3.7.6 Setting the Priority of the CMS and eGateway Disconnection Alarm

To set the priority of the CMS and eGateway disconnection alarm, follow this procedure:

1. Select the **Main Menu** quick key → from the **System** column select **Maintenance** → input the required password → select .
2. Select the **Alarm** tab → select the **Other** tab.
3. Set **CMS/eGW Disconnected**.

24.3.8 Changing Alarm Delay Settings

24.3.8.1 Setting the Alarm Delay Time

For continuously measured parameters, you can set the alarm delay time. If the alarm condition is resolved within the delay time, the monitor does not present the alarm.

The setting of **Alarm Delay** is not applied to the apnea alarms and the ST alarms. You can set **Apnea Delay** and **ST Alarm Delay** separately.

To set the alarm delay time, follow this procedure:

1. Select the **Main Menu** quick key → from the **System** column select **Maintenance** → input the required password → select .
2. Select the **Alarm** tab → select the **Other** tab.
3. Set **Alarm Delay**.
 - ◆ **Off**: an alarm is presented as soon as the alarm condition occurs.
 - ◆ **1 sec ~ 15sec**: for continuously measured parameters, an alarm is not presented if the alarm condition is resolved within the designated delay time.

WARNING

- **The alarm delay time can be set to a maximum of 15 seconds. Changing this setting to an inappropriate level could result in a hazard to the patient.**
-
-

24.3.8.2 Setting the ST Alarm Delay Time

1. Select the **Main Menu** quick key → from the **System** column select **Maintenance** → input the required password → select .
2. Select the **Alarm** tab → select the **Other** tab.
3. Set **ST Alarm Delay**.

24.3.9 Changing Other Alarm Settings

24.3.9.1 Setting the Intubation Time

The default intubation time is 2 minutes. To change the intubation time, following this procedure:

1. Select the **Main Menu** quick key → from the **System** column select **Maintenance** → input the required password → select .
2. Select the **Alarm** tab → select the **Other** tab.
3. Set the **Intubation Mode Period**.

24.3.9.2 Enabling Automatic Recordings on an Alarm

Print on Alarm is set to **Printer** by default. To enable automatic recording via recorder when a parameter alarm is triggered, set **Print on Alarm** to **Recorder**. To do so, follow this procedure:

1. Select the **Main Menu** quick key → from the **System column** select **Maintenance** → input the required password → select .
2. Select the **Alarm** tab → select the **Other** tab.
3. Set **Print on Alarm** to **Recorder**.

24.3.9.3 Setting Arrhythmia Alarm Timeout Period

The arrhythmia algorithm can disable alarm light and alarm tone for designated period of time when certain arrhythmia alarms are detected.

To set the arrhythmia alarm timeout period, follow this procedure:

1. Select the **Main Menu** quick key → from the **System** column select **Maintenance** → input the required password → select .
2. Select the **Alarm** tab → select the **Other** tab.
3. From the **Other** block, set **Arrhy Shield Time**.

NOTE

- **For the following alarms, alarm light and alarm tone cannot be disabled: HR high, HR low, Tachycardia, Bradycardia, Afib End, Irr Rhythm End.**
 - **The arrhythmia alarm timeout period is only applied to the medium priority chains and atrial fibrillation chain. For the alarms in the high priority chain, alarm tone and alarm light are presented as soon as the alarm condition is detected. Refer to 8.6.5.1 Arrhythmia Alarm Chains for more information on the arrhythmia alarm chain.**
 - **Alarm indication rules for alarms in the atrial fibrillation chain are the same with those for the medium priority chains.**
-

24.3.9.4 Setting the Night Mode Switch

You can enable or disable the night mode function. To do so, follow this procedure:

1. Select the **Main Menu** quick key → from the **System** column select **Maintenance** → input the required password → select .
2. Select the **Alarm** tab → select the **Other** tab.
3. From the **Other** block, set **Disable Night Mode**.
 - ◆ **On:** the night mode function is not available.
 - ◆ **Off:** the night mode function is available.

24.3.9.5 Setting the Notify Alarm Setting Change Switch

The monitor can give an prompt when alarm settings, including alarm limits, alarm priorities, and alarm switches, are changed from the CMS. This function is disabled by default. To enable this function, follow this procedure:

1. Select the **Main Menu** quick key → from the **System** column select **Maintenance** → input the required password → select .
2. Select the **Alarm** tab → select the **Other** tab.
3. From the **Other** block, switch on **Notify Alarm Setting Change**.

When this switch is turned on, the monitor gives the prompt “Alarm Limits/Level/Switch is changed by CMS” if alarm settings are changed from the CMS.

24.4 Changing CAA Settings

24.4.1 Enabling Inputting the Clinician ID

To display the clinician ID on the EWS screen, follow this procedure:

1. Select the **Main Menu** quick key → from the **System** column select **Maintenance** → input the required password → select .
2. Select the **CAA** tab → select the **EWS** tab.
3. Switch on **Clinician ID**.
4. Select **Clinician ID Timeout** to set how long the clinician ID will remain valid.

NOTE

- **The EWS tab is only available if a license for EWS is installed in the monitor.**
- **When a patient is discharged, or the monitor is turned off, the clinical ID is cleared even if the timeout is not reached.**

24.4.2 Selecting the Default Scoring Tool

To set the default scoring tool for different patient category, follow this procedure:

1. Select the **Main Menu** quick key → from the **System** column select **Maintenance** → input the required password → select .
2. Select the **CAA** tab → select **EWS** tab.
3. From the **Select Default Score** area, set **Default Adult Score**, **Default Ped Score**, and **Default Neo Score**.

24.4.3 Managing the Scoring Tools

To manage the scoring tool, follow this procedure:

1. Select the **Main Menu** quick key → from the **System** column select **Maintenance** → input the required password → select .
2. Select the **CAA** tab → select the **EWS** tab.
3. Select the **Manage Score** button.
 - ◆ Delete local scoring tools: from the **Local** page, delete any unnecessary scoring tools.
 - ◆ Import the desired scoring tools to the monitor: from the USB drive page, select the scoring tools on the USB drive, and then select **Import**.

NOTE

- **The monitor provides MEWS and NEWS by default. You cannot delete them.**

24.4.4 Setting GCS Threshold for Each Consciousness Level

You can configure the threshold and color of each consciousness level. To do so, follow this procedure:

1. Select the **Main Menu** quick key → from the **System** column select **Maintenance** → input the required password → select .
2. Select the **CAA** tab → select the **GCS** tab.

3. Set high limit, low limit for each level.

24.5 Changing Module Settings

24.5.1 Selecting the ECG Standard

Select the ECG standard according to the leadwires you are using. To select the ECG standard, follow this procedure:

1. Select the **Main Menu** quick key → from the **System** column select **Maintenance** → input the required password → select .
2. Select the **Module** tab → select the **ECG** tab.
3. Set **ECG Standard** to **AHA** or **IEC**.

24.5.2 Changing the QTc Formula

The monitor uses the Hodges correction formula by default to correct the QT interval for heart rate. To select the QTc formula, follow this procedure:

1. Select the **Main Menu** quick key → from the **System** column select **Maintenance** → input the required password → select .
2. Select the **Module** tab → select the **ECG** tab.
3. Set **QTc Formula**.

◆ Hodges: $QTc = QT + 1.75 \times (HeartRate - 60)$

◆ Bazett: $QTc = QT \times \left(\frac{HeartRate}{60}\right)^{\frac{1}{2}}$

◆ Fridericia: $QTc = QT \times \left(\frac{HeartRate}{60}\right)^{\frac{1}{3}}$

◆ Framingham: $QTc = QT + 154 \times \left(1 - \frac{60}{HeartRate}\right)$

24.5.3 Calibrating ECG

The ECG signal may be inaccurate due to hardware or software problems. As a result, the ECG waveform amplitude becomes greater or smaller. In that case, you need to calibrate the ECG module. To do so, follow this procedure:

1. Select the **Main Menu** quick key → from the **System** column select **Maintenance** → input the required password → select .
2. Select the **Module** tab → select the **ECG** tab.
3. From the bottom left corner of the dialog select **Calibrate**.

24.5.4 Manually Zeroing the CO₂ Module

To zero the CO₂ module, follow this procedure:

1. Select the **Main Menu** quick key → from the **System** column select **Maintenance** → input the required password → select .
2. Select the **Module** tab → select the **CO₂** tab.
3. From the bottom left corner of the dialog select **Zero**.

24.5.5 Hiding the Invalid Display after Zeroing the CO₂ Module

After the zero calibration is completed, the CO₂ module reacquires the CO₂ readings. During the reacquisition period, "**Zero Recovering**" is displayed in the CO₂ numeric area. Valid data will reappear 30 seconds after the zero calibration is started.

To hide the display of the “Zero Recovering” message, follow this procedure:

1. Select the **Main Menu** quick key → from the **System** column select **Maintenance** → input the required password → select .
2. Select the **Module** tab → select the **CO2** tab.
3. Switch off **Zero Recovery for 30s**.

Selecting **Defaults** from the bottom of the dialog can restore this setting to the factory default.

24.5.6 Manually Zeroing the AG Module

To zero the AG module, follow this procedure:

1. Select the **Main Menu** quick key → from the **System** column select **Maintenance** → input the required password → select .
2. Select the **Module** tab → select the **AG** tab.
3. From the bottom left corner of the dialog select **Zero**.

24.5.7 Hiding the Invalid Display after Zeroing the AG Module

After the zero calibration is completed, the AG module reacquires the AG readings. During the reacquisition period, “Zero Recovering” is displayed in the AG numeric area. Valid data will reappear 30 seconds after the zero calibration is started.

To hide the display of the “Zero Recovering” message, follow this procedure:

1. Select the **Main Menu** quick key → from the **System** column select **Maintenance** → input the required password → select .
2. Select the **Module** tab → select the **AG** tab.
3. Switch off **Zero Recovery for 30s**.

Selecting **Defaults** from the bottom of the dialog can restore this setting to the factory default.

24.5.8 Selecting the Gas Type for Measurement

You can select what gases are detected by the monitor. To do so, follow this procedure:

1. Ensure that the AG module is inserted in the monitor.
2. Select the **Main Menu** quick key → from the **System** column select **Maintenance** → input the required password → select .
3. Select the **Module** tab → select the **AG** tab.
4. Set **Types of Gas Measurement**. Any gas that is not selected, will not be displayed or used for calculating the MAC value. When the concentration of any unselected gas is equal to or greater than 1%, you will be prompted to select the gas and enable the measurement (**Set XX measurement to On**).

Selecting **Defaults** from the bottom of the dialog can restore this setting.

24.5.9 Setting IBP Filter

To set IBP filter, follow this procedure:

1. Select the **Main Menu** quick key → from the **System** column select **Maintenance** → input the required password → select .
2. Select the **Module** tab → select the **Other** tab.
3. Set **IBP Filter**.

24.5.10 Setting Parameter Measurement Timeout

NIBP measurements become outline fonts after a preset time. This feature prevents older values being misinterpreted as current measurements. To adjust the timeout period for PAWP and NIBP, follow this procedure:

1. Select the **Main Menu** quick key → from the **System** column select **Maintenance** → input the required password → select .
2. Select the **Module** tab → select the **Other** tab.
3. Set the timeout period for PAWP, C.O., and NIBP.

24.5.11 Setting Flow Rate

When you are using the sidestream CO₂ module to monitor a neonatal patient, you can select flow rate. To do so, follow this procedure:

1. Ensure that the sidestream module is inserted in the monitor.
2. Select the **Main Menu** quick key → from the **System** column select **Maintenance** → input the required password → select .
3. Select the **Module** tab → select the **Other** tab.
4. Set **CO2 Flow Rate For Neo**.

24.6 Changing the Review Settings

24.6.1 Hiding Undesired Review Tabs

If you do not need to review some items, you can hide them. To do so, follow this procedure:

1. Select the **Main Menu** quick key → from the **System** column select **Maintenance** → input the required password → select .
2. Select the **Review** tab.
3. From the **Tabs** page, **Event** page or **Arrh Mark** page deselect those not need to be available to clinicians during review.

24.6.2 Renaming Events

You can rename manual events and arrhythmia events. To do so, follow this procedure:

1. Select the **Main Menu** quick key → from the **System** column select **Maintenance** → input the required password → select .
2. Select the **Review** tab.
3. Switch on **Rename Event**.

24.6.3 Exporting Patient Data

To export data of the current and discharged patients, follow this procedure:



1. Connect the USB drive to the monitor's USB connector.
2. Select the **Main Menu** quick key → from the **System** column select **Maintenance** → input the required password → select .
3. Select the **Review** tab → select the **Export** tab.
4. Select **Export Patient Data**.
5. From the patient list select desired patients.
6. Select **Export Patient Data**.

24.7 Setting the Printer

24.7.1 Setting the Printer Properties

To set a network printer, follow this procedure:

1. Select the **Main Menu** quick key → from the **System** column select **Maintenance** → input the required password → select .

2. Select the **Print** tab.
3. In the **Printer** tab, select **Connection Type** to choose whether you want to output patient reports via the print server or a network printer.
4. If you set **Connection Type** to **Print Server**, perform the following settings:
 - ◆ **Print Server Address:** select  to input the printer server name or IP address.
 - ◆ **Port:** selects  to input the printer server port. If the CMS is used as the printer server, set **Port** to **6603**.
 - ◆ Set the report type in the **Report Type** area. For more information, see section 24.7.2 *Setting the Report Type*.
5. If you set **Connection Type** to **Printer**, perform the following settings:
 - ◆ Select **Printer IP Address**. Select  to input the IP address of the desired network printer.
 - ◆ Select **Paper Size**.
 - ◆ Select **Resolution**.

After finishing configurations, you can select the **Print Test Page** button to verify that the printer works properly.

24.7.2 Setting the Report Type

If the **Connection Type** is set to **Print Server**, you need to set the report type:

1. Select the **Main Menu** quick key → from the **System** column select **Maintenance** → input the required password → select .
2. Select the **Print** tab.
3. Set **Connection Type** to **Print Server**.
4. Select the report you intend to set, for example, **General Report**.
5. Set the **Print Action**:
 - ◆ **Paper:** outputs paper report.
 - ◆ **PDF:** outputs the electronic report in PDF format.
 - ◆ **Paper And PDF:** outputs both the paper report and the PDF report.
6. For paper report, respectively select **Printer** and **Printer Resolution** to set the default printer and the resolution for the default printer.
7. For PDF report, select the **PDF Resolution** to set the resolution.

NOTE

- **General reports refer to the reports other than the end case report and realtime alarm report.**

24.7.3 Setting the Report Layout

To set the patient information you want to display on general reports, follow this procedure:

1. Select the **Main Menu** quick key → from the **System column** select **Maintenance** → input the required password → select .
2. Select the **Print** tab → select the **Report Layout** tab.
3. Select the desired items under **Report Name**. **N/A** indicates that this item is not displayed on a report.

24.7.4 Configuring the Name of PDF Files

If you use the Print Server to output patient reports, you can use the PDF printer to output PDF format reports. To configure the name of PDF files, follow this procedure:

1. Select the **Main Menu** quick key → from the **System** column select **Maintenance** → input the required password → select .
2. Select the **Print** tab → select the **PDF File Name** tab.
3. Select the desired items and their sequence under **PDF File Name**. **N/A** refers to no information.

24.7.5 Showing the Second Mark

To set whether you want to show second marks on the report output by the printer, follow this procedure.

1. Select the **Main Menu** quick key → from the **System** column select **Maintenance** → input the required password → select .
2. Select the **Print** tab → select the **Other** tab.
3. Enable or disable **Second Mark (Printer)**.

24.7.6 Setting the Arrhythmia Information to Output by the Recorder

To set whether you want to include arrhythmia thresholds and QRS thresholds in the report output by the recorder, follow this procedure.

1. Select the **Main Menu** quick key → from the **System** column select **Maintenance** → input the required password → select .
2. Select the **Print** tab → select the **Other** tab.
3. Enable or disable **Arrhy Settings (Recorder)**.

24.7.7 Setting Parameter Unit

To set parameter unit, follow this procedure:

1. Select the **Main Menu** quick key → from the **System** column select **Maintenance** → input the required password → select .
2. Select the **Unit** tab.
3. Set unit for each parameter.

24.8 Setting the Time

24.8.1 Setting the Time Synchronization

If the NTP Time Synchronization function is enabled, the monitor can automatically synchronize its time with a time server on which NTP (Network Time Protocol) is implemented. If there are many monitors connected within one network, you can enable the time synchronization to synchronize the time, and make it unnecessary to manually set the time for individual monitors.

24.8.1.1 Enabling NTP Time Synchronization

To enable the NTP Time Synchronization function, follow this procedure:

1. Select the **Main Menu** quick key → from the **System** column select **Maintenance** → input the required password → select .
2. Select the **Time** tab → select the **Time Synchronization** tab.
3. Switch on **Start NTP Time Sync**.

24.8.1.2 Setting the Time Server Address

To set the DNS name of the time server address, follow this procedure:

1. Select the **Main Menu** quick key → from the **System** column select **Maintenance** → input the required password → select .
2. Select the **Time** tab → select the **Time Synchronization** tab.
3. Input the domain name or IP address of the time server.

After configuring the NTP time server, select **Network Test** to verify that the NTP server is properly connected.

24.8.1.3 Setting the Time Synchronization Interval

To set the time synchronization interval, follow this procedure:

1. Select the **Main Menu** quick key → from the **System** column select **Maintenance** → input the required password → select .
2. Select the **Time** tab → select the **Time Synchronization** tab.
3. Set **Interval**.

24.8.1.4 Defining the Night Time Period

To define the nighttime, follow this procedure:

1. Select the **Main Menu** quick key → from the **System** column select **Maintenance** → input the required password → select .
2. Select the **Time** tab → select the **Time Synchronization** tab.
3. Select **From** and **To** to define the beginning and end of Nighttime.

24.8.2 Enabling Auto Daylight Savings Time

By default, daylight savings time is disabled. If this function is needed, you need to manually enable the daylight savings time. To auto start the daylight savings time, follow this procedure:

1. Select the **Main Menu** quick key → from the **System** column select **Maintenance** → input the required password → select .
2. Select the **Time** tab → select the **Daylight Savings Time** tab.
3. Switch on **Auto Daylight Savings Time**.
4. Adjust daylight savings time settings as necessary.

NOTE

-
- **If you enable Auto Daylight Savings Time you cannot manually switch it on or off from the System Time dialog. For more information, see 3.8.1 Setting the Date and Time.**
-

24.9 Viewing Version Information

To view the system software version, module hardware and software version, and firmware version, follow this procedure:

1. Select the **Main Menu** quick key → from the **System** column select **Maintenance** → input the required password → select .
2. Select the **Version** tab.

You can also view the system software version by selecting the **Main Menu** quick key → from the **System** column select **Version**.

24.10 Checking Battery Information

To check the battery information, follow this procedure:

1. Select the **Main Menu** quick key → from the **System** column select **Maintenance** → input the required password → select .
2. Select the **Battery Information** tab.

24.11 Changing Scanner Settings

For the 2D barcode reader, you can change the scanner settings.

24.11.1 Establishing the Relationship between Patient Demographics and 2D Barcode Fields (for the Mindray Custom 2D Barcode Reader)

To configure 2D barcode reader, follow this procedure:

1. Select the **Main Menu** quick key → from the **System** column select **Maintenance** → input the required password → select .
2. Select the **Scanner** tab → select the **2D Barcode** tab.
3. Establish the relationship between the monitor data and hospital's barcode data for selectable patient demographics. For example, the monitor has an option of **Ped** for patient category. In your hospital barcode, the text may read as **Pediatric**. So input **Pediatric** for the field **Ped** to establish their relationship.

24.11.2 Setting the Barcode Reader Information

To set the barcode reader information, follow this procedure:

1. Select the **Main Menu** quick key → from the **System** column select **Maintenance** → input the required password → select .
2. Select the **Scanner** tab → select the **Scanner Info.** tab.
3. Set **Scanner Type**:
 - ◆ **1D Scanner**: select this option when using a 1D scanner or a 2D scanner other than the Mindray custom 2D scanner.
 - ◆ **2D Scanner**: select this option when using the Mindray custom scanner.

NOTE

- **When you set Scanner Type to 2D Scanner, default settings are applied to Data Encoding Type and Data Parse Mode. You do not need to change these setting.**
-

24.11.3 Identifying the Barcode Reader (for the non-Mindray Custom 2D Barcode Reader)

When you are using barcode readers other than the JADAK Flexpoint HS-1R or HS-1M, you should select the barcode reader from the USB device list, so that the monitor can identify the barcode reader. To do so, follow this procedure:

1. Select the **Main Menu** quick key → from the **System** column select **Maintenance** → input the required password → select .
2. Select the **Scanner** tab → select the **Identifying Scanner** tab.
3. From the USB device list, select the barcode reader you are using.

24.11.4 Selecting Patient Information Read by the Barcode Reader (for the Mindray Custom 2D Barcode Reader)

To select desired patient information that will be read by the barcode reader, follow this procedure:

1. Select the **Main Menu** quick key → from the **System** column select **Maintenance** → input the required password → select .
2. Select the **Scanner** tab → select the **Field** tab.
3. Select the patient information. The selected information can be read by the barcode reader.

NOTE

- **The patient information read by the barcode reader is dependent on the patient information encoded in the hospital's barcodes.**
-

24.12 Configuring the Network

You can connect the monitor to the central monitoring system (CMS), eGateway, and other monitors through wired LAN or wireless LAN.

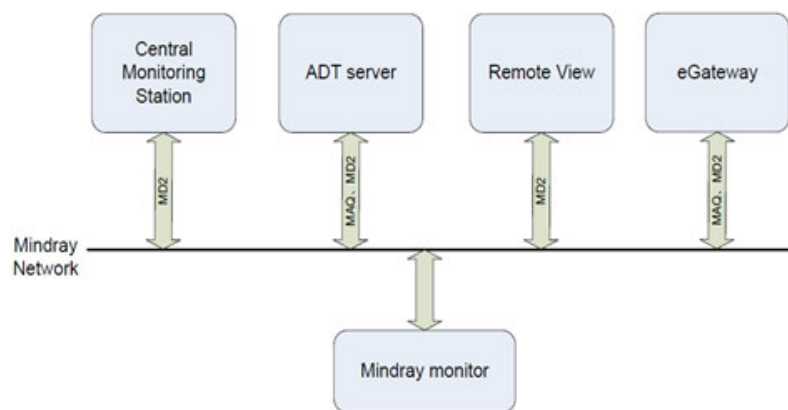

24.12.1 Network Safety Information

CAUTION

- Wireless network design, deployment, debugging, and maintenance should be executed by Mindray service personnel or authorized technicians.
- Always deploy the wireless network according to local wireless regulations.
- Using 5G frequency band is recommended whenever possible. There are more interference sources in 2.4G frequency band.
- Private APs and wireless routers are not allowed. These devices may cause radio interference and result in monitor and CMS data loss.
- Data communication must be performed within a closed network or within a virtually isolated network provided by a hospital for all network functions. The hospital is responsible for ensuring the security of the virtually isolated network.
- WPA2-PSK and WPA2-Enterprise verification and encryption should be used if possible. Otherwise, the equipment may not be able to work or patient information may be divulged. WPA2-Enterprise and a long password are recommended.
- Keep network authentication information, for example passwords, safe, to protect the network from being accessed by unauthorized users.
- Do not connect non-medical devices to the monitor network.
- If wireless network signal is poor, there may be a risk of CMS-destined data loss.
- Maximum number of monitors connected to a single AP is 16. Too many monitors connected to the same AP may result in network disconnection.
- RF interference may result in wireless network disconnection.
- Disconnecting from the network may result in CMS-destined data loss and function failure. Check the patient in case of network disconnection and solve the network problem as soon as possible.
- Ensure that the monitor IP address setting is correct. Changing the network settings may result in network disconnection. Contact your service personnel if there are any problems with the IP address.
- If the device remains in service following the end of support, the cyber security risks for end-users can be expected to increase over time.
- Network disconnection does not have an impact on local monitoring functions.
- Contact Mindray service personnel if cyber security problems occur.

24.12.2 Selecting a Network Type

To select network type, follow this procedure:

1. Select the **Main Menu** quick key → from the **System** column select **Maintenance** → input the required password → select .

2. Select the **Network Setup** tab → select the **Network Type** tab.
3. Set **Monitor** to **Auto**, **LAN1 IP**, or **WLAN** according to your network type. The default is **Auto**, which means the monitor will automatically use LAN1 IP when detected and the available WLAN when LAN1 IP is not detected.

24.12.3 Setting the Wired Network

To set the wired network, follow this procedure:



1. Select the **Main Menu** quick key → from the **System** column select **Maintenance** → input the required password → select .
2. Select the **Network Setup** tab → select the **LAN1 IP** tab.
3. Select how to get the IP address.
 - ◆ **Obtain IP Address Automatically:** the monitor automatically gets the IP address.
 - ◆ **Use the following Address:** you need to input the **IP Address**, **Subnet Mask**, and **Gateway**.
4. Select how to get the DNS address:
 - ◆ **Obtain DNS Address Automatically:** the monitor automatically gets the DNS address.
 - ◆ **Use the following DNS Address:** you need to input the IP address of **Preferred DNS Server** and **Alternate DNS Server**.

24.12.4 Setting the Wireless Network

To set the wireless network, follow this procedure:

1. Select the **Main Menu** quick key → from the **System** column select **Maintenance** → input the required password → select .
2. Select the **Network Setup** tab → select the **WLAN** tab.
3. Select **Add WLAN**. In the popup dialog, input network name, SSID, and password. Set **Security**.
4. Select the **WLAN IP** tab and select how to get the IP address and DNS address.
 - ◆ **Obtain IP Address Automatically:** the monitor automatically gets the IP address.
 - ◆ **Use the Following Address:** you need to input the **IP Address**, **Subnet Mask**, and **Gateway**.
 - ◆ **Obtain DNS Address Automatically:** the monitor automatically gets the DNS address.
 - ◆ **Use the following DNS Address:** you need to input the IP address of **Preferred DNS Server** and **Alternate DNS Server**.
5. Select **WLAN Setup** tab and set WLAN band and channels. The default is **Auto**, which means the monitor can automatically identify the WLAN band.

After configuring the wireless network, select **Network Test** to verify that the wireless network can be properly connected.

If you need to change network settings, select  beside the desired wireless network. Selecting  deletes the wireless network.

24.12.5 Managing Certifications

You can delete certifications from the monitor, or import certifications from the USB memory device. To do so, follow this procedure:

1. Select the **Main Menu** quick key → from the **System** column select **Maintenance** → input the required password → select .
2. Select the **Network Setup** tab → select the **WLAN** tab.
3. Select the **Certificate Management** button from the bottom left corner of the dialog.
 - ◆ From the **Local** tab, select certifications you want to delete from the monitor, and then select **Delete**.
 - ◆ From the **USB Drive** tab, select certifications you want to import from the USB memory device, and then select **Import**.

24.12.6 Enabling Selecting a CMS

To enable selecting a CMS, follow this procedure:

1. Select the **Main Menu** quick key → from the **System** column select **Maintenance** → input the required password → select .
2. Select the **Network Setup** tab → select the **Central Station Setup** tab.
3. Switch on **Select CMS**.

24.12.7 Adding CMSs

You can add up to 30 central monitoring systems (CMS) for your monitor. To add CMSs, follow this procedure:

1. Select the **Main Menu** quick key → from the **System** column select **Maintenance** → input the required password → select .
2. Select the **Network Setup** tab → select the **Central Station Setup** tab.
3. Select **Add Central Station**, and then input the CMS name and IP address of this department.

24.12.8 Setting Multicast Parameters

Multicast helps device discovery between monitors and other devices on the network. Devices in the same multicast group can be mutually discovered.

To set multicast parameters, follow this procedure:

1. Select the **Main Menu** quick key → from the **System** column select **Maintenance** → input the required password → select .
2. Select the **Network Setup** tab → select the **Device Discover** tab.
3. Set **Multicast TTL**.
4. Set **Multicast Address**.

24.12.9 Setting the Master Server Address

To set the DNS name of the master server, follow this procedure:

1. Select the **Main Menu** quick key → from the **System** column select **Maintenance** → input the required password → select .
2. Select the **Network Setup** tab → select the **Device Discover** tab.
3. Select **Master Server Address** to input the DNS name or IP address of the master server.

After configuring the CMS, select **Network Test** to verify that the CMS is properly connected.

24.12.10 Setting the Network Service Quality Level

To set the quality of service (QoS), follow this procedure:

1. Select the **Main Menu** quick key → from the **System** column select **Maintenance** → input the required password → select .
2. Select the **Network Setup** tab → select the **QoS** tab.
3. Select **QoS Level For Realtime Monitoring** to set the service quality of network connection for realtime monitoring, for example parameter measurements and waveforms, alarms, etc.
4. Select **QoS Level For Others** to set the service quality of network connection for non-realtime monitoring, for example history data, printing, etc.

24.12.11 Using the ADT Gateway

The ADT (admit-discharge-transfer) gateway is normally deployed in the eGateway. You can obtain patient information from the hospital ADT server through the ADT gateway.

To configure the ADT gateway, follow this procedure:

1. Select the **Main Menu** quick key → from the **System** column select **Maintenance** → input the required password → select .
2. Select the **Network Setup** tab → select the **ADT** tab.
3. Select **Server Address** to input the host name or IP address of the ADT gateway.
4. Select **Port** to input the port of the ADT gateway.

ADT Query is switched off by default. You can load patient information to the monitor from the ADT server only when this function is enabled.

After configuring the ADT gateway, select **Network Test** to verify that the ADT server is properly connected.

24.12.12 Sending Realtime Data, Waveforms and Alarms via HL7 Protocol

You can send realtime data, waveforms, and/or alarms from the monitor to the hospital information system via HL7 protocol. To do so, follow this procedure:

1. Select the **Main Menu** quick key → from the **System** column select **Maintenance** → input the required password → select .
2. Select the **Network Setup** tab → select the **HL7 Configuration** tab.
3. Select **Network Mode** respectively from the **Data + Waveforms** area and **Alarms** area to set network mode for sending realtime data, waveforms, and/or alarms.
 - ◆ **Client Mode:** the monitor works as a client to connect the hospital information system. In this mode, set **Server Address** by inputting the name or IP address of the hospital server for receiving realtime data, waveform, and/or alarm data. Set **Port** as well.
 - ◆ **Listening Mode:** the monitor works as a server. The hospital information system can connect the monitor to receive realtime data, waveform, and/or alarm data.
4. Switch on **Send Data**, **Send Waveform**, and /or **Send Alarms** as needed.
5. Set **Data Interval**.
6. From the **Compatibility** area, set **HL7 Protocol Version**.

From this page, you can also check the server connection status.

24.12.13 Selecting Data Encryption Type

To set data encryption type, follow this procedure:

1. Select the **Main Menu** quick key → from the **System** column select **Maintenance** → input the required password → select .
2. Select the **Network Setup** tab → select the **Information Security** tab.
3. Select **Encryption Connection Type** to set data encryption type when connecting devices:
 - ◆ **Only Private Encryption:** Mindray private encryption is used to encrypt the transmitted data. You cannot connect devices supporting SSL (secure sockets layer) encryption.
 - ◆ **SSL Encryption Priority:** for devices supporting SSL encryption, SSL encryption is used when connecting the devices. For devices not supporting SSL encryption, private encryption is used when connecting the devices.

24.12.14 Disabling the Broadcasting Patient Demographics Function

When viewing other patients, device location and patient information of remote devices are displayed in the remote device list by default. To protect patient privacy, you can disable the broadcasting of patient demographics function to prevent the monitor from sending patient information via broadcast. To do so, follow this procedure:

1. Select the **Main Menu** quick key → from the **System** column select **Maintenance** → input the required password → select .
2. Select **Network Setup** tab → select the **Information Security** tab.
3. Switch off **Broadcast Patient Demographics**.

Thus, patient information will not display in the remote device list.

24.12.15 Managing TLS Certificates

You can delete local certificates or import certificates from a USB drive.

To delete local CA certificates or user certificates, follow this procedure:

1. Select the **Main Menu** quick key → from the **System** column select **Maintenance** → input the required password → select .
2. Select **Network Setup** tab → **Information Security** tab.
3. Select **Certificate Type**.
4. Select certificates you want to delete.
5. Select **Delete**. To delete all certificate type, select **Delete All**.

To import certificates from a USB drive, follow this procedure:

1. Select the **Import Certificate** tab.
2. Select **Certificate Type**.
3. Select **Certificate Name**, **Private Key Name**, and input private key password.
4. Select **Confirm** to start import.

24.13 MLDAP

MLDAP refers to Mindray LDAP (Lightweight Directory Access Protocol). It is an independent process which can be installed on the eGateway or other application server (Windows). MLDAP provides user identity and authentication.

The MLDAP server is connected with the hospital LDAP server. All monitoring devices are connected to the MLDAP server to implement identity and authentication for the following operations:

- Changing alarm settings
- Changing arrhythmia settings
- Accessing the **Maintenance** dialog

24.13.1 Setting MLDAP

To access the MLDAP server, you should set your monitor as follows:

1. Select the **Main Menu** quick key → from the **System** column select **Maintenance** → input the required password → select .
2. Select the **Network Setup** tab → select the **MLDAP** tab.
3. Set Server address and port of the MLDAP server.

24.13.2 Testing MLDAP Server Connection

To test whether the monitor is properly connected with the MLDAP server, follow this procedure:

1. Select the **Main Menu** quick key → from the **System** column select **Maintenance** → input the required password → select .
2. Select the **Network Setup** tab → select the **MLDAP** tab.
3. Select **Network Test**.

24.13.3 Selecting Password for User Authentication

You can select what password is used when changing alarm settings and arrhythmia settings, viewing current or discharged patient data, and accessing the **Maintenance** dialog. To do so, follow this procedure:

1. Select the **Main Menu** quick key → from the **System** column select **Maintenance** → input the required password → select .
2. Select the **Authorization Setup** tab.
3. From the **Maintenance** area, set **User Maintenance** to select the password for accessing the monitor's **Maintenance** dialog.

- ◆ **Local Password:** the monitor's password for accessing the **Maintenance** dialog is required.
 - ◆ **User Password:** the user name and password saved in the MLDAP server are required.
4. From the **Clinical Setting** area, set passwords for **Alarm Setup**, **Arrhythmia**, **View Discharged Patients**, and **Viewing Patient Review Data**.
- ◆ **No Password:** changing alarm settings and arrhythmia settings, reviewing data of the current patient and discharged patients are not password protected.
 - ◆ **Local Password:** changing alarm settings, arrhythmia settings, and reviewing data of the current patient are password protected. The clinical password is required.
 - ◆ **User Password:** changing alarm settings, arrhythmia settings, and reviewing data of discharged patients are password protected. The user name and password saved in the MLDAP server are required.

From the **Maintenance** area, selecting **Modify Local Password** can change the monitor's password for accessing the **Maintenance** dialog.

From the **Clinical Setting** area, selecting **Modify Local Password** can change the monitor's password for accessing alarm settings and arrhythmia settings, and reviewing data of the current patient and discharged patients.

24.13.4 Setting the Password Timeout Period

If you use the password saved in the MLDAP server to access the **Maintenance** dialog, alarm settings and arrhythmia settings, you can set the password timeout period. Once the timeout period is reached, you will need to re-enter the password. To do so, follow this procedure:

1. Select the **Main Menu** quick key → from the **System** column select **Maintenance** → input the required password → select .
2. Select the **Authorization Setup** tab.
3. Set **Automatic Logout Time**.

24.14 Defining Other Functions

24.14.1 Setting Notch Filter Frequency

Set notch filter frequency according to the power line frequency of your country. To set notch filter frequency, follow this procedure:

1. Select the **Main Menu** quick key → from the **System** column select **Maintenance** → input the required password → select .
2. Select the **Other** tab.
3. Set **Notch Frequency** to **50 Hz** or **60 Hz** according to the power line frequency.

24.14.2 Setting Mouse Sensitivity

The mouse sensitivity is adjustable. To do so, follow this procedure:

1. Select the **Main Menu** quick key → from the **System** column select **Maintenance** → input the required password → select .
2. Select the **Other** tab.
3. Set **Mouse Sensitivity**.

24.14.3 Setting the Manual Event Edit Switch

You can set whether selecting and editing the name of a manual event is allowed. To do so, follow this procedure:

1. Select the **Main Menu** quick key → from the **System** column select **Maintenance** → input the required password → select .
2. Select the **Other** tab.
3. Switch on or off **Manual Event Edit**.

24.14.4 Setting the SpO₂ Tone Mode

The monitor adjusts the QRS tone (pitch tone) according to the SpO₂ values. To set the SpO₂ tone mode, follow this procedure:

1. Select the **Main Menu** quick key → from the **System** column select **Maintenance** → input the required password → select .
2. Select the **Other** tab.
3. Set **SpO₂ Tone** to **Mode 1** or **Mode 2**. The pitch changes more rapidly in Mode 2 than in Mode 1, as saturation levels change.

The SpO₂ tone mode chart for SpO₂ between 40% to 100% is as follows:

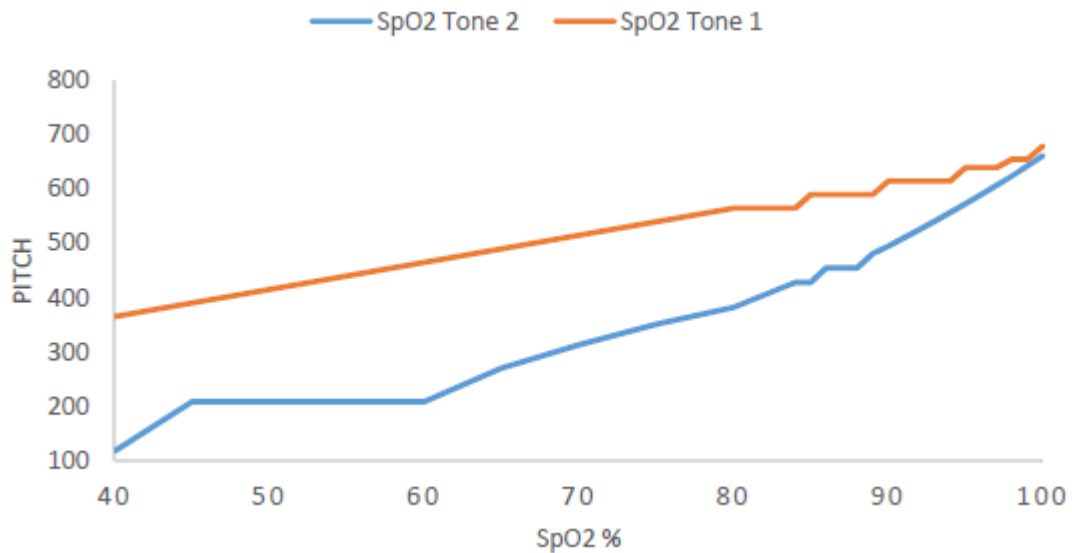

CAUTION

- It is highly recommended to use the same SpO₂ tone mode for the same monitors in a single area to prevent issues arising from inconsistent operation.
-

24.14.5 Selecting the Language

To set the user interface (UI) language, follow this procedure:

1. Select the **Main Menu** quick key → from the **System** column select **Maintenance** → input the required password → select .
2. Select the **Other** tab
3. Set **Language**.

24.14.6 Switching On or Off a Parameter

If there is no **Parameters On/Off** tab in the **Screen Setup** dialog then setting parameter switches is password protected. Follow this procedure to set parameter switches:

1. Select the **Main Menu** quick key → from the **System** column select **Maintenance** → input the required password → select .
2. Select the **Other** tab.
3. Select **Parameters On/Off**.
4. Enable or disable desired parameters.

When a parameter is switched off, the monitor stops data acquisition and alarming for this measurement.

NOTE

- **When a parameter is manually switched off and the corresponding parameter module is plugged in, you cannot monitor this parameter.**

24.14.7 Setting If Setting Parameter Switches is Protected

You can set whether setting parameter switches is password protected. To do so, follow this procedure:

1. Select the **Main Menu** quick key → from the **System** column select **Maintenance** → input the required password → select .
2. Select the **Other** tab.
3. Switch on or off **Parameters On/Off Protected**.

24.14.8 Setting If Parameter Switch is Influenced by Configuration

You can set if the settings of parameter switches are influenced by loading a configuration. To do so, follow this procedure:

1. Select the **Main Menu** quick key → from the **System** column select **Maintenance** → input the required password → select .
2. Select the **Other** tab.
3. Switch on or off **Parameters On/Off Config Influenced**.

24.14.9 Setting Parameter Output Properties

The monitor can output the parameter measurements, alarm limit settings, and alarm status to external devices via the DIAP protocol (Datascope Improved ASCII Protocol). You should configure the DIAP protocol to establish communications between the monitor and the third party device. To do so, follow this procedure:

1. Select the **Main Menu** quick key → from the **System** column select **Maintenance** → input the required password → select .
2. Select the **Other** tab.
3. Select **Parameter Output Setup**.
4. Set **Baud Rate, Parity Mode, Data Bits** and **Stop Bits**.

24.14.10 Browsing System Log

To browse the system log, follow this procedure:

1. Select the **Main Menu** quick key → from the **System** column select **Maintenance** → input the required password → select .
2. Select the **Other** tab.
3. Select **Browse System Log** to enter the **System Log** page.
4. Select the log classifications you want to view, and then select **Search**. To view logs of certain date and time, select **Jump To** and define the date and time.

24.14.11 Exporting System Log

To export the system log, follow this procedure:

1. Connect the USB drive to the monitor's USB connector.
2. Select the **Main Menu** quick key → from the **System** column select **Maintenance** → input the required password → select .
3. Select the **Other** tab.
4. Select **Export System Log**.

This page intentionally left blank.

25 Battery

25.1 Battery Introduction

This monitor is designed to operate on battery power when the mains power is not available. The monitor uses mains power as primary power source. In case of mains power failure, the monitor automatically runs on the battery power.

NOTE

- If the mains power fails and the monitor runs on battery power, the display brightness automatically lowers to the value of Brightness on Battery (set in Screen Setup → Display). You can manually adjust the display brightness as required.
-

25.2 Battery Safety Information

WARNING

- Keep batteries out of the reach of children.
 - Use only Mindray specified batteries. Use of a different battery may present a risk of fire or explosion.
 - Keep the batteries in their original package until you are ready to use them.
 - Do not expose batteries to liquid.
 - Do not crush, drop or puncture the battery. Mechanical abuse can lead to internal damage and internal short circuits. If a battery has been dropped or banged against a hard surface, whether damage is externally visible or not, remove the battery from use and dispose of it properly.
 - If the battery shows signs of damage or signs of leakage, replace it immediately. Use caution in removing the battery. Avoid contacting the leakage.
 - Batteries should be charged only in this monitor.
 - Extremely high ambient temperature may cause battery overheat protection, resulting in monitor shutdown.
 - The lithium-ion battery has a service life of three years. Replace the battery when it reaches the end of its service life. Failure to replace the battery may cause serious damage to the equipment from battery overheating.
 - Do not open batteries, heat batteries above 60 °C, incinerate batteries, or short battery terminals. They may ignite, explode, leak or heat up, causing personal injury.
-

CAUTION

- Remove the battery before shipping the monitor or when it will not be used for an extended period of time.
-

25.3 Installing the Battery

No battery is installed when the monitor leaves the factory. The battery must only be installed by service personnel trained and authorized by Mindray. To install the battery, contact your service personnel.

To install the battery, follow this procedure:

1. Turn off the monitor. Disconnect the power cable and other cables.
2. Open the battery door as indicated below.



3. Turn the latch aside.



4. Insert the battery into the battery compartment with the battery terminal inwards.
5. Turn the latch back to the middle position.
6. Close the battery door.

25.4 Battery Indications

The battery LED, on-screen battery symbols and related alarm messages indicate the battery status.





25.4.1 Battery LED

The battery LED indications are as follows:

- Green: the battery is fully charged.
- Yellow: the battery is being charged.
- Flashing green: the monitor is running on battery power.
- Off: no battery is installed, or the battery malfunctioned, or the AC mains is not connected when the monitor is powered off.

25.4.2 Battery Symbols

The on-screen battery symbols indicate the battery status as follows:

-  indicates that the battery is working correctly. The green portion represents the remaining charge.
-  indicates that the battery power is low and needs to be charged.
-  indicates that the battery is almost depleted and needs to be charged immediately. Otherwise, the monitor will automatically shut down soon.
-  indicates that the battery is being charged.
-  indicates that no battery is installed or the battery has failed.

25.4.3 Battery-related Alarms

The capacity of the battery is limited. When the battery level is low, the monitor presents the **Low Battery** alarm, the alarm lamp flashes, and the monitor produces an alarm sound.

If the battery is almost depleted, the monitor presents the **Critically Low Battery** alarm. In this case, immediately connect the AC mains to power the monitor and charge the battery. Otherwise, the monitor will automatically shut down soon.

For more information on battery-related alarms, see Appendix D *Alarm Messages*.

25.5 Charging the Battery

The battery is recharged automatically when the monitor is connected to AC mains power.

25.6 Maintaining the Battery

25.6.1 Conditioning the Battery

The performance of batteries deteriorates over time. You should condition the batteries periodically or when you notice a degradation in performance. If the battery is not conditioned for a prolonged time, its charge indication may not be accurate and you may wrongly evaluate the remaining battery runtime.

To condition a battery, follow this procedure:

1. Disconnect the monitor from the patient and stop all monitoring and measuring procedures.
2. Turn off the monitor, and connect the monitor to the AC mains power.
3. Allow the battery to be charged uninterruptedly until it is fully charged.
4. Disconnect the monitor from the AC mains power, and turn on the monitor.
5. Allow the monitor to run on the battery until the battery is completely depleted and the monitor automatically shuts down.
6. Fully charge the battery again for use or charge it to 40 - 60% for storage.

NOTE

- **Do not use the monitor to monitor a patient during battery conditioning.**
 - **Do not interrupt battery conditioning. Interrupting battery conditioning to use the monitor will prevent completion of the conditioning cycle and require repeating the conditioning process completely to properly condition the battery.**
-

25.6.2 Checking Battery Performance

The performance of a rechargeable battery deteriorates over time. You should check the battery performance periodically or if you are concerned that the battery may fail.

See steps 1 to 3 of 25.6.1 *Conditioning the Battery* to check battery performance. The operating time of the batteries reflects their performance directly. If the operating time of a battery is noticeably shorter than that stated in the specifications, the battery may have reached its service life or be malfunctioning. If the battery performance meets the requirement, fully charge the battery again for use or charge it to 40 - 60% for storage.

NOTE

- **Battery operating time depends on equipment configuration and operation. For example, high display brightness or measuring NIBP repeatedly will shorten the battery operating time.**
-

25.7 Storing Batteries

When storing batteries, make sure that the battery terminals do not come into contact with metallic objects. If batteries are stored for an extended period of time, place the batteries in a cool place with a partial charge of 40% to 60% capacity.

Condition the stored batteries every three months. For more information, see 25.6.1 *Conditioning the Battery*.

NOTE

- **Remove the battery from the equipment if the equipment is not used for a prolonged time (for example, several weeks). Otherwise the battery may overdischarge.**
 - **Storing batteries at high temperature for an extended period of time will significantly shorten their life expectancy.**
 - **The battery storage temperature is between -5 °C and 35 °C. Storing batteries in a cool place can slow the aging process. Ideally the batteries should be stored at 15 °C.**
-

25.8 Recycling Batteries

Discard a battery in the following situations:

- The battery has visual signs of damage.
- The battery fails.
- The battery is aged and its runtime significantly less than the specification.
- The battery service life is reached.

Properly dispose of batteries according to local regulations.

WARNING

- **Do not open batteries, heat batteries above 60 °C, incinerate batteries, or short the battery terminals. They may ignite, explode, leak or heat up, causing personal injury.**
-
-

26 Care and Cleaning

26.1 Care and Cleaning Introduction

In this chapter we only describe cleaning and disinfection of the main unit, modules and certain accessories. For the cleaning and disinfection of other reusable accessories, refer to their instructions for use of the corresponding accessories.

Keep your equipment and accessories clean. To avoid damage to the equipment, follow these guidelines:

- Always follow the manufacturer's instructions for each cleaning / disinfecting agent.
- Do not immerse any part of the equipment or accessories into liquid.
- Do not pour liquid onto the equipment or accessories.
- Do not allow liquid to enter the case.
- Never use abrasive materials (such as steel wool or silver polish), or erosive cleaners (such as acetone or acetone-based cleaners).

26.2 Care and Cleaning Safety Information

WARNING

- **Be sure to turn off the system and disconnect all power cables from the outlets before cleaning the equipment.**
-

CAUTION

- **If you spill liquid on the equipment or accessories, contact Mindray or your service personnel.**
 - **Avoid wetting the pins and metal parts of the equipment, mounting kits or accessories during cleaning and disinfection.**
 - **Use only Mindray approved cleaners and disinfectants and methods listed in this chapter to clean or disinfect your equipment. Warranty does not cover damage caused by unapproved substances or methods.**
 - **We make no claims regarding the efficacy of the listed chemicals or methods as a means for controlling infection. For the method to control infection, consult your hospital's Infection Control Officer or Epidemiologist.**
 - **Be sure to turn off the system and disconnect all power cables from the outlets before cleaning the equipment.**
 - **The responsible hospital or institution shall carry out all cleaning and disinfection procedures specified in this chapter.**
 - **Refer to the respective instructions for use of the cleaning agents and disinfectants.**
 - **Do not mix disinfecting solutions (such as bleach and ammonia) as hazardous gases may result.**
-

NOTE

- **To clean or disinfect reusable accessories, refer to the instructions delivered with the accessories.**
-

26.3 Cleaning and Disinfecting the Equipment and Mounting Kits

Use approved cleaning and disinfecting agents for cleaning or disinfecting the main unit and parameter modules.

26.3.1 Approved Cleaning and Disinfecting Agents

The following table lists approved cleaning and disinfecting agents:

Product Name	Product Type	Active Ingredients
Sodium hypochlorite bleach	Liquid Powder	Sodium hypochlorite bleach 0.5%
Hydrogen peroxide		Hydrogen peroxide 3%
Isopropanol		Isopropanol 70%
1-Propanol		1-Propanol 50%
Metrex CaviCide1™		Diisobutylphenoxyethoxyethyl dimethyl benzyl ammonium chloride 0.28%, Isopropanol 17.2%
Virex® II 256 (1:256)		Didecyl dimethyl ammonium chloride 8.704%, n-Alkydimethyl benzyl ammonium chloride 8.190%
Virex® TB		n-Alkyl dimethyl benzyl ammonium chlorides 0.105%, n-Alkyl dimethyl ethylbenzyl ammonium chlorides 0.105%
Rely+On™ Virkon® High Level Surface Disinfectant		Used as 1% solution Biocidal active: Pentapotassium bis (peroxymonosulphate) bis (sulphate)(500g/kg), Contains dipotassium peroxodisulphate.
Alpet® D2 Surface Sanitizing Wipes	Wipes	Isopropyl Alcohol 58.6000%, Octyl Decyl Dimethyl Ammonium chloride 0.0075%, Dioctyl Dimethyl Ammonium Chloride 0.0030%
Clorox Dispatch® Hospital Cleaner Disinfectant Towels with Bleach		Sodium Hypochlorite 0.65%
Clorox Healthcare® Bleach Germicidal Wipes		Sodium Hypochlorite 0.55%
Clorox Healthcare® Hydrogen Peroxide Cleaner Disinfectant Wipes		Hydrogen Peroxide 1.4%
Diversey Oxivir® TB Wipes		Hydrogen Peroxide 0.5%
Metrex CaviWipes™		Diisobutylphenoxyethoxyethyl dimethyl benzyl ammonium chloride 0.28%, Isopropanol 17.2%
PDI Sani-Cloth® AF3 Germicidal Disposable Wipe		n-Alkyl dimethyl ethylbenzyl ammonium chlorides 0.14%, n-Alkyl dimethyl benzyl ammonium chlorides 0.14%
PDI Sani-Cloth® Bleach Germicidal Disposable Wipe		Sodium Hypochlorite 0.63%, other ingredients 99.37%
PDI Sani-Cloth® HB Germicidal Disposable Wipe		n-Alkyl dimethyl ethylbenzyl ammonium chlorides 0.07%, n-Alkyl dimethyl benzyl ammonium chlorides 0.07%
PDI Sani-Cloth® Plus Germicidal Disposable Cloth		n-Alkyl dimethyl ethylbenzyl ammonium chlorides 0.125%, n-Alkyl dimethyl benzyl ammonium chlorides 0.125%
PDI Super Sani-Cloth® Germicidal Disposable Wipe		n-Alkyl dimethyl ethylbenzyl ammonium chlorides 0.25%, n-Alkyl dimethyl benzyl ammonium chlorides 0.25%, Isopropyl Alcohol 55.0%

Product Name	Product Type	Active Ingredients
VIRAGUARD Hospital Surface Disinfectant Towelette	Wipes	Isopropanol 70%, Other ingredients 30%

NOTE

- For equipment with the symbol , all the listed cleaning and disinfecting agents are available for use.

26.3.2 Cleaning the Equipment and Mounting Kits

The main unit and parameter modules should be cleaned on a regular basis. Before cleaning the equipment, consult your hospital's regulations for cleaning the equipment.

To clean your equipment, follow this procedure:

- Shut down the monitor and disconnect it from the AC power.
- Clean the display screen with wipes or a soft cloth moistened with one of the cleaning agents listed in *26.3.1 Approved Cleaning and Disinfecting Agents* only.
- Clean the exterior surface of the equipment or parameter modules with wipes or a soft cloth moistened with one of the cleaning agents listed in *26.3.1 Approved Cleaning and Disinfecting Agents* only.
- Wipe off all the cleaning agent residue with a dry cloth.
- Dry your equipment in a ventilated, cool place.

26.3.3 Disinfecting the Equipment and Mounting Kits

Disinfect the main unit and parameter modules as required in your hospital's servicing schedule using the disinfecting agents listed in the table above. Cleaning equipment before disinfecting is recommended.

CAUTION

- Never use EtO or formaldehyde for disinfection.

26.4 Cleaning and Disinfecting the Accessories

For the NIBP air hose, Masimo SpO₂ cable and Nellcor SpO₂ cable, you should clean and disinfect them using the cleaners and disinfectants and methods listed in this section. For other accessories, you should consult the instructions delivered with the accessories.

CAUTION

- Fluids entering the NIBP air hose can damage the equipment. When cleaning and/or disinfecting the NIBP air hose, prevent liquid from entering the hose.
- Periodically inspect the NIBP air hose and connector for signs of wear or deterioration. Replace the NIBP air hose if you detect a leak. Dispose of damaged NIBP air hose according to local laws for disposal of hospital waste.
- Never immerse or soak the accessories in any liquid.
- Never clean or disinfect the metallic connectors at either end of the accessories.
- Use only Mindray approved cleaners and disinfectants and methods listed in this section to clean or disinfect the accessories. Warranty does not cover damage caused by unapproved substances or methods.
- To avoid long term damage, the accessories should be disinfected only when necessary as determined by your hospital's policy.

26.4.1 Approved Accessories Cleaning and Disinfecting Agents

The following table lists approved NIBP air hose cleaning and disinfecting agents:

Product Name	Product Type	Active Ingredients
Isopropanol	Liquid Powder	Isopropanol 70%
1-Propanol		1-Propanol 50%
Metrex CaviCide1™		Diisobutylphenoxyethoxyethyl dimethyl benzyl ammonium chloride 0.28%, Isopropanol 17.2%
Virex® TB		n-Alkyl dimethyl benzyl ammonium chlorides 0.105%, n-Alkyl dimethyl ethylbenzyl ammonium chlorides 0.105%
Rely+On™ Virkon® High Level Surface Disinfectant		Used as 1% solution Biocidal active: Pentapotassium bis (peroxymonosulphate) bis (sulphate)(500g/kg), Contains dipotassium peroxodisulphate.
Alpet® D2 Surface Sanitizing Wipes	Wipes	Isopropyl Alcohol 58.6000%, Octyl Decyl Dimethyl Ammonium chloride 0.0075%, Dioctyl Dimethyl Ammonium Chloride 0.0030%
Clorox Dispatch® Hospital Cleaner Disinfectant Towels with Bleach		Sodium Hypochlorite 0.65%
Metrex CaviWipes™		Diisobutylphenoxyethoxyethyl dimethyl benzyl ammonium chloride 0.28%, Isopropanol 17.2%
PDI Sani-Cloth® AF3 Germicidal Disposable Wipe		n-Alkyl dimethyl ethylbenzyl ammonium chlorides 0.14%, n-Alkyl dimethyl benzyl ammonium chlorides 0.14%
PDI Sani-Cloth® Plus Germicidal Disposable Cloth		n-Alkyl dimethyl ethylbenzyl ammonium chlorides 0.125%, n-Alkyl dimethyl benzyl ammonium chlorides 0.125%
PDI Super Sani-Cloth® Germicidal Disposable Wipe		n-Alkyl dimethyl ethylbenzyl ammonium chlorides 0.25%, n-Alkyl dimethyl benzyl ammonium chlorides 0.25%, Isopropyl Alcohol 55.0%
VIRAGUARD Hospital Surface Disinfectant Towelette		Isopropanol 70%, Other ingredients 30%

The following table lists approved Masimo SpO₂ cable cleaning and disinfecting agents:

Product Name	Product Type	Active Ingredients
Isopropanol	Liquid	Isopropanol 70%

The following table lists approved Nellcor SpO₂ cable cleaning and disinfecting agents:

Product Name	Product Type	Active Ingredients
Sodium hypochlorite bleach	Liquid	Sodium hypochlorite bleach 0.5%
Isopropanol	Powder	Isopropanol 70%
1-Propanol		1-Propanol 50%
Virex® TB		n-Alkyl dimethyl benzyl ammonium chlorides 0.105%, n-Alkyl dimethyl ethylbenzyl ammonium chlorides 0.105%
Rely+On™ Virkon® High Level Surface Disinfectant		Used as 1% solution Biocidal active: Pentapotassium bis (peroxymonosulphate) bis (sulphate)(500g/kg), Contains dipotassium peroxodisulphate.
Clorox Dispatch® Hospital Cleaner Disinfectant Towels with Bleach		Sodium Hypochlorite 0.65%
Clorox Healthcare® Bleach Germicidal Wipes	Wipes	Sodium Hypochlorite 0.55%
Clorox Healthcare® Hydrogen Peroxide Cleaner Disinfectant Wipes		Hydrogen Peroxide 1.4%
Diversey Oxivir® TB Wipes		Hydrogen Peroxide 0.5%
PDI Super Sani-Cloth® Germicidal Disposable Wipe		n-Alkyl dimethyl ethylbenzyl ammonium chlorides 0.25%, n-Alkyl dimethyl benzyl ammonium chlorides 0.25%, Isopropyl Alcohol 55.0%
VIRAGUARD Hospital Surface Disinfectant Towelette		Isopropanol 70%, Other ingredients 30%

26.4.2 Cleaning the Accessories

You should clean the accessories (NIBP air hose, Masimo SpO₂ cable and Nellcor SpO₂ cable) on a regular basis. Before cleaning the accessories, consult your hospital's regulations for cleaning the accessories.

To clean the accessories (NIBP air hose, Masimo SpO₂ cable and Nellcor SpO₂ cable), follow this procedure:

1. Clean the accessories with wipes or a soft cloth moistened with one of the cleaning agents listed in 26.3.1 *Approved Cleaning and Disinfecting Agents* only.
2. Wipe off all the cleaning agent residue with a dry cloth.
3. Allow the accessories to air dry.

26.4.3 Disinfecting the Accessories

We recommend that the accessories (NIBP air hose, Masimo SpO₂ cable and Nellcor SpO₂ cable) should be disinfected only when necessary as determined by your hospital's policy, to avoid long term damage to the accessories. Cleaning the accessories before disinfecting is recommended.

26.5 Sterilization

Sterilization is not recommended for this equipment, related products, accessories, or supplies unless otherwise indicated in the Instructions for Use that accompany the products, accessories or supplies.

This page intentionally left blank.

27 Maintenance

27.1 Maintenance Introduction

Regular maintenance is essential to ensure that the equipment continues to function properly. This chapter contains information on periodic testing and maintenance.

27.2 Maintenance Safety Information

WARNING

- **To avoid electric shock, stop using the equipment if you find the housing is damaged, and contact the service personnel.**
 - **Failure on the part of the responsible individual hospital or institution using this equipment to implement a recommended maintenance schedule may cause undue equipment failure and possible health hazards.**
 - **No modification of this equipment is allowed.**
 - **This equipment contains no user serviceable parts.**
 - **The safety checks or maintenance involving any disassembly of the equipment should be performed by professional service personnel. Otherwise, undue equipment failure and possible health hazards could result.**
 - **Do not open batteries, heat batteries to above 60 °C, incinerate batteries, or short the battery terminals. Batteries may ignite, explode, leak or heat up, causing personal injury.**
 - **The service personnel must be properly qualified and thoroughly familiar with the operation of the equipment.**
-

CAUTION

- **The equipment and accessories shall not be serviced or maintained while in use on a patient.**
 - **If you discover a problem with any of the equipment, contact your service personnel or Mindray.**
 - **Use and store the equipment within the specified temperature, humidity, and altitude ranges.**
 - **When disposing of the packaging material, be sure to observe the applicable waste control regulations and keep it out of the reach of children.**
 - **At the end of its service life, the equipment, as well as its accessories, must be disposed of in compliance with the guidelines regulating the disposal of such products. If you have any questions concerning disposal of the equipment, please contact Mindray.**
-

27.3 Maintenance and Testing Schedule

Follow the maintenance and testing schedule or local regulations to perform testing and maintenance such as defined in section 27.5 *Testing Methods and Procedures*. Follow your hospital policy on cleaning and disinfecting the equipment before testing and maintenance.

The following table lists the maintenance and testing schedule:

Test/Maintenance Item		Recommended Frequency
Performance Tests		
Visual inspection		Every day, before first use.
Measurement module performance test and calibration		<ol style="list-style-type: none"> 1. If you suspect that the measurement values are incorrect. 2. Follow any repairs or replacement of relevant module. 3. Once a year for CO₂ and AG tests. 4. Once every two years for other parameter module performance tests.
Analog output test		If you suspect that the analog output function does not work properly.
Defibrillation synchronization test		If you suspect that the defibrillation synchronization function does not work properly.
Nurse call test		If you suspect that the nurse call function does not work properly.
Electrical Safety Tests		
Electrical safety tests		Once every two years.
Other Tests		
Power-on test		Before use
Recorder check		<ol style="list-style-type: none"> 1. When the recorder is used for the first time. 2. Follow any repair or replacement of the recorder.
Network printer tests		<ol style="list-style-type: none"> 1. When first installed. 2. Follow any repair or replacement of the printer.
Device integration check		<ol style="list-style-type: none"> 1. When first installed. 2. Following any repair or replacement of the external device.
Battery check	Functionality test	<ol style="list-style-type: none"> 1. When first installed. 2. When battery is replaced.
	Performance test	Every three months or if the battery runtime is reduced significantly.

27.4 Checking System Software Version

To view system software version information, select the **Main Menu** quick key → from the **System** column select **Version**.

You can check the detailed system software version, module hardware and software version, and firmware version only from the **Maintenance** dialog.

27.5 Testing Methods and Procedures

Except for the following maintenance tasks, all other test and maintenance tasks should be performed by Mindray-qualified service personnel only.

- Regular checks, including visual inspection and power-on test
- Printer and recorder tests
- Battery check

If your monitor needs a safety test and performance test, contact the service personnel.

27.5.1 Performing Visual Inspection

Visually inspect the equipment before its first use every day. If you find any signs of damage, remove the monitor from use and contact the service personnel.

Verify that the equipment meets the following requirements:

- Environment and power supply specifications are met.
- The monitor housing and display screen are free from cracks or other damage.
- The power cord is not damaged and the insulation is in good condition.
- Connectors, plugs, and cables are not damaged or kinked.
- Power cord and patient cables are securely connected to the equipment and modules.

27.5.2 Performing Power-on Test

The monitor automatically performs a power-on test at startup. Verify the following items for the power-on test:

- The equipment powers on properly.
- The alarm system works properly, denoted by alarm sounds and display of all 3 alarm light colors.
- The monitor displays properly.

27.5.3 Testing the Recorder

To test the recorder, follow this procedure:

1. Start a recording task to print waveforms and reports.
2. Check that the recorder functions correctly.
3. Check that the printout is clear without missing dots.

27.5.4 Testing the Network Printer

To check the printer, follow this procedure:

1. Start a printing task to print waveforms and reports.
2. Check that the printer is properly connected and functions correctly.
3. Check that the printout is clear without missing information.

27.5.5 Checking the Battery

For information on battery check, see 25.6.2 *Checking Battery Performance*.

27.6 NIBP Maintenance

27.6.1 NIBP Leakage Test

The NIBP leakage test checks the integrity of the system and of the valve. The NIBP leakage test should be performed once every two years or when you doubt the NIBP measurements. The NIBP leakage test should be performed by Mindray-qualified service personnel only.

27.6.2 NIBP Accuracy Test

The NIBP accuracy test should be performed once every two years or when you doubt the NIBP measurements. The NIBP accuracy test should be performed by Mindray-qualified service personnel only.

27.7 Disposing of the Monitor

Dispose of the monitor and its accessories when its service life is reached. Follow local regulations regarding the disposal of such products.

WARNING

- **For disposal of parts and accessories, where not otherwise specified, follow local regulations regarding disposal of hospital waste.**
-
-

28 Accessories

The accessories listed in this chapter comply with the requirements of IEC 60601-1-2 when in use with the patient monitor. The accessory material that contacts the patients has undertaken the bio-compatibility test and is verified to be in compliance with ISO 10993-1. For details about the accessories, refer to the instructions for use provided with the accessory.

WARNING

- Use accessories specified in this chapter. Using other accessories may cause damage to the patient monitor or not meet the claimed specifications.
- Single-use accessories are not designed to be reused. Reuse may cause a risk of contamination and affect the measurement accuracy.

CAUTION

- The accessories may not meet the performance specifications if stored or used outside the specified temperature and humidity ranges. If accessory performance is degraded due to aging or environmental conditions, contact your service personnel.
- Check the accessories and their packages for any sign of damage. Do not use them if any damage is detected.
- Use the accessories before the expiration date if an expiration date is indicated.
- Discard disposable accessories according to hospital regulations.

NOTE

- This manual describes all the accessories that are validated for use. Not all accessories are available in every market.

28.1 ECG Accessories

28.1.1 ECG Electrodes Available for Purchase

Model	Part No.	Description	Usage	Applicable patient
31499224	0010-10-12304	Electrode, Kendall, pkg of 10	Disposable	Adult
1050NPSMKittycat	0681-00-0098-01	NEO pre-wired electrode radio Opaque, pkg of 100	Disposable	Neonate
1051NPSMKittycat	0681-00-0098-02	NEO pre-wired electrode radio Translucent, pkg of 100	Disposable	Neonate

28.1.2 ECG Electrodes Also Compatible

Model	Part No.	Description	Usage	Applicable patient
2245-50	9000-10-07469	ECG electrode, 3M, pkg of 50	Disposable	Pediatric
H1245G	900E-10-04880	Neonatal ECG electrode (kendall, package of 50)	Disposable	Neonate

28.1.3 12-Pin Trunk Cables Available for Purchase

Model	Part No.	Description	Usage	Applicable patient
EV6201	0010-30-42719	12Pin 3/5-Lead ECG trunk cable, defibrillation-proof	Reusable	Adult/Pediatric
EV6211	0010-30-42723	12Pin 3/5-Lead ECG trunk cable, ESU-proof	Reusable	Adult/Pediatric
EV6222	040-000754-00	12Pin 3-Lead trunk cable, defibrillation-proof, DIN Conn	Reusable	Pediatric/Neonate
EV6206	009-005266-00	ECG cable, 10' (3.1 m), defibrillation-proof, for N/T	Reusable	Adult/Pediatric
EV6207	009-005267-00	ECG cable, 20' (6.2 m), defibrillation-proof, for N/T	Reusable	Adult/Pediatric
EV6216	009-005268-00	ECG cable, 10' (3.1 m), ESU-proof, for N/T	Reusable	Adult/Pediatric
EV6217	009-005269-00	ECG cable, 20' (6.2 m), ESU-Proof, for N/T	Reusable	Adult/Pediatric

28.1.4 3-lead ECG Leadwires Available for Purchase

Model	Part No.	Description	Usage	Applicable patient
EY6316B	009-004765-00	3-Lead, N/T, AHA, snap, 24"	Reusable	Adult/Pediatric
EY6305B	009-004766-00	3-Lead, N/T, AHA, snap, 36"	Reusable	Adult/Pediatric
EY6316A	009-004771-00	3-Lead, N/T, AHA, clip, 24"	Reusable	Adult/Pediatric
EY6305A	009-004772-00	3-Lead, N/T, AHA, clip, 36"	Reusable	Adult/Pediatric
EY6310B	009-004777-00	3-Lead, N/T, AHA, snap, 24"	Disposable	Adult/Pediatric
EY6310B	115-032954-00	3-Lead, N/T, AHA, snap, 24", pkg of 20	Disposable	Adult/Pediatric

28.1.5 3-lead ECG Leadwires Also Compatible

Model	Part No.	Description	Usage	Applicable patient
EL6303A	0010-30-42731	3-Lead leadset, AHA, clip, Long	Reusable	Adult/Pediatric
EL6301B	0010-30-42734	3-Lead leadset, AHA, snap	Reusable	Adult/Pediatric
EL6311B	040-000146-00	3-Lead leadset, AHA, snap	Disposable	Pediatric/Neonate
EL6311A	040-000148-00	3-Lead leadset, AHA, clip	Disposable	Pediatric/Neonate

28.1.6 5-lead ECG Leadwires Available for Purchase

Model	Part No.	Description	Usage	Applicable patient
EY6511B	009-004782-00	5-Lead, N/T, AHA, snap, 24"	Reusable	Adult/Pediatric
EY6512B	009-004783-00	5-Lead, N/T, AHA, snap, 36"	Reusable	Adult/Pediatric
EY6511A	009-004786-00	5-Lead, N/T, AHA, pinch, 24"	Reusable	Adult/Pediatric
EY6512A	009-004787-00	5-Lead, N/T, AHA, pinch, 36"	Reusable	Adult/Pediatric
EY6507B	009-004790-00	5-Lead, N/T, AHA, snap, 24"	Disposable	Adult/Pediatric
EY6507B	115-032955-00	5-Lead, N/T, AHA, snap, 24", pkg of 20	Disposable	Adult/Pediatric

28.1.7 5-lead ECG Leadwires Also Compatible

Model	Part No.	Description	Usage	Applicable patient
EL6503A	0010-30-42729	5-Lead leadset, AHA, clip, Long	Reusable	Adult/Pediatric
EL6501B	0010-30-42735	5-Lead leadset, AHA, snap	Reusable	Adult/Pediatric
EL6501A	0010-30-42727	5-Lead leadset, AHA, clip	Reusable	Adult/Pediatric

28.2 SpO₂ Accessories

Wavelength emitted by the sensors is between 600 nm and 1000 nm. The maximum photic output consumption of the sensor is less than 18 mW.

The information about the wavelength range and maximum photic output consumption can be especially useful to clinicians, for example, when photodynamic therapy is performed.

28.2.1 Extension Cables and Adapter Cables Available for Purchase

Model	Part No.	Description	Usage	Applicable patient
572A	0010-20-42712	8-pin SpO ₂ extension cable, Nellcor	Reusable	/
583A	040-003310-00	8-pin, RD SET, Masimo	Reusable	/
4089	040-003381-00	RD to LNCS adapter cable, Masimo	Reusable	/
4092	040-003426-00	LNCS to RD adapter, Masimo	Reusable	/

28.2.2 Extension Cables and Adapter Cables Also Compatible

Model	Part No.	Description	Usage	Applicable patient
582A	115-020768-00	8-pin SpO ₂ extension cable, Masimo	Reusable	/

28.2.3 Masimo SpO₂ RD Set Sensors Available for Purchase

Model	Part No.	Description	Usage	Applicable patient
4050	040-003376-00	SpO ₂ sensor, RD SET DCI	Reusable	Adult (> 30 kg)
4051	040-003377-00	SpO ₂ sensor, RD SET DCI	Reusable	Pediatric (10-50 kg)
4053	040-003380-00	SpO ₂ sensor, RD Set TC-I, tip-clip ear sensor, 3ft	Reusable	Adult (> 30 kg)
4000	040-003382-00	SpO ₂ sensor, RD SET Adt, adhesive, pkg of 20	Disposable	Adult (> 30 kg)
4001	040-003383-00	SpO ₂ sensor, RD SET PDT, adhesive, pkg of 20	Disposable	Pediatric (10 to 50 kg)
4002	040-003384-00	SpO ₂ sensor, RD Set Inf, adhesive, pkg of 20	Disposable	Infant (3 to 20 kg)
4003	040-003385-00	SpO ₂ sensor, RD Set Neo, adhesive, pkg of 20	Disposable	Neonatal /Adult (<3Kg or >40Kg)
4004	040-003386-00	SpO ₂ sensor, RD Set NeoPt, adhesive, pkg of 20	Disposable	Neonate (<1 kg)
4005	040-003387-00	SpO ₂ sensor, RD Set NeoPt-500, non-adhesive, pkg of 20	Disposable	Neonate (<1 kg)

28.2.4 Masimo SpO₂ LNCS Sensors Also Compatible

Model	Part No.	Description	Usage	Applicable patient
LNCS Amtx	0600-00-0121	SpO ₂ sensor, finger-clip, 20 pcs/box	Disposable	Adult (>30 kg)
LNCS Pmtx	0600-00-0122	SpO ₂ sensor, finger-clip, 20 pcs/box	Disposable	Pediatric (10-50 kg)
LNCS DCI	0600-00-0126	SpO ₂ sensor, finger-clip	Reusable	Adult (>30 kg)
LNCS DCIP	0600-00-0127	SpO ₂ sensor, finger-clip	Reusable	Pediatric (10-50 kg)
LNCS NeoPt	0600-00-0156	SpO ₂ sensor, finger-clip	Disposable	Neonate (<1Kg)
LNCS Neo-L	0600-00-0157	SpO ₂ sensor, 20 pcs/box	Disposable	Neonate /Adult (<3 kg or > 40 kg)
LNCS Inf	0600-00-0158	SpO ₂ sensor, 20 pcs/box	Disposable	Infant (3-20 kg)

28.2.5 Nellcor SpO₂ Sensors Also Compatible

Model	Part No.	Description	Usage	Applicable patient
DS100A	9000-10-05161	SpO ₂ sensor, finger-clip	Reusable	Adult
D-YS	0010-10-12476	SpO ₂ sensor, with wraps	Reusable	/
OXI-P/I	9000-10-07308	SpO ₂ sensor, finger, band	Reusable	Pediatric/Infant
OXI-A/N	9000-10-07336	SpO ₂ sensor, finger/foot, band	Reusable	Adult/Neonate
MAX-AI	0010-10-12202	SpO ₂ sensor, 24 pcs/box	Disposable	Adult (>30 kg)
MAX-PI	0010-10-12203	SpO ₂ sensor, 24 pcs/box	Disposable	Pediatric (10-50 Kg)
MAX-II	0010-10-12204	SpO ₂ sensor, 24 pcs/box	Disposable	Infant (3-20 kg)
MAX-NI	0010-10-12205	SpO ₂ sensor, 24 pcs/box	Disposable	Adult/Neonate (<3 kg or >40 kg)

28.3 Temp Accessories

28.3.1 Temp Cable Available for Purchase

Model	Part No.	Description	Usage	Applicable patient
MR420B	040-001235-00	2-pin Temperature adapter cable	Reusable	/

28.3.2 Temp Probes Available for Purchase

Model	Part No.	Description	Usage	Applicable patient
MR401B	0011-30-37392	Temperature probe, endocavity	Reusable	Adult
MR402B	0011-30-37394	Temperature probe, endocavity	Reusable	Pediatric/Infant
MR403B	0011-30-37393	Temperature probe, skin surface	Reusable	Adult
MR404B	0011-30-37395	Temperature probe, skin surface	Reusable	Pediatric/Infant
MR411	040-003292-00	Temperature probe, esophageal/rectal, 9FR	Disposable	Adult/Pediatric
MR411	040-003294-00	Temperature probe, esophageal/rectal, 9FR, pkg of 20	Disposable	Adult/Pediatric
MR412	040-003293-00	Temp probe, skin surface	Disposable	All

Model	Part No.	Description	Usage	Applicable patient
MR412	040-003295-00	Temp probe, skin surface, pkg of 20	Disposable	All
ES400-12	0206-03-0112-02	PROBE,D TEMP,ES400-12 (box of 20)	Disposable	Adult
ES400-18	0206-03-0118-02	PROBE,D TEMP,ES400-18 (box of 20)	Disposable	Adult
ER400-9	0206-03-0209-02	PROBE,D TEMP,ER 400-9 (box of 20)	Disposable	Adult
ER400-12	0206-03-0212-02	PROBE,D TEMP,ER400-12 (box of 20)	Disposable	Adult
STS-400	0206-03-0300-02	PROBE,D TEMP,STS-400 (box of 20)	Disposable	Adult

28.4 NIBP Accessories

28.4.1 NIBP Hoses Available for Purchase

Model	Part No.	Description	Usage	Applicable patient
CM1901	6200-30-11560	NIBP hose, inbuilt connector, 3m	Reusable	Neonate

28.4.2 NIBP Hoses Also Compatible

Model	Part No.	Description	Usage	Applicable patient
CM1903	6200-30-09688	NIBP hose, inbuilt connector, 3m	Reusable	Adult/Pediatric/ Neonate

28.4.3 Cuffs Available for Purchase

Model	Part No.	Description	Usage	Applicable patient
CM1301	115-027713-00	Cuff, 10-19 cm, bladderless	Reusable	Infant
CM1302	115-027714-00	Cuff, 18-26 cm, bladderless	Reusable	Small Adult
CM1303	115-027715-00	Cuff, 25-35 cm, bladderless	Reusable	Adult
CM1304	115-027716-00	Cuff, 33-47 cm, bladderless	Reusable	Adult
CM1305	115-027717-00	Cuff, 46-66 cm, bladderless	Reusable	Adult thigh
CM1306	115-027718-00	Cuff, 24-35 cm, bladderless	Reusable	Adult
CM1307	115-027719-00	Cuff, 33-47 cm, bladderless	Reusable	Adult
CM1501	115-027563-00	Cuff, 10-19 cm, bladderless, pkg of 10	Disposable	Child
CM1502	115-027564-00	Cuff, 18-26 cm, bladderless, pkg of 10	Disposable	Small adult
CM1503	115-027565-00	Cuff, 25-35 cm, bladderless, pkg of 10	Disposable	Adult
CM1504	115-027566-00	Cuff, 33-47 cm, bladderless, pkg of 10	Disposable	Large adult
CM1505	115-027567-00	Cuff, 46-66 cm, bladderless, pkg of 5	Disposable	Adult thigh
CM1506	115-027568-00	Cuff, 25-35 cm, bladderless, pkg of 10, long	Disposable	Adult
CM1507	115-027569-00	Cuff, 33-47 cm, bladderless, pkg of 10, long	Disposable	Large adult
CM1500A	125-000051-00	Cuff, 3.1-5.7 cm, pkg of 20	Disposable	Neonate
CM1500B	125-000052-00	Cuff, 4.3-8.0 cm, pkg of 20	Disposable	Neonate
CM1500C	125-000053-00	Cuff, 5.8-10.9 cm, pkg of 20	Disposable	Neonate

Model	Part No.	Description	Usage	Applicable patient
CM1500D	125-000054-00	Cuff, 7.1-13.1 cm, pkg of 20	Disposable	Neonate
/	115-031807-00	Cuff starter kit, bladderless	Reusable	Child/Small adult/ Adult/Adult thigh

28.5 IBP Accessories

28.5.1 IBP Accessories Available for Purchase

Model	Part No.	Description	Usage	Applicable patient
IM2202	001C-30-70757	12 Pin IBP cable, Argon	Reusable	/
IM2201	001C-30-70759	12 Pin IBP cable, ICU Medical	Reusable	/
/	125-000123-00	12 Pin IBP cable, Edwards (not for transportation)	Reusable	/

28.5.2 ICP Accessories Available for Purchase

Model	Part No.	Description	Usage	Applicable patient
82-6653	040-002336-00	Codman ICP sensor kit, Johnson & Johnson, pkg of 1	Disposable	/
/	115-025257-00	Camino ICP cable kit	Reusable	/
CP12601	009-005460-00	12 Pin ICP Cable	Reusable	/

28.6 C.O. Accessories Available for Purchase

Model	Part No.	Description	Usage	Applicable patient
CO7702	0010-30-42743	12Pin C.O. cable, Edwards	Reusable	/
9850A	0012-00-1519	C.O. cable kit with TI sensor	Reusable	/
SP4042	6000-10-02079	In-line injection temperature sensor, BD	Reusable	/
SP5045	6000-10-02080	In-line injection temperature sensor housing, BD, pkg of 25	Disposable	/
MX387	6000-10-02081	12cc control syringe w/Rotator (MEDEX MX387), pkg of 20	Disposable	/
93522	0012-00-1520	In-line inject temperature probe	Reusable	/

28.7 CO₂ Accessories

28.7.1 Sidestream CO₂ Accessories Available for Purchase

Model	Part No.	Description	Usage	Applicable patient
4000	115-043001-00	CO2 Nasal sample cannula, 7" line, pkg of 25	Disposable	Adult
4100	115-043002-00	CO2 Nasal sample cannula, 7" line, pkg of 25	Disposable	Pediatric

Model	Part No.	Description	Usage	Applicable patient
4200	115-043003-00	CO2 Nasal sample cannula, 7" line, pkg of 25	Disposable	Neonatal
60-15200-00	115-043017-00	Sampling line, 2.5 m, pkg of 25	Disposable	Adult/Pediatric
60-15300-00	115-043018-00	Sampling line, 2.5 m, pkg of 25	Disposable	Neonatal
60-14100-00	115-043020-00	Dryline airway adapter, straight, pkg of 10	Disposable	Adu/Ped
040-001187-00	115-043019-00	Airway Adapter pkg of 10	Disposable	Neonatal
60-14200-00	115-043021-00	Dryline airway adapter, elbow pkg of 10	Disposable	/
100-000080-00	115-058733-00	Watertrap, DRYLINE II, pkg of 10	Reusable	Adult/Pediatric
100-000081-00	115-058734-00	Watertrap, DRYLINE II, pkg of 10	Reusable	Neonatal
4707	125-000365-00	CO2 Nasal cannula,with O ₂ , pkg of 25	Disposable	Adult
4703	125-000366-00	CO2 Nasal cannula,with O ₂ , pkg of 25	Disposable	Pediatric
4700	125-000367-00	CO2 Nasal cannula,with O ₂ , pkg of 25	Disposable	Neonatal

28.7.2 Microstream CO₂ Accessories Also Compatible

Model	Part No.	Description	Usage	Applicable patient
MVAI	0010-10-42560	Adult-Pediatric Intubated CO2 FilterLine	Disposable	Adult, pediatric
MVAIH	0010-10-42561	Adult-Pediatric Intubated CO2 FilterLine	Disposable	Adult, pediatric
MVIH	0010-10-42562	Neonatal-Infant Intubated CO2 FilterLine	Disposable	Neonate
MVAIL	0010-10-42563	Adult-Pediatric Intubated CO2 FilterLine	Disposable	Adult, pediatric
MVAIHL	0010-10-42564	Adult-Pediatric Intubated CO2 FilterLine	Disposable	Adult, pediatric
MVIHL	0010-10-42565	Neonatal-Infant Intubated CO2 FilterLine	Disposable	Neonate
MVA	0010-10-42566	Adt Oral-Nasal CO2 FilterLine	Disposable	Adult
MVP	0010-10-42567	Ped Oral-Nasal CO2 FilterLine	Disposable	Pediatric
MVAO	0010-10-42568	Adt Oral-Nasal CO2 FilterLine w/O2	Disposable	Adult
MVPO	0010-10-42569	Ped Oral-Nasal CO2 FilterLine w/O2	Disposable	Pediatric
MVAOL	0010-10-42570	Adt Oral-Nasal CO2 FilterLine w/O2 L	Disposable	Adult
MVPOL	0010-10-42571	Ped Oral-Nasal CO2 FilterLine w/O2 L	Disposable	Pediatric
MVANH	0010-10-42572	Adult Nasal CO2 FilterLine	Disposable	Adult
MVINH	0010-10-42574	Neo-Inf Nasal CO2 FilterLine H	Disposable	Neonate
MVANO	0010-10-42575	Adt Nasal CO2 FilterLine w/O2 H	Disposable	Adult
MVPNOH	0010-10-42576	Ped Nasal CO2 FilterLine w/O2 H	Disposable	Pediatric
MVAN	0010-10-42577	Adult Nasal CO2 FilterLine	Disposable	Adult
MVPN	0010-10-42578	Pediatric Nasal CO2 FilterLine	Disposable	Pediatric

28.8 AG Accessories

Model	Part No.	Description	Usage	Applicable patient
60-15200-00	115-043017-00	Sampling line, 2.5 m, pkg of 25	Disposable	Adult/Pediatric

Model	Part No.	Description	Usage	Applicable patient
60-15300-00	115-043018-00	Sampling line, DRYLINE, 2.5m, pkg of 25	Disposable	Neonate
60-14100-00	115-043020-00	DRYLINE airway adapter, straight, pkg of 10	Disposable	Adult/Pediatric
60-14200-00	115-043021-00	DRYLINE airway adapter, elbow, pkg of 10	Disposable	Adult/Pediatric
100-000080-00	115-058733-00	DRYLINE II water trap	Reusable	Adult/Pediatric
100-000081-00	115-058734-00	DRYLINE II water trap	Reusable	Neonate
115-052162-00	115-052162-00	Generic scavenging line	Reusable	/

28.9 External Modules

Module	Part No.	Comments
C.O. module	115-047275-00	Supports C.O. monitoring
IBP module	115-047274-00	Supports IBP monitoring
Microstream CO ₂ module	120-023072-00	Supports CO ₂ monitoring
Sidestream CO ₂ module	115-048924-00	Supports CO ₂ monitoring
AG module	120-021994-00	Supports AG monitoring, integrates O ₂ (paramagnetic) monitoring

28.10 Mount and Mounting Accessories

Part No.	Description
045-002148-00	Passport12 wall mount (VHM)
045-003428-00	Rolling stand with quick release mount
045-004267-00	Rolling stand
045-003424-00	Quick release mount for rolling stand and wall mount
045-003427-00	M series wall mount with quick release mount
045-002935-00	Disinfectant wipes mount
045-002877-00	VS600/VS900 new value stand
045-002960-00	VS600/900 Rolling stand
045-002936-00	No handle basket pack
8000-30-90170	Bedrail clamp
045-003255-00	N12 roll stands (With iPM/iMEC adapter)
8000-30-90169	Bedrail hook
034-000666-00	Barcode reader holder (for JADAK Barcode reader)
042-007382-00	Cable management hook

28.11 Miscellaneous Accessories

Part No.	Description
DA8K-10-14452	Power cord, USA
115-065140-00	Lithium-ion battery, 10.95 V, 4500 mAh, LI23S002A
023-000218-00	USB flash drive, 8 GB, USB2.0
1000-21-00122	Grounding cable
023-000247-00	Keyboard, wired USB connector, black
023-000248-00	Mouse, wired USB connector, black
023-000524-00	Wireless keyboard and mouse set
023-000525-00	Wired keyboard and mouse set
023-001566-00	HP LaserJet Enterprise M608n, black and white
023-001286-00	2D Barcode reader, HS-1M, JADAK
023-001288-00	2D Barcode reader, HS-1R, JADAK
115-045643-00	Remote controller
115-056983-00	Clinical Scoring Custom CD
009-003116-00	Nurse call cable
009-003117-00	Analog output cable
009-003118-00	Synchronization cable
A30-000001---	Recording paper, 50 mm*20 m
009-003648-00	Cable protecting tube, 20cm&40cm
009-003903-00	Accessories management tape
009-009117-00	Serial port cable

This page intentionally left blank.

A Product Specifications

A.1 Monitor Safety Specifications

The monitor is classified, according to IEC 60601-1:

Degree of protection against electrical shock	Type CF defibrillation proof for ECG, Resp, SpO ₂ , NIBP, Temp, IBP, C.O. Type BF defibrillation proof for CO ₂ , AG
Type of protection against electrical shock	Class I
Degree of protection against harmful ingress of water	IPX1
Degree of safety of application in the presence of flammable anesthetic mixture with air or with oxygen or nitrous oxide	The equipment is not suitable for use in the presence of a flammable anesthetic mixture with air or with oxygen or nitrous oxide
Mode of operation	Continuous

A.2 Physical Specifications

Item	Maximum Weight (kg)	W × H × D (mm)	Comments
ePM 10M main unit	4.5(standard configuration and recorder, excluding battery, accessories and modules)	269 × 252 × 159	4.0 kg (standard configuration, excluding battery, accessories, modules and recorder)
ePM 12M main unit	5.5(standard configuration and recorder, excluding battery, accessories and modules)	310 × 289 × 169	4.8 kg (standard configuration, excluding battery, accessories, modules and recorder)
IBP module	0.26	136.5 × 40 × 102	/
C.O. module	0.25	136.5 × 40 × 102	/
Microstream CO ₂ module	0.38	136.5 × 40 × 102	/
Sidestream CO ₂ module	0.54	136.5 × 40 × 102	/
AG module	1.03	136.5 × 80.5 × 102	With built-in O ₂ module

A.3 Environmental Specifications

WARNING

- **The monitor may not meet the performance specifications if stored or used outside the specified temperature and humidity ranges. If the performance of the equipment is degraded due to aging or environmental conditions, contact your service personnel.**
- **When the monitor and related products have differing environmental specifications, the effective range for the combined products is that range which is common to the specifications for all products.**

NOTE

- **The environmental specification of unspecified parameter modules are the same as those of the main unit.**

Main Unit			
Item	Temperature (°C)	Relative humidity (noncondensing) (%)	Barometric
Operating Condition	0 to 40 (0 to 35 configured with AG module)	15 to 95	427.5 to 805.5 mmHg (57 to 107.4 kPa)
Storage Condition	-20 to 60	10 to 95	120 to 805.5 mmHg (16 to 107.4 kPa)
Microstream CO₂ Module			
Item	Temperature (°C)	Relative humidity (noncondensing) (%)	Barometric
Operating Condition	0 to 40	15 to 95	430 to 790 mmHg (57.3 to 105.3 kPa)
Storage Condition	-20 to 60	10 to 95	430 to 790 mmHg (57.3 to 105.3 kPa)
Sidestream CO₂ Module			
Item	Temperature (°C)	Relative humidity (noncondensing) (%)	Barometric
Operating Condition	5 to 40	15 to 95	430 to 790 mmHg (57.3 to 105.3 kPa)
Storage Condition	-20 to 60	10 to 95	430 to 790 mmHg (57.3 to 105.3 kPa)
AG Module			
Item	Temperature (°C)	Relative humidity (noncondensing) (%)	Barometric
Operating Condition	10 to 40	15 to 95	525 to 805.5 mmHg (70 to 107.4 kPa)
Storage Condition	-20 to 60	10 to 95	525 to 805.5 mmHg (70 to 107.4 kPa)

A.4 Power Supply Specifications

A.4.1 External Power Supply Specifications

AC Power	
Line voltage	100 to 240 VAC (±10%)
Input current	2.0 to 0.9 A
Frequency	50/60 Hz (± 3 Hz)

A.4.2 Battery Specifications

Battery type	Rechargeable lithium-Ion battery (non-smart battery)
Battery voltage	10.95V
Battery capacity	4500 mAh
Maximum number of batteries configured	only one battery can be connected.
Run time	≥ 4 hours when the monitor is powered by a new fully-charged battery at 25 °C±5 °C with 5-lead ECG and SpO ₂ cable connected, auto NIBP measurements at an interval of 15 minutes, and screen brightness set to 1. Shutdown delay: at least 15 minutes after the low battery alarm first occurs.
Charge time	<ul style="list-style-type: none">• No more than 5 hours to 90% when the monitor is off• No more than 10 hours to 90% when the monitor is on

A.5 Display Specifications

Screen type	Capacitive, multi-point color touchscreen	
Screen Size (diagonal)	ePM 12M:	12.1 inches
	ePM 10M:	10.1 inches
Resolution	ePM 12M:	1280 x 800 pixels
	ePM 10M:	1280 x 800 pixels

A.6 Recorder Specifications

Method	Thermal dot array
Horizontal resolution	16 dots/mm (25 mm/s paper speed)
Vertical resolution	8 dots/mm
Paper width	50 mm±1mm
Paper length	20 m
Paper speed	25 mm/s, 50 mm/s Accuracy: ±5%
Number of waveform channels	A maximum of 3

A.7 LEDs

Alarm lamp	1 or 2 (three color-coded: red, yellow, and cyan)
Power-on LED	1 (green)
AC power LED	1 (green)
Battery LED	1 (two color-coded: yellow and green)

A.8 Audio Indicator

Speaker	Give alarm tones (45 to 85 dB), reminder tones, key tones, QRS tones; support PITCH TONE and multi-level tone modulation; alarm tones comply with IEC 60601-1-8.
Audio signal	Alarm tone: ISO mode with frequency of 600 Hz QRS tone: short beep with frequency of 650 Hz Key tone: short beep with frequency of 1000 Hz

A.9 Monitor Interface Specifications

AC power input	1
Network connector	1, standard RJ45 connectors, 100 Base-TX, IEEE 802.3
USB connector	2, USB 2.0
Module rack	1
Multifunctional connector	1
Video output connector	1, 15-pin D-sub
Equipotential grounding terminal	1

A.10 Signal Outputs Specifications

Auxiliary Output	
Standard	Meets the requirements of IEC 60601-1 for short-circuit protection and leakage current
ECG Analog Output	
Bandwidth (-3dB; reference frequency: 10Hz)	Diagnostic mode: 0.05 to 150 Hz Monitor mode: 0.5 to 40 Hz Surgical mode: 1 to 20 Hz ST mode: 0.05 to 40 Hz
Maximum QRS delay	25 ms (in diagnostic mode, and non-paced)
Gain (reference frequency 10Hz)	1V/mV ($\pm 5\%$)
Pace enhancement	Signal amplitude: $V_{oh} \geq 2.5V$ Pulse width: $10ms \pm 5\%$ Signal rising and falling time: $\leq 100\mu s$
IBP Analog Output	
Bandwidth (-3dB; reference frequency: 1Hz)	0 to 40 Hz
Maximum transmission delay	30 ms
Gain (reference frequency 1 Hz)	1 V/100 mmHg, $\pm 5\%$
Nurse Call Signal	
Amplitude	High level: 3.5 to 5 V, $\pm 5\%$, providing a minimum of 10 mA output current; Low level: $< 0.5 V$, receiving a minimum of 5 mA input current.
Rising and falling time	$\leq 1 ms$
Defib Sync Pulse	

Output impedance	≤100 Ω
Maximum time delay	35 ms (R-wave peak to leading edge of pulse)
Amplitude	High level: 3.5 to 5 V, ±5%, providing a maximum of 10 mA output current; Low level: < 0.5 V, receiving a maximum of 5 mA input current.
Pulse width	100 ms ±10%
maximum rising and falling time	1 ms
Alarm Output	
Alarm delay time from the monitor to remote equipment	The alarm delay time from the monitor to remote equipment is ≤2 seconds, measured at the monitor signal output connector.
Alarm signal sound pressure level range	45 db(A) to 85 db(A) within a range of one meter

A.11 Data Storage

Trends	<ul style="list-style-type: none"> Standard-capacity memory card: up to 120 hours of trend data with the resolution no less than 1 minute, or up to 1200 hours of trend data with the resolution no less than 10 minutes. High-capacity memory card: up to 240 hours of trend data with the resolution no less than 1 minute, or up to 2400 hours of trend data with the resolution no less than 10 minutes.
Events	<ul style="list-style-type: none"> Standard-capacity memory card: 1000 events, including parameter alarms, arrhythmia events, technical alarms, and so on. High-capacity memory card: 2000 events, including parameter alarms, arrhythmia events, technical alarms, and so on.
NIBP measurements	<ul style="list-style-type: none"> Standard-capacity memory card: 1000 sets. High-capacity memory card: 3000 sets.
Full-disclosure waveforms	<ul style="list-style-type: none"> Standard-capacity memory card: up to 48 hours for one waveform. The specific storage time depends on the waveforms stored and the number of stored waveforms. High-capacity memory card: up to 48 hours for all parameter waveforms.
ST view	A maximum of 120 hours of ST segment waveforms. One group of ST segment waveforms is stored every minute.
OxyCRG view	A maximum of 48 hours of OxyCRG events.

A.12 Wi-Fi Specifications

A.12.1 Wi-Fi Technical Specifications (MSD45N)

Protocol	IEEE 802.11a/b/g/n
Modulation mode	BPSK, QPSK, 16QAM, 64QAM
Operating frequency	2.4 GHz to 2.495 GHz 5.15 GHz to 5.25 GHz, 5.725 GHz to 5.85 GHz
Channel spacing	IEEE 802.11b/g: 5 MHz IEEE 802.11n (at 2.4 GHz): 5 MHz IEEE802.11a: 20 MHz IEEE802.11n (at 5 GHz): 20 MHz
Wireless baud rate	IEEE 802.11b: 1 Mbps to 11 Mbps IEEE 802.11g: 6 Mbps to 54 Mbps IEEE 802.11n: 6.5 Mbps to 72.2 Mbps (MCS0-MCS7) IEEE 802.11a: 6 Mbps to 54 Mbps

Output power	<20dBm (CE requirement, detection mode: RMS) <30dBm (FCC requirement: detection mode: peak power)
Operating mode	As station, access AP for data transmission
Data security	Standards: WPA-PSK AES, WPA2-PSK, WPA-Enterprise, WPA2-Enterprise, CCKM AES EAP method: EAP-FAST, EAP-TLS, EAP-TTLS, PEAP-GTC, PEAP- MSCHAPv2, PEAP-TLS, LEAP Encryption: AES

A.12.2 Wi-Fi Technical Specifications (SX-SDMAC-2832S+)

Protocol	IEEE 802.11a/b/g/n
Modulation mode	BPSK, QPSK, 16QAM, 64QAM
Operating frequency	2412 MHz to 2462 MHz 5180 MHz to 5320 MHz, 5500 MHz to 5700 MHz, 5745 MHz to 5825 MHz WARNIGN: SX-SDMAC-2832S+ supports the DFS channels. When using the DFS channels, Wi-Fi performance stability and roaming time can be undermined due to avoiding interfering with Radar systems. DFS channels are disabled by default and not recommended. The operator should comprehensively assess the risk before using the DFS channels.
Channel spacing	IEEE 802.11b/g: 5 MHz IEEE 802.11n (at 2.4 GHz): 5 MHz IEEE802.11a: 20 MHz IEEE802.11n (at 5 GHz): 20 MHz
Wireless baud rate	IEEE 802.11b: 1 Mbps to 11 Mbps IEEE 802.11g: 6 Mbps to 54 Mbps IEEE 802.11n: MCS0 - MCS7 IEEE 802.11a: 6 Mbps to 54 Mbps
Output power	<20 dBm (CE requirements, detection mode: RMS) <30 dBm (FCC requirements, detection mode: peak power)
Operating mode	As station, access AP for data transmission
Data security	Standards: WPA-PSK AES, WPA2-PSK, WPA-Enterprise, WPA2-Enterprise, CCKM AES EAP method: EAP-FAST, EAP-TLS, EAP-TTLS, PEAP-GTC, PEAP-MSCHAPv2, PEAP-TLS, LEAP Encryption: AES

A.12.3 Wi-Fi Performance Specifications

WARNING

- All network function of data communication are designed to operate on a private network.
-

A.12.3.1 System Capacity

Number of the monitors supported by a single AP: ≤ 16.

- Each monitor can communicate with the CMS.
- Two monitors are used to view other monitors.
- Only one monitor can transmit history data.
- The weakest strength of the AP signal where the monitor is located can not be less than -65 dBm.

A.12.3.2 Resistance to Wireless Interference

The distance between the interfering devices and the monitor is greater than 20 cm. A Wi-Fi interference (no greater than -85 dBm) in the same channel and a Wi-Fi interference (no greater than -50 dBm) in an adjacent-channel are presented synchronously. The interfering devices include, but are not limited to, 2.4 GHz wireless devices, cellular mobile networks, microwave ovens, interphones, cordless phones, and ESU equipment. The interfering devices do not include Wi-Fi devices.

The monitoring network must support the following requirements:

- All the monitors do not encounter communication loss.
- The total delay of data transmission from the monitor to the CMS: ≤ 2 seconds.
- The delay for monitor-related settings configured at the CMS to be effective: ≤ 2 seconds.
- The total delay of data transmission from one monitor to the other: ≤ 2 seconds.
- The delay for the monitor to reset alarms of another to be effective: ≤ 2 seconds.

A.12.3.3 Wi-Fi Network Stability

The ratio of the communication data loss on the CMS from any monitor does not exceed 0.1% over a 24-hour period.

Testing conditions are as follows:

- Number of the monitors supported by a single AP: ≤ 16 .
- 12 of the 16 monitors connected to the network roam for 30 times.
- Each monitor can communicate with the CMS.
- Two monitors are used to view other monitors.
- Only one monitor can transmit history data.
- The weakest strength of the AP signal where the monitor is located cannot be less than -65 dBm.

A.12.3.4 Line of Sight Distance

The line of sight distance between the monitor and the AP is no less than to 50 meters.

A.13 Measurement Specifications

The adjustable range of alarm limits is the same with the measurement range of signals unless otherwise specified.

A.13.1 ECG Specifications

ECG	
Standards	Meet standards of IEC 60601-2-27: 2011 and IEC 60601-2-25: 2011
Lead set	3-lead: I, II, III 5-lead: I, II, III, aVR, aVL, aVF, V
ECG standard	AHA, IEC
Display sensitivity	1.25 mm/mV ($\times 0.125$), 2.5 mm/mV ($\times 0.25$), 5 mm/mV ($\times 0.5$), 10 mm/mV ($\times 1$), 20 mm/mV ($\times 2$), 40 mm/mV ($\times 4$), Auto, less than 5% error
Sweep speed	6.25 mm/s, 12.5 mm/s, 25 mm/s, 50 mm/s, less than 5% error
Bandwidth (-3dB)	Diagnostic mode: 0.05 to 150 Hz Monitor mode: 0.5 to 40 Hz Surgical mode: 1 to 20 Hz ST mode: 0.05 to 40 Hz

Common mode rejection ratio	Diagnostic mode: >90 dB Monitor mode: >105 dB (with notch filter on) Surgical mode: >105 dB (with notch filter on) ST mode: >105 dB (with notch filter on)
Notch filter	50/60 Hz Monitor, surgical, and ST mode: notch filter turns on automatically Diagnostic mode: notch filter is turned on/off manually
Differential input impedance	≥5 MΩ
Input signal range	±8mV (peak-to-peak value)
Accuracy of signal reproduction	Use A and D methods based on IEC 60601-2-25 to determine frequency response.
Electrode offset potential tolerance	±500 mV
Lead-off detection current	Measuring electrode: <0.1 μA Drive electrode: <1 μA
Input offset current	≤0.1 μA, (drive lead≤1μA)
Defibrillation protection	Enduring 5000V (360 J) charge without data loss or corruption Baseline recovery time: <5 s (after defibrillation) Polarization recovery time: <10 s Defibrillation energy absorption: ≤10% (100Ω load)
Patient leakage current	<10 uA
Calibration signal	1mV (peak-to-peak value) ±5%
ESU protection	Cut mode: 300 W Coagulate mode: 100 W Recovery time: ≤10 s In compliance with the requirements in clause 202.6.2.101 of IEC 60601-2-27
Pace Pulse	
Pace pulse markers	Pace pulses meeting the following conditions are labelled with a PACE marker: Amplitude: ±2 to ±700 mV Width: 0.1 to 2 ms Rise time: 10 to 100 μs (no greater than 10% of pulse width) No overshoot
Pace pulse rejection	When tested in accordance with the IEC 60601-2-27: 201.12.1.101.13, the heart rate meter rejects all pulses meeting the following conditions. Amplitude: ±2 to ±700 mV Width: 0.1 to 2 ms Rise time: 10 to 100 μs (no greater than 10% of pulse width) No overshoot
HR	
Measurement range	Neonate: 15 to 350 bpm Pediatric: 15 to 350 bpm Adult: 15 to 300 bpm
Resolution	1 bpm
Accuracy	±1 bpm or ±1%, whichever is greater.
Sensitivity	200 μV (lead II)

HR averaging method	<p>In compliance with the requirements in Clause 201.7.9.2.9.101 b) 3) of IEC 60601-2-27, the following method is used:</p> <p>If the last 3 consecutive RR intervals are greater than 1200 ms, the 4 most recent RR intervals are averaged to compute the HR. Otherwise, heart rate is computed by subtracting the maximum and minimum ones from the most recent 12 RR intervals and then averaging them.</p> <p>The HR value displayed on the monitor screen is updated no more than one second.</p>	
Response to irregular rhythm	<p>In compliance with the requirements in Clause 201.7.9.2.9.101 b) 4) of IEC 60601-2-27, the heart rate after 20 seconds of stabilization is displayed as follows:</p> <p>Ventricular bigeminy (waveform A1): 80±1 bpm Slow alternating ventricular bigeminy (waveform A2): 60±1 bpm Rapid alternating ventricular bigeminy (waveform A3): 120±1 bpm Bidirectional systoles (waveform A4): 90±2 bpm</p>	
Response time to heart rate change	<p>Meets the requirements of IEC 60601-2-27: Clause 201.7.9.2.9.101 b) 5).</p> <p>From 80 to 120 bpm: less than 11 s From 80 to 40 bpm: less than 11 s</p>	
Time to alarm for tachycardia	<p>Meets the requirements in Clause 201.7.9.2.9.101 b) 6) of IEC 60601-2-27.</p> <p>Waveform</p> <p>B1h-range: <11 s B1-range: <11 s B1d-range: <11 s B2h-range: <11 s B2-range: <11 s B2d-range: <11 s</p>	
Tall T-wave rejection capability	<p>When the test is performed based on Clause 201.12.1.101.17 of IEC 60601-2-27, the heart rate calculation is not affected for QRS of 1 mV amplitude and 100 ms duration, T-wave duration of 180 ms and amplitude lower than 1.2 mV, and QT interval of 350 ms.</p>	
Arrhythmia Analysis Classifications	<p>Asystole, V-Fib/V-Tach, V-Tach, Vent Brady, Extreme Tachy, Extreme Brady, Vent Rhythm, PVCs/min, Pauses/min, Couplet, Bigeminy, Trigeminy, R on T, Run PVCs, PVC, Tachy, Brady, Missed Beats, Pacer Not Pacing, Pacer Not Capture, Multiform PVC, Nonsus V-Tach, Pause, Irr Rhythm, A-Fib</p>	
ST Segment Analysis		
Measurement range	-2.0 to 2.0 mV RTI	
Accuracy	-0.8 to 0.8 mV: ±0.02 mV or ±10%, whichever is greater. Beyond this range: Not specified.	
Resolution	0.01mV	
QT/QTc Analysis		
Measurement range	QT: 200 to 800 ms QTc: 200 to 800 ms QT-HR: 15 to 150 bpm for adult, 15 to 180 bpm for pediatric and neonate	
Accuracy	QT: ±30 ms	
Resolution	QT: 4 ms QTc: 1 ms	
Alarm limit	Range	Step
HR High	HR ≤ 40 bpm: (low limit + 2 bpm) to 40 bpm HR > 40 bpm: (low limit + 5 bpm) to 295 bpm	HR ≤ 40 bpm: 1 bpm HR > 40 bpm: 5 bpm
HR Low	HR ≤ 40 bpm: 16 bpm to (high limit - 2 bpm) HR > 40 bpm: 40 bpm to (high limit - 5 bpm)	

ST High	(low limit + 0.2 mV) to 2.0 mV (ST alarm mode: Absolute) 0 mV to 2.0 mV (ST alarm mode: Relative)	0.05 mV
ST Low	-2.0 mV to (high limit - 0.2 mV) (ST alarm mode: Absolute) -2.0 mV to 0 mV (ST alarm mode: Relative)	
QTc High	200 to 800 ms	10 ms
ΔQTc High	30 to 200 ms	

A.13.2 Resp Specifications

Technique	Trans-thoracic impedance	
Lead	Options are lead I, II and Auto.	
Respiration excitation waveform	<300 μA RMS, 62.8 kHz (±10%)	
Minimum respiration impedance threshold	0.3Ω	
Baseline impedance range	200 to 2500Ω (using an ECG cable with 1kΩ resistance)	
Bandwidth	0.2 to 2.5 Hz (-3 dB)	
Sweep speed	3mm/s, 6.25 mm/s, 12.5 mm/s, 25 mm/s or 50 mm/s, less than 10% error	
Respiration Rate		
Measurement range	Adult: 0 to 120 rpm Pediatric, neonate: 0 to 150 rpm	
Resolution	1 rpm	
Accuracy	7 to 150 rpm: ±2 rpm or ±2%, whichever is greater 0 to 6 rpm: not specified	
Apnea alarm delay	10 s, 15 s, 20 s, 25 s, 30 s, 35 s, 40 s	
Alarm limit	Range (rpm)	Step (rpm)
RR High	Adult, Pediatric: RR≤20 (low limit + 2) to 20 RR>20 (low limit + 5) to 100 Neonate: RR≤20 (low limit + 2) to 20 RR>20 (low limit + 5) to 150	RR≤20: 1 RR>20: 5
RR Low	RR≤20: 0 to (high limit - 2) RR>20: 20 to (high limit - 5)	

A.13.3 SpO₂ Specifications

Refer to Appendix F *SpO₂ Sensor Accuracy* for the clinical study results of SpO₂ sensor accuracy.

Alarm limit	Range (%)	Step (%)
SpO ₂ High	(low limit + 2) to 100	1
SpO ₂ Low	Masimo: (Desat+1) to (high limit - 2) Nellcor: (Desat+1) or 20 (whichever is greater) to (high limit - 2)	
SpO ₂ Desat Low	0 to (SpO ₂ low limit - 1)	

Masimo SpO₂ Module

Standards	Meets the requirements of ISO 80601-2-61: 2011
Measurement range	1 to 100%
Resolution	1%
Response time	≤20 s (normal perfusion, no disturbance, SpO2 value sudden changes from 70% to 100%)
Accuracy ¹	70 to 100%: ±2%ABS (measured without motion in adult/pediatric mode) 70 to 100%: ±3%ABS (measured without motion in neonate mode) 70 to 100%: ±3%ABS (measured with motion) 1% to 69%: Not specified.
Refresh rate	≤ 1 s
SpO2 averaging time	2-4 s, 4-6 s, 8 s, 10 s, 12 s, 14 s, 16 s
Low perfusion conditions	Pulse amplitude: >0.02% Light penetration: >5%
Low perfusion SpO2 accuracy ²	±2%
PI measurement range	0.02 to 20%
<p>¹ The Masimo pulse oximeter with sensors have been validated for no motion accuracy in human blood studies on healthy adult volunteers in induced hypoxia studies in the range of 70% to 100% SpO2 against a laboratory co-oximeter and ECG monitor. This variation equals plus or minus one standard deviation. Plus or minus one standard deviation encompasses 68% of the population. One percent was added to the accuracies for neonatal sensors to account for accuracy variation due to properties of fetal hemoglobin.</p> <p>The Masimo pulse oximeter with sensors has been validated for motion accuracy in human blood studies on healthy adult volunteers in induced hypoxia studies while performing rubbing and tapping motions at 2 to 4 Hz. At an amplitude of 1 to 2 cm and non-repetitive motion between 1 to 5 Hz. At an amplitude of 2 to 3 cm in induced hypoxia studies in the range of 70% to 100% SpO2 against a laboratory co-oximeter and ECG monitor. This variation equals plus or minus one standard deviation. Plus or minus one standard deviation encompasses 68% of the population.</p> <p>² The Masimo pulse oximeter has been validated for low perfusion accuracy in bench top testing against a Biotek Index 2 simulator and Masimo's simulator with signal strengths of greater than 0.02% and a % transmission of greater than 5% for saturations ranging from 70 to 100%. This variation equals plus or minus one standard deviation. Plus or minus one standard deviation encompasses 68% of the population.</p>	

Nellcor SpO₂ Module

Measurement range	0 to 100%
Resolution	1%
Refreshing rate	≤1 s
Response time	≤30 s (normal perfusion, no disturbance, SpO2 value sudden change from 70% to 100%)
Accuracy	70 to 100%: ±2%ABS (adult/pediatric) 70 to 100%: ±3%ABS (neonate) 0% to 69%: Not specified.
<p>When the SpO₂ sensor is applied for neonatal patients as indicated, the specified accuracy range is increased by ±1%, to compensate for the theoretical effect on oximeter measurements of fetal hemoglobin in neonatal blood.</p>	

A.13.4 PR Specifications

Alarm limit	Range	Step
PR High	PR≤40bpm: (low limit + 2 bpm) to 40 bpm PR > 40 bpm: (low limit + 5 bpm) to 295 bpm	PR≤40: 1 bpm PR>40: 5 bpm
PR Low	PR≤40bpm: 16 bpm to (high limit - 2 bpm) PR > 40 bpm: 40 bpm to (high limit - 5 bpm)	

PR from Masimo SpO₂

Measurement range	25 to 240 bpm
Resolution	1 bpm
Response time	≤20 s (with normal perfusion, no disturbance, and a PR value transition from 25 to 220 bpm)
Accuracy	±3 bpm (measured without motion) ±5 bpm (measured with motion)
Refresh rate	≤1 s

PR from Nellcor SpO₂ Module

Measurement range	20 to 300 bpm
Resolution	1 bpm
Response time	≤30 s (normal perfusion, no disturbance, PR value sudden change from 25 to 250 bpm)
Accuracy	20 to 250 bpm: ±3 bpm 251 to 300 bpm, not specified
Refreshing rate	≤1 s

PR from IBP Module

Measurement range	25 to 350 bpm
Resolution	1 bpm
Accuracy	±1 bpm or ±1%, whichever is greater

A.13.5 Temp Specifications

Standard	Meet the standard of ISO 80601-2-56: 2017	
Technique	Thermal resistance	
Operating mode	Direct mode	
Measurement range	0 to 50 °C (32 to 122 °F)	
Resolution	0.1 °C	
Accuracy	±0.1 °C or ±0.2 °F (excluding probe error)	
Refreshing rate	≤1 s	
Minimum time for accurate measurement	Body surface: <100 s Body cavity: <80 s	
Alarm limit	Range	Step
TXX High (XX refers to temperature site)	(low limit +1.0) to 50.0 °C (low limit +2.0) to 122.0 °F	0.1 °C 0.1 °F
TXX Low (XX refers to temperature site)	0.1 to (high limit - 1.0) °C 32.2 to (high limit - 2.0) °F	
ΔT High	0.1 to 50.0 °C 0.2 to 90.0 °F	

A.13.6 NIBP Specifications

Standard	Meet standard of IEC 80601-2-30: 2018
Technique	Oscillometry

Mode of operation	Manual, Auto, STAT, Sequence			
Auto mode repetition intervals	1, 2, 2.5, 3, 5, 10, 15, 20, 30, 60, 90, 120, 180, 240 or 480 min			
STAT mode cycle time	5 min			
Max measurement time	Adult, Pediatric: 180 s Neonate: 90 s			
Heart rate range	30 to 300 bpm			
Measurement ranges (mmHg)		Adult	Pediatric	Neonate
	Systolic:	25 to 290	25 to 240	25 to 140
	Diastolic:	10 to 250	10 to 200	10 to 115
	Mean:	15 to 260	15 to 215	15 to 125
Accuracy	Max mean error: ± 5 mmHg Max standard deviation: 8 mmHg			
Resolution	1 mmHg			
Initial cuff inflation pressure range (mmHg)	Adult: 80 to 280 Pediatric: 80 to 210 Neonate: 60 to 140			
Default initial cuff inflation pressure (mmHg)	Adult: 160 Pediatric: 140 Neonate: 90			
Software overpressure protection	Adult: 297 ± 3 mmHg Pediatric: 297 ± 3 mmHg Neonate: 147 ± 3 mmHg			
Static pressure measurement range	0 mmHg to 300 mmHg			
Static pressure measurement accuracy	± 3 mmHg			
PR				
Measurement range	30 to 300 bpm			
Resolution	1 bpm			
Accuracy	± 3 bpm or $\pm 3\%$, whichever is greater			
Alarm limit	Range (mmHg)		Step (mmHg)	
NIBP-S High	Adult: (low limit + 5) to 285 Pediatric: (low limit + 5) to 235 Neonate: (low limit + 5) to 135		NIBP ≤ 50 : 1 NIBP > 50 : 5	
NIBP-S Low	26 to (high limit - 5)			
NIBP-M High	Adult: (low limit + 5) to 255 Pediatric: (low limit + 5) to 210 Neonate: (low limit + 5) to 120			
NIBP-M Low	16 to (high limit - 5)			
NIBP-D High	Adult: (low limit + 5) to 245 Pediatric: (low limit + 5) to 195 Neonate: (low limit + 5) to 110			
NIBP-D Low	11 to (high limit - 5)			

NIBP-S Extreme High	NIBP-S high limit < 50 Adult: (NIBP-S high limit + 1) to 290 Pediatric: (NIBP-S high limit + 1) to 240 Neonate: (NIBP-S high limit + 1) to 140 NIBP-S high limit ≥ 50 Adult: (NIBP-S high limit + 5) to 290 Pediatric: (NIBP-S high limit + 5) to 240 Neonate: (NIBP-S high limit + 5) to 140	NIBP ≤ 50: 1 NIBP > 50: 5
NIBP-S Extreme Low	NIBP-S low limit ≤ 50 25 to (NIBP-S low limit - 1) NIBP-S low limit > 50 25 to (NIBP-S low limit - 5)	
NIBP-M Extreme High	NIBP-M high limit < 50 Adult: (NIBP-M high limit + 1) to 260 Pediatric: (NIBP-M high limit + 1) to 215 Neonate: (NIBP-M high limit + 1) to 125 NIBP-M high limit ≥ 50 Adult: (NIBP-M high limit + 5) to 260 Pediatric: (NIBP-M high limit + 5) to 215 Neonate: (NIBP-M high limit + 5) to 125	
NIBP-M Extreme Low	NIBP-M low limit ≤ 50 15 to (NIBP-M low limit - 1) NIBP-M low limit > 50 15 to (NIBP-M low limit - 5)	
NIBP-D Extreme High	NIBP-D high limit < 50 Adult: (NIBP-D high limit + 1) to 250 Pediatric: (NIBP-D high limit + 1) to 200 Neonate: (NIBP-D high limit + 1) to 115 NIBP-D high limit ≥ 50 Adult: (NIBP-D high limit + 5) to 250 Pediatric: (NIBP-D high limit + 5) to 200 Neonate: (NIBP-D high limit + 5) to 115	NIBP ≤ 50: 1 NIBP > 50: 5
NIBP-D Extreme Low	NIBP-D low limit ≤ 50 10 to (NIBP-D low limit - 1) NIBP-D low limit > 50 10 to (NIBP-D low limit - 5)	

*Measurement accuracy verification: In adult and pediatric modes, the blood pressure measurements measured with this device are in compliance with the Standard for Non-invasive sphygmomanometers (ISO 81060-2) in terms of mean error and standard deviation by comparing with intra-arterial or auscultatory measurements (depending on the configuration) in a typical patient population. For auscultatory reference, the 5th Korotkoff sound was used to determine the diastolic pressure.

In neonatal mode, the blood pressure measurements measured with this device are in compliance with the American National Standard for Non-invasive sphygmomanometers (ISO 81060-2) in terms of mean error and standard deviation by comparing with intra-arterial measurements (depending on the configuration) in a typical patient population.

A.13.7 IBP Specifications

Standard	Meet the standard of IEC 60601-2-34: 2011
Technique	Direct invasive measurement
IBP	
Measurement range	-50 to 300 mmHg
Resolution	1 mmHg
Accuracy	±2% or ±1 mmHg, whichever is greater (excluding sensor error)

Refreshing rate	≤1 s	
PPV		
Measurement range	0% ~ 50%	
Pressure transducer		
Excitement voltage	5 VDC, ±2%	
Sensitivity	5 μV/V/mmHg	
Zero adjustment range	±200 mmHg	
Impedance range	300 to 3000Ω	
Volume displacement	<0.04 mm ³ /100 mmHg	
Alarm limit	Range (mmHg)	Step (mmHg)
Sys High	IBP ≤ 50: (low limit + 2) to 50 IBP > 50: (low limit + 5) to 295	IBP ≤ 50: 1 IBP > 50: 5
Mean High		
Dia High		
Sys Low	IBP ≤ 50: -49 to (high limit - 2) IBP > 50: 50 to (high limit - 5)	
Mean Low		
Dia Low		
Art-S Extreme High	High limit < 50: (Art-S high limit+ 1) to 300 High limit ≥ 50: (Art-S high limit+ 5) to 300	IBP ≤ 50: 1 IBP > 50: 5
Art-M Extreme High		
Art-D Extreme High		
Art-S Extreme Low	low limit < 50: -50 to (Art-S low limit- 1) low limit ≥ 50: 50 to (Art-S low limit- 5)	
Art-M Extreme Low		
Art-D Extreme Low		

A.13.8 C.O. Specifications

Standard	Meet the standard of ISO 80601-2-56: 2017	
Measurement method	Thermodilution method	
Measurement range	C.O.:	0.1 to 20 L/min
	TB:	23 to 43 °C
	TI:	0 to 27 °C
Resolution	C.O.:	0.1 L/min
	TB, TI:	0.1 °C
Accuracy	C.O.:	±5% or ±0.1 L /min, whichever is greater
	TB, TI:	±0.1 °C (without sensor)
Repeatability	C.O.:	±2% or ±0.1 L/min, whichever is greater
TB Operating mode	Direct mode	
Minimum time for accurate TB measurement	10 s	
Alarm range	TB:	23 to 43 °C
Alarm limit	Range	Step
TB High	(low limit + 1) to 43 °C (low limit + 2) to 109.4 °F	0.1 °C 0.1 °F
TB Low	23 to (high limit - 1) °C 73.4 to (high limit - 2) °F	

A.13.9 CO₂ Specifications

Measurement mode	Sidestream, microstream	
Technique	Infrared absorption	
Apnea delay	10 s, 15 s, 20 s, 25 s, 30 s, 35 s, 40 s	
Alarm limit	Range	Step
EtCO ₂ High	(low limit + 2) to 99 mmHg	1 mmHg
EtCO ₂ Low	1 to (high limit - 2)mmHg	
FiCO ₂ High	1 to 99 mmHg	

Sidestream CO₂ Module

Standard	Meet the standard of ISO 80601-2-55: 2011
CO ₂ Measurement range	0 to 150 mmHg
CO ₂ absolute accuracy*	Full accuracy mode: 0 to 40 mmHg: ± 2 mmHg 41 to 76 mmHg: ±5% of reading 77 to 99 mmHg: ±10% of reading 100 to 150 mmHg: ±(3 mmHg + 8% of reading) ISO accuracy mode: add ±2mmHg to the full accuracy mode
Inaccuracy specifications are affected by the breath rate and I:E. The EtCO ₂ accuracy is within specification for breath rate ≤ 60 rpm and I/E ratio ≤ 1:1, or breath rate ≤ 30 rpm and I/E ratio ≤ 2:1.	
CO ₂ resolution	1 mmHg
Accuracy drift	Meet the requirement for measurement accuracy within 6 hours

Sample flowrate	Connected a DRYLINE II watertrap for adult and pediatric patient: 120 ml/min Connected a DRYLINE II watertrap for neonatal patient: 90 ml/min or 70 ml/min	
Sample flowrate tolerance	±15% or ±15 ml/min, whichever is greater.	
Start-up time	Maximum: 90 s Typically: 20 s	
Response time	Measured with a DRYLINE II neonatal watertrap and a 2.5-meter neonatal sampling line: ≤5.0 s @ 70 ml/min ≤4.5 s @ 90 ml/min Measured with a DRYLINE II adult watertrap and a 2.5-meter adult sampling line: ≤5.0 s @ 120 ml/min	
Rise time	Measured with a DRYLINE II neonatal watertrap and a 2.5-meter neonatal sampling line: ≤250 ms@70 ml/min. ≤250 ms@90 ml/min. Measured with a DRYLINE II adult watertrap and a 2.5-meter adult sampling line: ≤300 ms@120 ml/min	
awRR measurement range	0 to 150 rpm	
awRR measurement precision	≤60 rpm: ±1 61 to 150 rpm: ±2	
awRR resolution	1 rpm	
Data sample rate	50 Hz	
Effect of interference gases on CO₂ measurements		
Gas	Concentration (%)	Quantitative effect*
N ₂ O	≤60	±1 mmHg
Hal	≤4	
Sev	≤5	
Iso	≤5	
Enf	≤5	
Des	≤15	±2 mmHg
*: means an extra error should be added in case of gas interference when CO ₂ measurements are performed between 0 to 40mmHg.		

Microstream CO₂ Module

Standard	Meet the standard of ISO 80601-2-55: 2011
CO ₂ Measurement range	0 to 99 mmHg
Accuracy*	0 to 38 mmHg: ±2 mmHg 39 to 99 mmHg: ±5% of the reading (0.08% increased in error for every 1 mmHg if the reading is more than 38 mmHg)
Accuracy drift	Meet the requirement for measurement accuracy within 6 hours
* Accuracy applies for respiration rate up to 80 rpm. For respiration rate above 80 rpm and EtCO ₂ exceeding 18 mmHg, the accuracy is 4 mmHg or ±12% of the reading, whichever is greater. For respiration rate above 60 rpm, the above accuracy can be achieved by using the FilterLine H Set for Infant/Neonatal (Model: 006324). In the presence of interfering gases, the above accuracy is maintained to within 4%.	

Resolution	1 mmHg
Sample flow rate	50 ⁺¹⁵ _{-7.5} ml/min
Initialization time	30 s (typical) 180 s (maximum)
Response time	4.3 s (with any 2-meter FilterLine) 5.5 s (with any 4-meter FilterLine)
Rise time	190 msec (with any 2-meter FilterLine) 210 msec (with any 4-meter FilterLine)
awRR measurement range	0 to 150 rpm
awRR measurement accuracy	0 to 70 rpm: ±1 rpm 71 to 120 rpm: ±2 rpm 121 to 150 rpm: ±3 rpm
awRR resolution	1 rpm
Data sample rate	40 Hz

A.13.10 AG Specifications

Standard	Meet the standard of ISO 80601-2-55: 2011
Technique	Infrared absorption, paramagnetic properties for O ₂ monitoring
Warm-up time	Iso accuracy mode: 45 s Full accuracy mode: 10 min
Sample flow rate	Adult, Pediatric: 200 ml/min Neonate: 120 ml/min Accuracy: ±10 ml/min or ±10%, whichever is greater
Measurement range	CO ₂ : 0 to 30% O ₂ : 0 to 100% N ₂ O: 0 to 100% Des: 0 to 30% Sev: 0 to 30% Enf: 0 to 30% Iso: 0 to 30% Hal: 0 to 30% awRR: 2 to 100 rpm
Resolution	CO ₂ : 0.1% O ₂ : 1% N ₂ O: 1% Des: 0.1% Sev: 0.1% Enf: 0.1% Iso: 0.1% Hal: 0.1% awRR: 1 rpm
Iso accuracy	As full accuracy specifications, but derated as follows: Add ±0.3% _{ABS} to accuracy for CO ₂ Add ±8% _{REL} to accuracy for all anesthetic gases N ₂ O accuracy is ±(8% _{REL} +2% _{ABS})

Full accuracy	Gases	Range (%REL) ¹	Accuracy (%ABS)
	CO ₂	0 ≤ CO ₂ ≤ 1 1 < CO ₂ ≤ 5 5 < CO ₂ ≤ 7 7 < CO ₂ ≤ 10 CO ₂ > 10	±0.1 ±0.2 ±0.3 ±0.5 Not specified
	N ₂ O	0 - 20 20 - 100 (excluding 20)	±2 ±3
	O ₂	0 - 25 25 - 80 (excluding 25) 80 - 100 (excluding 80)	±1 ±2 ±3
	Des	0 - 1 1 - 5 (excluding 1) 5 - 10 (excluding 5) 10 - 15 (excluding 10) 15 - 18 (excluding 15) >18	±0.15 ±0.2 ±0.4 ±0.6 ±1 Not specified
	Sev	0 - 1 1 - 5 (excluding 1) 5 - 8 (excluding 5) >8	±0.15 ±0.2 ±0.4 Not specified
	Enf, Iso, Hal	0 - 1 1 - 5 (excluding 1) >5	±0.15 ±0.2 Not specified
	awRR	2 to 60 rpm >60 rpm	±1 rpm Not specified
Note ¹ : The highest GAS LEVEL for a single halogenated anaesthetic gas in a gas mixture that is concealed when the anaesthetic concentration falls is 0.15/0.3% (Full/ISO accuracy).			
Accuracy drift	Meet the requirement for measurement accuracy within 6 hours		
Apnea alarm delay	10 s, 15 s, 20 s, 25 s, 30 s, 35 s, 40 s		
Refreshing rate	≤1 s		
Rise time (10% ~ 90%)	Gas sample flow rate 120ml/min, using a DRYLINE II neonatal watertrap and sampling line (2.5m):		
	CO ₂	≤250 ms	
	N ₂ O	≤250 ms	
	Hal, Iso, Sev, Des	≤300 ms	
	Enf	≤350 ms	
	O ₂	≤600 ms	
	Gas sample flow rate 200ml/min, using the adult DRYLINE II water trap and sampling line (2.5m):		
	CO ₂	≤250 ms	
	N ₂ O	≤250 ms	
	O ₂	≤500 ms	
	Hal, Iso, Sev, Des	≤300 ms	
	Enf	≤350 ms	

Response time	Measured with a DRYLINE II neonatal watertrap and a 2.5-meter neonatal sampling line:				
	120 ml/min: CO ₂ : ≤4 s N ₂ O: ≤4.2 s O ₂ : ≤4 s Hal, Iso, Sev, Des, Enf: ≤4.4 s				
	Measured with a DRYLINE II adult watertrap and a 2.5-meter adult sampling line:				
	200 ml/min: CO ₂ : ≤4.2s N ₂ O: ≤4.3s Hal, Iso, Sev, Des, Enf: ≤4.5s O ₂ : ≤4s				
Anesthetic agent limit	Primary anesthetic agent In full accuracy mode: 0.15%,				
	Secondary anesthetic agent: In full accuracy mode: 5% of primary agent if primary agent is greater than 10%, 0.3% if primary agent is less than or equal to 10%.				
Data sample rate	25 Hz				
Inaccuracy specifications are affected by the breath rate and I:E change. The end-tidal gas reading is within specification for breath rate below 15BPM and I:E ratio smaller than 1:1 relative to the gas readings without breath; Add ±6%REL to inaccuracy for HAL and O ₂ for breath rate larger than 15 BPM; Add ±6%REL to inaccuracy for all gases for breath rate larger than 30 BPM (inaccuracy for HAL and O ₂ are unspecified in this case); inaccuracy is unspecified for breath rate larger than 60 BPM.					
Effect of interference gases on AG measurements					
Gas	Concentration (%)	Quantitative effect (%ABS) ³⁾			
		CO ₂	N ₂ O	Agent ¹⁾	O ₂
CO ₂	/	/	0.1	0	0.2
N ₂ O	/	0.1	/	0.1	0.2
Agent ^{1) 2)}	/	0.1	0.1	0.1	1
Xenon	<100%	0.1	0	0	0.5
Helium	<50%	0.1	0	0	0.5
Ethanol	<0.1%	0	0	0	0.5
Acetone	<1%	0.1	0.1	0	0.5
Methane	<1%	0.1	0.1	0	0.5
Saturated Isopropanol vapour	/	0.1	0	0	0.5
Metered dose inhaler propellants,	/	Unspecified	Unspecified	Unspecified	Unspecified
O ₂	/	0.2	0.2	1.0	/
1) Agent represents one of Des, Iso, Enf, Sev, and Hal. 2) Multiple agent interference on CO ₂ , N ₂ O and O ₂ is typically the same as single agent interference. 3) For CO ₂ , N ₂ O and Agents, maximum interference from each gas at concentrations within specified accuracy ranges for each gas. The total interference of all gases is never larger than 5%REL.					
Alarm limit	Range			Step	

EtCO ₂ High	(low limit + 2) to 99 mmHg	1 mmHg
EtCO ₂ Low	1 to (high limit - 2) mmHg	
FiCO ₂ High	1 to 99 mmHg	
EtO ₂ High	(low limit + 2%) to 100%	1%
EtO ₂ Low	0% to (high limit - 2)%	
FiO ₂ High	(low limit + 2%) to 100%	
FiO ₂ Low	18% to (high limit - 2)%	
EtN ₂ O High	(low limit + 2) to 100%	1%
EtN ₂ O Low	0 to (high limit - 2)%	
FiN ₂ O High	(low limit + 2) to 100%	
FiN ₂ O Low	0 to (high limit - 2)%	
EtHal/Enf/Iso High	(low limit + 0.2) to 5.0%	0.1%
EtHal/Enf/Iso Low	0 to (high limit - 0.2)%	
FiHal/Enf/Iso High	(low limit + 0.2) to 5.0%	
FiHal/Enf/Iso Low	0 to (high limit - 0.2)%	
EtSev High	(low limit + 0.2) to 8.0%	0.1%
EtSev Low	0 to (high limit - 0.2)%	
FiSev High	(low limit + 0.2) to 8.0%	
FiSev Low	0 to (high limit - 0.2)%	
EtDes High	(low limit + 0.2) to 18.0%	0.1%
EtDes Low	0 to (high limit - 0.2)%	
FiDes High	(low limit + 0.2) to 18.0%	
FiDes Low	0 to (high limit - 0.2)%	

This page intentionally left blank.

B EMC and Radio Regulatory Compliance

B.1 EMC

The device meets the requirements of IEC 60601-1-2: 2014.

WARNING

- **Use of accessories, transducers and cables other than those specified or provided by the manufacturer of this equipment could result in increased electromagnetic emissions or decreased electromagnetic immunity of this equipment and result in improper operation.**
- **The non-ME EQUIPMENT (e.g. ITE) that is a part of an ME SYSTEM may be disrupted by the electromagnetic interference of nearby equipment. It may be necessary to take mitigation measures, such as re-orienting or relocating the non-ME EQUIPMENT or shielding the location.**
- **Use of this equipment adjacent to or stacked with other equipment should be avoided because it could result in improper operation. If such use is necessary, this equipment and the other equipment should be observed to verify that they are operating normally.**
- **This device is intended for use in professional healthcare facility environment and home healthcare environment. If it is used in special environment, such as magnetic resonance imaging environment, the equipment/system may be disrupted by the operation of nearby equipment.**
- **Portable RF communications equipment (including peripherals such as antenna cables and external antennas) should be used no closer than 30 cm (12 inches) to any part of the this device, including cables specified by the manufacturer. Otherwise, degradation of the performance of this equipment could result.**
- **The equipment/system may be disrupted by the electromagnetic interference of nearby medical equipment, such as CISPR 11 group 2 medical equipment of diathermy, magnetic resonance imaging and microwave therapy. It may be necessary to take mitigation measures, such as re-orienting, relocating or shielding the location.**
- **If the equipment/system is used in RFID environment, such as RFID marking belt, chest card, mobile RFID reader and door control system, it may be disrupted by the operation of nearby RFID equipment. It may be necessary to take mitigation measures, such as re-orienting or relocating the equipment/system away from RFID equipment.**

Guidance and Declaration - Electromagnetic Emissions		
The device is intended for use in the electromagnetic environment specified below. The customer or the user of the device should assure that it is used in such an environment.		
Emission tests	Compliance	Electromagnetic environment - guidance
Conducted and radiated RF EMISSIONS CISPR 11	Group 1	The device is suitable for use in all establishments other than domestic and those directly connected to the public low-voltage power supply network that supplies buildings used for domestic purposes
Conducted and radiated RF EMISSIONS CISPR 11	Class A	
Harmonic distortion EMISSIONS IEC61000-3-2	Class A	
Voltage Fluctuations/Flicker EMISSIONS IEC 61000-3-3	Complies	

If the system is operated within the electromagnetic environment listed in Table Guidance and Declaration - Electromagnetic Immunity, the system will remain safe and provide the following essential performance:

- Operating mode
- Accuracy

- Function
- Accessories identification
- Data stored
- Alarm
- Detect for connection

NOTE

- **If the essential performance is lost or degraded, it may be necessary to take mitigation measures, such as re-orienting or relocating the ME EQUIPMENT or ME SYSTEM or shielding the location or stopping using the monitor and contact the service personnel.**
- **The device needs special precautions regarding EMC and needs to be installed and put into service according to the EMC information provided below.**
- **Other devices may interfere with this device even though they meet the requirements of CISPR.**
- **When the inputted signal is below the minimum amplitude provided in technical specifications, erroneous measurements could result.**
- **The EMISSIONS characteristics of this device make it suitable for use in industrial areas and hospitals (CISPR 11 class A). If it is used in a residential environment (for which CISPR 11 class B is normally required) this device might not offer adequate protection to radio-frequency communication services. The user might need to take mitigation measures, such as relocating or re-orienting the device.**

Guidance and Declaration - Electromagnetic Immunity			
The device is intended for use in the electromagnetic environment specified below. The customer or the user of the device should assure that it is used in such an environment.			
Immunity test	IEC60601 test level	Compliance level	Electromagnetic environment - guidance
Electrostatic discharge (ESD) IEC 61000-4-2	±8 kV contact ±15 kV air	±8 kV contact ±15 kV air	Floors should be wood, concrete or ceramic tile. If floors are covered with synthetic material, the relative humidity should be at least 30%.
Electrical fast transient/burst IEC 61000-4-4	±2 kV for power supply lines ±1 kV for input/output lines	±2 kV for power supply lines ±1 kV for input/output lines	Mains power quality should be that of a typical commercial or hospital environment.
Surge IEC 61000-4-5	±1 kV line(s) to line(s) ±2 kV line(s) to earth	±1 kV line(s) to line(s) ±2 kV line(s) to earth	
Voltage dips and voltage interruptions IEC 61000-4-11	0% U_T for 0.5 cycle: at 0°, 45°, 90°, 135°, 180°, 225°, 270° and 315° 0% U_T for 1 cycle and 70% U_T for 25/30 cycles: at 0° 0% U_T for 250/300 cycle	0% U_T for 0.5 cycle: at 0°, 45°, 90°, 135°, 180°, 225°, 270° and 315° 0% U_T for 1 cycle and 70% U_T for 25/30 cycles: at 0° 0% U_T for 250/300 cycle	Mains power quality should be that of a typical commercial or hospital environment. If the user of our product requires continued operation during power mains interruptions, it is recommended that our product be powered from an uninterruptible power supply or a battery.
RATED power frequency magnetic fields IEC 61000-4-8	30 A/m 50 Hz/60 Hz	30 A/m 50 Hz/60 Hz	Power frequency magnetic fields should be at levels characteristic of a typical location in a typical commercial or hospital environment.
Note: U_T is the AC mains voltage prior to application of the test level.			

Guidance and Declaration - Electromagnetic Immunity

The device is intended for use in the specified electromagnetic environment. The customer or the user of the device should assure that it is used in such an environment as described below.

Immunity test	IEC60601 test level	Compliance level	Electromagnetic environment - guidance
Conducted disturbances induced by RF fields IEC61000-4-6	3 Vrms 150 kHz to 80 MHz 80% AM at 1 kHz	3Vrms	Portable and mobile RF communications equipment should be used no closer to any part of the system, including cables, than the recommended separation distance calculated from the equation appropriate for the frequency of the transmitter. Recommended separation distances: $d = 1.2\sqrt{P}$
	6 Vrms in ISM bands between 0.15 MHz and 80 MHz 80% AM at 1 kHz	6 Vrms	
Radiated RF EM fields IEC61000-4-3	3 V/m 80 MHz to 2,7 GHz 80% AM at 1 kHz	3V/m	Recommended separation distances: 80 MHz to 800 MHz: $d = 1.2\sqrt{P}$ 800MHz - 2.7GHz: $d = 2.3\sqrt{P}$ Where, P is the maximum output power rating of the transmitter in watts (W) according to the transmitter manufacturer and d is the recommended separation distance in meters (m) ^b . Field strengths from fixed RF transmitters, as determined by an electromagnetic site survey ^a should be less than the compliance level in each frequency range ^b . Interference may occur in the vicinity of equipment marked with the following symbol: 
Proximity fields from RF wireless communications equipment IEC61000-4-3	27 V/m 385 MHz	27 V/m	
	28 V/m 810 MHz, 870 MHz, 930 MHz, 1720 MHz, 1845 MHz, 1970 MHz, 2450 MHz (pulse modulation)	28 V/m	
	28V/m 450 MHz (FM modulation)	28 V/m	
	9V /m 710 MHz, 745 MHz, 780 MHz, 5240 MHz, 5500 MHz, 5785 MHz	9 V/m	

Note 1: At 80 MHz to 800 MHz, the separation distance for the higher frequency range applies.

Note 2: These guidelines may not apply in all situations. Electromagnetic propagation is affected by absorption and reflection from structures, objects and people.

^a: Field strengths from fixed transmitters, such as base stations for radio (cellular/cordless) telephones and land mobile radios, amateur radio, AM and FM radio broadcast and TV broadcast cannot be predicted theoretically with accuracy. To assess the electromagnetic environment due to fixed RF transmitters, an electromagnetic site survey should be considered. If the measured field strength in the location in which the **ME EQUIPMENT or ME SYSTEM** is used exceeds the applicable RF compliance level above, the **ME EQUIPMENT or ME SYSTEM** should be observed to verify normal operation. If abnormal performance is observed, additional measures may be necessary, such as re-orienting or relocating the **ME EQUIPMENT or ME SYSTEM**.

^b: Over the frequency range 150 kHz to 80 MHz, field strengths should be less than 3V/m.

WARNING

- **The device is configured with a wireless network connector to receive wireless signal. Other devices may interfere with this device even though they meet the requirements of CISPR.**
-
-

Recommended separation distances between portable and mobile RF communications equipment and the device			
The device is intended for use in an electromagnetic environment in which radiated RF disturbances are controlled. The customer or the user of the device can help prevent electromagnetic interference by maintaining a minimum distance between portable and mobile RF communications equipment (transmitters) and the device as recommended below, according to the maximum output power of the communications equipment.			
Rated maximum output power of transmitter (W)	Separation distance in meters (m) according to frequency of the transmitter		
	150 kHz to 80 MHz $d = 1.2\sqrt{P}$	80 MHz to 800 MHz $d = 1.2\sqrt{P}$	800 MHz to 2.7 GHz $d = 2.3\sqrt{P}$
0.01	0.12	0.12	0.23
0.1	0.38	0.38	0.73
1	1.20	1.20	2.30
10	3.80	3.80	7.30
100	12.00	12.00	23.00
For transmitters rated at a maximum output power not listed above, the recommended separation distance d in metres (m) can be estimated using the equation applicable to the frequency of the transmitter, where P is the maximum output power rating of the transmitter in watts (W) according to the transmitter manufacturer. Note 1: At 80 MHz and 800 MHz, the separation distance for the higher frequency range applies. Note 2: These guidelines may not apply in all situations. Electromagnetic propagation is affected by absorption and reflection from structures, objects and people.			

B.2 Radio Regulatory Compliance

This device complies with Part 15 of the FCC Rules and RSS-210 of Industry Canada. Operation is subject to the following two conditions: (1) this device may not cause harmful interference, and (2) this device must accept any interference received, including interference that may cause undesired operation.

Any changes or modifications to this equipment not expressly approved by Mindray may cause harmful radio frequency interference and void your authority to operate this equipment.

The maximum antenna gain permitted complies with the e.i.r.p. limits as stated in RSS-210.

The maximum antenna gain permitted complies with the e.i.r.p. limits specified for point-to-point operation, as stated in RSS-210.

WARNING

- **Changes or modifications not expressly approved by the party responsible compliance could void the user's authority to operate the equipment.**
-
-

C Default Settings

C.1 ECG, Arrhythmia, ST and QT Default Settings

C.1.1 ECG Default Settings

Item		Default Setting
HR/PR	Alarm switch	On
	High limit	Adult: 120 bpm Pediatric: 160 bpm Neonate: 200 bpm
	Low limit	Adult: 50 bpm Pediatric: 75 bpm Neonate: 100 bpm
	Priority	Med
	Alarm Outputs	Off
Alarm Source		Auto
ECG1		II
ECG2 (5-lead)		V
ECG Gain		×1
Speed		25 mm/sec
Filter		OR: Surgery CCU: Diagnostic Other departments: Monitor
Notch Filter		On
Lead Set		Auto
Smart Lead		On
QRS Volume		General, OR: 2 Other department: 0
QRS Threshold		0.16 mV
Paced		Adult: Unspecified Pediatric/Neonate: No
Pacer Reject		Off

C.1.2 Arrhythmia Default Settings

C.1.2.1 Arrhythmia Alarm Default Settings

Item	Alarm Switch	Priority	Alarm Outputs
Asystole	On	High, unadjustable	Off
V-Fib/V-Tach	On	High, unadjustable	Off
V-Tach	On	High, unadjustable	Off
Vent Brady	On	High, unadjustable	Off
Extreme Tachy	On	High, unadjustable	Off
Extreme Brady	On	High, unadjustable	Off
R on T	CCU: On Other departments: Off	Med	Off
Run PVCs	Off	Low	Off
Couplet	Off	Prompt	Off
Multiform PVC	Off	Med	Off
PVC	Off	Prompt	Off
Bigeminy	CCU: On Other departments: Off	Med	Off
Trigeminy	CCU: On Other departments: Off	Med	Off
Tachy	Off	Med	Off
Brady	Off	Med	Off
Pacer Not Capture	Off	Prompt	Off
Pacer Not Pacing	Off	Prompt	Off
Missed Beat	Off	Prompt	Off
Nonsus V-Tach	CCU: On Other departments: Off	Med	Off
Vent Rhythm	CCU: On Other departments: Off	Med	Off
Pause	Off	Low	Off
Irr Rhythm	Off	Prompt	Off
A-Fib	Off	Prompt	Off
PVCs/min	CCU: On Other departments: Off	Med	Off
Pauses/min	CCU: On Other departments: Off	Med	Off

C.1.2.2 Arrhythmia Threshold Default Settings

Item	Adult	Pediatric	Neonate
Asystole Delay	5 sec	5 sec	3 sec
Tachy	120 bpm	160 bpm	200 bpm
Brady	50 bpm	75 bpm	100 bpm
Extreme Tachy	160 bpm	180 bpm	220 bpm
Extreme Brady	35 bpm	50 bpm	80 bpm
Multif PVCs Window	15 beats	15 beats	15 beats
PVCs/min	10	10	5
Pause/min	8	8	8
Pause Threshold	2.0 sec	2.0 sec	1.5 sec
AF/Irr Rhy End Time	2 min	2 min	2 min
V-Tach Rate	130 bpm	130 bpm	150 bpm
V Brady Rate	40 bpm	40 bpm	60 bpm
V-Tach PVCs	6	6	5
V-Brady PVCs	5	5	3

C.1.3 ST Default Settings

Item	Default Setting	
ST Alarm Mode	Absolute	
ST Alarm Mode set to Absolute ST-I, ST-II, ST-III, ST-aVR, ST-aVL, ST-aVF, ST-V1, ST-V2, ST-V3, ST-V4, ST-V5, ST-V6, ST-Va, ST-Vb	Alarm switch	Off
	High limit	0.2 mV
	Low limit	-0.2 mV
	Priority	Med
	Alarm Outputs	Off
ST Alarm Mode set to Relative ST Single, ST Dual	Alarm switch	Off
	High limit	0.1 mV
	Low limit	-0.1 mV
	Priority	Med
	Alarm Outputs	Off
ST Analysis	Off	
ST Segment	Auto	
Show Markers	Off	
ST Point	J+60 ms	
Auto Adjust	On	
J	48	
ISO	-80	

C.1.4 QT Default Settings

Item		Default Setting
QTc	Alarm switch	Off
	High limit	Adult: 500 Pediatric: 480 Neonate: 460
	Priority	Med
	Alarm Outputs	Off
ΔQTc	Alarm switch	Off
	High limit	60
	Priority	Med
	Alarm Outputs	Off
QT Analysis		Off
QT Leads		All

C.2 Respiration Default Settings

Item		Default Setting
RR	Alarm switch	On
	High limit	Adult: 30 Pediatric: 30 Neonate: 100
	Low limit	Adult: 8 Pediatric: 8 Neonate: 30
	Priority	Med
	Alarm Outputs	Off
Apnea	Alarm switch	On
	Priority	High, unadjustable
	Alarm Outputs	Off
Apnea Delay		Adult: 20 sec Pediatric: 20 sec Neonate: 15 sec
RR Source		Auto
Resp Lead		Adult: Auto Pediatric: Auto Neonate: II
Gain		×2
Speed		6.25 mm/s
Auto Threshold Detection		On

C.3 SpO₂ Default Settings

Item		Default Setting
SpO ₂	Alarm switch	On
	High limit	Adult: 100% Pediatric: 100% Neonate: 95%
	Low limit	90%
	Priority	Med
	Alarm Outputs	Off
SpO ₂ Desat	Alarm switch	On
	Low limit	80%
	Priority	High
	Alarm Outputs	Off
Sat-Second (for Nellcor SpO ₂)		Off
NIBP Simul		Off
FastSAT (for Masimo SpO ₂)		Off
Display SIQ (for Masimo SpO ₂)		Off
Sensitivity (for Masimo SpO ₂)		APOD
Averaging (for Masimo SpO ₂)		8s
Display PI (for MasimoSpO ₂)		Off
Speed		25 mm/s
PR	Alarm switch	On
	High limit	Adult: 120 Pediatric: 160 Neonate: 200
	Low limit	Adult: 50 Pediatric: 75 Neonate: 100
	Priority	Med
	Alarm Outputs	Off
	Alarm Source	Auto
	PR Source	Auto
	QRS Volume	General, OR: 2 Other departments: 0
	Display PR	Off

C.4 Temperature Default Settings

Item		Default Setting
TXX (XX refers to temperature site)	Alarm switch	On
	High limit	38.0 °C
	Low limit	35.0 °C
	Priority	Med
	Alarm Outputs	Off
ΔT	Alarm switch	On
	High limit	2.0 °C
	Priority	Med
	Alarm Outputs	Off

C.5 NIBP Default Settings

Item		Default Setting
NIBP-S	Alarm switch	On
	High limit	Adult: 160 mmHg Pediatric: 120 mmHg Neonate: 90 mmHg
	Low limit	Adult: 90 mmHg Pediatric: 70 mmHg Neonate: 40 mmHg
	Priority	Med
	Alarm Outputs	Off
NIBP-D	Alarm switch	On
	High limit	Adult: 90 mmHg Pediatric: 70 mmHg Neonate: 60 mmHg
	Low limit	Adult: 50 mmHg Pediatric: 40 mmHg Neonate: 20 mmHg
	Priority	Med
	Alarm Outputs	Off
NIBP-M	Alarm switch	On
	High limit	Adult: 110 mmHg Pediatric: 90 mmHg Neonate: 70 mmHg
	Low limit	Adult: 60 mmHg Pediatric: 50 mmHg Neonate: 25 mmHg
	Priority	Med
	Alarm Outputs	Off

Item		Default Setting
NIBP-S Extreme	Alarm switch	On
	High limit	Adult: 175 mmHg Pediatric: 130 mmHg Neonate: 95 mmHg
	Low limit	Adult: 75 mmHg Pediatric: 60 mmHg Neonate: 35 mmHg
	Priority	High
	Alarm Outputs	Off
NIBP-D Extreme	Alarm switch	On
	High limit	Adult: 105 mmHg Pediatric: 80 mmHg Neonate: 65 mmHg
	Low limit	Adult: 35 mmHg Pediatric: 30 mmHg Neonate: 15 mmHg
	Priority	High
	Alarm Outputs	Off
NIBP-M Extreme	Alarm switch	On
	High limit	Adult: 125 mmHg Pediatric: 100 mmHg Neonate: 75 mmHg
	Low limit	Adult: 45 mmHg Pediatric: 40 mmHg Neonate: 20 mmHg
	Priority	High
	Alarm Outputs	Off
Initial Pressure	Adult: 160 mmHg Pediatric: 140 mmHg Neonate: 90 mmHg	
Interval	OR: 5 min NICU: 30 min Other departments: 15 min	
Start Mode	Clock	
NIBP End Tone	Off	
Venipuncture Pressure	Auto	
Display Format	Sys/Dia (Mean)	
Display Alarm Limits	Off	
Display PR	Off	

C.6 IBP Default Settings

Item		Default Setting
IBP-S	Alarm switch	On
	High limit	<ul style="list-style-type: none"> ■ Art/Ao/UAP/BAP/FAP/LV/P1/P2 arterial pressure Adult: 160 mmHg Pediatric: 120 mmHg Neonate: 90 mmHg ■ PA Adult: 35 mmHg Pediatric, Neonate: 60 mmHg
	Low limit	<ul style="list-style-type: none"> ■ Art/Ao/UAP/BAP/FAP/LV/P1/P2 arterial pressure Adult: 90 mmHg Pediatric: 70 mmHg Neonate: 55 mmHg ■ PA Adult: 10 mmHg Pediatric, Neonate: 24 mmHg
	Priority	Med
	Alarm Outputs	Off
IBP-D	Alarm switch	On
	High limit	<ul style="list-style-type: none"> ■ Art/Ao/UAP/BAP/FAP/LV/P1/P2 arterial pressure Adult: 90 mmHg Pediatric: 70 mmHg Neonate: 60 mmHg ■ PA Adult: 16 mmHg Pediatric, Neonate: 4 mmHg
	Low limit	<ul style="list-style-type: none"> ■ Art/Ao/UAP/BAP/FAP/LV/P1/P2 arterial pressure Adult: 50 mmHg Pediatric: 40 mmHg Neonate: 20 mmHg ■ PA Adult: 0 mmHg Pediatric, Neonate: -4 mmHg
	Priority	Med
	Alarm Outputs	Off

Item		Default Setting
IBP-M	Alarm switch	On
	High limit	<ul style="list-style-type: none"> ■ Art/Ao/UAP/BAP/FAP/LV/P1/P2 arterial pressure Adult: 110 mmHg Pediatric: 90 mmHg Neonate: 70 mmHg ■ PA Adult: 20 mmHg Pediatric, Neonate: 26 mmHg ■ ICP/RAP/LAP/UVP/P3-P4 venous pressure Adult: 10 mmHg Pediatric, Neonate: 4 mmHg ■ CVP Adult: 14 cmH₂O Pediatric, Neonate: 5 cmH₂O
	Low limit	<ul style="list-style-type: none"> ■ Art/Ao/UAP/BAP/FAP/LV/P1/P2 arterial pressure Adult: 70 mmHg Pediatric: 50 mmHg Neonate: 35 mmHg ■ PA Adult: 0 mmHg Pediatric, Neonate: 12 mmHg ■ ICP/RAP/LAP/UVP/P3/P4 venous pressure Adult: 0 mmHg Pediatric, Neonate: 0 mmHg ■ CVP Adult: 0 cmH₂O Pediatric, Neonate: 0 cmH₂O
	Priority	Med
	Alarm Outputs	Off
	Art-S Extreme	Alarm switch
Art-S Extreme	High limit	Adult: 175 mmHg Pediatric: 130 mmHg Neonate: 95 mmHg
	Low limit	Adult: 75 mmHg Pediatric: 60 mmHg Neonate: 50 mmHg
	Priority	High
	Alarm Outputs	Off
	Art-D Extreme	Alarm switch
Art-D Extreme	High limit	Adult: 105 mmHg Pediatric: 80 mmHg Neonate: 65 mmHg
	Low limit	Adult: 35mmHg Pediatric: 30 mmHg Neonate: 15 mmHg
	Priority	High
	Alarm Outputs	Off

Item		Default Setting
Art-M Extreme	Alarm switch	Off
	High limit	Adult: 125 mmHg Pediatric: 100 mmHg Neonate: 75 mmHg
	Low limit	Adult: 55 mmHg Pediatric: 40 mmHg Neonate: 30 mmHg
	Priority	High
	Alarm Outputs	Off
CPP	Alarm switch	On
	High limit	Adult: 130 mmHg Pediatric: 100 mmHg Neonate: 90 mmHg
	Low limit	Adult: 50 mmHg Pediatric: 40 mmHg Neonate: 30 mmHg
	Priority	Med
	Alarm Outputs	Off
Measure (for P1, P2)		All
Measure (for P3, P4)		Mean Only
Sensitivity		Med
Speed		25 mm/sec
Scale	ICP/RAP/LAP/UVP venous pressure	0-20 mmHg
	Art/Ao/BAP/FAP/LV/P1/P2 arterial pressure	0-160 mmHg
	UAP/P3/P4 venous pressure	0-80 mmHg
	PA/CVP	PA: 0-30 mmHg CVP: 0-30 cmH ₂ O
PPV Measure		Off
PPV Source		Auto
PAWP	Reference Waveform 1	II
	Reference Waveform 2	Resp
	Speed	12.5 mm/sec
	PA Scale (mmHg)	0-30
Overlapping Waveform Setup	Left Scale (mmHg)	0-160
	Right Scale (mmHg)	0-20
	CVP Scale (cmH ₂ O)	0-30
	ICP Scale (mmHg)	0-20
	PA Scale (mmHg)	0-30
	Speed	25 mm/sec
	Gridlines	Off

Item	Default Setting
Display Format	Sys/Dia (Mean)
Display Alarm Limit	Off
Use PA-D as PAWP	Off

C.7 C.O. Default Settings

Item	Default Setting	
TB	Alarm switch	On
	High limit	39.0 °C
	Low limit	36.0 °C
	Priority	Med
	Alarm Outputs	Off
Comp Const	0.542	
Auto Start	On	
Auto TI	On	

C.8 CO₂ Default Settings

C.8.1 General Settings

Item	Default Setting	
EtCO ₂	Alarm switch	On
	High limit	Adult, Pediatric: 50 mmHg Neonate: 45 mmHg
	Low limit	Adult, Pediatric: 25mmHg Neonate: 30mmHg
	Priority	Med
	Alarm Outputs	Off
FiCO ₂	Alarm switch	On
	High limit	4 mmHg
	Priority	Med
	Alarm Outputs	Off
Apnea Delay	Adult, Pediatric: 20 s Neonate: 15 s	
RR Source	Auto	
Speed	6.25 mm/s	
Scale	50 mmHg	
Waveform Type	Draw	

C.8.2 Sidestream CO₂ Default Settings

Item	Default Setting
BTPS Compensation	Off
AG Compensation	0%
N ₂ O Compensation	0%
Auto Standby	60 min
Operating Mode	Measure

C.8.3 Microstream CO₂ Default Settings

Item	Default Setting
BTPS Compensation	Off
Maximum Hold	20 sec
Auto Standby	Off
Operating Mode	Measure

C.9 Gas Default Settings

Item	Default Setting	
EtCO ₂	Alarm switch	On
	High limit	Adult, Pediatric: 50 mmHg Neonate: 45 mmHg
	Low limit	Adult, Pediatric: 25mmHg Neonate: 30mmHg
	Priority	Med
	Alarm Outputs	Off
FiCO ₂	Alarm switch	On
	High limit	4 mmHg
	Priority	Med
	Alarm Outputs	Off
EtO ₂	Alarm switch	On
	High limit	88%
	Low limit	18%
	Priority	Med
	Alarm Outputs	Off
FiO ₂	Alarm switch	On
	High limit	Adult, Pediatric: 100% Neonate: 90%
	Low limit	18%
	Priority	Med
	Alarm Outputs	Off

Item		Default Setting
EtN ₂ O	Alarm switch	On
	High limit	55%
	Low limit	0%
	Priority	Med
	Alarm Outputs	Off
FiN ₂ O	Alarm switch	On
	High limit	53%
	Low limit	0%
	Priority	Med
	Alarm Outputs	Off
EtAA/FiAA	Alarm switch	On
	High limit	30%
	Low limit	0.0%
	Priority	Med
	Alarm Outputs	Off
EtHal/EtEnf/EtIso	Alarm switch	On
	High limit	3.0%
	Low limit	0.0%
	Priority	Med
	Alarm Outputs	Off
FiHal/FiEnf/FiIso	Alarm switch	On
	High limit	2.0%
	Low limit	0.0%
	Priority	Med
	Alarm Outputs	Off
EtSev	Alarm switch	On
	High limit	6.0%
	Low limit	0.0%
	Priority	Med
	Alarm Outputs	Off
FiSev	Alarm switch	On
	High limit	5.0%
	Low limit	0.0%
	Priority	Med
	Alarm Outputs	Off

Item		Default Setting
EtDes	Alarm switch	On
	High limit	8.0%
	Low limit	0.0%
	Priority	Med
	Alarm Outputs	Off
FiDes	Alarm switch	On
	High limit	6.0%
	Low limit	0.0%
	Priority	Med
	Alarm Outputs	Off
Apnea Delay		Adult, Pediatric: 20 sec Neonate: 15 sec
RR Source		Auto
Operating Mode		Measure
Auto Standby		Off
Speed		6.25 mm/sec
Scale		O ₂ : 400 mmHg CO ₂ : 50 mmHg N ₂ O: 50% Hal, Enf, and Iso: 2.5% Sev: 4.0% AA and Des: 9.0%
Waveform Type		Draw (for CO ₂ only)
O ₂ compensation		OR: 100% Other departments: Off

C.10 Alarm Default Settings

Item	Default Setting
Alarm Volume	2
High Alarm Volume	Alarm Volume + 3
Reminder Volume	2
Apnea Delay	Adult: 20 sec Pediatric: 20 sec Neonate: 15 sec
Printing Duration On Alarm	20 sec
Auto Limits for New Patient	On

C.11 Display Default Settings

Item		Default Setting
Primary Screen	Choose Screen	Normal Screen
Display	Screen Lock Duration	General, CCU: Permanent Other departments: 10s
	Brightness	5
	Brightness On Battery	1
Night Mode	Brightness	1
	Alarm Volume	2
	QRS Volume	1
	Key Volume	0
	NIBP End Tone	Off
	Stop NIBP	Off

This page intentionally left blank.

D Alarm Messages

This chapter lists only the physiological and technical alarm messages. Some messages appearing on your monitor may not be included. In the “Cause and solution” column, corresponding solutions are given instructing you to troubleshoot problems. If the problem persists, contact your service personnel.

NOTE

- **The gas analyzer is not an apnea monitor. The safety and effectiveness of the respiration measurement method in the detection of apnea, particularly the apnea of prematurity and apnea of infancy, has not been established.**

D.1 Physiological Alarm Messages

D.1.1 General Physiological Alarm Messages

Alarm messages	Default priority	Cause and solution
XX High	Med	XX value has risen above the high alarm limit or fallen below the low alarm limit. Check the patient’s condition and check if the patient category and alarm limit settings are correct.
XX Low	Med	

Note: XX represents a measurement or parameter label, such as HR, NIBP, PVCs, RR, SpO2, PR, and so on.

D.1.2 Arrhythmia Alarm Messages

Alarm message	Default priority
Asystole	High
V-Fib/V-Tach	High
V-Tach	High
Vent Brady	High
Extreme Tachy	High
Extreme Brady	High
R on T	Med
Run PVCs	Low
Couplet	Prompt
Multiform PVC	Med
PVC	Prompt
Bigeminy	Med
Trigeminy	Med
Tachy	Med
Brady	Med
Pacer Not Pacing	Prompt
Pacer Not Capture	Prompt
Missed Beats	Prompt

Alarm message	Default priority
Nonsus V-Tach	Med
Vent Rhythm	Med
Pause	Low
Irr Rhythm	Prompt
PVCs/min	Med
Pauses/min	Med
A-Fib	Prompt

Note: When arrhythmia alarms occur, check the patient's condition and the ECG connections.

D.1.3 ST Physiological Alarm Messages

ST alarm mode	Alarm messages	Default priority	Cause and solution
Absolute	ST-XX High	Med	The ST value of the respective ECG lead has risen above the high alarm limit or fallen below the low alarm limit. Check the patient's condition and check if the patient category and alarm limit settings are correct.
	ST-XX Low	Med	
Relative	ST Single	Med	The ST value of any ECG lead has risen above the high alarm limit or fallen below the low alarm limit. Check the patient's condition and check if the patient category and alarm limit settings are correct.
	ST Dual	Med	The ST values of two or more ECG leads have risen above the high alarm limit or fallen below the low alarm limit. Check the patient's condition and check if the patient category and alarm limit settings are correct.

Note: XX represents the ECG lead label.

D.1.4 Resp Physiological Alarm Messages

Alarm message	Default priority	Cause and solution
Resp Artifact	High	The patient's heartbeat has interfered with the impedance respiration. Check the patient's condition and the Resp connections.
Apnea	High	The respiration signal is so weak that the monitor cannot perform respiration analysis. Check the patient's condition, module and patient connections.

D.1.5 SpO₂ Physiological Alarm Messages

Alarm message	Default priority	Cause and solution
SpO ₂ Low (YY hrs YY min YYsec)	High	The SpO ₂ value falls below the alarm limit. Check the patient's condition and check if the alarm limit settings are correct.
SpO ₂ Desat (YY hrs YY min YYsec)	High	The SpO ₂ value falls below the desaturation alarm limit. Check the patient's condition and check if the alarm limit settings are correct.

Note: YY hrs YY min YY sec represents the period of time that the SpO₂ alarm lasts.

D.1.6 PR Physiological Alarm Messages

Alarm message	Default priority	Cause and solution
No Pulse	High	The pulse signal was so weak that the monitor cannot perform pulse analysis. Check the patient's condition, the source of PR, such as IBP or SpO2 sensor, and measurement site.

D.1.7 NIBP Physiological Alarm Messages

Alarm message	Default priority	Cause and solution
NIBP-S Extremely High/ NIBP-D Extremely High/ NIBP-M Extremely High	High	The NIBP value is higher than the NIBP Extreme alarm high limit. Check the patient's condition and check if the alarm limit settings are correct.
NIBP-S Extremely Low/ NIBP-D Extremely Low/ NIBP-M Extremely Low	High	The NIBP value is lower than the NIBP Extreme alarm low limit. Check the patient's condition and check if the alarm limit settings are correct.

D.1.8 IBP Physiological Alarm Messages

Alarm message	Default priority	Cause and solution
Art-S Extremely High/ Art-D Extremely High/ Art-M Extremely High	High	The Art value is higher than the Art Extreme alarm high limit. Check the patient's condition and check if the alarm limit settings are correct.
Art-S Extremely Low/ Art-D Extremely Low/ Art-M Extremely Low	High	The Art value is lower than the Art Extreme alarm low limit. Check the patient's condition and check if the alarm limit settings are correct.

D.1.9 AG Physiological Alarm Messages

Alarm message	Default priority	Cause and solution
Mixed Agent and MAC \geq 3	Med	The mixed anaesthetic gases concentration is too high. Verify the MAC parameters are correct and adjust the anaesthetic gases concentration.
Apnea	High	The respiration signal was so weak that the monitor cannot perform respiration analysis. Check the patient's condition, module and patient connections.

D.2 Technical Alarm Messages

This section lists technical alarms, their default priority, responses on alarm reset, and the actions that can be taken when an alarm occurs. Some of alarms may not be included.

Various technical alarms respond differently when the alarm system is reset. For easy clarification, in this section the technical alarms are classified into three categories of response when the alarm system is reset:

- A: technical alarms are cleared. The monitor gives no alarm indications.
- B: technical alarms are changed to the prompt messages.
- C: the alarm is silenced and a check mark  appears before the alarm message.

In the following tables we will use A, B, and C are used to refer to the responses on alarm reset.

D.2.1 General Technical Alarm Messages

Alarm message	Default priority	Indication on alarm reset	Cause and solution
XX Module Error	High	C	XX module does not work properly. Replug the module, if the alarm persists, contact your service personnel.

Note: XX represents a measurement or parameter label, such as HR, RR, SpO₂, EtCO₂, and so on.

D.2.2 ECG Technical Alarm Messages

Alarm message	Default priority	Indication on alarm reset	Cause and solution
ECG Noisy	Low/Prompt	A	The ECG signal is noisy. Check for any possible sources of signal noise around the cable and electrode, and check the patient for excessive motion.
ECG Amplitude Too Small	Low	C	The ECG amplitude does not reach the detected threshold. Check for any possible source of interference around the cable and electrode.
ECG XX Lead Off	Low	B	The electrode has become detached from the patient or the lead wire has become disconnected from the adapter cable. Check the connections of the electrodes and leadwires.
ECG Lead Off (YY hrs YY min YYsec)	Low	B	The electrode has become detached from the patient or the lead wire has become disconnected from the adapter cable. Check the connections of the electrodes and leadwires.
ECG Signal Invalid	Low	A	Patient skin impedance is too high. Check ECG electrode application.
ECG Learning	Prompt	/	ECG learning is manually or automatically triggered.
Cannot Analyze QT	Prompt	/	/

Note: The alarm priority of ECG XX Lead Off depends on whether HR value is available. If HR value is available, the priority of ECG XX Lead Off is "Low". If HR value is not available, the priority of ECG XX Lead Off is defined by the setting of ECG Lead Off from the Maintenance menu. For more information, see 24.3.7.1 *Setting the Priority of the ECG Lead Off Alarm*.

Note: XX represents ECG lead name, for example LL, V, Va, Vb, and so on.

Note: YY hrs YY min YY sec represents the period of time that the ECG Lead Off alarm lasts.

D.2.3 Resp Technical Alarm Messages

Alarm message	Default priority	Indication on alarm reset	Cause and solution
Resp Interference	Prompt	/	The respiration circuit is disturbed. Check for any possible sources of signal noise.
Electrode Poor Contact	Prompt	/	Check the electrode application. Reposition or replace the electrodes if necessary.

D.2.4 SpO₂ Technical Alarm Messages

Alarm message	Default priority	Indication on alarm reset	Cause and solution
SpO ₂ Sensor Off	Adjustable	B	The SpO ₂ sensor has become detached from the patient or the module. Check the sensor connection. If the alarm persists, replace the sensor.
SpO ₂ No Sensor	Low	A	The SpO ₂ extension cable is detached from the SpO ₂ module, or the SpO ₂ sensor is detached from the SpO ₂ extension cable. Check the SpO ₂ cable and the sensor connection. If the alarm persists, replace the sensor.
SpO ₂ Excess Light	Low	C	Ambient light is too strong. Move the sensor to a place with lower level of ambient light or cover the sensor to minimize the ambient light.
SpO ₂ No Pulse	Low	C	The SpO ₂ sensor failed to obtain pulse signal. Check the patient's condition and replace the sensor application site. If the alarm persists, replace the sensor.
SpO ₂ Sensor Incompatible	Low	C	Incompatible or an unspecified SpO ₂ sensor is used. Use specified sensors.
SpO ₂ Low Signal Quality	Low	C	<ol style="list-style-type: none"> 1. Check the sensor and sensor position. 2. Make sure the patient is not shivering or moving. 3. The patient's pulse may be too low to be measured.
SpO ₂ Interference	Low	C	The SpO ₂ signal has been interfered. Check for any possible sources of signal noise and check the patient for excessive motion.
SpO ₂ Sensor Error	Low	C	Replace the sensor and measure again.
SpO ₂ Searching Pulse	Prompt	/	SpO ₂ is searching for pulse.
SpO ₂ Low Perfusion	Prompt	/	<p>The SpO₂ sensor is not properly placed or the patient's perfusion index is too low.</p> <ol style="list-style-type: none"> 1. Check the sensor and sensor position. 2. Reposition the sensor if necessary.

D.2.5 Temp Technical Alarm Messages

Alarm message	Default priority	Indication on alarm reset	Cause and solution
T XX Sensor Off	Low	A	Check the sensor connection and reconnect the sensor.

Note: XX represents a temperature site, for example skin, core, axil, T1, and so on.

D.2.6 NIBP Technical Alarm Messages

Alarm message	Default priority	Indication on alarm reset	Cause and solution
NIBP Cuff Loose	Low	A	There is a leak in the cuff or air tubing. Use a cuff of correct type based on the patient size. Apply the cuff and connect the air tubing as instructed in the manual.

Alarm message	Default priority	Indication on alarm reset	Cause and solution
NIBP Cuff or Airway Leak	Low	A	Check the NIBP cuff and pump for leakages.
NIBP Airway Error	Low	A	The air tubing may be occluded. Check the air tubing for an occlusion or kinking. If the alarm persists, contact your service personnel.
NIBP Weak Signal	Low	A	The patient's pulse is weak or the cuff is loose. Check the patient's condition and replace the cuff application site.
NIBP Overrange	Low	A	The measured NIBP value exceeds the module measurement range. Check the patient's condition.
NIBP Excessive Motion	Low	A	Check the patient's condition and reduce patient motion.
NIBP Cuff Overpressure	Low	A	The NIBP airway may be occluded. Check the airway and measure again. If the alarm persists, contact your service personnel.
NIBP Timeout	Low	A	The measurement time exceeds 120 seconds in the adult or pediatric mode, or exceeds 90 seconds in the neonatal mode, and the BP value cannot be obtained. Check the patient's condition and NIBP connections, or replace the cuff and measure again.
NIBP Cuff and Patient Mismatch	Low	A	The cuff type mismatches the patient category. Verify the patient category or replace the cuff if necessary. If patient category is correct, check that the tubing is not bent and the airway is not occluded.
NIBP Airway Leak	Low	A	Airway leakage is found during the NIBP leakage test. Check the NIBP cuff and pump for leakages.

D.2.7 IBP Technical Alarm Messages

Alarm message	Default priority	Indication on alarm reset	Cause and solution
XX Sensor Error	Med	C	The IBP sensor fails. Replace the sensor.
XX No Sensor	Med	A	The IBP patient cable and/or corresponding IBP sensor is not connected or detached. Check the cable and sensor connection.
XX No Pulse	Low	A	The catheter may be occluded. Please flush the catheter.
XX Disconnected	High	C	The tubing is disconnected from the patient, or the three-way valve is open to the air. Check the connection of the tubing, or check the valve is open to the patient. If the alarm persists, contact your service personnel.

Note: XX represents an IBP label, for example PA, CVP, FAP, P1, and so on.

D.2.8 C.O. Technical Alarm Messages

Alarm message	Default priority	Indication on alarm reset	Cause and solution
TB Sensor Off	Low	A	Check the sensor connection and reconnect the sensor.

Alarm message	Default priority	Indication on alarm reset	Cause and solution
TI Sensor Off	Low	A	Check the sensor connection and reconnect the sensor.

D.2.9 CO₂ Technical Alarm Messages

Alarm message	Default priority	Indication on alarm reset	Cause and solution
CO2 Module High Temp	Low	C	Ambient temperature is too high or there is a module failure. <ol style="list-style-type: none"> 1. Lower the operating temperature. 2. Replug the module. 3. If the alarm persists, the CO₂ module may fail, contact your service personnel.
CO2 Module Low Temp	Low	C	Ambient temperature is too low or there is a module failure. <ol style="list-style-type: none"> 1. Raise the operating temperature. 2. Replug the module. 3. If the alarm persists, the CO₂ module may fail, contact your service personnel.
CO2 Zero Failed	Low	C	Replug the module. If the alarm persists, contact your service personnel.
CO2 No Watertrap	Low	B	Check the watertrap connections.
CO2 High Airway Pressure	Low	C	<ol style="list-style-type: none"> 1. Check the airway pressure settings of the ventilator/anesthesia machine. 2. Disconnect the module from the ventilator/anesthesia machine. 3. Replug the module. 4. If the alarm persists, contact your service personnel.
CO2 Low Airway Pressure	Low	C	<ol style="list-style-type: none"> 1. Check the airway pressure settings of the ventilator/anesthesia machine. 2. Disconnect the module from the ventilator/anesthesia machine. 3. Replug the module. 4. If the alarm persists, contact your service personnel.
High Barometric	Low	C	The ambient pressure exceeds the operating pressure range or CO ₂ module fails. <ol style="list-style-type: none"> 1. Make sure that the ambient pressure meets the specifications, and check for sources that affect the ambient pressure. 2. Replug the module. 3. If the alarm persists, contact your service personnel.
Low Barometric	Low	C	The ambient pressure exceeds the operating pressure range or CO ₂ module fails. <ol style="list-style-type: none"> 1. Make sure that the ambient pressure meets the specifications, and check for sources that affect the ambient pressure. 2. Replug the module. 3. If the alarm persists, contact your service personnel.

Alarm message	Default priority	Indication on alarm reset	Cause and solution
CO2 Airway Occluded	Low	C	<ol style="list-style-type: none"> 1. Check if the sample line is kinked or occluded. 2. Replace the sample line. 3. Replug the module. 4. If the alarm persists, contact your service personnel.
CO2 No Filterline	Low	A	Make sure that the filterline is connected.
CO2 Calibration Required	Low	C	Perform a calibration.
CO2 Airway Error	Low	C	<ol style="list-style-type: none"> 1. Check if the sample line is kinked or occluded. 2. Replace the sample line. 3. Replug the module. 4. If the alarm persists, contact your service personnel.
CO2 Adapter Error	Low	A	Check, clean or replace the airway adapter. Perform a zero calibration.
CO2 No Sensor	Low	A	Make sure that the CO ₂ transducer is connected.
CO2: Change Watertrap	Low	C	Replace the watertrap.
CO2 Watertrap and Patient Mismatch	Low	C	Check the patient category and use a correct watertrap.

D.2.10 AG Technical Alarm Messages

Alarm message	Default priority	Indication on alarm reset	Cause and solution
AG No Watertrap	Low	B	Check the connections of the watertrap and re-connect it.
AG: Change Watertrap	Low	C	Replace the watertrap.
AG Watertrap and Patient Mismatch	Low	C	Check the patient category and use a correct watertrap.
AG Zero Failed	Low	C	<p>There is external electromagnetic interference, airway occlusion or module failure.</p> <ol style="list-style-type: none"> 1. Check for external inference sources. 2. Check for "AG Airway Occluded" alarm message. Remove the occlusion. 3. If the alarm persists, contact your service personnel.
Anesthetic Mixture	Low	C	Anesthetic mixture is detected.
AG Airway Occluded	Low	C	<ol style="list-style-type: none"> 1. Check if the sample line is occluded. 2. Replace the sample line. 3. Replug the module. 4. If the alarm persists, contact your service personnel.

D.2.11 EWS Technical Alarms

Alarm message	Default priority	Indication on alarm reset	Cause and solution
EWS param XX is timeout	Low	A	The manually input parameter is timeout. Input a parameter numeric again.

Alarm message	Default priority	Indication on alarm reset	Cause and solution
EWS score needs to be confirmed	Low	A	Confirm to save or give up current score.

XX represents RR, SpO₂, Supp. O₂, Temp, BP, HR, Consciousness, Blood Sugar, Urine Output, Catheter, Pain Score, Pain, EtCO₂, FiO₂, Airway, or Customer defined parameter.

D.2.12 Power Supply Technical Alarm Messages

Alarm message	Default priority	Indication on alarm reset	Cause and solution
Low Battery	Med	C	Connect the monitor to the external power supply and allow the batteries to charge.
Critically Low Battery	High	C	Connect the monitor to the external power supply and allow the batteries to charge.
Power Board Comm Error	High	C	Restart the monitor. If the alarm persists, contact your service personnel.
Battery Error	High	C	The battery may fail. Contact your service personnel.
RT Clock Need Reset	High	C	Contact your service personnel.
RT Clock Not Exist	High	C	Contact your service personnel.
XX V Too High	High	C	There is a problem with the system power supply. Restart the monitor.
XX V Too Low	High	C	

Note: XX represents 2.5 V, 3.3 V, 5 V, or 12 V.

D.2.13 Recorder Technical Alarm Messages

Alarm message	Default priority	Indication on alarm reset	Cause and solution
Recorder Init Error	Low	A	An error occurred during the recorder initialization. If the alarm persists, contact your service personnel.
Recorder Comm Error	Low	A	Restart the monitor if not solved. If the alarm persists, contact your service personnel.
Recorder Head Hot: Please Wait	Low	C	The recorder has been working for too long time. Stop the recording and resume the recording till the recorder's print head cools down.
Recorder Initializing	Prompt	/	Wait until the recorder initialization is completed.
Recorder Out Of Paper	Prompt	/	The recorder paper is not loaded or the recorder door is not closed. Check the recorder, load the recorder paper or close the recorder door.
Recorder Busy	Prompt	/	The buffer queue for recording is full.

D.2.14 Printer Technical Alarm Messages

Alarm message	Default priority	Indication on alarm reset	Cause and solution
Printer Buffer Full	Prompt	/	The printer buffer is full. Wait till the printer finishes the printing task.
Printing Fail	Prompt	/	The printer runs out of paper or cannot be connected. Check the printer.
Printing Stopped	Prompt	/	Printing was manually stopped.
Printer Unavailable	Prompt	/	The printer may fail. Check the printer.
PDF storage space is nearly full	Prompt	/	Delete the files saved under the PDF file path to release storage space. Otherwise you cannot save new PDF files.
Error storing PDF file	Prompt	/	The PDF file path settings on the printer server and the PDFCreator are not consistent or the PDF storage space is full. Check the PDF file path settings for consistency, or delete the files saved under the PDF file path to release storage space.
Change the print server language to be consistent with this monitor	Prompt	/	Verify that the language settings of the printer server and the monitor are consistent, Otherwise you cannot perform printing.
Print Server Disconnected	Prompt	/	Check that the monitor is properly connected with the printer server.

D.2.15 Technical Alarm Messages Related to Networked Monitoring

Alarm message	Default priority	Indication on alarm reset	Cause and solution
CMS/eGW Disconnected	Low	B	The monitor is disconnected from the CMS. Check the network connection.
View Bed XX YY-ZZ, Network Disconnected.	Low	A	The network is interrupted when the monitor is viewing the remote device. Check the network connection.
Viewed by Bed XX YY-ZZ, Network Disconnected.	Low	A	The network is interrupted when the monitor is viewed by another remote device. Check the network connection.
WLAN IP Address Conflict	Low	C	There is a wireless network IP address conflict. Check the network settings.
LAN1 IP Address Conflict	Low	C	There is a wireless network IP address conflict. Check the network settings.
Fail To Get WLAN IP Address	Low	C	Unable to automatically obtain the wireless network IP address. Check the network settings.
Fail To Get LAN1 IP Address	Low	C	Unable to automatically obtain the wired network LAN1 IP address. Check the network settings.

Note: XX refers to the department name, YY refers to the room number, and ZZ refers to the bed number.

D.2.16 Other System Technical Alarm Messages

Alarm message	Default priority	Indication on alarm reset	Cause and solution
XX: Disconnected (XX refers to the name of the external device)	High	A	Corresponding external device is disconnected. Check the connection between the monitor and the external device.
Storage Error	High	C	The storage card fails or files are damaged. Restart the monitor to format the storage card. If the alarm persists, contact your service personnel.
Loading Default Config Failed	Low	A	The default configuration was not correctly loaded. The monitor will restore to the factory default configuration for the current patient category.
XX Conflicts (XX refers to the module label)	Prompt	/	The same type of corresponding module being used exceeds the supported number. Remove the conflict module.
XX Measurement has been closed (XX refers to the module label)	Prompt	/	The parameter module is disabled. Switch on the module if you want to use it. For more information, see <i>3.9.1 Switching On or Off a Parameter</i> .
The display setup for XX is disabled. (XX refers to the parameter label)	Prompt	/	The parameter of the newly inserted module is not displayed on the screen. Select a desired area to display the parameter numerics and waveforms. For more information, see <i>3.9.2 Displaying Parameter Numerics and Waveforms</i> .
The patient data storage space is nearly full. Please delete some discharged patients.	Med	B	The storage space of the monitor is full. Delete unnecessary earlier discharged patient.

This page intentionally left blank.

E SpO₂ Sensor Accuracy

E.1 The Accuracy of Masimo SpO₂ Sensors

Table information for the plots below show A_{RMS} values measured with Masimo SET Oximetry Technology in a clinical study.

Aidx/Pdtx/4000/4001

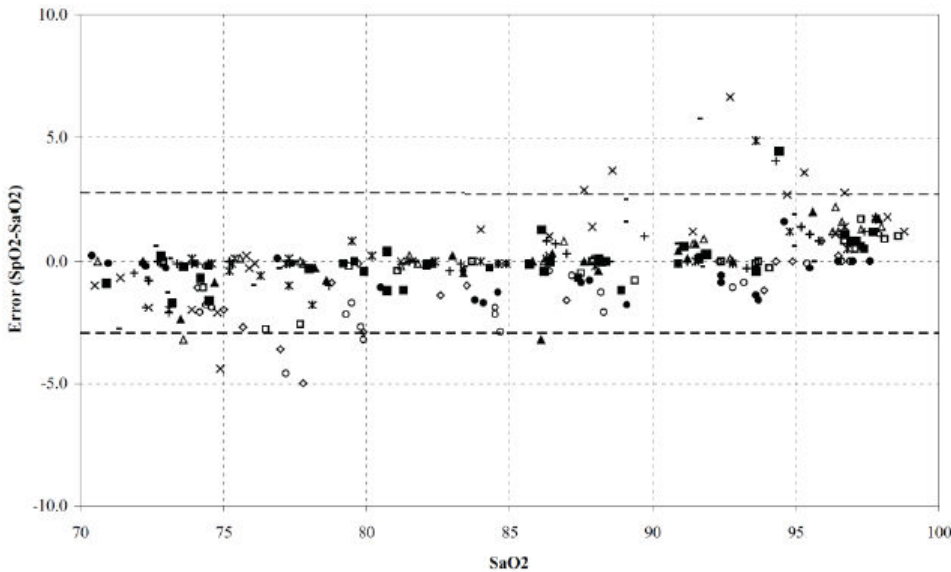

MEASURED A _{RMS} VALUES	
Range	A _{RMS}
90-100%	1.64%
80-90%	1.07%
70-80%	1.55%
Range	A _{RMS}
70-100%	± 2 %
Overall Claimed Accuracy Value	

Inf/Neo/NeoPt/4002/4003/4004/4005

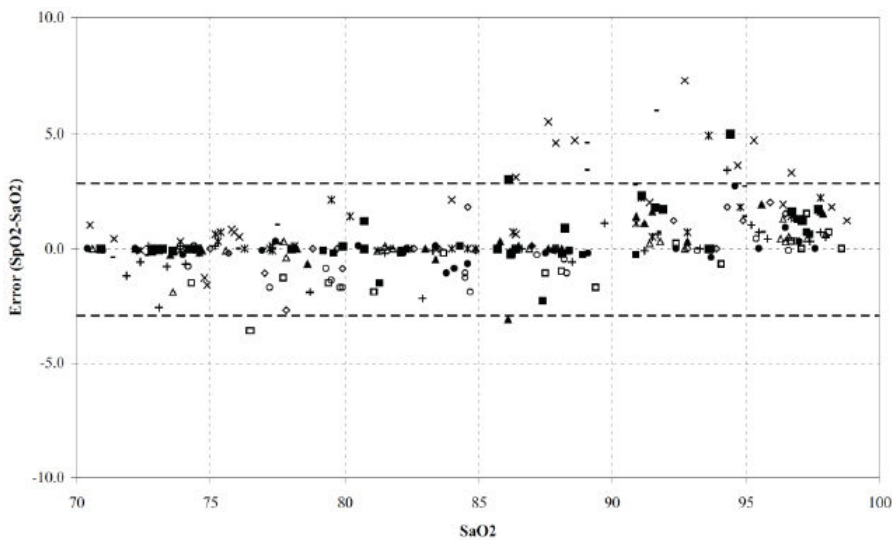

MEASURED A _{RMS} VALUES	
Range	A _{RMS}
90-100%	1.85%
80-90%	1.44%
70-80%	0.89%

Range	A _{RMS}		
	Inf	Neo*	Neo Pt*
70-100%	± 2 %	±2 % Adult ±3 % Neonatal	±3 %
Overall Claimed Accuracy Value			

*The saturation accuracy of the Neonate and Preterm sensors was validated on adult volunteers and 1% was added to account for the properties of fetal hemoglobin.

DCI/DCIP/4050/4051

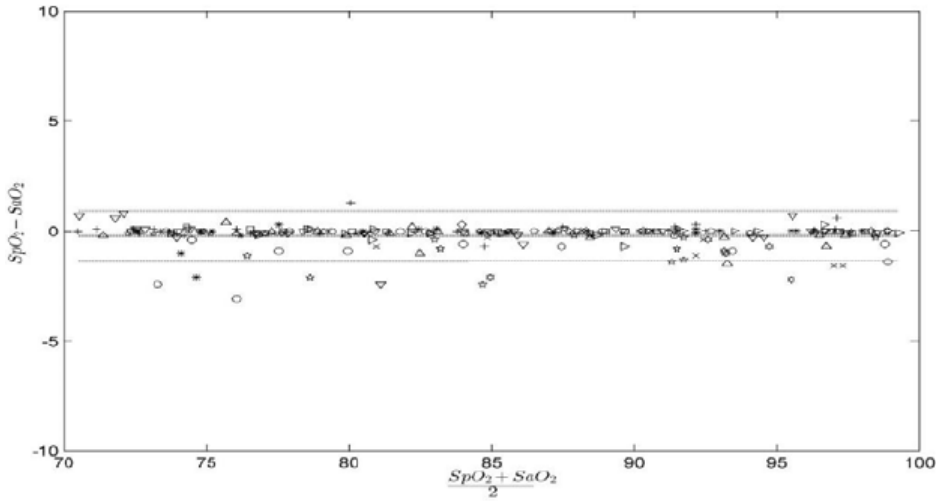

MEASURED A_{RMS} VALUES	
Range	A_{RMS}
90-100%	0.60%
80-90%	0.54%
70-80%	0.67%
Range	A_{RMS}
70-100%	2 %
Overall Claimed Accuracy Value	

LNCS YI

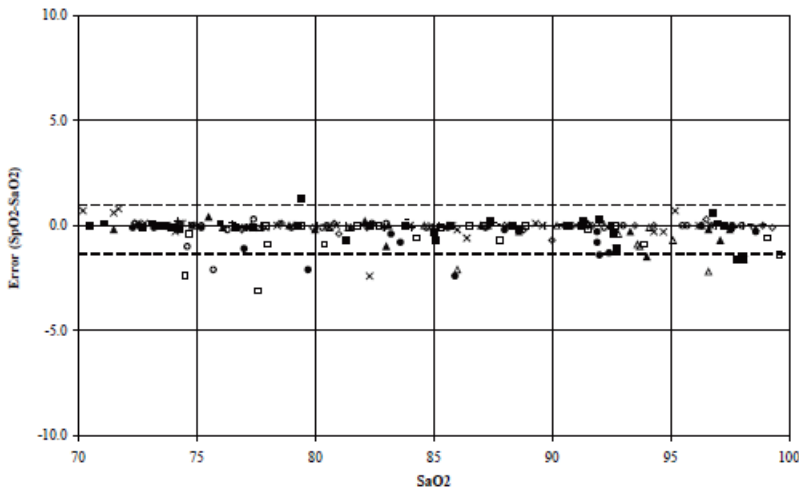

MEASURED A_{RMS} VALUES	
RANGE	A_{RMS}
90-100%	0.6%
80-90%	0.5%
70-80%	0.7%
OVERALL CLAIMED ACCURACY VALUE	
70-100%	$\pm 2\%$

4053

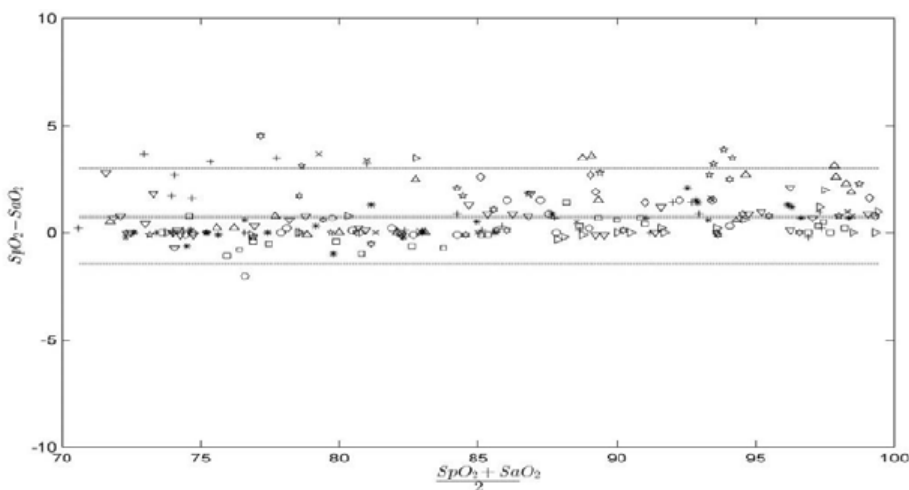

MEASURED A_{RMS} VALUES	
Range	A_{RMS}
90-100%	1.45%
80-90%	1.22%
70-80%	1.41%
Range	A_{RMS}
70-100%	2 %
Overall Claimed Accuracy Value	

E.2 The Accuracy of Nellcor SpO₂ Sensors

SpO₂ Accuracy for Nellcor Sensors vs. Co-Oximeters (Arms)

SpO ₂ Range	100% to 70%	100% to 90%	90% to 80%	80% to 70%
DS-100A	1.64%	1.16%	1.67%	2.25%
D-YS, OXI-P/I, OXI-A/N	2.41%	1.38%	2.50%	3.60%
MAXAI, MAXPI, MAXII	1.62%	1.49%	1.57%	2.50%
MAXNI	1.85%	1.71%	1.51%	1.59%

Modified Bland-Altman for SpO₂ - MAXAI, MAXPI, MAXII, MAXNI Sensors: (SpO₂ - SaO₂) vs.SaO₂

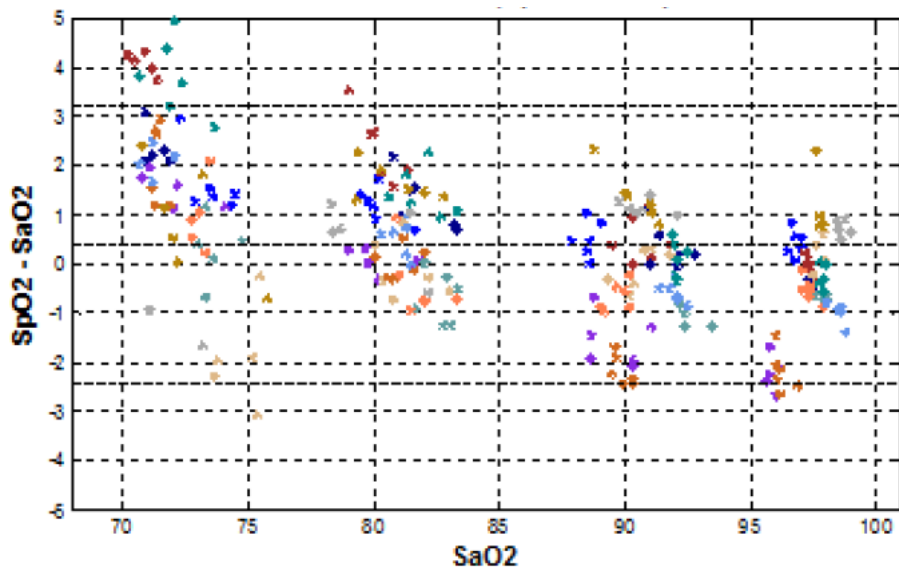

Modified Bland-Altman for SpO₂ - DS-100A Sensors: (SpO₂ - SaO₂) vs.SaO₂

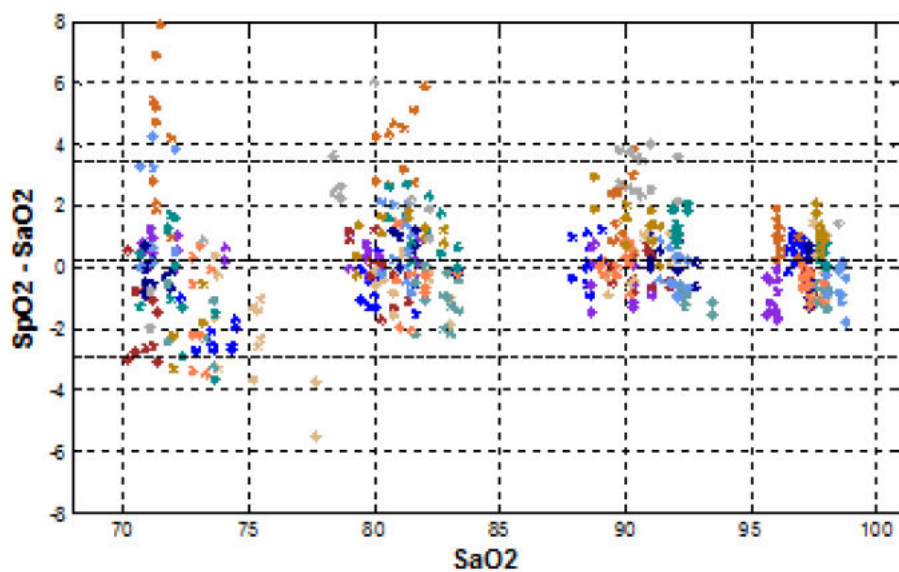

Modified Bland-Altman for SpO₂ - D-YS, OXI-A/N, OXI-P/I Sensors: (SpO₂ - SaO₂) vs.SaO₂

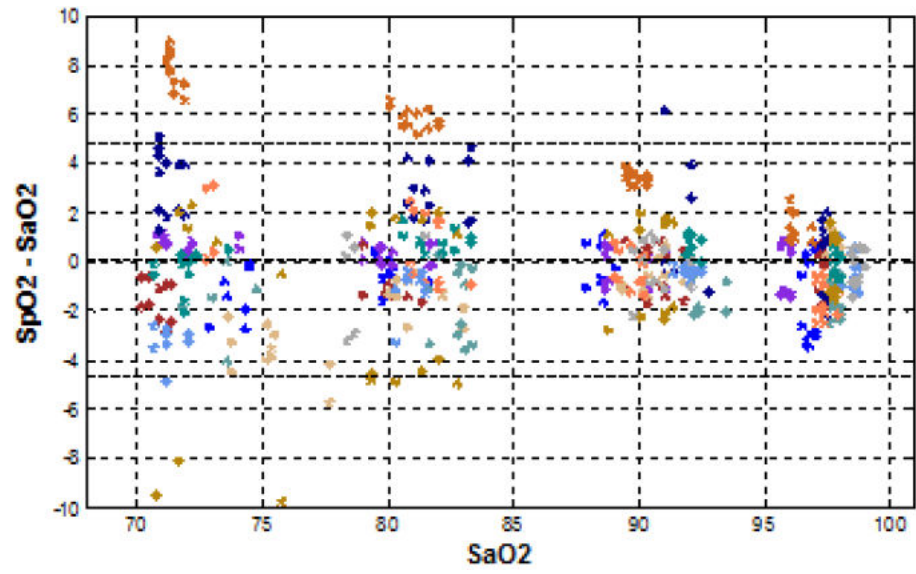

F Units, Symbols and Abbreviations

F.1 Units

Abbreviation	In Full
μA	microampere
μV	microvolt
μs	microsecond
A	Ampere
Ah	Ampere hour
bpm	beat per minute
bps	bits per second
°C	Celsius
cc	cubic centimeter
cm	centimeter
dB	decibel
DS	dyne second
°F	Fahrenheit
g	gram
GHz	gigahertz
GTT	gutta
h	hour
Hz	hertz
in	inch
k	kilo
kg	kilogram
kPa	kilopascal
L	litre
lb	pound
m	meter
mAh	milliampere hour
mcg	microgram
mEq	milli-equivalents
mg	milligram
min	minute
ml	milliliter
mm	millimeter
mmHg	millimeters of mercury

Abbreviation	In Full
cmH ₂ O	centimeters of water
ms	millisecond
mV	millivolt
mW	milliwatt
MΩ	megaohm
nm	nanometer
rpm	breaths per minute
s	second
V	volt
VA	volt ampere
Ω	ohm
W	watt

F.2 Symbols

Symbol	Explanation
-	negative, minus
%	percent
/	per; divide; or
~	to
+	plus
=	equal to
<	less than
>	greater than
≤	less than or equal to
≥	greater than or equal to
±	plus or minus
×	multiply
©	copyright

F.3 Abbreviations

Abbreviation	In Full
AaDO ₂	alveolar-arterial oxygen gradient
AC	alternating current
Adu	adult
AG	anaesthesia gas
AHA	American Heart Association
Ao	aortic pressure
Art	arterial
ATMP	barometric pressure
aVF	left foot augmented lead
aVL	left arm augmented lead
aVR	right arm augmented lead
awRR	airway respiratory rate
BSA	body surface area
BT	blood temperature
BTPS	body temperature and pressure, saturated
CAA	Clinical Assistive Application
CaO ₂	arterial oxygen content
CCU	cardiac (coronary) care unit
CE	Conformité Européenne
C.I.	cardiac index
CIS	clinical information system
CISPR	International Special Committee on Radio Interference
CMS	central monitoring system
C.O.	cardiac output
CO ₂	carbon dioxide
COHb	carboxyhemoglobin
COPD	chronic obstructive pulmonary disease
CVP	central venous pressure
DC	direct current
Des	desflurane
Dia	diastolic
dpi	dot per inch
DVI	digital video interface
ECG	electrocardiograph
EDV	end-diastolic volume
EEC	European Economic Community
EMC	electromagnetic compatibility

Abbreviation	In Full
EMI	electromagnetic interference
Enf	enflurane
ESV	end systolic volume
ESVI	end systolic volume index
ESU	electrosurgical unit
Et	end-tidal
EtAA	end-tidal anesthetic agent
EtDes	end-tidal anesthetic agent
EtEnf	
EtHal	
EtIso	
EtSev	
EtCO ₂	
EtN ₂ O	end-tidal nitrous oxide
EtO ₂	end-tidal oxygen
EWS	Early Warning Score
FAP	femoral arterial pressure
FCC	Federal Communication Commission
FDA	Food and Drug Administration
Fi	fraction of inspired
FiAA	inspired anesthetic agent
FiDes	inspired anesthetic agent
FiEnf	
FiHal	
FiIso	
FiSev	
FiCO ₂	
FiN ₂ O	fraction of inspired nitrous oxide
FiO ₂	fraction of inspired oxygen
GCS	Glasgow Coma Scale
GEDV	global end diastolic volume
GEDI	global end diastolic volume index
GEF	global ejection fraction
Hal	halothane
HIS	hospital information system
HR	heart rate
IBP	invasive blood pressure
ICP	intracranial pressure
ICU	intensive care unit

Abbreviation	In Full
ID	identification
I:E	inspiratory time: expiratory time ratio
IEC	International Electrotechnical Commission
IEEE	Institute of Electrical and Electronic Engineers
IP	internet protocol
Iso	isoflurane
LA	left arm
LAP	left atrial pressure
LCD	liquid crystal display
LDAP	Lightweight Directory Access Protocol
LED	light emitting diode
LL	left leg
LVSW	left ventricular stroke work
LVSWI	left ventricular stroke work index
MAC	minimum alveolar concentration
MetHb	methemoglobin
MEWS	Modified Early Warning Score
MLDAP	Mindray LDAP, Mindray lightweight directory access protocol
MRI	magnetic resonance imaging
N/A	not applied
N ₂ O	nitrous oxide
Neo	neonate
NEWS	National Early Warning Score
NIBP	noninvasive blood pressure
O ₂	oxygen
O ₂ %	oxygen concentration
OR	operating room
OxyCRG	oxygen cardio-respirogram
PA	pulmonary artery
PAWP	pulmonary artery wedge pressure
Ped	pediatric
Pleth	plethysmogram
PPV	pulse pressure variation
PR	pulse rate
PVC	premature ventricular contraction
RA	right arm
RAP	right atrial pressure
Raw	airway resistance
Rec	record, recording

Abbreviation	In Full
Resp	respiration
RL	right leg
RR	respiration rate
SEF	spectral edge frequency
Sev	sevoflurane
SI	stroke index
SpO ₂	arterial oxygen saturation from pulse oximetry
SQI	signal quality index
SR	suppression ratio
SV	stroke volume
SVI	stroke volume index
SVR	systemic vascular resistance
SVRI	systemic vascular resistance index
Sync	synchronization
Sys	systolic pressure
TB	blood temperature
TD	temperature difference
Temp	temperature
TFC	thoracic fluid content
TI	injectate temperature
TP	total power
TV	tidal volume
UAP	umbilical arterial pressure
USB	universal serial bus
UVP	umbilical venous pressure
VAC	volts alternating current

