

**P7-3T/P7-3TE/P7-3TU/P7-3Ts Ultrasonic  
Transducer**

**Operator's Manual**



# Contents

<b>Contents</b> .....	<b>i</b>
Intellectual Property Statement.....	I
Responsibility on the Manufacturer Party.....	II
Warranty.....	II
Customer Service Department.....	III
Important Information.....	IV
Introduction.....	V
<b>Safety Precautions</b> .....	<b>VI</b>
Meaning of Signal Words.....	VI
Meaning of Safety Symbols.....	VI
Safety Precautions.....	VI
Labels.....	IX
<b>1 Overview</b> .....	<b>1-1</b>
1.1 Safety Classification.....	1-1
1.2 Applications.....	1-1
1.3 Acoustic Power.....	1-1
1.4 Contraindications.....	1-2
1.5 Out-of-Box Inspection.....	1-2
1.6 Structure of P7-3T/P7-3TE/P7-3TU/P7-3Ts.....	1-3
1.6.1 Transducer Functions by Part.....	1-3
<b>2 Transducer Controls and Inspection</b> .....	<b>2-1</b>
2.1 Inspection before Use.....	2-1
2.1.1 Visual and Tactile Inspection.....	2-1
2.1.2 Deflection and Scanplane Rotation Control.....	2-2
2.2 Connecting and Disconnecting the Transducer.....	2-6
2.2.1 Connecting the Transducer.....	2-6
2.2.2 Disconnecting the Transducer:.....	2-6
2.3 Electrical Safety.....	2-7

2.3.1	Electrical Leakage Current Test .....	2-7
2.3.2	Bite-hole Inspection Test .....	2-8
2.4	Thermal Safety.....	2-9
2.4.1	Thermal Limits.....	2-9
2.4.2	Control Settings, Temperature.....	2-10
2.4.3	Temperature Calibration Test .....	2-10
2.5	Cleaning and Disinfecting the Transducer and Bite-guard .....	2-11
2.6	Checking after Turning ON the System .....	2-11
<b>3</b>	<b>Examination.....</b>	<b>3-1</b>
3.1	Pre-Exam Inspection.....	3-1
3.2	Couple Gel, Sheath, and Bite-guard.....	3-2
3.2.1	Couple Gel.....	3-2
3.2.2	Sheath .....	3-2
3.2.3	Bite-guard .....	3-3
3.2.4	Ordering Supplies.....	3-3
3.3	Examination .....	3-3
3.3.1	Cautions .....	3-4
3.3.2	Operation of Deflection Controls .....	3-4
3.3.3	Emergency Retraction.....	3-5
3.4	After Examinations .....	3-5
<b>4</b>	<b>Cleaning and Disinfection.....</b>	<b>4-1</b>
4.1	Cleaning.....	4-1
4.2	Disinfections.....	4-3
<b>5</b>	<b>Storage and Transportation.....</b>	<b>5-1</b>
<b>6</b>	<b>Specifications.....</b>	<b>6-1</b>

© 2012-2016 Shenzhen Mindray Bio-Medical Electronics Co., Ltd. All rights Reserved.

For this Operator's Manual, the issue date is 2017-03.

## Intellectual Property Statement

SHENZHEN MINDRAY BIO-MEDICAL ELECTRONICS CO., LTD. (hereinafter called Mindray) owns the intellectual property rights to this Mindray product and this manual. This manual may refer to information protected by copyright or patents and does not convey any license under the patent rights or copyright of Mindray, or of others.

Mindray intends to maintain the contents of this manual as confidential information. Disclosure of the information in this manual in any manner whatsoever without the written permission of Mindray is strictly forbidden.

Release, amendment, reproduction, distribution, rental, adaptation, translation or any other derivative work of this manual in any manner whatsoever without the written permission of Mindray is strictly forbidden.

**mindray**,  **MINDRAY**, **MET** , **OmniLab**,  **DigiPrince**, **MINDRAY** **BeneView**, **WATO**,

**BeneHeart**,  are the trademarks, registered or otherwise, of Mindray in China and other countries. All other trademarks that appear in this manual are used only for informational or editorial purposes. They are the property of their respective owners.

# Responsibility on the Manufacturer Party

Contents of this manual are subject to change without prior notice.

All information contained in this manual is believed to be correct. Mindray shall not be liable for errors contained herein or for incidental or consequential damages in connection with the furnishing, performance, or use of this manual.

Mindray is responsible for the effects on safety, reliability and performance of this product, only if:

- all installation operations, expansions, changes, modifications and repairs of this product are conducted by Mindray authorized personnel;
- the electrical installation of the relevant room complies with the applicable national and local requirements; and
- the product is used in accordance with the instructions for use.

## **Note**

This equipment must be operated by skilled/trained clinical professionals.

## **Warning**

It is important for the hospital or organization that employs this equipment to carry out a reasonable service/maintenance plan. Neglect of this may result in machine breakdown or personal injury.

## Warranty

THIS WARRANTY IS EXCLUSIVE AND IS IN LIEU OF ALL OTHER WARRANTIES, EXPRESSED OR IMPLIED, INCLUDING WARRANTIES OF MERCHANTABILITY OR FITNESS FOR ANY PARTICULAR PURPOSE.

### Exemptions

Mindray's obligation or liability under this warranty does not include any transportation or other charges or liability for direct, indirect or consequential damages or delay resulting from the improper use or application of the product or the use of parts or accessories not approved by Mindray or repairs by people other than Mindray authorized personnel.

**This warranty shall not extend to:**

- Malfunction or damage caused by improper use or man-made failure.
- Malfunction or damage caused by unstable or out-of-range power input.
- Malfunction or damage caused by act of God such as fire and earthquake.
- Malfunction or damage caused by improper operation or repair by unqualified or unauthorized service people.
- Malfunction of the instrument or part whose serial number is not legible.
- Others not caused by the instrument or part itself.

## Customer Service Department

**Manufacturer:** Shenzhen Mindray Bio-Medical Electronics Co., Ltd.  
**Address:** Mindray Building, Keji 12th Road South, High-tech industrial park, Nanshan, Shenzhen 518057, P.R.China  
**Website:** www.mindray.com  
**E-mail Address:** service@mindray.com  
**Tel:** +86 755 81888998  
**Fax:** +86 755 26582680

**EC-Representative:** Shanghai International Holding Corp. GmbH(Europe)  
**Address:** Eiffestraße 80, Hamburg 20537, Germany  
**Tel:** 0049-40-2513175  
**Fax:** 0049-40-255726

**Manufacturer:** Mindray DS USA, Inc.  
**Address:** 800 MacArthur Blvd.  
Mahwah, NJ 07430-0619 USA  
**Tel:** +1(201) 995-8000  
**Toll Free:** +1 (800) 288-2121  
**Fax:** +1 (800) 926-4275

# Important Information

## Customer responsibility:

1. The responsibility for maintenance and management of the product after delivery resides with the customer who has purchased the product.
2. When the transducer is sent to MINDRAY for warranty or repair, you must disinfect it and keep it in the original shipping/carrying case to prevent infection.
3. The warranty does not cover:
  - (1) Damage to the transducer due to patient biting,
  - (2) Damage to the transducer caused by disinfecting or sterilizing incorrectly or with chemicals not recommended by Mindray
4. The warranty will be void if the transducer is not returned in its original Mindray carrying case.
5. This equipment shall not be used by persons other than fully qualified and certified medical personnel.
6. Do not make changes or modifications to the software or hardware of this product.
7. In no event shall MINDRAY be liable for problems, damage, or loss caused by relocation, modification, or repair performed by personnel other than those designated by MINDRAY.
8. The purpose of this system is to provide physicians with data for clinical diagnosis. The responsibility for diagnostic procedures lies with the physicians involved. MINDRAY shall not be liable for the results of diagnostic procedures.
9. MINDRAY shall not be liable for loss of data stored in the memory of this system caused by operator error or accidents.
10. This manual contains Warnings regarding foreseeable potential dangers. Be alert at all times to dangers other than those indicated. MINDRAY shall not be liable for damage or loss that results from negligence or from ignoring the precautions and operating instructions contained in this operator's manual.
11. On the occasion of change of the administrator or manager for this system, be sure to hand over this operator's manual.
12. When disposing of this system, contact your MINDRAY Customer Service Department or sales representative. Do not dispose of this system without consulting MINDRAY Customer Service Department or sales representative first. MINDRAY does not assume any responsibility for damage resulting from disposal of this system without consulting MINDRAY. A replacement transducer will not be sent to customer until the defective transducer is received.



# Introduction

This operator's manual describes the operating procedure for the transducer P7-3T/P7-3TE/P7-3TU/P7-3Ts. To ensure safe and correct operation of the transducer, read the operator's manual carefully and understand the transducers clearly before operation.



For the operating procedures for the ultrasonic diagnostic system and other devices, please refer to the relevant manuals.

# Safety Precautions

---

## Meaning of Signal Words

In this operator's manual,  **DANGER**,  **WARNING**,  **CAUTION** and **NOTE** are signal words used to indicate safety and other important instructions. The signal words and their meanings are defined as follows. Please understand their meanings clearly before reading this manual.

Signal Word	Meaning
 <b>DANGER</b>	Indicates an imminently hazardous situation that, if not avoided, will result in death or serious injury.
 <b>WARNING</b>	Indicates a potentially hazardous situation that, if not avoided, could result in death or serious injury.
 <b>CAUTION</b>	Indicates a potentially hazardous situation that, if not avoided, may result in minor or moderate injury.
<b>NOTE</b>	Indicates a potentially hazardous situation that, if not avoided, may result in property damage.

## Meaning of Safety Symbols

Symbol	Description
	General warning, caution, risk of danger.

## Safety Precautions

Please read the following precautions carefully to ensure the safety of the patient and the operator when using this transducer.

 <b>DANGER:</b>	<b>DO NOT use flammable gasses, such as anesthetic gas or hydrogen, or flammable liquids such as ethanol, near this system, because there is danger of explosion.</b>
--	---

**WARNING:**

1. This ultrasonic transducer is only for use with the specified ultrasonic diagnostic system. Please refer the ultrasonic diagnostic system operation manual to select the proper transducer.
2. The multiplane TE Transducer should be used only by a qualified physician who has received appropriate training in proper operation of the transducer and in endoscopic techniques as dictated by current relevant medical practices.
3. The multiplane TE transducer is a precision instrument, which must be handled with care. It may be damaged when dropped or abused. In particular, do not allow the ultrasonic window in the tip to come into contact with a sharp object. Do not touch this window unnecessarily. Never exert force onto the window.
4. To avoid injury to the patient, if any irregularity, substandard function or unsafe condition is observed or suspected, the TE transducer should not be used.
5. Keep the control handle and system connector out of any cleaning or disinfection solutions. The control handle and cable may be cleaned with a damp cloth, but only the distal end of the transducer up to the 100cm marker on the shaft may be placed into a disinfection solution.
6. To avoid injury to the patient and damage to the transducer, use a bite-guard during all transesophageal exams.
7. The use of a bite-guard is mandatory. Failure to use the bite-guard may result in damage to the transducer, which could result in a safety hazard. Damage to the transducer due to biting is not covered by the transducer's warranty.
8. To avoid injury to the patient, avoid forceful intubation pressure which can cause lacerations of the gastrointestinal tract with attendant and subsequent perforation.
9. The up/down and/or left/right deflection may after prolonged use develop an unwanted amount of free play. In that case, contact the service organization to readjust the steering of the transducer. In this way, the risk of "buckling" or "U-turning" of the transducer in the esophagus is minimized.
10. Confirm that the transducer and cable are normal before and after each examination. A defective transducer may cause electric shock to the patient.
11. When using intra-cavity transducers, do not activate the transducer outside the patient's body.
12. The connector is not watertight, and should always be kept dry. The control unit, although spray-watertight, should not be immersed.
13. Do not subject the transducer to shock. A defective transducer may cause electric shock to the patient.

14. This equipment contains no operator serviceable components. To prevent electric shock, do not remove any covers or panels.
15. **DO NOT** use the transesophageal transducer with the defibrillator.



**CAUTION:**

1. When using this transducer, wearing sterile gloves can help to prevent infection.
2. To avoid inadvertent damage to the transducer, read this user guide before handling and cleaning the TE transducer.
3. Be sure to use ultrasound gel. Please use the ultrasound gel compliant with the relevant local regulations.  
Only use water-based coupling gel.
4. Under normal conditions at full acoustic power the temperature of the tip does not exceed 43°C. Follow the instruction in this user manual to check this regularly.
5. Do not use the carrying case for storing the transducer. If the carrying case is used for storage, it may become a source of infection.
6. It is required to practice ALARA when operating ultrasound system. Minimize the acoustic power without compromising the quality of images.
7. The transducer and accessories supplied with it are not delivered disinfected or sterilized. Sterilization or high-level disinfection is recommended before use.
8. Disposable components are packaged sterile and are single-use only. Do not use if integrity of packaging violated or if expiration date has passed. Please use the disposable components compliant with the relevant local regulations.
9. Please use the disinfection or sterilization solution that recommended in this operator's manual, otherwise Mindray will not be liable for damage caused by other solutions. If you have any questions, please contact Mindray Customer Service Department or sales representative.
10. Before introducing the transducer: do not rub or spray the tip of the transducer with an anesthetic agent.
11. The damage of the transducer may be caused by the contact of improper gel or cleaner:  
**DO NOT** dip the transducer in the strong polar solutions of ethanol, chloride of lime, ammonium chloride, acetone and formaldehyde.  
**DO NOT** contact the transducer with solution or ultrasound gel containing oily medium such as mineral oil or lanoline.

<b>NOTE:</b>	<ol style="list-style-type: none"> <li>1. Read the following precautions to prevent the transducer from malfunction. <ul style="list-style-type: none"> <li>● Before connecting or disconnecting the transducer, freeze or turn off the ultrasonic diagnostic system.</li> <li>● Clean and disinfect the transducer before and after each examination.</li> </ul> </li> <li>2. Ambient conditions: <p>To prevent the transducer from being damaged, do not use it where it will be exposed to:</p> <ul style="list-style-type: none"> <li>● direct sunlight or X-rays</li> <li>● sudden changes in temperature</li> <li>● dust</li> <li>● excessive vibration</li> <li>● heat generators</li> </ul> <p>Use the P7-3T/P7-3TE/P7-3TU/P7-3Ts transducer under the following ambient conditions:</p> <ul style="list-style-type: none"> <li>● ambient temperature: 0°C to 40°C</li> <li>● relative humidity: 30% to 85% (no condensation)</li> <li>● atmospheric pressure: 700 hPa to 1060 hPa</li> </ul> </li> <li>3. Repeated disinfection will eventually damage the transducer, please check the transducer's performance periodically.</li> </ol>
--------------	--



## Labels

Various labels are attached to this device.

This operator's manual describes the safety precautions of operating the transducer. Read the operator's manual carefully before using the system.

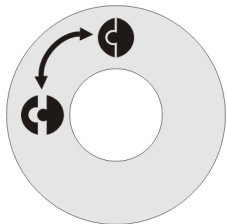
Some labels are shown in the following.

No.	Label	Meaning
1		Indicates the direction of the lock handle. The top symbol indicates the position of locked handle, the left symbol indicates the position of the unlocked handle.

No.	Label	Meaning
2		Type-BF applied part.
3		Indicates safety precautions. The label uses the same signal words as used in the descriptions in the operator's manual.

# 1 Overview

---

## 1.1 Safety Classification

Please refer to the safety classification information in the related operator's manual for the ultrasonic diagnostic system that matches with this transducer.

## 1.2 Applications

- |   |  |
|---|--|
|  <b>WARNING:</b> | <ol style="list-style-type: none"><li>1. The multiplane TE Transducer should be used only by a qualified physician who has received appropriate training in proper operation of the transducer and in endoscopic techniques as dictated by current relevant medical practices.</li><li>2. The TE transducer is intended to be used on adults only. Fetal imaging and pediatric imaging is not permitted.</li></ol> |
|---|--|

The P7-3T/P7-3TE/P7-3TU/P7-3Ts transducer is designed for 2D, M Mode, color Doppler (Color), pulsed wave (PW) Doppler, and continuous wave (CW) Doppler by applying ultrasound energy through the esophagus or stomach of the patient into the heart. The TE transducer is intended to be used on adults only. Backscattered ultrasound energy from the patient's heart is used to form images of the heart to detect abnormalities in structure or motion, to evaluate the velocity of blood flowing within the heart, and to obtain a color depiction of the velocities of blood flowing in the heart.

The physician conducting the examination must exercise sound medical judgment in the selection of patients for this transducer and be skilled in interpreting the data obtained from the examination with the multiplane TE transducer.

## 1.3 Acoustic Power

The effects of acoustic power on human tissue are currently under investigation. Therefore, it is recommended that diagnostic ultrasound output power be set to the lowest possible levels in accordance with the ALARA (As Low As Reasonably Achievable) principle.

Please refer to the operator's manual of the ultrasonic diagnostic system.

## 1.4 Contraindications

 **WARNING:** The physician must take into account all possible factors before starting the examination.

Contraindications for using the TEE transducer are:

- Fetal imaging
- Pediatric imaging
- Imaging when the patient exhibits the following or similar conditions:
  - Esophageal stricture, spasms, lacerations, and trouble swallowing (dysphagia)
  - Esophageal diverticula, esophageal varices (swollen veins)
  - Gastrointestinal bleeding
  - Peptic ulcers, hiatal hernia, esophageal webs and rings
  - Recent radiation treatment to the esophagus
  - Inability of the patient to swallow or accommodate the transducer
  - History of gastroesophageal diseases
  - Other therapies the patient may be undergoing

## 1.5 Out-of-Box Inspection

The following items are supplied with each transducer.

Items	Quantity
Ultrasonic transducer	1
Operator's manual	1
Carrying case	1
Tip cover	1

Tips: the tip cover encloses and protects the distal end/scanhead of the endoscope from being exposed to mechanical strain during transportation and storage.

The following inspections should be performed on the TE transducer after unpacking the contents.

- Perform visual and tactile inspection. See “2.1.1 Visual and Tactile Inspection”.
- Perform tip deflection inspection. See “2.1.2.1 Tip Deflection Control”.
- Perform brake inspection. See “2.1.2.2 Brake Operation”.
- Perform scanplane rotation inspection. See “2.1.2.5 Scanplane Rotation Inspection”.
- Perform leakage test. See “2.3.1 Electrical Leakage Current Test”.

Contact Mindray or your local representative immediately to report any damage or discrepancies.



**⚠ WARNING:** To avoid injury to the patient, if any irregularity, substandard function or unsafe condition is observed or suspected, the TE transducer should not be used.

## 1.6 Structure of P7-3T/P7-3TE/P7-3TU/P7-3Ts

P7-3T/P7-3TE/P7-3TU/P7-3Ts is a phased array transducer, mounted in a sealed tip at the end of a gastroscope. The transducer is intended for imaging of the heart through the esophagus and the stomach. The array can be rotated 0°-180°. Scan plane rotation is controlled by two push-buttons on the control handle or via the ultrasound system. The deflection control wheels on the handle of the transducer controls the deflection of the tip.

### 1.6.1 Transducer Functions by Part

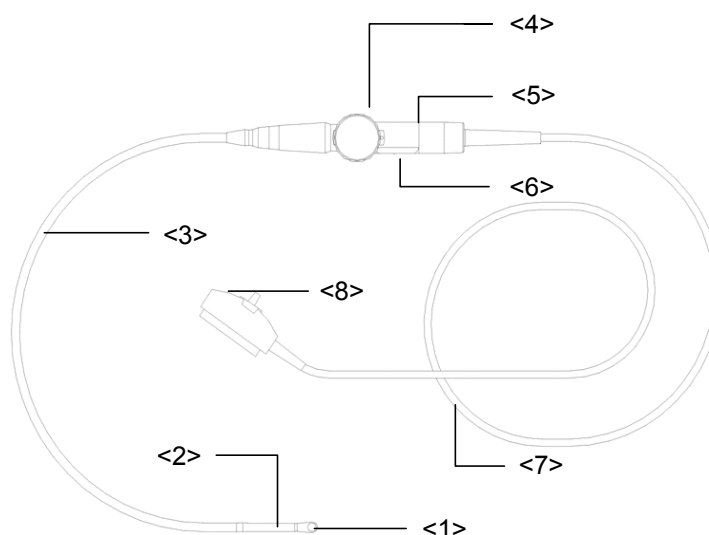

No.	Name	Function
1.	Distal tip with transducer	Converts the electrical signal into an ultrasonic signal, focusing the sound beams in a given direction; meanwhile, it receives the reflected ultrasonic signal and converts it into an electrical signal for transmission over the cable. The lens on the surface is the acoustic lens. Apply ultrasound gel on the acoustic lens for correct operation.
2.	Deflection section	Deflects to obtain an overall scanning.
3.	Flexible shaft	Inserts into the mouth cavity or esophagus. Depth is marked on the flexible shaft, unit: cm.
4.	Deflection control wheels	Controls deflection of the multiplane TE transducer tip.
5.	Control handle	Operates on the transducer deflection or rotation.

No.	Name	Function
6.	Motor control push-buttons	Controls to scanplane rotation. Range: 0° -180° .
7.	Cable	Transmits electrical signals between the transducer body and connector.
8.	Connector	Connects the transducer to the ultrasonic diagnostic system.

# 2 Transducer Controls and Inspection

---

## 2.1 Inspection before Use

The endoscope is designed for one-hand operation of the deflection and scanplane controls. The mechanical operation and physical integrity of the transducer should be checked after taking it out of the box and prior to each exam.

If any abnormality is found, immediately stop using the transducer and contact MINDRAY Customer Service Department or sales representative.

 **WARNING:** To avoid injury to the patient, if any irregularity, substandard function or unsafe condition is observed or suspected, the TE transducer should not be used.

### 2.1.1 Visual and Tactile Inspection

The visual and tactile inspection should be performed on the TE transducer after taking it out of the box and prior to each exam.

 **WARNING:** To avoid injury to the patient, do not use the transducer if any metallic protrusions, holes, rough spots, cracks, or dents are found.

Inspect contents:

1. Visually examine and feel all portions of the transducer before use, especially the gastroscope shaft and the flexible section at the distal end of the gastroscope. Perform the inspection of the flexible section both with the transducer deflection straight and deflected. There should be no discontinuities, bumps, dents, holes, abrasions, bite-marks or any other evidence of wear or damage found.
2. The hard plastic section at the distal end of the transducer should be smooth and firmly attached to the gastroscope shaft.
3. The cable and the connector that attach the transducer to the ultrasound console should be free from evidence of damage.

## 2.1.2 Deflection and Scanplane Rotation Control

The control handle is designed for one-hand operation. Normally the operator takes the control handle in his left hand. Thumb, first and second fingers control the deflection control wheels and scan plane rotation push-buttons.

The smallest wheel on the handle is for controlling the transducer left/right tip deflection. The largest wheel on the handle is for controlling the transducer up/down tip deflection. Both wheels have a locked and freely moving mode. In the locked mode the movement of the deflection wheel is restrained. This is used to hold the tip in a certain position. A metallic ring around the body of the handle, which clicks on/off, controls the lock of the up/down tip deflection. A shifting bar in the largest knob controls the lock of the left/right tip deflection.

### 2.1.2.1 Tip Deflection Control

The tip deflection brake inspection should be performed on the transducer after taking it out of the box and prior to each exam.

The deflection control wheels found on the handle of the transducer control deflection of the multiplane TE transducer tip. See the figure below:

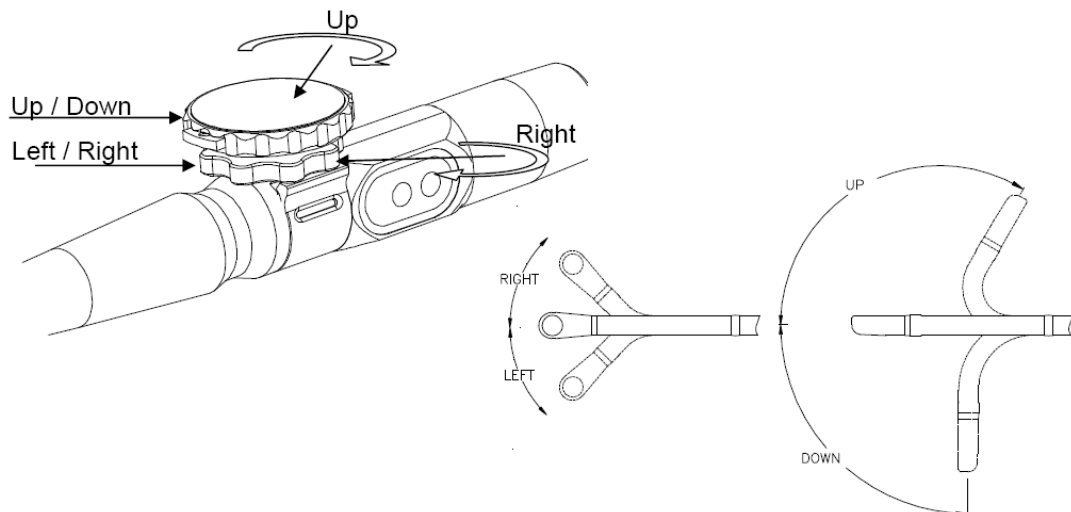

- Turn lower wheel counterclockwise to move the tip to the left, 30° minimum, 45° maximum.
  - Turn lower wheel clockwise to move the tip to the right, 30° minimum, 45° maximum.
  - Turn upper wheel counterclockwise to move the tip posterior, 90° minimum, 120° maximum.
  - Turn upper wheel clockwise to move the tip anterior, 60° minimum, 90° maximum.
1. Deflect the tip in all four directions and confirm that the angle is within the ranges specified above (with reference to the endoscope shaft).
  2. Confirm that the deflection controls operate smoothly.
  3. Check that when the deflection controls are in the neutral position that the transducer tip is also in a neutral position (undeflected).

<p><b>⚠ WARNING:</b></p>	<ol style="list-style-type: none"> <li>1. Check if the maximum deflection of the tip is 90° to 120° upward, 60° to 90° downwards and 30° to 45° left/right. If the deflection shows an unwanted amount of free play or exceeds the maximal deflection angles given above, do not use the transducer. Contact the service organization to re-adjust the steering of the transducer. In this way, the risk of "buckling" or "U-turning" of the transducer in the esophagus is minimized.</li> <li>2. To avoid damaging the transducer, do not deflect the transducer tip using finger pressure directly on the tip, as this may permanently damage the internal control wires.</li> </ol>
--------------------------	---

### 2.1.2.2 Brake Operation

To protect the patient and the transducer, unlock the deflection controls when inserting or withdrawing the transducer.

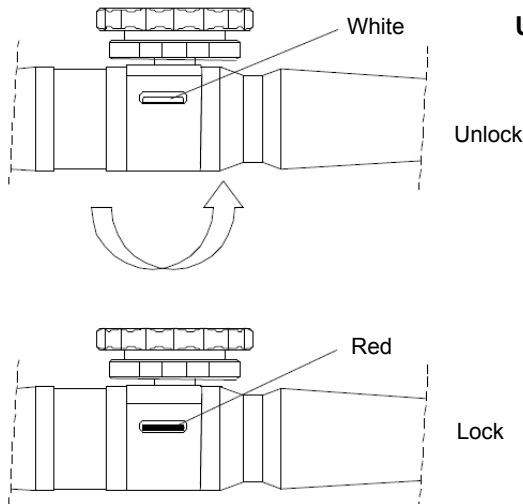

**Up/down**



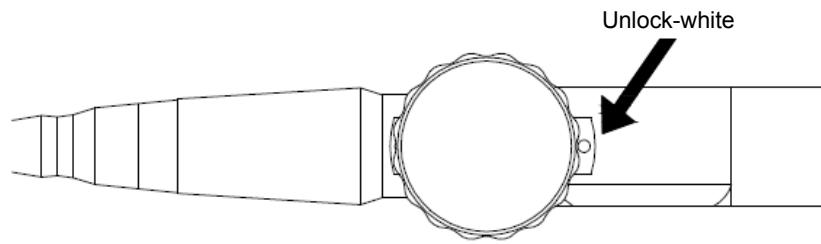

Left/right

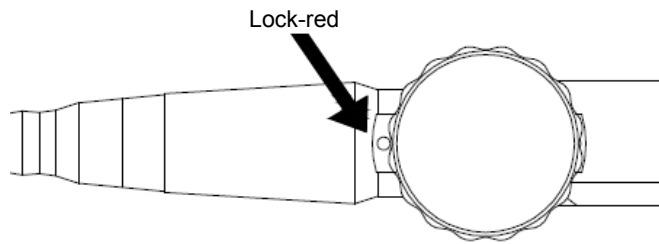

1. Confirm the brake is in the unlocked position.
2. Deflect the tip to the anterior direction.
3. Move the brake to the locked position.
4. Confirm that the tip is locked in the deflected position.
5. Unlock the brake and confirm the tip straightens easily.
6. Repeat steps 1-5 for the other directions.

### 2.1.2.3 Transducer Scan Plane Rotation Control

The transducer scan plane can be rotated from 0° (transversal plane) via 90° (longitudinal plane) to 180° (transversal plane, left/right inverted). All planes in between can also be chosen. This makes it possible to scan a conical imaging volume.

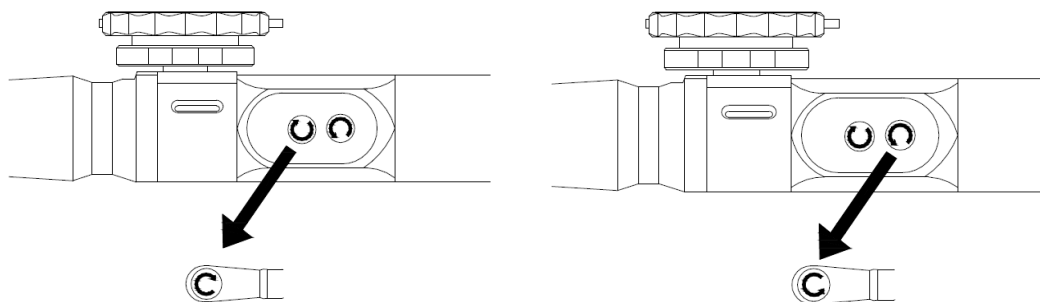

For orientation purposes, the user may choose to start scanning in one of the transverse planes, for instance the standard monoplane indicated as 0° on the system monitor. After rotating the scanplane 90° , scanning occurs in the longitudinal plane, sweeping through two opposite quadrants of the cone. When the scanplane rotates 90° further in the same direction, scanning occurs in the mirror image of the first transverse plane. The only two planes that are equivalent are the two transverse planes; one being the mirror image of the

other. As shown in figure below, a 180° rotation of the scanplane fills all four quadrants of the conic imaging volume.

The direction of the tip of the endoscope is easily steered using the deflection control wheels on the handle of the instrument to allow exact positioning of the transducer in the esophagus.

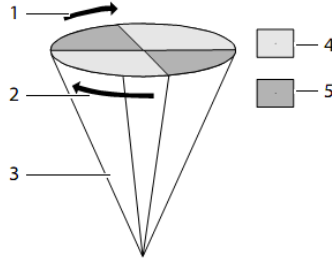

No.	Description
1	90° rotation sagittal to mirror image of transverse plane
2	90° rotation transverse to longitudinal plane
3	Conic imaging volume
4	Quadrants filled by first 90° rotation
5	Quadrants filled by second 90° rotation

### 2.1.2.4 Scanplane Indicator

For orientation purposes, a scanplane indicator has been incorporated on the system display. The actual scanplane angle is indicated by a marker, and the value is also displayed as shown in figure below. The scanplane angle ranges from 0° to 180° .



### 2.1.2.5 Scanplane Rotation Inspection

The scanplane rotation inspection on the transducer should be performed after taking it out of the box and prior to each exam.

1. Connect a TE transducer to the ultrasound system.
2. Prior to inserting the transducer, obtain an image, e.g., rest the transducer on a surface and adjust the gain to visualize the image on the ultrasound display.
3. Press the scanplane control buttons on the handle to rotate the scanplane counterclockwise (0° to 180°) and clockwise (180° to 0°).
4. Confirm the image on the screen changes in relation to the numbers on the scanplane indicator.

While pressing the scanplane control buttons, the transducer motor should be running as the image is changing.

**NOTE:** Do not rely only on the scanplane indicator on the screen to verify that the scanplane is rotating.

## 2.2 Connecting and Disconnecting the Transducer

This transducer should be used only with Mindray compatible ultrasonic diagnostic systems.

**NOTE:** Before connecting or disconnecting a transducer, freeze or turn off the ultrasonic diagnostic system, otherwise the ultrasonic diagnostic system or the transducer may malfunction.

### 2.2.1 Connecting the Transducer

After freezing or turning off the ultrasonic diagnostic system, align the connector with the transducer connector port of the ultrasonic diagnostic system, then turn the lock handle 90° clockwise to lock it securely. See the figure below:

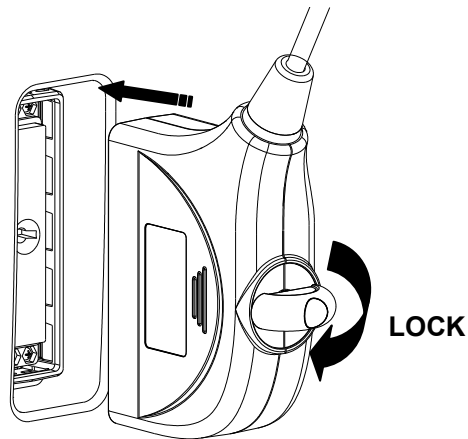

### 2.2.2 Disconnecting the Transducer:

After freezing or turning off the ultrasonic diagnostic system, turn the lock handle 90° anticlockwise to release the transducer, and pull it out straight. See the figure below:



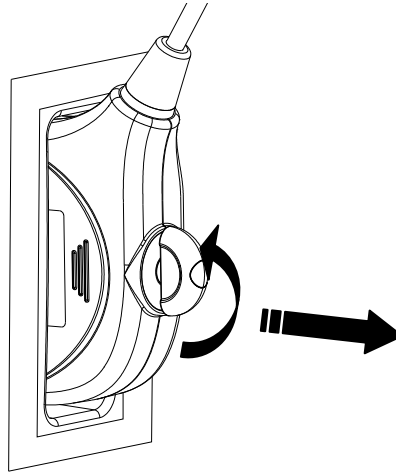

## 2.3 Electrical Safety

The electrical leakage current test should be performed on the TE transducer after taking it out of the box and prior to each exam, alternatively, if the bite-guard inspection test is done prior to each exam, then the electrical leakage current test should be done yearly at a minimum.

### 2.3.1 Electrical Leakage Current Test

Mindray ultrasound systems with accessories are designed to meet the requirements for patient safety described in IEC 60601-1:1988 Medical Electrical Equipment-Part1.General Requirements for Safety. To maintain patient safety it is important to have a low electrical leakage current in the product.

The endoscope shaft has no electrically conducting surfaces, and is covered with a layer of material, which permits neither fluids nor electricity to pass through it. Electrical safety is maintained for the transducer by keeping this material intact. Each TE transducer is tested for electrical isolation and leakage current before it is shipped to a customer.

<p><b>⚠ WARNING:</b></p>	<ol style="list-style-type: none"><li><b>1. To avoid injury to the patient, do not use the transducer if the insulating material has been punctured or otherwise compromised.</b></li><li><b>2. Measuring electrical leakage current should only be done by qualified personnel. Take all necessary precautions to avoid contact with non-insulated parts that have applied voltage.</b></li></ol>
--------------------------	--

Checking the integrity of the insulating material cannot always be accomplished by visual inspections. A program for measuring the electrical leakage current on a regular basis should be established. As a minimum, leakage tests according to EN 60601-1/IEC 60601.1 §19 must be performed once a year, or as required by local regulation. The leakage limits associated with Type BF Applied Part must be met. The test requires access to the

ultrasound system and to standardized test equipment. The transducer has to be immersed in a Normal Saline solution (50g NaCl per liter water) to above the 40 cm mark (but below the handle).

Mindray recommends keeping a written log of the results.

### 2.3.2 Bite-hole Inspection Test

Bite-holes or other damages of the endoscope surface can alternatively be detected by a simplified test without the access to the ultrasound system, by using the following procedure. The objective of this test is to detect bite-holes. It is safe and easy to perform, but is not an isolation or leakage current test as described in EN 60601-1. The test equipment is shown in figure below.

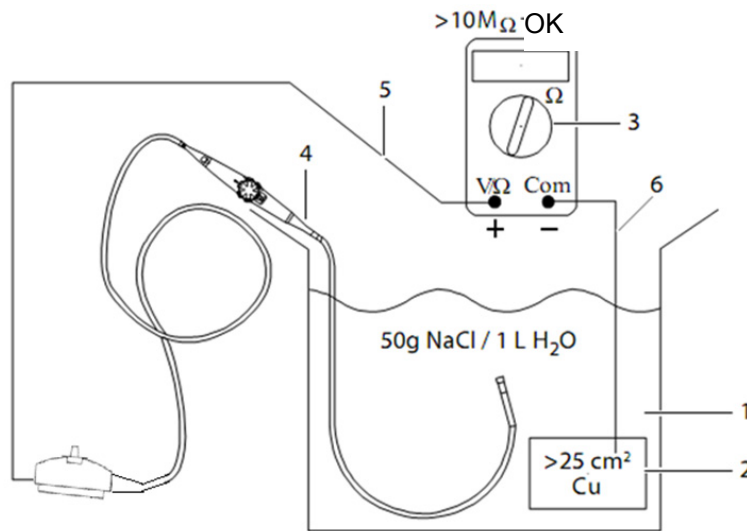

No.	Description
1.	Water bath
2.	Copper or aluminum sheet
3.	Multimeter
4.	TE transducer
5.	Positive lead
6.	Negative lead

#### Test Setup

Assemble the following items for the test.

- Water bath with a 1 Normal saline solution (50g NaCl/1 liter water).
- Copper or aluminum sheet with an area of at least 25 cm<sup>2</sup>.
- Digital multimeter with 40 MOhm scale (calibrated to NIST).

**Bite-hole Test**

1. Submerge the TE transducer with the endoscope shaft in liquid to above the 40 cm mark (but below the handle).
2. Connect the leads of the multimeter. See figure above.

**NOTE:** The multimeter can be connected to transducer and copper or aluminum sheet using alligator clips.

- Connect the positive lead to the bare metal of the system connector housing.
  - Connect the negative lead to the copper or aluminum sheet in the salt-water bath.
3. Set the multimeter to measure resistance (range > 40 MOhms).
  4. Wait at least 2 seconds and verify that the resistance is acceptable (greater than 10 MOhms).

**NOTE:** If there is a bite-hole, the resistance may vary considerably during the measurement and between different multimeters.

**WARNING:**

1. To avoid injury to the patient, do not use the transducer if the resistance value is less than 10 MOhms. Endoscope insulation may be damaged and should be verified by a Mindray representative.
2. To avoid injury to the patient, Mindray recommends that leakage current measurements be carried out on a regular basis. In addition, a bite-hole inspection should be conducted prior to the use of the transducer in any surgical procedure.

## 2.4 Thermal Safety

Maintaining a safe thermal environment for the patient has been a design priority at Mindray. It is generally agreed that to avoid damage to body tissues, for long term exposures, tissue contact transducer tip temperatures should be less than 43° C. The ultrasound system incorporates an elaborate thermal safety system which informs the physician of the operating temperature of the transducer, and prevents the operative temperature from exceeding given limits. Whenever the TE transducer is connected to the system, the transducer tip temperature is always on the system display.

If the temperature sensor is not working properly when you connect the transducer to the system, the transducer will not be accepted and scanning will not be possible.

### 2.4.1 Thermal Limits

- High limit

The system has two levels of upper thermal limit: the first high limit is set at 41.0° C, and the second high limit is set at 42.5° C. If the temperature of the transducer tip reaches 41.0° C,

the temperature display turns red and a warning appears on the image (For DC-7 series product, the system will freeze automatically in this condition). If the temperature reaches 42.5° C, the system will freeze unconditionally (the system can't be unfrozen even by pressing <Freeze> key). The user will not be allowed to scan until the temperature has decreased below 42.0° C. To restart scanning, the user must press the Freeze key.

■ Low limit

The system has a lower thermal limit of 17.5° C. If the temperature of the transducer tip reaches 17.5° C, the temperature display turns red.

## 2.4.2 Control Settings, Temperature

The following are general guidelines for reducing temperature in 2D or Doppler modes.

- In general, imaging in 2D mode results in the lowest transducer surface temperature.
- When imaging in 2D mode, increasing the image depth generally reduces the transducer surface temperature.
- When imaging in color mode, there are no imaging changes that reduce the transducer surface temperature.
- When imaging in PW Doppler mode, decreasing the PRF and/or positioning the Doppler sample gate to a shallower depth generally reduces the transducer surface temperature.
- When imaging in CW Doppler mode, increasing the depth of the CW Doppler sample line (2D image depth prior to turning on Doppler trace mode) generally reduces the transducer surface temperature.
- In any imaging mode, freezing the image will temporarily reduce the transducer surface temperature.

## 2.4.3 Temperature Calibration Test

The temperature measurement function should be verified to the specifications at least once a year.

### 2.4.3.1 Test Setup

Assemble the following items for the test.

- Temperature stabilized water bath
- Temperature gauge with accuracy of  $\pm 0.1^\circ \text{C}$

### 2.4.3.2 Temperature Calibration Test

1. Adjust the water bath temperature to  $41^\circ \pm 0.1^\circ \text{C}$  and monitor the temperature with the gauge.

If an accurate and stable water bath is not available, the added inaccuracy must be taken into account when the temperature is read from the ultrasound system. Deviation of

more than  $\pm 0.5^{\circ}$  C is not acceptable. Maintaining this accuracy without temperature regulation may be difficult.

2. Connect the TEE transducer to the ultrasound system.
3. Press <Freeze> and set patient temperature to be  $41^{\circ}$  C on ultrasound system.
4. Put the transducer tip in the water bath.  
At least 10 cm of the distal end must be submerged.
5. Observe the temperature indicated on the system monitor.
6. Wait until the temperature display is stabilized at  $41^{\circ} \pm 0.5^{\circ}$  C plus/minus any water bath temperature deviation.
7. Observe that the Warning pop-up window is displayed.

If both steps 6 and 7 are passed the temperature shutdown works as stated. If not, Contact Mindray or your local representative.

## 2.5 Cleaning and Disinfecting the Transducer and Bite-guard

For cleaning and disinfecting the transducer, please refer to “4 Cleaning and Disinfection” for details. Cleaning and sterilization of the bite-guards should be done according to instructions provided by the manufacturer of the bite-guard.

 <b>WARNING:</b>	<ol style="list-style-type: none"> <li>1. <b>The use of a bite-guard is mandatory. Failure to use the bite-guard may result in damage to the transducer, which could result in a safety hazard. Damage to the transducer due to biting is not covered by the transducer’s warranty.</b></li> <li>2. <b>If you don’t clean and disinfect the transducer and bite-guard, it may become a source of infection.</b></li> <li>3. <b>To avoid injury to the patient and damage to the transducer, use a bite-guard during all transesophageal exams.</b></li> </ol>
---	---

## 2.6 Checking after Turning ON the System

After turning ON the power of the ultrasonic diagnostic system, perform the following checks.

1. The acoustic lens of the transducer must not generate abnormal heat while it is being used. The transducer temperature should be checked by hand.

 <b>CAUTION:</b>	<b>If you keep a hot acoustic lens on the body surface, the patient may be burned.</b>
---	--

2. Scanplane calibration: A scanplane positioning calibration test is automatically performed when the transducer is connected and the ultrasound system is turned on. This calibration cycle lasts 5 to 10 seconds. After the calibration test is completed, the transducer temperature sensor is activated, and the transducer temperature is displayed, indicating the transducer is ready for use.

If the calibration test of the transducer fails, (no response from the scanplane buttons after calibration), re-connect the transducer to repeat the calibration test.

3. The image must not be abnormal while turning on the system.



**CAUTION:** Any of the problems mentioned above indicates that the ultrasonic diagnostic system or the transducer may be defective.

# 3 Examination

The actual examination with the multiplane TE Transducer is beyond the scope of this manual. There are many medical articles and books, which very thoroughly address this topic. There are however specific cautions that should be considered.

The operator should have adequate clinical experience and received related training.

**⚠ WARNING:** The physician must take into account all possible factors before starting the examination.

## 3.1 Pre-Exam Inspection

The following inspections should be performed prior to each exam.

Inspection/Activity	Location
Perform visual tactile inspection	See "2.1.1 Visual and Tactile Inspection".
Perform tip deflection inspection	See "2.1.2.1 Tip Deflection Control".
Perform brake inspection	See "2.1.2.2 Brake Operation".
Perform scanplane rotation inspection	See "2.1.2.5 Scanplane Rotation Inspection".
Perform leakage test or bite-guard inspection test	See "2.3.1 Electrical Leakage Current Test" or "2.3.2 Bite-hole Inspection Test".
Clean and disinfect transducer	See "2.5 Cleaning and Disinfecting the Transducer and Bite-guard".

**⚠ WARNING:**

1. To avoid injury to the patient, Mindray recommends performing the above procedures prior to each exam.
2. To avoid injury to the patient, do not use the transducer if any metallic protrusions, holes, rough spots, cracks, or dents are found.
3. To avoid injury to the patient, if during the deflection test, a sharp "U-turn" of the transducer tip is observed (the transducer tip angle exceeds the maximum deflection angles), do not use the transducer. Call Mindray or your local representative.
4. Some gels and sterilants can cause an allergic reaction in some individuals.

## 3.2 Couple Gel, Sheath, and Bite-guard

### 3.2.1 Couple Gel

Apply a sufficient amount of water-soluble acoustic coupling gel on the transducer acoustic window.

 **CAUTION:** Only use water-soluble acoustic coupling gel. Other coupling gels containing ingredients like ethanol, mineral oil, iodine, lotions, lanolin, aloe vera or methyl or ethyl parabenzoic acid can cause transducer damage.

### 3.2.2 Sheath

For patient protection, a sterile, single-use, latex sheath can be used over the transducer before performing examination. Use a commercially available transducer sheath.

If used, place the latex sheath over the transducer and gastroscope shaft up to but not covering the handle. Rub the tip carefully to ensure that all air bubbles have been removed from the transducer's acoustic window area. In addition to the gel on the acoustic window, apply a sufficient amount of acoustic coupling gel on the outside of the sheath at the tip of the transducer.

 **CAUTION:**

1. Be sure to cover the transducer with a new (unused) transducer sheath to prevent infection during examination. If the package of a transducer sheath is open or broken, the sterilization of the transducer sheath may not be sufficient. Do not use such a transducer sheath.
2. The sheath contains natural rubber latex and talc that can cause allergic reactions in some individuals. In the USA, refer to FDA Medical Alert MDA91-1.
3. Do not exert force on the window area.

Method (for reference):

1. Place an appropriate amount of gel inside sheath or on the transducer surface. Poor imaging may result if no gel is used.
2. Insert the transducer into the sheath.
3. Pull sheath tightly over transducer surface to remove wrinkles and air bubbles, and take care to avoid puncturing the sheath. Secure sheath with the enclosed elastic bands.
4. Inspect the sheath to ensure there are no holes or tears.



### 3.2.3 Bite-guard

Place the bite-guard on the transducer so that after insertion of the transducer the bite-guard can easily be placed in the patient's mouth. The bite-guard can also be placed in the patient's mouth before inserting the transducer.

**WARNING:**

1. **The use of a bite-guard is mandatory. Failure to use the bite-guard may result in damage to the transducer, which could result in a safety hazard. Damage to the transducer due to biting is not covered by the transducer's warranty.**
2. **To avoid damaging the transducer, use a bite-guard during all TE examinations. Biting the endoscope may cause severe, permanent damage to the transducer, rendering it unusable in the future, and unsafe in the present by creating electrical and mechanical failure mechanisms.**

Re-use, cleaning, and sterilization of the bite-guards should be done according to instructions provided by the manufacturer of the bite-guard.

### 3.2.4 Ordering Supplies

You can order transducer sheath, bite-guard and necessary accessories from the following manufacturer.

To order a transducer sheath, you may contact:

CIVCO Medical Instruments Co.

102 First Street South, Kalona, IA 52247-9589 USA

E-mail: [info@civco.com](mailto:info@civco.com)

<http://www.civco.com>

Call 1-800-445-6741 within the United States or 1-319-656-4447 outside of the United States.  
To fax orders call: 1-319-656-4451

For details, please contact your local Mindray representative for assistance.

## 3.3 Examination

The operator should adopt proper ultrasonic scanning procedures and methods according to different target organs.

**NOTE:** It is required to practice ALARA when operating ultrasonic diagnostic system.

### 3.3.1 Cautions

The actual techniques for introduction of the TE transducer into the patient are beyond the scope of the user guide. There are numerous medical texts and articles which thoroughly address this topic.

Observe the following precautionary measures when conducting an exam.

- Maintenance of an unobstructed airway is a prime consideration for all patients.
- Prolonged pressure on the esophagus by the tip of the transducer may lead to a pressure necrosis condition. Thus, in operating room monitoring applications, the tip should be removed from the esophagus wall when not scanning, by releasing it in the neutral position. If continuous monitoring is required, the transducer tip should be re-positioned often.
- Long term exposure to ultrasound should be minimized. Although there have never been any bioeffects demonstrated at the acoustic output levels of the TE transducer, it is prudent to minimize patient exposure to ultrasound according to the principle of ALARA (As Low As Reasonably Achievable). Please see the ultrasound system user guide.
- In consideration of the above 2 points, the user should freeze the image, which turns the power to the transducer off, and allow the endoscope deflection controls to be disengaged whenever active scanning is not desired.
- Proper patient preparation is essential for successful examinations. This includes restrictions on food and liquid intake as well as a thorough explanation of the examination procedure and other instructions as the particular situation warrants.
- The use of a bite-guard during all TE examinations is mandatory to protect the transducer from possible damage.
- The use of protective gloves during the examination is encouraged. Please see the U.S. Food and Drug Administration's Medical Alert on Latex Products (FDA 1991).
- In addition to the high level disinfection, the use of a protective sheath may provide an even higher level of protection against contamination of the transducer. Contact CIVCO for protective sheaths and applicators for protective sheaths.

### 3.3.2 Operation of Deflection Controls

The endoscope is designed for one-hand operation. Figure below shows the operator holding the endoscope handle in the left hand (for reference only). Thumb, first and second fingers interact with the deflection and scanplane controls.



There are two wheels for controlling the transducer tip deflection. The wheels have brake and freely-moving modes. In the braked mode, the movement of the deflection wheel is restrained. This is used to hold the tip in a certain position.

Special care should be taken when inserting and removing the transducer.

<b>⚠ WARNING:</b>	<ol style="list-style-type: none"><li>1. To avoid injury to the patient, using excessive force during insertion, positioning, or withdrawal may cause trauma to the stomach or esophagus.</li><li>2. To prevent damage to the esophagus when inserting or withdrawing the transducer, the control wheel must be in the freely moving, neutral, and un-braked state</li></ol>
-------------------	--

<b>⚠ CAUTION:</b>	To avoid damaging the transducer, do not deflect the distal tip of the transducer by direct application of force. Use the deflection wheels for this task.
-------------------	--

### 3.3.3 Emergency Retraction

If the transducer tip should get jammed in a deflected position inside the patient, and all attempts to release the deflected tip should fail, follow the following procedure to assure a safe retraction of the transducer.

1. Disconnect the transducer from the ultrasound system.
2. At an accessible location between the transducer handle and the patient, cut the entire endoscope shaft, including all internal wiring, using heavy duty cutting pliers or another suitable tool.

The deflection mechanism is now released and the transducer may be safely retracted.

## 3.4 After Examinations

After the examination is completed, turn OFF the ultrasonic diagnostic system, remove the bite-guard and disconnect the transducer, and then clean & disinfect the transducer.

After completing each examination, disinfect the transducer and bite-guard as necessary.

After disinfecting the transducer, confirm that the transducer is in good condition and store it in a suitable place.

For details about clean, disinfect, please refer to “4 Cleaning and Disinfection”.

# 4 Cleaning and Disinfection

---

This section describes the methods and precautions for cleaning and disinfection.



## **WARNING:**

1. **Keep the control handle and system connector out of any cleaning or disinfection solutions. The control handle and cable may be cleaned with a damp cloth, but only the distal end of the transducer up to the 100cm marker on the shaft may be placed into a disinfection solution.**
2. **Do not use other disinfection methods like Iodine, Steam, Heat or Ethylene Oxide.**



## **CAUTION:**

**When performing cleaning and disinfection of the transducer, wear gloves to prevent infection.**



**After disinfection, rinse the transducer thoroughly with water to remove all chemical residues. Chemical residues on the transducer may be harmful to the human body.**

**The efficacy of disinfectants and sterilizing solutions is not guaranteed by MINDRAY. Contact the manufacturers for information on the activity of the products.**

## **NOTE:**

1. **After the examination, wipe off the ultrasound gel thoroughly, otherwise, the ultrasound gel may solidify and degrade the image quality of the transducer.**
2. **Do not permit the transducer to become overheated (more than 55°C) during cleaning and disinfections. High temperature may cause the transducer to become deformed or damaged.**

## 4.1 Cleaning

Only the following cleaners are recommended by Mindray to clean the TEE transducers. For the biological effectiveness and the correct use of the cleaners, see the information of the cleaner's manufacturer:

Water and soap

70vol.%IsoPropyl alcohol

Enzol/Cidezyme LF

Cleaner	Active ingredient	Concentration
Aniosyme DD1	N,N-Didecyl-N-Methyl-Poly(oxyethyl)Ammonium Propionate Sodium N-Lauryl B-Iminodipropionate Ethoxylated Isotridecanol Monopropylene Glycol Ethane-1,2-Diol, Homopolymere PolyHexamethylene Biguanide Hydrochloride	10-25% 2,5-10% 2,5-10% 2,5-10% 0-2,5% 0-2,5%
Cidezyme/Enzol	Proteolytic enzymes	< 5%
T-Spray	N-alkyl-(C12-18)-n-N-dimethyl-N-Benzyl-ammonium-chloride; Alkyl-dimethyl-ethyl-benzyl-ammonium-chloride	
T-Spray II	Alkyl-dimethyl-benzyl-ammonium-chloride; Octyl-decyl-dimethyl-ammonium-chloride; Dioctyl-dimethyl-ammonium-chloride; Didecyl-dimethyl-ammonium-chloride	
Empower	Proteolytic enzymes	< 2%
Metrizyme	Proteolytic enzymes	< 2%
Neodisher MediClean forte	Trisodium ntrilotriacetate 2,2-Iminodiethanol diethanolamine	5-10% 1-2%
Hycolin	Alkyldimethylbenzylammonium chloride /Tetrasodium EDTA/ Alcohol ethoxylate	1-10%
Prolystica 2x conc.	Ethanollamine, Protease, Ethoxylated alcohol, Polyalkylene glycol, Glycerine	
Wip Anios Excel	Didecyldimethylammoniumchloride Amines, N-C12-14-Alkyltrimethylenedi	<2.5% <2.5%
Wip Anios Premium	Didecyldimethylammoniumchloride Polyhexamethylene Biguanide Hydrochloride	<2.5% <2.5%

Use the following instructions to clean the transducer and remove residues before disinfection. The transducer handle may be wiped with the wet pad.

1. Wear clean gloves to prevent infection.
2. Clean the transducer in mild soapy water.
3. Wipe the transducer with a gauze pad saturated in one of the compatible solutions.
4. Wash the transducer in lukewarm running water.
5. Wipe dry with a soft towel or air dry the transducer.

**⚠ WARNING:** To avoid injury to the patient, you must follow the manufacturer's recommendation for rinsing.

**⚠ CAUTION:**

1. To avoid damaging the transducer, the transducer should not be exposed to the disinfectant longer than specified to achieve the desired effect, but never longer than one hour.
2. To avoid damaging the transducer, do not steam autoclave or subject the transducer to Ethylene Oxide (ETO).
3. To avoid damaging the transducer, do not immerse the transducer in a solution containing ethanol.

## 4.2 Disinfections

Only the following disinfectants are recommended by Mindray to disinfect the TEE transducers. For the biological effectiveness and the correct use of the disinfectants, see the information of the disinfectants' manufacturer:

Disinfectant	Manufacturer	Active ingredient	Concentration
Cidex ADS	ASP J&J	Gluteraldehyde	2,55%
Cidex OPA	ASP J&J	Ortho-phthalaldehyde	0,55%
Gigasept AF	Schulke	Didecyldimethylammoniumchloride Glycine, aminoalkyl derivs Tridecylpolyethylenglycoether N-(3-Aminopropyl)-N-dodecylpropane-1,3-diamine	15% 6,9% 15-30% < 5%
Gigasept FF (neu)	Schulke	Dimethoxytetrahydrofurane Succindialdehyde Ethanol Methanol Alkylpolyethylenglykopolpolypropylenglycol-ether, 2-ethanol, 3,6-dioxa-1-dodecanol, 3,6-dioxadodecan-1-ol, DEGHE, diethylene glycol monohexyl ether, hexyl carbitol	3,2% 11,9% 5-15% 5-10% 1-5%
Gigasept PAA concentrate	Schulke	Peracetic Acid Hydrogen peroxide Acetic Acid	5% 10-20% 10-20%
Korsolex extra	Bode Chemie	Gluteraldehyde	5-10%
Metricide	Metrex	Gluteraldehyde	2,60%
Metricide 28	Metrex	Gluteraldehyde	2,50%
Metricide Plus 30	Metrex	Gluteraldehyde	3,40%
Metricide OPA Plus	Metrex	Ortho-phthalaldehyde	0,60%

NeoDisher Septo 3000	Dr.Weigert	Per 100gr: 15,2g glutardialdehyde 1,6-dihydroxy-2.5-dioxahehexan 19,7g	4%
Nu-Cidex	ASP J&J	Peracetic Acid Acetic Acid Hydrogen peroxide	0,30% 0,60% < 1,6%
Omnicide 14 N.S.	Coventry Chemicals	Gluteraldehyde	2,60%
Omnicide 28	Coventry Chemicals	Gluteraldehyde	2,50%
Perasafe	Dupont	Sodium Perborate	40-60%
Revital-Ox Resert XL HDL	Steris	Hydrogen Peroxide 2-Fluroic Acid	1.4-2.3 ≤2.50
Steranios 2%, 2% N.G., 2% E.C.S.	Laboratoires Anios	Gluteraldehyde	2,00%
TD100 & TD5	CS Medical	Gluteraldehyde	2,65%
Totacide 28	Coventry Chemicals	Gluteraldehyde	2,00%
Trigene Advance (incl. wipes) (1% solution)	Ethical Agents	C9-C11 alcohol ethoxylate Isopropanol Didecyl dimethyl ammonium chloride Polymeric biguanide hydrochloride Alkyl dimethylbenzylammonium chloride	5-8% 2-5% 2-5% 1-2% 0,5-1%
Tristel Trio Wipe System	Tristel	Propan-2-OL Polymeric Biguanide Hydrochloride 5-Chloro-2-Isothiazol-3-one 2-Methyl-2H-Isothiazol-3-O Chlorinedioxide Sodiumchlorite 100%	1-10% < 1% < 1% < 1% < 1%
Virkon	Dupont	Potassium peroxymonosulphate	< 50%
Wavicide 01	Medical Chemical Corp.	Gluteraldehyde	2,65%

Procedures:

1. Immerse the flexible shaft of the cleaned TE transducer in one of the recommended disinfectants for the time duration specified by the manufacturer. (Take care that only the distal end up to the 100cm marker is immersed.)  
The transducer handle may be wiped with the wet pad.
2. Thoroughly rinse the part of the transducer that was in contact with the disinfectant with water in a quantity recommended by the disinfectant manufacturer.
3. Wipe dry with a soft towel and air dry the transducer.



4. If residue is present after air drying, remove residue by wiping the transducer with a soft cloth moistened in an ethanol solution. Do not immerse the transducer in a solution containing ethanol.



**CAUTION:**

1. The lens may be discolored; the label on the transducer may fade. These are not abnormalities.
2. Repeated disinfection will eventually damage the transducer, please check the transducer's performance periodically, please refer to chapter 3.5.
3. Disinfecting or sterilizing incorrectly or with chemicals not recommended by Mindray will void the warranty.



**WARNING:**

To avoid injury to the patient, if residue from the disinfectant is not removed it can cause irritation and/or burning of the mouth and esophageal tissue.

# 5 Storage and Transportation

---

When all examinations for the day have been completed, confirm that the transducer is in good condition and store it in a suitable place so that the next examination can be conducted smoothly. Make sure the transducer is adequately cleaned and disinfected prior to storage.



## **CAUTION:**

**1. When transporting the transducer, do not allow any part of the transducer to protrude beyond the shipping case. Never store a moist TE transducer in the shipping case.**

**2. Use the tip cover to enclose and protect the distal end of the transducer from being damaged during transportation and storage.**

- To prevent the transducer from being damaged, do not store it in locations where it may be exposed to:
  - Direct sunlight or X-rays
  - Sudden changes in temperature
  - Dust
  - Excessive vibration
  - Heat generators
- Store and transport the P7-3T transducer under the following ambient conditions:
  - Ambient temperature: -20°C to 55°C
  - Relative humidity: 30% to 95% (no condensation)
  - Atmospheric pressure: 700 hPa to 1060 hPaStore and transport the P7-3TE transducer under the following ambient conditions:
  - Ambient temperature: -10°C to 45°C
  - Relative humidity: 30% to 90% (no condensation)
  - Atmospheric pressure: 700 hPa to 1060 hPaStore and transport the P7-3TU/P7-3Ts transducer under the following ambient conditions:
  - Ambient temperature: -10°C to 45°C
  - Relative humidity: 30% to 90% (no condensation)
  - Atmospheric pressure: 700 hPa to 1060 hPa

- When the transducer is sent to MINDRAY Customer Service Department or sales representative for repair, be sure to disinfect it and keep it in the original carrying/shipping case to prevent infection.
- Sterilize the carrying case as necessary.
- Tip cover. The tip cover encloses and protects the distal end/scanhead of the endoscope from being exposed to mechanical strain during transportation and storage.



**CAUTION:**

**To avoid damaging the transducer, the tip cover is a single use device. Discard after use.**

# 6 Specifications

---

The specifications of this transducer are listed below.

- Mechanical dimensions
  - Shaft external diameter: 11 mm
  - Shaft length: 100 cm
  - Transducer tip width: 14 mm
  - Transducer tip height: 10.3 mm
  - Length of the inflexible distal part of the transducer tip: 41 mm
- Transducer
  - Center frequency: 5.0 MHz
  - Type: phased array
  - Number of elements: 64
  - Aperture: 9 mm
  - Focus: 50 mm
  - Scanplane rotation: minimum 180°
- Temperature precision
  - Temperature range: 17.5~50°C, precision:  $\pm 1^{\circ}\text{C}$ , of which, when the temperature is 43°C, the precision is  $\pm 0.5^{\circ}\text{C}$ .
- Tip deflection
  - Up:  $120^{\circ} \pm 10^{\circ}$
  - Down:  $90^{\circ} \pm 10^{\circ}$
  - Left:  $45^{\circ} \pm 10^{\circ}$
  - Right:  $45^{\circ} \pm 10^{\circ}$
- Leakage current / Dielectric strength
  - Meet the requirements of IEC 60601.
- Biocompatibility
  - All external materials of the multiplane TE Transducer have passed relevant biocompatibility tests according to ISO 10993.

