

BeneVision N22/BeneVision N19

BeneVision N17/BeneVision N15/BeneVision N12

Patient Monitor

Operator's Manual

© Copyright 2017-2022 Shenzhen Mindray Bio-Medical Electronics Co., Ltd. All rights reserved.

Release time: July 2022

Revision: 6.0

WARNING

- **Federal Law (USA) restricts this device to sale by or on the order of a physician or other practitioner licensed by U.S. state law to use or order the use of this device.**
-
-

Intellectual Property Statement

SHENZHEN MINDRAY BIO-MEDICAL ELECTRONICS CO., LTD. (hereinafter called Mindray) owns the intellectual property rights to this Mindray product and this manual. This manual may refer to information protected by copyright or patents and does not convey any license under the patent rights or copyright of Mindray, or of others.

Mindray intends to maintain the contents of this manual as confidential information. Disclosure of the information in this manual in any manner whatsoever without the written permission of Mindray is strictly forbidden.

Release, amendment, reproduction, distribution, rental, adaptation, translation or any other derivative work of this manual in any manner whatsoever without the written permission of Mindray is strictly forbidden.

mindray is the trademark, registered or otherwise, of Mindray in China and other countries. All other trademarks that appear in this manual are used only for informational or editorial purposes. They are the property of their respective owners.

This posting serves as notice under 35 U.S.C. §287(a) for Mindray patents: <http://www.mindrayna.com/patents>.

Manufacturer's Responsibility

Contents of this manual are subject to changes without prior notice.

Mindray is responsible for the effects on safety, reliability and performance of this product, only if:

- all installation operations, expansions, changes, modifications and repairs of this product are conducted by Mindray authorized personnel;
- the electrical installation of the relevant room complies with the applicable national and local requirements;
- the product is used in accordance with the instructions for use.

WARNING

- **Only skilled/trained clinical professionals should operate this equipment.**
 - **It is important for the hospital or organization that uses this equipment to perform a recommended service/maintenance plan. Neglect of this may result in machine breakdown or personal injury.**
-
-

Service

Mindray maintains a network of service representatives and factory-trained distributors. Prior to requesting service, perform a complete operational check of the instrument to verify proper control settings. If operational problems continue to exist, contact Mindray service.

In North America contact the Service Department at (800) 288-2121, ext: 8116 for Technical Support or (201) 995-8000 for assistance in determining the nearest field service location.

Please include the instrument model number, the serial number, and a description of the problem with all requests for service.

Any questions regarding the warranty should be directed to the local sales or service representative.

Company Contact

Manufacturer: Shenzhen Mindray Bio-Medical Electronics Co., Ltd.
Address: Mindray Building, Keji 12th Road South, High-tech Industrial Park, Nanshan, Shenzhen 518057, P.R.China
Website: www.mindray.com
E-mail Address: service@mindray.com
Tel: +86 755 81888998
Fax: +86 755 26582680

Distributor: Mindray DS USA, Inc.
Address: 800 MacArthur Boulevard, Mahwah, New Jersey, 07430 USA
Tel: 1.800.288.2121, 1.201.995.8000
Website: www.mindray.com

Preface

Manual Purpose

This manual contains the instructions necessary to operate the product safely and in accordance with its function and intended use. Observance of this manual is a prerequisite for proper product performance and correct operation and ensures patient and operator safety.

This manual is based on the maximum configuration and therefore some contents may not apply to the product. If you have any question, please contact Mindray.

This manual is an integral part of the product. It should always be kept close to the equipment so that it can be obtained conveniently when needed.

Intended Audience

This manual is geared for clinical professionals who are expected to have a working knowledge of medical procedures, practices and terminology as required for monitoring of patients.

Illustrations

All illustrations in this manual serve as examples only. They may not necessarily reflect the setup or data displayed on the patient monitor.

Conventions

- ***Italic text*** is used in this manual to quote the referenced manuals, chapters, sections and formulas.
- **Bold text** is used to indicate the screen texts and names of hard keys.
- → is used to indicate operational procedures.

Contents

1 Safety	1 - 1
1.1 Safety Information	1 - 1
1.1.1 Warnings	1 - 1
1.1.2 Cautions	1 - 2
1.1.3 Notes	1 - 2
1.2 Equipment Symbols	1 - 3
2 Equipment Introduction	2 - 1
2.1 Indications for Use	2 - 1
2.2 Applied Parts	2 - 1
2.3 System Components	2 - 1
2.3.1 N22, N19 Main Unit	2 - 2
2.3.2 N22, N19 Displays	2 - 4
2.3.3 N17, N15, N12 Main Unit	2 - 7
2.3.4 Satellite Module Rack (SMR)	2 - 12
2.3.5 External Modules	2 - 12
2.3.6 Cable Management Kit	2 - 15
2.3.7 Input Devices	2 - 15
2.3.8 Printing Devices	2 - 16
3 Getting Started	3 - 1
3.1 Equipment Preparation Safety Information	3 - 1
3.2 Monitor Installation	3 - 1
3.2.1 Unpacking and Checking	3 - 2
3.2.2 Environmental Requirements	3 - 2
3.3 Setting Up the Equipment	3 - 2
3.3.1 Connecting the AC Mains	3 - 2
3.3.2 Connecting the Input Devices	3 - 3
3.3.3 Connecting the SMR	3 - 3
3.3.4 Connecting Modules to the SMR	3 - 3
3.3.5 Removing Modules from the SMR	3 - 3
3.4 Turning on the Monitor	3 - 4
3.5 Operation and Navigation	3 - 4
3.5.1 Using the Touchscreen	3 - 4
3.5.2 Using the On-Screen Keyboard	3 - 5
3.5.3 Using the Navigation Knob (for N22/N19)	3 - 5
3.5.4 Using the Barcode Reader	3 - 5
3.5.5 Using the Remote Controller	3 - 5
3.6 Screen Display	3 - 5
3.6.1 On-screen Symbols	3 - 6
3.6.2 Dialogs	3 - 7
3.6.3 Quick Keys	3 - 8
3.7 Operating Modes	3 - 10
3.7.1 Monitoring Mode	3 - 10
3.7.2 Privacy Mode	3 - 10

3.7.3 Night Mode	3 - 11
3.7.4 Standby Mode	3 - 12
3.7.5 Discharge Mode	3 - 12
3.8 Configuring the Monitor	3 - 12
3.8.1 Setting the Screen Orientation (for N22 and N19)	3 - 13
3.8.2 Setting the Date and Time	3 - 13
3.8.3 Adjusting the Screen Brightness	3 - 13
3.8.4 Adjusting the Volume	3 - 13
3.9 General Operation	3 - 14
3.9.1 Switching On or Off a Parameter	3 - 14
3.9.2 Displaying Parameter Numerics and Waveforms	3 - 14
3.9.3 Displaying the Parameter List	3 - 14
3.9.4 Accessing Parameter Setup Dialogs	3 - 14
3.9.5 Changing Measurement Colors	3 - 15
3.10 Freezing Waveforms	3 - 15
3.10.1 Freezing Waveforms	3 - 15
3.10.2 Viewing Frozen Waveforms	3 - 15
3.10.3 Unfreezing Waveforms	3 - 15
3.10.4 Printing Frozen Waveforms	3 - 15
3.11 N22 and N19 Secondary Display	3 - 16
3.11.1 Connecting the Secondary Display Power Supply (for N22/N19)	3 - 16
3.11.2 Setting the ECG Waveform Size for the Independent External Display (for N17/N15/N12)	3 - 16
3.12 Using the iView System	3 - 17
3.13 Capturing the Screen	3 - 17
3.14 Connecting the CMS	3 - 18
3.15 Connecting the eGateway	3 - 18
3.16 Connecting the Wireless Network	3 - 18
3.17 Disconnecting the Wireless Network	3 - 18
3.18 Turning Off the Monitor	3 - 19
4 User Screens	4 - 1
4.1 Choosing a Screen	4 - 1
4.2 Normal Screen	4 - 1
4.2.1 Entering the Normal Screen	4 - 1
4.2.2 Configuring the Normal Screen	4 - 1
4.3 The Big Numerics Screen	4 - 1
4.3.1 Entering the Big Numerics Screen	4 - 1
4.3.2 Configuring the Big Numerics Screen	4 - 2
4.4 Minitrends Screen	4 - 2
4.4.1 Entering the Minitrends Screen	4 - 2
4.4.2 The Display of Minitrends Screen	4 - 3
4.4.3 Viewing the Long Trends	4 - 3
4.4.4 Setting Minitrends Parameters	4 - 3
4.4.5 Setting the Minitrend Length	4 - 3
4.4.6 Setting the Alarm Statistics Switch	4 - 4
4.4.7 Setting the Alarm Statistics Duration	4 - 4
4.4.8 Routine Vital/Baseline	4 - 4

4.5 The OxyCRG Screen	4 - 4
4.5.1 Entering the OxyCRG Screen	4 - 4
4.5.2 The Display of the OxyCRG Screen	4 - 5
4.5.3 OxyCRG Events	4 - 5
4.5.4 The Display of the ABD Event Area	4 - 6
4.5.5 Setting OxyCRG Parameters	4 - 6
4.5.6 Setting the Threshold of ABD Events	4 - 6
4.5.7 Editing ABD Events	4 - 6
4.6 The Targeted Goal Screen	4 - 6
4.6.1 Entering the Targeted Goal Screen	4 - 6
4.6.2 The Display of the Targeted Goal Screen	4 - 6
4.6.3 Configuring the Targeted Goal Screen Layout	4 - 7
4.6.4 Operating the Targeted Goal Screen	4 - 7
4.7 Remote View	4 - 8
4.7.1 Entering the Remote View Screen	4 - 8
4.7.2 About the Remote View	4 - 8
4.7.3 Adding a Bed	4 - 9
4.7.4 Removing a Bed	4 - 9
4.7.5 Displaying the Main Bed	4 - 9
4.7.6 Saving a Manual Event	4 - 9
4.7.7 Managing Alarms from Remote Devices	4 - 9
4.7.8 Resetting Alarms for Remote Devices	4 - 10
4.7.9 Selecting Beds By Care Group	4 - 10
4.7.10 Alarm Watch	4 - 10
4.7.11 Auto Displaying the Alarm Bed	4 - 11
5 Managing Patients	5 - 1
5.1 Starting Monitoring a Patient	5 - 1
5.2 Admitting a Patient	5 - 1
5.2.1 Entering the Patient Management Dialog	5 - 1
5.2.2 Editing Patient Information	5 - 1
5.2.3 Loading Patient Information from the CMS	5 - 2
5.2.4 Loading Patient Information from the ADT Server	5 - 2
5.3 Transferring Patient	5 - 3
5.3.1 Data Storage Introduction	5 - 3
5.3.2 Transferring Patient Data	5 - 4
5.4 Exporting Patient Data	5 - 4
5.5 Deleting Patient Data	5 - 4
5.6 Stopping a Parameter Measurement	5 - 5
5.7 Discharging a Patient	5 - 5
6 Interfacing with External Devices	6 - 1
6.1 BeneLink Introduction	6 - 1
6.2 BeneLink Safety Information	6 - 1
6.3 Differences in Displayed Values	6 - 2
6.4 Connecting an External Device	6 - 2
6.5 Accessing the Integrated Devices Screen	6 - 3
6.6 Displaying Parameters from External Devices	6 - 4

6.6.1	Setting Waveform Properties for Parameters from External Devices	6 - 4
6.6.2	Setting Alarms from External Devices	6 - 5
6.6.3	Setting Parameters from External Devices for Display	6 - 5
6.6.4	Setting Units for Parameters from External Devices	6 - 5
6.6.5	Accessing the Loops Screen	6 - 5
6.7	Viewing Alarms from External Devices	6 - 5
6.8	Viewing Parameter Trends from External Devices	6 - 6
6.9	Recording and Printing Parameter Trends from External Devices	6 - 6
7	Using with the Telemetry Monitor	7 - 1
7.1	Introduction	7 - 1
7.1.1	Pairing Procedure	7 - 1
7.2	Binding the Telemetry with the Monitor	7 - 2
7.3	Unpairing the Telemetry and the Monitor	7 - 2
7.3.1	Unpairing the Telemetry and the Monitor via the Monitor	7 - 2
7.3.2	Unpairing the Telemetry and the Monitor via the telemetry	7 - 2
7.4	Troubleshooting	7 - 3
8	Alarms	8 - 1
8.1	Alarm Introduction	8 - 1
8.2	Alarm Safety Information	8 - 1
8.3	Understanding the Alarms	8 - 1
8.3.1	Alarm Categories	8 - 1
8.3.2	Alarm Priorities	8 - 1
8.3.3	Alarm Indicators	8 - 2
8.3.4	Alarm Status Symbols	8 - 3
8.4	Accessing On-screen Help for Technical Alarms (AlarmSight)	8 - 3
8.5	Checking the Physiological Alarms List	8 - 3
8.6	Changing Alarm Settings	8 - 3
8.6.1	Setting Parameter Alarm Properties	8 - 3
8.6.2	Changing the Alarm Volume	8 - 4
8.6.3	Setting the Auto Limits for New Patient Switch	8 - 5
8.6.4	Initiating Auto Alarm Limits	8 - 5
8.6.5	Setting the Apnea Delay Time	8 - 8
8.6.6	Switching On or Off V-Tach Latching	8 - 8
8.6.7	Restoring the Default Alarm Settings	8 - 8
8.6.8	Setting the Length of Printed Waveforms	8 - 8
8.7	Pausing Alarms/Pausing Alarm Tones	8 - 8
8.7.1	Pausing Alarms	8 - 8
8.7.2	Pausing Alarm Sound	8 - 9
8.8	Resetting Alarms	8 - 10
8.8.1	Resetting Physiological Alarms	8 - 10
8.8.2	Resetting Technical Alarms	8 - 10
8.9	Latching Alarms	8 - 10
8.10	Nurse Call	8 - 11
8.11	Calling for Help	8 - 11
8.11.1	Issuing the Call Help Signal	8 - 11

8.12 CPB Mode	8 - 11
8.12.1 Entering the CPB Mode	8 - 11
8.12.2 Exiting the CPB Mode	8 - 12
8.13 Intubation Mode	8 - 12
8.13.1 Entering the Intubation Mode	8 - 12
8.13.2 Exiting the Intubation Mode	8 - 12
8.14 Testing Alarms	8 - 12
9 Monitoring ECG, Arrhythmia, ST and QT	9 - 1
9.1 ECG Introduction	9 - 1
9.2 ECG Safety Information	9 - 1
9.3 ECG Display	9 - 2
9.4 Preparing for ECG Monitoring	9 - 2
9.4.1 Preparing the Patient Skin	9 - 2
9.4.2 Applying Electrodes and Connecting the Patient	9 - 2
9.4.3 Lead Wire Color Code	9 - 3
9.4.4 ECG Electrode Placements	9 - 3
9.4.5 Choosing the ECG Lead Type	9 - 6
9.4.6 Checking Paced Status	9 - 6
9.4.7 Enabling Pacer Rejection	9 - 6
9.5 Changing ECG Settings	9 - 7
9.5.1 Choosing an ECG Screen	9 - 7
9.5.2 Setting ECG Alarm Properties	9 - 7
9.5.3 Changing ECG Wave Settings	9 - 7
9.5.4 Disabling the Smart Lead Off Function	9 - 9
9.5.5 Adjusting the QRS Volume	9 - 9
9.5.6 Adjusting the Minimum QRS Detection Threshold	9 - 9
9.6 Monitoring Arrhythmia	9 - 10
9.6.1 Arrhythmia Safety Information	9 - 10
9.6.2 Arrhythmia Events	9 - 10
9.6.3 Displaying Arrhythmia Information	9 - 11
9.6.4 Changing Arrhythmia Settings	9 - 11
9.6.5 Intelligent Arrhythmia Alarm	9 - 13
9.7 ST Segment Monitoring	9 - 15
9.7.1 ST Safety Information	9 - 15
9.7.2 Enabling ST Monitoring	9 - 15
9.7.3 Displaying ST Deviation Numerics	9 - 15
9.7.4 Displaying ST Segments in the Waveform Area	9 - 16
9.7.5 Entering the ST View	9 - 17
9.7.6 Saving the Current ST Deviation and Segment as Baseline	9 - 17
9.7.7 Entering the ST Graphic	9 - 18
9.7.8 Changing ST Settings	9 - 18
9.7.9 Adjusting ST Measurement Points	9 - 19
9.8 QT/QTc Interval Monitoring	9 - 20
9.8.1 QT/QTc Monitoring Limitations	9 - 20
9.8.2 Enabling QT/QTc Monitoring	9 - 20
9.8.3 Displaying QT Numerics and Segments	9 - 21
9.8.4 Entering the QT View	9 - 21
9.8.5 Saving the Current QTc as Baseline	9 - 22

9.8.6 Changing QT Settings	9 - 22
9.9 ECG Relearning	9 - 22
9.9.1 Auto ECG Relearning	9 - 22
9.9.2 Initiating an ECG Relearning Manually	9 - 23
9.10 Defibrillation Synchronization Pulse Output	9 - 23
9.11 ECG Troubleshooting	9 - 23
10 Resting 12-Lead ECG Analysis	10 - 1
10.1 Resting 12-Lead ECG Analysis Introduction	10 - 1
10.2 Entering the 12-Lead Screen	10 - 1
10.3 Initiating Resting 12-Lead ECG Analysis	10 - 1
10.4 Changing 12-Lead ECG Analysis Settings	10 - 1
10.4.1 Setting the High Frequency Filter	10 - 1
10.4.2 Setting the Baseline Drift Removal Filter	10 - 1
10.4.3 Setting the 12-Lead Waveform Layout	10 - 2
10.4.4 Editing Patient Information	10 - 2
10.4.5 Setting Tachycardia and Bradycardia Thresholds	10 - 2
10.4.6 Setting the 12-Lead Interpretation Report	10 - 3
10.5 Saving the 12-Lead Interpretation Report	10 - 3
10.6 Printing the 12-Lead Interpretation Report	10 - 3
10.7 Exiting the ECG 12-Lead Screen	10 - 3
11 Monitoring Impedance Respiration (Resp)	11 - 1
11.1 Resp Introduction	11 - 1
11.2 Impedance Resp Safety Information	11 - 1
11.3 Resp Display	11 - 2
11.4 Preparing for Impedance Resp Monitoring	11 - 2
11.4.1 Preparing the Patient	11 - 2
11.4.2 Placing the Electrodes	11 - 3
11.5 Changing Resp Settings	11 - 4
11.5.1 Setting the Resp Alarm Properties	11 - 4
11.5.2 Setting the RR Source	11 - 4
11.5.3 Choosing the Respiration Lead	11 - 4
11.5.4 Setting the Resp Waveform Size	11 - 4
11.5.5 Setting the Resp Waveform Speed	11 - 4
11.5.6 Setting the Auto Detection Switch	11 - 5
11.5.7 Adjusting the Resp Waveform Detection Threshold	11 - 5
12 Monitoring Pulse Oxygen Saturation (SpO₂)	12 - 1
12.1 SpO ₂ Introduction	12 - 1
12.2 SpO ₂ Safety Information	12 - 2
12.3 SpO ₂ Measurement Limitations	12 - 3
12.4 SpO ₂ Display	12 - 4
12.5 Preparing for SpO ₂ Monitoring	12 - 4
12.6 Changing the SpO ₂ Settings	12 - 5
12.6.1 Changing the SpO ₂ Alarm Settings	12 - 5
12.6.2 Nellcor SatSeconds™ Alarm Management	12 - 5

12.6.3 Setting SpO ₂ Sensitivity (for Masimo SpO ₂)	12 - 6
12.6.4 Enabling FastSAT (for Masimo SpO ₂)	12 - 7
12.6.5 Displaying SIQ (for Masimo SpO ₂)	12 - 7
12.6.6 Changing Averaging Time (for Masimo SpO ₂)	12 - 7
12.6.7 Monitoring SpO ₂ and NIBP Simultaneously	12 - 8
12.6.8 Changing the Sweep Speed of the Pleth Waveform	12 - 8
12.7 Changing the PR Settings	12 - 8
12.7.1 Changing the PR Alarm Settings	12 - 8
12.7.2 Changing the QRS Volume	12 - 8
12.7.3 Setting the PR Source	12 - 8
12.7.4 Showing/Hiding PR	12 - 9
12.8 Displaying SpO ₂ Statistics	12 - 9
12.8.1 Selecting the Range of each SpO ₂ Section and the Target Section	12 - 9
12.8.2 Selecting the SpO ₂ Statistics Length	12 - 9
12.9 SpO ₂ Troubleshooting	12 - 10
12.10 Nellcor Information	12 - 10
12.11 Masimo Information	12 - 11
12.12 Masimo End-User License Agreement	12 - 11
13 Monitoring Temperature (Temp)	13 - 1
13.1 Temperature Introduction	13 - 1
13.2 Temperature Safety Information	13 - 1
13.3 Temperature Display	13 - 1
13.4 Preparing for Temperature Monitoring	13 - 2
13.5 Changing Temperature Settings	13 - 2
13.5.1 Setting the Temperature Alarm Properties	13 - 2
13.5.2 Selecting the Temperature Label	13 - 2
13.5.3 Displaying the Temperature Difference	13 - 2
13.6 Temperature Troubleshooting	13 - 3
14 Monitoring Noninvasive Blood Pressure (NIBP)	14 - 1
14.1 NIBP Introduction	14 - 1
14.2 NIBP Safety Information	14 - 1
14.3 NIBP Measurement Limitations	14 - 2
14.4 Measurement Modes	14 - 2
14.5 NIBP Display	14 - 3
14.6 Preparing for NIBP Measurements	14 - 3
14.6.1 Preparing the Patient for NIBP Measurements	14 - 3
14.6.2 Placing the NIBP Cuff	14 - 4
14.7 Starting and Stopping NIBP Measurements	14 - 4
14.8 Changing NIBP Settings	14 - 5
14.8.1 Setting the NIBP Alarm Properties	14 - 5
14.8.2 Setting the Initial Cuff Inflation Pressure	14 - 5
14.8.3 Setting the NIBP Interval	14 - 5
14.8.4 Selecting NIBP Start Mode	14 - 5
14.8.5 Enabling the NIBP End Tone	14 - 6
14.8.6 Setting NIBP Sequence	14 - 6

14.8.7 Setting the NIBP Display Format	14 - 6
14.8.8 Setting the NIBP Alarm Limits Display Switch	14 - 6
14.8.9 Showing/Hiding PR	14 - 6
14.8.10 Correcting the NIBP Measurements	14 - 6
14.9 Assisting Venous Puncture	14 - 6
14.10 NIBP Troubleshooting	14 - 7
15 Monitoring Invasive Blood Pressure (IBP)	15 - 1
15.1 IBP Introduction	15 - 1
15.2 IBP Safety Information	15 - 1
15.3 Preparing for IBP Monitoring	15 - 2
15.3.1 IBP Equipment to Patient Connection	15 - 2
15.3.2 Measuring an Invasive Blood Pressure	15 - 2
15.3.3 Zeroing the IBP transducer	15 - 3
15.4 Measuring ICP Using the Codman ICP Transducer	15 - 3
15.4.1 Zeroing the Codman ICP transducer	15 - 3
15.4.2 Measuring ICP	15 - 4
15.5 IBP Display	15 - 4
15.5.1 Overlapping IBP Waveforms	15 - 5
15.6 Changing IBP Settings	15 - 5
15.6.1 Changing the IBP Alarm Settings	15 - 5
15.6.2 Changing the Pressure Label	15 - 5
15.6.3 Setting the Pressure Type for Display	15 - 6
15.6.4 Changing the Sensitivity	15 - 6
15.6.5 Setting the IBP Waveform	15 - 6
15.6.6 Setting the Display Format of Artery Pressure	15 - 7
15.6.7 Showing/Hiding the Alarm Limits of Artery Pressure	15 - 7
15.6.8 Setting the Use PA-D as PAWP Switch	15 - 7
15.6.9 Enabling PPV Measurement	15 - 7
15.7 PAWP	15 - 8
15.7.1 PAWP Equipment to Patient Connection	15 - 8
15.7.2 Preparing to Measure PAWP	15 - 8
15.7.3 Measuring PAWP	15 - 9
15.7.4 Setting the Waveforms of the PAWP Screen	15 - 10
15.7.5 Performing Hemodynamic Calculation	15 - 10
15.8 Connecting a Camino Device	15 - 10
15.9 IBP Troubleshooting	15 - 11
16 Monitoring Cardiac Output (C.O.)	16 - 1
16.1 C.O. Introduction	16 - 1
16.2 C.O. Safety Information	16 - 1
16.3 C.O. Measurement Limitations	16 - 2
16.4 C.O. Display	16 - 2
16.5 C.O. Equipment to Patient Connection	16 - 3
16.6 Performing C.O. Measurement	16 - 3
16.6.1 Preparing for C.O. Measurement	16 - 3
16.6.2 Setting C.O. Measurement	16 - 3
16.6.3 Performing C.O. Measurement	16 - 4

16.7 Changing C.O. Settings	16 - 5
16.7.1 Setting C.O. Alarm Properties	16 - 5
16.8 C.O. Troubleshooting	16 - 5
17 Monitoring Central Venous Oxygen Saturation (ScvO₂)	17 - 1
17.1 ScvO ₂ Introduction	17 - 1
17.2 ScvO ₂ Safety Information	17 - 1
17.3 ScvO ₂ Display	17 - 1
17.4 Accessing the On-screen ScvO ₂ Guide	17 - 2
17.5 ScvO ₂ Equipment to Patient Connection	17 - 2
17.6 Measuring ScvO ₂	17 - 2
17.7 ScvO ₂ Calibration	17 - 3
17.8 Accessing the HemoSight Dialog	17 - 3
17.9 Changing ScvO ₂ Settings	17 - 3
17.9.1 Changing ScvO ₂ Alarm Settings	17 - 3
17.9.2 Setting Hb or Hct	17 - 3
17.9.3 Inputting the SaO ₂ Value	17 - 4
18 Monitoring CCO/SvO₂	18 - 1
18.1 CCO/SvO ₂ Introduction	18 - 1
18.2 CCO/SvO ₂ Safety Information	18 - 2
18.3 Connecting the Device	18 - 2
18.3.1 CCO/SvO ₂ Cable	18 - 2
18.3.2 Connecting to the Vigilance II Monitor	18 - 2
18.3.3 Connecting to the Vigileo Monitor	18 - 4
18.3.4 Connecting the EV1000 Monitor	18 - 5
18.3.5 Connecting the HemoSphere Monitor	18 - 5
18.4 Accessing the HemoSight dialog	18 - 6
18.5 Changing CCO Settings	18 - 6
18.5.1 Changing the CCO Alarm Settings	18 - 6
18.5.2 Setting Parameters for Display	18 - 6
18.5.3 Setting the CCO Analog Output Signal	18 - 7
18.6 Changing SvO ₂ /ScvO ₂ Settings	18 - 7
18.6.1 Changing the SvO ₂ /ScvO ₂ Alarm Settings	18 - 7
18.6.2 Setting the SvO ₂ /ScvO ₂ Analog Output Signal	18 - 8
18.7 CCO/SvO ₂ Troubleshooting	18 - 9
19 Monitoring Carbon Dioxide (CO₂)	19 - 1
19.1 CO ₂ Introduction	19 - 1
19.2 Identifying CO ₂ Modules	19 - 1
19.3 CO ₂ Safety Information	19 - 2
19.4 CO ₂ Measurement Limitations	19 - 2
19.5 CO ₂ Display	19 - 2
19.6 Measuring CO ₂ Using the Sidestream/Microstream CO ₂ Module	19 - 3
19.6.1 Preparing to Measure CO ₂ Using the Sidestream CO ₂ Module	19 - 3
19.6.2 Preparing to Measure CO ₂ Using the Microstream CO ₂ Module	19 - 4

19.6.3 Zeroing the Sidestream/Microstream CO ₂ Module	19 - 5
19.7 Changing Settings for All CO ₂ Modules	19 - 6
19.7.1 Changing CO ₂ Alarm Settings	19 - 6
19.7.2 Setting the CO ₂ Waveform	19 - 6
19.7.3 Setting the RR Source	19 - 6
19.7.4 Entering the Standby Mode	19 - 6
19.7.5 Entering the Intubation Mode	19 - 6
19.7.6 Setting the Auto Standby	19 - 7
19.7.7 Setting Humidity Compensation	19 - 7
19.8 Changing O ₂ Settings (For Sidestream CO ₂ Module Integrating O ₂)	19 - 7
19.8.1 Changing O ₂ Alarm Settings	19 - 7
19.8.2 Setting the O ₂ Waveform	19 - 7
19.9 Setting the Gas Compensation	19 - 8
19.10 Choosing a Time Interval for Peak-Picking	19 - 8
19.11 Performing the Leakage Test	19 - 8
19.12 CO ₂ Calibration	19 - 8
19.13 Test Method Used to Determine the Respiration Rate Measuring Range	19 - 9
19.14 CO ₂ Troubleshooting	19 - 9
19.14.1 Troubleshooting the Sidestream/Microstream CO ₂ Module	19 - 9
19.15 Oridion Information	19 - 9
20 Monitoring Anesthetic Gas (AG)	20 - 1
20.1 AG Introduction	20 - 1
20.2 AG Safety Information	20 - 2
20.3 AG Measurement Limitations	20 - 2
20.4 AG Display	20 - 3
20.5 AG Equipment to Patient Connection	20 - 3
20.6 Preparing for AG Monitoring	20 - 4
20.7 Zeroing the AG Module	20 - 4
20.8 MAC Values	20 - 5
20.9 Changing AG Settings	20 - 6
20.9.1 Changing AG Alarm Settings	20 - 6
20.9.2 Setting the O ₂ Compensation	20 - 6
20.9.3 Entering the Standby Mode	20 - 6
20.9.4 Setting Auto Standby	20 - 6
20.9.5 Setting the Gas Waveform	20 - 7
20.9.6 Setting the RR Source	20 - 7
20.9.7 Entering the Intubation Mode	20 - 7
20.9.8 Enabling or Disabling MAC Display	20 - 7
20.10 Changing the Anesthetic Agent	20 - 7
20.11 Performing AG Leakage Test	20 - 8
20.12 Calibrating the AG Module	20 - 8
20.13 AG Troubleshooting	20 - 8
21 Monitoring Respiratory Mechanics (RM)	21 - 1
21.1 RM Introduction	21 - 1

21.2 RM Safety Information	21 - 1
21.3 RM Parameters	21 - 1
21.4 RM Display	21 - 2
21.5 RM Equipment to Patient Connection	21 - 3
21.6 Preparing for RM Monitoring	21 - 3
21.7 Respiratory Loops	21 - 4
21.7.1 Changing the Loop Type	21 - 5
21.7.2 Saving the Loop as Reference	21 - 5
21.7.3 Displaying the Reference Loop	21 - 5
21.7.4 Adjusting the Loop Scale	21 - 5
21.7.5 Selecting the Parameters for Display	21 - 5
21.8 Changing RM Settings	21 - 5
21.8.1 Changing RM Alarm Settings	21 - 5
21.8.2 Setting the Apnea Alarm Delay	21 - 5
21.8.3 Setting RR Source	21 - 6
21.8.4 Changing the Wave Sweep Speed	21 - 6
21.8.5 Changing the Wave Scale	21 - 6
21.8.6 Setting the Ambient Temperature	21 - 6
21.8.7 Setting the Ambient Humidity	21 - 6
21.8.8 Setting Parameters for Display	21 - 6
21.8.9 Entering the Intubation Mode	21 - 7
21.9 VCO ₂ and Metabolic Monitoring	21 - 7
21.9.1 VCO ₂ and Metabolic Parameters	21 - 7
21.9.2 Safety Information When RM Module in Use with CO ₂ or AG Module	21 - 7
21.9.3 Measurement Limitations When RM Module in Use with CO ₂ or AG Module	21 - 8
21.9.4 Equipment to Patient Connection When RM Module in Use with CO ₂ or AG Module	21 - 8
21.9.5 Displaying the VCO ₂ and EE Numerics Areas	21 - 8
21.9.6 Preparing for VCO ₂ and Metabolic Monitoring	21 - 9
21.10 RM Troubleshooting	21 - 9
22 Monitoring Electroencephalogram (EEG)	22 - 1
22.1 EEG Introduction	22 - 1
22.2 EEG Safety Information	22 - 1
22.3 EEG Parameters	22 - 2
22.4 EEG Display	22 - 2
22.5 Accessing the On-screen EEG Guide	22 - 3
22.6 Prepare for EEG Monitoring	22 - 3
22.6.1 EEG Equipment to Patient Connection	22 - 3
22.6.2 Choosing an EEG Electrode Montage	22 - 4
22.6.3 Attaching EEG Electrodes	22 - 5
22.7 Performing EEG Sensor Check	22 - 6
22.7.1 Setting the Interval of Auto Sensor Check	22 - 6
22.7.2 Displaying/Hiding Impedance Value	22 - 6
22.7.3 Manually Starting a Sensor Check	22 - 7
22.7.4 EEG Electrode Status	22 - 7
22.7.5 Stopping Sensor Check	22 - 7
22.8 Changing EEG Settings	22 - 7

22.8.1 Changing the EEG Scale	22 - 7
22.8.2 Changing the EEG Sweep Speed	22 - 8
22.8.3 Changing the High/Low Filter	22 - 8
22.8.4 Switching Off the Notch Filter	22 - 8
22.8.5 Changing Displayed EEG Parameters	22 - 8
22.9 Displaying the EEG Expand View	22 - 8
22.9.1 CSA View	22 - 9
22.9.2 DSA View	22 - 9
22.10 EEG Troubleshooting	22 - 11
23 Monitoring Bispectral Index (BIS)	23 - 1
23.1 BIS Introduction	23 - 1
23.2 BIS Safety Information	23 - 2
23.3 BIS Parameters	23 - 3
23.4 BIS Display	23 - 4
23.5 Accessing the On-screen BIS Guide	23 - 4
23.6 Preparing for BIS Monitoring	23 - 5
23.7 Changing BIS Settings	23 - 6
23.7.1 Setting BIS Alarm Properties	23 - 6
23.7.2 Choosing the BIS Smoothing Rate	23 - 6
23.7.3 Setting the Display of BIS Waveform Area	23 - 6
23.7.4 Switching the Filter On or Off	23 - 6
23.7.5 Setting the Displayed BIS Parameters	23 - 6
23.8 Sensor Check	23 - 7
23.8.1 Automatic Sensor Check	23 - 7
23.8.2 Disabling automatic sensor check	23 - 7
23.8.3 Manual Sensor Check	23 - 7
23.8.4 BIS Sensor Status	23 - 8
23.9 Monitoring Bilateral BIS	23 - 8
23.9.1 Entering the BIS Expand View	23 - 8
23.9.2 Selecting BIS Expand View Display	23 - 8
23.10 BIS Troubleshooting	23 - 10
23.11 Covidien Information	23 - 10
24 Monitoring Neuromuscular Transmission (NMT)	24 - 1
24.1 NMT Introduction	24 - 1
24.2 NMT Safety Information	24 - 1
24.3 Stimulation Modes	24 - 2
24.3.1 Train-Of-Four (TOF)	24 - 2
24.3.2 Single Twitch (ST)	24 - 2
24.3.3 Post-Tetanic Count (PTC)	24 - 2
24.3.4 Double Burst Stimulation (DBS)	24 - 3
24.4 NMT Parameters	24 - 3
24.5 NMT Display	24 - 3
24.6 Accessing the On-screen NMT Guide	24 - 4
24.7 Preparing for NMT Monitoring	24 - 4
24.7.1 NMT Equipment to Patient Connection	24 - 4

24.7.2 Preparing the Skin	24 - 5
24.7.3 Placing the Electrodes and Sensor	24 - 5
24.8 Calibrating the NMT Measurement	24 - 6
24.8.1 Setting the Calibration Current	24 - 6
24.8.2 Starting NMT Calibration	24 - 6
24.9 Starting NMT Measurements	24 - 7
24.10 Stopping NMT Measurements	24 - 7
24.11 Changing NMT Measurement Settings	24 - 7
24.11.1 Selecting the NMT Measurement Mode	24 - 7
24.11.2 Changing the Stimulation Current	24 - 7
24.11.3 Changing the Pulse Width	24 - 7
24.11.4 Enabling Block Recovery Notification	24 - 8
24.11.5 Adjusting NMT Stimulation Beep Volume	24 - 8
24.12 Recalling Calibration Information	24 - 8
24.13 NMT Troubleshooting	24 - 8
25 Monitoring Regional Oxygen Saturation (rSO₂)	25 - 1
25.1 rSO ₂ Introduction	25 - 1
25.2 rSO ₂ Safety Information	25 - 2
25.3 rSO ₂ Measurement Limitations	25 - 2
25.4 rSO ₂ Display	25 - 2
25.5 Accessing the On-screen rSO ₂ Guide	25 - 3
25.6 Preparing for rSO ₂ Monitoring	25 - 3
25.6.1 rSO ₂ Sensor Site Selection	25 - 3
25.6.2 Preparing the Skin	25 - 3
25.6.3 Applying the rSO ₂ Sensor	25 - 4
25.6.4 Connecting the rSO ₂ Parts	25 - 4
25.7 Changing rSO ₂ Settings	25 - 5
25.7.1 Changing rSO ₂ Alarm Settings	25 - 5
25.7.2 Setting the rSO ₂ Auto Low Limit Switch	25 - 5
25.7.3 Setting the rSO ₂ Label	25 - 5
25.7.4 Setting the AUC Mode	25 - 5
25.7.5 Setting the Baseline	25 - 5
25.7.6 Selecting rSO ₂ Parameters for Display	25 - 6
25.8 Covidien Information	25 - 6
26 Review	26 - 1
26.1 Review Overview	26 - 1
26.2 Review Dialog	26 - 1
26.2.1 Accessing the Review Dialog	26 - 1
26.2.2 Example Review Dialog	26 - 1
26.2.3 Symbols on Review Pages	26 - 2
26.2.4 Common Operations	26 - 2
26.2.5 Tabular Trends Review Page	26 - 3
26.2.6 Graphics Trends Review Page	26 - 4
26.2.7 Events Review Page	26 - 5
26.2.8 Full Disclosure Review Page	26 - 7
26.2.9 Arrhy Statistics Review Page	26 - 9

26.2.10 OxyCRG Review Page	26 - 9
26.2.11 12-Lead ECG Review Page	26 - 10
26.2.12 ST Review Page	26 - 11
26.3 Reviewing Discharged Patients	26 - 12
26.3.1 Checking the Data of a Discharged Patient	26 - 12
26.3.2 Checking the Information of a Discharged Patient	26 - 12
27 Clinical Assistive Applications (CAA)	27 - 1
27.1 Checking Software Licenses	27 - 1
27.2 BoA Dashboard™	27 - 1
27.2.1 Accessing BoA Dashboard™	27 - 1
27.2.2 Induction	27 - 1
27.2.3 Maintenance	27 - 3
27.2.4 Recovery	27 - 4
27.2.5 Setting the BoA Dashboard	27 - 4
27.3 Early Warning Score (EWS)	27 - 5
27.3.1 Displaying the EWS Numerics Area	27 - 6
27.3.2 Accessing the EWS Screen	27 - 6
27.3.3 Performing EWS Scoring	27 - 7
27.3.4 Changing EWS Settings	27 - 8
27.3.5 Viewing Historical Scores	27 - 9
27.3.6 Viewing Parameter Trends	27 - 9
27.4 Glasgow Coma Scale (GCS)	27 - 9
27.4.1 Displaying the GCS Parameter Area	27 - 10
27.4.2 Accessing the GCS Dialog	27 - 10
27.4.3 Performing GCS Scoring	27 - 11
27.4.4 Setting GCS Scoring Interval	27 - 11
27.4.5 Reviewing GCS Trend Data	27 - 11
27.5 SepsisSight™	27 - 11
27.5.1 Accessing the SepsisSight Dialog	27 - 12
27.5.2 Screening	27 - 12
27.5.3 Recommendations	27 - 13
27.5.4 Reviewing SepsisSight Trend Data	27 - 13
27.6 Resus Mode	27 - 13
27.6.1 Entering the Resus Mode	27 - 14
27.6.2 CPR Record	27 - 14
27.6.3 Exiting the Resus Mode	27 - 16
27.6.4 Reviewing the Resuscitation Events	27 - 16
27.7 ECG 24h Summary	27 - 16
27.7.1 Viewing the ECG 24h Summary	27 - 17
27.7.2 Selecting Typical ECG Strips	27 - 17
27.7.3 Reviewing ECG Summary	27 - 17
27.8 HemoSight™	27 - 17
27.8.1 Accessing the HemoSight Dialog	27 - 17
27.8.2 Viewing Hemodynamic Parameters	27 - 18
27.8.3 Physiology Graphics	27 - 20
27.8.4 Physiology Relationship	27 - 22
27.8.5 Hemodynamic Test	27 - 23
27.8.6 Following Up the Patient Hemodynamic Status	27 - 24

27.8.7 Evaluating the Hemodynamic Parameters	27 - 25
27.8.8 Setting Hemodynamic Parameter Ranges	27 - 27
27.8.9 Restoring Default HemoSight Range Values	27 - 27
27.8.10 Setting the Pattern	27 - 28
28 Calculation	28 - 1
28.1 Calculation Overview	28 - 1
28.2 Calculation Safety Information	28 - 1
28.3 Drug Calculations	28 - 1
28.3.1 Performing Drug Calculations	28 - 1
28.3.2 Checking the Titration Table	28 - 2
28.3.3 Drug Calculation Formula	28 - 2
28.3.4 Titration Table Calculation Formula	28 - 2
28.4 Hemodynamic Calculations	28 - 3
28.4.1 Performing Hemodynamic Calculations	28 - 3
28.4.2 Input Parameters for Hemodynamic Calculations	28 - 3
28.4.3 Calculated Parameters and Formulas for Hemodynamic Calculations	28 - 3
28.5 Oxygenation Calculations	28 - 4
28.5.1 Performing Oxygenation Calculations	28 - 4
28.5.2 Input Parameters for Oxygenation Calculations	28 - 5
28.5.3 Calculated Parameters and Formulas for Oxygenation Calculations	28 - 5
28.6 Ventilation Calculations	28 - 6
28.6.1 Performing Ventilation Calculations	28 - 6
28.6.2 Input Parameters for Ventilation Calculations	28 - 6
28.6.3 Calculated Parameters and Formulas for Ventilation Calculations	28 - 6
28.7 Renal Calculations	28 - 7
28.7.1 Performing Renal Calculations	28 - 7
28.7.2 Calculated Parameters and Formulas for Renal Calculations	28 - 7
28.7.3 Calculated Parameters and Formulas for Renal Calculations	28 - 8
29 Recording	29 - 1
29.1 Recorder	29 - 1
29.2 Starting Recordings	29 - 1
29.2.1 Manually Starting Recordings	29 - 1
29.2.2 Automatic Recordings	29 - 1
29.3 Stopping Recordings	29 - 2
29.3.1 Stopping Recordings Manually	29 - 2
29.3.2 Stopping Recordings Automatically	29 - 2
29.4 Recording Related Flags	29 - 2
29.5 Setting up the Recorder	29 - 2
29.6 Clearing Recording Tasks	29 - 2
29.7 Loading Paper	29 - 3
29.8 Removing Paper Jam	29 - 3
29.9 List of Recording Reports	29 - 3
30 Printing	30 - 1
30.1 Supported Printer	30 - 1

30.2 End Case Reports	30 - 1
30.2.1 Printing the End Case Report	30 - 1
30.2.2 Setting a Report as An End Case Report	30 - 1
30.2.3 Configuring the End Case Reports	30 - 1
30.2.4 Setting the End Case Report Period	30 - 2
30.3 Manually Starting a Printing Task	30 - 2
30.3.1 Printing from the Screen	30 - 2
30.3.2 Printing Realtime Reports	30 - 2
30.3.3 Printing Most Common Reports	30 - 2
30.4 Automatically Printing Reports	30 - 2
30.5 Stopping a Printing Task	30 - 3
30.6 Configuring Reports	30 - 3
30.6.1 Configuring ECG Reports	30 - 3
30.6.2 Configuring Realtime Reports	30 - 4
30.6.3 Configuring Tabular Trends Reports	30 - 4
30.6.4 Configuring Graphic Trends Reports	30 - 5
30.7 Viewing Printer Status	30 - 5
30.8 Printer Out of Paper	30 - 5
30.9 List of Reports	30 - 5
31 Using the On-Screen Timers	31 - 1
31.1 Displaying Timers	31 - 1
31.2 Controlling the Timer	31 - 1
31.3 Setting the Timer	31 - 1
32 Managing Configurations	32 - 1
32.1 Configuration Introduction	32 - 1
32.2 Changing the Department	32 - 1
32.3 Setting Default Patient Category	32 - 1
32.4 Setting Default Configuration	32 - 1
32.5 Saving Current Settings	32 - 2
32.6 Deleting a Configuration	32 - 2
32.7 Transferring a Configuration	32 - 2
32.7.1 Exporting a Configuration	32 - 2
32.7.2 Importing a Configuration	32 - 3
32.7.3 Loading a Configuration	32 - 3
32.8 Printing Configurations	32 - 3
32.9 Modifying Configuration Password	32 - 3
33 Password-protected User Settings	33 - 1
33.1 Setting the Device Location	33 - 1
33.1.1 Setting Monitor Information	33 - 1
33.1.2 Setting Monitor Location	33 - 1
33.1.3 Enabling the Auto Obtain Bed Number Function	33 - 1
33.2 Changing Patient Management Settings	33 - 2
33.2.1 Selecting Displayed Patient Information	33 - 2
33.2.2 Setting the Length of Data Transferred by N1 or T1	33 - 2

33.2.3	Setting the Strategy of Transferring Patient Information	33 - 2
33.2.4	Transferring the N1 or T1 Settings	33 - 2
33.2.5	Auto Discharging a Patient after Monitor Power Off	33 - 3
33.2.6	Clearing All Patient Data	33 - 3
33.2.7	Selecting Query Criteria for Searching Patients in ADT Server	33 - 3
33.2.8	Setting Patient Location Options for the Discharge Screen	33 - 3
33.2.9	Hiding Patient Name	33 - 3
33.2.10	Select Whether a Prompt is Required When Auto Deleting Discharged Patients	33 - 4
33.3	Changing the Alarm Settings	33 - 4
33.3.1	Setting Alarm Tone Properties	33 - 4
33.3.2	Setting Alarm Pausing and Resetting Properties	33 - 5
33.3.3	Defining the Pause Function	33 - 5
33.3.4	Latching Physiological Alarms	33 - 6
33.3.5	Changing Remote Alarm Settings	33 - 7
33.3.6	Setting Nurse Call Properties	33 - 8
33.3.7	Changing Alarm Priority Settings	33 - 9
33.3.8	Changing Alarm Delay Settings	33 - 10
33.3.9	Adjusting the Alarm Light Brightness	33 - 11
33.3.10	Changing Other Alarm Settings	33 - 11
33.4	Changing CAA Settings	33 - 12
33.4.1	Enabling Inputting the Clinician ID	33 - 12
33.4.2	Selecting the Default Scoring Tool	33 - 12
33.4.3	Managing the Scoring Tools	33 - 13
33.4.4	Setting GCS Threshold for Each Consciousness Level	33 - 13
33.5	Changing Module Settings	33 - 13
33.5.1	Selecting the ECG Standard	33 - 13
33.5.2	Changing the QTc Formula	33 - 13
33.5.3	Setting the 12-Lead Order Switch	33 - 14
33.5.4	Calibrating ECG	33 - 14
33.5.5	Manually Zeroing the CO ₂ Module	33 - 14
33.5.6	Hiding the Invalid Display after Zeroing the CO ₂ Module	33 - 14
33.5.7	Manually Zeroing the AG Module	33 - 14
33.5.8	Hiding the Invalid Display after Zeroing the AG Module	33 - 15
33.5.9	Selecting the Gas Type for Measurement	33 - 16
33.5.10	Setting Parameter Measurement Timeout	33 - 16
33.5.11	Setting Flow Rate (For Sidestream CO ₂ Module Without O ₂)	33 - 16
33.6	Hiding Undesired Review Tabs	33 - 16
33.7	Setting the Printer	33 - 16
33.7.1	Setting the Printer Properties	33 - 16
33.7.2	Setting the Report Type	33 - 17
33.7.3	Setting the Report Layout	33 - 17
33.7.4	Setting Patient Information on 12-lead ECG Reports	33 - 17
33.7.5	Configuring the Name of PDF Files	33 - 18
33.7.6	Showing the Second Mark	33 - 18
33.7.7	Setting the Arrhythmia Information to Output by the Recorder	33 - 18
33.7.8	Setting Parameter Unit	33 - 18
33.8	Setting the Time	33 - 18
33.8.1	Setting the Time Synchronization	33 - 18
33.8.2	Enabling Auto Daylight Savings Time	33 - 19

33.9 Viewing Version Information	33 - 19
33.10 Checking Battery Information	33 - 20
33.11 Changing Secondary Display Settings (for N22/N19)	33 - 20
33.11.1 Configuring Secondary Display Screen Contents (for N22/N19/N17)	33 - 20
33.11.2 Enabling Secondary Display Alarm Indications (for N22/N19)	33 - 20
33.12 Changing Scanner Settings	33 - 20
33.12.1 Establish the Relationship between Patient Demographics and 2D Barcode Fields (for the Mindray Custom 2D Barcode Reader)	33 - 20
33.12.2 Setting the Barcode Reader Information	33 - 21
33.12.3 Identifying the Barcode Reader (for the non-Mindray Custom 2D Barcode Reader)	33 - 21
33.12.4 Selecting Patient Information Read by the Barcode Reader (for the Mindray Custom 2D Barcode Reader)	33 - 21
33.13 Configuring the Network	33 - 21
33.13.1 Network Safety Information	33 - 22
33.13.2 Selecting a Network Type	33 - 22
33.13.3 Setting the Wired Network	33 - 22
33.13.4 Setting the Wireless Network	33 - 22
33.13.5 Managing Certifications	33 - 23
33.13.6 Enabling Selecting a CMS	33 - 23
33.13.7 Adding CMSs	33 - 23
33.13.8 Setting Multicast Parameters	33 - 23
33.13.9 Setting the Master Server Address	33 - 23
33.13.10 Setting the Network Service Quality Level	33 - 24
33.13.11 Using the ADT Gateway	33 - 24
33.13.12 Sending Realtime Data, Waveforms and Alarms via HL7 Protocol	33 - 24
33.13.13 Selecting Data Encryption Type	33 - 24
33.13.14 Disabling the Broadcasting Patient Demographics Function	33 - 25
33.14 MLDAP	33 - 25
33.14.1 Setting MLDAP	33 - 25
33.14.2 Testing MLDAP Server Connection	33 - 25
33.14.3 Selecting Password for User Authentication	33 - 25
33.14.4 Setting the Password Timeout Period	33 - 26
33.15 Defining Other Functions	33 - 26
33.15.1 Setting Notch Filter Frequency	33 - 26
33.15.2 Setting Mouse Sensitivity	33 - 26
33.15.3 Setting the SpO ₂ Tone Mode	33 - 26
33.15.4 Selecting the Language	33 - 27
33.15.5 Switching On or Off a Parameter	33 - 27
33.15.6 Setting If Setting Parameter Switches is Protected	33 - 28
33.15.7 Setting If Parameter Switch is Influenced by Configuration	33 - 28
33.15.8 Setting Whether the Monitor Stands by if MPM module is Removed	33 - 28
34 Battery	34 - 1
34.1 Battery Introduction	34 - 1
34.2 Battery Safety Information	34 - 1
34.3 Installing or Replacing the Battery	34 - 1
34.4 Battery Indications	34 - 2
34.4.1 Battery LED	34 - 2
34.4.2 Battery symbols	34 - 3

34.4.3 Battery-related Alarms	34 - 3
34.5 Charging the Battery	34 - 3
34.6 Maintaining the Battery	34 - 3
34.6.1 Conditioning the Battery	34 - 3
34.6.2 Checking Battery Performance	34 - 4
34.7 Storing Batteries	34 - 4
34.8 Recycling Batteries	34 - 4
35 Care and Cleaning	35 - 1
35.1 Care and Cleaning Introduction	35 - 1
35.2 Care and Cleaning Safety Information	35 - 1
35.3 Cleaning and Disinfecting the Equipment and Mounting Kits	35 - 2
35.3.1 Approved Cleaning and Disinfecting Agents	35 - 2
35.3.2 Cleaning the Equipment and Mounting Kits	35 - 3
35.3.3 Disinfecting the Equipment and Mounting Kits	35 - 3
35.4 Cleaning and Disinfecting the Accessories	35 - 3
35.4.1 Approved Accessories Cleaning and Disinfecting Agents	35 - 4
35.4.2 Cleaning the Accessories	35 - 6
35.4.3 Disinfecting the Accessories	35 - 6
35.5 Sterilization	35 - 6
36 Maintenance	36 - 1
36.1 Maintenance Introduction	36 - 1
36.2 Maintenance Safety Information	36 - 1
36.3 Maintenance and Testing Schedule	36 - 2
36.4 Checking System Software Version	36 - 2
36.5 Testing Methods and Procedures	36 - 2
36.5.1 Performing Visual Inspection	36 - 3
36.5.2 Performing Power-on Test	36 - 3
36.5.3 Checking the NMT Sensor	36 - 3
36.5.4 Testing the Recorder	36 - 3
36.5.5 Testing the Network Printer	36 - 3
36.5.6 Checking the Battery	36 - 4
36.6 NIBP Maintenance	36 - 4
36.6.1 NIBP Leakage Test	36 - 4
36.6.2 NIBP Accuracy Test	36 - 4
36.7 Disposing of the Monitor	36 - 4
37 Accessories	37 - 1
37.1 ECG Accessories	37 - 1
37.1.1 ECG Electrodes Available for Purchase	37 - 1
37.1.2 ECG Electrodes Also Compatible	37 - 1
37.1.3 12-Pin Trunk Cables Available for Purchase	37 - 2
37.1.4 12-Pin Trunk Cables Also Compatible	37 - 2
37.1.5 3-lead ECG Leadwires Available for Purchase	37 - 2
37.1.6 3-lead ECG Leadwires Also Compatible	37 - 2
37.1.7 5-lead ECG Leadwires Available for Purchase	37 - 3
37.1.8 5-lead ECG Leadwires Also Compatible	37 - 3

37.1.9 6-lead ECG Leadwires Available for Purchase	37 - 3
37.1.10 12-lead ECG Chest Leadwires Available for Purchase	37 - 3
37.1.11 12-lead ECG Leadwires Also Compatible	37 - 3
37.2 SpO ₂ Accessories	37 - 3
37.2.1 Extension Cables and Adapter Cables Available for Purchase	37 - 4
37.2.2 Extension Cables and Adapter Cables Also Compatible	37 - 4
37.2.3 Masimo SpO ₂ RD Set Sensors Available for Purchase	37 - 4
37.2.4 Masimo SpO ₂ LNCS Sensors Also Compatible	37 - 4
37.2.5 Nellcor SpO ₂ Sensors Also Compatible	37 - 5
37.3 Temp Accessories	37 - 5
37.3.1 Temp Cable Available for Purchase	37 - 5
37.3.2 Temp Probes Available for Purchase	37 - 5
37.4 NIBP Accessories	37 - 6
37.4.1 NIBP Hoses Available for Purchase.....	37 - 6
37.4.2 Cuffs Available for Purchase	37 - 6
37.5 IBP Accessories	37 - 7
37.5.1 IBP Accessories Available for Purchase	37 - 7
37.5.2 IBP Accessories Also Compatible	37 - 7
37.5.3 ICP Accessories Available for Purchase	37 - 7
37.6 C.O. Accessories Available for Purchase	37 - 7
37.7 ScvO ₂ Accessories Available for Purchase	37 - 8
37.8 CO ₂ Accessories	37 - 8
37.8.1 Sidestream CO ₂ Accessories Available for Purchase	37 - 8
37.8.2 Microstream CO ₂ Accessories Also Compatible	37 - 8
37.9 AG Accessories	37 - 9
37.9.1 AG Accessories Available for Purchase	37 - 9
37.10 EEG Accessories Available for Purchase	37 - 9
37.11 BIS Accessories	37 - 9
37.11.1 BIS Accessories Available for Purchase	37 - 9
37.11.2 BIS Accessories Also Compatible	37 - 9
37.12 RM Accessories	37 - 10
37.13 NMT Accessories Available for Purchase	37 - 10
37.14 rSO ₂ Accessories	37 - 10
37.14.1 rSO ₂ Accessories Available for Purchase	37 - 10
37.14.2 rSO ₂ Accessories Also Compatible	37 - 10
37.15 CCO/SvO ₂ Accessories Available for Purchase	37 - 11
37.16 Benelink Accessories	37 - 11
37.17 External Modules	37 - 12
37.18 Mount and Mounting Accessories	37 - 13
37.19 Miscellaneous Accessories	37 - 14

A Product Specifications **A - 1**

A.1 Monitor Safety Specifications	A - 1
A.2 Physical Specifications	A - 1
A.2.1 BeneVision N22/N19	A - 1
A.2.2 BeneVision N17/N15/N12	A - 1

A.2.3 SMR and Modules	A - 2
A.3 Environmental Specifications	A - 2
A.4 Power Supply Specifications	A - 3
A.4.1 External Power Supply Specifications	A - 3
A.4.2 Battery Specifications	A - 3
A.4.3 N17/N15/N12 Battery Specifications	A - 4
A.5 Display Specifications	A - 4
A.6 Recorder Specifications	A - 4
A.7 LEDs	A - 5
A.8 Audio Indicator	A - 5
A.9 Monitor Interface Specifications	A - 5
A.9.1 Interface Specifications of the N22/N19 Main Unit	A - 5
A.9.2 Interface Specifications of the N22/N19 Separate Primary Display	A - 5
A.9.3 Interface Specifications of the N22/N19 Integrated Primary Display	A - 5
A.9.4 Interface Specifications of the N22/N19 Secondary Display	A - 5
A.9.5 Interface Specifications of the N17/N15/N12	A - 6
A.10 Signal Outputs Specifications	A - 6
A.11 Data Storage	A - 7
A.12 Wi-Fi Specifications	A - 7
A.12.1 Wi-Fi Technical Specifications (MSD45N)	A - 7
A.12.2 Wi-Fi Technical Specifications (SX-SDMAC-2832S+)	A - 8
A.12.3 Wi-Fi Performance Specifications	A - 8
A.13 Measurement Specifications	A - 9
A.13.1 ECG Specifications	A - 9
A.13.2 Resp Specifications	A - 12
A.13.3 SpO ₂ Specifications	A - 12
A.13.4 PR Specifications	A - 13
A.13.5 Temp Specifications	A - 14
A.13.6 NIBP Specifications	A - 15
A.13.7 IBP Specifications	A - 17
A.13.8 C.O. Specifications	A - 17
A.13.9 ScvO ₂ /SvO ₂ Specifications from the Edwards Monitor	A - 18
A.13.10 CCO Specifications from the Edwards Monitor	A - 18
A.13.11 ScvO ₂ Specifications	A - 19
A.13.12 CO ₂ Specifications	A - 19
A.13.13 AG Specifications.....	A - 23
A.13.14 RM Specifications	A - 26
A.13.15 EEG Specifications	A - 28
A.13.16 BIS Specifications	A - 28
A.13.17 NMT Specifications (NMT from Mindray NMT module)	A - 28
A.13.18 rSO ₂ Specifications	A - 29
B EMC and Radio Regulatory Compliance	B - 1
B.1 EMC	B - 1
B.2 Radio Regulatory Compliance	B - 4
C Default Settings	C - 1
C.1 ECG, Arrhythmia, ST and QT Default Settings	C - 1

C.1.1 ECG Default Settings	C - 1
C.1.2 Arrhythmia Default Settings	C - 2
C.1.3 ST Default Settings	C - 3
C.1.4 QT Default Settings	C - 4
C.1.5 Glasgow 12-lead ECG Algorithm Default Settings	C - 4
C.2 Respiration Default Settings	C - 4
C.3 SpO ₂ /SpO ₂ b Default Settings	C - 5
C.4 Temperature Default Settings	C - 6
C.5 NIBP Default Settings	C - 6
C.6 IBP Default Settings	C - 8
C.7 C.O. Default Settings	C - 11
C.8 ScvO ₂ Default Settings	C - 12
C.9 CCO Default Settings(Vigilance II/Vigileo/EV1000/HemoSphere)	C - 12
C.10 ScvO ₂ /SvO ₂ Default Settings(Vigilance II/Vigileo/EV1000/HemoSphere)	C - 12
C.11 CO ₂ Default Settings	C - 13
C.11.1 General Settings	C - 13
C.11.2 Sidestream CO ₂ Default Settings	C - 13
C.11.3 Microstream CO ₂ Default Settings	C - 14
C.12 Gas Default Settings	C - 14
C.13 RM Default Settings	C - 16
C.14 EEG Default Settings	C - 17
C.15 BIS Default Settings	C - 18
C.16 NMT Default Settings	C - 18
C.17 rSO ₂ Default Settings	C - 18
C.18 Alarm Default Settings	C - 19
C.19 Display Default Settings	C - 19

D Alarm Messages D - 1

D.1 Physiological Alarm Messages	D - 1
D.1.1 General Physiological Alarm Messages	D - 1
D.1.2 Arrhythmia Alarm Messages	D - 1
D.1.3 Resp Physiological Alarm Messages	D - 2
D.1.4 SpO ₂ Physiological Alarm Messages	D - 2
D.1.5 PR Physiological Alarm Messages	D - 2
D.1.6 NIBP Physiological Alarm Messages	D - 2
D.1.7 IBP Physiological Alarm Messages	D - 3
D.1.8 CO ₂ Physiological Alarm Messages	D - 3
D.1.9 AG Physiological Alarm Messages	D - 3
D.1.10 RM Physiological Alarm Messages	D - 3
D.2 Technical Alarm Messages	D - 3
D.2.1 General Technical Alarm Messages	D - 4
D.2.2 ECG Technical Alarm Messages	D - 4
D.2.3 Resp Technical Alarm Messages	D - 4
D.2.4 SpO ₂ Technical Alarm Messages	D - 4
D.2.5 Temp Technical Alarm Messages	D - 5
D.2.6 NIBP Technical Alarm Messages	D - 5
D.2.7 IBP Technical Alarm Messages	D - 6

D.2.8 C.O. Technical Alarm Messages	D - 7
D.2.9 ScvO ₂ Technical Alarm Messages	D - 7
D.2.10 CO ₂ Technical Alarm Messages	D - 7
D.2.11 AG Technical Alarm Messages	D - 9
D.2.12 RM Technical Alarm Messages	D - 9
D.2.13 EEG Technical Alarm Messages	D - 9
D.2.14 BIS Technical Alarm Messages	D - 10
D.2.15 NMT Technical Alarm Messages	D - 11
D.2.16 rSO ₂ Technical Alarm Messages	D - 11
D.2.17 Power Supply Technical Alarm Messages	D - 12
D.2.18 Recorder Technical Alarm Messages	D - 12
D.2.19 Printer Technical Alarm Messages	D - 13
D.2.20 Technical Alarm Messages Related to Networked Monitoring	D - 13
D.2.21 Technical Alarm Messages Related to Telemetry Monitors	D - 14
D.2.22 Other System Technical Alarm Messages	D - 14
E SpO₂ Sensor Accuracy	E - 1
E.1 The Accuracy of Masimo SpO ₂ Sensors	E - 1
E.2 The Accuracy of Nellcor SpO ₂ Sensors	E - 3
F Units, Symbols and Abbreviations	F - 1
F.1 Units	F - 1
F.2 Symbols	F - 2
F.3 Abbreviations	F - 3

This page intentionally left blank.

1 Safety

1.1 Safety Information

WARNING

- Indicates a potential hazard or unsafe practice that, if not avoided, could result in death or serious injury.
-
-

CAUTION

- Indicates a potential hazard or unsafe practice that, if not avoided, could result in minor personal injury or product/property damage.
-

NOTE

- Provides application tips or other useful information that does not involve patient or user risk.
-

1.1.1 Warnings

WARNING

- Patient with a pacemaker – on ventricular paced patients, episodes of Ventricular Tachycardia may not always be detected. Do not rely entirely upon the system's automated arrhythmia detection algorithm. Keep pacemaker patients under close surveillance.
- This equipment is used for a single patient at a time.
- To avoid explosion hazards, do not use the equipment in the presence of oxygen-rich atmospheres, flammable anesthetics, or other flammable agents.
- Do not touch the equipment's metal parts or connectors when in contact with the patient; otherwise patient injury may result.
- Never mix patient electrode types or brands. Dissimilar metals or other incompatibilities may cause considerable baseline drift and may increase trace recovery time after defibrillation.
- To reduce the hazard of burns during high-frequency surgical procedure, ensure that the monitor's cables and transducers never come into contact with the electro-surgery unit (ESU).
- The neutral electrode of the electro-surgery unit (ESU) shall properly contact the patient. Otherwise, burns may result.
- MR unsafe: the N Series monitor is not intended to be used within the Magnetic Resonance (MR) environment.
- Before connecting the equipment to the mains power, ensure that the voltage and frequency ratings of the power line are the same as those indicated on the equipment's label or in this manual.
- Before putting the system into operation, the operator must verify that the equipment, connecting cables, and accessories are in correct working order and operating condition.
- To avoid risk of electric shock, the equipment must only be connected to mains power with protective earth, or operated on battery power.
- Do not touch the patient and live parts simultaneously. Otherwise patient injury may result.
- Do not touch the patient or metal parts in contact with the patient during defibrillation. Otherwise serious injury or death could result.
- Do not open the equipment housings. All servicing and future upgrades must be carried out by trained and authorized personnel.

- Do not rely exclusively on the audible alarm system for patient monitoring. Turning the alarm volume to a low level or off may result in a hazard to the patient. Always keep the patient under close surveillance.
 - Alarm settings should be customized according to patient situations.
 - Do not place the equipment or accessories in any position that might cause it to fall on the patient.
 - Do not start or operate the equipment unless the setup was verified to be correct.
 - To avoid inadvertent disconnection, route all cables in a way to prevent a stumbling hazard. Wrap and secure excess cabling to reduce risk of entanglement by patients or personnel.
 - The physiological data and alarm messages displayed on the equipment are for reference only and cannot be directly used for diagnostic interpretation. The equipment should not be used as the sole basis for medical decisions. It must be used in conjunction with clinical signs and symptom. If any measurement seems questionable, first check the patient's vital signs by alternate means and then check the equipment for proper functioning.
-

1.1.2 Cautions

CAUTION

- Use only parts and accessories specified in this manual.
 - Disposable accessories are not designed to be reused. Reuse may cause a risk of contamination and affect the measurement accuracy.
 - Ensure that the equipment is supplied with continuous electric power during operation from the mains power or batteries. Sudden power failure may cause data loss.
 - When no battery is installed, ensure that the monitor is supplied with continuous electric power during operation. Sudden power failure may lead to data loss.
 - Store and use the equipment in specified environmental condition. The monitor and accessories may not meet the performance specification due to aging, stored or used outside the specified temperature and humidity range.
 - Magnetic and electrical fields are capable of interfering with the proper performance of the equipment. For this reason make sure that all external devices operated in the vicinity of the equipment comply with the relevant EMC requirements. Mobile phones, X-ray equipment, and MRI devices are possible sources of interference as they may emit higher levels of electromagnetic radiation.
 - Always install or carry the equipment properly to avoid damage caused by drops, impacts, strong vibrations or other mechanical forces.
 - Dry the equipment immediately in case of rain or water spray.
 - Some settings are password protected and can only be changed by authorized personnel. Contact your department manager or biomedical engineering department for the passwords used at your facility.
 - Do not loop the patient cabling into a tight coil or wrap around the device, as this can damage the patient cabling.
 - Dispose of the package material as per the applicable waste control regulations. Keep it out of children's reach.
 - At the end of its service life, the equipment, as well as its accessories, must be disposed of in compliance with the guidelines regulating the disposal of such products. If you have any questions concerning disposal of the equipment, please contact Mindray.
-

















1.1.3 Notes



















NOTE

- The equipment software copyright is solely owned by Mindray. No organization or individual shall resort to modifying, copying, or exchanging it or to any other infringement on it in any form or by any means without due permission.
- Put the equipment in a location where it can be easily viewed and operated.

- The equipment uses a mains plug as isolation means to the mains power. Do not locate the equipment in a place difficult to access the mains plug.
- During normal use, the operator is expected to face the front of the equipment.
- Remove the battery before shipping the monitor or if it will not be used for an extended period of time.
- Remove the battery before transporting the equipment or if the equipment will not be used for a long time.
- The software was developed in compliance with IEC62304, to minimize the possibility of hazards arising from software errors.
- This manual is based on the maximum configuration and therefore some contents may not apply to the product. If you have any question, please contact Mindray.
- Observance of this manual is a prerequisite for proper product performance and correct operation and ensures patient and operator safety.
- Keep this manual in the vicinity of the equipment so that it can be referenced when needed.

1.2 Equipment Symbols

Symbol	Description	Symbol	Description
	General warning sign		Refer to instruction manual/booklet
	Serial number	REF	Catalogue number
	Date of manufacture		Manufacturer
	USB connector	IPX1	Protected against vertically falling water drops per IEC 60529
	Battery indicator		Computer network
	Equipotentiality		Alternating current
	Defibrillation-proof type CF applied part		Defibrillation-proof type BF applied part
	Stop USB		Output
	Input/output		IBP zero key

Symbol	Description	Symbol	Description
	NIBP start/stop		Calibration
	Start		Stop
	Set baseline		Batch code
	Stand-by		Menu
	Check sensor		Graphical record
	Gas outlet		Gas inlet
	Pushing prohibited (wheels locked, no pushing)		Unlocking
	Video output		Non-ionizing electromagnetic radiation
	Dispose of in accordance to local requirements		Plastic identification symbol
	Certified to CAN/CSA Std. C22.2 No. 60601-1, No. 60601-1-6, No. 60601-1-8, No. 60601-2-25, No. 60601-2-26, No. 60601-2-27, No. 80601-2-30, No. 60601-2-34, No. 60601-2-49, No. 80601-2-55, No. 80601-2-56, and No. 80601-2-61		

2 Equipment Introduction

2.1 Indications for Use

The BeneVision N12/N15/N17/N19/N22 patient monitors are intended for monitoring, displaying, reviewing, storing, alarming, and transferring of multiple physiological parameters including ECG (3-lead, 5-lead, 6-lead or 12-lead selectable, Arrhythmia Detection, ST Segment Analysis, QT Analysis, and Heart Rate (HR)), Respiration Rate (Resp), Temperature (Temp), Pulse Oxygen Saturation (SpO₂), Pulse Rate (PR), Non-invasive Blood Pressure (NIBP), Invasive Blood Pressure (IBP), Pulmonary Artery Wedge Pressure (PAWP), Cardiac Output (C.O.), Continuous Cardiac Output (CCO), Mixed/Central Venous Oxygen Saturation (SvO₂/ScvO₂), Carbon Dioxide (CO₂), Oxygen (O₂), Anesthetic Gas (AG), Bispectral Index (BIS), Respiration Mechanics (RM), Neuromuscular Transmission Monitoring (NMT), Electroencephalograph (EEG), and Regional Oxygen Saturation (rSO₂). The system also provides an interpretation of resting 12-lead ECG.

All the parameters can be monitored on single adult, pediatric, and neonatal patients except for the following:

- The arrhythmia detection, BIS, RM, CCO, SvO₂/ScvO₂, PAWP, and NMT monitoring are intended for adult and pediatric patients only;
- C.O. monitoring is intended for adult patients only;

The monitors are to be used in healthcare facilities by clinical professionals or under their guidance. They should only be used by persons who have received adequate training in their use. The BeneVision N12/N15/N17/N19/N22 monitors are not intended for helicopter transport, hospital ambulance, or home use.

NOTE

- **This manual is based on the maximum configuration and therefore some contents may not apply to the product. If you have any question, please contact Mindray.**
-

2.2 Applied Parts

The applied parts of the monitor are:

- ECG electrode and leadwire
- SpO₂ sensor
- Temp probe
- NIBP cuff
- IBP transducer
- C.O. sensor
- CCO sensor
- ScvO₂ sensor
- CO₂ sampling line/nasal sampling cannula, water trap, and mask
- AG sampling line, water trap, airway adapter, and mask
- RM sensor
- EEG electrode
- BIS sensor
- NMT sensor and electrode
- rSO₂ sensor

2.3 System Components

The N22 and N19 monitors consist of the main unit, primary display, secondary displays, external modules, satellite module rack (SMR), input devices, and output devices.

The N17, N15, N12 monitors consist of the main unit, external display, external modules, input devices, and output devices. The N17 and N15 can also be configured with the satellite module rack (SMR).

NOTE

- **The monitor may not include all these components. Contact the local service personnel for available components.**

2.3.1 N22, N19 Main Unit

The main unit processes data from modules and sends information to displays and, optionally, among networked devices.

2.3.1.1 N22, N19 Main Unit for Integrated Installation

If the main unit and the primary display are installed together. It provides the following connectors:

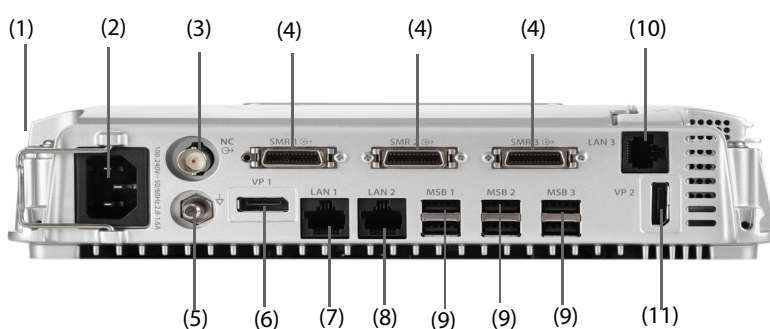

N22, N19 Main Unit Bottom View



N22, N19 Main Unit Side View

- (1) Cable retainer
- (2) AC Power input
- (3) Nurse call connector (NC)
It is a BNC connector. It connects the monitor to the hospital's nurse call system through the nurse call cable (PN: 8000-21-10361). Alarms from the monitor are sent to the nurse station through the nurse call system, if configured to do so.
- (4) Satellite module rack connector (SMR1, 2, 3): connects the SMR and N1/T1 docking station.

- (5) Equipotential Grounding Terminal
When using the monitor together with other devices, connect their equipotential grounding terminals together to eliminate the potential difference between them.
- (6) Video output connector (VP1): connects the secondary display.
- (7) Network Connector (LAN1)
It is a standard RJ45 connector which connects the monitor to the central monitoring system (CMS) or other network devices.
- (8) Network Connector (LAN 2)
Reserved for future use.
- (9) Serial bus connectors (MSB1, 2, 3): connect approved USB devices, for example the keyboard, mouse, and barcode reader. If an independent secondary display is connected, the MSB1 connector is connected to the SBH connector at the rear of the secondary display to activate the MSB connector connecting the keyboard and mouse for the independent secondary display.
- (10) Network Connector (LAN3)
It is a standard RJ45 connector which connects the iView system to the external network.
- (11) Video output connector (VP2): connects the iView display.
- (12) USB connectors: available only when iView module is configured. They connect approved USB devices to the iView, for example keyboard and mouse.
- (13) UDI label

CAUTION

- **Main unit installation and troubleshooting should be executed by Mindray service personnel or authorized technicians.**
-

NOTE

- **The UDI label on the main unit should be consistent with that on the display.**
-

2.3.1.2 N22, N19 Main Unit for Separate Installation

If the main unit and the primary display are separately installed, besides the connectors described in 2.3.1.1 *N22, N19 Main Unit for Integrated Installation*, the main unit also provides connectors at the rear.



(1) Video output connector (VP3): connects the VP connector on the separated primary display.

(2) Serial bus connector (MSB4): connects the serial bus hub connector (SBH) on the separated primary display.

(3) Signal input connector (SIG): connects the SIG1 connector on the separated primary display.

(4) DC-in connector: connects the DC-in connector on the separated primary display.

2.3.2 N22, N19 Displays

The displays are used to display system information, alarm messages, parameter numerics, waveforms, and so on. The displays integrate audible and visual alarms and provide USB connectivity. There are two display sizes available: the 22-inch display and the 19-inch display. The monitor supports a primary display, a secondary display, and a iView display.

2.3.2.1 N22, N19 Integrated Primary Display

The primary display can be attached to or separately from the main unit, either horizontally or vertically.

The following picture shows the indicators and connectors on the primary display when it is installed with the main unit.

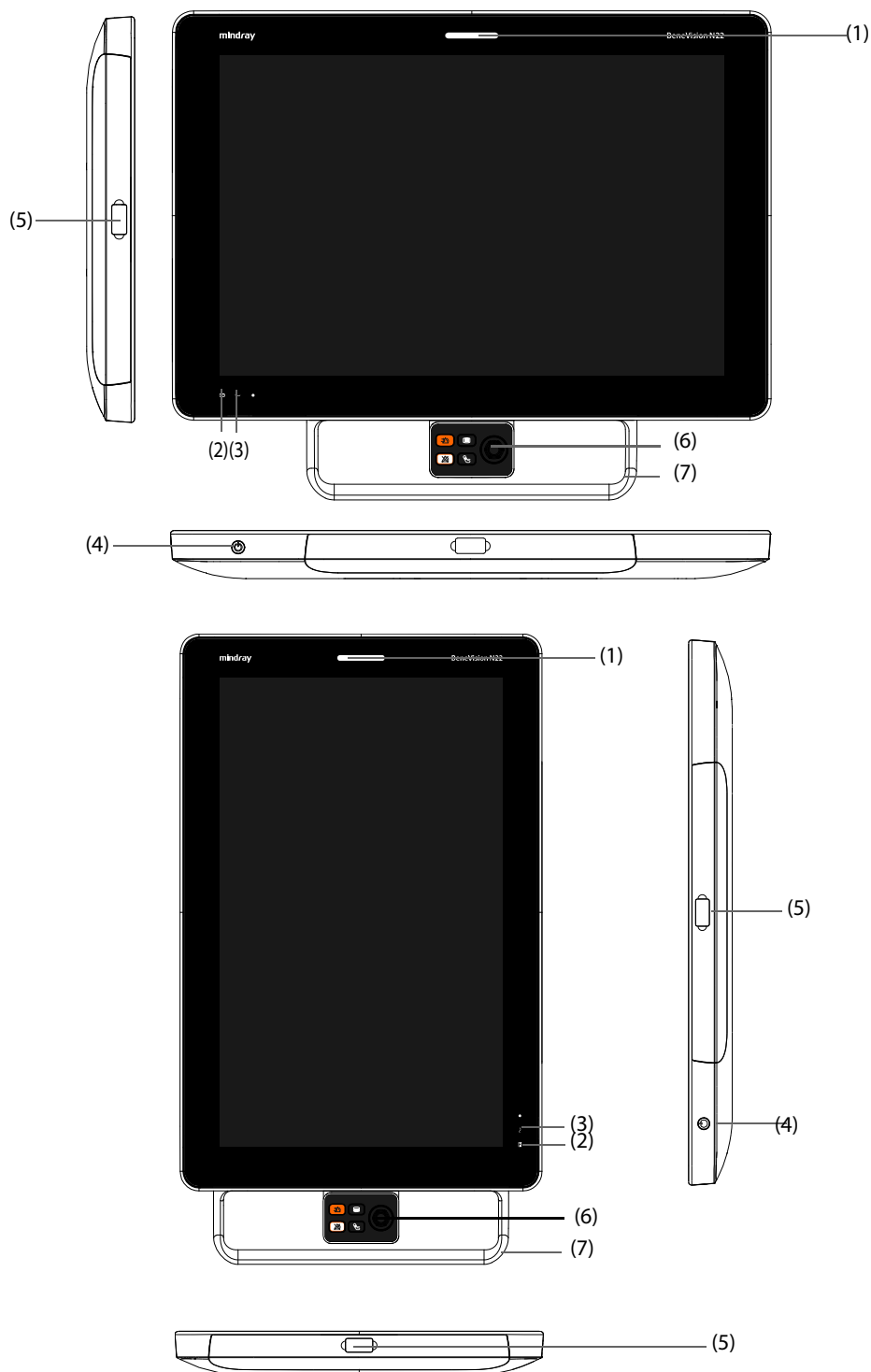

- (1) Alarm lamp:
When a physiological alarm or technical alarm occurs, this lamp lights and flashes corresponding with the alarm priority:
- ◆ High priority alarms: the lamp quickly flashes red.
 - ◆ Medium priority alarms: the lamp slowly flashes yellow.
 - ◆ Low priority alarms: the lamp lights in cyan without flashing.

- (2) Battery indicator:
 - ◆ Yellow: the battery is being charged.
 - ◆ Green: the battery is fully charged.
 - ◆ Flashing green: the monitor operates on battery power.
 - ◆ Off: no battery is installed, or the battery is malfunctioning, or the monitor is powered off and no AC power is connected.
- (3) AC power indicator
 - ◆ On: when AC power is connected.
 - ◆ Off: when AC power is not connected.
- (4) Power switch
 - ◆ Pressing this switch turns on the monitor.
 - ◆ When the monitor is on, pressing and holding this switch turns off the monitor.
- (5) Serial bus connectors (MSB): connect approved USB devices, for example keyboard, mouse, and barcode reader. Note that every connector may not be visible if the handle (7) is installed.
- (6) Navigation knob
- (7) Handle

2.3.2.2 N22, N19 Separated Primary Display and Secondary Display

Besides the indicators and connectors, which are the same as those of the integrated primary display, the separated primary display and the secondary display have connectors at the rear.

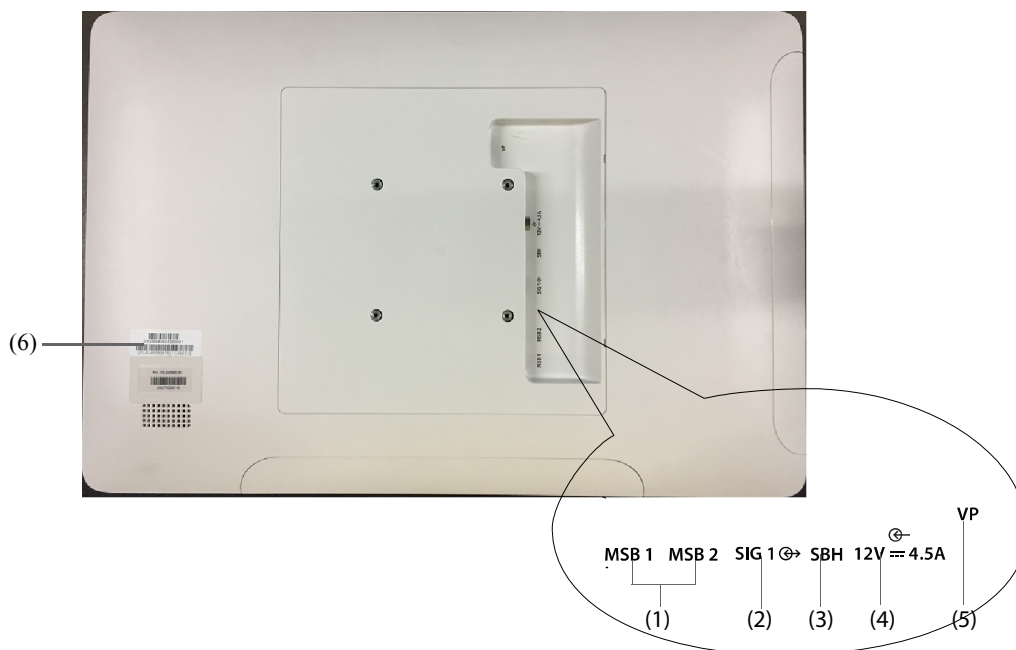

- (1) Serial bus connector (MSB1, MSB2): connect approved USB devices, for example keyboard, mouse, and barcode reader.
- (2) Signal input connector (SIG1): for the separate primary display, it connects the SIG connector at the rear of the main unit; for the secondary display, it is reserved for future use.
- (3) Serial bus hub connector (SBH): connects the MSB1 connector at the bottom of the main unit to activate MSB connectors for the independent secondary display.

- (4) DC-in connector: connects the DC adapter to run the secondary display.
- (5) Video output connector (VP): connects only to the VP3 connector on the back of the main unit when used as a separate primary display.
- (6) UDI label

NOTE

- **The UDI label on the main unit must be consistent with that on the display**
- **VP of the primary display must connect to VP3 on the main unit to have a supported configuration.**

2.3.3 N17, N15, N12 Main Unit

The main unit processes and displays data from modules, and optionally, among networked devices.

2.3.3.1 N17, N15, N12 Front View



- (1) Alarm lamp:
When a physiological alarm or technical alarm occurs, this lamp lights and flashes corresponding with the alarm priority:
 - ◆ High priority alarms: the lamp quickly flashes red.
 - ◆ Medium priority alarms: the lamp slowly flashes yellow.
 - ◆ Low priority alarms: the lamp lights in cyan without flashing.
- (2) Display

- (3) Battery indicator:
 - ◆ Yellow: the battery is being charged.
 - ◆ Green: the battery is fully charged.
 - ◆ Flashing green: the monitor operates on battery power.
 - ◆ Off: no battery is installed, or the monitor is powered off and no AC power is connected.
- (4) AC power indicator
 - ◆ On: when AC power is connected.
 - ◆ Off: when AC power is not connected.
- (5) Power switch
 - ◆ Pressing this switch turns on the monitor.
 - ◆ When the monitor is on, pressing and holding this switch turns off the monitor.

2.3.3.2 N17, N15, N12 Left View

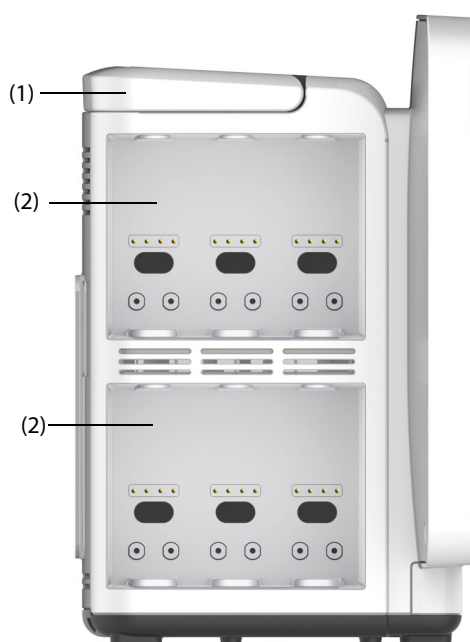

N17/N15

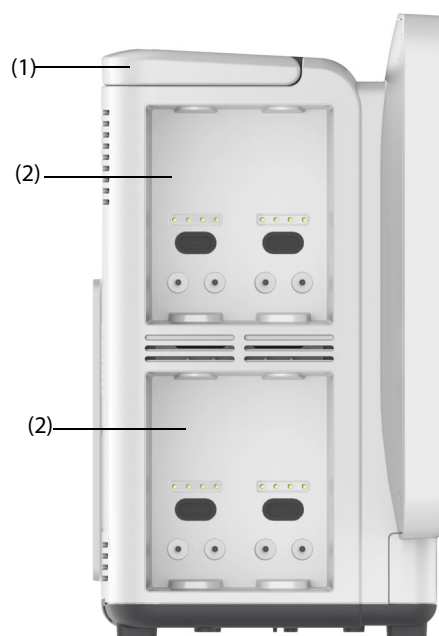

N12

- (1) Handle
- (2) Module racks

2.3.3.3 N17, N15, N12 Right View

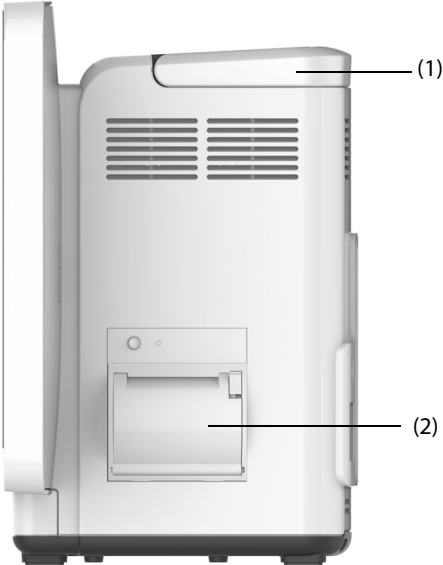

- (1) Handle
- (2) Recorder

2.3.3.4 N15, N12 Rear View

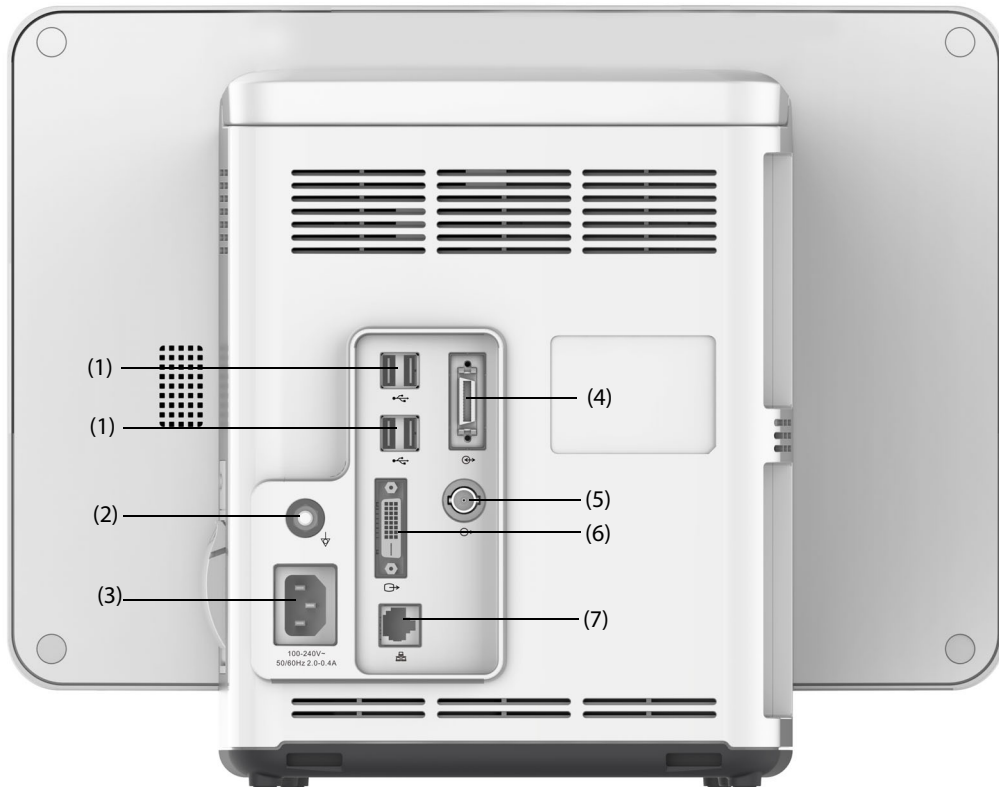

- (1) USB connectors
Connect approved USB devices, for example the keyboard, mouse, and barcode reader.
- (2) Equipotential Grounding Terminal
When using the monitor together with other devices, connect their equipotential grounding terminals together to eliminate the potential difference between them.
- (3) AC Power input
- (4) Satellite module rack connector
For N15, connects the SMR and N1/ T1 docking station.
For N12, connects the N1/ T1 docking station.
- (5) Nurse call connector
It is a BNC connector. It connects the monitor to the hospital's nurse call system through the nurse call cable (PN: 8000-21-10361). Alarms from the monitor are sent to the nurse station through the nurse call system, if configured to do so.
- (6) Digital video connector: connects external display.
- (7) Network Connector
It is a standard RJ45 connector which connects the monitor to the central monitoring system (CMS) or other network devices.

2.3.3.5 N17 Rear View

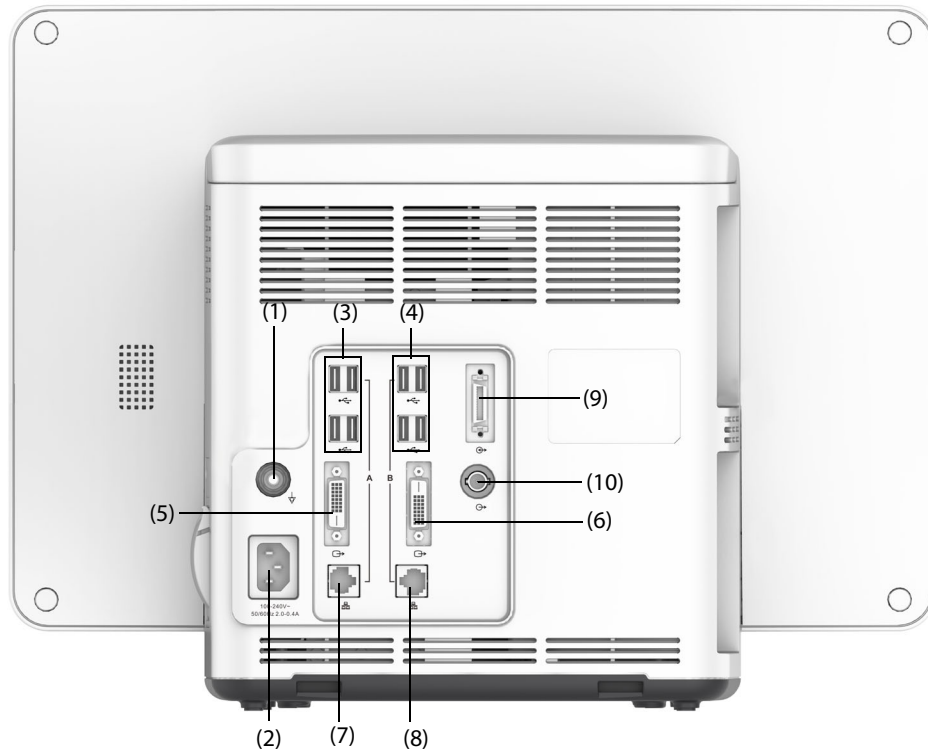

- (1) Equipotential Grounding Terminal
When using the monitor together with other devices, connect their equipotential grounding terminals together to eliminate the potential difference between them.
- (2) AC Power input
- (3) USB connectors
Connect approved USB devices, for example the keyboard, mouse, and barcode reader.
- (4) USB connectors: available only when iView module is configured. They connect approved USB devices to the iView system, for example keyboard and mouse.
- (5) Digital video connector: connects a mirrored external display.
- (6) Digital video connector:
Connects the iView display if the iView module is configured.
Connects an independent external display if the N17 does not have an iView.
- (7) Network Connector
It is a standard RJ45 connector which connects the monitor to the central monitoring system (CMS) or other network devices.
- (8) Network Connector: available only when iView module is configured. It is a standard RJ45 connector which connects the iView system to an external network.
- (9) Satellite module rack (SMR) connector: connects the SMR or N1/T1 docking station.
- (10) Nurse call connector
It is a BNC connector. It connects the monitor to the hospital's nurse call system through the nurse call cable (PN: 8000-21-10361). Alarms from the monitor are sent to the nurse station through the nurse call system, if configured to do so.

2.3.4 Satellite Module Rack (SMR)

The SMR provides an interface between the monitor and external modules. The SMR has eight module slots. It is connected to the main unit through the SMR connector.

The following pictures show the indicator and connectors on the SMR.

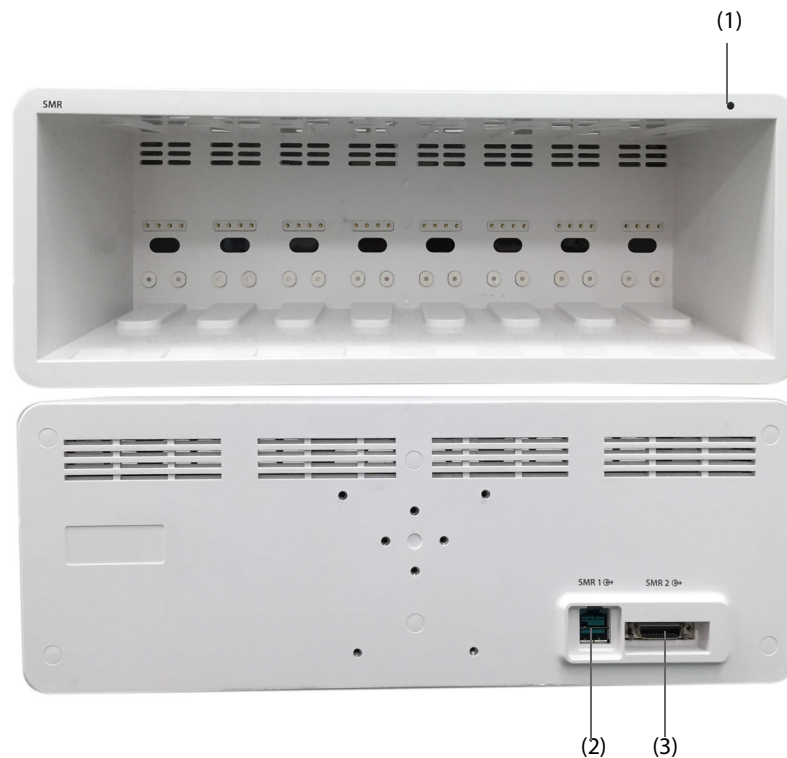

(1) SMR status indicator: illuminates when the SMR is powered on.

(2) Monitor connector: connects to the Passport 17m/12m monitor.

(3) Monitor connector: connects to the BeneVision monitor.

2.3.5 External Modules

The external modules are used to monitor the patient's physiological parameters, record patient information and data, and connect external devices. The monitor provides the following modules:

- Parameter modules: acquires and processes the patient's data and sends the data to the main unit.
- Recorder module: prints patient information, parameter measurements and waveforms.
- BeneLink module: connects external devices. The monitor outputs data from external devices through the BeneLink module.

2.3.5.1 Available Modules

Refer to *25.18 External Modules* for available modules.

The monitor can simultaneously use maximum of three IBP modules and three Temp modules (besides the Temp and IBP of the MPM module), and two rSO₂ modules. The other modules can only be used one at a time. Otherwise, the monitor will issue a module conflict prompt. Using MPM module, T1, or N1 at the same time will also result in module conflict.

For example, if a CO₂ module is already loaded and then another CO₂ module is inserted, the monitor will then prompt module conflict. To solve the problem of module conflict, just remove a module.

2.3.5.2 Example Module

The parameter modules have similar structure:

- The parameter label is marked at the upper left corner.
- Hard keys are located on the upper part.
- Patient cable connectors are located at the lower part.

Take the MPM module as an example:

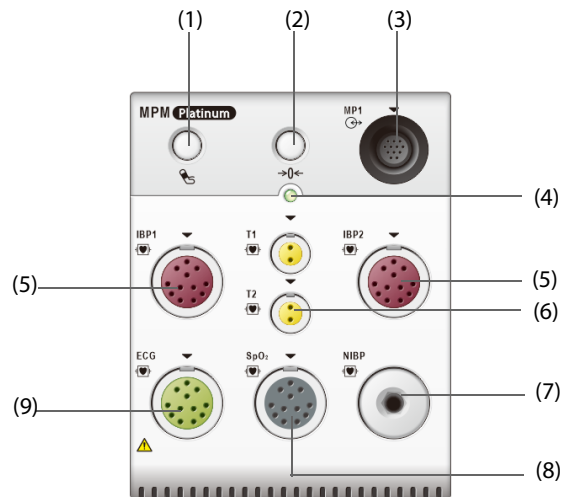

- (1) NIBP Start/Stop key: starts/stops NIBP measurement.
- (2) Zero hard key: enters the **Zero IBP** dialog.
- (3) Analog out connector: outputs defibrillation synchronization pulse, ECG, and IBP analog signal.
- (4) Module status indicator
 - ◆ On: the module works properly.
 - ◆ Flashing: the module is initializing.
 - ◆ Off: the module is not connected or the module fails.
- (5) Connector for IBP cable
- (6) Connector for Temp probe
- (7) Connector for NIBP cuff
- (8) Connector for SpO₂ cable
- (9) Connector for ECG cable

2.3.5.3 BeneVision N1

The BeneVision N1 is used as an MPM module when being connected to the monitor through the module rack (for N17, N15, N12), SMR or through the Dock.

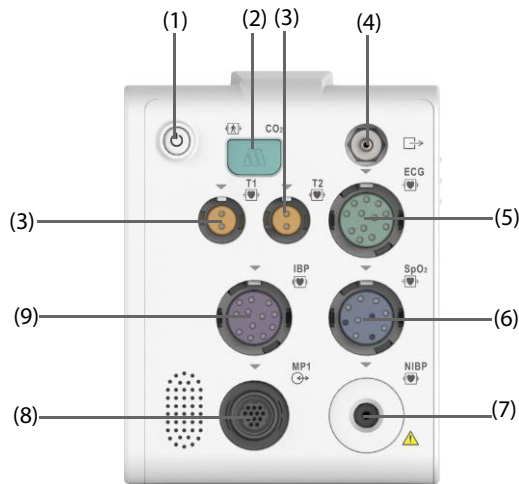

- (1) Power switch
- (2) Sample line connector for sidestream CO₂
- (3) Temperature probe connector
- (4) Gas outlet
- (5) ECG cable connector
- (6) SpO₂ sensor connector
- (7) NIBP cuff connector
- (8) Multifunctional connector: outputs analog ECG, IBP and defib synchronization signals.
- (9) IBP cable connector

2.3.5.4 T1

The T1 is used as an MPM module when being connected to the monitor through the module rack (for N17, N15, N12), SMR or through the T1 docking station.

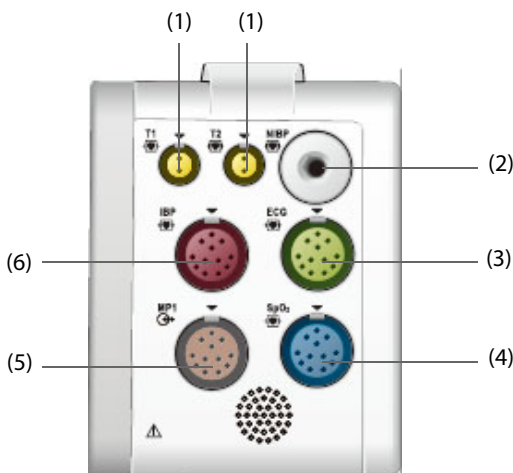

- (1) Temperature probe connector
- (2) NIBP cuff connector
- (3) ECG cable connector
- (4) SpO₂ sensor connector
- (5) Multifunctional connector: outputs analog ECG, IBP, and defibrillation synchronization signals.
- (6) IBP cable connector

2.3.6 Cable Management Kit

The cable management kit is installed at the bottom of the SMR.



(1) Handle: can hold the NIBP cuff

(2) Cable hooks: can hold the cables and leadwires

2.3.7 Input Devices

The monitor allows data entry through touchscreen, keyboard, mouse, navigation knob, remote controller, and barcode reader.

Only Mindray specified input devices should be used. For N22 and N19, the primary display and the secondary display can have independent mice and keyboards. When the secondary display is used as an extended display, one mouse and one keyboard can control both the primary display and the secondary display.

For N22 and N19, you can use the navigation knob to operate some features of the monitor, such as scrolling through lists. The navigation knob is installed at the bottom of the display. The primary display and the secondary display can have independent navigation knobs. When the secondary display is configured as an extended display, you can use one navigation knob to control both the primary display and the secondary display.

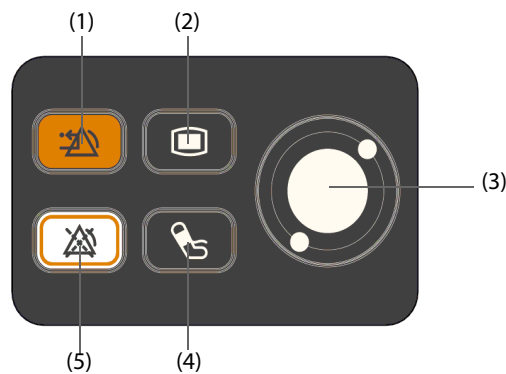

(1) Alarm Reset hard key: resets the alarm system

(2) Main Menu hard key: enters the main menu.

(3) Navigation knob

(4) NIBP Start/Stop hard key: starts an NIBP measurement or stops the current NIBP measurement

(5) Alarm Pause hard key: pauses physiological alarm system

2.3.8 Printing Devices

The monitor can use Mindray specified printer and/or recorder to output patient information and data.

N17, N15, N12 can be configured with a built-in recorder. If the built-in recorder is not available, an optional external recorder module is available.

For N22 and N19, to use the recorder, insert the recorder module into the SMR.

The printer can be connected to the monitor through the network to output patient reports.

3 Getting Started

3.1 Equipment Preparation Safety Information

WARNING

- Use only installation accessories specified by Mindray.
 - Connect only approved devices to this equipment. Devices connected to the equipment must meet the requirements of the applicable IEC standards (e.g. IEC 60950 safety standards for information technology equipment and IEC 60601-1 safety standards for medical electrical equipment). The system configuration must meet the requirements of the IEC 60601-1 medical electrical systems standard. Any personnel who connect devices to the equipment's signal input/output port are responsible for providing evidence that the safety certification of the devices has been performed in accordance to the IEC 60601-1. If you have any questions, please contact Mindray.
 - The monitor and parameter monitoring accessories are suitable for use within the patient environment. For other equipment and accessories connected to the monitor, consult corresponding manufacturers for the suitability within the patient environment.
 - If it is not evident from the equipment specifications whether a particular combination with other devices is hazardous, for example, due to summation of leakage currents, please consult the manufacturer or an expert in the field. A determination must be made that the proposed combination will not negatively affect the devices themselves or the patient's safety.
-

CAUTION

- The equipment should be installed by Mindray authorized personnel.
 - When disposing of the packaging material, be sure to observe the applicable waste control regulations and keep it out of children's reach.
 - Before use, verify whether the packages are intact, especially the packages of single use accessories. In case of any damage, do not apply it to the patient.
 - Make sure that the equipment operating environment meets the specific requirements. Otherwise unexpected consequences, e.g. damage to the equipment, could result.
 - Avoid rough handling during transport.
-

NOTE

- This manual is based on the maximum configuration and therefore some contents may not apply to the product. If you have any question, please contact Mindray.
 - Put the equipment in a location where it can be easily viewed and operated.
 - Keep this manual in the vicinity of the equipment so that it can be referenced when needed.
 - Save the packing case and packaging material as they can be used if the equipment must be reshipped.
 - Many settings in the patient monitor are password protected. It is recommended to change the default passwords and keep the passwords safe. Passwords should only be changed by authorized personnel. Contact the department manager or biomedical engineering department for the passwords used at the facility.
-

3.2 Monitor Installation

The monitor can be installed in various ways as required.

- Wall mount
- Installed on the medical supply unit

- Installed on the anesthesia machine

3.2.1 Unpacking and Checking

Before unpacking, examine the packaging carefully for signs of damage. If any damage is detected, contact the carrier, distributor, or Mindray.

If the packing case is intact, open the package and remove the equipment and accessories carefully. Check all materials against the packing list and check for any mechanical damage. Contact Mindray in case of any problems.

3.2.2 Environmental Requirements

The operating environment of the equipment must meet the requirements specified in this manual.

The environment where the equipment is used shall be reasonably free from noises, vibration, dust, corrosive, flammable and explosive substances. Moreover, to maintain good ventilation, the equipment shall be at least 2 inches (5cm) away from around the cabinet.

When the equipment is moved from one place to another, condensation may occur as a result of temperature or humidity difference. In this case, never start the system before the condensation evaporates.

CAUTION

- **Make sure that the equipment operating environment meets the specific requirements. Otherwise unexpected consequences, e.g. damage to the equipment, could result.**
-

3.3 Setting Up the Equipment

Observance of this manual is a prerequisite for proper product performance and correct operation. It ensures patient and operator safety.

3.3.1 Connecting the AC Mains

The monitor is powered by an AC power supply. Before connecting the equipment to the AC mains, check that the voltage and frequency ratings of the power line are the same as those indicated beside the AC power input.

To use the AC power source, follow this procedure:

1. Connect the female end of the power cord with the AC power input.
2. Connect the male end of the power cord with a wall AC outlet.
3. Check that the AC indicator is on.

The AC indicator is off if the AC mains is not connected. When AC mains is connected, the AC indicator is illuminated in green.

WARNING

- **Operate the equipment on battery power if the integrity of the protective earth conductor or the protective earthing system in the installation is in doubt.**
-

CAUTION

- **Always use the accompanying power cord delivered with the monitor.**
 - **Before connecting the equipment to the AC mains, ensure that the voltage and frequency ratings of the power line are the same as those indicated beside the AC power input.**
-

NOTE

- **Use the cable retainer to secure the power cord to prevent it from falling off.**
-

3.3.2 Connecting the Input Devices

Connect the mouse, keyboard, navigation knob, and/or barcode reader to the USB ports if necessary.

3.3.3 Connecting the SMR

To connect the SMR, use the SMR cable (PN: 009-005121-00 or 009-005122-00) to connect the monitor connector on the rear of SMR to the SMR connector on the main unit.

3.3.4 Connecting Modules to the SMR

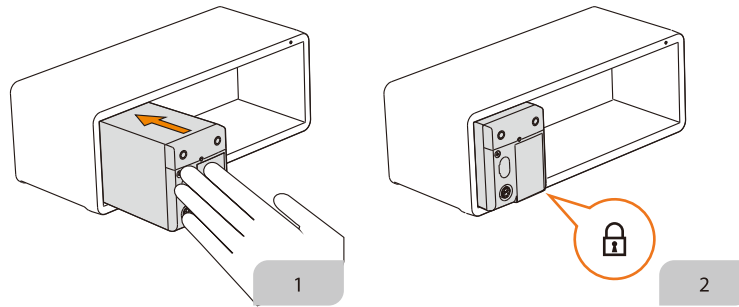

To connect a module to the SMR, follow this procedure:

1. With the module properly oriented, align the module insertion guide slot with the SMR insertion guide. Push the module into the SMR until there is a click.
2. Push the lock at the bottom of the module inwards to lock the module.

3.3.5 Removing Modules from the SMR

To remove a module from the SMR, follow this procedure:

1. Pull outwards on the lock at the bottom of the module to release the module.
2. Lift the latches at the bottom of the module and slide the module out of the SMR. Hold on the module securely to make sure it does not drop when it comes out.



- (1) Latch
- (2) Lock

CAUTION

- **When removing modules, be careful not to drop them. Modules may be heavier than expected, so securely supporting a module with two hands during removal is recommended.**
-

3.4 Turning on the Monitor

Before beginning measurements, turn on the monitor, perform the following inspections:

1. Check the monitor, SMR and modules for any mechanical damage. Make sure that all external cables, plugs and accessories are properly connected.
2. Connect the power cord to the AC power source.
3. Press the power switch to turn on the monitor. Secondary displays must be turned on separately.

When the monitor is turned on, the alarms are paused for two minutes. Then the alarm system is activated.

CAUTION

- **Check that visual and auditory alarm signals are presented correctly when the equipment is powered on.**
 - **Do not use the monitor for any monitoring procedure on a patient if you suspect it is not working properly, or if it is mechanically damaged. Contact the service personnel or Mindray.**
-

3.5 Operation and Navigation

Everything needed to operate the monitor is on its screen. Almost every element on the screen is interactive. Screen elements include parameter values, waveforms, quick keys, information fields, alarms fields, dialogs, and menus. Often you can access the same element in different ways. For example, you can access a parameter dialog by selecting the corresponding numeric area or waveform area, through the Menu hard key  on the parameter module, or through the **Parameters Setup** quick key.

3.5.1 Using the Touchscreen

You can use the touchscreen to select a screen element by pressing directly on the monitor's screen.

3.5.1.1 Tapping or Swiping across the Screen

- Tapping the screen
 - ◆ To select an item from menus or lists or select a quick key, tap on it with your finger.
 - ◆ To enter a parameter menu, tap the corresponding numeric area or waveform area. For example, select the ECG numeric area or waveform area to enter the **ECG** menu.
- Swiping the screen with a single finger
 - ◆ To scroll through a list or a menu, swipe up or down.
 - ◆ To show or expand the Minitrends screen or the EWS screen, swipe right across the corresponding screen.
 - ◆ To contract or hide the Minitrends screen or the EWS screen, swipe left across the corresponding screen.
- Swiping across the screen with two fingers
 - ◆ To switch to another screen, swipe left or right across the screen. For example, on the Normal screen, swipe with two fingers from left to right to switch to the Minitrends screen.
 - ◆ To discharge a patient, swipe from top to bottom.

3.5.1.2 Locking the Touchscreen

To avoid accidental use, you can temporarily disable the touchscreen by holding and pressing the **Main Menu** quick key and sliding as directed by the arrow. A padlock symbol  displays at the top of the main menu quick key if the touchscreen is disabled.

The touchscreen lock period is configurable. To do so, follow this procedure:

1. Access **Display** in either of the following ways:
 - ◆ Select the **Screen Setup** quick key → select the **Display** tab.
 - ◆ Select the **Main Menu** quick key → from the **Display** column select **Display**.
2. Set **Screen Lock Duration**.





The touchscreen is enabled when the preset time is reached. To manually enable the touchscreen, hold and press the **Main Menu** quick key and slide as directed by the arrow.

CAUTION

- **Check that the touchscreen is not damaged, broken, or loose. If there is any sign of damage, stop using the monitor and contact the service personnel.**
-

3.5.2 Using the On-Screen Keyboard

The on-screen keyboard enables information entry:

- Enter the information by selecting one character after another.
- Select the Backspace key  to delete single characters or select  to delete the entire entry.
- Select the Caps Lock key  to access uppercase letters.
- Select the Enter key  to confirm the entry and close the on-screen keyboard.

If a conventional keyboard is connected to the monitor, you can use it instead of, or in combination with, the on-screen keyboard.

3.5.3 Using the Navigation Knob (for N22/N19)

You can use the navigation knob and associated buttons to access the main menu, pause alarms, reset alarms, and start/stop NIBP measurements.

3.5.4 Using the Barcode Reader

The monitor supports both a linear (1D) barcode reader and two-dimensional (2D) barcode reader. The barcode reader is connected to the monitor's MSB connector (for N22/N19) or the USB connector (N17/N15/N12).

NOTE

- **Use the Mindray custom barcode reader to obtain all the available patient information from both the 2D and 1D barcodes. Using other barcode readers can only output the patient's medical record number (MRN) and visit number.**
-

3.5.4.1 Clearing Old Data Formats (for the Mindray Custom 2D Barcode Reader)

If you are using the Mindray custom 2D barcode reader (Model HS-1R or HS-1M), before using the it for the first time, clear old data formats and configure the barcode reader. To do so, follow this procedure:

1. Scan the engineering barcode to clear the previous data format.
2. Scan the 2D engineering barcode which contains the hospital's data format.

NOTE

- **Contact the scanner manufacturer or Mindray to obtain the barcodes for clearing data formats and programming the hospital's data format.**
-

3.5.5 Using the Remote Controller

The remote controller can control the monitor by connecting the receiver of the remote controller to the monitor's MSB connector (for N22/N19) or the USB connector (N17/N15/N12). For more information on how to use the remote controller, see the Instructions for Use delivered with the remote controller.

3.6 Screen Display



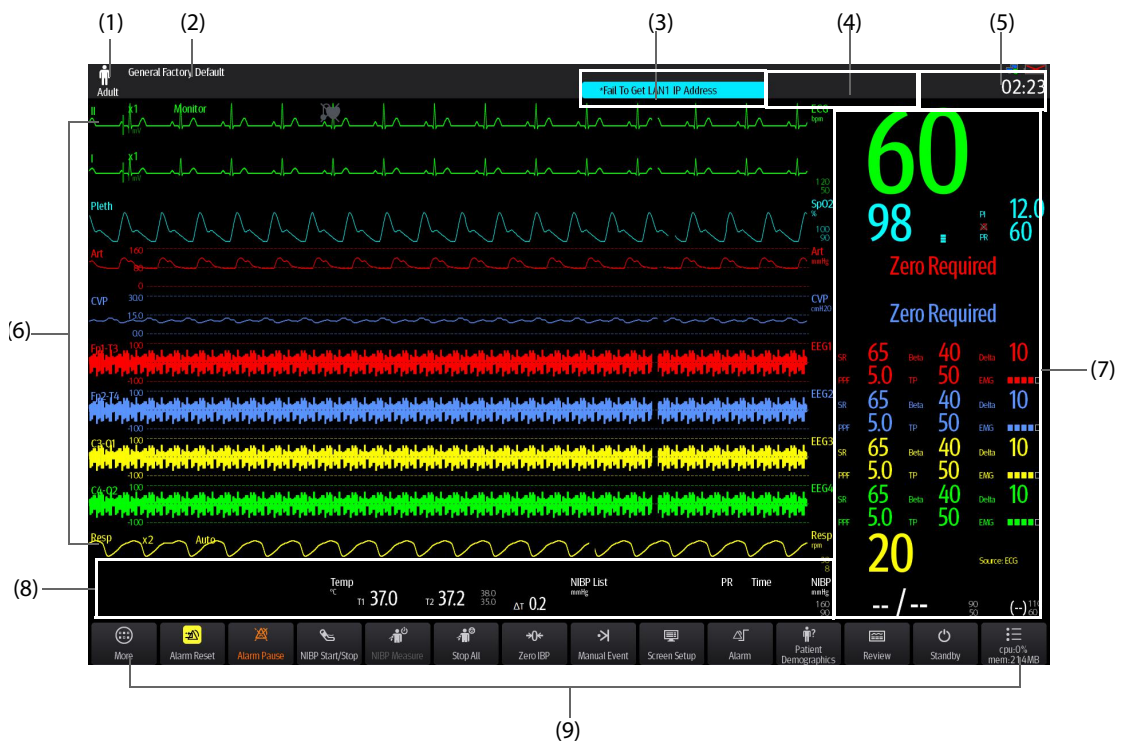

The following figure shows the normal screen:



- (1) Patient information area: displays patient information, including patient category, gender, department, room number, bed number, and so on. The displayed patient information is configurable. Selecting this area enters the **Patient Management** dialog. For more information, see 5.2.1 *Entering the Patient Management Dialog*.
- (2) The current configuration: displays the name of the configuration that can be loaded from the main menu.
- (3) Technical alarm information area: displays prompt messages at the top; displays technical alarm messages at the bottom.
- (4) Physiological alarm information area: displays high priority physiological alarms at the top; displays medium and low priority physiological alarms at the bottom.
- (5) System status information area: displays alarm symbol, battery status, network status, currently connected CMS, storage device status, and system time. For more information, see 3.6.1 *On-screen Symbols*.
- (6) Parameter waveform area: displays parameter waveforms, measurement ranges, and magnification. Selecting a waveform enters the corresponding parameter dialog.
- (7) Parameter numerics area: displays parameter values, alarm limits, and alarm status. This area can also display the parameter list. For more information, see 3.9.3 *Displaying the Parameter List*. Selecting a parameter numeric block enters the corresponding parameter dialog. Selecting the parameter list enters Tabular Trends review.
- (8) Parameter waveform/numerics area: unique area of the screen that can be configured to display either parameter numerics or parameter waveforms. Depending on the configuration, the tiles take on the characteristics of either area (6) or area (7).
- (9) Quick key area: displays quick keys.

3.6.1 On-screen Symbols

The following table lists the on-screen symbols displayed on the system status information area:

Symbol	Description	Symbol	Description
	Adult, male		Adult, female
	Pediatric, male		Pediatric, female

Symbol	Description	Symbol	Description
	Neonate, male		Neonate, female
	Wireless network is connected. The solid part indicates network signal strength.		Wireless network is not connected.
	Wired network is connected.		Wired network is not connected.
	All the alarms are paused.		Individual physiological alarms are turned off or the monitor is in the alarm off status.
	Audible alarm tones are paused.		Audible alarm tones are turned off.
	The alarm system is reset.		The battery is working correctly. The green portion represents the remaining charge.
	The battery has low power and needs to be charged.		The battery has critically low charge and needs to be charged immediately. Otherwise, the monitor will automatically shut down soon.
	The battery is being charged.		No battery is installed.

3.6.2 Dialogs

All dialogs have similar style and structure, see the figure below:

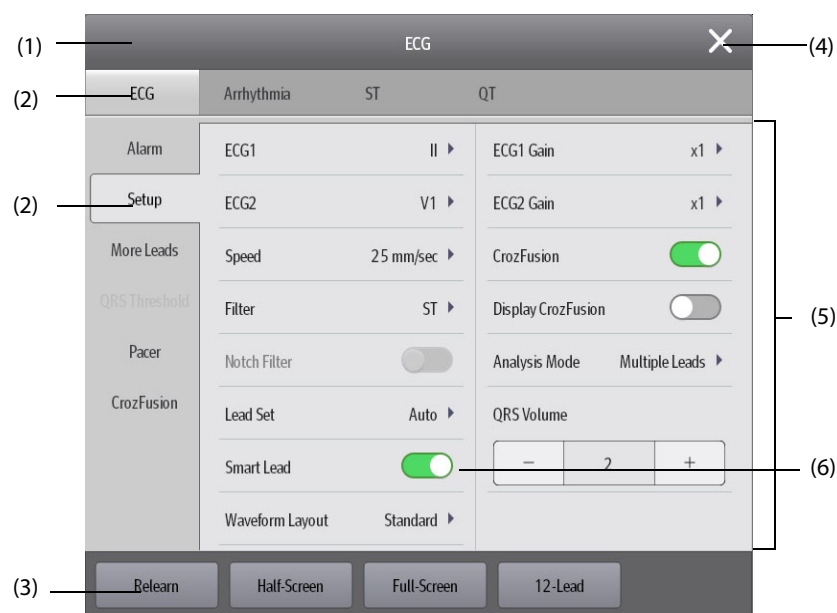

(1) Dialog heading

















- (2) subdialog tabs
- (3) Operation buttons
- (4) Exit button: closes the current dialog.
- (5) Main body area: includes dialog items and options.
- (6) Switch:
 - ◆ Green: the switch is on.
 - ◆ Gray: the switch is off.

3.6.3 Quick Keys









The monitor provides quick keys for you to quickly access some functions. The quick key area is located at the bottom of the screen. Normally the quick key area displays 14 quick keys (12 quick keys for N12). The **Main Menu** key is permanently located the right, and the **More** key is permanently located at the left. Selecting the **More** quick key shows more quick keys. The quick keys displayed on the screen are configurable.

3.6.3.1 Available Quick Keys

The following table shows available quick keys.

Symbol	Label	Function	Symbol	Label	Function
	Main Menu	Enters the main menu.		Alarm Reset	Resets the alarm system.
	Alarm Pause	Pauses the physiological alarm system (Availability depends on configuration of Pause in Maintenance → Alarm → Pause/Reset dialog).		Audio Pause	Pauses alarm tone (Availability depends on configuration of Pause in Maintenance → Alarm → Pause/Reset dialog).
	Screen Setup	Enters the Screen Setup dialog.		Standby	Enters the standby mode.
	Manual Event	Manually saves an event into the Events list.		Print	Starts printing a real-time report.
	NIBP Start/Stop	Starts an NIBP measurement or stops the current NIBP measurement.		NIBP Measure	Opens the NIBP Measure interval options.
	NIBP STAT	Starts a five-minute continuous NIBP measurement.		NIBP Stop All	Stops all NIBP measurements.
	Alarm Setup	Enters the Alarm dialog.		More	Shows more quick keys.
	Zero IBP	Enters the Zero IBP dialog.		C.O. Measure	Opens the C.O. Measure screen.

Symbol	Label	Function	Symbol	Label	Function
	PAWP	Opens the PAWP screen.		Loops	Opens the Loops screen.
	Venipuncture	Inflates the NIBP cuff to help venous puncture.		Start TOF	Starts/stops TOF measurement.
	Parameters Setup	Enters the Parameters Setup dialog.		Remote View	Opens the Remote View screen to view other patients.
	Review	Enters the Review dialog to review historical data.		Minitrends	Opens the Minitrends screen.
	OxyCRG	Opens the OxyCRG screen.		ECG Full-Screen	Opens the ECG full screen.
	Privacy Mode	Enters the privacy mode.		Night Mode	Enters the night mode.
	CPB Mode	Enters the CPB mode.		Intubation Mode	Enters the intubation mode.
	Volume	Enters the Volume dialog.		Freeze	Freezes waveforms.
	Calculations	Enters the Calculations dialog.		Load Config	Enters the Load Config dialog.
	Patient Management	Enters the Patient Management dialog.		Record	Starts/Stops a recording.
	Integrated Devices	Opens the Integrated Devices screen		Rotate Screen (N22 and N19 only)	Changes the screen orientation.
	ECG Lead/Gain	Enters the ECG Lead/Gain dialog.		Call Help	Sends the Call Help signal over the network.
	HemoSight	Enters the HemoSight dialog.		EWS	Opens the EWS screen.
	GCS	Enters the GCS dialog.		SepsisSight	Enters the SepsisSight dialog.

Symbol	Label	Function	Symbol	Label	Function
	Discharge Patient	Enters the Discharge Patient dialog to discharge the patient and restore pre-configured default settings.		Discharged Patients	Enters the Discharged Patients dialog and displays previously discharged patients.
	ECG 24h Sum	Views the 24-hour ECG summary.		End Case Report	Prints the selected end case reports
	Bedside Devices	Enters the Bedside Devices dialog.		Targeted Goal	Opens the Targeted Goal screen.
	BoA Dashboard	Opens the BoA Dashboard screen.		Resus Mode	Enters the resus mode.

3.6.3.2 Configuring the Displayed Quick Keys

To select the quick keys for display, follow this procedure:

1. Access **Quick Keys** in either of the following ways:
 - ◆ Select the **Screen Setup** quick key → the **Select Quick Keys** tab.
 - ◆ Select the **Main Menu** quick key → from the **Display** column select **Quick Keys**.
2. Select the **Current** tab to configure the quick keys for display on the screen: From the top of this page, select a block location to show a certain quick key, and then select the quick key from the quick key list. For example, to show the **Screen Setup** quick key at the first block, select the first block, and then select **Screen Setup** from the list.
3. Select the **More** tab to configure the quick keys for display when the **More** quick key is selected.

3.7 Operating Modes

The monitor provides different operating modes. This section describes the different monitoring modes and standby modes.

3.7.1 Monitoring Mode

The monitoring mode is the most frequently used clinical mode for patient monitoring. When the monitor is turned on, it automatically enters the monitoring mode.

3.7.2 Privacy Mode

The privacy mode is a special clinical monitoring mode. In the privacy mode, the monitor does not display patient information and monitoring data. This provides controlled access to patient data and ensures confidentiality.

The privacy mode is only available when the patient admitted by the monitor is also monitored by the CMS. The monitor continues monitoring the patient, but patient data is only visible at the CMS.

3.7.2.1 Entering the Privacy Mode

To enter the privacy mode, choose either of the following ways:

- Select the **Privacy Mode** quick key → select **Ok**.
- Select the **Main Menu** quick key → from the **Display** column select **Privacy Mode** → select **Ok**.

The monitor has the following features after entering the privacy mode:

- The screen turns blank.

- Except for the low battery alarm, the monitor inactivates alarm tones and alarm lights for all other alarms.
- The monitor suppresses all system sounds, including heart beat tone, pulse tone, and prompt tone.

WARNING

- **In the privacy mode, all audible alarms are suppressed and the alarm light is deactivated at the monitor. Alarms are presented only at the CMS. Pay attention to potential risk.**
-

NOTE

- **The privacy mode is not available if the Department is set to OR.**
 - **You cannot enter the privacy mode if a low battery alarm is active.**
-

3.7.2.2 Exiting the Privacy Mode

The monitor automatically exit the privacy mode in any of the following situations:

- The monitor disconnects from the CMS.
- The low battery alarm occurs.

You can also operate the touchscreen, mouse, or keyboard to manually exit the privacy mode.

3.7.3 Night Mode

The night mode is a special clinical monitoring mode. The night mode reduces screen brightness, sound volumes, and pauses NIBP measurements. To avoid disturbing the patient, you can use the night mode.

3.7.3.1 Entering the Night Mode

To enter the night mode, follow this procedure:

1. Select the **Night Mode** quick key, or select the **Main Menu** quick key → from the **Display** column select **Night Mode**.
2. Change the night mode settings if necessary.
3. Select **Enter Night Mode**.

The night mode settings are as follows by default:

- **Brightness: 1**
- **Alarm Volume: 2**
- **QRS Volume: 1**
- **Key Volume: 0**
- **NIBP End Tone: Off**
- **Stop NIBP: Off**

CAUTION

- **Verify the night mode settings before entering the night mode. Pay attention to the potential risk if the setting value is low.**
-

3.7.3.2 Exiting the Night Mode

To cancel the night mode, follow this procedure:

1. Select the **Night Mode** quick key, or select the **Main Menu** quick key → from the **Display** column select **Exit Night Mode**.
2. Select **Ok**.

NOTE

- **If the monitor is connected to the CMS, it automatically exits the night mode if disconnected from the CMS.**
 - **The monitor resumes the previous settings after exiting the night mode.**
-

3.7.4 Standby Mode

You can temporarily stop patient monitoring without switching off the monitor by entering the standby mode.

3.7.4.1 Entering the Standby Mode

1. Select the **Standby** quick key, or select the **Main Menu** quick key → from the **Patient Management** column select **Standby**.
2. Define where the patient is by selecting a location in the drop down list when the monitor enters the standby mode.
3. Select **Ok**.

The monitor behaves as follows after entering the standby mode:

- Stops all parameter measurements.
- Disables all the alarms and prompt messages, except for the battery low alarm.
- Turns screen brightness to the dimmest after entering the standby mode for 30 seconds.

WARNING

- **Pay attention to the potential risk of placing the monitor to standby. In the standby mode, the monitor stops all parameter measurements and disable all the alarm indications, except for the battery low alarm.**
-

3.7.4.2 Changing the Patient Location at Standby

To change the patient's location, select patient location from the Standby screen.

3.7.4.3 Exiting the Standby Mode

To exit the standby mode, choose any of the following ways:

- Select **Resume Monitor** to exit the standby mode and resume monitoring the current patient.
- Select **Discharge Patient** to discharge the current patient.

If the monitor automatically enters the standby mode after a patient is discharged, choose any of the following ways to exit the standby mode:

- Select **Monitor** to exit the standby mode and admit a new patient.
- Select **Patient Management** to enter the patient information for preparing to admit a new patient.

When the monitor exits Standby mode and resumes monitoring, the alarms are paused for two minutes, after which the alarm system is activated.

3.7.5 Discharge Mode

The discharge mode is a special standby mode after a patient is discharged.

3.8 Configuring the Monitor

Configure the monitor before putting it in use.

3.8.1 Setting the Screen Orientation (for N22 and N19)

Both the primary display and the secondary display can be installed vertically or horizontally. Set the screen orientation accordingly. To do so, follow this procedure:

1. Access **Display** in either of the following ways:
 - ◆ Select the **Screen Setup** quick key → select the **Display** tab.
 - ◆ Select the **Main Menu** quick key → from the **Display** column select **Display**.
2. Select **Screen Orientation** to set the screen orientation of the corresponding display.
 - ◆ **Portrait**: if the display is vertically installed, set **Screen Orientation** to **Portrait**.
 - ◆ **Landscape**: if the display is horizontally installed, set **Screen Orientation** to **Landscape**.

You can select the **Rotate Screen** quick key to quickly switch the screen orientation.

3.8.2 Setting the Date and Time

To set the system time, follow this procedure:

1. Select the **Main Menu** quick key → from the **System** column select **Time**.
2. Set **Date** and **Time**.
3. Set **Date Format**.
4. If you want to use the 12-hour mode, switch off **24 Hour Time**.
5. If you want to use daylight saving time, switch on **Daylight Saving Time**. You can manually switch on or off the daylight saving time only when the auto daylight saving time function is disabled. For more information, see *33.8.2 Enabling Auto Daylight Savings Time* for details.

If the monitor is connected to a central monitoring system (CMS) or hospital clinical system (HIS), the date and time are automatically taken from the CMS. In this case, you cannot change the date and time on the monitor.

CAUTION

- **Changing the date and time affects the storage of trends and events and may result in loss of data.**
-

3.8.3 Adjusting the Screen Brightness

To adjust the screen brightness, follow this procedure:

1. Access **Display** in either of the following ways:
 - ◆ Select the **Screen Setup** quick key → select the **Display** tab.
 - ◆ Select the **Main Menu** quick key → from the **Display** column select **Display**.
2. Set **Brightness**. If **Brightness** is set to **Auto**, the monitor automatically adjust the screen brightness according to the ambient light.

NOTE

- **The brightness of the primary screen and secondary screen can be adjusted separately.**
-

3.8.4 Adjusting the Volume

- Set **Alarm Volume** in either of the following ways:
 - ◆ Select the **Volume** quick key.
 - ◆ Select the **Main Menu** quick key → from the **Alarm** column select **Setup**.
- Set **Reminder Volume** by selecting the **Main Menu** quick key → from the **Alarm** column select **Setup**.
- Set **QRS Volume** in any of the following ways:
 - ◆ Select the **Volume** quick key.
 - ◆ From the ECG dialog select **Setup**.

- ◆ From the SpO₂ dialog select **PR Setup**.
- Select the **Volume** quick key to set **Key Volume**.

3.9 General Operation

This section describes the operations that are generally used when monitoring a patient.

3.9.1 Switching On or Off a Parameter

You can manually switch on or off a parameter when its module is connected. If setting parameter switches is not password protected, follow this procedure to set parameter switches:

1. Access **Parameters On/Off** in either of the following ways:
 - ◆ Select the **Screen Setup** quick key → select the **Parameters On/Off** tab.
 - ◆ Select the **Main Menu** quick key → from the **Parameters** column select **Parameters On/Off**.
2. Switch on or off desired parameters.

When a parameter is switched off, the monitor stops data acquisition and alarming for this measurement.

NOTE

- **When a parameter is manually switched off, you cannot monitor this parameter even if corresponding parameter module is plugged in and related accessories of this parameter are connected.**

3.9.2 Displaying Parameter Numerics and Waveforms

You can configure the parameter numerics, waveforms, and their sequence displayed on the normal screen. To do so, follow this procedure:

1. Access **Tile Layout** in either of the following ways:
 - ◆ Select the **Screen Setup** quick key → select the **Tile Layout** tab.
 - ◆ Select the **Main Menu** quick key → from the **Display** column select **Tile Layout**.
2. Select a parameter numeric area or waveform area, and then from the popup list select an element you want to display in this area. The parameters and waveforms you did not select will not displayed.

If you are using the independent secondary display, you can select parameter and waveform locations on the secondary display.

3.9.3 Displaying the Parameter List

You can display the trends of HR, SpO₂, RR, and NIBP/IBP in the parameter numerics area. To do so, follow this procedure:

1. Access **Tile Layout** in either of the following ways:
 - ◆ Select the **Screen Setup** quick key → select the **Tile Layout** tab.
 - ◆ Select the **Main Menu** quick key → from the **Display** column select **Tile Layout**.
2. Select the parameter numerics area where you want to display the parameter list, and then from the popup list select **Parameter List**.

3.9.4 Accessing Parameter Setup Dialogs

Each parameter has a setup dialog in which you can adjust the alarm and parameter settings. You can enter a parameter setup dialog by using any of the following methods:

- Select the parameter numeric area or waveform area.
- Press the setup hard key  on the module front.
- Select the **Parameters Setup** quick key, and then select the desired parameter.

- Select the **Main Menu** quick key → from the **Parameters** column select **Setup** → select the desired parameter.

NOTE

- **In this manual, we always use the first method to enter the setup dialog. But you can use any method you prefer.**
-

3.9.5 Changing Measurement Colors

You can set the color of measurement values and waveforms for each parameter. To do so, follow this procedure:

1. Select **Main Menu** quick key → from the **Parameters** column select **Parameter Color**.
2. Select the **Current** tab and set the colors of the currently monitoring measurement values and waveforms.
3. Select the **All** tab and set the colors of measurement values and waveforms for all parameters.

3.10 Freezing Waveforms

During patient monitoring, the freeze feature allows you to freeze the currently displayed waveforms on the screen so that you can have a close examination of the patient's status. Additionally, you can select any frozen waveform for recording.



3.10.1 Freezing Waveforms

To freeze waveforms, select the **Freeze** quick key. Except waveforms of the following screens, all displayed waveforms stop refreshing and scrolling after you select the **Freeze** quick key:

- **Minitrends** screen
- **OxyCRG** screen
- **Remote View** screen
- **BoA Dashboard** screen
- **EWS** screen

3.10.2 Viewing Frozen Waveforms

To view the frozen waveforms, follow this procedure:

- Select the  or  button in the **Freeze** screen.
- Slide the frozen waveform leftward or rightward.

At the lower right corner of the bottom-most waveform displays the freeze time. The initial frozen time is **0 s**. With the waveforms scrolling, the freeze time changes at an interval of 1 second. For example, **-2 s** means two seconds before the frozen time. This change will be applied for all waveforms on the screen.

NOTE

- **You can view the frozen waveforms of up to 120 seconds.**
-

3.10.3 Unfreezing Waveforms

To unfreeze the frozen waveforms, select the  button at the upper right corner of the **Freeze** Big Numerics.

3.10.4 Printing Frozen Waveforms

To print the frozen waveforms, select the  button at the upper left corner of the **Freeze** Big Numerics.

3.11 N22 and N19 Secondary Display

The secondary display of N22/N19 has the following features:

- Be able to connect independent input devices.
- Provides visual and audible alarm indications.

The secondary display runs on independent AC mains through a DC adapter. To use the secondary display, turn it on and verify that it is connected before turning on the monitor. The secondary display does not support hot swapping. If the secondary display is disconnected from the main unit, the primary display will announce an alarm.

3.11.1 Connecting the Secondary Display Power Supply (for N22/N19)

You need a power adapter to convert the AC mains to DC so as to power the secondary display. Before connecting the power adapter, check that the power adapter meets the specification.

To connect the power supply, follow this procedure:

1. Connect one end of the power adapter to the DC-IN connector on the secondary display.
2. Connect the other end of the power adapter to the AC mains.
3. Check that the AC indicator on the secondary display is on.

CAUTION

- Use only Mindray-specified power adapters for powering Mindray displays.
-

3.11.1.1 Setting Secondary Display Orientation (for N22/N19)

If the secondary display is an independent display or an extended display, you can set its orientation if necessary. See 3.8.1 *Setting the Screen Orientation (for N22 and N19)* for details.

NOTE

- If the secondary display is a mirror display, its orientation is the same with the primary display and cannot be set separately.
-

3.11.1.2 Setting Secondary Display Brightness (for N22/N19)

See 3.8.3 *Adjusting the Screen Brightness* for details.

3.11.2 Setting the ECG Waveform Size for the Independent External Display (for N17/N15/N12)

For N17/N15/N12 monitors, if the independent external display is connected, you can set the speed and amplitude scales of the ECG waveforms for displays of different dimensions to achieve the best display effect. To do so, follow this procedure:

1. From the independent external display screen, select the **Main Menu** quick key → from the **System** column select **Maintenance** → input the required password → select .
2. Select **Display** → select the **Screen Size** tab.
3. Select the screen size.
4. Adjust the speed and amplitude of the ECG waveform by setting the scale so that 1 cm on the scale is actually equal to one centimeter.
5. Restart the monitor.

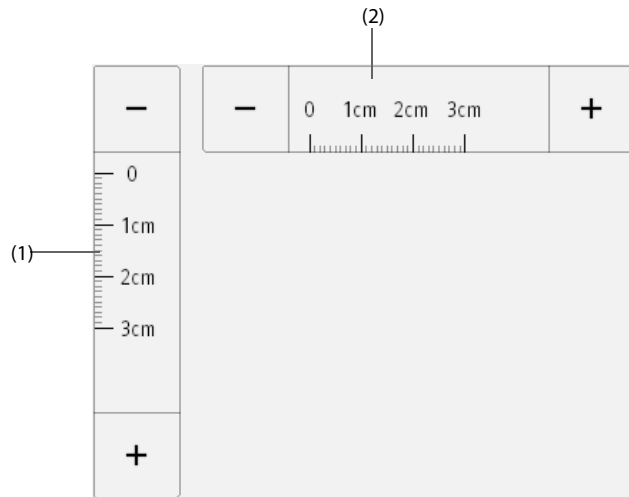

- (1) Adjust the amplitude of the ECG waveform
 (2) Adjust the speed of the ECG waveform

NOTE

- The setting of Screen Size for the independent external display takes effect only after the monitor restarts.

3.12 Using the iView System

The iView system provides a means of running clinical applications on a monitor for obtaining other patient data. The application data from the iView can show on the monitor's display or on the iView display.

For more information on iView, see *iView System Operator's Manual (PN: 046-012637-00)*.

WARNING

- Some clinical applications may show data from another patient. Be aware that some of the data on the patient monitor display may not always be from a single patient.
- Applications running on the iView cannot act as a primary alarming device and cannot be relied upon for alarm notification. There may be no audible or visible indications apart from what is shown on the screen, and any data shown may be delayed.

CAUTION

- Always use AC mains to run the monitor if iView is in use.
- Ensure that any software installed on the iView complies with all relevant local regulations.
- iView is an independent PC platform that enables running third-party applications. The monitor runs independently of the iView, and vice versa. It is the user's responsibility to maintain iView security patches in compliance with hospital PC policy. The user's IT administrator should determine what security patches and policies needed after third-party applications are installed.

3.13 Capturing the Screen

The monitor provides the function of screen capture. To capture the current screen display, follow this procedure:

1. Connect the USB drive to the monitor's MSB connector (for N22/N19) or the USB connector (N17/N15/N12).
2. Press and hold the **More** quick key. Wait until it turns from blue to grey.

The captured pictures are automatically saved in the USB drive.

3.14 Connecting the CMS

You can connect the monitor to the BeneVision CMS through wired LAN or wireless LAN. When connected to the CMS, the system provides the following function.

- The monitor can transmit parameter values, waveforms, alarms, and events to the CMS. From the CMS, you can check the patient's monitoring data and alarms.
- The monitor can transmit parameter values and alarms from the connected external devices to the CMS. From the CMS you can check the patient's monitoring data and alarms obtained from the connected external devices.
- Patient information, alarm settings, and alarm status can be synchronized between the monitor and the CMS.
- You can start or stop NIBP measurements from the CMS.
- In case of network disconnection, the monitor can transmit the offline data to the CMS when the network is reconnected.

For more information on the CMS, see the operator's manual of corresponding central monitoring system.

To select a CMS, select the system status information area at the top right corner of the main screen. Select the desired CMS from the popup CMS list.

NOTE

- **You can select CMS only when the Select CMS switch is on. For more information, see 33.13.6 Enabling Selecting a CMS.**

3.15 Connecting the eGateway

You can connect the monitor to the eGateway through wired LAN or wireless LAN to implement interaction between the monitor and external devices. When connected to the eGateway, the system provides the following functions:

- The monitor can transmit parameter values, waveforms, alarm settings, and events to the eGateway.
- The monitor can transmit parameter values and alarm settings received from the BeneLink-connected external devices to the eGateway.
- Clock can be synchronized between the monitor and the eGateway.

3.16 Connecting the Wireless Network

You can add up to five wireless networks for the monitor. For more information, see 33.13.4 *Setting the Wireless Network*.

If connecting the current wireless network fails, the monitor automatically connects other wireless networks in the order when they were added.

To manually switch the wireless network, from the system status information area on the top right corner of the screen select , and select the desired wireless network.

3.17 Disconnecting the Wireless Network

To disconnect the wireless network manually, follow this procedure:

1. Swipe the screen from top down with a single finger.
2. Select .

To reconnect the wireless network after it is disconnected manually, follow this procedure:

1. Swipe the screen from top down with a single finger.
2. Select .

3.18 Turning Off the Monitor

Before turning off the monitor, perform the following check:

1. Ensure that monitoring of the patient has been completed.
2. Disconnect the cables and sensors from the patient.
3. Save or clear the patient data as required.

To turn off the monitor, press and hold the power switch for 3 seconds.

CAUTION

- **Press and hold the power switch for 15 seconds (for N22/N19) or 10 seconds (for N17/N15/N12) to forcibly shut down the monitor if it could not be shut down normally. This may cause loss of patient data.**
-

NOTE

- **Turning off the monitor does not disconnect the monitor from the AC mains. To completely disconnect the power supply, unplug the power cord.**
 - **If a monitor is on during a power loss, then the monitor is automatically switched on when the power is restored.**
 - **In case of a temporary power failure, if the power is restored within 30 minutes, monitoring will resume with all active settings unchanged. If the monitor is without power for more than 30 minutes, it behaves the same as if it were normally turned off.**
-

This page intentionally left blank.

4 User Screens

The monitor provides different user screens to facilitate patient monitoring in different departments and clinical applications.

4.1 Choosing a Screen

The monitor enters the normal screen after it is powered on. The normal screen is most frequently used for patient monitoring. To select other screens, follow this procedure:

1. Access the **Choose Screen** tab in either of the following ways:
 - ◆ Select the **Screen Setup** quick key.
 - ◆ Select the **Main Menu** quick key → from the **Display** column select **Choose screen**.
2. Select the desired screen.

4.2 Normal Screen

The normal screen is most frequently used for patient monitoring. For general department, ICU, and CCU, normal screen is used by default.

4.2.1 Entering the Normal Screen

To enter the normal screen, choose any of the following ways:

- Swipe left or right on the touchscreen with two fingers to switch to the normal screen.
- Select the **Screen Setup** quick key → select the **Choose Screen** tab → select **Normal Screen**.
- Select the **Main Menu** quick key → from the **Display** column select **Choose Screen** → select **Normal Screen**.

4.2.2 Configuring the Normal Screen

You can configure the parameter numerics, waveforms, and their sequence displayed on the normal screen. To do so, follow this procedure:

1. Access **Tile Layout** in either of the following ways:
 - ◆ Select the **Screen Setup** quick key.
 - ◆ Select the **Main Menu** quick key → from the **Display** column select **Tile Layout**.
2. Select a parameter numeric area or waveform area, and then from the popup list select an element you want to display in this area. The parameters and waveforms you did not select will not be displayed.

4.3 The Big Numerics Screen

The Big Numerics screen displays parameter numerics in big font size. The Big Numerics screen displays measurement values and waveforms of up to six parameters. You can configure the parameters and their layout on the big numeric screen.

4.3.1 Entering the Big Numerics Screen

To enter the big numerics screen, choose any of the following ways:

- Swipe left or right on the touchscreen with two fingers to switch to the big numerics screen.
- Select the **Screen Setup** quick key → select the **Choose Screen** tab → select **Big Numerics**.
- Select the **Main Menu** quick key → from the **Display** column select **Choose Screen** → select **Big Numerics**.

4.3.2 Configuring the Big Numerics Screen

To configure the big numerics screen, follow this procedure:

1. Access **Choose Screen** in either of the following ways:
 - ◆ Select the **Screen Setup** quick key .
 - ◆ Select the **Main Menu** quick key → from the **Display** column select **Choose Screen**.
2. Select the **Big Numerics** tab
3. Select a parameter numeric area or waveform area, and then from the popup list select an element to display in this area.

■

4.4 Minitrends Screen

The Minitrends screen shows the recent graphic trends of parameters.

4.4.1 Entering the Minitrends Screen

Choose one of the following methods to enter the Minitrends screen:

- Swipe left or right on the touchscreen with two fingers to switch among the Minitrends screen, normal screen, and the big numerics screen.
- Select the **Minitrends** quick key.
- Select the **Screen Setup** quick key → Select the **Choose Screen** tab → select **Minitrends**.
- Select the **Main Menu** quick key → from the **Display** column select **Choose Screen** → select **Minitrends**.

For adult and pediatric patients, when the Minitrends screen is hidden as , you can also choose one of the following methods to quickly enter the Minitrends screen.

- Swipe left or right across the touchscreen with two fingers until you switch to the Minitrends screen.
- Swipe right across the touchscreen with a single finger.
- Select the  button.

4.4.2 The Display of Minitrends Screen

The following figure shows the minitrends screen. Your display may be configured to look slightly different.

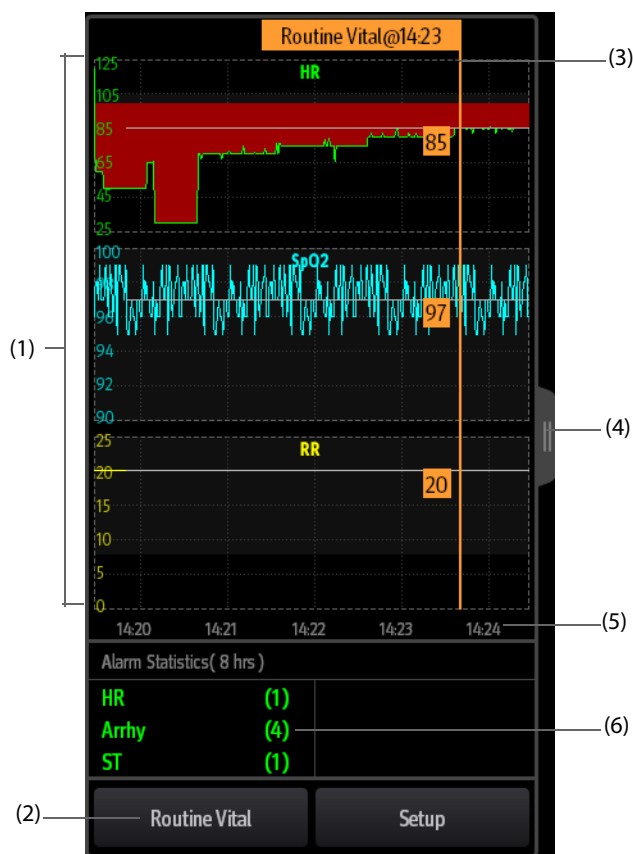

- (1) Scale
- (2) **Routine Vital** button. If the department is set to **OR**, then the **Baseline** button is displayed.
- (3) Routine Vital/Baseline
- (4) Select this button to view the long trends, or contract the long trends screen to the Minitrends screen.
- (5) Time line
- (6) Alarm statistic area

4.4.3 Viewing the Long Trends

To expand the Minitrends screen to view the long trends, choose either of the following ways:

- Select the  button.
- Swipe right across the Minitrends screen with a finger.

4.4.4 Setting Minitrends Parameters

To set parameters, follow this procedure:

1. Enter the Minitrends screen.
2. Select the **Setup** button.
3. Set parameters. If you want to use the default parameters, select **Default Parameter**.

4.4.5 Setting the Minitrend Length

To set the Minitrend length, follow this procedure:

1. Enter the Minitrends screen.

2. Select the **Setup** button.
3. Set the **Minitrend Length**.

4.4.6 Setting the Alarm Statistics Switch

The Minitrends screen can be configured to display the statistic number of physiological alarms in its lower half screen. To set the alarm statistics switch, follow this procedure:

1. Enter the Minitrends screen.
2. Select the **Setup** button.
3. Switch on or off the **Alarm Statistics** switch.

4.4.7 Setting the Alarm Statistics Duration

The time length within which the alarms statistics are made is configurable. To set the alarm statistics length, follow this procedure:

1. Enter the Minitrends screen.
2. Select the **Setup** button.
3. Set **Alarm Statistics Duration**.

4.4.8 Routine Vital/Baseline

The Routine vital/Baseline function is used for marking the parameter measurements of certain moment for later reference. If the department is set to **OR**, then the **Baseline** button is available. For other departments, the **Routine Vital** button is available.

4.4.8.1 Manually Marking the Routine Vital/Baseline

To manually mark the Routine Vital/Baseline, follow this procedure:

1. Enter the Minitrends screen.
2. Select the **Routine Vital** button or **Baseline** button.

NOTE

-
- **If you do not see the Baseline button or Routine Vital button in the Minitrends screen, you can select the Setup button and switch on the Baseline switch, or set the Routine Vital to Manual or Auto.**
-

4.4.8.2 Configuring Automatic Routine Vital Settings

The monitor can automatically mark the routine vital sign values. To enable this function, follow this procedure:

1. Enter the Minitrends screen.
2. Select the **Setup** button.
3. Select **Auto** from the dropdown list of **Routine Vital**.
4. Select **Time** to set the time for marking the first routine vital sign values.
5. Select **Interval** to set the interval for marking the routine vital sign values.

4.5 The OxyCRG Screen

The monitor displays the OxyCRG screen by default when the neonatology department is selected. The OxyCRG screen is available in any department setting, but only when the patient size is set to **Neo**. This screen displays 6-minute HR, SpO₂ trends, CO₂/Resp compressed waveform, ABD parameters, and the latest ABD events.

The OxyCRG function is intended for neonatal patients only.

4.5.1 Entering the OxyCRG Screen

To enter the OxyCRG screen, choose any of the following ways:

- Swipe left or right on the touchscreen with two fingers to switch to the OxyCRG screen.
- Select the **OxyCRG** quick key.
- Select the **Screen Setup** quick key → select the **Choose Screen** tab → select **OxyCRG**.
- Select the **Main Menu** quick key → from the **Display** column select **Choose Screen** → select **OxyCRG**.

4.5.2 The Display of the OxyCRG Screen

The following figure shows the OxyCRG screen. Your display may be configured to look slightly different.

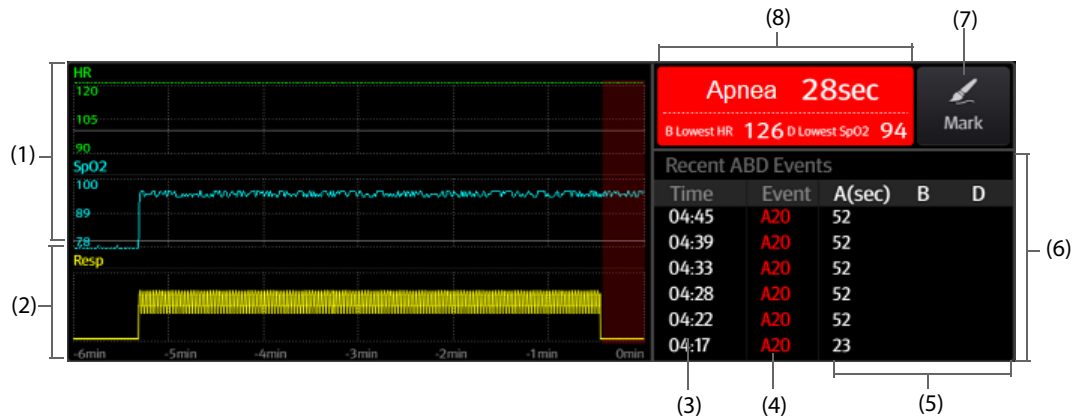

- (1) HR, SpO₂/SpO₂b trend
- (2) Resp/CO₂ compressed waveform
- (3) Event time
- (4) Event type
- (5) Parameter values of ABD events
- (6) ABD event list: displays the latest red ABD events. Selecting the ABD event list area enters the OxyCRG review page.
- (7) Mark button: opens the **Mark** dialog to edit the events.
- (8) ABD event prompt area: displays parameter values of currently active OxyCRG events.

4.5.3 OxyCRG Events

The following table lists the ABD events and their criteria:

Event type	Description	Remarks
A	Apnea event: the apnea duration exceeds the threshold. <ul style="list-style-type: none"> A20: the apnea duration is greater or equal to 20 seconds. A15: the apnea duration is between 15 to 20 seconds (excluding 20 seconds). A10: the apnea duration is between 10 to 15 seconds (excluding 15 seconds). 	A20 is a red event
B	Low Heart Rate event: the duration of low heart rate exceeds the threshold.	/
D	Low SpO ₂ event: the duration of SpO ₂ Desat exceeds the threshold.	/
BD	Low Heart Rate and low SpO ₂ happen at the same time.	/
AB	Apnea and Low Heart Rate happens at the same time.	Red event
AD	Apnea and low SpO ₂ happen at the same time.	Red event
ABD	Apnea, Low Heart Rate, and low SpO ₂ happen at the same time.	Red event

NOTE

- **The monitor records all ABD events for OxyCRG review, but only red events displays in the ABD list of the OxyCRG screen.**

4.5.4 The Display of the ABD Event Area

The ABD event area displays parameter values of currently active OxyCRG events and lists the latest red ABD events.

4.5.5 Setting OxyCRG Parameters

Select parameter trends or compressed waveform to set parameters and the compressed waveform you want to display. The selected parameters will be used for ABD event calculation.

4.5.6 Setting the Threshold of ABD Events

Select any parameter trend or the compressed waveform to perform the following setup:

- Set the threshold of ABD events.
- Set **Event Storage Format**:
 - ◆ **1 min+3 min**: stores data one minute before and three minutes after the event.
 - ◆ **3 min+1 min**: stores data three minutes before and one minute after the event.
 - ◆ **2 min+2 min**: stores data two minutes before and two minutes after the event.

The stored data includes the trends of the OxyCRG parameters, compressed waveform, alarm thresholds, NIBP, and Temp measurements.

4.5.7 Editing ABD Events

To edit ABD events, follow this procedure:

1. Select the **Mark** button to enter the **Mark** dialog box.
2. Drag the event list upwards and downwards to select the desired event.
3. Select the patient's status when the event happened.
4. Select **Save**.

4.6 The Targeted Goal Screen

If you are concerned with specific parameters and their trends, you can use the Targeted Goal screen. The Targeted Goal screen focuses on the target parameter and displays parameter measurements in big numerics. You can easily identify whether parameter target is reached via a dashboard and review the statistics of the target parameter by sections.

The Targeted Goal screen displays parameter measurements and waveforms of ECG, SpO₂, IBP, PI, PR, CO₂, Resp, NIBP, and Temp. You can define the target parameter and secondary parameters. The measurements of these parameters displays in big numerics.

4.6.1 Entering the Targeted Goal Screen

To enter the Targeted Goal screen, choose any of the following ways:

- Select the **Screen Setup** quick key → select the **Choose Screen** tab → select Targeted Goal screen.
- Select the **Main Menu** quick key → from the **Display** column select **Choose Screen** → select Targeted Goal Screen.
- If the **Patient Category** is set to **Neo**, swipe left or right on the touchscreen with two fingers to switch to the Targeted Goal screen.

4.6.2 The Display of the Targeted Goal Screen

The following figure shows the Targeted Goal screen. Your display may be configured to look slightly different.

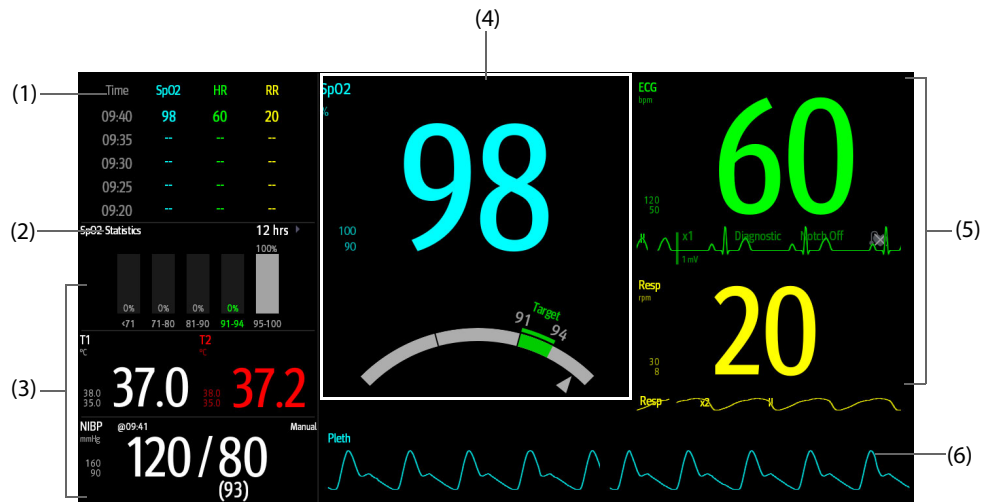

- (1) Parameter trends area: displays trends of the target parameter and secondary parameters. If the target parameter is Art, this area only lists the trend of arterial pressure.
- (2) Target parameter statistics area: displays the statistics of the target parameter by sections.
- (3) Other parameter area: displays parameter measurements and alarm limits of parameters other than the target parameter and secondary parameters.
- (4) Target parameter area: displays the measurement of the target parameter in big numerics, as well as its target range, and alarm limits.
 - If the target parameter is Resp or PR, parameter source is also displayed.
 - The dashboard shows the target range in green.
 - The Δ pointer below the dashboard indicates the current measurement value.
- (5) Secondary parameters area: displays parameter measurement of secondary parameters in big numerics, as well as waveforms and alarm limits. If secondary parameters are Resp and PR, parameter sources are also displayed.
- (6) Target parameter waveform area: displays the waveform of the target parameter.
 - If the target parameter is Resp or PR, the waveform of the source parameter is displayed.
 - If the target parameter is ECG, the fist ECG waveform is displayed by default.

4.6.3 Configuring the Targeted Goal Screen Layout

To configure the parameter numerics, waveforms, and their sequence displayed on the Targeted Goal screen, follow this procedure:

1. Access the Targeted Goal screen in either of the following ways:
 - ◆ Select the **Screen Setup** quick key → select the **Choose Screen** tab → select Targeted Goal screen.
 - ◆ Select the **Main Menu** quick key → from the **Display** column select **Choose Screen** → select Targeted Goal Screen.
2. Select a parameter numeric area or waveform area, and then from the popup list select an element to display in this area. The parameters and waveforms not selected will not displayed.

4.6.4 Operating the Targeted Goal Screen

You can access parameter setup and trends review from the Targeted Goal screen. To do so, follow this procedure:

- Select the parameter trends area to enter the **Tabular Trends** review page.
- Select the target parameter statistics area to enter the parameter statistics setup dialog. Set the range of each section and the target section.
- Select the desired waveform area, parameter numeric area, or dashboard to enter corresponding parameter setup dialog.

4.7 Remote View

On the monitor, you can observe alarm conditions and view real time physiological data from patients on other compatible remote networked monitoring devices, such as a bedside monitor or a telemetry device.

A device from a remote site is called a remote device or bed. N22/N19/N17 can simultaneously watch up to 18 remote devices. N15/N12 can simultaneously watch up to 12 remote devices. The monitor can show waveforms of one remote device.

You can watch the remote devices in the **Remote View** screen, or the alarm watch tiles on the main screen.

In the **Remote View** screen, you can view real time parameters and waveforms from one specific device, and watch the alarms of other monitored devices at the same time.

NOTE

- A particular monitor (for example Monitor #1) can be viewed by at most 32 remote devices at the same time, of which eight of those remote devices can watch Monitor #1's waveforms.

4.7.1 Entering the Remote View Screen

To enter the **Remote View** screen, choose one of the following ways:

- Select the **Remote View** quick key.
- Select the bed at the alarm watch tile on the main screen. For more information, see 4.7.10.2 *Displaying the Alarm Watch Tile on the Main Screen*.
- Select the **Screen Setup** quick key → select the **Choose Screen** tab → select **Remote View**.

4.7.2 About the Remote View

The following figure shows the **Remote View** screen.

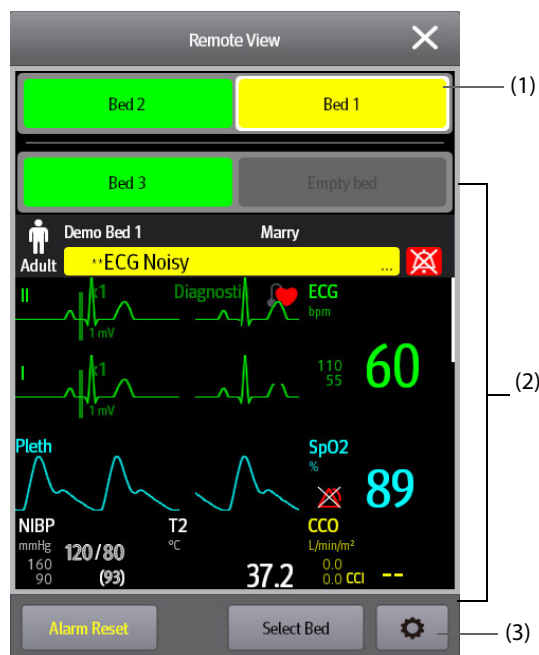

- (1) Alarm watch area

Displays all the monitored remote beds. Each bed displays the room number, bed number, connection status and alarm status. The background color indicates the alarm status on the corresponding bed.

Background Color	Description
Green	No alarm is occurring at the bed.
Red	The remote device is disconnected or a high priority alarm is currently the highest alarm level on the bed. If the remote device is disconnected, the  icon is displayed.

Background Color	Description
Yellow	The medium priority alarm is currently the highest alarm level on the bed.
Cyan	The low priority alarm is currently the highest alarm level on the bed.
Grey	The bed is in the standby mode.

(2) Main area

Displays the patient's information, alarm status and messages, waveforms, measurements, etc. of the selected bed. This bed is called main bed.

(3) Remote View setup button: select it to enter the Remote View setup menu.

WARNING

- **The data presented in the Remote View screen has a delay. Do not rely on this screen for real time data.**
-

4.7.3 Adding a Bed

After adding the desired remote devices, then the alarms from these devices can be viewed on the monitor. To add a remote device, follow this procedure:

1. Enter the **Select Bed** dialog. To do so, choose either of the following ways:
 - ◆ In the **Remote View** screen, select **Select Bed**. For more information, see *4.7.1 Entering the Remote View Screen*.
 - ◆ Select the  icon at the alarm watch tile if the tile is configured to display on the main screen.
2. In the **Select Bed** dialog, select a desired department. All the beds under this department will be listed.
3. Select a desired tile at the A-W1, A-W2 or A-W3 areas and then select a bed from the bed list. The selected bed will appear in the tile.

NOTE

- **The added bed is indicated by a check mark (✓) at the left of the bed list.**
-

4.7.4 Removing a Bed

To remove a remote device from remote monitoring, follow this procedure:

1. Enter the **Select Bed** dialog. Choose either of the following ways:
 - ◆ In the **Remote View** screen, select **Select Bed**. For more information, see *4.7.1 Entering the Remote View Screen*.
 - ◆ Select the  icon in the alarm watch tile if the tile is configured to display on the main screen.
2. In the **Select Bed** dialog, select a bed at the A-W1, A-W2 or A-W3 areas, and then select **Clear Bed**. If you want remove all beds, select **Clear All Beds**.

4.7.5 Displaying the Main Bed

In the **Remote View** screen, you can select a bed in the alarm watch area, then the main body of the **Remote View** screen will display the real time monitoring screen of the device.

4.7.6 Saving a Manual Event

You can initiate a manual event on the remote monitor by selecting **Manual Event** in the **Remote View** screen.

4.7.7 Managing Alarms from Remote Devices

You can view and manage the alarms coming from remote devices.

If the monitor and remote devices have alarms at the same time, the monitor presents alarms according to the following rules:

- If the alarm tone pattern for the monitor is same as that for the remote devices, the monitor prioritizes all the alarms and sounds the highest alarm tone.
- If the alarm tone pattern for the monitor is different from that for the remote devices, the monitor sounds the alarms in their corresponding tone.

The monitor provides the same alarm tone pattern for the remote device alarms as those for the monitor alarms by default. You can change the alarm tone pattern of the remote monitor; see 33.3.5.5 *Setting the Tone Pattern for Alarms from Remote Devices*.

4.7.8 Resetting Alarms for Remote Devices

You can reset the alarms on the remote devices by selecting **Alarm Reset** in the **Remote View** screen. This function needs to be enabled. For more information, see 33.3.5.1 *Resetting Alarms for Remote Devices*.

4.7.9 Selecting Beds By Care Group

If configured, the monitor automatically selects beds in the same care group during the shift of care groups in the CMS. To enable this function, follow this procedure:

1. Enter the **Select Bed** window. Choose either of the following ways:
 - ◆ In the **Remote View** window, select **Select Bed**. For more information, see 4.7.1 *Entering the Remote View Screen* for entering the **Remote View** window.
 - ◆ Select the  icon in the alarm watch tile if the tile is configured to display on the main screen.
2. In lower left corner of the **Select Bed** window, select **Select Beds By Care Group**.

4.7.10 Alarm Watch

The alarm watch function provides the alarm notification by color and sound.

- The monitor sounds the highest priority alarm tone from all the monitored remote devices.
- The monitor displays the highest priority alarm in corresponding background color for each bed at the following areas:
 - ◆ At the top of the **Remote View**. For more information, see 4.7.2 *About the Remote View* for details.
 - ◆ On the main screen. For more information, see 4.7.10.1 *About Alarm Watch Tile* for details.

4.7.10.1 About Alarm Watch Tile

The main screen can display up to three alarm watch tiles, namely A-W1, A-W2 and A-W3. Each tile can accommodate up to six beds.

The following figure shows the alarm watch tiles.

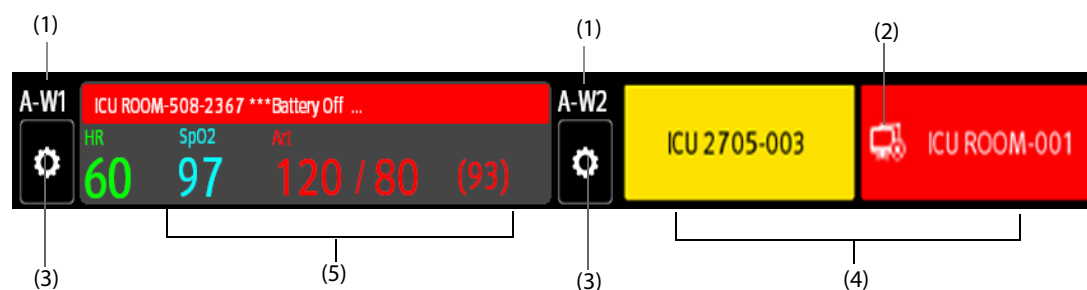

- (1) Alarm watch tile label
- (2) Disconnection icon: when the remote device is disconnected, this icon displays at the tile, and the tile background color is red.
- (3) Select bed icon: select it to enter the **Select Bed** dialog.

- (4) More than one bed tile: when more than one bed is assigned to a tile, the tile displays the alarm status, connection status, etc.
- (5) One bed tile: when only one bed is assigned to a tile, the tile displays the parameter value and alarm message from this bed, etc.

The alarm watch tile is similar to alarm watch area in the **Remote View**. For more information, see 4.7.2 *About the Remote View*.

4.7.10.2 Displaying the Alarm Watch Tile on the Main Screen

To configure the alarm watch tile to be displayed on the monitor's main screen, follow this procedure:

1. Select the **Main Menu** quick key → from the **Display** column select **Choose Screen** to enter the **Screen Setup** dialog.
2. Select the **Tile Layout** tab.
3. Select the numeric area where you want to display the alarm watch tile, and then in the drop-down list, select **Alarm Watch** → **A-W1**, **A-W2**, or **A-W3**.

4.7.11 Auto Displaying the Alarm Bed

The monitor provides the function of automatically displaying the remote alarm bed. If this function is enabled, when a remote bed issues an alarm, the monitor automatically displays the monitoring information from this remote bed.

If multiple remote beds issue alarms, the monitor cyclically displays the alarm beds as per the preset interval and in the order of alarm time.

The auto displaying alarm bed function is disabled by default. To enable this function, follow this procedure:

1. From the **Remote View** screen, select  to enter the **Remote View** setup menu.
2. Switch on **Rollup Alarm Beds**.
3. Set **Rollup Interval**:
 - ◆ **Off**: do not cyclically display the remote alarm beds. Once a new alarm is issued, the monitor automatically switches to the new alarm bed.
 - ◆ **10 sec**, **20 sec**, or **30 sec**: If multiple remote beds issue alarms, the monitor cyclically displays the alarm beds as per the preset interval and alarm priority in the order of alarm time.
4. Set Alarm Priority:
 - ◆ **High Only**: Only when a high priority alarm is issued, the monitor automatically switches to the alarm bed.
 - ◆ **High & Med**: If **Rollup Interval** is set to **Off** and when a high priority alarm or medium priority alarm is issued, the monitor automatically switches to the alarm bed. If **Rollup Interval** is set to **10 sec**, **20 sec**, or **30 sec** and multiple remote beds issue alarms, the monitor cyclically displays the alarm beds with higher priority in the order of alarm time. For example, if both high priority alarms or medium priority alarm are issued, only beds with high priority alarms are cyclically displayed.

This page intentionally left blank.

5 Managing Patients

5.1 Starting Monitoring a Patient

After turning on the monitor, follow this procedure to monitor a patient:

1. Admit the patient.
2. Check patient settings. Make sure that alarm limits, patient category and paced status, and so on, are appropriate for the patient. Change them if necessary.
3. Perform desired measurements. For more information, see corresponding measurement chapters.

5.2 Admitting a Patient

The monitor admits a new patient in the following situations:

- After a patient is manually discharged, the monitor automatically admits a new patient.
- After being switched off for the selected time period, the monitor automatically discharges the previous patient and admits a new patient at startup.
- If the monitor has not detected certain patient vital signs (ECG, SpO₂, PR, RR, NIBP) for 30 minutes, it will prompt whether to start monitoring a new patient if any of the above vital signs are detected again.

Always input patient information as soon as the patient is admitted. For more information, see *5.2.2 Editing Patient Information* for details.

WARNING

- **The default Patient Category setting is Adult, and Paced setting is Unspecified. Set Paced and check if the Patient Category setting is correct for the patient.**
 - **For paced patients, set Paced to Yes. If it is incorrectly set to No, the monitor could mistake a pace pulse for a QRS and fail to alarm when the ECG signal is too weak.**
 - **For non-paced patients, set Paced to No.**
-

5.2.1 Entering the Patient Management Dialog

Use any of the following methods to enter the **Patient Management** dialog:

- Select the patient information area at the top left corner of the screen.
- Select the **Patient Management** quick key.
- Select the **Main Menu** quick key → from the **Patient Management** column select **Patient Management**.

5.2.2 Editing Patient Information

Edit patient information after a patient has been admitted, or when patient information is incomplete, or when it is necessary to change patient information:

To edit patient information, follow this procedure:

1. Enter the **Patient Management** dialog. For more information, see *5.2.1 Entering the Patient Management Dialog*.
2. Edit patient information as required.

If a barcode reader is connected to the monitor, scanning the patient's barcode will enter the patient's information.

NOTE

- **The monitor will reload the configuration if you change the patient category.**
-

5.2.3 Loading Patient Information from the CMS

If the monitor is connected to the central monitoring system (CMS). You can load patient information from the CMS to the monitor. To do so, follow this procedure:

1. Enter the **Find Patient** dialog in either of the following ways:
 - ◆ Select the **Main Menu** quick key → from the **Patient Management** column select **Find Patient**.
 - ◆ From the **Patient Management** dialog select **Find Patient**.
2. Input query criteria.
3. Select **Search**. Then a list pops up, including all the patients that meet the query criteria.
4. Select a patient from the patient list, and then select **Admit**. Corresponding patient information in the monitor will be updated.

NOTE

- **If ADT Query is switched on, input query criteria from the Discharged Patients page.**
-

5.2.4 Loading Patient Information from the ADT Server

If the monitor is connected with the Admit-Discharge-Transfer (ADT) server through the eGateway. You can load patient information from ADT server to the monitor.

To do so, follow this procedure:

1. Enter the **Find Patient** dialog in either of the following ways:
 - ◆ Select the **Main Menu** quick key → from the **Patient Management** column select **Find Patient**.
 - ◆ Select **Find Patient** from the **Patient Management** dialog.
2. Input query criteria.
3. Select **Search**. Then a list pops up, including all the patients that meet the query criteria.
4. Select a patient from the patient list, and then select **Admit**. Corresponding patient information in the monitor will be updated.

NOTE

- **You can load patient information from the ADT server only when ADT Query is enabled. For more information, see 33.13.11 Using the ADT Gateway.**
 - **The monitor can automatically upload the patient information from the ADT server when:**
 - ◆ The configured keywords of the monitor and the eGateway are the same.
 - ◆ The IP address of the monitor is added to the eGateway configuration dialog.
 - **Loading patient information from the ADT server updates only patient information in the monitor. The patient's monitoring data is not changed and the patient is not discharged.**
-

5.3 Transferring Patient

Patient settings and data can be transferred from a T1, BeneVision N1, or MPM module into this monitor. The patient settings and data includes patient information, trend data, alarm events, and parameter alarm limits. The N1 also allows transfer of full disclosure data.

The MPM allows transfer of patient information, such as patient ID, height, and weight, etc.

WARNING

- **Do not discharge a patient on the bedside monitor before patient information is completely transferred. Discharging the patient during transfer will result in incomplete patient information.**
-

NOTE

- **The system automatically switches on the HR/PR (high, low) alarms and lethal arrhythmia alarms after transferring the patient data.**
-

5.3.1 Data Storage Introduction

Familiarizing with the data respectively stored in the patient monitor, T1, N1, or MPM helps you understand the effects incurred by transferring patients with an T1, N1, or MPM.

Type of storage		Can be stored in the monitor?	Can be transferred via MPM?	Can be transferred via T1?	Can be transferred via N1
Data	Patient demographics	Yes	Yes	Yes	Yes
	Trend data	Yes	Yes	Yes	Yes
	Calculation data	Yes	No	No	Yes
	Event data	Yes	No	Yes	Yes
	Full disclosure waveforms	Yes	No	No	Yes
Settings	Monitor settings (Alarm pause, alarm volume, etc.)	Yes	No	No	No
	Parameter settings (Alarm limits, measurement setting, etc.)	Yes	Yes	Yes	Yes

5.3.2 Transferring Patient Data

To transfer the patient data via N1/T1/MPM, insert it into the SMR.

- If the patient demographics in the monitor are consistent with those of in the N1/T1/MPM, N1/T1/MPM automatically uploads the data to the monitor.
- If the patient demographics in the monitor are not consistent with those of in the N1/T1/MPM, and **Data Transfer Strategy** is set to **Always Ask** (for more information, see 33.2.3 *Setting the Strategy of Transferring Patient Information*), the monitor prompts the **Select Patient** dialog automatically. In this case, you need to select an operation (see the following table) according to the actual situation. If the Data Transfer Strategy is not set to Always Ask then the monitor will follow the strategy setting without prompting the user.

Operations	Operation Description	Examples of applications
Continue Patient in Monitor	Continue to use the patient data in the monitor. This deletes all patient data in the N1/T1/MPM and copies all data in the monitor to the N1/T1/MPM.	1. Replace N1/T1/MPM during patient monitoring. 2. After the patient is admitted, connect the N1/T1/MPM.
Continue Patient in Module	Continue to use the patient data in N1/T1/MPM. The monitor discharges the patient, and automatically admits a new patient and copies all data from N1/T1/MPM.	You are monitoring a patient using N1/T1/MPM, and you need to transfer the patient, e.g. from a ward (original monitor) to the operating room (destination monitor).
New Patient	Select this option if you will use neither the information in the monitor nor that in the N1/T1/MPM. This deletes all data in the monitor and N1/T1/MPM and lets you admit a new patient on the monitor. In this case, you need to re-enter the patient demographics. The monitor will restore the settings according to the patient category.	Connect the N1/T1/MPM before admitting a new patient. However, the monitor and/or N1/T1/MPM have stored the previous patient's data and settings.
Same Patient	Select this option if the patient information in the monitor and N1/T1/MPM are different but you are sure that it is the same patient. This merges the patient's trend data in the monitor and N1/T1/MPM and copies the settings in N1/T1/MPM to the monitor as well.	A patient monitored with the N1/T1/MPM is moved to another department and again moved back. However, the patient information stored in the N1/T1/MPM was altered before connected to the original monitor.

NOTE

- **Selecting Apply Module Settings will transfer the N1/T1/MPM settings to the monitor along with the patient data. For more information, see 5.4 Exporting Patient Data.**

5.4 Exporting Patient Data

To export the data of the current patient and discharged patients, follow this procedure:

1. For N17/N15/N12, connect the USB drive to the monitor's USB connector. For N22/N19, connect the USB drive to the monitor's MSB connector.
2. Access the **Discharged Patients** dialog box by either of the following ways:
 - ◆ Select the **Discharged Patients** quick key.
 - ◆ Select the **Main Menu** quick key → from the **Patient Management** column select **Discharged Patients**.
3. From the patient list select desired patients.
4. Select **Export Patient Data**.

5.5 Deleting Patient Data

To delete the data of discharged patients, follow this procedure:

1. Access the **Discharged Patients** dialog box by either of the following ways:
 - ◆ Select the **Discharged Patients** quick key.
 - ◆ Select the **Main Menu** quick key → from the **Patient Management** column select **Discharged Patients**.
2. From the patient list select desired patients.
3. Select **Delete**.

5.6 Stopping a Parameter Measurement

To stop monitoring a parameter, follow this procedure:

1. Remove corresponding sensor from the patient.
2. Disconnect the sensor from the patient cable.
3. Disconnect the patient cable from the parameter module.

5.7 Discharging a Patient

Before monitoring a new patient, discharge the previous patient. The technical alarms are reset, and monitor settings return to their defaults. For more information, see *32.3 Setting Default Patient Category*.

After a patient is discharged, the monitor automatically admits a new patient.

WARNING

- **Always discharge the previous patient before starting to monitor a new patient. Failure to do so can lead to data being associated with the wrong patient.**
-

To manually discharge a patient, use any of the following methods to access the **Discharge Patient** dialog:

- Swipe down the touchscreen with two fingers.
- Select the **Discharge Patient** quick key.
- Select the patient information area at the top left corner of the screen → **Discharge Patient**.
- Select the **Patient Management** quick key → **Discharge Patient**.
- Select the **Main Menu** quick key → from the **Patient Management** column select **Discharge**.

Select a button in the **Discharge Patient** dialog:

- **Print End Case Report:** prints the end case report when the patient is discharged.
- **Discharge:** clears the waveform data of the current patient. The monitor loads the default configuration and goes to the standby mode. The current patient becomes a discharged patient.
- **Clear Patient Data:** discharges the current patient and clears the waveform data. The monitor still uses the current configuration and does not go to the standby mode. The current patient becomes a discharged patient.

This page intentionally left blank.

6 Interfacing with External Devices

6.1 BeneLink Introduction

BeneLink module is intended for connecting external devices, such as ventilators and anesthesia machines, to the monitor. It allows information (patient data, alarms, etc.) from external devices to be displayed, saved, recorded, or printed through the monitor. If the monitor is connected with the CMS or eGateway, information from external devices can also be transmitted to the CMS or eGateway.

For more information on connecting external devices via the BeneLink module, see BeneLink Module Operator's Manual (PN: 046-011948-00).

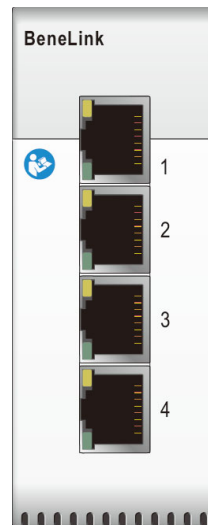

6.2 BeneLink Safety Information

WARNING

- Devices of the same category cannot be connected to the BeneLink module simultaneously.
- The parameter labels used on the patient monitor may be different from those used on the external device.
- The alarms from external devices may be delayed before transmission to the patient monitor.
- There can be differences between the alarm priorities displayed on the monitors and the priorities displayed on external devices interfaced through BeneLink.

NOTE

- The alarm messages from external devices are derived from the open protocol of the corresponding external device. For more information about these alarms, please see the operator's manual for the corresponding devices.
-

6.3 Differences in Displayed Values

In certain cases, there may be differences between the numerics displayed on the monitor and those on external devices. The table below lists some situations and possible reasons.

Situation	Possible Reasons
Some parameter values are displayed as invalid values on the monitor.	The patient monitor and the external device may have different parameter configuration or displaying range of values. If the patient monitor displays a parameter not configured in the external device, or a parameter value from the external device exceeds the displaying range of the monitor, then the corresponding parameter value is displayed on the monitor as an invalid value.
The monitor and external device display parameter values with different numbers of places of decimals.	The monitor displays parameter values from the external device based on the monitor displaying rules. Same parameter value is displayed differently when the monitor and the external device display numbers with different precision.
Non-continuously measured values and continuously measured values have the same displaying mode in the patient monitor.	For non-continuously measured values, the monitor displays the latest measured values until a new measurement is transmitted by the external device.
Parameter values displayed on the patient monitor and those displayed in the external device are slightly different.	Some parameter values are converted to different units when transmitted to the monitor. Sometimes, values from the external device may be delayed before transmission to the patient monitor.

NOTE

- **When the pressure units are converted among cmH₂O, hPa and mbar, the parameter values remain unchanged, for example, 1cmH₂O=1hPa=1mbar, which may differ from some external devices.**

6.4 Connecting an External Device

An external device is connected to the BeneLink module through an ID adapter. The ID adapter supports only its matching device.

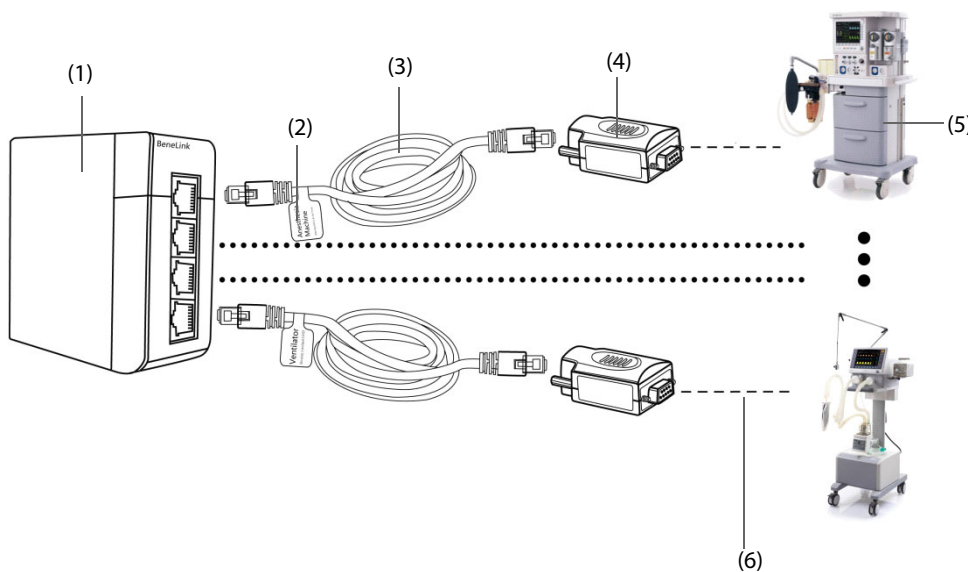

(1) BeneLink Module

(2) Label

(3) RJ45 connecting cable

(4) ID Adapter

(5) External device

(6) Serial port adapting cable (optional)

To connect an external device, follow this procedure:

1. Insert the BeneLink module into the SMR.
2. Connect the ID adapter that matches the external device to the BeneLink module with an RJ45 connecting cable.
3. Plug the ID adapter into the RS232 port on the external device. Some external devices may have ports incompatible with the ID adapter. In this case, a serial port adapting cable is required.
4. Stick a device name label to the RJ45 connecting cable at the end close to the BeneLink module. When the BeneLink module is connected to several external devices, you can tell devices easily with these labels. Switch on the external device.

After the external device is connected to the monitor, the indicators on both the ID adapter and the BeneLink module illuminate to show that the monitor successfully communicates with the external device.

CAUTION

- **First installation and debugging should be executed by Mindray service personnel or an authorized technician.**
- **Please check the compatibility of the external device and the ID adapter before connection. Otherwise, unpredictable system failure may result.**
- **Ports on the BeneLink module are not conventional network connectors. They are intended for connecting with the serial port of designated devices only. Do not connect them to network interfaces.**

6.5 Accessing the Integrated Devices Screen

You can view the information of external devices in the **Integrated Devices** screen of the monitor. The **Integrated Devices** screen provides information of both individual device and multi devices. To access the **Integrated Devices** screen, follow this procedure:

- Select the **Integrated Devices** quick key.
- Select the **Screen Setup** quick key → select **Integrated Devices**.
- Select the **Main Menu** quick key → from the **Display** column select **Choose Screen** →select **Integrated Devices**.
- Select the numeric area or waveform area of any parameter from the external device →select **Integrated Devices** button.

Integrated Devices					
Anesthesia			Ventilator		
Anesthesia Vent Mode:VCV					
PEEP	cmH2O	MV	L/min	Raw	cmH2O/L/s
0.0(0.0)		4.5		9	
Ppeak	cmH2O	f	bpm	FI02	%
18		15(15)		23.0	
Pplat	cmH2O	fE			
15		1:2(1.2)			
Pmean	cmH2O	TIP:TI	%		
6.0		(25)			
VT	ml	Plimit	cmH2O		
(300)		(30)			
VTe	ml	Compl	ml/cmH2O		
300		17			

The **Integrated Devices** screen has the following features:

- For the parameters measured by the external device, the measurements display directly after the parameter labels.
- For the parameters controlled by the external device, the settings are enclosed in parenthesis after parameter labels.

- For the parameters measured and controlled by the external device, measurements and settings are displayed after parameter labels, and settings are also enclosed in parenthesis. For example, PEEP 18 (20), in which PEEP is parameter label, 18 is the measurement, and (20) is the setting.

NOTE

- **Parameters in the Integrated Devices screen are displayed in the order as shown in the selection dialog. If the screen cannot display all the selected parameters, the parameter with higher positions (from top to bottom and from left to right) in the Select Parameter dialogue are displayed.**

6.6 Displaying Parameters from External Devices

This monitor can display parameters from external devices in the main screen:

- Display waveforms from external devices in the waveform area.
- Display labels and measurements of parameters from external devices in the numeric area.
- Display respiratory loops of parameters from external devices in the **Loops** screen.

The following is an example of parameters (from TOF-Watch SX monitor) displayed in the numeric area of the main screen.

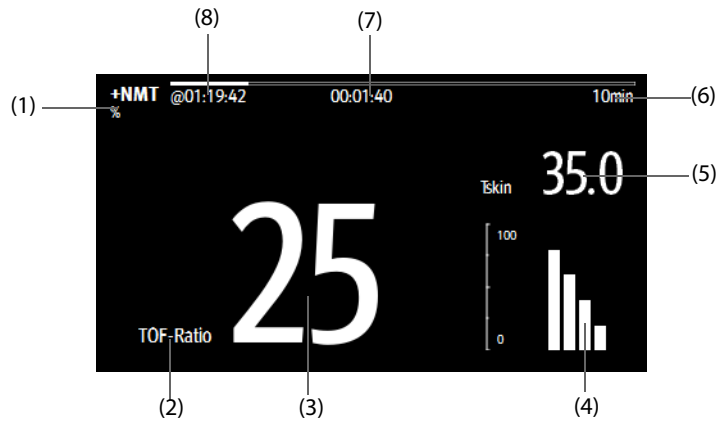

- | | |
|---------------------------|---------------------------------------|
| (1) Parameter unit | (2) Parameter label |
| (3) Parameter measurement | (4) Response amplitude of stimulation |
| (5) Skin temperature | (6) Measurement interval |
| (7) Measurement countdown | (8) Time of last measurement |

NOTE

- **When displayed in the monitor main screen, parameter labels of external devices are prefixed with the plug sign "+". For example, if SpO₂ is from an external device, its label is displayed as "+SpO₂", and its waveform label is displayed as "+Pleth".**
- **If a parameter can be obtained either from the monitor or an external device, the measured value, waveform or loops coming from the monitor will be displayed preferentially.**

6.6.1 Setting Waveform Properties for Parameters from External Devices

To set the waveform properties for parameters from external devices, follow this procedure:

1. Access the parameter setup dialog by selecting its waveform area or numeric area.
2. Set **Speed** or **Scale**.

6.6.2 Setting Alarms from External Devices

To enable or disable the storage, display, and sound of the external device alarms of a certain priority and category, follow this procedure:

1. From the **Integrated Devices** screen select **Setup**.
2. Set switches as desired.

If the storage, display, or audio settings of a specific alarm are different from its category or priority, set them individually by adding the Alarm ID to the alarm list. To do so, follow this procedure:

1. From the **Integrated Devices** screen select **Setup**.
2. Input the Alarm ID for this alarm, and select **Add**.

To delete a specific external device alarm, select the desired Alarm ID, and select **Delete**.

Refer to the *BeneLink Module Operator's Manual (PN: 046-011948-00)* for the list of supported alarms and Alarm IDs.

6.6.3 Setting Parameters from External Devices for Display

To select parameters displayed in the **Integrated Devices** screen, follow this procedure:

1. From the **Integrated Devices** screen select **Select Parameter**.
2. Select desired parameters.

In the main screen, the numeric area of some parameters from an external device, for example the +Paw parameter, can display multiple parameters. To select parameters for display, follow this procedure:

1. Select the numeric area of the parameter from the external device.
2. Select the **Select Parameter** tab.
3. Select the parameters for display.

6.6.4 Setting Units for Parameters from External Devices

To set units for parameters from external devices, follow this procedure:

1. Select the numeric area or waveform area of any parameter from the external device.
2. Select the **Unit** tab.
3. Set the unit for **O2**, **CO2**, **Pressure** or **Temp**.

6.6.5 Accessing the Loops Screen

To access the **Loops** screen, follow this procedure:

1. Select the numeric area or waveform area of +Paw, +Flow, or +Vol to enter its corresponding setup dialog.
2. Select the **Loops** button.

NOTE

-
- **The monitor only displays real-time loops of the external device, and these loops cannot be displayed or saved as reference loops.**
-

6.7 Viewing Alarms from External Devices

If the patient monitor is configured to do so, the monitor displays alarms from external devices in the physiological and technical alarm information areas. A plus sign "+" is added before each alarm message from external devices.

6.8 Viewing Parameter Trends from External Devices

If the patient monitor is configured to do so, the monitor saves parameters trends and alarm events from external devices. You can review these data in the **Tabular Trends**, **Graphic Trends**, **Events** and **Full Disclosure** pages in the **Review** screen. The monitor adds a "+" before the parameter label of external devices.

For more information, see *26 Review*.

NOTE

- **Parameters from external devices are saved and displayed according to the time on the monitor.**
-

6.9 Recording and Printing Parameter Trends from External Devices

You can record or print parameter trends from external devices. For more information, see *26 Review*, *29 Recording*, and *30 Printing*.

7 Using with the Telemetry Monitor

7.1 Introduction

You can connect a TM80 telemetry monitor (hereinafter called the telemetry) with the N Series monitor (hereinafter called the monitor) to measure the ECG, Resp, and SpO₂ of ambulatory adult and pediatric patients. If the telemetry is connected to the BP10 NIBP module, the NIBP measurements can also be transferred to the N Series monitor via the telemetry.

The telemetry is connected with the monitor via the wireless network. The process of connecting the telemetry and the monitor is called "pairing". After the telemetry is paired with the monitor, you can view the measurement data from the telemetry on the monitor's screen.

7.1.1 Pairing Procedure

Before pairing the telemetry and the monitor, verify the network settings of both the telemetry and the monitor. Ensure that the telemetry and the monitor are in the same network.

To pair the telemetry with the monitor, follow this procedure:

1. Access the **Bedside Devices** dialog in either of the following ways:
 - ◆ Select the **Bedside Devices** quick key.
 - ◆ Select the **Main Menu** quick key → from the **Parameters** column select **Bedside Devices**.
2. Select + to enter the **Add Device** dialog. Select **Refresh** if you want to refresh the unpaired telemetries list.
 - ◆ From the **All Unpaired** tab or the **Unpaired in Current Dept.** tab, select the telemetry you want to pair.
 - ◆ In the search box, input the device name, the patient's MRN, department, or bed number, and then select **Search**. Select the desired telemetry from the search results.
3. Select **Pair** and follow the on-screen instructions:
 - a. Select **Confirm** to start pairing the selected telemetry with the monitor.
 - b. Select patient.
 - ◆ **Use Patient in Monitor**: uses the patient data in the monitor and deletes patient data in the telemetry.
 - ◆ **Use Patient in Telemetry**: uses the patient data in the telemetry and deletes patient data in the monitor.
 - ◆ **New Patient**: discharges the current patient and admits a new patient. The new patient will be monitored.
 - c. Check that the message "This telemetry is pairing with patient monitor XX, are you sure?" is displayed on the desired telemetry. Select **Yes**.
4. At the completion of pairing, the message "Paired successfully" is displayed on the monitor. Close the **Pairing** and the **Bedside Devices** dialogs.

After pairing with the telemetry, on the monitor, labels of parameters from the telemetry are followed by "-T", for example ECG-T, indicating that these parameters come from the telemetry.

CAUTION



- **Make sure that correct telemetry is selected for pairing with the monitor.**
 - **If the wireless network signal is poor, the monitor may have the risk of data loss.**
-



NOTE

- **The telemetry is not intended for monitoring neonatal patients.**

- **By default the device name of the telemetry is its serial number. If you need to change the name of the telemetry, refer to the operator's manual of the corresponding telemetry.**
-

7.2 Binding the Telemetry with the Monitor

After the telemetry is paired with the monitor, discharging the patient from either device automatically unpairs the telemetry and the monitor. If you need the monitor and the telemetry to remain paired after the patient is discharged, bind the two devices. To do so, enter the **Bedside Devices** dialog and select the unlock symbol  on the top left corner. After the two devices are bound together, the lock symbol turns to be locked .

To release the binding of the monitor and the telemetry, select the lock symbol . Then the two devices are unbound and the lock symbol changes to be unlocked .

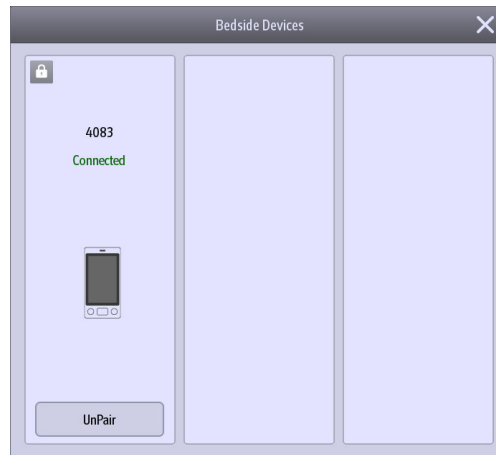

7.3 Unpairing the Telemetry and the Monitor

If you do not need to connect the monitor and the telemetry to monitor the patient, you can unpair them. After the monitor and the telemetry are unpaired, the CMS receives patient data from the monitor or the telemetry if connected.

7.3.1 Unpairing the Telemetry and the Monitor via the Monitor

To unpair the telemetry from the monitor, follow this procedure:

1. Access the **Bedside Devices** dialog in either of the following ways:
 - ◆ Select the **Bedside Devices** quick key.
 - ◆ Select the **Main Menu** quick key → from the **Parameters** column select **Bedside Devices**.
2. Select **Unpair**.
3. Select which device is used to continue monitoring the patient.
 - ◆ **Monitor**: the monitor is used to continue monitoring the patient. The telemetry enters standby.
 - ◆ **Telemetry**: the telemetry is used to continue monitoring the patient. The monitor enters standby.
4. Close the **Unpair** and the **Bedside Devices** dialogs.

7.3.2 Unpairing the Telemetry and the Monitor via the telemetry

To unpair the monitor from the telemetry, follow this procedure:

1. Press the main menu button  on the front panel of the telemetry.
2. If prompted, input the password for the screen lock dialog. When **Screen Lock** is set to **Off**, skip this step.
3. Select **Unpair**.
4. Select which device is used to continue monitoring the patient.
 - ◆ **Telemetry**: the telemetry is used to continue monitoring the patient. The monitor enters standby.

- ◆ **Monitor:** the monitor is used to continue monitoring the patient. The telemetry enters standby.
- ◆ **Cancel:** do not unpair the telemetry and the monitor.

7.4 Troubleshooting

Problem	Possible Cause	Corrective Action
Telemetry Disconnected	The telemetry is out of the wireless network coverage area.	Put the telemetry in the Wi-Fi coverage area.
	The telemetry is powered off.	Power on the telemetry.
	The monitor is not connected to the network or network settings are incorrect.	Verify that the monitor's network settings are correct and the monitor is connected to the network.
	The telemetry is not connected to the wireless network or wireless network settings are incorrect.	Verify that the telemetry's network settings are correct and the telemetry is connected to the wireless network.
	The exchanger network connected by the telemetry and the monitor does not support multicast data transfer.	Contact the service personnel.
After the telemetry is paired with the monitor, ECG and Pleth waveforms from the telemetry are not properly displayed on the monitor screen.	Wireless signal interference exists.	<ul style="list-style-type: none"> ■ Put the telemetry in the wireless coverage area. ■ Check the interference source and reduce or eliminate interference.
	Wireless signals are weak.	<ul style="list-style-type: none"> ■ Put the telemetry in the wireless network coverage area with strong signals. ■ Remove any metallic obstructions that stand between the telemetry and the monitor.
	Insufficient network bandwidth or greater network delay leads to data transfer delay.	Contact the service personnel.
The telemetry occasionally goes offline.	Wireless signal interference exists.	<ul style="list-style-type: none"> ■ Put the telemetry in the wireless network coverage area. ■ Check the interference source and reduce or eliminate interference.
	Wireless signals are weak.	<ul style="list-style-type: none"> ■ Put the telemetry in the wireless network coverage area with strong signals strength. ■ Remove any metallic obstructions between the telemetry and the monitor.
	Insufficient network bandwidth or greater network delay leads to data transfer delay.	Contact the service personnel.
Telemetry Low Battery or Telemetry Battery Depleted	The telemetry battery charge is low or depleted.	Replace the battery with a known good one.

This page intentionally left blank.

8 Alarms

8.1 Alarm Introduction

This chapter describes alarm functions and alarm settings.

8.2 Alarm Safety Information

WARNING

- **A potential hazard can exist if different alarm presets and default configuration settings are used for the same or similar equipment in the same care area, for example an intensive care unit or cardiac operating room.**
 - **If the monitor is connected to the central monitoring system (CMS) or other monitors, alarms can be presented and controlled remotely. Remote suspension, inhibition, or reset of monitor alarms via the CMS or other monitors may cause a potential hazard. For more information, see the operator's manuals for the CMS and the other monitors.**
 - **The monitors in the care area may each have different alarm settings to suit different patients. Always check that the alarm settings are appropriate for the patient before starting the monitoring. Always make sure that necessary alarm limits are active and set according to the patient's clinical condition.**
 - **Setting alarm limits to extreme values may cause the alarm system to become ineffective. For example, setting the SpO₂ high alarm limit to 100%, is equivalent to switching the alarm off.**
 - **When the alarm sound is switched off, the monitor gives no alarm tones even if a new alarm occurs. Be careful when considering to switch off the alarm sound. When the alarms are off or while alarm audio is paused either temporarily or indefinitely, observe the patient frequently.**
 - **When monitoring patients that are not continuously attended by a clinical operator, properly configure the alarm system and adjust alarm settings as per the patient's condition.**
 - **Do not rely exclusively on the audible alarm system for monitoring. Adjustment of alarm volume to a low level may result in a hazard to the patient.**
-

8.3 Understanding the Alarms

8.3.1 Alarm Categories

The monitor has two different types of alarms: physiological alarms and technical alarms.

- Physiological alarms are triggered by patient measurement exceeding the parameter limits, or by an abnormal patient conditions.
- Technical alarms are triggered by an electrical, mechanical, connectivity, or other monitor abnormal operation, or by failure of a sensor or component. Technical alarm conditions may also be caused when an algorithm cannot classify or interpret the available data.

Apart from the physiological and technical alarms, the monitor can also prompt with some messages describing the system status or patient status.

8.3.2 Alarm Priorities

By severity, the alarms are classified into the following priority levels:

- High priority alarms: indicate a life threatening situation or a severe device malfunction. High priority alarms require an immediate response.
- Medium priority alarms: indicate abnormal vital signs or a device malfunction. Medium priority alarms require a timely response.

- Low priority alarms: indicate a discomfort condition, a device malfunction, or an improper operation. Low priority alarms require you to be aware of this condition.
- Messages: provides additional information on the patient or the equipment.

8.3.3 Alarm Indicators

When an alarm occurs, the monitor indicates it through visual or audible alarm indications. For more information, see the following table.





Alarm Indicator		High Priority Alarm	Medium Priority Alarm	Low Priority Alarm	Message	Comments
Alarm lamp		Red Flashing frequency: 1.4 - 2.8 Hz Duty cycle: 20 - 60% on	Yellow Flashing frequency: 0.4 - 0.8 Hz Duty cycle: 20 - 60% on	Cyan No flashing Duty cycle: 100% on	None	None
Audible tone pattern	ISO	Repeat pattern of triple + double + triple + double beeps	Repeat pattern of triple beeps	Single beep	None	None
	Mode 1	Repeat pattern of high-pitched single beep	Repeat pattern of double beeps	Low-pitched single beep	None	
	Mode 2	Repeat pattern of high-pitched triple beeps	Repeat pattern of double beeps	Low-pitched single beep	None	
Alarm message		White text inside a red box	Black text inside a yellow box	Black text inside a cyan box	White text	Alarm messages are displayed in the alarm information area at the top of the screen. You can select the alarm messages to show the alarm list.
Alarm priority indicator		***	**	*	None	The indicator appears in front of the corresponding alarm message.
Parameter value		White text inside a flashing red box	Black text inside a flashing yellow box	Black text inside a flashing cyan box	None	None

NOTE

- **When multiple alarms of different priority levels occur simultaneously, the monitor selects the highest priority alarm to light the alarm lamp and issue the alarm tone.**
- **When multiple alarms of different priority levels occur simultaneously and should be displayed in the same area, the monitor only displays the messages from the highest priority alarm.**
- **When multiple alarms of the same priority levels occur simultaneously alarm messages are displayed cyclically.**
- **Some physiological alarms, such as Asystole, are exclusive. They have identical alarm tones and alarm lights with normal high level physiological alarms, but their alarm messages are displayed exclusively. That is, when an exclusive physiological alarm and a normal high level physiological alarm are triggered simultaneously, only exclusive physiological alarm message will be displayed.**

8.3.4 Alarm Status Symbols

Apart from the alarm indicators as described in **8.3.3 Alarm Indicators**, the monitor uses the following symbols to indicate the alarm status:

-  Alarm pause: indicates that all the alarms are paused.
-  Alarm off: indicates that individual measurement alarms are turned off or the system is in the alarm off status.
-  Audio pause: indicates that audible alarm tones are paused.
-  Audio off: indicates that audible alarm tones are turned off.
-  Alarm reset: indicates that the alarm system is reset.

8.4 Accessing On-screen Help for Technical Alarms (AlarmSight)

In the technical alarm list, alarm messages followed by **Detail** include help messages or pictures to help you identify the problem. This function is called AlarmSight. To access AlarmSight, follow this procedure:

1. Select an alarm displaying in the technical alarm information area to enter the **Alarms** dialog.
2. From the alarm list select the desired alarm.

NOTE

- If there are no displayed alarms, then selecting the technical alarm area will not open any dialogs.

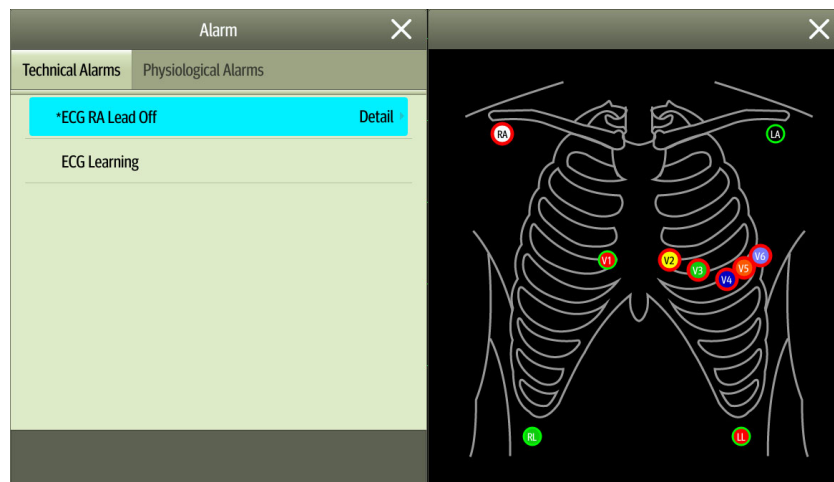

8.5 Checking the Physiological Alarms List

If the patient monitor has more than one physiological alarm, you can see the physiological alarm list by selecting the physiological alarm information area to enter the **Alarms** dialog. If there is only one physiological alarm, selecting the physiological alarm information area enters the **Review** dialog for the event created by this alarm.

8.6 Changing Alarm Settings

Alarms settings can be changed by selecting Main Menu and choosing from the list in the Alarm column.

8.6.1 Setting Parameter Alarm Properties

To set parameter alarm properties, follow this procedure:

1. Access the **Limits** page in either of the following WAYS:
 - ◆ Select the **Alarm Setup** quick key.
 - ◆ Select the **Main Menu** quick key → from the **Alarm** column select **Limits**.
2. Enter the password if required.
3. Select a parameter tab and set alarm properties as desired.

You can also change the alarm properties of individual parameter from the corresponding parameter dialog.

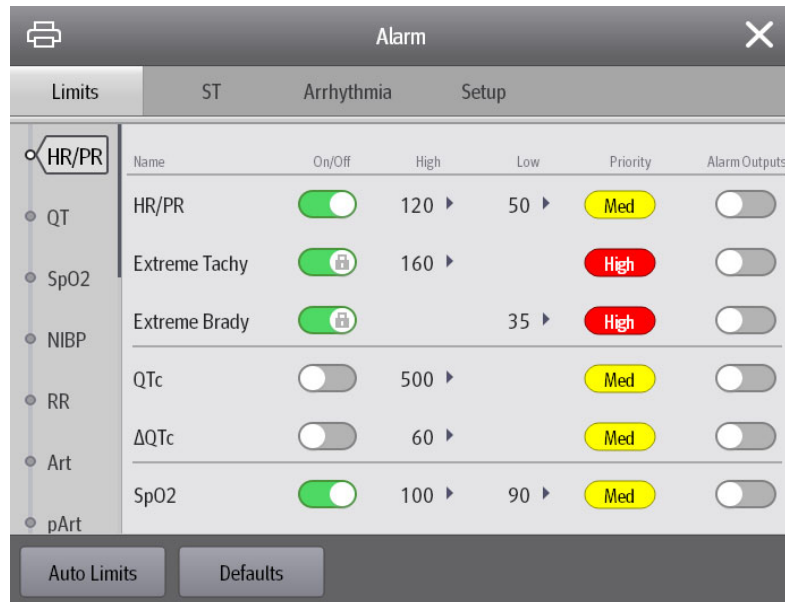

NOTE

- The monitor can be configured to require a password or login to change alarm settings. For more information, refer to 33.14.3 *Selecting Password for User Authentication*.

8.6.2 Changing the Alarm Volume

To change the alarm volume, follow this procedure:

1. Access the **Setup** page in either of the following ways:
 - ◆ Select the **Alarm Setup** quick key → select the **Setup** tab.
 - ◆ Select the **Main Menu** quick key → from the **Alarm** column select **Setup**.
2. Set **Alarm Volume**. The alarm volume can be set from X to 10, in which X is the minimum volume allowed by your department, and 10 is the maximum volume.
3. Select **High Alarm Volume** to set the volume of the high priority alarm.
4. Select **Reminder Volume** to set the volume of the reminder tone.

NOTE

- Alarm volume can only be set to 0 if the monitor is connected to a Central Monitoring System.
- When the alarm volume is set to 0, the alarm sound is turned off and the audio off symbol appears on the screen.
- You cannot set the volume of high priority alarms if Alarm Volume is set to 0.
- You can set the Alarm Volume to 0 only when your monitor is connected to the CMS. If your monitor is not connected to the CMS, the lowest setting of Alarm Volume is 1.
- When the monitor is connected to the CMS and Alarm Volume is set to 0, Alarm Volume automatically changes to 2 if the CMS is disconnected.

8.6.3 Setting the Auto Limits for New Patient Switch

If the **Auto Limits for New Patient** function is enabled, a dialog box can pop up to ask you whether to set alarm limits based on the latest parameter measurements for a newly admitted patient. To set the **Auto Limits for New Patient** switch, follow this procedure:

1. Enter the alarm setup page in any of the following ways:
 - ◆ Select the **Alarm Setup** quick key → select the **Setup** tab.
 - ◆ Select the **Main Menu** quick key → from the **Alarm** column select **Setup**.
2. Set the **Auto Limits for New Patient** switch.

When **Auto Limits for New Patient** is switched on, the confirmation dialog box pops up if all of the following requirements are met:

- Within 10 minutes after the patient is admitted.
- Continuous measurements are stable.
- An NIBP measurement has been taken.
- HR alarm switch is on.
- No lethal alarms are triggered.
- The patient is not in poor perfusion condition.
- Alarm limits of no parameters were manually changed.
- The monitor is not in intubation mode, private mode, or CPB mode.

NOTE

- **The Auto Limits for New Patient function is intended for newly admitted patients only.**
- **The automatically set alarm limits take effect only after being confirmed.**

8.6.4 Initiating Auto Alarm Limits

The monitor provides the auto alarm limits function to automatically adjust alarm limits according to the patient's vital signs. When auto limits are selected, the monitor calculates safe auto limits based on the latest measured values. To get accurate auto alarm limits, collect a set of measured vital signs as a baseline.

To initiate auto alarm limits, follow this procedure:

1. Access the **Limits** page in either of the following ways:
 - ◆ Select the **Alarm Setup** quick key.
 - ◆ Select the **Main Menu** quick key → from the **Alarm** column select **Limits**.
2. From the **Limits** page, select **Auto Limits** at the left bottom.
3. Select **Ok** from the popup dialog box.

Then the monitor will automatically calculate alarm limits based on the latest measured values. Before applying these automatically created alarm limits, confirm if they are appropriate for the patient from the **Limits** dialog. If not, you can adjust them manually. These alarm limits will remain unchanged until you select auto limits again or adjust them manually.

The monitor calculates auto limits based on the following rules:

Module	Parameter	Lower Limit		Upper Limit		Auto Limit Range
		Adult/ pediatric	Neonate	Adult/ pediatric	Neonate	
ECG	HR/PR (bpm)	HR × 0.8 or 40 (whichever is greater)	(HR - 30) or 90 (whichever is greater)	HR × 1.25 or 240 (whichever is smaller)	(HR + 40) or 200 (whichever is smaller)	Adult/pediatric: 35 to 240 Neonate: 55 to 225

Module	Parameter	Lower Limit		Upper Limit		Auto Limit Range
		Adult/ pediatric	Neonate	Adult/ pediatric	Neonate	
Resp	RR (rpm)	$RR \times 0.5$ or 6 (whichever is greater)	$(RR - 10)$ or 30 (whichever is greater)	$(RR \times 1.5)$ or 30 (whichever is smaller)	$(RR + 25)$ or 85 (whichever is smaller)	Adult/pediatric: 6 to 55 Neonate: 10 to 90
SpO ₂	SpO ₂ (%)	Same as the default alarm limit	Same as the default alarm limit	Same as the default alarm limit	Same as the default alarm limit	Same as the measurement range
NIBP	NIBP-S (mmHg)	$(SYS \times 0.68 + 10)$	$(SYS - 15)$ or 45 (whichever is greater)	$(SYS \times 0.86 + 38)$	$(SYS + 15)$ or 105 (whichever is smaller)	Adult: 45 to 270 Pediatric: 45 to 185 Neonate: 35 to 115
	NIBP-D (mmHg)	$(Dia \times 0.68 + 6)$	$(Dia - 15)$ or 20 (whichever is greater)	$(Dia \times 0.86 + 32)$	$(Dia + 15)$ or 80 (whichever is smaller)	Adult: 25 to 225 Pediatric: 25 to 150 Neonate: 20 to 90
	NIBP-M (mmHg)	$(Mean \times 0.68 + 8)$	$(Mean - 15)$ or 35 (whichever is greater)	$(Mean \times 0.86 + 35)$	$(Mean + 15)$ or 95 (whichever is smaller)	Adult: 30 to 245 Pediatric: 30 to 180 Neonate: 25 to 105
Temp (xx refers to temperature site)	Txx (°C)	$(Txx - 0.5)$	$(Txx - 0.5)$	$(Txx + 0.5)$	$(Txx + 0.5)$	1 to 49
	ΔT (°C)	Same as the default alarm limit	Same as the default alarm limit	Same as the default alarm limit	Same as the default alarm limit	Same as the measurement range
IBP: ART/ Ao/UAP/ BAP/FAP/ LV/P1-P4 (Arterial pressure)	IBP-S (mmHg)	$SYS \times 0.68 + 10$	$(SYS - 15)$ or 45 (whichever is greater)	$SYS \times 0.86 + 38$	$(SYS + 15)$ or 105 (whichever is smaller)	Adult: 45 to 270 Pediatric: 45 to 185 Neonate: 35 to 115
	IBP-D (mmHg)	$(Dia \times 0.68 + 6)$	$(Dia - 15)$ or 20 (whichever is greater)	$(Dia \times 0.86 + 32)$	$(Dia + 15)$ or 80 (whichever is smaller)	Adult: 25 to 225 Pediatric: 25 to 150 Neonate: 20 to 90
	IBP-M (mmHg)	$Mean \times 0.68 + 8$	$(Mean - 15)$ or 35 (whichever is greater)	$Mean \times 0.86 + 35$	$(Mean + 15)$ or 95 (whichever is smaller)	Adult: 30 to 245 Pediatric: 30 to 180 Neonate: 25 to 105
IBP: PA	IBP-S (mmHg)	$SYS \times 0.75$	$SYS \times 0.75$	$SYS \times 1.25$	$SYS \times 1.25$	3 to 120
	IBP-D (mmHg)	$Dia \times 0.75$	$Dia \times 0.75$	$Dia \times 1.25$	$Dia \times 1.25$	3 to 120
	IBP-M (mmHg)	$Mean \times 0.75$	$Mean \times 0.75$	$Mean \times 1.25$	$Mean \times 1.25$	3 to 120
IBP: CPP	CPP (mmHg)	$CPP \times 0.68 + 8$	$(CPP - 15)$ or 35, (whichever is greater)	$CPP \times 0.86 + 35$	$(CPP + 15)$ or 95, (whichever is smaller)	Adult: 20 to 235 Pediatric: 25 to 175 Neonate: 25 to 100
IBP: CVP/ LAP/ RAP/ UVP/P1- P4 (Venous pressure)	IBP-M (mmHg)	$Mean \times 0.75$	$Mean \times 0.75$	$Mean \times 1.25$	$Mean \times 1.25$	3 to 40

Module	Parameter	Lower Limit		Upper Limit		Auto Limit Range
		Adult/ pediatric	Neonate	Adult/ pediatric	Neonate	
CO ₂	EtCO ₂ (mmHg)	0 to 32: remains the same	0 to 32: remains the same	0 to 32: remains the same	0 to 32: remains the same	Same as the measurement range
		33 to 35: 29	33 to 35: 29	33 to 35: 41	33 to 35: 41	Same as the measurement range
		36 to 45: (etCO ₂ - 6)	36 to 45: (etCO ₂ - 6)	36 to 45: (etCO ₂ + 6)	36 to 45: (etCO ₂ + 6)	Same as the measurement range
		46 to 48: 39	46 to 48: 39	46 to 48: 51	46 to 48: 51	Same as the measurement range
		>48: remains the same	>48: remains the same	>48: remains the same	>48: remains the same	Same as the measurement range
	FiCO ₂	None	None	Same as the default alarm limit	Same as the default alarm limit	Same as the measurement range
awRR (rpm)	awRR × 0.5 or 6 (whichever is greater)	(awRR - 10) or 30 (whichever is greater)	awRR × 1.5 or 30 (whichever is smaller)	(awRR+25) or 85 rpm (whichever is smaller)	Adult/pediatric: 6 to 55 Neonate: 10 to 90	
AG	EtCO ₂	Same as the CO ₂ module				
	FiCO ₂	Same as the CO ₂ module				
	awRR (rpm)	awRR × 0.5 or 6 (whichever is greater)	(awRR - 10) or 30 (whichever is greater)	awRR × 1.5 or 30 (whichever is smaller)	awRR+25 or 85 (whichever is smaller)	Adult/pediatric: 6 to 55 Neonate: 10 to 90
	FiAA/EtAA	Same as the default alarm limit	Same as the default alarm limit	Same as the default alarm limit	Same as the default alarm limit	Same as the measurement range
	FiO ₂ /EtCO ₂	Same as the default alarm limit	Same as the default alarm limit	Same as the default alarm limit	Same as the default alarm limit	Same as the measurement range
	FiN ₂ O/ EtN ₂ O	Same as the default alarm limit	Same as the default alarm limit	Same as the default alarm limit	Same as the default alarm limit	Same as the measurement range
C.O.	TB (°C)	Adult: (TB - 1) Pediatric: N/A	N/A	Adult: (TB + 1) Pediatric: N/A	N/A	Same as the measurement range
	C.I.	N/A	N/A	N/A	N/A	N/A
	TFC	N/A	N/A	N/A	N/A	N/A
SvO ₂	SvO ₂ (%)	SvO ₂ - 5	N/A	SvO ₂ + 5	N/A	Same as the measurement range
	ScvO ₂ (%)	ScvO ₂ - 5	N/A	ScvO ₂ + 5	N/A	Same as the measurement range
rSO ₂	rSO ₂	Same as the default alarm limit	Manual mode: same as the default alarm limit Auto mode: remains unchanged	Same as the default alarm limit	Manual mode: same as the default alarm limit Auto mode: remains unchanged	15 to 95

8.6.5 Setting the Apnea Delay Time

To set the apnea delay time, follow this procedure:

1. Access the **Setup** page in either of the following ways:
 - ◆ Select the **Alarm Setup** quick key → select the **Setup** tab.
 - ◆ Select the **Main Menu** quick key → from the **Alarm** column select **Setup**.
2. Select **Apnea Delay** to set the apnea delay time.

8.6.6 Switching On or Off V-Tach Latching

When **V-Tach Latching Lock** is switched on, you can switch on or off **V-Tach Latching**. To do so, follow this procedure:

1. Access the **Setup** page in either of the following ways in either of the following ways:
 - ◆ Select the **Alarm Setup** quick key → select the **Setup** tab.
 - ◆ Select the **Main Menu** quick key → from the **Alarm** column select **Setup**.
2. Switching on or off **V-Tach Latching**.

For information on the V-Tach Latching function, see 33.3.4 *Latching Physiological Alarms*.

8.6.7 Restoring the Default Alarm Settings

To reset all alarm settings to the defaults, follow this procedure:

1. Access the **Alarm** page in either of the following ways:
 - ◆ Select the **Alarm Setup** quick key.
 - ◆ Select the **Main Menu** quick key → from the **Alarm** column select **Limits**.
2. On the **Limits** page, select **Defaults** at the bottom.

8.6.8 Setting the Length of Printed Waveforms

You can define the length of printed waveforms when an alarm is triggered. To do so, follow this procedure:

1. Access the **Setup** page in either of the following ways:
 - ◆ Select the **Alarm Setup** quick key → select the **Setup** tab.
 - ◆ Select the **Main Menu** quick key → from the **Alarm** column select **Setup**.
2. Set **Printing Duration On Alarm**.

8.7 Pausing Alarms/Pausing Alarm Tones

You can either pause alarms or pause alarm tones. This depends on the pause setting. To set the pause function, refer to 33.3.3 *Defining the Pause Function*.

8.7.1 Pausing Alarms

If the Pause function is configured to alarm pause, pressing the **Alarm Pause** quick key can temporarily disable alarm indicators. For the configuration of the pause function, see 33.3.3 *Defining the Pause Function*. When alarms are paused, the following rules are followed:

- No physiological alarm will be presented.
- For technical alarms, alarm sounds are paused, but alarm lamps and alarm messages continue to be presented.
- The remaining alarm pause time is displayed in the physiological alarm information area.
- The alarm pause symbol is displayed in the system information area.

When the alarm pause time expires, the alarm paused state is automatically deactivated. You can also cancel the alarm paused state by pressing the **Alarm Pause** quick key again.

8.7.1.1 Prolonging the Alarm Pause Time

If enabled, you can temporarily prolong the alarm pause time after the monitor enters the alarm paused state. This capability is disabled by default. To prolong the alarm pause time, follow this procedure:

1. In the physiological alarm information area, select the alarm pause countdown.
2. Select **Pause 5 min**, **Pause 10 min**, or **Pause 15 min**.

NOTE

- **Prolonging alarm pause time does not affect the setting of alarm pause time.**

8.7.1.2 Switching Off All Alarms

If **Pause Time** is set to **Permanent** (see section 33.3.3.1 *Setting the Alarm Pause Time/Alarm Tone Pause Time*), pressing the **Alarm Pause** quick key permanently switches off all alarms. The alarm off state has the following features:

- Physiological alarms are switched off. The alarm lamp does not flash and alarm sound is not issued.
- Alarm sound of technical alarms is switched off, but alarm lamp flashes and alarm messages are presented.
- The message **Alarm Off** with red background is displayed in the physiological alarm information area.
- The alarm off symbol is displayed in the system status information area.

To exit the alarm off state, press the **Alarm Pause** quick key again.

WARNING

- **Pausing or switching off alarms may result in a hazard to the patient.**

8.7.2 Pausing Alarm Sound

If the Pause function is configured to Audio Pause, pressing the **Audio Pause** quick key pauses alarm tone and sets the quick key to be highlighted. For the configuration of the pause function, see section 33.3.3 *Defining the Pause Function*. When alarm tones are paused, the following rules are followed:

- The sound of all physiological alarms and technical alarms are switched off.
- The remaining audio pause time is displayed in the physiological alarm information area.
- The audio pause symbol is displayed in the system information area.

When the audio pause time expires, the audio paused state is automatically deactivated. You can also cancel the audio paused state by pressing the highlighted **Audio Pause** quick key again.

8.7.2.1 Prolonging the Alarm Tone Pause Time

If enabled, you can temporarily prolong the alarm tone pause time after the monitor enters the alarm tone paused state. This capability is disabled by default. To prolong the audio pause time, follow this procedure:

1. In the physiological alarm information area, select the alarm pause countdown.
2. Select the alarm tone pause time. Options may include **Pause 5 min**, **Pause 10 min**, or **Pause 15 min**.

NOTE

- **Prolonging alarm pause time does not affect the setting of alarm tone pause time.**

8.7.2.2 Switching Off Alarm Sound

If **Pause Time** is set to **Permanent** (see section 33.3.3.1 *Setting the Alarm Pause Time/Alarm Tone Pause Time*), pressing the **Audio Pause** quick key permanently switches off all alarm sound. The audio off state has the following features:

- Alarm sound of both physiological alarms and technical alarms is switched off.
- The audio off symbol is displayed in the system information area.

To exit the audio off state, press the **Audio Pause** quick key again.

WARNING

- **Pausing or switching off alarm sound may result in a hazard to the patient.**
-
-

8.8 Resetting Alarms

Press the **Alarm Reset** quick key to reset the alarm system. When the alarm system is reset, the alarm reset symbol displays in the system status information area for alarm symbols.

NOTE

- **If a new alarm is triggered after the alarm system is reset, the alarm reset icon will disappear and the alarm light and alarm tone will be reactivated.**
-

8.8.1 Resetting Physiological Alarms

For physiological alarms, when the alarm system is reset, the following occur:

- The alarm sound is silenced.
- A √ appears before the alarm message.
- The color of the parameter numeric background corresponds with the alarm priority, but the parameter numeric does not flash.

8.8.2 Resetting Technical Alarms

For technical alarms, when the alarm system is reset, the following occur:

- Some technical alarms are cleared. The monitor gives no alarm indications.
- Some technical alarms are changed to prompt messages.
- For some technical alarms, the alarm is silenced and a √ appears before the alarm message.

For details about the indications of technical alarms when the alarm system is reset, see *D.2 Technical Alarm Messages*.

8.9 Latching Alarms

The latching setting for physiological alarms defines how alarm indicators behave if you do not reset the alarms.

- If you do not “latch” physiological alarms, their alarm indications disappear when the alarm condition ends.
- If you “latch” physiological alarms, all visual and audible alarm indications remain (if configured) until the alarms are reset. For latched alarms the time when the alarm is last triggered is displayed behind the alarm message.

The monitor can be set to separately latch visual indications or simultaneously latch the visual and the audible indications.

- When visual indications are latched, visual indications, including alarm lamp, alarm message and its background remain when the alarm condition ends and the time when the alarm last triggered is displayed behind the alarm message.
- When audible indications are latched, the monitor continues to issue alarm sounds when the alarm condition ends.

To set how you want to latch the physiological alarms, see section 33.3.4 *Latching Physiological Alarms*.

NOTE

- **Changing alarm priority may affect the latching status of the corresponding alarm. Determine if you need to adjust the latching status for the specific alarm when you have changed its alarm priority.**
 - **When the alarm system is reset, latched physiological alarms are cleared.**
-

8.10 Nurse Call

The monitor provides a nurse call connector to output a nurse call signal when a user-defined alarm occurs. To obtain a nurse call signal, use the nurse call cable to connect the hospital nurse call system with the monitor's nurse call connector.

Alarms are indicated on the nurse call device only when the following conditions are met:

- The nurse call system is enabled.
- A user-defined alarm occurs.
- Alarms are not paused or reset.

WARNING

- **Do not rely exclusively on the nurse call system for alarm notification. Remember that the most reliable alarm notification combines audible and visual alarm indications with the patient's clinical condition.**
-

8.11 Calling for Help

This monitor can be configured to call monitors in the same department, the central station, and the nurse call system so that nearby doctors and nurses can come for help.

8.11.1 Issuing the Call Help Signal

To call help, select the **Call Help** quick key and select **Ok** from the popup dialog box. If **Ok** is not selected within 5 seconds then the monitor will automatically send out the call help signal.

After the call help signal is sent out, the **Call Help** quick key flashes in red. Select the **Call Help** quick key again to stop the call help signal.

Monitors receiving the call help signal issue a sound and a dialog box pops up indicating which monitor is calling. Select **Ok** to acknowledge the call and stop the sound at this monitor.

NOTE

- **The call help function works only when the monitor is connected to the network.**
 - **The call help sound may disturb patients in the same department.**
-

8.12 CPB Mode

The CPB (Cardiopulmonary Bypass) mode is activated only if you set the department to **OR**.

In the CPB mode, except for EEG, NMT, tcGas, and rSO₂ related alarms, all the physiological alarms and technical alarms are switched off. So when performing CPB, you can put the monitor in the CPB mode to inactivate unnecessary alarms.

8.12.1 Entering the CPB Mode

To enter the CPB mode, choose either of the following ways:

- Select the **CPB Mode** quick key.
- Select the **Main Menu** quick key → from the **Alarm** column select **CPB Mode**.

In the CPB mode, **CPB Mode** is displayed in the physiological alarm area with a red background color.

NOTE

- **When the CPB mode is entered, the monitor stops all NIBP measurements. You can restart NIBP measurements after entering the CPB mode.**
-

8.12.2 Exiting the CPB Mode

To exit the CPB mode, choose either of the following ways:

- Select the **CPB Mode** quick key.
- Select the **Main Menu** quick key → from the **Alarm** column select **Exit CPB Mode**.

8.13 Intubation Mode

Intubation mode is available for Resp, CO₂, and AG monitoring. When performing intubation during general anesthesia, you can put the monitor in the intubation mode in order to inactivate unnecessary alarms.

In the intubation mode, Resp, CO₂, and AG related physiological alarms are switched off.

8.13.1 Entering the Intubation Mode

To enter the intubation mode, choose either of the following ways:

- Select the **Intubation Mode** quick key.
- From the bottom of the **Resp, CO₂, or AG** dialog, select **Intubation Mode**.
- Select the **Main Menu** quick key → from the **Alarm** column select **Intubation Mode**.

8.13.2 Exiting the Intubation Mode

To exit the intubation mode, choose either of the following ways:

- Select the **Intubation Mode** quick key.
- From the bottom of the **Resp, CO₂, or AG** dialog, select **Exit Intubation Mode**.
- Select the **Main Menu** quick key from the **Alarm** column → select **Exit Intubation Mode**.

8.14 Testing Alarms

The monitor automatically performs a selftest at startup. Check that an alarm tone is heard, the alarm lamp illuminates, one after the other, in red, yellow, and cyan. This indicates that the visible and audible alarm indicators function correctly.

To further test individual measurement alarms, perform measurements on yourself or using a simulator. Adjust alarm limits and check that appropriate alarm behavior is observed.

9

Monitoring ECG, Arrhythmia, ST and QT

9.1 ECG Introduction

The electrocardiogram (ECG) measures the electrical activity of the heart and displays it on the monitor as waveforms and numerics. ECG monitoring provides 3-, 5-, 6-, and 12-lead ECG monitoring, ST-segment analysis, arrhythmia analysis, QT/QTc measurements, and optional 12-lead resting analysis via the Glasgow algorithm.

The associated module incorporating ST analysis has the ST label.

The associated module incorporating 12-lead has the 12-lead label.

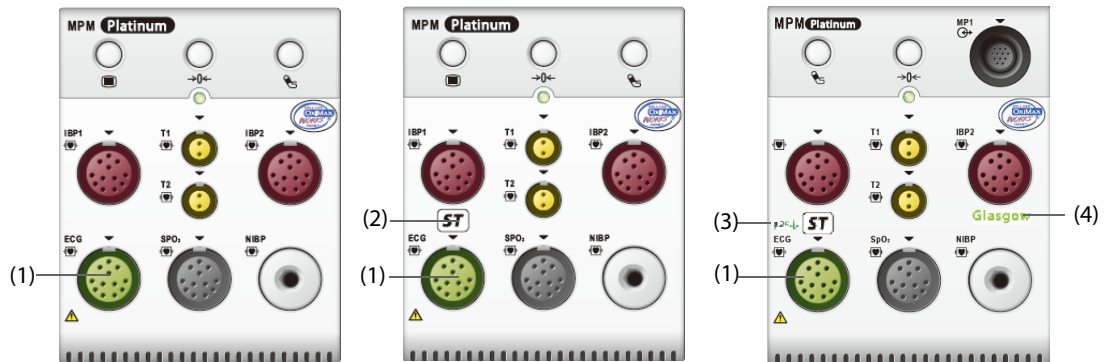

(1) ECG cable connector (2) ST label (3) 12-lead label (4) Glasgow label

9.2 ECG Safety Information

WARNING

- This equipment is not intended for direct cardiac application.
- Ensure that the conductive parts of ECG electrodes and associated connectors, including the neutral electrode, do not come into contact with any other conductive parts including earth.
- Always use defibrillation-proof ECG cables during defibrillation.
- Do not touch the patient, or metal devices connected to the patient, during defibrillation.
- To minimize the hazard of burns during high-frequency surgical procedures, ensure that the monitor's cables and transducers never come into contact with the electrosurgery unit (ESU).
- To minimize the hazard of burns during use of high-frequency surgical unit (ESU), the ECG electrodes should not be located between the surgical site and the ESU return electrode.



CAUTION

- Only use parts and accessories specified in this manual. Follow the instructions for use and adhere to all warnings and cautions.
- Periodically inspect the electrode application sites to ensure skin integrity. If the skin quality changes, replace the electrodes or change the application site.
- Interference from an ungrounded instrument near the patient or electrosurgery usage can induce noise and artifact into the waveforms.

9.3 ECG Display

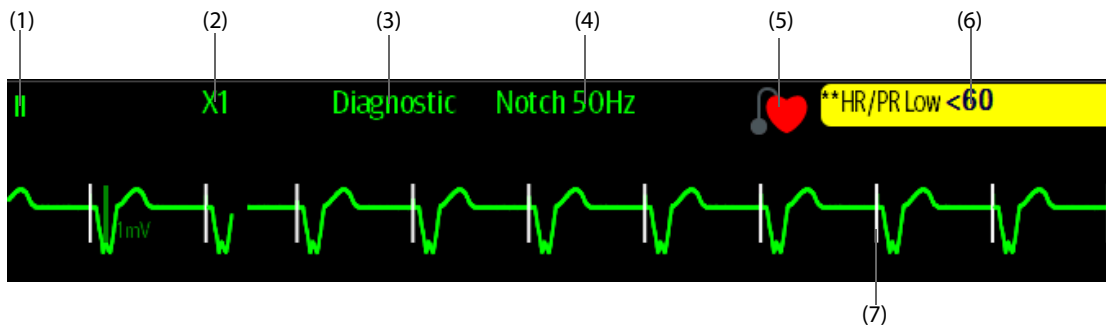
The following figures show the ECG waveform and numeric areas. The display may be configured to look slightly different.



- (1) ECG lead label of the displayed waveform
- (2) ECG waveform gain
- (3) ECG filter mode
- (4) Notch filter status
- (5) Paced status: If **Paced** is set to **Yes**,  is displayed. If **Paced** is set to **No**,  is displayed.
- (6) HR/PR alarm message
- (7) Pace pulse marker: If **Paced** is set to **Yes**, pace pulse markers "I" are displayed corresponding to detected pacer for each beat.

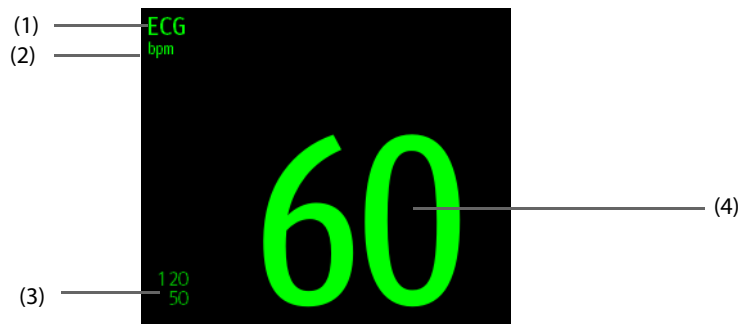

- (1) Parameter label
- (2) HR measurement unit
- (3) HR alarm limits
- (4) HR value

9.4 Preparing for ECG Monitoring

9.4.1 Preparing the Patient Skin

Proper skin preparation is necessary to ensure good signal quality at the electrode sites, as the skin is a poor conductor of electricity. To properly prepare the skin, choose flat areas and then follow this procedure:

1. Shave hair from skin at chosen electrode sites.
2. Gently rub skin surface at sites to remove dead skin cells.
3. Thoroughly cleanse the site with a mild soap and water solution. We do not recommend using ether or pure alcohol, because this dries the skin and increases the resistance.
4. Dry the skin completely before applying electrodes.

9.4.2 Applying Electrodes and Connecting the Patient

To connect ECG cables, follow this procedure:

1. Check that electrode packages are intact and the electrodes are not past the expiry date. Ensure the electrode gel is moist. If you are using snap electrodes, attach the snaps to the electrodes before placing electrodes on the patient.
2. Place the electrodes on the prepared sites. Ensure that all electrodes have good skin contact.

3. Connect the leadwires to the patient cable if not already connected.
4. Plug the patient cable into the ECG connector.

CAUTION

- **Never mix patient electrode types or brands. This may lead to impedance mismatches issues.**
-

NOTE

- **When applying the electrodes, avoid bony area, obvious layers of fat, and major muscles. Muscle movement can result in electrical interference. Applying electrodes on major muscles, for example on muscles of the thorax, may lead to erroneous arrhythmia alarms due to excessive muscle movement.**
-

9.4.3 Lead Wire Color Code

The following table lists the color coding of leadwires for AHA standards:

Lead	Label	Color
Right arm	RA	White
Left arm	LA	Black
Right leg (neutral)	RL	Green
Left leg	LL	Red
Chest 1	V1	Brown/Red
Chest 2	V2	Brown/Yellow
Chest 3	V3	Brown/Green
Chest 4	V4	Brown/Blue
Chest 5	V5	Brown/Orange
Chest 6	V6	Brown/Violet

9.4.4 ECG Electrode Placements

In this section, electrode placement is illustrated using the AHA naming convention.

9.4.4.1 3-leadwire Electrode Placement

The following is the electrode configuration when a 3-leadwire cable is used:

- RA placement: directly below the clavicle and near the right shoulder.
- LA placement: directly below the clavicle and near the left shoulder.
- LL placement: on the left lower abdomen.

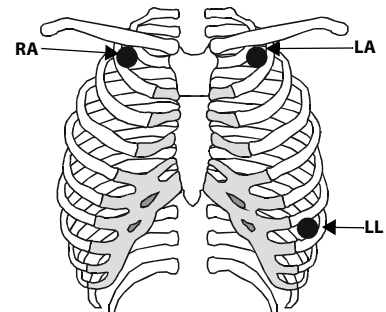

9.4.4.2 5-leadwire and 6-leadwire Electrode Placement

The following is the electrode configuration for a 5-leadwires cables:

- RA placement: directly below the clavicle and near the right shoulder.
- LA placement: directly below the clavicle and near the left shoulder.
- RL placement: on the right lower abdomen.
- LL placement: on the left lower abdomen.
- V placement: on the chest in any of the V1 to V6 positions.

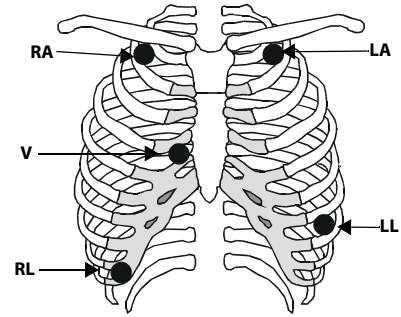

For 6-leadwire placement, you can use the position for the 5 - leadwire placement but with two chest leads. The two chest leads (Va and Vb) can be positioned at any two of the V1 to V6 positions. For more information, see 9.4.4.3 *Chest Electrode Placement*. The Va and Vb lead positions are configurable. For more information, see 9.5.3.3 *Changing Va and Vb Labels*.

9.4.4.3 Chest Electrode Placement

The chest electrode can be placed at the following positions:

- V1 placement: on the fourth intercostal space to the right of the sternum.
- V2 placement: on the fourth intercostal space to the left of the sternum.
- V3 placement: midway between the V2 and V4 electrode positions.
- V4 placement: on the fifth intercostal space at the left midclavicular line.
- V5 placement: on the left anterior axillary line, horizontal with the V4 electrode position.
- V6 placement: on the left midaxillary line, horizontal with the V4 electrode position.
- V3R-V6R placement: on the right side of the chest in positions corresponding to those on the left.

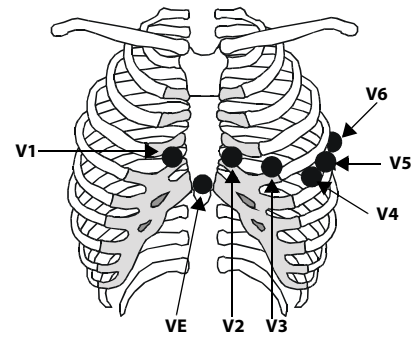

NOTE

- For the 5-leadwire and 6-leadwire placement, place the precordial electrode according to the physician's preference.

9.4.4.4 10-leadwire Electrode Placement

12-lead ECG uses 10 electrodes, which are placed on the patient's four limbs and chest. The limb electrodes should be placed on the limb extremities and the chest electrodes placed according to the physician's preference. The figure at right illustrates the conventional 10-leadwire electrode placement.

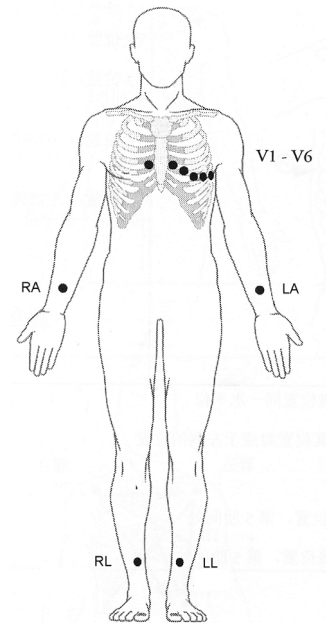

9.4.4.5 Lead Placement for Pacemaker Patients

The recommended lead placement for monitoring a pacemaker patient is as follows.

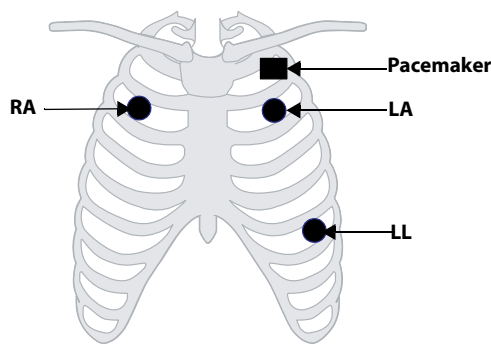

3-leadwire Electrode Placement

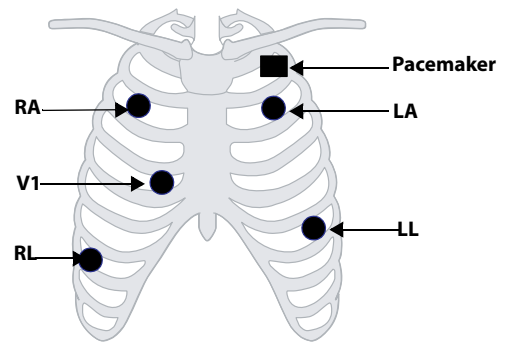

5-leadwire Electrode Placement

A pacemaker patient usually requires a different electrode patch placement configuration than a non-pacemaker patient.

Do not place an ECG electrode directly over the pacemaker generator. Place the electrode patches 2 to 3 inches away from the pacemaker generator area. For example, if the pacemaker generator is located in the left subclavian area, relocate the Left Arm electrode closer in towards the center of the chest.

9.4.4.6 Lead Placement for Surgical Patients

The surgical site should be taken into consideration when placing electrodes on a surgical patient. For example, for open-chest surgery, the chest electrodes can be placed on the lateral chest or back. To reduce artifacts and interference from electrosurgical units, you can place the limb electrodes close to the shoulders and lower abdomen and the chest electrodes on the left side of the mid-chest. Do not place the electrodes on the upper arm. Otherwise, the ECG waveform will be very small.

WARNING

- To reduce the hazard of burns during use of electrosurgical units (ESU), the ECG electrodes should not be located between the surgical site and the ESU return electrode.
- Never entangle the ESU cable and the ECG cable together.



- When using ESU, never place ECG electrodes near the grounding plate of the ESU, as this can cause a lot of interference on the ECG signal.
 - When using ESU, ensure proper contact of the ESU return electrode to the patient to avoid burns at monitor measurement sites. Also ensure that the ESU return electrode is near the operating area.
-
-

9.4.5 Choosing the ECG Lead Type

To choose ECG lead type, follow this procedure:

1. Select the ECG numeric area or waveform area to enter the **ECG** dialog.
2. Select the **Setup** tab.
3. Set **Lead Set** according to the lead type you are going to use. The default lead type is **Auto**. In this case, the monitor automatically detects the lead type.

9.4.6 Checking Paced Status

It is important to correctly set the patient's paced status before you start monitoring ECG. The paced symbol  is displayed when **Paced** is set to **Yes**. Pace pulse markers "P" are displayed on each ECG waveform whenever a pacer signal is detected. If **Paced** is set to **No** or unspecified, the symbol  will be shown in the ECG waveform area.

To change the paced status, follow this procedure:

1. Select the ECG numeric area or waveform area to enter the **ECG** dialog.
2. Select the **Pacer** tab.
3. Set **Paced** to **Yes** or **No**.

You can also change the patient's paced status from the **Patient Management** dialog. For more information, see *5.2.1 Entering the Patient Management Dialog*.

If you did not set the paced status, the monitor issues a prompt tone when pace pulse is detected. At the same time, the paced symbol  flashes and the message **Please check if the patient has a pacemaker?** appears in the ECG waveform area. Check and set the patient's paced status.

WARNING

- **For paced patients, you must set Paced to Yes. If it is incorrectly set to No, the monitor could mistake a pace pulse for a QRS complex and fail to alarm when the ECG signal is too weak. On ventricular paced patients, episodes of ventricular tachycardia may not always be detected. Do not rely entirely upon the system's automated arrhythmia detection algorithm.**
 - **False low heart rate or false asystole alarms may result with certain pacemakers because of pacemaker artifacts, such as electrical overshoot of the pacemaker overlapping the true QRS complexes.**
 - **Do not rely entirely on rate meter alarms when monitoring patients with pacemakers. Always keep these patients under close surveillance.**
 - **The auto pacer recognition function is not applicable to pediatric patients, neonatal patients, and patients with NMT monitoring.**
-
-

9.4.7 Enabling Pacer Rejection

To eliminate the pacing pulse from the ECG waveform of paced patients, it is recommended to enable the pace pulse rejection function. The pace pulse rejection function is disabled by default. To enable this function, follow this procedure:

1. Select the ECG numeric area or waveform area to enter the **ECG** dialog.
2. Select the **Pacer** tab.
3. Switch on **Pacer Reject**.

NOTE

- When pace pulses are detected, the pace pulse markers “|” are shown on the ECG waveforms. Pacer Rejection setting has no impact on the display of pace pulse markers “|”.
 - You can switch on pacer rejection only when Paced is set to Yes. If Paced is set to no, the Pacer Reject function is disabled.
-

9.5 Changing ECG Settings

9.5.1 Choosing an ECG Screen

When monitoring ECG, several display options are available.

- For 3-lead ECG monitoring, only normal screen is available.
- For 5-lead ECG monitoring, besides the normal screen, you can also choose Full-screen (7-lead) or Half Screen (7-lead).
- For 6-lead ECG monitoring, besides the normal screen, you can also choose Full-screen (8-lead) or Half Screen (8-lead).
- For 12-lead ECG monitoring, besides the normal screen, you can also choose Full-screen (7-lead), Half Screen (7-lead), or 12-Lead (12-lead analysis).

To choose the desired screen configuration, follow this procedure:

1. Select the ECG numeric area or waveform area to enter the **ECG** dialog.
2. Select **Full-Screen**, **Half-Screen**, or **12-Lead**.

To return to the normal screen, press the highlighted button to unselect that screen.

Alternately you can choose the desired screen configuration as follows:

1. Select the **Screen Setup** quick key → **Choose Screen** or select the **Main Menu** quick key → from the **Display** column select **Choose Screen**.
2. Select **ECG Full-Screen**, **ECG Half-Screen**, or **ECG 12-Lead**.

9.5.2 Setting ECG Alarm Properties

To select the desired ECG alarm options, follow this procedure:

1. Select the ECG numeric area or waveform area to enter the **ECG** dialog.
2. Select the **Alarm** tab.
3. Select the desired alarm options.

9.5.3 Changing ECG Wave Settings

9.5.3.1 Selecting the Leads of Displayed ECG Waveforms

To select the desired ECG waveforms to be displayed, follow this procedure:

1. Select the ECG numeric area or waveform area to enter the **ECG** dialog.
2. Select the **Setup** tab.
3. Select **ECG** to set the lead of each displayed ECG waveform.
4. If more than three ECG waveforms are to be displayed, select the **More Leads** tab, and then select **ECG** to set leads of other ECG waveforms.

For optimal ECG analysis, select leads with the following characteristics:

- The QRS complex should be either completely above or below the baseline and it should not be biphasic.
- The QRS complex should be tall and narrow.
- The P waves and T waves should be less than 0.2mV.

CAUTION

- **Ensure that you have selected the optimal leads with the best waveform amplitude and the highest signal-to-noise ratio. Selecting the optimal leads is important for detecting beats, classifying beats, and detecting ventricular fibrillation.**
-

9.5.3.2 Changing ECG Waveform Size

If the ECG waveform is too small or clipped, you can change its size by selecting the appropriate **Gain** setting. To do so, follow this procedure:

1. Select the ECG numeric area or waveform area to enter the **ECG** dialog.
2. Select the **Setup** tab.
3. Select **ECG Gain** to set the size of each ECG waveform.
4. If more than three ECG waveforms are displayed, select the **More Leads** tab, and then select **ECG Gain** to change the sizes of other ECG waveforms. If you select **Auto**, the monitor automatically adjusts the size of the ECG waveforms for all the leads.

9.5.3.3 Changing Va and Vb Labels

When monitoring ECG with 6-leadwire. You can change the labels of Va and Vb leads. To do so, follow this procedure:

1. Select the ECG numeric area or waveform area to enter the **ECG** dialog.
2. Select the **Setup** tab.
3. Set **Va** and **Vb** according to the locations of the Va and Vb electrode sites. Default settings are **Va** and **Vb**.

9.5.3.4 Changing ECG Waveform Speed

To change ECG waveform speed, follow this procedure:

1. Select the ECG numeric area or waveform area to enter the **ECG** dialog.
2. Select the **Setup** tab.
3. Set the desired **Speed**.

9.5.3.5 Setting the ECG Filter

To set the appropriate ECG waveform filter mode, follow this procedure:

1. Select the ECG numeric area or waveform area to enter the **ECG** dialog.
2. Select the **Setup** tab.
3. Set **Filter**.
 - ◆ **Diagnostic**: use when diagnostic quality ECG is required. The unfiltered ECG waveform is displayed so that changes such as R-wave notching or discrete elevation or depression of the ST segment are visible.
 - ◆ **Monitor**: use under normal monitoring conditions.
 - ◆ **Surgery**: use when the signal is distorted by high frequency or low frequency interference. High frequency interference usually results in large amplitude spikes making the ECG signal look irregular. Low frequency interference usually leads to wandering or rough baseline. The surgery filter reduces artifacts and interference from electrosurgical units. Under normal measurement conditions, selecting **Surgery** may suppress certain features or details of the QRS complexes.
 - ◆ **ST**: recommended for ST monitoring.

9.5.3.6 Switching On or Off the Notch Filter

The notch filter removes the line frequency interference. To switch on or off the notch filter, follow this procedure:

1. Select the ECG numeric area or waveform area to enter the **ECG** dialog.
2. Select the **Setup** tab.
3. Switch on or off **Notch Filter**.

NOTE

- **The notch filter can only be switched on or off when ECG Filter is set to Diagnostic. In other filter modes, the notch filter is always on.**
-

9.5.4 Disabling the Smart Lead Off Function

The monitor provides the smart lead off function. When the lead corresponding to the first ECG wave gets detached but another lead is available, the monitor automatically switches to the available lead to recalculate heart rate, and to analyze and detect arrhythmias. When you reconnect the detached leads, the monitor automatically switches back to the original lead.

The smart lead off function is enabled by default. To disable this function, follow this procedure:

1. Select the ECG numeric area or waveform area to enter the **ECG** dialog.
2. Select the **Setup** tab.
3. Switch off **Smart Lead**.

9.5.5 Adjusting the QRS Volume

To adjust the QRS volume, follow this procedure:

1. Select the ECG numeric area or waveform area to enter the **ECG** dialog.
2. Select the **Setup** tab.
3. Set **QRS Volume**.

When valid SpO₂ measurements are available, the monitor adjusts the pitch of QRS tone based on the SpO₂ value.

9.5.6 Adjusting the Minimum QRS Detection Threshold

To avoid false asystole alarm due to low R wave amplitude, and to avoid tall T waves and P waves being mistaken for QRS complexes, the monitor provides a means to manually adjust the minimum QRS detection threshold.

To adjust the minimum QRS detection threshold, follow this procedure:

1. Select the ECG numeric area or waveform area to enter the **ECG** dialog.
2. Select the **Setup** tab and set **Filter** to **Monitor**.
3. Select the **QRS Threshold** tab.
4. Select up or down arrow buttons to adjust the minimum threshold for QRS detection. Selecting **Default** resets the QRS threshold to the default value (0.16 mV).

CAUTION

- **The setting of the QRS detection threshold can affect the sensitivity for arrhythmia, ST, QT/QTc detection, and heart rate calculation.**
 - **If the QRS amplitude is low, the monitor might not be able to detect the beats and false asystole calls may occur.**
-

NOTE

- **The minimum QRS detection threshold can only be adjusted when the ECG filter is set to Monitor.**
-

9.6 Monitoring Arrhythmia

Arrhythmia monitoring is intended for adult and pediatric patients.

9.6.1 Arrhythmia Safety Information

WARNING

- Heart rate reading may be affected by cardiac arrhythmias. Do not rely entirely on heart rate alarms when monitoring patients with arrhythmias. Always keep these patients under close surveillance.
 - The arrhythmia analysis program may incorrectly identify the presence or absence of an arrhythmia. Therefore, a physician must analyze the arrhythmia information with other clinical findings.
 - Atrial fibrillation (Afib) detection function is not intended for pediatric and neonatal patients.
-
-

CAUTION

- Since the arrhythmia detection algorithm sensitivity and specificity are less than 100%, it is possible for false arrhythmias to be detected and true arrhythmia events to not be detected. The possibility increases when the signal is noisy.
 - The ECG size and minimum QRS detection threshold settings affect arrhythmia detection and heart rate calculation sensitivity.
 - If QRS amplitude is low, the monitor might be unable to calculate heart rate and thus create false asystole calls. During the learning phase of the algorithm, arrhythmia detection may not be available. It is recommended to closely monitor patient condition during, and for several minutes after, the learning phase to allow the algorithm to reach optimal detection performance.
-

9.6.2 Arrhythmia Events

This section lists all arrhythmia events and their criteria.

9.6.2.1 Lethal Arrhythmia Events

Arrhythmia message	Description
Asystole	No QRS complex detected within the set time interval in the absence of ventricular fibrillation or chaotic signal.
V-Fib/V-Tach	A fibrillatory wave for 6 consecutive seconds. A dominant rhythm of adjacent PVCs and the ventricular rate is greater than the V-tach rate limit.
V-Tach	The number of consecutive PVCs is greater than or equal to the V-Tach PVCs limit, and the ventricular rate is greater than or equal to the V-Tach rate limit.

9.6.2.2 Nonlethal Arrhythmia Events

Arrhythmia message	Description
Vent Brady	The number of consecutive PVCs is greater than or equal to V brady PVC limit and the ventricular rate is less than the V-Brady Rate limit.
Extreme Tachy	The heart rate is greater than the extreme tachycardia limit.
Extreme Brady	The heart rate is less than the extreme bradycardia limit.
R on T	R on T PVC is detected.
Run PVCs	More than two consecutive PVCs, but lower than the V-Brady PVCs limit, and the ventricular rate is lower than the V-Tach rate limit.
Couplet	A Pair of PVCs detected in between normal beats.

Arrhythmia message	Description
Multiform PVC	Multiform PVCs detected in Multif. PVC's Window (which is adjustable).
PVC	One PVC detected in between normal beats.
Bigeminy	A dominant rhythm of N, V, N, V, N, V*.
Trigeminy	A dominant rhythm of N, N, V, N, V, N, V*.
Tachy	The heart rate is greater than the tachycardia limit.
Brady	The heart rate is lower than the bradycardia limit.
Pacer Not Capture	No QRS complex detected for 300 ms following a pace pulse (for paced patients only).
Pacer Not Pacing	No pace pulse detected for 1.75 x average R-to-R intervals following a QRS complex (for paced patients only).
Missed Beat	At least 3 consecutive Ns*, and The current RR interval is greater than 1.5 x previous RR interval, and The next RR interval is lower than 1.5 x average RR interval, and HR lower than 100 and the current RR interval is greater than 1.75 x average RR interval , or HR is greater than or equal to 100 and the current RR interval is greater than 1000 ms.
Nonsus V-Tach	The number of consecutive PVCs is lower than the V-Tach PVCs limit but greater than 2, and the ventricular rate is greater than or equal to the V-Tach Rate limit.
Vent Rhythm	The number of consecutive PVCs is greater than or equal to the V-Brady PVCs limit, and ventricular rate is greater than or equal to the V-Brady Rate limit but lower than V-Tach Rate limit.
Pause	No QRS complex is detected within the set pause time threshold.
Irr Rhythm	Consistently irregular rhythm (N*, irregular RR interval change is greater than 12.5%)
A-Fib (for adult only)	P wave is absent and normal beat RR intervals are irregular.
PVCs/min	PVCs/min exceeds high limit.
Pauses/min	Pauses/min exceeds high limit.
Irr Rhythm End	Irregular rhythm no longer detected for the irregular rhythm end delay time.
A-Fib End (for adult only)	Atrial fibrillation no longer detected for the A-Fib end delay time.

*N: normal beat; V: ventricular beat

9.6.3 Displaying Arrhythmia Information

You can display the arrhythmia information in the numeric area. To do so, follow this procedure:

1. Access **Tile Layout** using either of the following ways:
 - ◆ Select the **Screen Setup** quick key → select the **Tile Layout** tab.
 - ◆ Select **Main Menu** quick key → from the **Display** column select **Tile Layout**.
2. Click the numeric area where you want to display the arrhythmia information, and then select ECG → **Arrhythmia**.

9.6.4 Changing Arrhythmia Settings

9.6.4.1 Changing Arrhythmia Alarm Settings

To set the arrhythmia alarm properties, follow this procedure:

1. Select the ECG numeric area or waveform area to enter the **ECG** dialog.
2. Select the **Arrhythmia** tab → **Alarm** tab.
3. Set alarm properties as desired.

NOTE

- You can switch off lethal arrhythmia alarms only when the monitor is set to enable Lethal Arrhythmia Alarms Off. For more information, see 33.3.10.1 Setting the Lethal Arrhythmia Alarms Switch.
- The priority of lethal arrhythmia alarms is always high. It cannot be altered.

9.6.4.2 Changing Arrhythmia Alarm Threshold Settings

You can change threshold settings for certain arrhythmia alarms. When an arrhythmia exceeds its threshold, an alarm will be triggered. To do so, follow this procedure:

1. Select the ECG numeric area or waveform area to enter the **ECG** dialog.
2. Select the **Arrhythmia** tab → select the **Threshold** tab.
3. Enter the password if required. For more information, refer to 33.14.3 Selecting Password for User Authentication.
4. Set the threshold for the desired arrhythmia alarms.

NOTE

- The asystole delay time relates to ECG relearning. When heart rate is less than 30 bpm, it is recommended to set Asystole Delay to 10 sec.

9.6.4.3 Arrhythmia Threshold Range

Arrhythmia	Threshold Range
Asystole Delay	3 sec to 10 sec
Tachy (HR High)	60 bpm to 295 bpm
Brady (HR Low)	16 bpm to 120 bpm
Extreme Tachy	65 bpm to 300 bpm
Extreme Brady	15 bpm to 115 bpm
Multif PVCs Window	3 beats to 31 beats
V-Tach Rate	100 bpm to 200 bpm
V-Brady Rate	15 bpm to 60 bpm
V-Tach PVCs	3 beats to 99 beats
V-Brady PVCs	3 beats to 99 beats
PVCs/min	1 to 100
Pauses/min	1 to 15
Pause Threshold	1.5 sec, 2.0 sec, 2.5 sec, 3.0 sec
AF/Irr Rhy End Time	0 min, 1 min, 2 min, 3 min, 4 min, 5 min, 10 min, 15 min, 30 min

9.6.4.4 Setting Thresholds for PVC-Related Alarms

PVC-related alarms are detected on the basis of the current PVC rate and the number of consecutive PVCs.

To set the required thresholds for PVC-related alarms, follow this procedure:

1. Select the ECG numeric area or waveform area to enter the **ECG** dialog.
2. Select the **Arrhythmia** tab → select the **More Threshold** tab.

- Enter the password if required. For more information, refer to 33.14.3 *Selecting Password for User Authentication*.

Adjust **V-Tach PVCs**, **V-Tach Rate**, **V-Brady PVCs**, and **V-Brady Rate** as necessary to set the thresholds for the desired PVC-related alarms.

The following figure illustrates the conditions under which PVC alarms will be generated if **V-Tach PVCs** is set to 6, **V-Tach Rate** is set to 130, **V-Brady PVCs** is set to 5, and **V-Brady Rate** is set to 40.

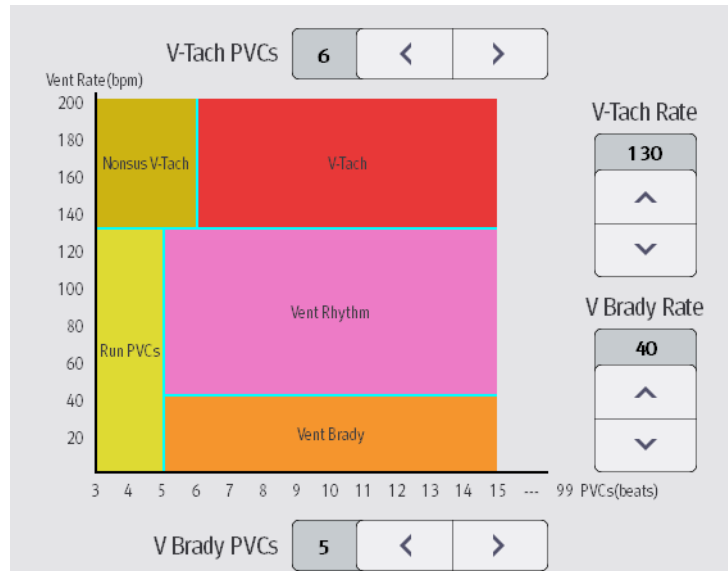

- If the number of consecutive PVCs is greater than or equal to the V-Tach PVCs limit (6), and the ventricular rate (Vent Rate) is greater than or equal to the V-Tach Rate limit (130), a V-Tach alarm is generated.
- If the number of consecutive PVCs is lower than the V-Tach PVCs limit (6) but greater than 2, and the ventricular rate is greater than or equal to the V-Tach Rate limit (130), a Nonsus V-Tach alarm is generated.
- If the number of consecutive PVCs is greater than or equal to the V-Brady PVCs limit (5), and the ventricular rate is lower than the V-Tach Rate limit (130) but greater than or equal to the V Brady Rate limit (40), a Vent Rhythm alarm is generated.
- If the number of consecutive PVCs is lower than the V-Brady PVCs limit (5) but greater than 2, and the ventricular rate is lower than the V-Tach Rate limit (130), a Run PVCs alarm is generated.
- If the number of consecutive PVCs is greater than or equal to the V-Brady PVCs limit (5), and the ventricular rate is lower than the V Brady Rate limit (40), a Vent Brady alarm is generated.

9.6.5 Intelligent Arrhythmia Alarm

Normally, an arrhythmia alarm is presented when an alarm condition is detected. However, there are certain situations that can inhibit audible and visible alarm indications even though an alarm condition was detected. For more information, see 9.6.5.1 *Arrhythmia Alarm Chains* and 9.6.5.2 *Arrhythmia Alarm Shielding Rules*.

9.6.5.1 Arrhythmia Alarm Chains

If multiple alarms overlap, announcing all of the detected alarm conditions would be confusing, and a more serious condition might be overlooked. So arrhythmia alarms are prioritized by alarm "chains".

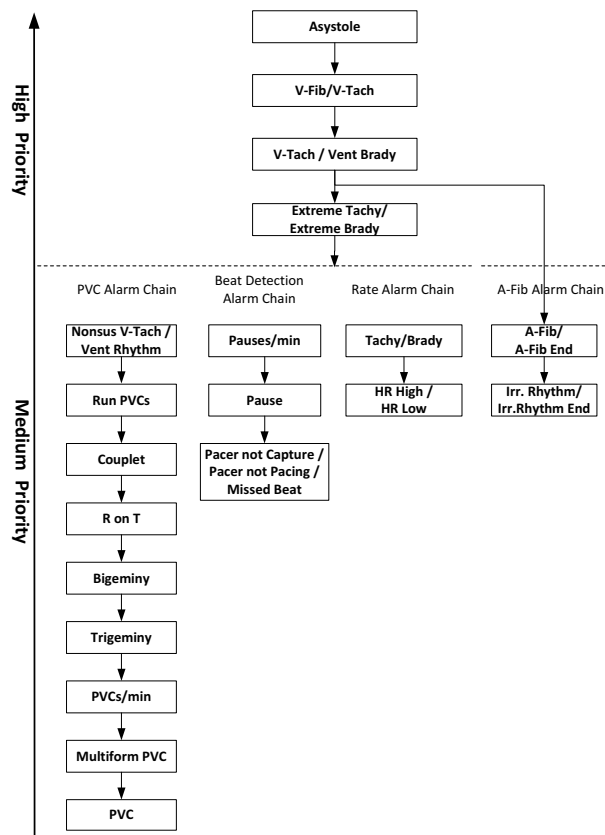

9.6.5.2 Arrhythmia Alarm Shielding Rules

The following table explains how audible and visual alarms are indicated during arrhythmia alarm shielding period.

Previous alarm	Current alarm	Alarm indication
Alarm in high priority chain	Alarm in high priority chain	Alarm light and alarm tone
	Alarm in medium priority chain	During the shielding period, alarm light and alarm tone are disabled. When the shielding period is reached, alarm light and alarm tone are reactivated.
Alarm in medium priority chain	Alarm in high priority chain	Alarm light and alarm tone
	Alarm in the same medium priority chain, but with higher priority	Alarm light and alarm tone
	The same alarm reoccurs	During the shielding period, alarm light and alarm tone are disabled. When the shielding period is reached, alarm light and alarm tone are reactivated.
	Alarm in the same medium priority chain, but with lower priority	During the shielding period, alarm light and alarm tone are disabled. When the shielding period is reached, alarm light and alarm tone are reactivated.
	Alarm in other medium priority chain	Alarm light and alarm tone

9.6.5.3 Arrhythmia Alarm Refractory Period

For the following eight alarms in medium priority chain, there is a 30-second refractory period. That is to say, if the same alarm is not presented within 30 seconds after the previous alarm disappears.

- Couplet
- R on T
- PVCs/min High
- Multiform PVCs
- PVC
- Missed Beat
- Pacer not Capture
- Pacer not Pacing

9.7 ST Segment Monitoring

ST segment analysis is intended for adult, pediatric and neonatal patients. To use this feature, the MPM must be labeled to support ST analysis, see 9.1 ECG Introduction.

9.7.1 ST Safety Information

WARNING

- **ST segment deviation values may be affected by such factors as certain drugs or metabolic and conduction disturbances.**
 - **ST deviation is often calculated at a fixed offset from the J point. Changes in heart rate may affect ST.**
 - **The significance of ST segment changes needs to be determined by a physician.**
 - **This monitor provides information regarding changes in ST deviation levels. The clinical significance of the ST level change information should be determined by a physician.**
-
-

9.7.2 Enabling ST Monitoring

The ST monitoring function is disabled by default. Before you start ST monitoring, enable the ST function. To do so, follow this procedure:

1. Select the ECG numeric area or waveform area to enter the **ECG** dialog.
2. Select the **ST** tab → select the **Setup** tab.
3. Switch on **ST Analysis**.

Reliable ST monitoring cannot be ensured under the following situations:

- You are unable to get a lead that is not noisy.
- Arrhythmias, such as atrial fibrillation or atrial flutter, which may cause an irregular baseline.
- The patient is continuously ventricularly paced.
- The patient has left bundle branch block.

In these cases, you may consider switching off ST monitoring.

9.7.3 Displaying ST Deviation Numerics

To display ST numerics, follow this procedure:

1. Access **Tile Layout** by either of the following ways:
 - ◆ Select the **Screen Setup** quick key → select the **Tile Layout** tab.
 - ◆ Select **Main Menu** quick key → from the **Display** column select **Tile Layout**.
2. Click the numeric area where you want to display the ST numerics, and then select **ECG** → **ST**.

The ST parameter display area is configured differently according to the ECG cable used:

- When you are using the 3-lead ECG leadwires, a separate ST numeric area does not appear on the display. The ST deviation value displays in the ECG numeric area.
- When you are using the 5-lead ECG leadwires, the ST numeric area displays 7 ST deviation values: ST-I, ST-II, ST-III, ST-aVR, ST-aVL, ST-aVF, ST-V.
- When you are using the 6-lead ECG leadwires, the ST numeric area displays 8 ST deviation values: ST-I, ST-II, ST-III, ST-aVR, ST-aVL, ST-aVF, ST-Va, ST-Vb.
- When you are using the 12-lead ECG leadwires, the ST numeric area displays 12 ST deviation values: ST-I, ST-II, ST-III, ST-aVR, ST-aVL, ST-aVF, ST-V1, ST-V2, ST-V3, ST-V4, ST-V5, ST-V6.

This example shows the ST numeric area when 5-lead ECG cable is used. The monitor screen may look slightly different:

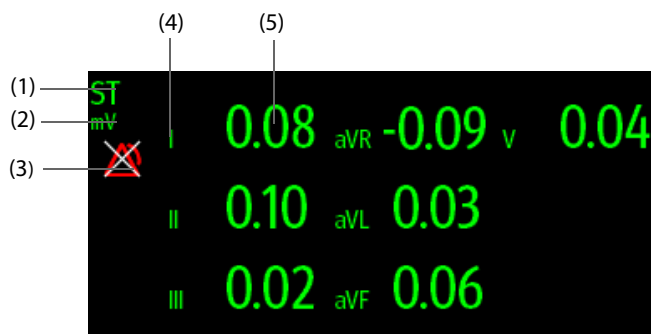

(1) Parameter label

(2) ST measurement unit

(3) ST alarm off symbol

(4) Lead labels

(5) ST numerics: a positive value indicates ST segment elevation, and a negative value indicates ST segment depression.

9.7.4 Displaying ST Segments in the Waveform Area

You can display ST segments in the waveform area. To do so, follow this procedure:

1. Access **Tile Layout** by either of the following ways:
 - ◆ Select the **Screen Setup** quick key → select the **Tile Layout** tab.
 - ◆ Select **Main Menu** quick key → from the **Display** column select **Tile Layout**.
2. Select the waveform area where you want to display the ST segments, and then select **ECG** → **ST**.

ST segment shows a QRS complex segment for each measured ST lead. The current ST segment is drawn in the same color as the ECG wave, usually green, superimposed over the stored reference segment, drawn in a different color. The information is updated once every ten seconds.

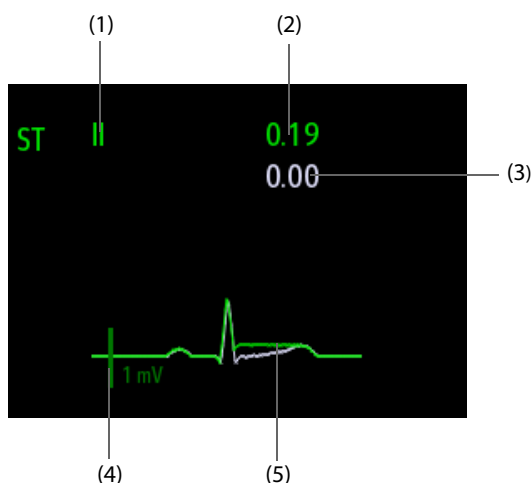

- (1) ST lead
- (2) Current ST deviation value
- (3) Baseline ST deviation value
- (4) 1 mV scale
- (5) Current ST segment (green) and baseline ST segment (white)

9.7.5 Entering the ST View

In ST View mode a complete QRS segment for each ST lead is displayed. The color of the current ST segments and ST deviation values is consistent with the color of the ECG waveforms, normally green. The color of the baseline ST segments and ST deviation values is white.

To enter the ST View, follow this procedure:

1. Select the ECG numeric area or waveform area to enter the **ECG** dialog.
2. Select the **ST** tab.
3. From the bottom of the dialog, select **ST View**.

9.7.6 Saving the Current ST Deviation and Segment as Baseline

ST deviation is typically monitored as a relative change from a baseline value. Set an ST baseline when ST deviation values become stable. If you did not set the ST baseline, the monitor automatically saves the baseline when valid ST deviation values appear for 5 minutes. To set the ST baseline, follow this procedure:

1. From the **ST View**, select **Set Baseline**.
2. From the pop-up dialog box, select **Ok** to set the current ST segments and values as the baseline.

From the **ST View**, you can also perform the following operations:

- Display or hide ST baseline by selecting **Display Baseline** or **Hide Baseline**.
- Display or hide the position of ISO point, J point and ST point by selecting **Display Marker** or **Hide Marker**.

CAUTION

- **Updating ST baseline affects ST alarms.**
-

9.7.7 Entering the ST Graphic

To display **ST Graphic**, follow this procedure:

1. Select the ECG numeric area or waveform area to enter the **ECG** dialog.
2. Select the **ST** tab.
3. Select **ST Graphic**.

The following figure shows the ST Graphic when **ST Alarm Mode** is set to **Absolute**. The height of the bar indicates the ST deviation value of corresponding ST lead. The color of the bar indicates ST alarm status: green indicates that corresponding ST deviation value is within alarm limits; cyan, yellow and red indicate that the ST deviation value exceeds the alarm limits. The color matches ST alarm priority.

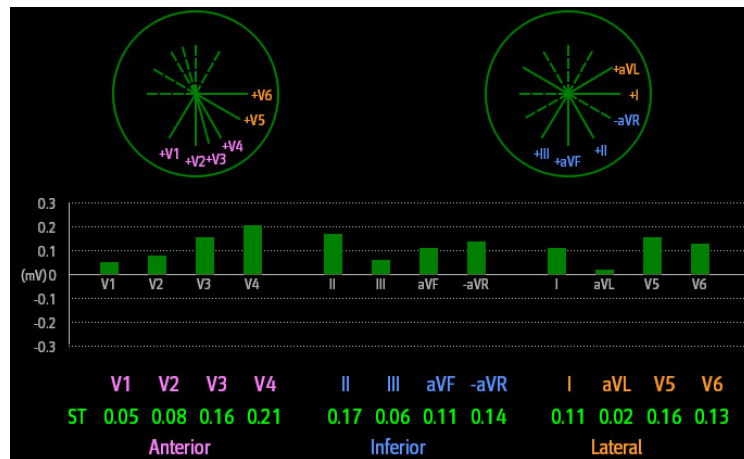

The following figure shows the ST Graphic when **ST Alarm Mode** is set to **Relative**. The height of grey bar indicates the baseline ST deviation value and the green bar (cyan, yellow or red if an alarm occurs) indicates relative ST from that baseline.

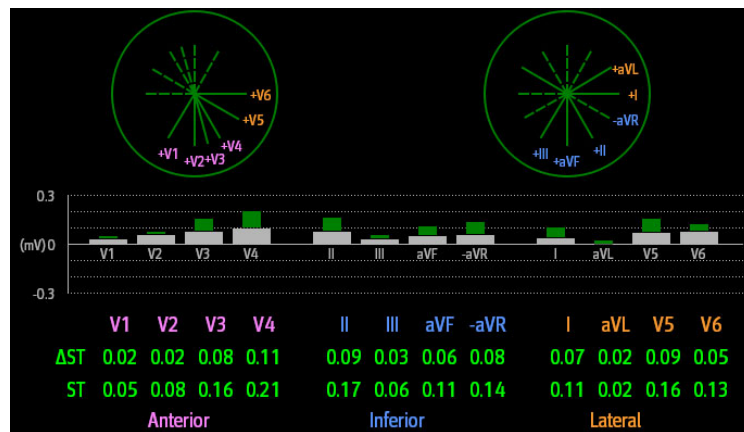

9.7.8 Changing ST Settings

9.7.8.1 Setting ST Alarm Properties

To set ST alarm properties, follow this procedure:

1. Select the ECG numeric area or waveform area to enter the **ECG** dialog.
2. Select the **ST** tab → **Alarm** tab.
3. Set **ST Alarm Mode** to **Absolute** or **Relative**.
 - ◆ **Absolute**: you can separately set the alarm properties for each ST alarm for each lead.
 - ◆ **Relative**: you can set the alarm properties for **ST Single** and **ST Dual** alarms.
4. Set ST alarm properties.

9.7.8.2 Changing Leads for ST Display

The monitor automatically selects the three most deviated leads for ST display. You can also manually select the leads. To do so, follow this procedure:

1. Select the ECG numeric area or waveform area to enter the **ECG** dialog.
2. Select the **ST** tab → select the **Setup** tab.
3. Set **ST Segment**. You can select up to 3 leads.

9.7.8.3 Showing ISO Point, J Point, and ST Point Markers

In the waveform area, the ISO point, J point, and ST point marker do not display on the ST segments by default. To display these markers, follow this procedure:

1. Select the ECG numeric area or waveform area to enter the **ECG** dialog.
2. Select the **ST** tab → select the **Setup** tab.
3. Switch on **Show Markers**.

9.7.9 Adjusting ST Measurement Points

9.7.9.1 About ST Point, ISO Point, and J Point

The ST deviation value for each beat is the potential difference between the isoelectric (ISO) point and the ST point. The ISO point provides the baseline. The ST point is located between the J point and the start of the T-wave. The J point is the end of the QRS complex. As the ST point is at a fixed distance away from the J point (40, 60, 80 etc msec), manually adjusting the J point helps you correctly position the ST point.

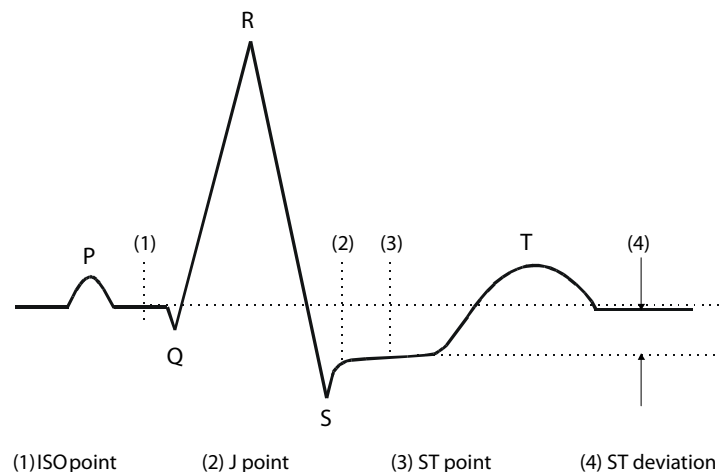

9.7.9.2 Setting ST Point, ISO Point, and J Point

CAUTION

- **If Auto Adjust is Off, or if the patient's heart rate or ECG morphology changes significantly, the ISO and ST points need to be occasionally adjusted because this may affect the QT interval and thus the location of the ST point. False ST segment depression or elevation may occur if the isoelectric point or the ST point is incorrectly set.**
 - **Always ensure that the locations of ST points are appropriate for the patient.**
-

To set the ST point, ISO point, and J point, follow this procedure:

1. Select the ECG numeric area or waveform area to enter the **ECG** dialog.
2. Select the **ST** tab → select the **Adjust** tab.
3. Set **ST Point**.

The setting for **Auto Adjust** defines the method of adjusting the ISO and J point locations. **Auto Adjust** is enabled by default. In this case, the locations of the ISO point and J point are automatically determined by the

algorithm. When **Auto Adjust** is disabled, you need to manually adjust the position of the ISO point and J point using the arrows at the right sides of **ISO** and **J**.

- The ISO point (isoelectric) location shown is relative to the R-wave peak. Position the ISO point in the middle of the flattest part of the waveform (between the P and Q waves).
- The J point location is indicated relative to the R-wave peak. Position the J point at the end of the QRS complex and the beginning of the ST segment.
- The ST point is positioned a fixed distance from the J point. Position the ST point relative to the J point at **J+60/80ms, J+40ms, J+60ms** or **J+80ms**. When **J+60/80ms** is selected, the ST point will be positioned 80 ms (heart rate 120 bpm or less) or 60 ms (heart rate more than 120 bpm) from the J point.

9.8 QT/QTc Interval Monitoring

The QT interval is the time between the beginning of the Q-wave and the end of the T-wave. It represents the total duration of the depolarization (QRS duration) and repolarization (ST-T) phases of the ventricles. QT interval monitoring can assist in the detection of long QT syndrome.

The QT interval has an inverse relationship to heart rate. Faster heart rates shorten QT interval and slower heart rates prolong QT interval. Therefore, several formulas are commonly used to correct the QT interval for heart rate. The heart rate corrected QT interval is abbreviated as QTc.

QT/QTc interval monitoring is intended for adult, pediatric, and neonatal patients.

9.8.1 QT/QTc Monitoring Limitations

Some conditions may make it difficult to achieve reliable QT/QTc monitoring, for example:

- R-wave amplitudes are too low
- The presence of frequent ventricular ectopic beats
- RR intervals are unstable
- P-waves tending to encroach on the end of the previous T-wave at high heart rates
- The T-wave is very flat or T-wave are not well defined
- The end of the T-wave is difficult to delineate because of the presence of U-waves
- QTc measurements are not stable
- In the presence of noise, asystole, ventricular fibrillation, atrial fibrillation, or ECG lead off

For reliable QT/QTc monitoring, choose lead with good T-wave amplitude and no visible flutter activity, and without a predominant U-wave or P-wave.

Some conditions such as left or right bundle branch block or ventricular hypertrophy can lead to a widened QRS complex. If a long QTc is observed you should verify it to ensure that it is not caused by QRS widening.

Because normal beats followed by ventricular beats are not included in the analysis, no QT measurement will be generated in the presence of a bigeminy rhythm.

If the heart rate is extremely high (over 150 bpm for adults and over 180 bpm for pediatrics and neonates), QT will not be measured. When the heart rate changes, it can take several minutes for the QT interval to stabilize. For reliable QTc calculation it is important to avoid measurements when the heart rate is changing.

9.8.2 Enabling QT/QTc Monitoring

The QT monitoring function is disabled by default. Before you start QT monitoring, enable the QT function. To do so, follow this procedure:

1. Select the ECG numeric area or waveform area to enter the **ECG** dialog.
2. Select the **QT** tab→ select the **Setup** tab.
3. Switch on **QT Analysis**.

9.8.3 Displaying QT Numerics and Segments

To display QT numerics and Segments, follow this procedure:

1. Access **Tile Layout** by either of the following ways:
 - ◆ Select the **Screen Setup** quick key → select the **Tile Layout** tab.
 - ◆ Select **Main Menu** quick key → from the **Display** column select **Tile Layout**.
2. Click the parameter numeric area where you want to display the QT numerics, and then select **ECG** → **QT/QTc**.

NOTE

- **QTc values are calculated based on the QT-HR, not the ECG HR. To view the QT-HR, open the QT View. For more information, see 9.8.4 Entering the QT View.**

The following picture shows the QT numeric area. The monitor screen may look slightly different:

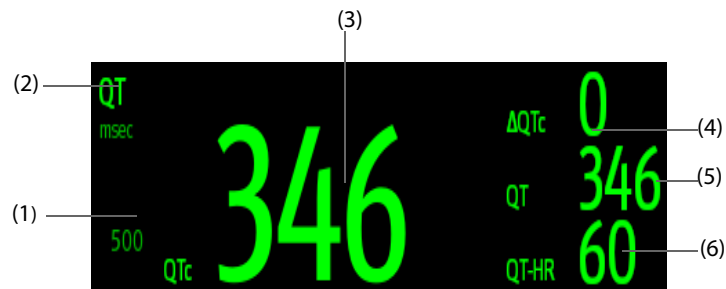

9.8.4 Entering the QT View

QT View shows the current and baseline QT parameter values and waveforms. To enter QT View, follow this procedure:

1. Select the ECG numeric area or waveform area to enter the **ECG** dialog.
2. Select the **QT** tab.
3. Select **QT View**.

The following picture shows a typical QT view.

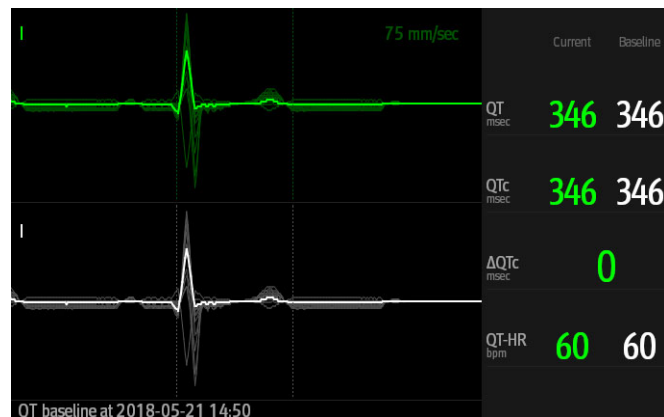

- The current waveform is shown in the upper half in green.
- The baseline waveform is shown below in white.

- The waveform of selected lead is highlighted, while the waveforms of other leads are in light green or light gray.
- The start of the QRS complex and the end of the T wave are marked with a vertical line.
- In some conditions, no QT measurement can be made. Then the cause of failed QT measurement is shown at the bottom of the QT numerics area and the message "Cannot Analyze QT" is shown in the technical alarm area.

Select the left or right arrow to switch leads, and the corresponding waveform will be highlighted.

9.8.5 Saving the Current QTc as Baseline

In order to quantify changes in the QTc value, you can set a QTc baseline. If no baseline has been set for this patient within the first five minutes after getting valid QT values, the monitor will automatically set a baseline. To set the current values as baseline, follow this procedure:

1. From the **QT View**, select **Set Baseline**.
2. From the pop-up dialog box, select **Ok**. This baseline will then be used to calculate Δ QTc.

If you set a new baseline the previous baseline is discarded.

From the **QT View**, you can also perform the following operations:

- Select the left or right arrow to select a lead label to highlight corresponding waveform.
- Select **Display Baseline** or **Hide Baseline** to display or hide the baseline waveform.

CAUTION

- **Updating QTc baseline affects the Δ QTc value and alarm.**
-

9.8.6 Changing QT Settings

9.8.6.1 Setting QT Alarm Properties

To set QT alarm properties, follow this procedure:

1. Select the ECG numeric area or waveform area to enter the **ECG** dialog.
2. Select the **QT** tab→ select the **Alarm** tab.
3. Set QTc and Δ QTc alarm properties.

9.8.6.2 Selecting Leads for QT Calculation

You can select one lead or all leads for QT calculation. To do so, follow this procedure:

1. Select the ECG numeric area or waveform area to enter the **ECG** dialog.
2. Select the **QT** tab→ select the **Setup** tab.
3. Set **QT Leads**. **All** is selected by default. This means all leads are used for QT calculation.

9.9 ECG Relearning

Changes in ECG beat morphology could result in incorrect arrhythmia alarms and/or inaccurate heart rate. ECG relearning allows the monitor to learn the new dominant beat morphology and thus reduce false arrhythmia alarms and inaccurate HR values. Once learning is complete, the dominant QRS complex is stored as a reference template. The reference template is used as the normal morphology of that patient and it is compared with incoming beats to identify possible arrhythmias.

9.9.1 Auto ECG Relearning

Auto arrhythmia relearning happens in the following situation:

- The ECG lead type or lead label is changed.

- ECG leads are off and are not reconnected within 60 seconds.
- The patient's paced status is changed.

9.9.2 Initiating an ECG Relearning Manually

If you suspect that false arrhythmia alarms are presented, you may need to manually initiate an ECG relearn. To do so, follow this procedure:

1. Select the ECG numeric area or waveform area to enter the **ECG** dialog.
2. Select **Relearn**.

CAUTION

- **Initiate ECG relearning only during periods of predominantly normal rhythm and when the ECG signal is relatively noise-free. If ECG learning takes place during arrhythmias, the ectopic beats may be incorrectly learned as normal QRS complexes. This may result in missed detection of subsequent arrhythmia events.**
-

9.10 Defibrillation Synchronization Pulse Output

The 12-lead MPM module provides an analog out connector to output synchronization pulses for defibrillators. If a defibrillator is connected, it receives a synchronization pulse (100 ms, +5 V) through the analog out connector each time an R-wave is detected. The 3/5/6 lead MPM module does not offer this output.

WARNING

- **According to IEC 60601-2-4: 2010, the peak of the synchronized defibrillator discharge should be delivered within 60 ms of the peak of the R wave. The signal at the ECG output (sync pulse) on the monitor is delayed by maximum of 30 ms. the biomedical engineer should verify that the ECG/ Defibrillator combination does not exceed recommended maximum delay of 60 ms.**
 - **Before defibrillation, ensure that both defibrillator and monitor have passed the system test and can be safely used together.**
-

9.11 ECG Troubleshooting

This section lists some of the problems that might be encountered during ECG monitoring. If you encounter problems when using the monitor or accessories, check the table below before requesting for services. If the problem persists after you have taken corrective actions, contact the service personnel.

NOTE

- **For the physiological and technical alarm messages, see *D Alarm Messages*.**

Problem	Corrective Actions
Noisy ECG traces	<ol style="list-style-type: none"> 1. Check that the electrodes are not detached or dry. Replace with fresh and moist electrodes if necessary. 2. Check that leadwires are not defective. Replace leadwires if necessary. 3. Check that the patient cable or leadwires are not routed too close to other electrical devices. Move the patient cable or leadwires away from electrical devices and their cables if necessary.
Excessive electrosurgical Interference	Use ESU-proof ECG cables. For more information, see <i>25.1 ECG Accessories</i> .
Muscle Noise	<p>Inadequate skin preparation, tremors, tense subject, and/or poor electrode placement.</p> <ol style="list-style-type: none"> 1. Perform skin preparation again and re-place the electrodes. For more information, see <i>9.4.1 Preparing the Patient Skin</i> and <i>9.4.2 Applying Electrodes and Connecting the Patient</i>. 2. Apply fresh, moist electrodes. Avoid muscular areas.

Problem	Corrective Actions
Intermittent Signal	<ol style="list-style-type: none"> 1. Check that cables are properly connected. 2. Check that electrodes are not detached or dry. Perform skin preparation again as described in <i>9.4.1 Preparing the Patient Skin</i> and apply fresh and moist electrodes. 3. Check that the patient cable or leadwires are not damaged. Change them if necessary.
Excessive alarms: heart rate, lead fault	<ol style="list-style-type: none"> 1. Check that electrodes are not dry. Perform skin preparation again and re-place the electrodes. For more information, see <i>9.4.1 Preparing the Patient Skin</i> and <i>9.4.2 Applying Electrodes and Connecting the Patient</i>. 2. Check for excessive patient movement or muscle tremor. Reposition the electrodes. Replace with fresh and moist electrodes if necessary.
Low Amplitude ECG Signal	<ol style="list-style-type: none"> 1. Check that the ECG gain is not set too low. Adjust the gain as required. For more information, see <i>9.5.3.2 Changing ECG Waveform Size</i>. 2. Perform skin preparation again and re-place the electrodes. For more information, see <i>9.4.1 Preparing the Patient Skin</i> and <i>9.4.2 Applying Electrodes and Connecting the Patient</i>. 3. Check electrode application sites. Avoid bone or muscular area. 4. Check that electrodes are not dry or used for a prolonged time. Replace with fresh and moist electrodes if necessary.
No ECG Waveform	<ol style="list-style-type: none"> 1. Check that the ECG gain is not set too low. Adjust the gain as required. For more information, see <i>9.5.3 Changing ECG Wave Settings</i>. 2. Check that the leadwires and patient cables are properly connected. 3. Change cable and lead wires if necessary. 4. Check that the patient cable or leadwires are not damaged. Change them if necessary.
Base Line Wander	<ol style="list-style-type: none"> 1. Check for excessive patient movement or muscle tremor. Secure leadwires and cable. 2. Check that electrodes are not detached or dry and replace with fresh and moist electrodes if necessary. For more information, see <i>9.4.1 Preparing the Patient Skin</i> and <i>9.4.2 Applying Electrodes and Connecting the Patient</i>. 3. Check for ECG filter setting. Set ECG Filter mode to Monitor to reduce baseline wander on the display.

10 Resting 12-Lead ECG Analysis

10.1 Resting 12-Lead ECG Analysis Introduction

The monitor can be configured with the Glasgow 12-lead resting ECG analysis algorithm. The MPM module or N1 incorporating the Glasgow algorithm is labelled with the logo of Glasgow as shown in *9.1 ECG Introduction*.

The Glasgow algorithm is intended for adult, pediatric, and neonatal patients.

10.2 Entering the 12-Lead Screen

To enter the 12-Lead screen, follow this procedure:

1. Select the ECG numeric area or waveform area to enter the **ECG** dialog.
2. From the bottom of the **ECG** dialog, select **12-Lead**.

You can also enter the 12-Lead screen by following this procedure:

- Select the **Screen Setup** quick key → select the **Choose Screen** tab → select **ECG 12-Lead**.
- Select **Main Menu** quick key → from the **Display** column select **Choose Screen** → select **ECG 12-Lead**.

NOTE

- **The ECG 12-Lead screen is available only when the Glasgow algorithm is configured (associated module has the Glasgow label) and Lead Set is set to Auto or 12-Lead.**
-

10.3 Initiating Resting 12-Lead ECG Analysis

Before initiating 12-lead ECG analysis, check that all electrodes are correctly connected to the lead wires and the ECG trunk cable is properly connected. Check that patient information is correct. Keep the patient still.

To initiate 12-Lead ECG analysis, select **Analyze** from the bottom left of the 12-Lead screen.

10.4 Changing 12-Lead ECG Analysis Settings

On the ECG 12-Lead screen, you can set the high frequency filter, baseline drift removal (BDR) filter, and the waveform layout.

10.4.1 Setting the High Frequency Filter

The high frequency filter attenuates muscle artifact by restricting the included frequencies. The setting of the high frequency filter is 35 Hz by default. To change the setting, follow this procedure:

1. On the ECG 12-Lead screen, select the ECG numeric area or waveform area to enter the **ECG** dialog.
2. Select the **Setup** tab.
3. Set **High-Freq Cut-off**.

The high frequency filter is a low-pass filter. That is to say, signal frequencies higher than the set frequency are filtered out. For example, if you set **High-freq Cutoff** to **35 Hz**, then signal below 35 Hz is kept in the signal and signal exceeding 35 Hz is attenuated.

10.4.2 Setting the Baseline Drift Removal Filter

The baseline drift removal (BDR) filter suppresses most baseline drift interference and also is able to preserve the fidelity of the ST-segment level. BDR is switched on by default. To set the BDR, follow this procedure:

1. On the ECG 12-Lead screen, select the ECG numeric area or waveform area to enter the **ECG** dialog.

2. Select the **Setup** tab.
3. Switch on or off **Baseline Drift Removal** as desired. If BDR is switched off, the 0.05 Hz high pass filter is used.

NOTE

- **BDR introduces around 1-second delay. Using BDR is recommended except when the delay is unacceptable.**
-

10.4.3 Setting the 12-Lead Waveform Layout

To set the 12-lead waveform layout, follow this procedure:

1. On the ECG 12-Lead screen, select the ECG numeric area or waveform area to enter the **ECG** dialog.
2. Select the **Setup** tab.
3. Set **Waveform Layout**.

- ◆ **Standard:** the waveform sequence is I, II, III, aVR, aVL, aVF, V1, V2, V3, V4, V5, V6.

- ◆ **Cabrera:** the waveform sequence is aVL, I, -aVR, II, aVF, III, V1, V2, V3, V4, V5, V6.

For the Glasgow algorithm, the sequence of the chest leads depends on the setting of **V3 Placement**. If **V3 placement** is set to **V4R**, the sequence of chest leads is V4R, V1, V2, V4, V5, V6.

10.4.4 Editing Patient Information

Some patient information may directly affect ECG analysis. Complete and correct patient information is helpful for accurate diagnosis and treatment of the patient. Enter patient information before starting a resting ECG analysis.

To enter patient information, follow this procedure:

1. On the ECG 12-Lead screen, select **Setup** to enter the **12-Lead Setup** dialog.
2. On the **Patient Demographics** page, input or edit patient information.

NOTE

- **Saving information will also save the information as though it was entered in the Patient Management dialog.**
 - **Changes are not saved until you press Save. So changing to another tab without saving and then pressing the exit button "X" will lose any changes.**
 - **Check that patient information is correct before starting a resting 12-lead analysis.**
 - **Using pediatric lead placement V4R, V1, V2, V4 - V6 is recommended if the patient is under 16 years of age. Please record V4R using the V3 electrode. Also set V3 Electrode to V4R. This is a normal practice for a patient of this age.**
-

10.4.5 Setting Tachycardia and Bradycardia Thresholds

To set tachycardia and bradycardia thresholds, follow this procedure:

1. On the ECG 12-Lead screen, select **Setup** to enter the **12-Lead Setup** dialog.
2. Select the **Setup** tab.
3. Set **Tachy** and **Brady**.

NOTE

- **The tachycardia threshold only applies to patients whose age exceeds 180 days.**
 - **The bradycardia threshold only applies to patients whose age exceeds 2191 days (6 years).**
-

10.4.6 Setting the 12-Lead Interpretation Report

To set the 12-lead interpretation report, follow this procedure:

1. On the ECG 12-Lead screen, select **Setup** to enter the **12-Lead Setup** dialog.
2. Select the **Report** tab.
3. Set the format and items included in the 12-lead interpretation report.

10.5 Saving the 12-Lead Interpretation Report

At the completion of 12-lead ECG interpretation, select **Save** to save the report. You can review the saved 12-lead interpretation reports. For more information, see *26.2.11 12-Lead ECG Review Page*.

10.6 Printing the 12-Lead Interpretation Report

At the completion of 12-lead ECG interpretation, select **Print** or **Record** to output the report via the printer or recorder.

10.7 Exiting the ECG 12-Lead Screen

To exit the ECG 12-Lead screen, select **Exit** on the ECG 12-Lead screen.

This page intentionally left blank.

11 Monitoring Impedance Respiration (Resp)

11.1 Resp Introduction

Impedance respiration is measured across the thorax. When the patient is breathing or ventilated, the volume of air changes in the lungs, resulting in impedance changes between the electrodes. Impedance respiration rate (RR) is calculated from the signal representing these impedance changes, and a respiration waveform is displayed on the patient monitor screen.

Impedance respiration monitoring is intended for adult, pediatric and neonatal patients.

Respiration may also be measured using a CO₂ module or anesthetic gas (AG) module. Refer to *19 Monitoring Carbon Dioxide (CO₂)* and *20 Monitoring Anesthetic Gas (AG)* for respiration information specific to those modules.

11.2 Impedance Resp Safety Information

WARNING

- **When monitoring the patient's impedance respiration, do not use ESU-proof ECG cables. The monitor cannot measure impedance respiration with ESU-proof ECG cables.**
 - **If you do not set the detection level for the respiration correctly in manual detection mode, it may not be possible for the monitor to detect apnea. If you set the detection level too low, the monitor is more likely to detect cardiac activity, and to falsely interpret cardiac activity as respiratory activity in case of apnea.**
 - **The respiration measurement does not recognize the cause of apnea. It only indicates an alarm if a pre-adjusted time has elapsed without a breath being detected since the last detected breath. Therefore, it cannot be used for diagnostic purpose.**
 - **If operating under conditions according to the EMC Standard IEC 60601-1-2 (Radiated Immunity 3V/m), field strengths above 3V/m may cause erroneous measurements at various frequencies. Therefore, it is recommended to avoid the use of electrically radiating equipment in close proximity to the impedance respiration measurement unit.**
 - **The current used to measure impedance respiration may cause rate changes in Minute Ventilation Rate Responsive Pacemakers. If you suspect the patient monitor is affecting the pacemaker rate then replace the ECG cable with an ECG cable that contains ESU filters.**
-

CAUTION

- **Only use parts and accessories specified in this manual.**
 - **Impedance respiration monitoring is not for use on patients while they are active, as this can cause false alarms.**
-

11.3 Resp Display

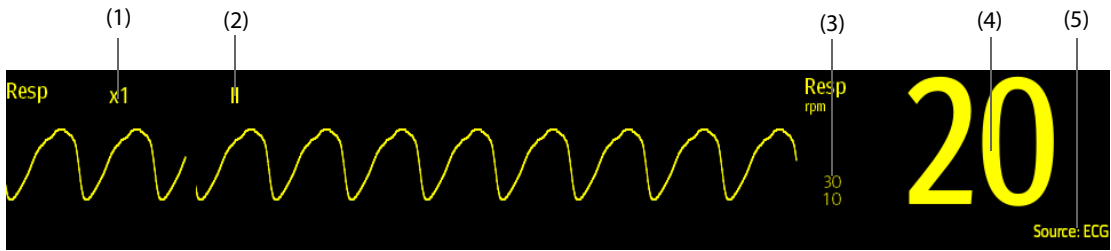

- (1) Resp waveform gain (2) Resp lead label (3) Alarm limits
(4) Respiration rate (RR) (5) RR source

NOTE

- If ESU-proof ECG cables are used, the Resp waveform area will display the message “Check Leads”. Replace the ECG cable if necessary.

11.4 Preparing for Impedance Resp Monitoring

11.4.1 Preparing the Patient

Follow this procedure to prepare the patient:

1. Shave hair from skin at chosen sites.
2. Gently rub skin surface at sites to remove dead skin cells.
3. Thoroughly cleanse the site with a mild soap and water solution.
4. Dry the skin completely before applying the electrodes.

CAUTION

- Proper skin preparation is necessary for good signal quality at the electrode site, as the skin is a poor conductor of electricity.

11.4.2 Placing the Electrodes

Impedance respiration is acquired using standard ECG electrodes and cables. Either lead I (RA-LA) or lead II (RA-LL) can be used.

For more information, see 9.4.4 ECG Electrode Placements.

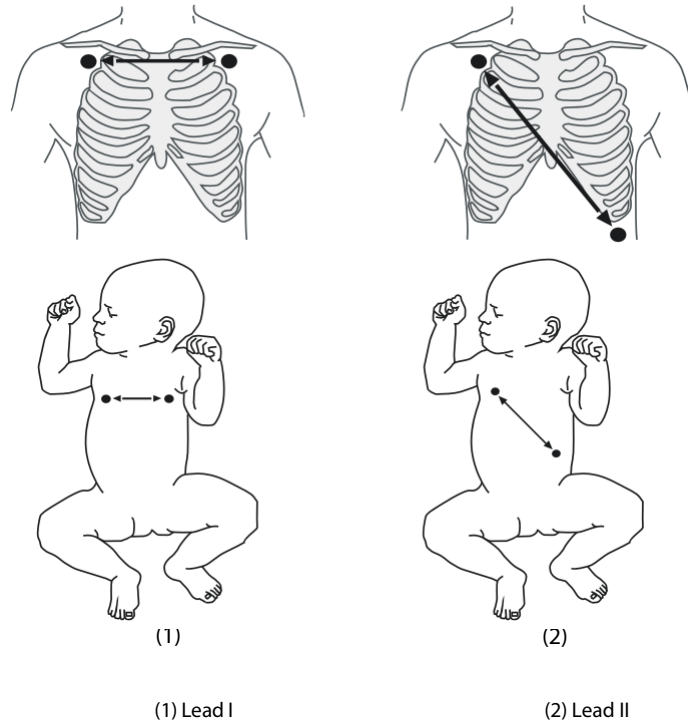

CAUTION

- **Correct electrode placement can help to reduce interference from cardiac related impedance changes: avoid including the liver area and the ventricles of the heart between the respiratory electrodes. This is particularly important for neonates.**
- **Some patients with restricted movements breathe mainly abdominally. In these cases, you may need to place the left leg electrode on the left abdomen at the point of maximum abdominal expansion to optimize the respiratory waveform.**
- **Some patients (especially neonates) expand their chests laterally, causing a negative intrathoracic pressure. In these cases, it is better to place the two respiration electrodes in the right midaxillary and the left lateral chest areas at the patient's maximum point of the breathing movement to optimize the impedance respiration waveform.**
- **To optimize the impedance respiration waveform, place the RA and LA electrodes horizontally when monitoring respiration with ECG Lead I; place the RA and LL electrodes diagonally when monitoring respiration with ECG Lead II.**
- **Periodically inspect electrode application sites to ensure skin integrity. If the skin quality changes, replace the electrodes or change the application site.**

NOTE

- **Store the electrodes at room temperature. Open the electrode package immediately prior to use.**
 - **Check that the electrode packages are intact and that the electrodes are not past the expiration date. Ensure the electrode gel is moist.**
-

11.5 Changing Resp Settings

11.5.1 Setting the Resp Alarm Properties

To set the Resp alarm properties, follow this procedure:

1. Select the Resp numeric area or waveform area to enter the **Resp** dialog.
2. Select the **Alarm** tab.
3. Enter the password if required. For more information, refer to *33.14.3 Selecting Password for User Authentication*.
4. Set alarm properties as desired.

11.5.2 Setting the RR Source

To set RR source, follow this procedure:

1. Select the Resp numeric area or waveform area to enter the **Resp** dialog.
2. Select the **Setup** tab.
3. Choose **RR Source** from the dropdown list.

When you select **Auto**, the monitor automatically selects the RR source following order of priority: first **CO₂**, and then **ECG**. When the manually selected RR source is not available, the monitor automatically switches the **RR Source** to **Auto**.

11.5.3 Choosing the Respiration Lead

To set the respiration lead, follow this procedure:

1. Select the Resp numeric area or waveform area to enter the **Resp** dialog.
2. Select the **Setup** tab.
3. Set **Resp Lead**.

If you cannot get an acceptable impedance Resp waveform or you suspect the veracity of the Resp value after choosing the Resp lead, you may need to adjust the electrode placement.

11.5.4 Setting the Resp Waveform Size

To set the Resp waveform size, follow this procedure:

1. Select the Resp numeric area or waveform area to enter the **Resp** dialog.
2. Select the **Setup** tab.
3. Set **Gain**.

11.5.5 Setting the Resp Waveform Speed

To set the Resp waveform speed, follow this procedure:

1. Select the Resp numeric area or waveform area to enter the **Resp** dialog.
2. Select the **Setup** tab.
3. Set **Speed**.

11.5.6 Setting the Auto Detection Switch

To set the auto detection switch, follow this procedure:

1. Select the Resp numeric area or waveform area to enter the **Resp** dialog.
2. Select the **Setup** tab.
3. Switch on or off **Auto Threshold Detection**.
 - ◆ If **Auto Threshold Detection** is switched on, the monitor automatically adjusts the Resp waveform detection level, or threshold.
 - ◆ If **Auto Threshold Detection** is switched off, you have to manually adjust the Resp waveform threshold. For more information, see *11.5.7 Adjusting the Resp Waveform Detection Threshold*.

In the auto threshold detection mode, if you are monitoring Resp and the ECG parameter is switched off, the monitor cannot compare the heart rate and Resp rates to detect cardiovascular artifact. The respiration detection level is automatically set higher to prevent the detection of cardiovascular artifact as respiration.

In the manual detection mode (where auto threshold detection is off), cardiovascular artifact can, in certain situations, trigger the respiration rate counter. This may lead to a false indication of a high respiration or an undetected apnea condition. If you suspect that cardiovascular artifact is being registered as respiratory activity, raise the detection level above the zone of cardiovascular artifact. If the Resp wave is so small that raising the detection level is not possible, you may need to optimize the electrode placement.

11.5.7 Adjusting the Resp Waveform Detection Threshold

Use the manual detection mode (where auto threshold detection is off) in the following situations:

- The respiration rate and the heart rate are close.
- Patients have intermittent mandatory ventilation.
- Respiration is weak. Try repositioning the electrodes to improve the signal.

To set the Resp waveform threshold to the desired level, follow this procedure:

1. Select the Resp numeric area or waveform area to enter the **Resp** dialog.
2. Select the **Threshold** tab.
3. Select the up and down arrows below **Upper Line** and **Lower Line** to define the Resp waveform threshold.

Once set, the detection level will not adapt automatically to different respiration depths. It is important to remember that if the depth of breathing changes, you may need to change the detection level.

This page intentionally left blank.

12 Monitoring Pulse Oxygen Saturation (SpO₂)

12.1 SpO₂ Introduction

Pulse Oxygen Saturation (SpO₂) monitoring is a non-invasive technique used to measure the amount of oxygenated hemoglobin and pulse rate by measuring the absorption of selected wavelengths of light. The light generated in the emitter side of the probe is partly absorbed when it passes through the monitored tissue. The amount of transmitted light is detected in the detector side of the probe. When the pulsative part of the light signal is examined, the amount of light absorbed by the hemoglobin is measured and the pulse oxygen saturation can be calculated. This device is calibrated to display functional oxygen saturation.

SpO₂ monitoring is intended for adult, pediatric and neonatal patients.

You can simultaneously measure SpO₂ from two different measurement sources: the MPM module and the SpO₂ module. The measurement from the MPM module is labelled as SpO₂ and the measurement from the SpO₂ module is labelled as SpO₂b.

The monitor can be configured with Masimo SpO₂ or Nellcor SpO₂:

- Masimo SpO₂: the connector is purple and the logo of Masimo SET is on the module's front panel.
- Nellcor SpO₂: the connector is grey and the logo of Nellcor is on the module's front panel.

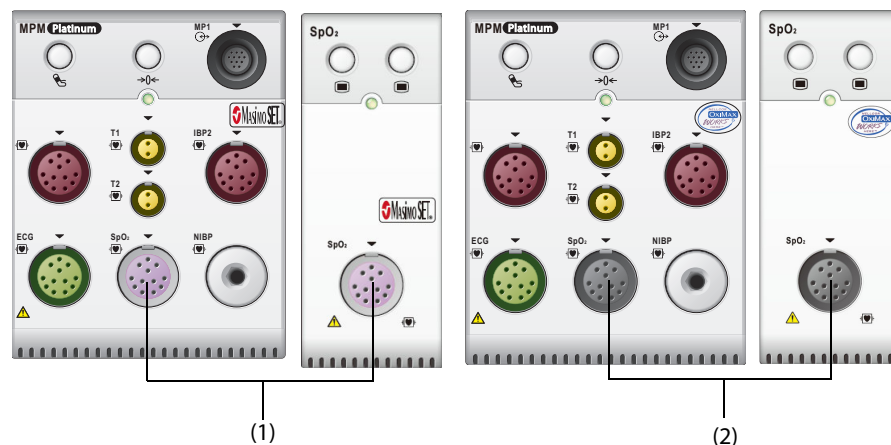

(1) Connector of Masimo SpO₂

(2) Connector of Nellcor SpO₂

NOTE

- If you need to measure SpO₂ by both the MPM module and the SpO₂ module, select the same type of SpO₂. Otherwise, the SpO₂ module will be disabled. For example, if an MPM module configured with the Nellcor SpO₂ and an SpO₂ module configured with the Masimo SpO₂ are simultaneously applied, the SpO₂ module will be automatically disabled.
- The SpO₂ extension cable used must be compatible with the SpO₂ sensor connectors used. For example, only the Masimo SpO₂ extension cable can be connected to the Masimo SpO₂ sensor connectors.
- Measurement accuracy verification: The SpO₂ accuracy has been verified in human experiments by comparing with arterial blood sample reference measured with a CO-oximeter. Pulse oximeter measurement are statistically distributed and about two-thirds of the measurements are expected to come within the specified accuracy range compared to CO-oximeter measurements.
- A functional tester or SpO₂ simulator can be used to determine the pulse rate accuracy.
- A functional tester or SpO₂ simulator cannot be used to assess the SpO₂ accuracy.

12.2 SpO₂ Safety Information

WARNING

- When a trend toward patient deoxygenation is indicated, analyze the blood samples with a laboratory co-oximeter to completely understand the patient's condition.
 - Do not use SpO₂ sensors during magnetic resonance imaging (MRI). Induced current could potentially cause burns. The sensor may affect the MRI image, and the MRI unit may affect the accuracy of the oximetry measurements.
 - Prolonged continuous monitoring may increase the risk of undesirable changes in skin characteristics, such as irritation, reddening, blistering or burns. Inspect the sensor site every two hours and move the sensor if the skin quality changes. Change the application site every four hours. For neonates, or patients with poor peripheral blood circulation or sensitive skin, inspect the sensor site more frequently.
 - If the sensor is too tight because the application site is too large or becomes too large due to edema, excessive pressure for prolonged periods may result in venous congestion distal from the application site, leading to interstitial edema and tissue ischemia.
 - When patients are undergoing photodynamic therapy they may be sensitive to light sources. Pulse oximetry may be used only under careful clinical supervision for short time periods to minimize interference with photodynamic therapy.
 - Setting alarm limits to extreme values may cause the alarm system to become ineffective. For example, high oxygen levels may predispose a premature infant to retrolental fibroplasia. If this is a consideration, do not set the high alarm limit to 100%, which is equivalent to switching off the alarm.
 - SpO₂ is empirically calibrated in healthy adult volunteers with normal levels of carboxyhemoglobin (COHb) and methemoglobin (MetHb).
 - To protect from electric shock, always remove the sensor before bathing the patient.
 - The pulse oximetry function of the bedside monitor should not be used for apnea monitoring.
 - The pulse oximetry function of the bedside monitor should not be used for arrhythmia analysis.
-

CAUTION

- Change the application site or replace the sensor and/or patient cable when a persistent SpO₂ Low Signal Quality message is displayed on the equipment. These messages may indicate that patient monitoring time is exhausted on the patient cable or sensor.
 - Replace the cable or sensor when a "SpO₂ Sensor Off", "SpO₂ No Sensor", or "SpO₂ Low Signal Quality" message is consistently displayed while monitoring consecutive patients after completing troubleshooting steps listed in this manual.
 - Variation in measurements may be profound and may be affected by sampling technique as well as the patient's physiological conditions. Any results exhibiting inconsistency with the patient's clinical status should be repeated and/or supplemented with additional test data. Blood samples should be analyzed by laboratory instruments prior to clinical decision making to completely understand the patient's condition.
 - Use only SpO₂ sensors specified in this manual. Follow the SpO₂ sensor's instructions for use and adhere to all warnings and cautions.
 - Do not place the patient monitor where the controls can be changed by the patient.
 - If using pulse oximetry during full body irradiation, keep the sensor out of the radiation field. If the sensor is exposed to the radiation, the reading might be inaccurate or the device might read zero for the duration of the active irradiation period.
-

NOTE

- Additional information specific to the Masimo sensors compatible with the equipment, including information about parameter/measurement performance during motion and low perfusion, may be found in the sensor's directions for use (DFU).

- **Masimo cables and sensors are provided with X-Cal™ technology to minimize the risk of inaccurate readings and unanticipated loss of patient monitoring. Refer to the Cable or Sensor DFU for the specified duration of the patient monitoring time.**
-

12.3 SpO₂ Measurement Limitations

The following factors may influence the accuracy of SpO₂ measurement:

- Patient physiological characteristics:
 - ◆ Cardiac arrest
 - ◆ Hypotension
 - ◆ Darkly pigmented skin
 - ◆ Shock
 - ◆ Severe vasoconstriction
 - ◆ Hypothermia
 - ◆ Severe anemia
 - ◆ Ventricular septal defects (VSDs)
 - ◆ Venous pulsations
 - ◆ Poor perfusion
 - ◆ Dysfunctional hemoglobin, such as carboxyhemoglobin (COHb) and methemoglobin (MetHb)
 - ◆ Elevated levels of bilirubin
 - ◆ Vasospastic disease, such as Raynaud's, and peripheral vascular disease
 - ◆ Hemoglobinopathies and synthesis disorders such as thalassemias, Hb s, Hb c, sickle cell, etc.
 - ◆ Hypocapnic or hypercapnic conditions
 - ◆ Birthmark(s), tattoos, skin discolorations, moisture on skin, deformed or abnormal fingers. etc.
- Interfering substances:
 - ◆ Intravascular dyes (such as indocyanine green, methylene blue, indigo carmine, etc.)
 - ◆ Dyes in the measure site, such as nail polish
- Environmental conditions:
 - ◆ Excessive ambient light
 - ◆ Electrosurgery equipment
 - ◆ Defibrillation (may cause inaccurate reading for a short amount of time)
 - ◆ Excessive patient/sensor motion
 - ◆ Electromagnetic field
 - ◆ Arterial catheters and intra-aortic balloon
- Others
 - ◆ Inappropriate positioning of the SpO₂ sensor, or use of incorrect SpO₂ sensor
 - ◆ Cuff or arterial blood pressure measurement device on the same limb as the SpO₂ sensor

12.4 SpO₂ Display

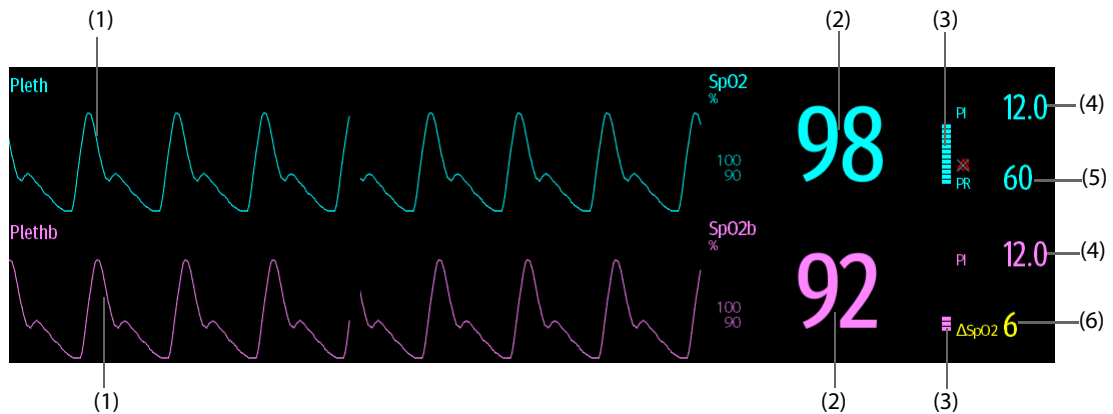

- (1) Pleth waveform (Pleth/Plethb): visual indication of patient's pulse. The waveform is not normalized.
- (2) Oxygen saturation of arterial blood (SpO₂/SpO_{2b}): percentage of oxygenated hemoglobin in relation to the sum of oxyhemoglobin and deoxyhemoglobin.
- (3) Perfusion indicator: the pulsatile portion of the measured signal caused by arterial pulsation.
- (4) Perfusion index (PI): gives the numerical value for the pulsatile portion of the measured signal caused by arterial pulsation. PI is an indicator of the pulsatile strength. You can also use it to assess the SpO₂ signal strength.
- (5) Pulse rate (derived from the pleth wave): detected pulsations per minute.
- (6) SpO₂ difference (ΔSpO₂): $\Delta SpO_2 = |SpO_2 - SpO_2b|$

NOTE

- PI is displayed for Masimo SpO₂.

12.5 Preparing for SpO₂ Monitoring

To prepare to monitor SpO₂, follow this procedure:

1. Select an appropriate sensor according to the module type, patient category and weight.
2. Clean the contact surface of the reusable sensor.
3. Remove colored nail polish from the application site.
4. Apply the sensor to the patient according to the instruction for use of the sensor.
5. Select an appropriate extension cable according to the connector type and plug the cable into the SpO₂ connector.
6. Connect the sensor to the extension cable.

CAUTION

- **Do not apply sensor too tightly as this results in venous pulsation which may severely obstruct circulation and lead to inaccurate measurements.**
- **At elevated ambient temperatures, be careful with measurement sites that are not well perfused, because this can cause burns after prolonged application.**
- **Avoid placing the sensor on extremities with an arterial catheter, an NIBP cuff or an intravascular venous infusion line.**
- **For neonatal patients, make sure that all sensor connectors and adapter cable connectors are outside the incubator. The humid atmosphere inside can cause inaccurate measurements.**

NOTE

- Up to two measurement sites are available simultaneously.

12.6 Changing the SpO₂ Settings

NOTE

- The settings of in the SpO₂ module and SpO₂b module are linked.

12.6.1 Changing the SpO₂ Alarm Settings

To change the SpO₂ alarm settings, follow this procedure:

1. Select the SpO₂ numeric area or waveform area to enter the **SpO2** dialog.
2. Select the **Alarm** tab.
3. Enter the password if required. For more information, refer to *33.14.3 Selecting Password for User Authentication*.
4. Set the alarm properties as desired.

For SpO₂b, you can also set alarm properties for ΔSpO₂.

NOTE

- The desat alarm is a high level alarm notifying you of potentially life threatening drops in oxygen saturation. When the SpO₂ value is below the desat alarm limit and desat alarm switch is set on, the message "SpO2 Desat" is displayed.
- You can switch off the SpO₂ Desat alarm only when the SpO₂ Desat Alarm Off is enabled. For more information, see section *33.3.7.6 Setting the Switch of the SpO₂ Desat Alarm Off*.

12.6.2 Nellcor SatSeconds™ Alarm Management

With traditional alarm management, high and low alarm limits are set for monitoring oxygen saturation. During monitoring, once an alarm limit is violated, an audible alarm immediately sounds. When the patient SpO₂ fluctuates near an alarm limit, the alarm sounds each time the limit is violated. Such frequent alarms can be distracting. Nellcor's SatSeconds alarm management technique is used to reduce these nuisance alarms.

The SatSeconds feature is available with the Nellcor SpO₂ to decrease the likelihood of false alarms caused by motion artifacts. With SatSeconds alarm management, high and low alarm limits are set in the same way as those with traditional alarm management. A SatSeconds limit is also set. The SatSeconds limit controls the amount of time that SpO₂ saturation may be outside the set limits before an alarm sounds.

The method of calculation is as follows: the percentage points of the SpO₂ saturation falling outside the alarm limit is multiplied by the number of seconds remaining outside the limit. This can be stated as the equation:

$$\text{SatSeconds} = \text{Points} \times \text{Seconds}$$

Only when the SatSeconds limit is reached, the monitor gives a SatSeconds alarm. For example, the figure below demonstrates the alarm response time with a SatSeconds limit set at 50 and a low SpO₂ limit set at 90%. In this example, the patient SpO₂ drops to 88% (2 points) and remains there for 2 seconds. Then it drops to 86% (4 points) for 3 seconds, and then to 84% (6 points) for 6 seconds. The resulting SatSeconds are:

% SpO ₂	Seconds	SatSeconds
2x	2=	4
4x	3=	12
6x	6=	36
Total SatSeconds=		52

After approximately 11 seconds, a Sat-Second alarm would sound, because the limit of 50 SatSeconds would have been exceeded.

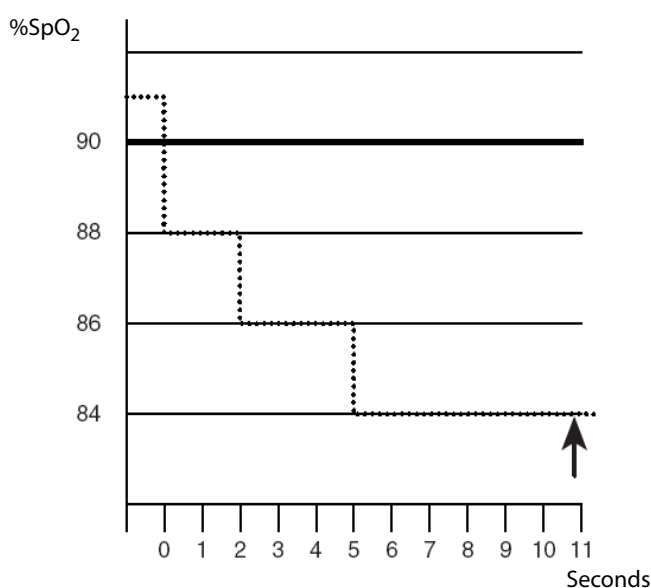

Saturation levels may fluctuate rather than remaining steady for a period of several seconds. Often, the patient SpO₂ may fluctuate above and below an alarm limit, re-entering the non-alarm range several times. During such fluctuation, the monitor integrates the number of SpO₂ points, both positive and negative, until either the SatSeconds limit is reached, or the patient SpO₂ re-enters the non-alarm range and remains there.

NOTE

- **The SpO₂ Too Low or SpO₂ Too High alarm is presented in the case that SpO₂ value violates the alarm limits 3 times within one minute even if the setting of SatSeconds is not reached.**

To set the SatSeconds, follow this procedure:

1. Select the SpO₂ numeric area or waveform area to enter the **SpO₂** dialog.
2. Select the **Alarm** tab.
3. Set **Sat-Seconds**.

12.6.3 Setting SpO₂ Sensitivity (for Masimo SpO₂)

For Masimo SpO₂, select the **Sensitivity** as per signal quality and patient motion.

Normal sensitivity is the recommended for patients who are experiencing some compromise in blood flow or perfusion. It is advisable for care areas where patients are observed frequently, such as the intensive care unit (ICU).

Adaptive Probe Off Detection (APOD) sensitivity is the recommended sensitivity mode where there is a high probability of the sensor becoming detached. It is also the suggested mode for care areas where patients are not visually monitored continuously. This mode delivers enhanced protection against erroneous pulse rate and arterial oxygen saturation readings when a sensor becomes inadvertently detached from a patient due to excessive movement.

Maximum sensitivity is recommended for use on patients with weak signals (e.g. high ambient noise and/or patients with very low perfusion) and for use during procedures or when clinician and patient contact is continuous such as in higher acuity settings.

To set SpO₂ sensitivity, follow this procedure:

1. Select the SpO₂ numeric area or waveform area to enter the **SpO₂** dialog.
2. Select the **Setup** tab.
3. Set **Sensitivity** to **Maximum, Normal, or APOD**.

CAUTION

- **When using the Maximum Sensitivity setting, performance of "Sensor Off" detection may be compromised. If the equipment and the sensor becomes detached from the patient, the potential for false readings may occur due to environmental noise such as light, and vibration.**
 - **Configuring the monitor to "Load Latest Configuration" as the default configuration may result in Masimo SpO₂ being set to Maximum sensitivity mode on power up or after admitting a new patient. Maximum sensitivity is recommended for use during procedures or when clinician and patient contact is continuous, such as in higher acuity settings. Maximum sensitivity is not recommended for care areas where patients are not monitored visually as "Sensor Off" detection may be compromised. Refer to Section 32.4 Setting Default Configuration for managing configuration.**
-

12.6.4 Enabling FastSAT (for Masimo SpO₂)

FastSAT enables rapid tracking of arterial oxygen saturation changes as may be required in urgent situations. When FastSAT is switched on, the averaging algorithm evaluates all the SpO₂ values and provides an averaged SpO₂ value that is a better representation of the patient's current oxygen saturation status.

The reliability of FastSAT is dependent on the setting for the averaging time and the input signal. FastSAT is disabled by default. To enable FastSAT, follow this procedure:

1. Select the SpO₂ numeric area or waveform area to enter the **SpO2** menu.
2. Select the **Setup** tab.
3. Switch on **FastSAT**.

12.6.5 Displaying SIQ (for Masimo SpO₂)

The signal quality indicator (SIQ) displays below the Pleth waveform. The SIQ is conveyed by vertical bars. The height of the bar provides an assessment of the confidence in the displayed SpO₂ value. The SpO₂ SIQ can also be used to identify the occurrence of a patient's pulse.

The following picture shows the SpO₂ SIQ:

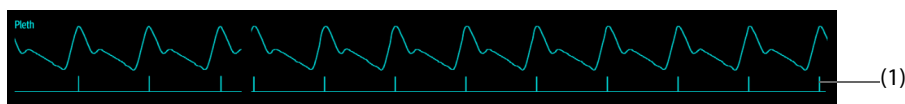

(1) Signal quality indicator (SIQ)

To show SpO₂ SIQ, follow this procedure:

1. Select the SpO₂ numeric area or waveform area to enter the **SpO2** menu.
2. Select the **Setup** tab.
3. Switch on **Display SIQ**.

12.6.6 Changing Averaging Time (for Masimo SpO₂)

The SpO₂ value displayed on the monitor screen is the average of data collected within a specific time. The shorter the averaging time is, the quicker the monitor responds to changes in the patient's oxygen saturation level. Contrarily, the longer the averaging time is, the slower the monitor responds to changes in the patient's oxygen saturation level, but the SpO₂ measurement is more stable. For critically ill patients, selecting a shorter averaging time will help with understanding the patient's state.

To set the averaging time, follow this procedure:

1. Select the SpO₂ numeric area or waveform area to enter the **SpO2** dialog.
2. Select the **Setup** tab.
3. Set **Averaging**.

12.6.7 Monitoring SpO₂ and NIBP Simultaneously

When monitoring SpO₂ and NIBP on the same limb simultaneously, you can switch on **NIBP Simul** to lock the SpO₂ alarm status until the NIBP measurement ends. If you switch off **NIBP Simul**, low perfusion caused by NIBP measurement may lead to inaccurate SpO₂ readings and therefore cause false physiological alarms.

To set the **NIBP Simul**, follow this procedure:

1. Select the SpO₂ numeric area or waveform area to enter the **SpO2** dialog.
2. Select the **Alarm** tab.
3. Set **NIBP Simul**.

12.6.8 Changing the Sweep Speed of the Pleth Waveform

To set the sweep speed of Pleth waveform, follow this procedure:

1. Select the SpO₂ numeric area or waveform area to enter the **SpO2** dialog.
2. Select the **Setup** tab.
3. Set **Speed**.

12.7 Changing the PR Settings

12.7.1 Changing the PR Alarm Settings

To change the PR alarm settings, follow this procedure:

1. Select the SpO₂ numeric area or waveform area to enter the **SpO2** dialog.
2. Select the **PR** tab.
3. Enter the password if required. For more information refer to *33.14.3 Selecting Password for User Authentication*.
4. Set the alarm properties as desired.

12.7.2 Changing the QRS Volume

If the **Alarm Source** is set to **PR**, the QRS tone is derived from PR measurements. To set the QRS volume, follow this procedure:

1. Select the SpO₂ numeric area or waveform area to enter the **SpO2** dialog.
2. Select the **PR** tab.
3. Select the **Setup** tab.
4. Set **QRS Volume**.

If the SpO₂ value is valid, the monitor also adjusts the QRS tone (pitch tone) according to the SpO₂ value. For information, see *33.15.3 Setting the SpO₂ Tone Mode*.

NOTE

-
- **Changing the QRS volume settings in the PR Setup page also changes the QRS volume settings in the Setup page of the ECG dialog.**
-

12.7.3 Setting the PR Source

Current pulse source is displayed in the PR numeric area if current PR source is not SpO₂. The PR from current pulse source has the following characteristics:

- PR is stored in the monitor's database and can be reviewed in the graphic and tabular trends. In graphic trends, as the PR curve has the same color as that of current PR source.
- PR is sent via the network to the CMS, if available.

To set which parameter is used as a PR source, follow this procedure:

1. Select the SpO₂ numeric area or waveform area to enter the **SpO₂** dialog.
2. Select the **PR** tab.
3. Select the **Setup** tab.
4. Set **PR Source**.

The dropdown list of the **PR Source** displays the currently available PR sources from top to bottom by priority. When you select **Auto**, the system will automatically select the first option as the PR source. If the current PR source is unavailable, the system will automatically switch **PR Source** to **Auto**. When you select **IBP**, the system will automatically select the first pressure label as the PR source.

12.7.4 Showing/Hiding PR

You can set whether to display the PR value in the SpO₂ parameter area. To do so, follow this procedure:

1. Select the SpO₂ numeric area or waveform area to enter the **SpO₂** menu.
2. Select the **PR** tab.
3. Select the **Setup** tab.
4. Switch on or off **Display PR**.

12.8 Displaying SpO₂ Statistics

You can show SpO₂ statistics for a defined period of time. To do so, follow this procedure:

1. Access the **Tile Layout** in either of the following ways:
 - ◆ Select the **Screen Setup** quick key → select the **Tile Layout** tab.
 - ◆ Select the **Main Menu** quick key → from the **Display** column select **Tile Layout**.
2. Select the parameter numeric area where you want to display SpO₂ statistics, and then from the popup list select **SpO₂** → **SpO₂ Statistics**.

The following figure shows the SpO₂ statistics area.

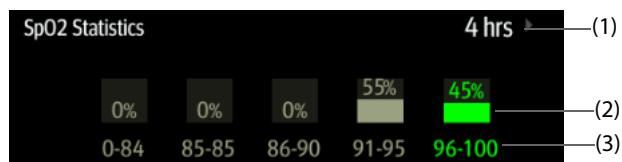

- (1) Duration of SpO₂ statistics
- (2) Results of SpO₂ statistics
- (3) Sections for statistics: The section in green indicates the target range.

12.8.1 Selecting the Range of each SpO₂ Section and the Target Section

To define the SpO₂ range of each section, follow this procedure:

1. Select the SpO₂ statistics area.
2. In the **To** column set the SpO₂ value at which each section ends. Changing the value in the **To** column automatically changes the value in the **From** column of the next section.
3. In the **Target** column select the section to be used as the target section. The target section is highlighted in green in the SpO₂ statistics area.

12.8.2 Selecting the SpO₂ Statistics Length

The time period over which the SpO₂ statistics are calculated is configurable. From the SpO₂ statistics area, select a new duration from the popup menu.

12.9 SpO₂ Troubleshooting

This section lists the problems that might occur. If you encounter the problems when using the equipment or accessories, check the table below before requesting service. If the problem persists, contact your service personnel.

NOTE

- For the physiological and technical alarm messages, see **Appendix D Alarm Messages**.

Problem	Solution
Do not see SpO ₂ numeric area or waveform area on the main screen	<ol style="list-style-type: none"> 1. Check that the SpO₂ is set to display in the Screen Setup → → Tile Layout page. For more information, see 3.9.2 <i>Displaying Parameter Numerics and Waveforms</i>. 2. Check that the SpO₂ parameter switch is enabled. If not, enable the SpO₂ measurement. For more information, see 3.9.1 <i>Switching On or Off a Parameter</i>. 3. Check that the cable connections of the SpO₂ sensor and the extension cable are tight. Replace the SpO₂ sensor or the extension cable if needed.
Dashes "--" display in place of numerics	<ol style="list-style-type: none"> 1. Check that the cable connections of SpO₂ sensor and the extension cable are tight. Replace the SpO₂ sensor or the extension cable if needed. 2. Reconnect the SpO₂ sensor if the alarm SpO₂ Sensor Off appears. 3. Check the PI value. If the PI value is too low, adjust the SpO₂ sensor, or apply the sensor to a site with better perfusion. 4. Move the sensor to a place with weaker ambient light, or cover the sensor to minimize the ambient light if the alarm SpO₂ Too Much Light appears.
Low amplitude SpO ₂ signal	<ol style="list-style-type: none"> 1. The SpO₂ sensor and NIBP cuff are placed on the same limb. Change the monitoring site if necessary. 2. Check the PI value. If the PI value is too low. Adjust the SpO₂ sensor, or apply the sensor to a site with better perfusion.
SpO ₂ value is inaccurate	<ol style="list-style-type: none"> 1. Check the patient's vital signs. 2. Check for conditions that may cause inaccurate SpO₂ readings. For more information, see 12.3 <i>SpO₂ Measurement Limitations</i>. 3. Check the monitor, the SpO₂ module or the MPM for proper functioning.

12.10 Nellcor Information



Nellcor Patents

This posting serves as notice under 35 U.S.C.§287(a) for Covidien patents: <http://www.covidien.com/patents>.

No Implied License

Possession or purchase of this device does not convey any express or implied license to use the device with unauthorized replacement parts which would, alone, or in combination with this device, fall within the scope of one or more of the patents relating to this device.

12.11 Masimo Information



Masimo Patents

This posting serves as notice under 35 U.S.C. §287(a) for Masimo patents: <http://www.masimo.com/patents.htm>.

No Implied License

Possession or purchase of this device does not convey any express or implied license to use the device with unauthorized sensors or cables which would, alone, or in combination with this device, fall within the scope of one or more of the patents relating to this device.

12.12 Masimo End-User License Agreement

THIS DOCUMENT IS A LEGAL AGREEMENT BETWEEN YOU ("PURCHASER") AND SHENZHEN MINDRAY. IF YOU DO NOT AGREE TO THE TERMS OF THIS AGREEMENT, PROMPTLY RETURN THE ENTIRE PACKAGE, INCLUDING ALL ACCESSORIES, IN THEIR ORIGINAL PACKAGE, WITH YOUR SALES RECEIPT TO SHENZHEN MINDRAY FOR A FULL REFUND.

1. **Grant of License.** In consideration of payment of the license fee, which is part of the price paid for this product, Shenzhen Mindray grants to Purchaser a nonexclusive, nontransferable license, without right to sublicense, to use the copy of the incorporated software/firmware, and documentation in connection with Purchaser's use of the Masimo Products for their labeled purpose. Shenzhen Mindray reserves all rights not expressly granted to Purchaser.
2. **Ownership of Software/Firmware.** Title to, ownership of, and all rights and interests in, any Masimo software and/or firmware and the documentation, and all copies thereof, remain at all times vested in Masimo Corporation, licensor to Shenzhen Mindray, and they do not pass to Purchaser.
3. **Assignment.** Purchaser shall not assign or transfer this License, in whole or in part, by operation of law or otherwise, without Shenzhen Mindray's prior written consent; any attempt without such consent, to assign any rights, duties or obligations arising hereunder shall be void.
4. **Copy Restrictions.** The software/firmware, mask works, circuit board layouts, and accompanying written materials are copyrighted. Unauthorized copying of the software, including software that has been modified, merged, or included with other software, or other written materials is expressly forbidden. You may be held legally responsible for any copyright infringement that is cause or incurred by your failure to abide by the terms of this license. Nothing in this license provides any rights beyond those provided by 17 U.S.C. §117.
5. **Use Restriction.** As the Purchaser, you may physically transfer the products from one location to another provided that the software/firmware is not copied. You may not electronically transfer the software/firmware from the products to any other device. You may not disclose, publish, translate, release distribute copies of, modify, adapt, translate, reverse engineer, decompile, disassemble, or create derivative works based on the Masimo Product, the software/firmware, or the written materials without the prior written consent of Masimo. Masimo Sensors that are designated for single use are licensed under Masimo patents for use on a single patient only, and are not sold. There is no license, implied or otherwise, that would allow use of single use Masimo Sensors beyond their intended single use. After use of single use Masimo Sensors, there is no further license granted by Masimo to use the sensors and they must be discarded.
6. **Transfer Restrictions.** The software/firmware is licensed to the Purchaser, and may not be transferred to anyone, except other end-users, without the prior written consent of Shenzhen Mindray. In no event may you transfer, assign, rent, lease, sell, or otherwise dispose of the software/firmware or the products on a temporary basis.
7. **Beneficiary.** Masimo Corporation is a Beneficiary of this Agreement and has the right to enforce its provisions.

U.S. Government Rights: If you are acquiring software (including the related documentation) on behalf of any part of the United States Government, the following provisions apply: the software is deemed to be "commercial software" and "commercial computer software documentation," respectively pursuant to DFAR Section 227.7202 FAR 12.212, as applicable. Any use, modification, reproduction, release, performance, display or disclosure of the software (including the related documentation) by the U.S. Government or any of its agencies shall be governed solely by the terms of this Agreement and shall be prohibited except to the extent expressly permitted by the terms of this agreement.

This page intentionally left blank.

13 Monitoring Temperature (Temp)

13.1 Temperature Introduction

The monitor can continuously monitor the patient's skin temperature and core temperature by the MPM module and the Temp modules. Thermally sensitive resistors (thermistors) are used, and are based on the principle that electrical resistance of the thermistor changes as temperature changes. The resistance change of the thermistors is used to calculate the temperature.

You can connect an MPM module and up to three Temp modules. Up to eight temperature sites can be monitored simultaneously and the difference between two measured sites is calculated.

Temperature monitoring is intended for adult, pediatric and neonatal patients.

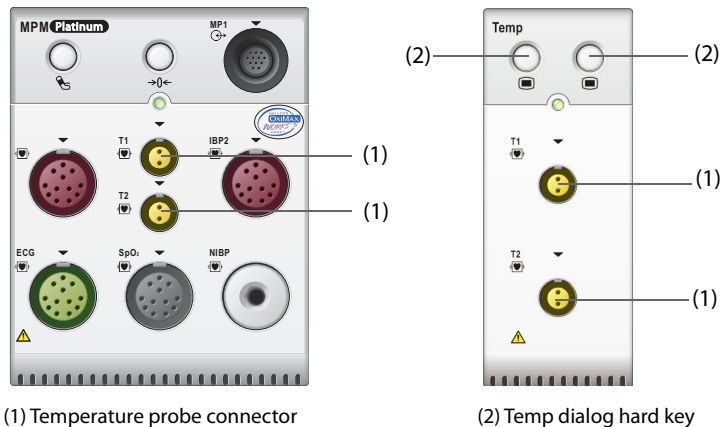

(1) Temperature probe connector

(2) Temp dialog hard key

13.2 Temperature Safety Information

CAUTION

- **Verify that the probe detection program works correctly before monitoring. Remove the temperature probe cable from the temperature probe connector, and check that the monitor can display the alarm messages and give alarm tones correctly.**

13.3 Temperature Display

The following figure shows the Temp numeric area for temperature monitoring with the MPM module or Temp module. Your display may be configured to look different.

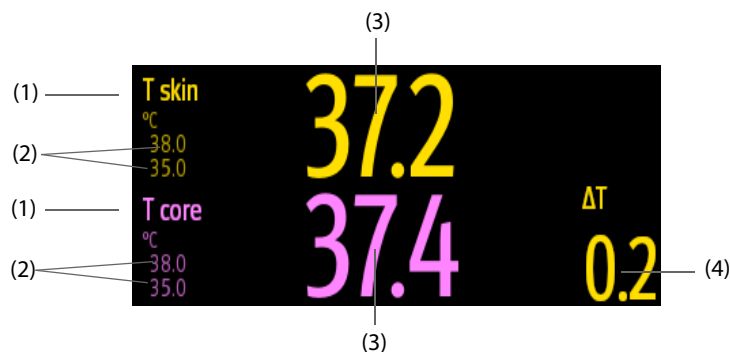

(1) Temperature site

(2) Temperature alarm limits

(3) Temperature value

(4) Temperature difference (ΔT): Difference between two temperature sites. It displays only when ΔT is switched on.

13.4 Preparing for Temperature Monitoring

To prepare temperature monitoring, follow this procedure:

1. Select an appropriate probe for your patient according to patient category and measured site.
2. Plug the probe or temperature cable to the temperature connector. If using a disposable probe, connect the probe to the temperature cable.
3. Follow the probe manufacturer's instructions to connect the probe to the patient.

13.5 Changing Temperature Settings

13.5.1 Setting the Temperature Alarm Properties

To set the temperature alarm properties, follow this procedure:

1. Select the temperature numeric area to enter the **Temp** dialog.
2. Select the **Alarm** tab.
3. Enter the password if required. For more information, refer to 33.14.3 *Selecting Password for User Authentication*.
4. Set the alarm properties as desired.

13.5.2 Selecting the Temperature Label

Select the temperature label according to the measurement site. To do so, follow this procedure:

1. Select the temperature numeric area to enter the **Temp** dialog.
2. Select the **Setup** tab.
3. Set the temperature label.

Label	Description	Label	Description
T1	Temperature of application site 1	T amb	Ambient temperature
T2	Temperature of application site 2	T airw	Airway temperature
T skin	Skin temperature	T vesic	Vesical temperature
T core	Core temperature	T blood	Blood temperature
T axil	Axillary temperature	T myo	Myocardial temperature
T naso	Nasopharyngeal temperature	T tym	Tympanic temperature
T eso	Esophageal temperature	T cereb	Cerebral temperature
T rect	Rectal temperature		

13.5.3 Displaying the Temperature Difference

To display the temperature difference between two measurement sites monitored by the same temperature module, switch on ΔT . To do so, follow this procedure:

1. Select the temperature numeric area to enter the **Temp** dialog.
2. Select the **Setup** tab.
3. Switch on ΔT .

13.6 Temperature Troubleshooting

This section lists the problems that might occur. If you encounter the problems when using the equipment or accessories, check the table below before requesting service. If the problem persists, contact your service personnel.

NOTE

- For the physiological and technical alarm messages, see **Appendix D Alarm Messages**.

Problem	Solution
Do not see Temp numeric area on the main screen	<ol style="list-style-type: none">1. Check that if the Temp parameter switch is enabled. If not, enable the Temp measurement. For more information, see <i>3.9.1 Switching On or Off a Parameter</i>.2. Check that the connections of the temperature probe and the temperature cable are tight.
Measurement fails/'--' is displayed in the Temp numeric area	<ol style="list-style-type: none">1. If using a disposable probe, check the connection between the probe and the temperature cable.2. Try using a known good probe in case the sensor is damaged.

This page intentionally left blank.

14 Monitoring Noninvasive Blood Pressure (NIBP)

14.1 NIBP Introduction

The monitor uses the oscillometric method for measuring Non-Invasive Blood Pressure (NIBP). NIBP measurement is based on the principle that pulsatile blood flow through an artery creates oscillations of the arterial wall. The oscillometric device uses a blood pressure cuff to sense these oscillations that appear as tiny pulsations in cuff pressure. The oscillometric devices measure the amplitude of pressure changes in the occluding cuff as the cuff deflates from above systolic pressure. The amplitude suddenly increases as the pulse breaks through the occlusion in the artery. As the cuff pressure decreases further, the pulsations increase in amplitude, reach a maximum (which approximates to the mean pressure), and then diminish. The oscillometric method measures the mean pressure and determines the systolic and diastolic pressures.

The NIBP module is integrated into the MPM module. NIBP monitoring is intended for adult, pediatric, and neonatal patients.

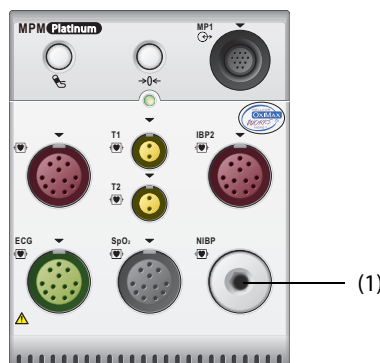

(1) NIBP cuff connector

NOTE

- **Blood pressure measurements determined with this device are equivalent to those obtained by a trained observer using the cuff/stethoscope auscultatory method or an intra-arterial blood pressure measurement device, within the limits prescribed by the American National Standard: manual, electronic, or automated sphygmomanometers.**
- **NIBP measurement can be performed during electro-surgery and discharge of a defibrillator.**

14.2 NIBP Safety Information

WARNING

- **Be sure to select the correct patient category setting for your patient before NIBP measurement. Do not apply the higher adult settings for pediatric or neonatal patients. Otherwise, it may present a safety hazard.**
- **Do not measure NIBP on patients with sickle-cell disease or on the limb where skin damage has occurred or is expected.**
- **Use clinical judgment to determine whether to perform frequent unattended blood pressure measurements on patients with severe blood clotting disorders because of the risk of hematoma in the limb fitted with the cuff.**
- **Do not use the NIBP cuff on a limb with an intravenous infusion or arterial catheter in place. This could cause tissue damage around the catheter when the infusion is slowed or blocked during cuff inflation.**
- **Do not apply cuff on the arm on the side of a mastectomy.**

- **Continuous cuff pressure due to connection tubing kinking may cause blood flow interference and result in harmful injury to the patient.**
- **NIBP reading can be affected by the measurement site, the position of the patient, exercise, or the patient's physiologic condition. If you doubt the NIBP measurements, determine the patient's vital signs by alternative means, and then verify that the monitor is working correctly.**
- **Devices that exert pressure on tissue have been associated with purpura, ischemia, and neuropathy. Inspect the application site regularly to ensure skin quality and inspect the extremity of the cuffed limb for normal color, warmth and sensitivity. If the skin quality changes, or if the extremity circulation is being affected, move the cuff to another site or stop the blood pressure measurements immediately. Check more frequently when making automatic or STAT measurements. Auto NIBP measurements with one and two minute intervals are not recommended for extended periods of time.**
- **Do not modify or replace connectors of the NIBP air hose except with mindray-approved connectors. Use neonatal and infant cuffs with CM1901 hoses only. Use pediatric/adult cuffs with CM1903 hoses only.**
- **Never connect intra-arterial or intra-venous lines, or any other incompatible connectors to the NIBP hose. This can cause serious injury or death.**
- **NIBP diagnostic significance must be decided by the hospital's clinician staff.**

CAUTION

- **Measuring NIBP on patients connected to an Intra Aortic Balloon Pump (IABP) machine may result in the NIBP measurement, including PR, to be inaccurate or fail.**
 - **Only use parts and accessories specified in this manual. Follow the instructions for use and adhere to all warnings and cautions.**
 - **Using IABP may cause NIBP, including PR, measurements inaccurate or failed.**
 - **Accuracy of NIBP measurement depends on using a cuff of proper size. It is essential to measure limb circumference and choose a cuff with proper size.**
-

14.3 NIBP Measurement Limitations

Measurements are impossible with heart rate extremes of less than 30 bpm or greater than 300 bpm, or if the patient is on a heart-lung machine. The measurement may be inaccurate or impossible in the following situations:

- Regular arterial pressure pulses are hard to detect
- Excessive and continuous patient movement such as shivering or convulsions
- Cardiac arrhythmias
- Rapid blood pressure changes
- Severe shock or hypothermia that reduces blood flow to the peripheries
- On an edematous extremity
- Obesity, where a thick layer of fat surrounding a limb dampens the oscillations coming from the artery

NOTE

- **The effectiveness of this sphygmomanometer has not been established in pregnant women, including pre-eclamptic patients.**
-

14.4 Measurement Modes

The monitor provides the following NIBP measurement modes:

- Manual: measurement on demand.
- Auto: repeated measurements at set interval.
- STAT: continual rapid series of measurements over a five-minute period.
- Sequence: continually automatic measurement at set durations and intervals.

14.5 NIBP Display

The NIBP display shows only numerics.

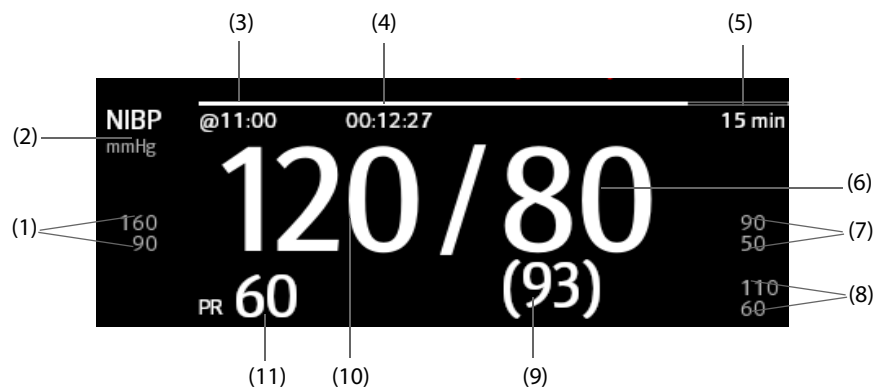

- (1) Systolic pressure alarm limits
- (2) NIBP unit: mmHg or kPa
- (3) The last NIBP measurement time
- (4) Time to the next measurement (for Auto mode and Sequence mode)
- (5) Measurement mode: for Auto NIBP, interval is displayed; for Sequence mode, the current phase and interval are displayed
- (6) Diastolic pressure
- (7) Diastolic pressure alarm limits
- (8) Mean pressure alarm limits
- (9) Mean pressure (displayed after measurement completed) or cuff pressure (displayed during the measurement)
- (10) Systolic pressure
- (11) Pulse Rate

NOTE

- If NIBP measurement fails, "XX" is displayed; if NIBP measurement is not taken or NIBP measurement exceeds its measurement ranges, "--" is displayed.
- NIBP numerics in black color with a light outline indicate that the measurement is old and exceeds the configured NIBP Measurement Timeout time (see section 33.5.10 Setting Parameter Measurement Timeout). These NIBP values are not recommended for reference.

14.6 Preparing for NIBP Measurements

14.6.1 Preparing the Patient for NIBP Measurements

In normal use, perform NIBP measurement on a patient who is in the following position:

- Comfortably seated
- Legs uncrossed
- Feet flat on the floor
- Back, arm and feet supported

NOTE

- It is recommended that the patient remains calm and relaxes as much as possible before performing the measurement and that the patient does not talk during the measurement.

- **Other factors that have been shown to result in an overestimation of blood pressure are labored breathing, full bladder, pain etc.**

14.6.2 Placing the NIBP Cuff

To place the NIBP cuff, follow this procedure:







1. Verify that the patient category setting is correct.
2. Connect the air tubing to the NIBP connector.
3. Select an appropriately sized cuff for the patient, and then wrap it around the limb directly over the patient's skin as follows:
 - a. Determine the patient's limb circumference.
 - b. Select an appropriate cuff by referring to the limb circumference marked on the cuff. The width of the cuff should be 40% (50% for neonates) of the limb circumference, or 2/3 of the length of the upper arm or the thigh. The inflatable part of the cuff should be long enough to encircle to overlap at least 50% to 80% of the limb.
 - c. Apply the cuff to the patient's upper arm or leg and make sure the Φ marking on the cuff matches the artery location. The cuff should fit snugly, but with enough room for two fingers to be placed between the cuff and the patient's arm (on adults), and loosely on neonates with little or no air present within the cuff. Otherwise it may cause discoloration and ischemia of the extremities. Make sure that the cuff index line falls within the range markings on the cuff. If it does not, use a cuff that fits better.
 - d. Middle of the cuff should be at the level of the right atrium of the heart. If it is not, use the measurement correction formula to correct the measurement. For more information, see *14.8.7 Setting the NIBP Display Format*.
4. Connect the cuff to the air tubing. Avoid compression or restriction of pressure tubes. Air must pass unrestricted through the tubing.



CAUTION

- **Do not touch or apply external pressure against the cuff and air tubing during NIBP measurement. This may cause inaccurate blood pressure values.**
- **Use care when placing the cuff on an extremity used for monitoring other patient parameters.**

14.7 Starting and Stopping NIBP Measurements

Start and stop NIBP measurement by selecting the NIBP quick keys or from the NIBP dialog.

Task	By Quick Key	From NIBP dialog
Start a manual measurement	NIBP Start/Stop quick key 	Start NIBP button
Start auto NIBP series	NIBP Start/Stop quick key 	Setup tab → set Interval → Start NIBP button
	NIBP Measure quick key  → select Interval	
Start NIBP sequence measurement	NIBP Measure quick key  → Sequence	Sequence tab → set NIBP sequence → Start NIBP button
Start STAT measurement	NIBP STAT quick key 	STAT button
	NIBP Measure quick key  → STAT	
Stop the current NIBP measurements	NIBP Start/Stop quick key 	Stop NIBP button

Task	By Quick Key	From NIBP dialog
End auto NIBP series or NIBP Sequence	NIBP Stop All quick key 	NIBP Stop All button
Stop STAT measurement and end series	NIBP Start/Stop quick key 	Stop NIBP or NIBP Stop All button
	NIBP STAT quick key 	

14.8 Changing NIBP Settings

14.8.1 Setting the NIBP Alarm Properties

To set the NIBP alarm properties, follow this procedure:

1. Select the NIBP numeric area to enter the **NIBP** dialog.
2. Select the **Alarm** tab.
3. Enter the password if required. For more information, refer to 33.14.3 *Selecting Password for User Authentication*.
4. Set the alarm properties as desired.

14.8.2 Setting the Initial Cuff Inflation Pressure

To set initial cuff inflation pressure, follow this procedure:

1. Select the NIBP numeric area to enter the **NIBP** dialog.
2. Select **Initial Pressure**, and then select the appropriate setting.

NOTE

- **For known hypertensive patients, you need to set initial cuff pressure to a higher value to reduce the measurement time.**

14.8.3 Setting the NIBP Interval

For auto NIBP measurement, you need to set the interval between two NIBP measurements. To set the NIBP interval, follow this procedure:

1. Select the NIBP numeric area to enter the **NIBP** dialog.
2. Set **Interval**. Selecting **Manual** switches to manual mode.

NOTE

- **NIBP Measure dialog gives quick access to starting and setting the interval. Selecting an option from the NIBP Measure dialog will change the NIBP interval to that selection and start the NIBP measurement.**

14.8.4 Selecting NIBP Start Mode

Start mode defines how future NIBP measurements are initiated with automatic measurement mode. To set the start mode, follow this procedure:

1. Select the NIBP numeric area to enter the **NIBP** dialog.
2. Select **Start Mode**.
 - ◆ **Clock:** after the first measurement, the monitor automatically synchronizes NIBP automatic measurements with the real time clock. For example, if **Interval** is set to **20 min**, and NIBP auto measurement is started at 14:03, the next measurement will be taken at 14:20, and then at 14:40, 15:00, and so on.

- ◆ **Interval:** after the first measurement, the monitor automatically repeats measurements at set interval. For example, if **Interval** is set to **20 min**, and NIBP auto measurement is started at 14:03, the next measurement will be taken at 14:23, and then at 14:43, 15:03, and so on.

14.8.5 Enabling the NIBP End Tone

The monitor can issue a reminder tone at the completion of NIBP measurement. The NIBP End Tone is off by default. To switch on the NIBP end tone, follow this procedure:

1. Select the NIBP numeric area to enter the **NIBP** dialog.
2. Switch on **NIBP End Tone**.

14.8.6 Setting NIBP Sequence

NIBP sequence measurement can have up to five phases: A, B, C, D, and E. The duration and interval of each phase can be set individually.

To set NIBP sequence, follow this procedure:

1. Select the NIBP numeric area to enter the **NIBP** dialog.
2. Select the **Sequence** tab.
3. Set **Duration** and **Interval** of each phase.

14.8.7 Setting the NIBP Display Format

To set the NIBP display format, follow this procedure:

1. Select the NIBP numeric area to enter the **NIBP** menu.
2. Select the **Setup** tab.
3. Set **Display Format**.

14.8.8 Setting the NIBP Alarm Limits Display Switch

To set whether to display the alarm limits of diastolic NIBP and mean NIBP, follow this procedure:

1. Select the NIBP numeric area to enter the **NIBP** menu.
2. Select the **Setup** tab.
3. Switch on or off **Display Alarm Limits**.

14.8.9 Showing/Hiding PR

You can set whether to display the PR value in the NIBP parameter area. To do so, follow this procedure:

1. Select the NIBP numeric area to enter the **NIBP** menu..
2. Select the **Setup** tab.
3. Switch on or off **Display PR**.

14.8.10 Correcting the NIBP Measurements

The middle of the cuff should be at the level of right atrium. If the limb is not at the heart level, the measurement should be corrected as follows:

- Add 0.75 mmHg (0.10 kPa) to the displayed value for each centimetre higher.
- Deduct 0.75 mmHg (0.10 kPa) to the displayed value for each centimeter lower.

14.9 Assisting Venous Puncture

You can use the NIBP cuff to cause sub-diastolic pressure to block the venous blood vessel and therefore help venous puncture. To assist venous puncture, follow this procedure:

1. Select the **Venipuncture** quick key or select the NIBP numeric area → **Setup** tab.

2. Set **Venipuncture Pressure**.
3. Select **Venipuncture** at the bottom of the dialog.
4. Puncture vein and draw blood sample.
5. Select the **NIBP Start/Stop** quick key to deflate the cuff. If the cuff is not manually deflated, the cuff automatically deflates after a fixed period of time (170 seconds for adult and pediatric patient, 85 seconds for neonatal patient).

During venous puncture, pay attention to the cuff pressure and the remaining time displayed in the NIBP numerics area.

14.10 NIBP Troubleshooting

This section lists the problems that might occur. If you encounter the problems when using the equipment or accessories, check the table below before requesting for services. If the problem persists, contact your service personnel.

NOTE

- For the physiological and technical alarm messages, see **Appendix D Alarm Messages**.

Problem	Solution
Cannot see NIBP numeric area on the main screen	<ol style="list-style-type: none"> 1. Check that the NIBP is set to display in the Screen Setup → Tile Layout page. For more information, see <i>3.9.2 Displaying Parameter Numerics and Waveforms</i> 2. Check that if the NIBP parameter switch is enabled. If not, enable the NIBP measurement. For more information, see <i>3.9.1 Switching On or Off a Parameter</i>.

This page intentionally left blank.

15 Monitoring Invasive Blood Pressure (IBP)

15.1 IBP Introduction

You can measure invasive blood pressure (IBP) using the MPM, or the IBP module. This patient monitor can monitor up to 8 invasive blood pressures and displays the systolic, diastolic and mean pressures and a waveform for each pressure.

IBP monitoring is intended for adult, pediatric, and neonatal patients. PAWP monitoring is only intended for adult and pediatric patients.

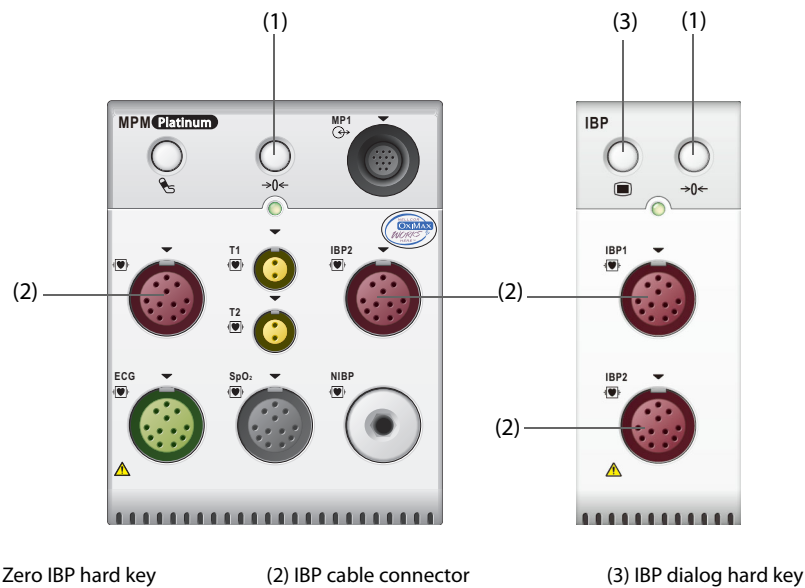

15.2 IBP Safety Information

WARNING

- Use only pressure transducers specified in this manual. Never reuse disposable pressure transducers. See chapter 25 Accessories for specified pressure transducers.
- Make sure that the applied parts never contact other conductive parts.
- To reduce the hazard of burns during high-frequency surgical procedures, ensure that the monitor's cables and transducers never come into contact with the high-frequency surgical units.
- When using accessories, their operating temperature should be taken into consideration. For more information, see instructions for use of accessories.
- All invasive procedures involve risks to the patient. Use aseptic technique. Follow catheter manufacturer's instructions.
- Mechanical shock to the invasive blood pressure transducer may cause severe shifts in zero balance and calibration, and cause erroneous readings.
- The neutral electrode of the electro-surgery unit (ESU) shall properly contact the patient. Otherwise, burns may result.

CAUTION

- Measuring IBP on patients connected to an Intra Aortic Balloon Pump (IABP) machine may result in the IBP measurement, including PR, to be inaccurate or fail.

15.3 Preparing for IBP Monitoring

15.3.1 IBP Equipment to Patient Connection

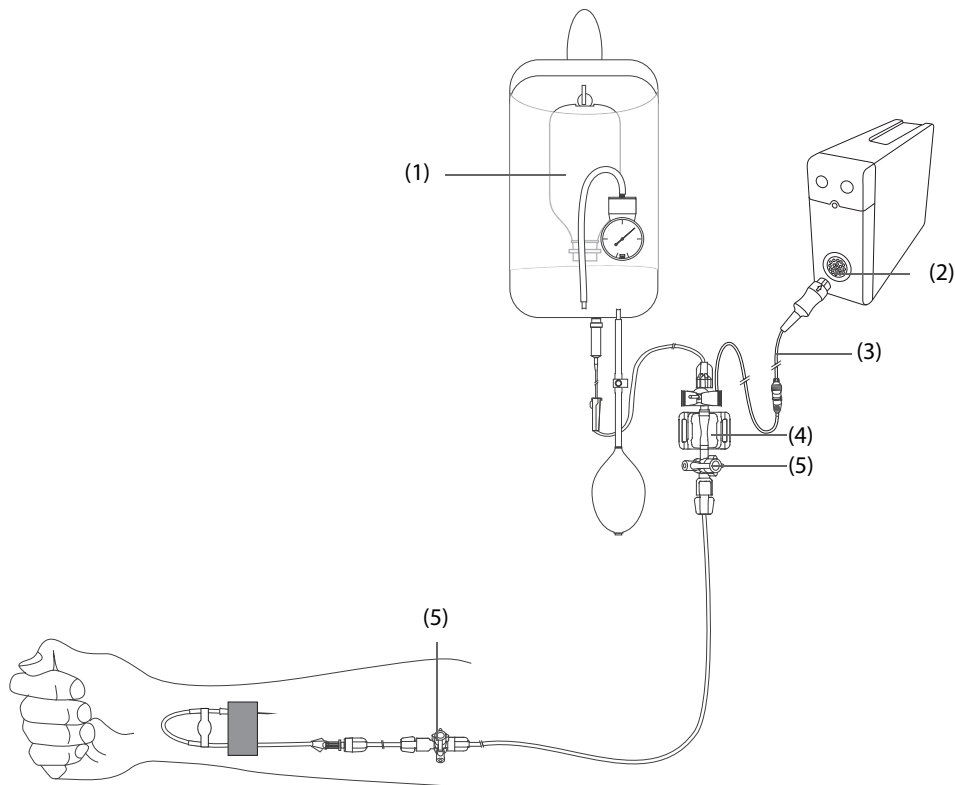

(1) Pressure bag

(2) IBP connector

(3) IBP cable

(4) IBP transducer

(5) Three-way valve

15.3.2 Measuring an Invasive Blood Pressure

To monitor IBP, follow this procedure:

1. Connect one end of the IBP cable to the IBP cable connector, and the other end to the IBP transducer.
2. Flush the IBP transducer system to exhaust all air from the tubing according to the manufacturer's instructions. Ensure that the system is free of air bubbles.
3. Connect the IBP transducer to the patient, making sure that the transducer is at the same horizontal level as the heart.
4. Select the proper pressure label for currently measured pressure. For more information, see *15.6.2 Changing the Pressure Label*.
5. Zero the IBP transducer. For more information, see *15.3.3 Zeroing the IBP transducer*. After a successful zeroing, turn off the three-way valve to the air and turn on the three-way valve to the patient.

CAUTION

- **Make sure that all the transducers are zeroed correctly before making IBP measurements.**
 - **Make sure that all air bubbles have been flushed from the IBP transducer system before making IBP measurements.**
 - **If measuring intracranial pressure (ICP) with a sitting patient, level the transducer with the top of the patient's ear. Incorrect leveling may give incorrect values (not applicable if measuring ICP with the Codman ICP transducer).**
-

15.3.3 Zeroing the IBP transducer

To avoid inaccurate pressure readings, the monitor requires a valid zero. Zero the transducer in accordance with your hospital policy. The IBP transducer should be zeroed in the following conditions:

- The IBP transducer, adapter cable or module is reconnected.
- The monitor restarts.
- The readings are in doubt.
- The monitor displays the prompt message **Zero Required**.

To zero the transducer, follow this procedure:

1. Connect the IBP transducer, the IBP adapter cable and the module.
2. Turn off the three-way valve (the one near the transducer) to the patient, in order to vent the transducer to the atmospheric pressure.
3. Zero the transducer by one of the following methods:
 - ◆ Press the **Zero** hard key on the module. In the **Zero IBP** dialog, select to zero an IBP, or select to zero all IBP.
 - ◆ Select the numeric area (such as the Art numeric area), and then select **Zero** button.
 - ◆ Select the **Zero IBP** quick key. In the **Zero IBP** dialog, select to zero an IBP, or select to zero all IBP.
4. After the zero calibration is completed, close the three-way valve to the air and open the three-way valve to the patient.

Zero calibration may fail in case of pressure fluctuation or pressure exceeding the calibration range. If zero calibration fails, follow this procedure:

1. Check that the three-way valve (the one near the transducer) is open to the air.
2. Perform zero calibration again. Do not sway the IBP transducer and tubing during zero calibration.

15.4 Measuring ICP Using the Codman ICP Transducer

15.4.1 Zeroing the Codman ICP transducer

The Codman ICP transducer (Model: 82-6653) must be zeroed before use. To zero the ICP transducer, follow this procedure:

1. Before unpacking the ICP transducer, check that the monitor supports the Codman ICP transducer.
 - a Select the **Main Menu** quick key → from the **Parameters** column select **Setup** → select **ICP** (If the **ICP** button is not in the **Parameter Setup** dialog, select any IBP button to enter corresponding IBP dialog, and then change the IBP label to **ICP**) → select the **Zero** tab.
 - b Check that the following icon is displayed in the **Zero** page. The monitor supports the Codman ICP transducer if the following icon is displayed in the **Zero** page.



2. Connect the ICP transducer, the ICP adapter cable and the module.
3. Follow the manufacturer's instructions to prepare the ICP transducer.
4. Zero the ICP transducer: when the message **Zero Reference** is displayed in the ICP numeric area, select the ICP waveform area or numeric area to enter the **ICP** dialog → select the **Zero** tab → select the **Zero** button.
5. Record the zero reference value on the blank area of the ICP transducer for reference.

If the ICP transducer zero calibration failed or the zero reference value is in doubt, perform the zero calibration again.

15.4.2 Measuring ICP

To perform the ICP measurement, follow this procedure:

1. Zero the Codman ICP transducer. For more information, see section 15.4.1 *Zeroing the Codman ICP transducer*.
2. Disconnect the ICP transducer and ICP adapter cable. Follow the manufacturer's instructions to apply the ICP transducer to the patient.
3. Reconnect the ICP transducer and ICP adapter cable.
4. Check that the zero reference value displayed on the monitor is consistent with that recorded on the ICP transducer.
 - ◆ Consistent: select **Accept**.
 - ◆ Inconsistent: input the zero reference value recorded on the ICP transducer, and select **Accept**.

If the patient being monitored for ICP must be transported, check that the target monitor supports the Codman ICP transducer. For more information, see 15.4.1 *Zeroing the Codman ICP transducer*. If the target monitor does not support the Codman ICP transducer, do not use it for ICP monitoring.

If the target monitor supports the Codman ICP transducer, follow this procedure to transport the patient:

1. Disconnect the ICP adapter cable from the measurement module, or remove the module from the monitor.
2. Connect the ICP adapter cable, measurement module, and the transport monitor, or insert the measurement module into the transport monitor.
3. Check that the zero reference value displayed on the monitor is consistent with that recorded on the ICP transducer.
 - ◆ Consistent: select **Accept**.
 - ◆ Inconsistent: input the zero reference value recorded on the ICP transducer, and select **Accept**.

CAUTION

- **If monitors of different brands are used to zero the Codman ICP transducer, the zero reference values can be different. Use a Mindray monitor to Zero the Codman ICP transducer if you will take ICP measurement using a Mindray monitor. Otherwise the ICP measurement could be inaccurate.**
-

15.5 IBP Display

The IBP measurement is displayed on the monitor as a waveform and numeric pressures. For arterial pressure, the IBP numeric area displays systolic pressure, diastolic pressure and mean pressure. For venous pressure, the IBP numeric area displays only the mean pressure. The figure below shows the waveform and numerics for the Art pressure.

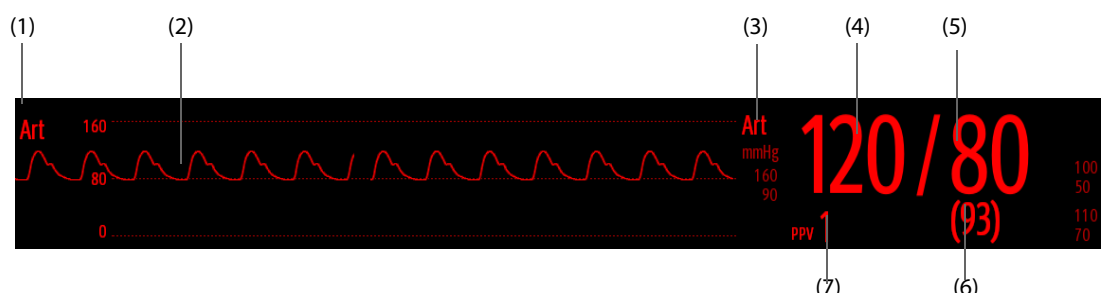

- | | |
|------------------------|-----------------------|
| (1) Pressure label | (2) Waveform |
| (3) Pressure Unit | (4) Systolic pressure |
| (5) Diastolic pressure | (6) Mean pressure |
| (7) PPV measurement | |

For some pressures, the parameter window may show the mean pressure only. For different pressures, their defaults unit may be different. If the Art and ICP pressures are measured simultaneously, the ICP parameter area will display numeric CPP, which is obtained by subtracting ICP from the Art mean.

15.5.1 Overlapping IBP Waveforms

The IBP waveforms can be displayed together. To combine IBP waveforms, follow this procedure:

1. Access **Tile Layout** by either of the following ways:
 - ◆ Select the **Screen Setup** quick key → select the **Tile Layout** tab.
 - ◆ Select **Main Menu** quick key → from the **Display** column select **Tile Layout**.
2. Select the waveform area where you want to display the overlapped IBP waveforms, and then select the IBP waves to be overlapped on the left side of the same line.
3. Repeat step 2 in another waveform area if needed.
4. Select  to save the setting and exit the screen. The main screen will display the overlapped IBP waves.

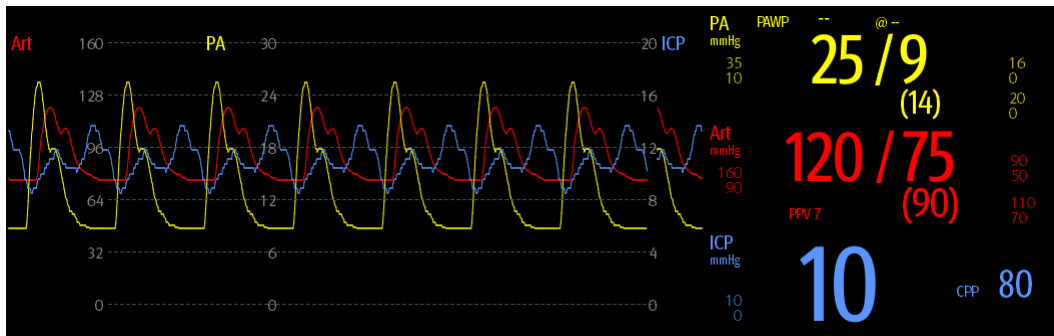

Selecting the overlapped IBP waveforms on the main screen opens the **Overlapping Waveform Setup** dialog, where you can make the following settings:

- **Scale**
 - ◆ Set **Left Scale** for the arterial pressure.
 - ◆ Set **Right Scale** for the venous pressure.
 - ◆ Set **CVP Scale** individually if the CVP waveform is combined and CVP unit is different from IBP unit.
 - ◆ Set **ICP Scale** individually if the ICP waveform is combined and ICP unit is different from IBP unit.
 - ◆ Set **PA Scale** individually if the PA waveform is combined.
- Switch on or off **Gridlines** to show or hide gridlines in the overlapped waveform area.
- Set **Speed** for the overlapped waveforms.

NOTE

- **The unit of CVP scale is consistent with the CVP parameter unit.**

15.6 Changing IBP Settings

15.6.1 Changing the IBP Alarm Settings

To change the IBP alarm settings, follow this procedure:

1. Select the IBP numeric area or waveform area to enter the corresponding pressure dialog.
2. Select the **Alarm** tab.
3. Enter the password if required. For more information, refer to *33.14.3 Selecting Password for User Authentication*.
4. Set the alarm properties of pressure.

15.6.2 Changing the Pressure Label

The pressure label is a unique identifier for each type of pressure. Therefore, it is recommended to select the proper pressure label for the source of the pressure being monitored.

To select the pressure label, follow this procedure:

1. Select the IBP numeric area or waveform area to enter the corresponding pressure dialog.
2. Select the **Setup** tab.
3. Set **IBP1 Label** or **IBP2 Label**.

Label	Description	Label	Description
Art	Arterial blood pressure	PA	Pulmonary artery pressure
Ao	Aortic pressure	UAP	Umbilical arterial pressure
BAP	Brachial arterial pressure	FAP	Femoral arterial pressure
CVP	Central venous pressure	LAP	Left atrial pressure
RAP	Right atrial pressure	ICP	Intracranial pressure
UVP	Umbilical venous pressure	LV	Left ventricular pressure
P1 to P4	Non-specific pressure label		

NOTE

- **The same label cannot be selected for different pressures. When two pressures are detected having the same label, the monitor automatically changes one pressure label to a currently unused one.**

15.6.3 Setting the Pressure Type for Display

For the non-specific pressure (P1, P2, P3 or P4), the displayed pressure type is configurable. To set the displayed pressure type, follow this procedure:

1. Select the numeric area or waveform area of the non-specific pressure to enter the corresponding pressure dialog.
2. Select the **Setup** tab.
3. Set **Measure**:
 - ◆ If this non-specific pressure is arterial pressure, set the **Measure** to **All**. In this case, its corresponding numeric area displays systolic pressure, diastolic pressure and mean pressure.
 - ◆ If this non-specific pressure is venous pressure, set the **Measure** to **Mean Only**. In this case, its corresponding numeric area displays only the mean pressure.

15.6.4 Changing the Sensitivity

The IBP value displayed on the monitor screen is the average of data collected within a specific time. The shorter the averaging time is, the quicker the monitor responds to changes in the patient's blood pressure, and the higher the sensitivity. Contrarily, the longer the averaging time is, the slower the monitor responds to changes in the patient's blood pressure, the lower the sensitivity, but the measurement accuracy will be improved. For critically ill patients, selecting higher sensitivity will help with understanding the patient's state.

To set the sensitivity, follow this procedure:

1. Select the IBP numeric area or waveform area to enter the corresponding pressure dialog.
2. Select the **Setup** tab.
3. Set **Sensitivity**.

15.6.5 Setting the IBP Waveform

To set the IBP waveform, follow this procedure:

1. Select the IBP numeric area or waveform area to enter the corresponding pressure dialog.
2. Select the **Setup** tab.
3. Set the following properties of the IBP waveform:

- ◆ **Speed**
- ◆ **Scale:** if **Auto** is selected, the size of the pressure's waveform will be adjusted automatically.

15.6.6 Setting the Display Format of Artery Pressure

To set the display format of the artery pressure, follow this procedure:

1. Select the numeric area or waveform area of any arterial pressure to enter the corresponding menu.
2. Select the **Setup** tab.
3. Set **Display Format**.

15.6.7 Showing/Hiding the Alarm Limits of Artery Pressure

To set whether to display the alarm limits of the arterial pressure, follow this procedure:

1. Select the numeric area or waveform area of any arterial pressure to enter the corresponding menu.
2. Select the **Setup** tab.
3. Switch on or off **Display Alarm Limits**.

15.6.8 Setting the Use PA-D as PAWP Switch

The PA-D value can be configured to replace the PAWP value for hemodynamic calculation. To do so, follow this procedure:

1. Select the PA numeric area or waveform area to enter the **PA** dialog.
2. Select the **Setup** tab.
3. Switch on or off **Use PA-D as PAWP**.

For more information on hemodynamic calculation, see *28.4 Hemodynamic Calculations*.

15.6.9 Enabling PPV Measurement

PPV indicates pulse pressure variation. When measuring the arterial pressure (except PA), the PPV measurement is available. To enable the PPV measurement, follow this procedure:

1. Select the IBP numeric area or waveform area to enter the corresponding pressure dialog.
2. Select the **PPV Setup** tab.
3. Switch on **PPV Measure**.

You can select PPV source after enabling the PPV measurement.

WARNING

- **This monitor can calculate PPV from beat-to-beat values of any arterial pulsatile pressure. The circumstances under which the calculation of a PPV value is clinically meaningful, appropriate and reliable must be determined by a physician.**
 - **The clinical value of the derived PPV information must be determined by a physician. According to recent scientific literature, the clinical relevance of PPV information is restricted to sedated patients receiving controlled mechanical ventilation and mainly free from cardiac arrhythmia.**
 - **PPV calculation may lead to inaccurate values in the following situations:**
 - ◆ **at respiration rates below 8 rpm**
 - ◆ **during ventilation with tidal volumes lower than 8 ml/kg**
 - ◆ **for patients with acute right ventricular dysfunction (cor pulmonale).**
 - **The PPV measurement has been validated only for adult patients.**
-

15.7 PAWP

Pulmonary Artery Wedge Pressure (PAWP) values, used to assess cardiac function, are affected by fluid status, myocardial contractility, and valve and pulmonary circulation integrity.

Obtain the measurement by introducing a balloon-tipped pulmonary artery flotation catheter into the pulmonary artery. When the catheter is in one of the smaller pulmonary arteries, the inflated balloon occludes the artery allowing the monitor to record changes in the intrathoracic pressures that occur throughout the respiration cycle.

The pulmonary wedge pressure is the left ventricular end diastolic pressure when the airway pressure and valve function are normal. The most accurate PAWP values are obtained at the end of the respiration cycle when the intrathoracic pressure is fairly constant and the artifact caused by respiration is minimal.

WARNING

- **PAWP monitoring is not intended for neonatal patients.**
-

15.7.1 PAWP Equipment to Patient Connection

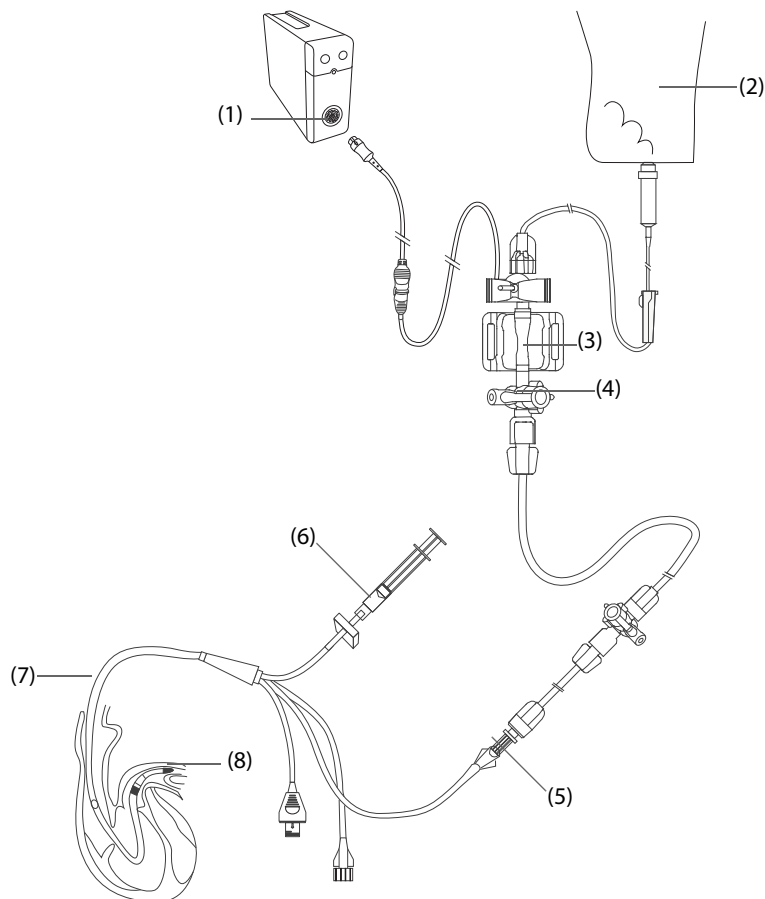

- | | |
|-----------------------------|-------------------------------|
| (1) IBP connector | (2) Flush bag |
| (3) IBP transducer | (4) Three-way valve |
| (5) PA distal port | (6) Balloon inflation syringe |
| (7) Thermodilution catheter | (8) Balloon |

15.7.2 Preparing to Measure PAWP

To prepare to monitor PAWP, follow this procedure:

1. Connect one end of the IBP cable to the IBP cable connector, and the other end to the IBP transducer. For more information, see 15.3.2 *Measuring an Invasive Blood Pressure*.
2. Follow the manufacturer's instructions to connect the PA port of the thermodilution catheter and the patient end of the IBP transducer.
3. Zero the IBP transducer. For more information, see 15.3.3 *Zeroing the IBP transducer*.
4. Set the IBP label to **PA** since the PAWP is measured on PA. For more information, see 15.6.2 *Changing the Pressure Label*.

15.7.3 Measuring PAWP

To measure the PAWP, follow this procedure:

1. Select the PA numeric area or waveform area to enter the **PA** dialog, and then select **PAWP**.

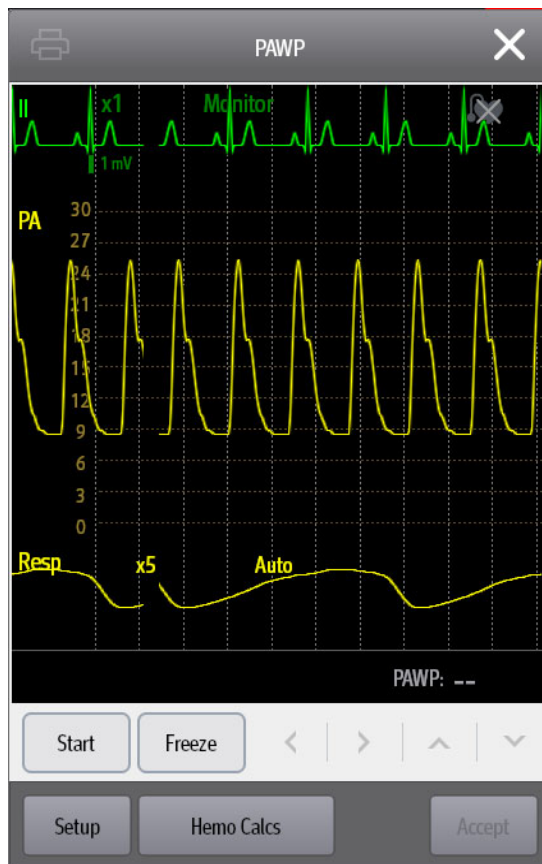

2. Wedge the flotation catheter into the pulmonary artery by observing the PA waveform changes on the screen, referring to the following figure.

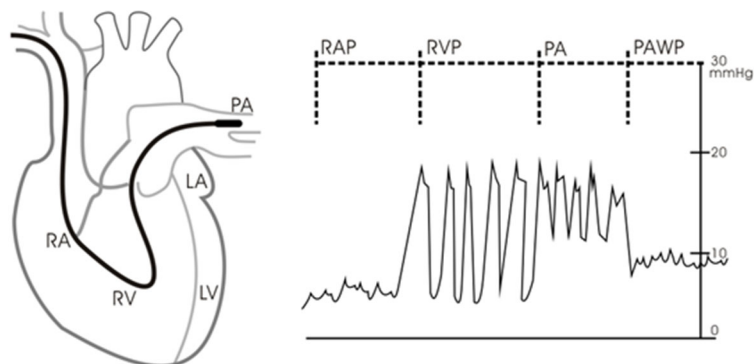

3. Select **Start**.
4. Inflate the balloon and pay attention to PA waveform changes on the screen when the prompt message **Ready For Balloon Deflation** appears.

5. Deflate the balloon when the prompt message **Ready For Balloon Deflation** appears. If the PA waveform is stable, but the monitor is still not showing the prompt message **Ready For Balloon Deflation**, select **Freeze** to freeze the waveform, and deflate the balloon.
6. Select **Accept** to save the PAWP value.
7. If you need to start a new measurement, repeat step 3 to step 6.

If the measurement fails or you need to adjust the PAWP value, you can use the following buttons to adjust the PAWP waveform and measurement.

- Select the up or down arrow button to adjust the PAWP value.
- Select the left or right arrow button to view the frozen waveforms of 40 seconds.
- Select **Accept** to save the PAWP value.

WARNING

- **Prolonged inflation can cause pulmonary hemorrhage, infarction or both. Inflate the balloon for the minimum time necessary to get an accurate measurement.**
- **If the PAWP is greater than the PA (systolic), deflate the balloon and report the incident in accordance with hospital policy. Because the pulmonary artery could be accidentally ruptured, and the PAWP value derived will not reflect the patient's hemodynamic state, but will merely reflect the pressure in the catheter or balloon.**
- **If the flotation/thermodilution catheter drifts into the wedge position without inflation of the balloon, the PA waveform assumes a wedged appearance. Take appropriate action, in accordance with standard procedures, to correct the situation.**

NOTE

- **The PA alarm is turned off automatically when the monitor enters the PAWP screen.**

15.7.4 Setting the Waveforms of the PAWP Screen

On the **PAWP** screen, select **Setup** to enter the **PAWP Setup** dialog. In the **PAWP Setup** dialog, you can make the following settings:

- Select **Reference Waveform 1** to set an ECG lead wave as the first reference wave.
- Select **Reference Waveform 2** to set a respiration wave as the second reference wave.
- Select **Speed** to set a sweep speed for the displayed waveforms on the **PAWP** screen.
- Select **Scale** to set the size of the PA waveform on the **PAWP** screen.

15.7.5 Performing Hemodynamic Calculation

On the **PAWP** screen, select **Hemo Calcs** to enter the **Calculations** dialog. For more information, see *28.4 Hemodynamic Calculations*.

15.8 Connecting a Camino Device

The IBP module can interface with the Camino multi-parameter monitor (Model: MPM-1) to measure intracranial pressure (ICP).

To connect the Camino, follow this procedure:

1. Plug the IBP module into the module rack.
2. Connect the Camino ICP cable to the IBP module.
3. Connect the Camino ICP cable to the ICP adapter.
4. Connect the ICP connector to the ICP adapter.
5. Connect the Camino cable to the Camino monitor.

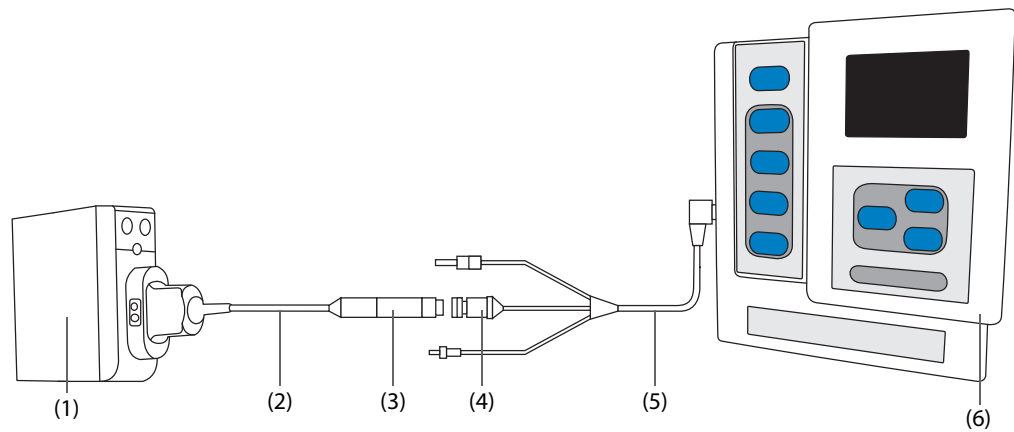

- (1) IBP module
- (2) Camino ICP cable
- (3) ICP adapter
- (4) ICP connector
- (5) Camino cable
- (6) Camino monitor

WARNING

- Refer to the Camino Operator’s Manual to adjust settings and connect the monitor with the patient.
- ICP alarm settings on the Mindray patient monitor are independent of the Camino monitor alarm settings, and thus may be different. Please pay special attention to the alarms on the Camino monitor.

15.9 IBP Troubleshooting

This section lists the problems that might occur. If you encounter the problems when using the equipment or accessories, check the table below before requesting service. If the problem persists, contact your service personnel.

NOTE

- For the physiological and technical alarm messages, see Appendix D Alarm Messages.

Problem	Solution
Cannot see IBP numeric area or waveform area on the main screen	<ol style="list-style-type: none"> 1. Check that the IBP is set to display in the Screen Setup dialog. For more information, see 3.9.2 <i>Displaying Parameter Numerics and Waveforms</i>. 2. Check that if the IBP parameter switch is enabled. If not, enable the IBP measurement. For more information, see 3.9.1 <i>Switching On or Off a Parameter</i>. 3. Check the connection of IBP cable, IBP transducer and monitor. 4. Check that the three-way valve is turned to the correct position. 5. Check that the IBP transducer has been zeroed. For more information, see 15.3.3 <i>Zeroing the IBP transducer</i>.
Cannot see systolic pressure and diastolic pressure for P1/P2/P3/P4	Set Measure to All in the P1/P2/P3/P4 setup page. For more information, see 15.6.3 <i>Setting the Pressure Type for Display</i> .
IBP readings seem unstable	<ol style="list-style-type: none"> 1. Make sure there are no air bubbles in the transducer systems. 2. Check that the transducer is properly fixed. 3. Zero the transducer again. 4. Replace the transducer.

Problem	Solution
Zeroing of IBP channel(s) fails.	<ol style="list-style-type: none"> 1. Ensure that the channels are open to air. 2. Perform zero calibration again. Do not sway the IBP transducer and tubing during zero calibration. For more information, see <i>15.3.3 Zeroing the IBP transducer</i>. 3. If zero calibration still fails, replace the transducer.

16 Monitoring Cardiac Output (C.O.)

16.1 C.O. Introduction

The cardiac output (C.O.) measurement invasively measures cardiac output and other hemodynamic parameters using the right heart (atria) thermodilution method. A cold solution of known volume and temperature is injected into the right atrium through the proximal port of a pulmonary artery (PA) catheter. The cold solution mixes with the blood in the right ventricle and the change in blood temperature is measured with a thermistor at the distal end of the catheter in the pulmonary artery. The temperature change is displayed as a curve on the C.O. split screen, and the monitor calculates the C.O. value from this curve. The C.O. value is inversely proportional to the area under the curve. As cardiac output varies continuously, a series of measurements must be carried out to achieve a reliable C.O. average value. Always use the average of multiple thermodilution measurements for therapy decisions. The monitor is capable of storing 6 measurements.

C.O. monitoring is intended for adult patients only.

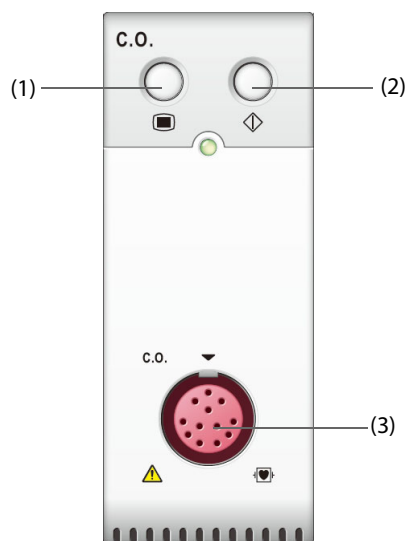

(1) C.O. dialog hard key

(2) C.O. measure dialog hard key

(3) C.O. cable connector

16.2 C.O. Safety Information

WARNING

- **The C.O. measurement results may be erroneous during electrosurgery.**
 - **All invasive procedures involve risks to the patient. Use aseptic technique and follow catheter manufacturer's instructions.**
 - **Use only accessories specified in this manual. Make sure that the accessories never come into contact with conductive parts.**
 - **C.O. monitoring is not intended for pediatric and neonatal patients.**
-

16.3 C.O. Measurement Limitations

The following factors may influence the accuracy of C.O. measurement:

- temperature of injectate solution
- volume of injectate solution
- baseline of patient's blood temperature
- patient's inspiratory/expiratory cycle
- placement of catheter with relation to proximity of lung field
- the catheter itself
- patient's heart rate and hemodynamic status
- any solution infused with intravenous injection during the C.O. measurement

To obtain accurate C.O. measurements, follow these recommendations:

- Temperature of injectate solution must be at least 10 °C cooler than that of the patient's blood.
- Inject solution at end of expiration.
- Inject solution rapidly and smoothly.
- Finish injection within four to five seconds.

16.4 C.O. Display

The C.O. display shows only C.O., C.I. (cardiac index), and TB (blood temperature) in the C.O. numeric area.



(1) C.O. label

(2) Primary parameter unit

(3) Labels and values for primary parameters

(4) Labels and values for secondary parameters

NOTE

- The C.O. value is invalid if it is displayed in outline font.

16.5 C.O. Equipment to Patient Connection

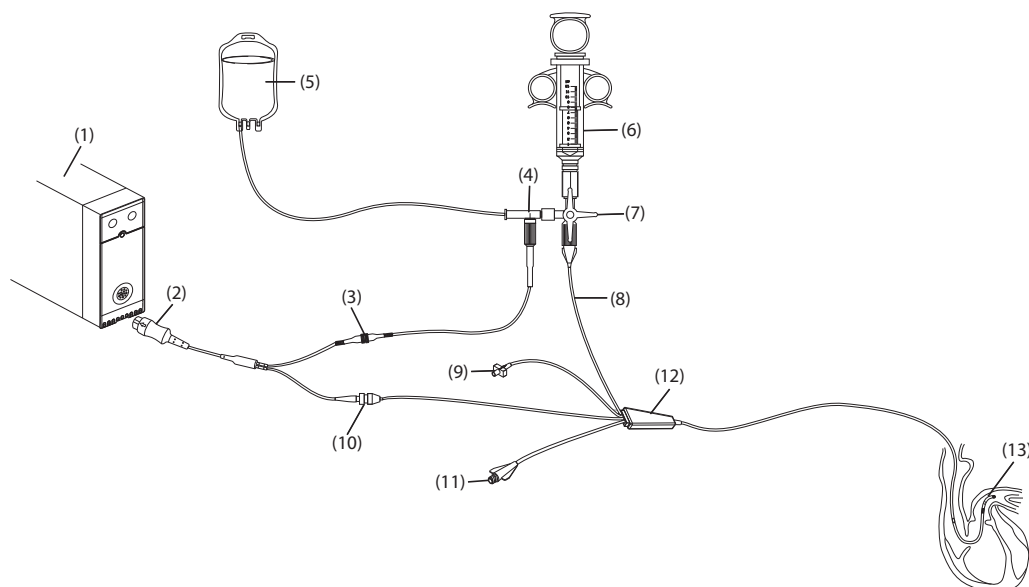

- | | | |
|---------------------------|---------------------------------------|--------------------------------|
| (1) C.O. module | (2) 12-pin C.O. cable (Model: CO7702) | (3) TI cable connector |
| (4) In-line probe | (5) Injectate solution | (6) Injectate syringe |
| (7) Three-way valve | (8) Proximal injectate port | (9) Balloon inflation valve |
| (10) Thermistor connector | (11) PA distal port | (12) Thermomodulation catheter |
| (13) Thermistor | | |

16.6 Performing C.O. Measurement

16.6.1 Preparing for C.O. Measurement

1. Connect the C.O. cable to the C.O. module and thermistor connector, making sure the C.O. numeric area is displayed on the monitor's main screen.
2. Follow the hospital's policy and procedures to prepare the patient for the C.O. measurement.
3. Follow the manufacturer's instructions to set up the catheter and other accessories.
4. Check that all the accessories are properly connected.
 - **For an in-line probe setup, make sure the in-line sensor is securely connected to the tubing. For the bath probe setup, make sure the bath probe is correctly sensing the injectate temperature.**

16.6.2 Setting C.O. Measurement

Before performing the C.O. measurement, follow this procedure:

1. Select the C.O. numeric area to enter the **C.O. Measure** dialog.
2. Select the **Setup**.
3. Perform the following check or setup:
 - ◆ Check if the height and weight are appropriate for your patient. Change if necessary. The patient's height and weight values are required for determining cardiac index (C.I.).
 - ◆ Check that the correct computation constant is entered. The computation constant has a close relationship with the entered injectate volume, injectate probe type (in-line probe or bath probe) and temperature. See the Instructions for Use of the pulmonary artery catheter to determine correctness. To change the computation constant, select **Comp Const** and then input the correct value. When a

new catheter is used, the computation constant should be adjusted in accordance with the manufacturer's instructions for use.

- ◆ Switch on or off **Auto TI**. If **Auto TI** is switched on, the system automatically detects the injectate temperature, and **TI** setting is disabled. If **Auto TI** is switched off, you need to input the injectate temperature at **TI**.
- ◆ Switch on or off **Auto Start**. If **Auto Start** is switched on, the monitor automatically takes the C.O. measurement after establishing a baseline of blood temperature. If **Auto Start** is switched off, you need to click the **Start** button in the **C.O. Measure** dialog for a new measurement.

16.6.3 Performing C.O. Measurement

To perform the C.O. measurement, follow this procedure:

1. Select the C.O. numeric area to enter the **C.O. Measure** dialog.

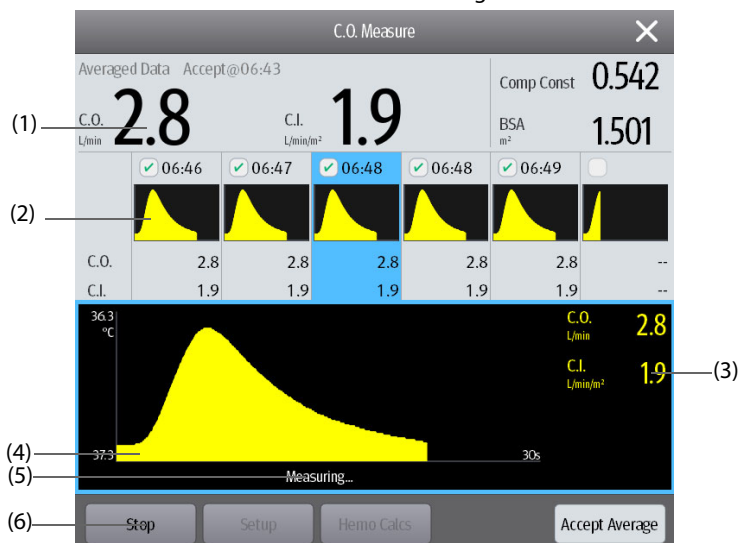

- | | |
|--------------------------------|------------------------------------|
| (1) Average values | (2) Historical measurement dialogs |
| (3) Current measurement values | (4) Current C.O. curve |
| (5) Prompt message area | (6) Buttons |

2. Proceed as follows to perform the C.O. measure:

- ◆ If **Auto Start** is switched off, select the **Start** button, and then inject the solution quickly when you see the message **Please Wait**. As shown in the figure above, during the measurement, the currently measured thermodilution curve is displayed. At the end of the measurement, the thermodilution curve is transferred to one of the 6 measurement areas and the monitor prompts you to wait for a certain period of time before starting a new measurement.
- ◆ If **Auto Start** is switched on, inject the solution quickly when you see the message **Ready For New Set Of Measurement**. The monitor consecutively takes C.O. measurements automatically without the need for pressing the **Start** button between two measurements. A new thermodilution measurement is possible as soon as the message **Inject Now!** is displayed on the screen. The monitor automatically detects further thermodilution measurements.

3. Acquire the average value of C.O. and C.I. A maximum of 6 measurements can be stored. If you perform more than six measurements without rejecting any, the oldest will automatically be deleted when a seventh curve is stored. Select from the 6 measurement curves and the system will automatically calculate and display the averaged C.O. and C.I. values. Then select the **Accept Average** button to accept and store the averaged values.

When injecting, the stopcock to the thermodilution catheter is open and the stopcock to the injectate solution is closed. After completing the measurement, turn off the stopcock to the thermodilution catheter and turn on the stopcock to the injectate solution, and then draw the injectate solution into the injectate syringe.

The button area also provides you with the following functions:

- Select **Stop** to stop the current measurement. Select **Setup** to enter the **C.O.** dialog.
- Select **Hemo Calcs** to enter the **Calculations** dialog.

NOTE

- **Starting a measurement without blood temperature being stable may cause measurement failure.**
- **The TB alarms are inactivated during a C.O. measurement, and will be reactivated automatically after the completion of C.O. measurement.**
- **Please see the Instructions for Use of thermodilution catheter to determine the Comp Const and the volume of injectate solution.**

16.7 Changing C.O. Settings

16.7.1 Setting C.O. Alarm Properties

To set the C.O. alarm properties, follow this procedure:

1. Select the C.O. numeric area to enter the **C.O. Measure** dialog.
2. Select **Setup** to enter the **C.O.** dialog.
3. Select the **Alarm** tab.
4. Enter the password if required. For more information, refer to 33.14.3 *Selecting Password for User Authentication*.
5. Set the alarm properties as desired.

16.8 C.O. Troubleshooting

This section lists the problems that might occur. If you encounter the problems when using the equipment or accessories, the table below may help with troubleshooting before requesting a service personnel visit. If the problem persists, contact your service personnel.

NOTE

- **For the physiological and technical alarm messages, see Appendix D Alarm Messages.**

Problem	Solution
Do not see C.O. numeric area on the main screen	<ol style="list-style-type: none"> 1. Check that the C.O. is set to display in the Screen Setup dialog. For more information, see 3.9.2 <i>Displaying Parameter Numerics and Waveforms</i>. 2. Check that if the C.O. parameter switch is enabled. If not, enable the C.O. measurement. For more information, see 3.9.1 <i>Switching On or Off a Parameter</i>. 3. Check that the patient type is adult. 4. Check the connection of C.O. cable, thermodilution catheter and TI sensor.
C.O. value is inaccurate	<ol style="list-style-type: none"> 1. Check that the thermodilution catheter is positioned properly. 2. Check that the computational constant is proper for current injectate temperature, injectate volume and injectate probe type. 3. Inject solution rapidly and smoothly. 4. Finish injection within four to five seconds. 5. Inject more volume, or inject colder solution. 6. Check that the height and weight of patient is properly configured. 7. If Auto TI is switched off, check that the entered temperature is correct.

Problem	Solution
C.O. measurement fails	<ol style="list-style-type: none">1. Inject more volume, or inject colder solution. Make sure that the injectate temperature is at least 10°C colder than the patient blood temperature.2. Finish injection within four to five seconds.3. Check the connection of C.O. cable, thermodilution catheter and TI sensor.

17 Monitoring Central Venous Oxygen Saturation (ScvO₂)

17.1 ScvO₂ Introduction

Central venous oxygen saturation (ScvO₂) is measured across spectrophotometry. Spectrophotometry involves the use of light emitting diodes (LED) that produce light of various wavelengths in red and infrared spectra. The light is transmitted to the blood through a fiberoptic in the probe, reflected off the red blood cells and transmitted back through a separate fiberoptic to an optical module. The central venous oxygen saturation is calculated through the analysis of the reflected spectra.

ScvO₂ monitoring is intended for adult and pediatric patients.

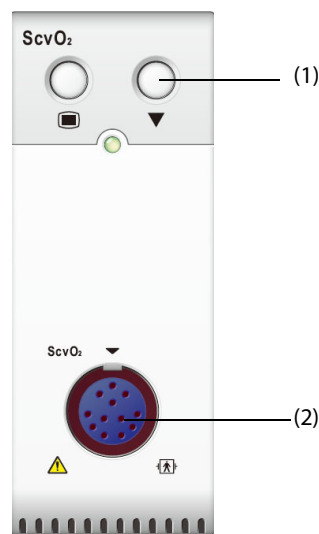

(1) Calibration hard key

(2) CeVOX cable connector

17.2 ScvO₂ Safety Information

WARNING

- ScvO₂ monitoring is not intended for neonatal patients.

17.3 ScvO₂ Display

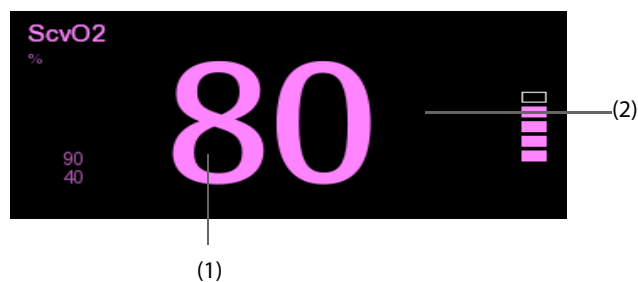

(1) ScvO₂ value

(2) SQI bar graph

17.4 Accessing the On-screen ScvO₂ Guide

The monitor provides the on-screen ScvO₂ guide to help you understand ScvO₂ monitoring principles, functions, and operating procedure. To access the on-screen ScvO₂ guide, follow this procedure:

1. Select the ScvO₂ numeric area to enter the **ScvO2** dialog.
2. Select the **Introduction** tab.
3. Select the desired tab of **Summary**, **Target Patients**, **Points To Note**, or **Operation Guides**.

17.5 ScvO₂ Equipment to Patient Connection

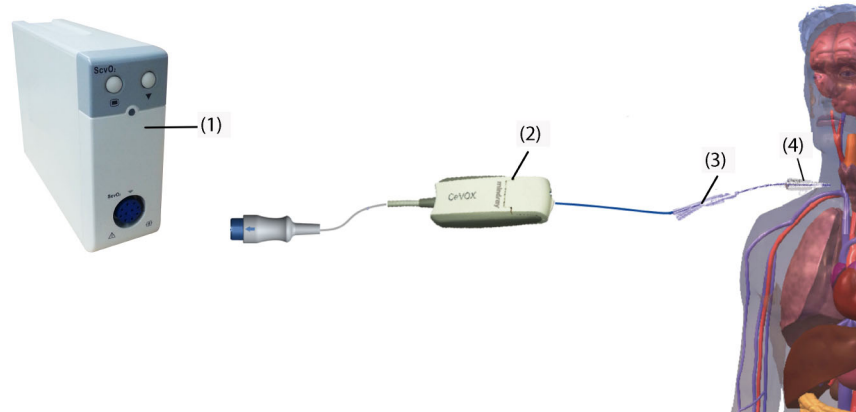

(1) ScvO₂ module

(2) CeVOX optical module

(3) CeVOX fiberoptic probe

(4) Central venous catheter

17.6 Measuring ScvO₂

To perform the ScvO₂ measurements, follow this procedure:

1. Apply the central venous catheter.
2. Place one end of the fiberoptic probe into the central venous catheter through the distal lumina, and connect the other end to the CeVOX optical module.
3. Plug the CeVOX cable into the ScvO₂ module.
4. If you see the message **Calibration Required**, calibrate the ScvO₂ before performing the measurements. For more information, see *17.7 ScvO₂ Calibration*.
5. Check the reading in the ScvO₂ numeric area.

WARNING

- **To avoid application failure, ensure that the proper fiberoptic probe is selected.**
 - **The monitor may only be regarded as a device providing early warning. If there is an indication of a trend towards de-oxygenation of the patient, blood samples must be taken and tested on a laboratory oximeter in order to arrive at a decision concerning the condition of the patient.**
 - **Incorrect placement of the fiberoptic probe can lead to vessel perforation. Therefore, check the correct position of the probe as indicated in the probe's instructions for use.**
-

17.7 ScvO₂ Calibration

Regular in vivo calibration is required using blood gas analysis of a central venous blood sample to ensure accurate measurement of continuous ScvO₂. For optimal accuracy, it is recommended that an in vivo calibration be performed at least every 24 hours or if hemoglobin is changing (for more details, check the notes below).

To perform calibration, follow this procedure:

1. Check the central venous catheter and CeVOX probe for proper placement.
2. Check the quality of the signal. The Signal Quality Indicator (SQI) is used for assessing the quality of fiberoptical signals during probe placement, calibration and measurement. The signal quality is indicated by bars of different height levels. Generally, the higher the level, the better the signal.
3. Withdraw a sufficient amount of central venous blood from the side port of the CeVOX probe to avoid intermixture of infusion/injection with the withdrawn blood.
4. Slowly withdraw 2ml blood from the side port of the CeVOX probe. Do not pull too strongly in order to avoid a hemolysis.
5. Immediately confirm by selecting **Sample Drawn** in the **Calibration** page of the **ScvO2** dialog.
6. If necessary put blood sample on ice and perform an analysis by a blood gas analysis device or a laboratory oximeter.
7. Input lab values for Hb, Hct, and ScvO₂ and select **Calibrate** to confirm.

NOTE

- **The SQI signal can be affected by the presence of electrosurgical units. Keep electrocautery equipment and cables away from the monitor and use separate power socket if possible.**
 - **To achieve optimal accuracy, it is recommended that the entered hemoglobin and hematocrit values are updated when there is a change of 6% or more in hematocrit, or of 1.8 g/dl (1.1 mmol/l) or more in hemoglobin. A change in hemoglobin may also affect SQI.**
 - **Dye (e.g. Indocyanine Green) or other substances, containing dyes which usually modify the light absorption capacities, can lead to faulty measurement values of the oxygen saturation.**
-

17.8 Accessing the HemoSight Dialog

To accessing the **HemoSight** dialog, follow this procedure:

1. Select the ScvO₂ numeric area to enter the **ScvO2** dialog.
2. Select the **HemoSight** button. For information on HemoSight, see 27.8 *HemoSight™*.

17.9 Changing ScvO₂ Settings

17.9.1 Changing ScvO₂ Alarm Settings

To change the ScvO₂ alarm settings, follow this procedure:

1. Select the ScvO₂ numeric area to enter the **ScvO2** dialog.
2. Select the **Alarm** tab.
3. Enter the password if required. For more information, refer to 33.14.3 *Selecting Password for User Authentication*.
4. Set the alarm properties as desired.

17.9.2 Setting Hb or Hct

To set the Hb or Hct, follow this procedure:

1. Select the ScvO₂ numeric area to enter the **ScvO2** dialog.
2. Select the **Calibration** tab.
3. Set **Hb** or **Hct**.

17.9.3 Inputting the SaO₂ Value

The monitor computes the DO₂ and VO₂ using the SaO₂ value. To input the SaO₂ value, follow this procedure:

1. Select the ScvO₂ numeric area to enter the **ScvO2** dialog.
2. Select the **Setup** tab.
3. Input the **SaO2** value.

18 Monitoring CCO/SvO₂

18.1 CCO/SvO₂ Introduction

The Edwards Lifesciences Vigilance II monitor, Vigileo monitor, EV1000 monitor, and HemoSphere monitor, measure continuous cardiac output (CCO), mixed venous oxygen saturation (SvO₂), central venous oxygen saturation (ScvO₂) etc. They also calculate hemodynamic and oxygenation parameters. The N Series monitors can be connected to the Vigilance II/Vigileo/EV1000/HemoSphere monitors and can display, store, and review the measured and calculated parameter values from these monitors. The N Series monitors can also give alarms of these measured parameters; however, you must set alarm on/off, alarm limits, alarm priority, and alarm record separately on the N Series monitors. The alarm is On by default.

The CCO/SvO₂ module is only intended for adult and pediatric patients.

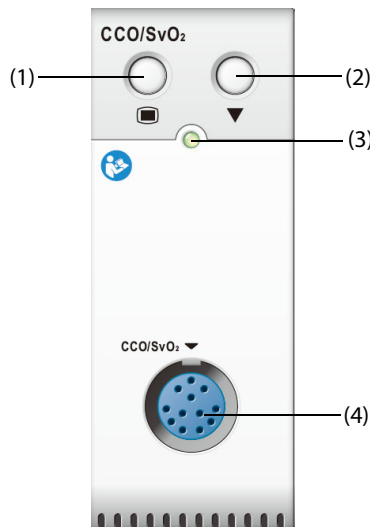

(1) CCO/SvO₂ dialog hard key

(2) Calibration key (for Vigilance II and Vigileo monitor)

(3) Module status indicator

(4) CCO/SvO₂ cable connector

18.2 CCO/SvO₂ Safety Information

WARNING

- Because the alarm limits of the relevant measured parameters can be set on the N Series monitors, the alarms of these parameters may be different from those on the Vigilance II/Vigileo/EV1000/HemoSphere monitors. Please pay special attention to the alarms on the Vigilance II/Vigileo/EV1000/HemoSphere monitors.
 - The CCO/SvO₂ monitoring is not intended for neonatal patients.
-

CAUTION

- Observe the operator's manuals of Vigilance II/Vigileo/EV1000/HemoSphere monitor to configure settings and to connect the monitor to the patient.
 - The N Series monitors give disconnection alarms when being disconnected from the Vigilance II/Vigileo/EV1000/HemoSphere monitors. These alarms may be delayed.
-

NOTE

- The Vigilance II monitor, Vigileo monitor, EV1000 monitor, and HemoSphere monitor are manufactured and trademarked by Edwards Lifesciences, and they provide the technology for measuring and calculating the relevant parameters. Mindray only provides a connection and interface to display the parameters from the Vigilance II/Vigileo/EV1000/HemoSphere monitor on the N Series monitors. If you have any doubts about the operation and maintenance of the Vigilance II/Vigileo/EV1000/HemoSphere monitors, read the operator's manuals of the corresponding monitor, or contact Edwards Lifesciences (www.edwards.com) directly.
-

18.3 Connecting the Device

The CCO/SvO₂ cable is used to connect this monitor to the Vigilance II/Vigileo/EV1000/HemoSphere monitor.

18.3.1 CCO/SvO₂ Cable

The following figure shows the CCO/SvO₂ cable.

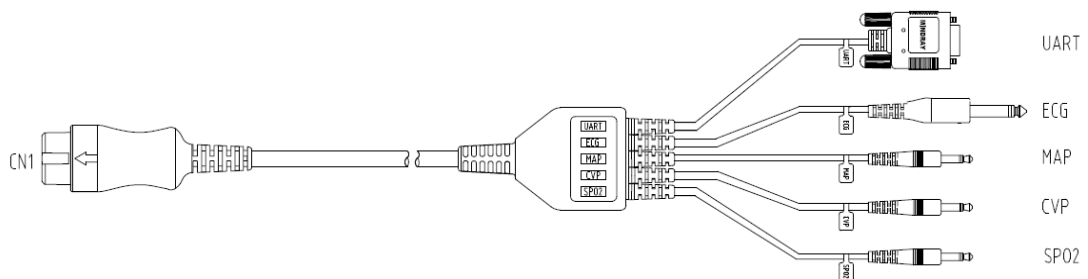

18.3.2 Connecting to the Vigilance II Monitor

The following figure shows the rear housing connectors of the Vigilance II monitor.

WARNING

- **Calibrate the Vigilance II monitor before monitoring. For more information, see the Vigilance II operator's manual for the calibration instructions.**
-
-

18.3.3 Connecting to the Vigileo Monitor

The following figure shows the rear housing connectors of the Vigileo monitor.

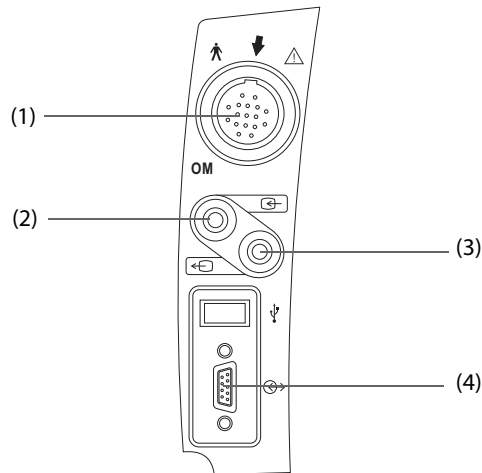

- | | |
|---------------------------------|------------------|
| (1) Patient Optical Module (OM) | (2) Analog Input |
| (3) Analog Input | (4) Serial Port |

To connect the Vigileo monitor, follow this procedure:

1. Insert the end of the CCO/SvO₂ cable marked CN1 to the Mindray CCO/SvO₂ module.
2. Insert the CVP signal end of the CCO/SvO₂ cable into the analog signal input port(2) on the rear housing of the Vigileo monitor.
3. Insert UART end of the CCO/SvO₂ cable into the serial port on the rear housing(4) of the Vigileo monitor.
4. Enter the **Serial Port Setup** menu of the Vigileo monitor, and make the following settings:
 - ◆ **Device: IFMout**
 - ◆ **Baud Rate: 19200**
 - ◆ **Parity: None**
 - ◆ **Stop Bits: 1**
 - ◆ **Data Bits: 8**
 - ◆ **Flow Control: 2 seconds**
5. Enter the **Analog Input Port Setup** menu of the Vigileo monitor, and set the CVP as follows:
 - ◆ **Parameter: CVP**
 - ◆ **Voltage Range: 0-5 v**
 - ◆ **Full Scale Range: 100 mmHg (13.3 kPa)**
 - ◆ **Simulated High Value: 100 mmHg (13.3 kPa)**
 - ◆ **Simulated Low Value: 0 mmHg (0.0 kPa)**

For more information, see the Vigileo operator's manual for the operation of the monitor.

WARNING

- **Calibrate the Vigileo monitor before monitoring. See the Vigileo operator's manual for the calibration instructions.**
-
-

18.3.4 Connecting the EV1000 Monitor

The following figure shows the rear housing of the EV1000 monitor.

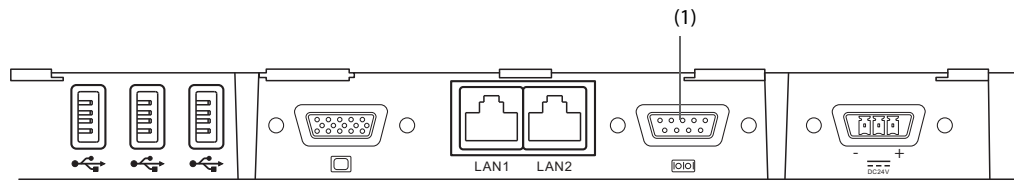

(1) serial port

To connect the EV1000 monitor, follow this procedure:

1. Insert the end of the CCO/SvO2 cable marked CN1 to the Mindray CCO/SvO2 module.
2. Insert UART into the serial port(1) on the rear housing of the EV1000 monitor.
3. Enter the **Serial Port Setup** menu of the EV1000 monitor, and make the following settings:
 - ◆ **Device: IFMout**
 - ◆ **Baud Rate: 19200**
 - ◆ **Parity: None**
 - ◆ **Stop Bits: 1**
 - ◆ **Data Bits: 8**
 - ◆ **Flow Control: 2 seconds**

For more information, see the EV1000 operator’s manual for the operation of the monitor.

WARNING

- **Calibrate the EV1000 monitor before monitoring. Refer to the EV1000 Operator’s Manual for the calibration instructions.**
-

18.3.5 Connecting the HemoSphere Monitor

The following figure shows the rear housing of the HemoSphere monitor.

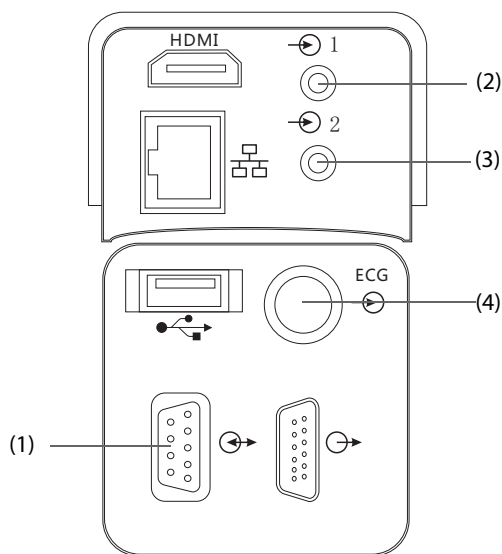

(1) COM1 Serial Port

(2) Analog Input

(3) Analog Input

(4) ECG Input

To connect the HemoSphere monitor, follow this procedure:

1. Connect CN1 with the CCO/SvO₂ cable connector of the CCO/SvO₂ module.
2. Insert the UART signal end of the CCO/SvO₂ cable into the COM1 serial port on the rear housing of the HemoSphere monitor.
3. Insert the CVP and MAP signal ends of the CCO/SvO₂ cable into the Analog Inputs on the rear housing of the HemoSphere monitor.
4. Insert ECG signal end of the CCO/SvO₂ cable into the ECG Input on the rear housing of the HemoSphere monitor.
5. Enter the **Serial Port Setup** menu of the HemoSphere monitor, and make the following settings:
 - ◆ **Device: IFMout**
 - ◆ **Baud Rate: 19200**
 - ◆ **Parity: None**
 - ◆ **Stop Bits: 1**
 - ◆ **Data Bits: 8**
 - ◆ **Flow Control: 2 seconds**
6. Enter the **Analog Input Setup** menu of the HemoSphere monitor, and set as follows:

Parameter	MAP	CVP
Voltage Range	0-5 v	0-5 v
Full Scale Range	500 mmHg (66.7 kPa)	100 mmHg (13.3 kPa)
Simulated High Value	500 mmHg (66.7 kPa)	100 mmHg (13.3 kPa)
Simulated Low Value	0 mmHg (0.0 kPa)	0 mmHg (0.0 kPa)

For more information, see the HemoSphere operator's manual for the operation of the monitor.

WARNING

- **Calibrate the HemoSphere monitor before monitoring. Refer to the HemoSphere Operator's Manual for the calibration instructions.**
-

18.4 Accessing the HemoSight dialog

To access the **HemoSight** dialog, follow this procedure:

1. Select the **CCO** numeric area to enter the **CCO** dialog.
2. Select the **HemoSight** button. For more information, see 27.8 *HemoSight™*.

18.5 Changing CCO Settings

18.5.1 Changing the CCO Alarm Settings

To change the CCO alarm settings, follow this procedure:

1. Select the CCO numeric area to enter the **CCO** dialog.
2. Select the **Alarm** tab.
3. Set the alarm properties of CCO and CCI.

18.5.2 Setting Parameters for Display

To set the parameters for display, follow this procedure:

1. Select the CCO numeric area to enter the **CCO** dialog.
2. Select the **Select Parameter** tab.
3. Select the primary and secondary parameters for display.

18.5.3 Setting the CCO Analog Output Signal

To set the CCO output signal, follow this procedure:

1. Select the CCO numeric area to enter the **CCO** dialog.
2. Select the **Signal Output Setup** tab.
3. Set the output signal as follows:
 - ◆ This monitor can output the analog signals of ECG waveform, MAP value, SpO₂ value and CVP value to the Vigilance II monitor. If a signal has several sources, you can select a source.
 - ◆ This monitor can output the CVP analog signal to the Vigileo monitor. If the CVP signal has several sources, you can select a source.
 - ◆ This monitor can output ECG waveform, MAP value, and CVP value to the HemoSphere monitor. If a signal has several sources, you can select a source.
 - ◆ Select **Simulated High Value** to output the simulated high value calibration signals to Vigilance II, Vigileo, or HemoSphere monitor. To stop outputting the simulated high value signal, select **Stop Cal Signal Output** where the **Simulated High Value** button was previously.
 - ◆ Select **Simulated Low Value** to output the simulated low value calibration signals to Vigilance II, Vigileo, or EV1000 monitor. To stop outputting the simulated low value signal, select **Stop Cal Signal Output** where the **Simulated Low Value** button was previously.

The following table shows values and voltages of the high and low value calibration signals.

Parameters	Parameter Values	Output Voltage
High Value Calibration Signals		
MAP	500 mmHg	5V
SpO ₂	100%	10V
CVP	100 mmHg	5V
Low Value Calibration Signals		
MAP	0 mmHg	0V
SpO ₂	0%	0V
CVP	0 mmHg	0V

CAUTION

- The calibration voltage of Vigilance II, Vigileo, EV1000, and HemoSphere monitor should be the same as the output voltage of this monitor. Otherwise, some parameter values may be incorrectly calculated.

NOTE

- See the operator's manuals of Vigilance II, Vigileo, EV1000, and HemoSphere monitors for the calibration instructions.

18.6 Changing SvO₂/ScvO₂ Settings

18.6.1 Changing the SvO₂/ScvO₂ Alarm Settings

To change the SvO₂/ScvO₂ alarm settings, follow this procedure:

1. Select the SvO₂/ScvO₂ numeric area to enter the **SvO2** or **ScvO2** dialog.
2. Select the **Alarm** tab.
3. Set the alarm properties of SvO₂/ScvO₂.

18.6.2 Setting the SvO₂/ScvO₂ Analog Output Signal

This monitor can output the analog signals to the Vigilance II/Vigileo/EV1000/HemoSphere monitor. To set the SvO₂/ScvO₂ analog output signal, follow this procedure:

1. Select the SvO₂ numeric area to enter the **SvO2** dialog; or select the ScvO₂ numeric area to enter the **ScvO2** dialog.
2. Select the **Signal Output Setup** tab.
3. Set the output signal as follows:
 - ◆ This monitor can output the analog signals of ECG waveform, MAP value, SpO₂ value and CVP value to the Vigilance II monitor. If a signal has several sources, you can select a source.
 - ◆ This monitor can output the CVP analog signal to the Vigileo monitor. If the CVP signal has several sources, you can select a source.
 - ◆ This monitor can output ECG waveform, MAP value, and CVP value to the HemoSphere monitor. If a signal has several sources, you can select a source.
 - ◆ Select **Simulated High Value** to output the simulated high value calibration signals to Vigilance II, Vigileo, or HemoSphere monitor. To stop output the simulated high value signal, select **Simulated High Value** again.
 - ◆ Select **Simulated Low Value** to output the simulated low value calibration signals to Vigilance II, Vigileo, or HemoSphere monitor. To stop output the simulated low value signal, select **Simulated Low Value** again.

The following table shows values and voltages of the high and low value calibration signals.

Parameters	Parameter Values	Output Voltage
High Value Calibration Signals		
MAP	500 mmHg	5V
SpO ₂	100%	10V
CVP	100 mmHg	5V
Low Value Calibration Signals		
MAP	0 mmHg	0V
SpO ₂	0%	0V
CVP	0 mmHg	0V

CAUTION

- **The calibration voltage of Vigilance II, Vigileo, EV1000, and HemoSphere monitor should be the same as the output voltage of this monitor. Otherwise, some parameter values may be incorrectly calculated.**

NOTE

- **See the operator's manuals of Vigilance II, Vigileo, EV1000, and HemoSphere monitors for the calibration instructions.**

18.7 CCO/SvO₂ Troubleshooting

This section lists the problems that might occur. If you encounter the problems when using the equipment or accessories, check the table below before requesting for services. If the problem persists, contact your service personnel.

NOTE

- For the physiological and technical alarm messages, see **Appendix D Alarm Messages**.

Problem	Solution
The numeric area does not display CCO values when the Vigilance II, Vigileo, EV1000, or HemoSphere monitor is connected.	<ol style="list-style-type: none">1. Check that the CCO is set to display in the Screen Setup → Tile Layout page. For more information, see 3.9.2 <i>Displaying Parameter Numerics and Waveforms</i>.2. Check that if the CCO parameter switch is enabled. If not, enable the CCO measurement. For more information, see 3.9.1 <i>Switching On or Off a Parameter</i>.3. Check that the Vigilance II, Vigileo, EV1000, or HemoSphere monitor is set properly as described in 18.3 <i>Connecting the Device</i>.4. Check the connection of CCO/SvO₂ cable. For more information, see 18.3 <i>Connecting the Device</i>.
Do not see ScvO ₂ or SvO ₂ numeric area on the main screen	<ol style="list-style-type: none">1. Check that the ScvO₂ or SvO₂ is set to display in the Screen Setup → Tile Layout page. For more information, see 3.9.2 <i>Displaying Parameter Numerics and Waveforms</i>.2. Check that if the ScvO₂ /SvO₂ parameter switch is enabled. If not, enable the ScvO₂ /SvO₂ measurement. For more information, see 3.9.1 <i>Switching On or Off a Parameter</i>.3. Check that the Vigilance II, Vigileo, EV1000, or HemoSphere monitor is set properly as described in 18.3 <i>Connecting the Device</i>.4. Check the connection of CCO/SvO₂ cable. For more information, see 18.3 <i>Connecting the Device</i>.

This page intentionally left blank.

19 Monitoring Carbon Dioxide (CO₂)

19.1 CO₂ Introduction

CO₂ monitoring is a continuous, non-invasive technique for determining the concentration of CO₂ in the patient's airway by measuring the absorption of infrared (IR) light of specific wavelengths. CO₂ has its own absorption characteristic and the amount of light passing the gas probe depends on the concentration of the measured CO₂. When a specific band of IR light passes through respiratory gas samples, some of IR light will be absorbed by the CO₂ molecules. The amount of IR light transmitted after it has been passed through the respiratory gas sample is measured with a photodetector. From the amount of IR light measured, the concentration of CO₂ is calculated.

CO₂ measurement is used to monitor the patient's respiratory status. The sidestream/Microstream CO₂ measurement takes a sample of the respiratory gas with a constant sample flow from the patient's airway and analyzes it with a remote CO₂ sensor built into the Sidestream or Microstream CO₂ module.

The sidestream CO₂ module can be configured with a paramagnetic oxygen sensor to measure O₂. The paramagnetic oxygen sensor measures oxygen based on its paramagnetic properties.

The sidestream and microstream CO₂ measurement can be used, with specified accessories, with intubated and non-intubated adult, pediatric, and neonatal patients. With intubated patients, a sample of the respiratory gas is drawn from the patient's breathing circuit through an airway adapter and a gas sampling line. With non-intubated patients, the gas sample is drawn through a nasal cannula.

Both sidestream and microstream CO₂ modules have the function of automatic barometric pressure compensation (the system automatically measures the barometric pressure to which the patient monitor is exposed).

CO₂ monitoring is intended for adult, pediatric and neonatal patients.

19.2 Identifying CO₂ Modules

The following figures show the controls and connectors of different CO₂ module.

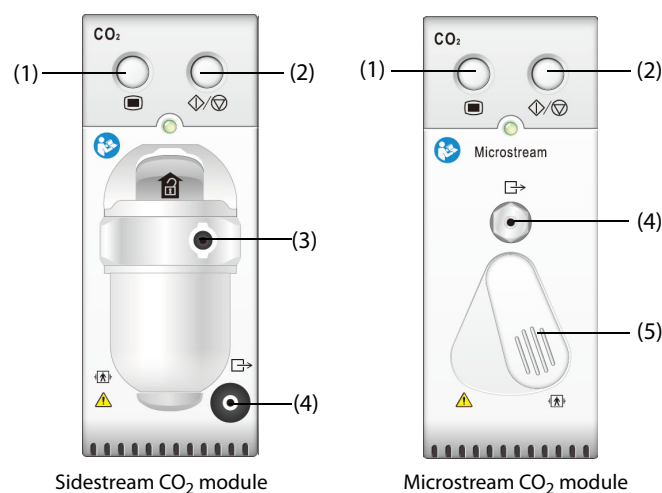

(1) CO₂ dialog hard key

(3) CO₂ watertrap seat

(5) Sample line connector

(2) CO₂ Measure/standby hard key

(4) Gas outlet

To measure CO₂ using the AG module, see *20 Monitoring Anesthetic Gas (AG)*.

19.3 CO₂ Safety Information

WARNING

- Route all tubing away from the patient's throat to avoid strangulation.
-

CAUTION

- Remove the airway sample line from the patient's airway while nebulized medications are being delivered. Measuring CO₂ during nebulization may lead to inaccurate CO₂ readings.
 - EtCO₂ values measured from the CO₂ module may differ from those from the blood gas analysis.
 - Avoid mechanical shock to the sidestream CO₂ module.
 - Shaking the CO₂ module during O₂ measurement may lead to a distorted O₂ waveform or inaccurate O₂ measurement
-

NOTE

- The CO₂ module automatically suppresses physiological alarms until breathing waves have been detected. Ensure that the patient is properly connected when using the CO₂ module.
-

19.4 CO₂ Measurement Limitations

The following factors may influence the measurement accuracy:

- Leaks or internal venting of sampled gas
- Mechanical shock
- Cyclic pressure up to 10 kPa (100 cmH₂O)
- Other sources of interference, if any

For more information, refer to *A.13.12 CO₂ Specifications*.

CAUTION

- Measurement accuracy of the sidestream CO₂ module may be affected by the breath rate and inspiration/expiration (I/E) ratio.
 - Measurement accuracy of the microstream CO₂ module may be affected by the breath rate.
-

19.5 CO₂ Display

The CO₂ numeric and waveform areas provide FiCO₂ measurement, EtCO₂ measurement, awRR measurement, and a CO₂ waveform.

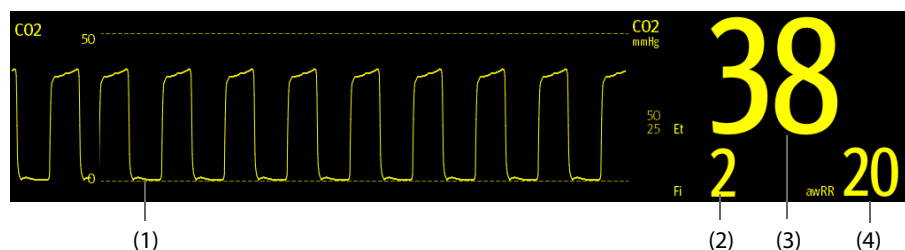

(1) CO₂ waveform

(2) Fraction of inspired CO₂ (FiCO₂)

(3) End tidal CO₂ value (EtCO₂)

(4) Airway respiration rate (awRR)

If the sidestream CO₂ module is configured with the oxygen sensor, O₂ waveform and parameters can be displayed in an O₂ numeric and waveform area as follows:

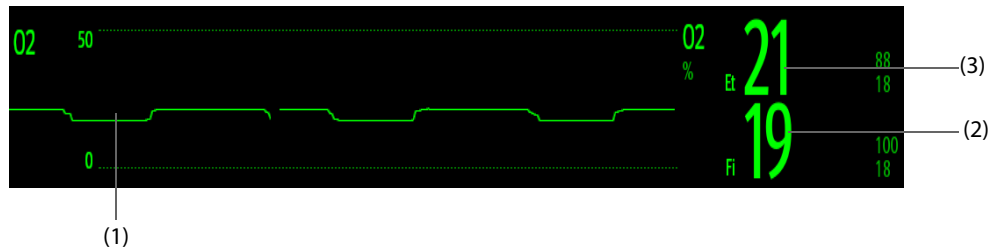

(1) O₂ waveform (2) FiO₂ measurement (3) EtO₂ measurement

19.6 Measuring CO₂ Using the Sidestream/Microstream CO₂ Module

19.6.1 Preparing to Measure CO₂ Using the Sidestream CO₂ Module

To prepare the CO₂ measurement, follow this procedure:

1. Select the appropriate gas sample line and watertrap according to the patient category.
2. Connect the watertrap to the CO₂ module, and connect the gas sample line to the watertrap.

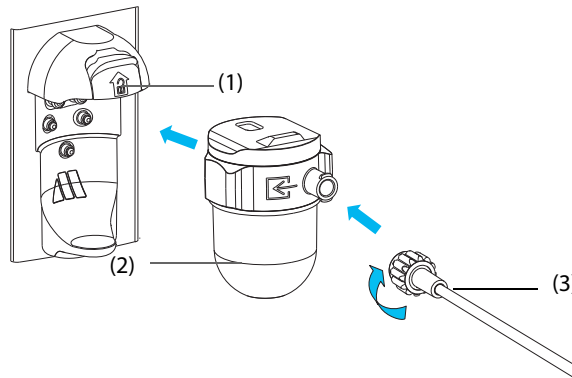

(1) Watertrap receptacle (2) DRYLINE II watertrap
(3) Gas sample line

3. Connect the other end of the gas sample line to the patient.
 - ◆ For intubated patients requiring an airway adapter, install the airway adapter between the patient circuit and the ventilator Y-piece.

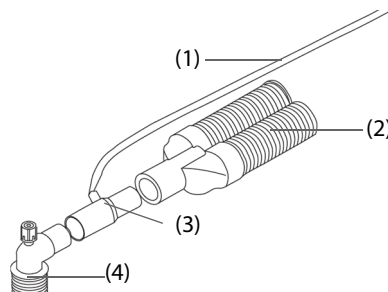

(1) Sample line (2) Connection to the ventilator
(3) Airway adapter (4) Connection to the patient

- ◆ For non-intubated patients, place the nasal cannula onto the patient.

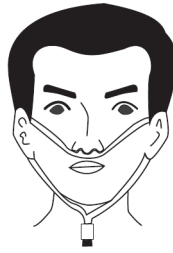

4. Connect the gas outlet to the scavenging system using an exhaust tube.

After the CO₂ module is connected, it enters measure mode by default and the monitor displays **CO2 Starting**. CO₂ can be measured after the start-up sequence is complete.

WARNING

- Do not use the adult or pediatric watertrap with a neonate patient. Otherwise, patient injury could result.
- Connect the gas outlet to the scavenging system when measuring CO₂ using the sidestream CO₂ module.

CAUTION

- Leakage in the breathing or sampling system may cause the displayed EtCO₂ values to be significantly low. Always make sure that all components are securely connected.
- Inspect the airway adapter for a tight connection and proper operation before attaching it to the patient.
- Squeezing or bending the sample line during sidestream or microstream CO₂ measurement may cause inaccurate CO₂ readings or no reading.
- To avoid blocking the airway, empty the DRYLINE II watertrap container whenever half full. Replacing the DRYLINE II watertrap once a month is recommended. Dispose of accumulated fluids in accordance with hospital policy or your local regulations.
- The DRYLINE II watertrap has a filter preventing bacterium, water and secretions from entering the module. Extended use could destroy the filter in watertrap and fail to stop the bacterium, water and secretions entering the module, result in damaging the gas module and having infection risk.

NOTE

- To extend the lifetime of the watertrap and module, disconnect the watertrap from the module and set the operating mode to Standby mode when CO₂ monitoring is not required.
- The sample rates are different when different types of watertraps are used.
- The emptying interval of the DRYLINE II adult/pediatric watertrap is 26 hours @ 120 ml/min, sample gas of 37 °C, room temperature of 23 °C, and 100% RH.
- The emptying interval of the DRYLINE II neonatal watertrap is 35 hours @ 90 ml/min, sample gas of 37 °C, room temperature of 23 °C, and 100% RH.

19.6.2 Preparing to Measure CO₂ Using the Microstream CO₂ Module

To prepare the CO₂ module for measurement, follow this procedure:

1. Connect one end of the sample line to the microstream CO₂ module.

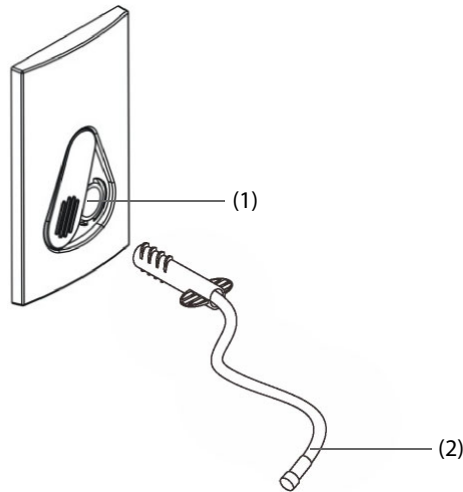

(1) Sample line connector

(2) Sample line

2. Connect the other end of the sample line to the patient.
 - ◆ For intubated patient requiring an airway adapter, install the airway adapter between the patient circuit and the ventilator Y-piece.
 - ◆ For non-intubated patient, place the nasal cannula onto the patient.
 - ◆ For patient prone to mouth breathing, place the oral-nasal cannula onto the patient.
3. Connect the gas outlet to the a scavenging system using an exhaust tube.

After the CO₂ module is connected, it enters measure mode by default and the monitor displays **CO₂ Sensor Warmup**. CO₂ can be measured after the start-up sequence is complete.

WARNING

- **Connect the gas outlet to the scavenging system when measuring CO₂ using the microstream CO₂ module.**

NOTE

- **Disconnect the sample line from the module when CO₂ monitoring is not required.**
-

19.6.3 Zeroing the Sidestream/Microstream CO₂ Module

The sidestream and microstream CO₂ modules perform a zero calibration automatically when needed. Once the zero calibration is started, the CO₂ module stops measuring and **“Zeroing”** is displayed in the CO₂ numeric area.

After the zero calibration is completed, the CO₂ module reacquires the CO₂ readings. During the reacquisition period, **“Zero Recovering”** is displayed in the CO₂ numeric area. Valid data will reappear 30 seconds after the zero calibration is started. You can hide the display of the **“Zero Recovering”** message, but values displayed during the reacquisition period may not be accurate. See [33.5.6 Hiding the Invalid Display after Zeroing the CO₂ Module](#) for more information.

The automatic zero calibration will not start under the following conditions:

- Physiological alarms related to CO₂ or AG are active.
- An apnea alarm is active.
- No breath has been detected for over 30 seconds.

You can also perform the zero calibration manually. For more information, see [33.5.5 Manually Zeroing the CO₂ Module](#).

19.7 Changing Settings for All CO₂ Modules

19.7.1 Changing CO₂ Alarm Settings

To change the CO₂ alarm settings, follow this procedure:

1. Select the CO₂ numeric area or waveform area to enter the **CO2** dialog.
2. Select the **Alarm** tab.
3. Enter the password if required. For more information, refer to 33.14.3 *Selecting Password for User Authentication*.
4. Set alarm properties as desired.

19.7.2 Setting the CO₂ Waveform

To set the CO₂ waveform, follow this procedure:

1. Select the CO₂ numeric area or waveform area to enter the **CO2** dialog.
2. Select the **Setup** tab.
3. Set **Waveform Type**, **Speed**, **Scale**, or **CO2 Scale** of the CO₂ waveform.

19.7.3 Setting the RR Source

To set the respiration rate (RR) source, follow this procedure:

1. Select the CO₂ numeric area or waveform area to enter the **CO2** dialog.
2. Select the **Setup** tab.
3. Set **RR Source**.

When you select **Auto**, the system automatically selects the RR source according to the priority. The priority of RR source is first CO₂, and then RM and ECG. When the current RR source does not have valid measurement, the system automatically switches the **RR Source** to **Auto**.

19.7.4 Entering the Standby Mode

Set the CO₂ module to one of the following modes according to the module status:

- Select **Measure** mode when using the CO₂ module for monitoring.
- Select **Standby** mode to prolong the CO₂ module service life when not using the CO₂ module.

The default operating mode is **Measure**. When not using the CO₂ module, proceed as follows to enter the Standby mode:

1. Select the CO₂ numeric area or waveform area to enter the **CO2** dialog.
2. Select the **Setup** tab.
3. Set **Operating Mode** to **Standby**.

19.7.5 Entering the Intubation Mode

When performing intubation during general anesthesia, enter the intubation mode to reduce unnecessary alarms. To enter the intubation mode, follow this procedure:

1. Select the CO₂ numeric area or waveform area to enter the **CO2** dialog.
2. Select **Intubation Mode**.

To exit the intubation mode, choose either of the following ways:

- From the bottom of the **CO2** dialog, select **Exit Intubation Mode**.
- Select the **Main Menu** quick key → from the **Alarm** column select **Exit Intubation Mode**.

For the details of the intubation mode, see 8.13 *Intubation Mode*.

NOTE

- **When the configured intubation period is over, the monitor automatically exits the intubation mode and gives two alert sounds.**

19.7.6 Setting the Auto Standby

The monitor enters standby mode automatically if no breath is detected after the configured period of time. To set the auto standby, follow this procedure:

1. Select the CO₂ numeric area or waveform area to enter the **CO2** dialog.
2. Select the **Setup** tab.
3. Set **Auto Standby**.

19.7.7 Setting Humidity Compensation

Sidestream and microstream CO₂ modules are configured to compensate CO₂ readings for either Body Temperature and Pressure, Saturated Gas (BTPS), to account for humidity in the patient's breath, or Ambient Temperature and Pressure, Dry Gas (ATPD).

- ATPD: $P_{CO_2}(mmHg) = CO_2(vol\%) \times P_{amb}/100$
- BTPS (sidestream): $P_{CO_2}(mmHg) = CO_2(vol\%) \times (P_{amb} - 47)/100$
- BTPS (microstream): $P_{CO_2}(mmHg) = CO_2(vol\%) \times (1 - 0.03) \times P_{amb}/100$

Where, $P_{CO_2}(mmHg)$ = partial pressure, $vol\%$ = CO₂ concentration, P_{amb} = ambient pressure, and unit is mmHg.

For the sidestream and microstream CO₂ module, set the humidity compensation on or off according to the actual condition.

To set the humidity compensation, follow this procedure:

1. Select the CO₂ numeric area or waveform area to enter the **CO2** dialog.
2. Select the **Setup** tab.
3. Set **BTPS Compensation**.
 - ◆ Switch on for BTPS.
 - ◆ Switch off for ATPD.

19.8 Changing O₂ Settings (For Sidestream CO₂ Module Integrating O₂)

19.8.1 Changing O₂ Alarm Settings

To change the O₂ alarm settings, follow this procedure:

1. Select the CO₂ numeric area or waveform area to enter the **CO2** dialog.
2. Select the **Alarm** tab.
3. Enter the password if required. For more information, refer to 33.14.3 *Selecting Password for User Authentication*.
4. Set alarm properties as desired.

19.8.2 Setting the O₂ Waveform

To set the O₂ waveform, follow this procedure:

1. Select the CO₂ numeric area or waveform area to enter the **CO2** dialog.
2. Select the **Setup** tab.
3. Set **Speed** and **O2 Scale** of the O₂ waveform.

19.9 Setting the Gas Compensation

The presence of interfering gas affects the CO₂ measurement. To get the best possible measurement result, it is recommended to set the gas compensation. The configured concentration of the interfering gas should be in accordance with its actual proportion.

For the microstream CO₂ module, gas compensations are not required.

CAUTION

- **Make sure to use the appropriate compensations. Inappropriate compensations may cause inaccurate measurement values and result in misdiagnosis.**
-

For the sidestream CO₂ module, follow this procedure to set the gas compensation:

1. Select the CO₂ numeric area or waveform area to enter the **CO2** dialog.
2. Select the **Setup** tab.
3. Set the compensation according to the actual condition.

19.10 Choosing a Time Interval for Peak-Picking

For microstream CO₂ modules, select a time interval for picking the highest CO₂ as the EtCO₂ and the lowest as the FiCO₂.

To set the time interval, follow this procedure:

1. Select the CO₂ numeric area or waveform area to enter the **CO2** dialog.
2. Select the **Setup** tab.
3. Set **Maximum Hold**.
4. Toggle between **Single Breath, 10 s** and **20 s**.
 - ◆ **Single Breath:** EtCO₂ and FiCO₂ are calculated for every breath.
 - ◆ **10 s and 20 s:** EtCO₂ and FiCO₂ are calculated using 10 or 20 seconds of data.

19.11 Performing the Leakage Test

When measuring CO₂ using the sidestream CO₂ module, the leakage test is required every time before the CO₂ measurement. To perform the CO₂ leakage test, follow this procedure:

1. Connect the measuring accessories as per section *19.6.1 Preparing to Measure CO₂ Using the Sidestream CO₂ Module*.
2. Wait until the startup finishes. Completely block the gas inlet on the sidestream CO₂ module. The alarm message "**CO2 Airway Occluded**" will appear on the screen.
3. Continue to block the gas inlet for another one minute.
4. Select the **Main Menu** quick key → from the **System** column select **Maintenance** → input the required password → select .
5. Select the **Module** tab → **CO2** tab.
6. Check that the current flow rate is less than 10ml/min, and the alarm message "**CO2 Airway Occluded**" does not disappear.

This indicates that the module does not leak. If the alarm message disappears, or the flow rate is equal to 10ml/min or greater, it indicates that the module leaks. Perform the leakage test again. If the problem remains, contact your service personnel for help.

19.12 CO₂ Calibration

For sidestream and microstream CO₂ modules, a calibration is needed every year or when the measured values have a great deviation.

To calibrate the CO₂ module, contact your service personnel.

CAUTION

- Connect the gas outlet to the scavenging system when calibrating the CO₂ module.
-

19.13 Test Method Used to Determine the Respiration Rate Measuring Range

To determine the RR measurement range, follow this procedure:

1. Connect the 5% CO₂ + N₂ (BAL) gas cylinder, reduction valve, rhythm generator and gas sampling path of a monitor.
2. Respectively set the rhythm generator to generate a respiration rate of 0 rpm, 6 rpm, 20 rpm, 60 rpm, 120rpm, and 150 rpm.
3. Verify that it meets the specifications.

NOTE

- The rhythm generator mentioned above is a sensor/sampling site in Figure 201.101 – Test apparatus for the TOTAL SYSTEM RESPONSE TIME of an RGM of ISO 80601-2-55.
-

19.14 CO₂ Troubleshooting

This section lists the problems that might occur. If you encounter the problems when using the equipment or accessories, check the table below before requesting service. If the problem persists, contact your service personnel.

NOTE

- For the physiological and technical alarm messages, see Appendix D Alarm Messages.
-

19.14.1 Troubleshooting the Sidestream/Microstream CO₂ Module

Problem	Solution
EtCO ₂ measurements too low	<ol style="list-style-type: none">1. Check the patient status.2. Check the sample line and connectors for leakage.3. Ventilate the room if the environmental CO₂ concentration is too high.

19.15 Oridion Information

Microstream

Oridion Patents

This posting serves as notice under 35 U.S.C.§287(a) for Covidien patents: <http://www.covidien.com/patents>.

No Implied License

Possession or purchase of this device does not convey any express or implied license to use the device with unauthorized CO₂ sampling consumables which would, alone, or in combination with this device, fall within the scope of one or more of the patents relating to this device and/or CO₂ sampling consumable.

This page intentionally left blank.

20 Monitoring Anesthetic Gas (AG)

20.1 AG Introduction

The anesthetic gas (AG) module measures the patient's anesthetic and respiratory gases by connecting to the airway of intubated patients or collecting the gases with specified accessories. It also incorporates the features of the O₂ module and BIS module.

The AG module determines the concentration of certain gases using the infrared (IR) light absorption measurement. The gases that can be measured by the AG module absorbing IR light. Each gas has its own absorption characteristic. The gas is transported into a sample cell, and an optical IR filter selects a specific band of IR light to pass through the gas. For multiple gas measurements, there are multiple IR filters. The higher the concentration of gas in a given volume, the more IR light is absorbed. This means that higher concentration of IR absorbing gas causes a lower transmission of IR light. The amount of IR light transmitted after it has been passed through an IR absorbing gas is measured. From the amount of IR light measured, the concentration of gas present can be calculated.

Oxygen does not absorb IR light as other breathing gases and is therefore measured relying on its paramagnetic properties. Inside the O₂ sensor are two nitrogen-filled glass spheres mounted on a strong rare metal taut-band suspension. This assembly is suspended in a symmetrical non-uniform magnetic field. In the presence of paramagnetic oxygen, the glass spheres are pushed further away from the strongest part of the magnetic field. The strength of the torque acting on the suspension is proportional to the oxygen concentration. From the strength of the torque, the concentration of oxygen is calculated.

AG monitoring is intended for adult, pediatric and neonatal patients.

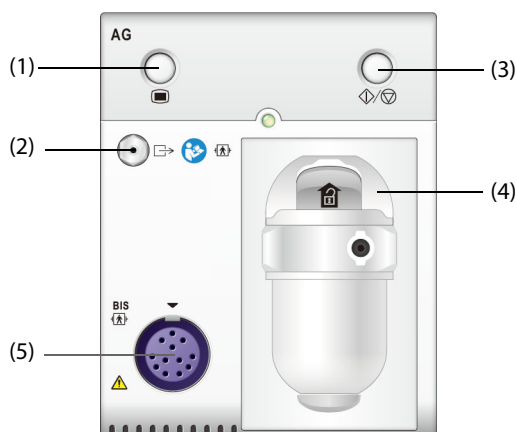

- (1) AG dialog hard key
- (2) Gas outlet
- (3) AG Measure/standby hard key
- (4) Watertrap seat
- (5) BIS cable connector

NOTE

- **The AG module is configured with automatic barometric pressure compensation function.**

20.2 AG Safety Information

WARNING

- To avoid explosion hazard, do not use flammable anesthetic agent such as ether and cyclopropane for this equipment.
 - The presence of other substances in the patient's breathing circuit, such as ethanol, acetone, methanol, isopropanol, freon, asthma medication carrier gases, and other infrared absorbing gases, can influence the anesthesia agent identification and lead to incorrect measurements and identification.
 - Using high-frequency electrosurgical units may increase the risk of skin burn. In this case, do not use antistatic or conductive respiratory tubing.
 - Route all tubing away from the patient's throat to avoid strangulation.
-
-

CAUTION

- Perform the measurement in a well-ventilated environment.
 - EtCO₂ values measured from the AG module may differ from that of from the blood gas analysis.
-
-

NOTE

- The AG module automatically suppresses physiological alarms until breathing waves have been detected. Make sure that a patient is properly connected when monitoring with the AG module
-
-

20.3 AG Measurement Limitations

The following factors may influence the measurement accuracy:

- Leaks or internal venting of sampled gas
- Mechanical shock
- Cyclic pressure up to 10 kPa (100 cmH₂O)
- Other sources of interference, if any

20.4 AG Display

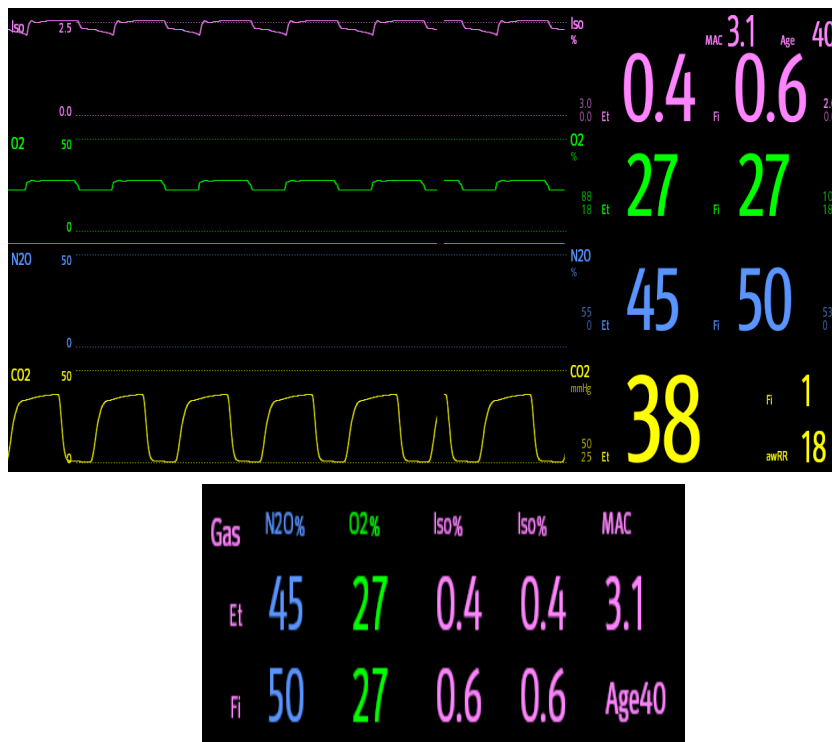

The AG module can send waves and numerics for all measured anesthetic gases for display on the monitor, including:

- CO₂, O₂, N₂O and AA waves
- awRR: airway respiratory rate
- MAC: minimum alveolar concentration
- End tidal (Et) and fraction of inspired (Fi) numerics for CO₂, O₂, N₂O and AA

AA represents one of the following agents: Des (desflurane), Iso (isoflurane), Enf (enflurane), Sev (sevoflurane), or Hal (halothane).

If only one anesthetic agent is used, the AA waveform area displays the waveform of this anesthetic agent. If several anesthetic agents are used, the AA waveform area displays the waveform of the primary anesthetic agent.

20.5 AG Equipment to Patient Connection

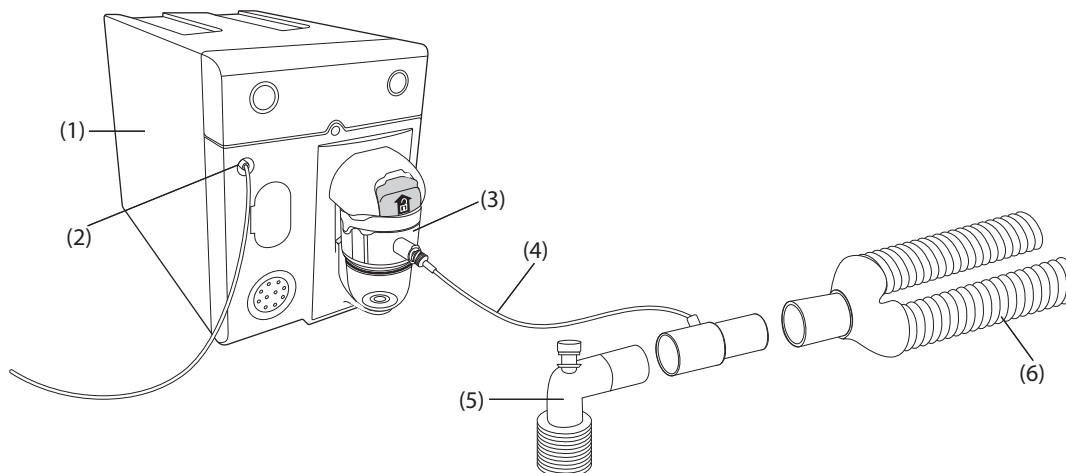

- | | |
|---|---|
| (1) AG module | (2) Gas outlet |
| (3) Watertrap | (4) Gas sample line |
| (5) Airway adapter (connected to patient) | (6) Y-piece (connected to the anesthesia machine) |

20.6 Preparing for AG Monitoring

To prepare to monitor AG, follow this procedure:

1. Select the appropriate gas sample line and watertrap according to the patient category.
2. Connect the watertrap to the AG module, and connect the gas sample line to the watertrap.
3. Connect the other end of the gas sample line to the patient via the airway adapter.
4. Connect the gas outlet to a scavenging system or the patient respiration circuit using an exhaust tube.
5. Check that the connections are tight.

After the AG module is connected to the SMR, the AG module enters the measurement mode by default and the monitor prompts **AG Starting**. AG measurement is available after the start-up is completed.

WARNING

- **When using the AG module, connect the gas outlet to the scavenging system or the patient respiration circuit when in use with the Mindray A7 anesthesia machine.**
- **If the sampled gas is returned to the breathing system, there may be a risk of patient cross-infection.**
- **If the sampled gas is returned to the breathing system, install a breathing system filter compliant with the ISO 23328-1 and ISO 23328-2 standards on the patient end.**
- **Make sure that the connections are tight. Any leak in the system can result in erroneous readings due to ambient air mixing with patient gases.**
- **Always inspect the airway adapter for a tight connection and proper operation before attaching it to the patient.**
- **Squeezing or bending the gas sample line during AG measurement may cause erroneous readings or no readings.**

CAUTION

- **Position the airway adapter so that the part connecting to the gas sample line is pointing upwards. This prevents condensed water from passing into the gas sample line and causing an occlusion.**
- **The watertrap collects water drops condensed in the sample line and therefore prevents them from entering the module. To avoid blocking the airway, empty the watertrap container whenever half full.**
- **The watertrap has a filter preventing bacterium, water and secretions from entering the module. After long-term use, dust or other substances may compromise the performance of the filter or even block the airway. In this case, replace the watertrap. Replacing the watertrap once a month is recommended.**

NOTE

- **Do not apply adult watertrap to the neonatal patient. Otherwise, patient injury could result.**
- **To extend the lifetime of the watertrap and module, disconnect the watertrap from the module and set the operating mode to Standby when AG monitoring is not required.**

20.7 Zeroing the AG Module

The AG module performs a zero calibration automatically when needed. Once the zero calibration is started, the AG module stops measuring and **"Zeroing"** is displayed in the AG numeric area.

After the zero calibration is completed, the AG module reacquires the AG readings. During the reacquisition period, “Zero Recovering” is displayed in the AG numeric area. Valid data will reappear 30 seconds after the zero calibration is started. You can hide the display of the “Zero Recovering” message, but values displayed during the reacquisition period may not be accurate. See 33.5.8 *Hiding the Invalid Display after Zeroing the AG Module* for more information.

The automatic zero calibration will not start under the following conditions:

- Physiological alarms related to CO₂ or AG are active.
- An apnea alarm is active.
- No breath has been detected for over 30 seconds.

You can also perform the zero calibration manually. For more information, see 33.5.7 *Manually Zeroing the AG Module*.

20.8 MAC Values

Minimum alveolar concentration (MAC) is the minimum concentration of the agent in the alveoli. It is a basic index to indicate the depth of anesthesia. The standard ISO 80601-2-55 defines MAC as this: alveolar concentration of an inhaled anesthetic agent that, in the absence of other anesthetic agents and at equilibrium, prevents 50% of patients from moving in response to a standard surgical stimulus.

MAC values are listed below:

Agent	Des	Iso	Enf	Sev	Hal	N ₂ O
1 MAC	6%	1.15%	1.7%	2.1%	0.77%	105%*

* indicates 1 MAC nitrous oxide can only be reached in hyperbaric chamber.

NOTE

- **The types of gases used for calculating the MAC value can be selected. For more information, see 33.5.5 *Manually Zeroing the CO₂ Module*.**
- **The MAC values shown in the table above are those published by the U.S. Food and Drug Administration for a healthy 40-year-old adult male patient.**
- **In actual applications, the MAC value may be affected by age, weight and other factors.**

The formula to calculate the MAC value is as follows:

$$MAC = \sum_{i=0}^{N-1} \frac{EtAgent_i}{AgentVol_{age}^i}$$

Where N is the number of all agents (including N₂O) that the AG module can measure, EtAgent_i is the concentration of each agent, and AgentVol_{age}ⁱ is the concentration of each agent at 1 MAC with age correction.

The formula for calculating age correction of 1 MAC is:

$$MAC_{age} = MAC_{40} \times 10^{(-0.00269 \times (age - 40))}$$

For example, the Des concentration at 1 MAC of a 60-year old patient is.

$$6\% \times 10^{(-0.00269 \times (60 - 40))} = 6\% \times 0.88$$

The AG module measures 4% of Des, 0.5% of Hal and 50% of N₂O in the patient’s end-tidal gas:

$$MAC = \frac{4.0\%}{6\% \times 0.88} + \frac{0.5\%}{0.77\% \times 0.88} + \frac{50\%}{105\% \times 0.88} = 2.04$$

NOTE

- **The formula above is only suitable for patients who are older than one year. If the patient is less than one year, the system uses one year old to do age correction.**

20.9 Changing AG Settings

20.9.1 Changing AG Alarm Settings

To change the AG alarm settings, follow this procedure:

1. Select the AG numeric area or waveform area to enter the **Gas** dialog.
2. Select the desired gas tab.
3. Select the **Alarm** tab.
4. Enter the password if required. For more information, refer to *33.14.3 Selecting Password for User Authentication*.
5. Set alarm properties as desired.

20.9.2 Setting the O₂ Compensation

If the AG module does not incorporate the O₂ module, you need to set the amount of O₂ in the ventilation gas mixture. To set the O₂ compensation, follow this procedure:

1. Select the AG numeric area or waveform area to enter the **Gas** dialog.
2. Select the **Setup** tab.
3. Set **O2 Compensation**:
 - ◆ Select **Off** when the amount of O₂ is less than 30%.
 - ◆ Select the other options in accordance with the O₂ concentration in the gas mixture.

The **O2 Compensation** setting is available only when the AG module does not incorporate the O₂ module. If the AG module incorporates the O₂ module, the system directly uses the O₂ concentration detected by the O₂ module to make compensation.

20.9.3 Entering the Standby Mode

Set the AG module to one of the following modes according to the module status:

- Select **Measure** mode when using the AG module for monitoring.
- Select **Standby** mode when not using the AG module.

The default operating mode is **Measure**. If not using the AG module, follow this procedure to enter the Standby mode:

1. Select the AG numeric area or waveform area to enter the **Gas** dialog.
2. Select the desired gas tab.
3. Select the **Setup** tab.
4. Set **Operating Mode** to **Standby**.

20.9.4 Setting Auto Standby

The monitor enters the standby mode automatically after the configured period of time if no breath is detected since the last detected breath. To set the auto standby, follow this procedure:

1. Select the AG numeric area or waveform area to enter the **Gas** dialog.
2. Select the desired gas tab.
3. Select the **Setup** tab.
4. Set **Auto Standby**.

20.9.5 Setting the Gas Waveform

To set the gas waveform, follow this procedure:

1. Select the AG numeric area or waveform area to enter the **Gas** dialog.
2. Select the desired gas tab.
3. Select the **Setup** tab.
4. Set the speed and scale of gas waveforms. For CO₂, set **Waveform Type**.

20.9.6 Setting the RR Source

To set the RR (respiration rate) source, follow this procedure:

1. Select the AG numeric area or waveform area to enter the **Gas** dialog.
2. Select the desired gas tab.
3. Select the **Setup** tab.
4. Set **RR Source**.

When the current RR source does not have valid measurement, the system will automatically switch **RR Source** to **Auto**.

20.9.7 Entering the Intubation Mode

When performing intubation during general anesthesia, enter the intubation mode to reduce unnecessary alarms. To enter the intubation mode, follow this procedure:

1. Select the AG numeric area or waveform area to enter the **Gas** dialog.
2. Select **Intubation Mode** from the bottom of the dialog.

For the details of the intubation mode, see **8.13 Intubation Mode**.

20.9.8 Enabling or Disabling MAC Display

Set whether MAC value is displayed in the AG numeric area by following this procedure:

1. Select the AG numeric area or waveform area to enter the **Gas** dialog.
2. Select the desired anesthetic agent tab.
3. Switch on or off **MAC**.

20.10 Changing the Anesthetic Agent

When the anesthetic agent used on the patient is changed, the AG module detects the mixed anesthetic gas during the transition of two anesthetic agents. The time required for completing the replacement of anesthetic agent depends on anesthesia type (low flow or high flow) and the characteristics of anesthetic agents (pharmacokinetics). During the transition of two anesthetic agents, the monitor gives no prompt messages and the MAC value displayed may be inaccurate.

The AG module can identify two anesthetic agents automatically. When the proportion of primary and secondary anesthetic agents in the mixture changes, the AG module can distinguish between them according to their contributions to the MAC value. Then primary and secondary anesthetic agents will be exchanged for display.

20.11 Performing AG Leakage Test

The AG leakage test is required every time before the AG measurement. To perform the AG leakage test, follow this procedure:

1. Plug the AG module into the module rack.
2. Wait for about one minute until the AG module warms up. Completely block the gas inlet of the AG module. Then the alarm message "**AG Airway Occluded**" will appear on the screen.
3. Block the gas inlet for another one minute.
4. Select the **Main Menu** quick key → from the **System** column select **Maintenance** → input the required password → select .
5. Select the **Module** tab → **AG** tab.
6. Check that the current flow rate is less than 10 ml/min, and the alarm message "**AG Airway Occluded**" does not disappear.

This indicates that the module does not leak. If the alarm message disappears, or the flow rate is equal to 10ml/min or greater, it indicates that the module leaks. Perform the leakage test again. If the problem remains, contact your service personnel for help.

20.12 Calibrating the AG Module

Calibrate the AG module every year or when the measured value is outside the specification. To calibrate the AG module, contact the service personnel.

CAUTION

- **Connect the gas outlet to the scavenging system when calibrating the AG module.**
-

20.13 AG Troubleshooting

If the AG airway is occluded, the message **AG Airway Occluded** appears. In this case, check for the follows until the message disappears:

1. Check the airway adapter for occlusion and replace if necessary.
2. Check the sample line for occlusion or kinking and replace if necessary.
3. Check the watertrap for water or occlusion. Empty the watertrap, or replace the watertrap if necessary.
4. Check the gas outlet and the exhaust tube for any occlusion.

If the message does not disappear, it is probably the module fault. Contact the service personnel in this case.

NOTE

- **For the physiological and technical alarm messages, see Appendix D Alarm Messages.**
-

21 Monitoring Respiratory Mechanics (RM)

21.1 RM Introduction

The RM monitoring enables clinicians to understand the ventilator/anesthesia machine operation and patient respiratory status. In respiratory mechanics (RM) monitoring, the airway pressures are measured between the patient circuit and intubation tube using a flow sensor inserted between the Y-piece of the patient circuit and the patient connection. The pressure is transferred to the monitor through the tube and measured by a pressure transducer in the RM module. The pressure difference together with the gas concentration information is used to calculate flow. The volume information is obtained by integrating the flow signal. From these three parameters, other parameters such as RR, I:E, Compl, etc. are derived.

RM monitoring is intended for adult and pediatric patients.

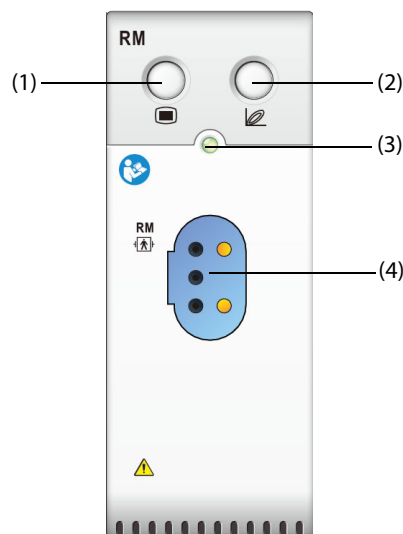

(1) RM menu hard key

(2) Enter/Exit the respiratory Loops

(3) Module status indicator

(4) Flow sensor connector

21.2 RM Safety Information

WARNING

- **RM monitoring is not intended for neonatal patients.**
- **RM monitoring is for mechanically ventilated patients only.**
- **The RM module is not intended to be used with high frequency ventilators.**

21.3 RM Parameters

RM monitoring displays the following waveforms and loops:

- Flow waveform
- Paw waveform
- Vol waveform
- FV (flow-volume) loop
- PV (paw-volume) loop

■ PF (paw-flow) loop

RM monitoring provides values for 18 parameters. The 18 parameters can be classified into 4 categories:

Parameter Label	Description	Unit
Paw parameters		
PIP	peak inspiratory pressure	cmH ₂ O
Pplat	pressure	cmH ₂ O
PEEP	positive end expiratory pressure	cmH ₂ O
Pmean	mean pressure	cmH ₂ O
Flow parameters		
PIF	peak inspiratory flow	L/min
PEF	peak expiratory flow	L/min
Vol parameters		
TVi	inspiratory tidal volume	ml
TVe	expiratory tidal volume	ml
MVi	inspiratory minute volume	L/min
MVe	expiratory minute volume	L/min
Other parameters		
RR	respiratory rate	rpm
I : E	ratio of the inspiratory and expiratory time	/
Compl	compliance	ml/cmH ₂ O
FEV1.0	first second forced expiratory volume ratio	%
RSBI	rapid shallow breathing index	rpm/L
WOB	work of breathing	J/L
NIF	negative inspiratory force	cmH ₂ O
RAW	airway resistance	cmH ₂ O/L/s

21.4 RM Display

You can select the parameter for display in the **Select Parameter** page of the **RM** menu. For more information, see *21.8.8 Setting Parameters for Display*.

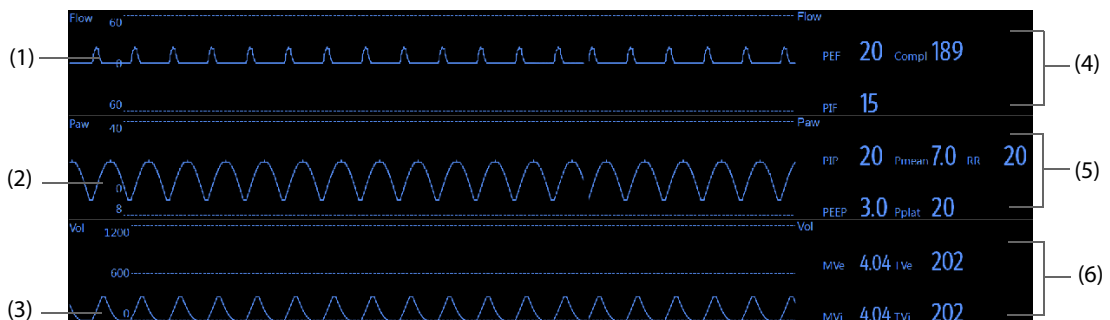

(1) Flow waveform

(2) Paw waveform

(3) Volume waveform

(4) Flow numeric area

21.5 RM Equipment to Patient Connection

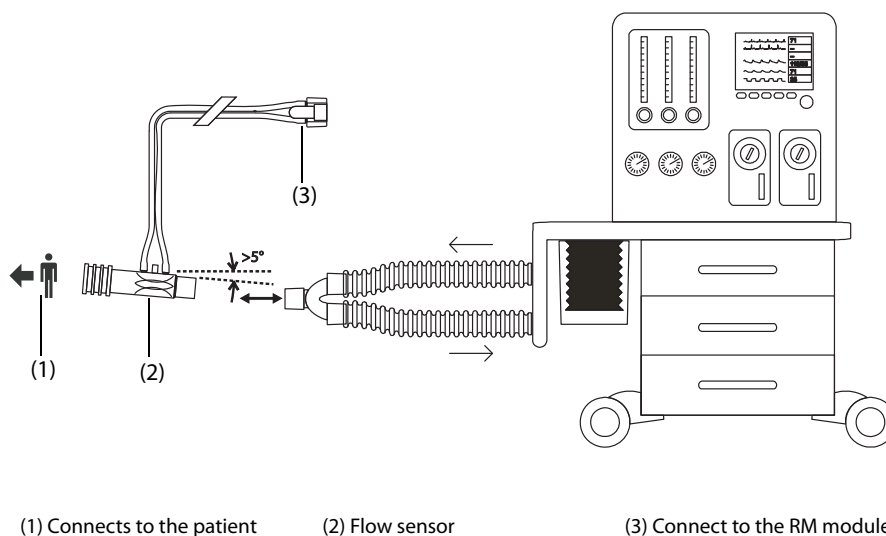

21.6 Preparing for RM Monitoring

To prepare to monitor RM, follow this procedure:

1. Select an appropriate flow sensor in accordance with the patient category.
2. Connect the thin tubes of the flow sensor to the flow sensor connector of the RM module.
3. Connect the end of the flow sensor marked  to the patient tracheal tube.
4. Connect the other end of the flow sensor to the Y-tube of a ventilator or anesthesia machine.
5. Check that the connections are tight.

CAUTION

- **Be sure to set the barometric pressure properly before using the RM module. Improper settings will result in erroneous RM reading.**
- **A system leak may significantly affect readings of flow, volume, pressure and other respiratory mechanics parameters.**
- **Match the airway adapter you select to the appropriate patient category. Improper sensor selection may produce excessive ventilation resistance or introduce excessive airway dead space.**
- **To prevent stress on the endotracheal tube, support the sensor and airway adapter.**
- **Position sensor tubing carefully to avoid entanglement or potential strangulation.**

NOTE

- **To avoid the effect of excessive moisture in the measurement circuit, insert the flow sensor in the breathing circuit with the tubes upright, and make sure that the flow sensor is always positioned a few degrees off the horizontal level towards the ventilator side.**
- **Do not place the flow sensor between the endotracheal tube and an elbow as this may allow patient secretions to block the flow sensor window.**
- **Measurement values provided by a ventilator or an anesthesia machine may differ significantly from the values provided by the RM module due to different locations of the flow sensor.**
- **For best measurement performance, a heat moisture exchanger (HME) should always be put between the tracheal tube and the flow sensor. Periodically check the flow sensor and tubing for excessive moisture or secretion build-up and purge if necessary.**

- During RM monitoring, the RM module automatically performs zero calibration periodically or when the temperature changes. Zero calibration affects RM waveforms.
- Keep the respiration loop away from condensing equipment.

21.7 Respiratory Loops

Respiratory loops reflect patient lungs function and ventilation condition, such as the lung's compliance, over-inflation, breathing system leakage and airway blockage.

The monitor provides three types of respiratory loops: PV (pressure-volume) loop, FV (flow-volume) loop, and PF (flow-pressure) loop. The three types of loops come from pressure, flow, and volume waveforms data.

To view the respiration loops, choose any of the following ways:

- Select the **Loops** quick key.
- Select the **Screen Setup** quick key → the **Select Quick Keys** tab.
- Select the **Main Menu** quick key → from the **Display** column select **Choose Screen** → select **Respiration Loops**.

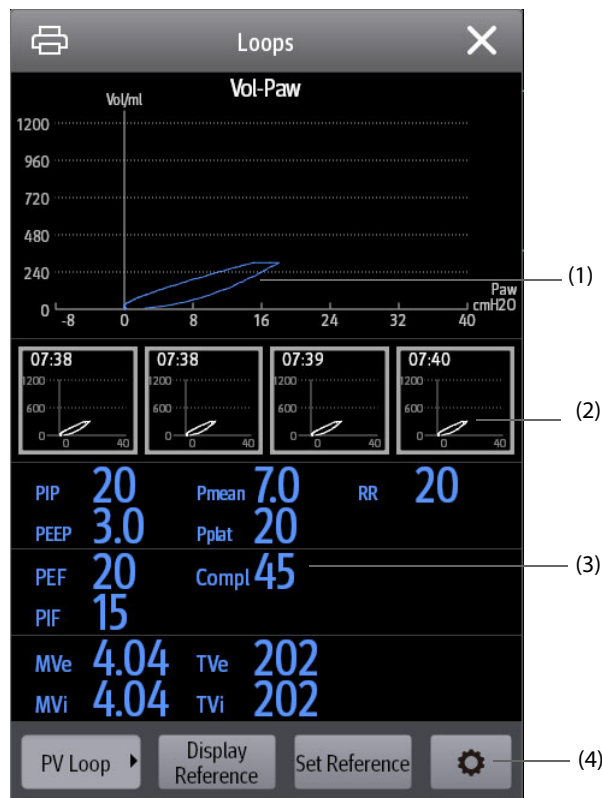

(1) Respiratory loop

(2) Reference loop

(3) RM parameters

(4) Button area

21.7.1 Changing the Loop Type

The monitor displays only one type of respiratory loops at the same time. To change the type of the respiratory loops, follow this procedure:

1. Select the numeric area or waveform area of Paw, Flow or Vol to enter the **RM** menu.
2. Select **Loops** from the bottom of the menu to enter the **Loops** window.
3. Select the desired loop type at the lower left corner of the window.

21.7.2 Saving the Loop as Reference

You can save the real time loops as reference loops. To save the loops, follow this procedure:

1. Select the numeric area or waveform area of Paw, Flow or Vol to enter the **RM** menu.
2. Select **Loops** from the bottom of the menu to enter the **Loops** window.
3. Select **Set Reference**.

The reference loops and the time at which the reference loops are saved display in the **Loops** window simultaneously. Up to four groups of loops can be saved as reference loops. If the fifth group of loops needs to be saved as reference, the monitor will prompt that an older group of reference loops should be replaced by the fifth group.

21.7.3 Displaying the Reference Loop

The reference loop and real time loop can overlap and be displayed in the same area of the **Loops** window. In this case, the reference loop is drawn in white. To display the reference loop, follow this procedure:

1. Select the numeric area or waveform area of Paw, Flow or Vol to enter the **RM** menu.
2. Select **Loops** from the bottom of the menu to enter the **Loops** window.
3. Select the reference loop to be displayed.
4. Select **Display Reference**.

To hide the reference loop, select **Hide Reference** button in the **Loops** window.

21.7.4 Adjusting the Loop Scale

The scales of the loops are the same as the scale of the corresponding waveforms. For more information, see *21.8.5 Changing the Wave Scale*.

21.7.5 Selecting the Parameters for Display

The parameters displayed in the **Loops** window are the same as those displayed in the Paw, Flow and Vol numeric areas. For more information, see *21.8.8 Setting Parameters for Display*.

21.8 Changing RM Settings

21.8.1 Changing RM Alarm Settings

To change the RM alarm settings, follow this procedure:

1. Select the numeric area or waveform area of Paw, Flow or Vol to enter the **RM** menu.
2. Select the **Alarm** tab.
3. Set the alarm properties of PEEP, PIP and MVE:

21.8.2 Setting the Apnea Alarm Delay

The monitor will alarm if the patient has stopped breathing for longer than the previously set apnea time. To change the delay time of the apnea alarm, follow this procedure:

1. Select the numeric area or waveform area of Paw, Flow or Vol to enter the **RM** menu.

2. Select the **Alarm** tab.
3. Enter the password if required.
4. Set **Apnea Delay**.

WARNING

- **The respiration monitoring does not recognize the cause of apneas. It only indicates an alarm if no breath is detected when a preadjusted time has elapsed since the last detected breath. Therefore, it cannot be used for diagnostic purposes.**
-

21.8.3 Setting RR Source

To set the RR (respiration rate) source, follow this procedure:

1. Select the numeric area or waveform area of Paw, Flow or Vol to enter the **RM** menu.
2. Select the **Setup** tab.
3. Set **RR Source**.

When the current RR source does not have valid measurement, the system will automatically switch **RR Source** to **Auto**.

21.8.4 Changing the Wave Sweep Speed

To set the sweep speed of Paw, Flow, and Vol waveforms, follow this procedure:

1. Select the numeric area or waveform area of Paw, Flow or Vol to enter the **RM** menu.
2. Select the **Setup** tab.
3. Set **Speed**.

21.8.5 Changing the Wave Scale

To set the scale of Paw, Flow, and Vol waveforms, follow this procedure:

1. Select the numeric area or waveform area of Paw, Flow or Vol to enter the **RM** menu.
2. Select the **Setup** tab.
3. Set **Paw Scale, Flow Scale, or Vol Scale**

21.8.6 Setting the Ambient Temperature

To set the ambient temperature, follow this procedure:

1. Select the numeric area or waveform area of Paw, Flow or Vol to enter the **RM** menu.
2. Select the **Setup** tab.
3. Set **Atmosphere Temp**.

21.8.7 Setting the Ambient Humidity

To set the ambient humidity, follow this procedure:

1. Select the numeric area or waveform area of Paw, Flow or Vol to enter the **RM** menu.
2. Select the **Setup** tab.
3. Set **Relative Humidity**.

21.8.8 Setting Parameters for Display

Each numeric areas of Paw, Flow or Vol can display up to 6 parameters. To set the parameters for display, follow this procedure:

1. Select the numeric area or waveform area of Paw, Flow or Vol to enter the **RM** menu.
2. Select the **Select Parameter** tab.
3. Select the parameters for display on pages of **Paw, Flow** and **Vol**.

21.8.9 Entering the Intubation Mode

When performing intubation during general anesthesia, you can enter the intubation mode in order to reduce unnecessary alarms. To enter the intubation mode, follow this procedure:

1. Select the numeric area or waveform area of Paw, Flow or Vol to enter the **RM** menu.
2. Select **Intubation Mode** from the bottom of the menu.

For more information of the intubation mode, see 8.13 *Intubation Mode*.

21.9 VCO₂ and Metabolic Monitoring

When the RM module is used together with the sidestream CO₂ module or AG module configured with the paramagnetic oxygen sensor, the following parameters can be monitored:

- Volume CO₂ parameters (VCO₂, MVCO₂)
- Oxygen consumption parameters (VO₂, MVO₂)
- Respiratory Quotient (RQ) and Energy Expenditure (EE)

Monitoring above parameters is intended for adult and pediatric patients.

21.9.1 VCO₂ and Metabolic Parameters

The following table lists VCO₂ and metabolic parameters.

Parameter label	Description	Unit
VCO ₂	CO ₂ Production for one breath	ml
MVCO ₂	CO ₂ Minute Production	ml/min
VO ₂	O ₂ Consumption for one breath	ml
MVO ₂	O ₂ Minute Consumption	ml/min
EE	Energy Expenditure	kCal/day
RQ	Respiratory Quotient	/

21.9.2 Safety Information When RM Module in Use with CO₂ or AG Module

WARNING

- **Measurement using RM module and CO₂ or AG Module is for intubated patients only.**
-

CAUTION

- **When using the RM module together with the CO₂ or AG Module, the gas sampling positions should be between the patient and the Y-piece, adjacent to the Y-piece end. The two sampling positions should be close to each other. Otherwise, measurement error can result.**
- **Strong scavenging suction may change the operating pressure of the modules and cause inaccurate readings or excessive sample gas flow.**
- **When monitoring with the RM module and the CO₂ or AG Module, keep the patient still. Do not disturb the patient or adjust the ventilation device.**

- **RQ has no reference significance if beyond the range of 0.6 and 1.3. Verify that the measurement is correct and the patient is stable.**

21.9.3 Measurement Limitations When RM Module in Use with CO₂ or AG Module

When the RM module is used together with the CO₂ module or AG module, measurements have reference significance only when the patient is in stable ventilation status. Stable ventilation status refers to the following situations:

- Patient is at rest for at least 30 minutes.
- Mechanical ventilation parameters (RR, TV, and etc) remain unchanged.
- No operations that may affect the patient's gas exchange or metabolism.

The measurement may be inaccurate in the following situations:

- The airway of sampling lines are abnormal or sampling lines leak or are blocked.
- Unsteady FiO₂ values
- Other circumstance causing wrong CO₂, O₂, and Flow measurements

Measurement cannot be taken in the following situations due to inadequate time for accurate sampling:

- High frequency ventilation (HFV) or bi-level positive airway pressure (BiPAP)
- Respiration rate is above 35 rpm.

21.9.4 Equipment to Patient Connection When RM Module in Use with CO₂ or AG Module

When the RM module is used together with the sidestream CO₂ module or AG module, equipment to patient connection is as follows:

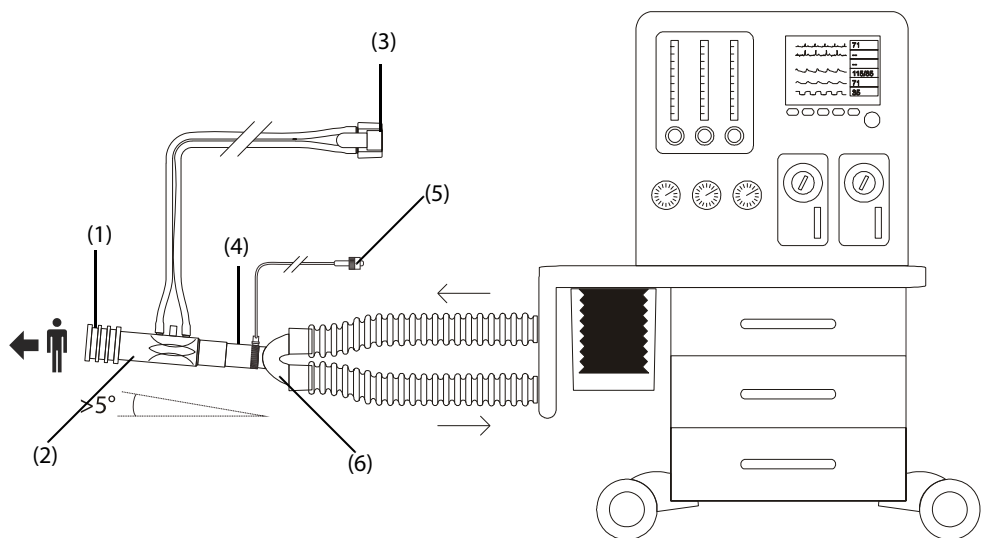

- (1) Connects to the patient
- (2) RM flow sensor
- (3) Connects to the RM module
- (4) Airway adapter
- (5) Connects to the sidestream CO₂ module or AG module
- (6) Y-piece (connects to the ventilator or anesthesia machine)

21.9.5 Displaying the VCO₂ and EE Numerics Areas

When the RM module is used together with the sidestream CO₂ module or AG module configured with the paramagnetic oxygen sensor, parameter display is as follows:

- In the VCO₂ parameter area, VCO₂, MVCO₂, VO₂, MVO₂ are displayed.
- In EE parameter area, RQ and EE are displayed.

21.9.6 Preparing for VCO₂ and Metabolic Monitoring

For more information, see 19.6.1 *Preparing to Measure CO₂ Using the Sidestream CO₂ Module*, 20.6 *Preparing for AG Monitoring*, and 21.6 *Preparing for RM Monitoring*.

NOTE

- **When the RM module is used together with the sidestream CO₂ module or AG module configured with the paramagnetic oxygen sensor, the CO₂ and Flow waveforms need to be synchronized to get valid measurements. This process is automatic, but takes approximately two minutes to complete.**

21.10 RM Troubleshooting

This section lists the problems that might occur. If you encounter the problems when using the equipment or accessories, check the table below before requesting for services. If the problem persists, contact your service personnel.

NOTE

- **For the physiological and technical alarm messages, see *D Alarm Messages*.**

Problem	Solution
Do not see RM numeric area or waveform area on the main screen	<ol style="list-style-type: none">1. Check that the Paw, Flow or Vol is set to be displayed in the Screen Setup menu. For more information, see 3.9.2 <i>Displaying Parameter Numerics and Waveforms</i>.2. Check that if the RM parameter switch is enabled. If not, enable the RM measurement. For more information, see 3.9.1 <i>Switching On or Off a Parameter</i>.3. Check the connection of flow sensor.
Erroneous values	<ol style="list-style-type: none">1. Check that the tube connectors and their connections are tight and not leaking.2. Check that the sensor type is appropriate.3. Disconnect the flow sensor, and remove the water or secretions from the flow sensor.
Values seem unstable	
Strong vibrations in the loop	<ol style="list-style-type: none">1. Check the patient status.2. Check the breathing system for water or secretions.
The respiratory loops are not whole. (gap between the starting and ending points may indicate a leak)	Check the breathing system for leakage.

This page intentionally left blank.

22 Monitoring Electroencephalogram (EEG)

22.1 EEG Introduction

The Electroencephalograph (EEG) module monitors the patient's cerebral function by measuring the electrical activity of the brain.

The EEG module can continuously monitor EEG signal from up to four channels. It can also display Density Spectral Arrays (DSA) and Compressed Spectral Arrays (CSA).

EEG monitoring is intended for adult, pediatric, and neonatal patients.

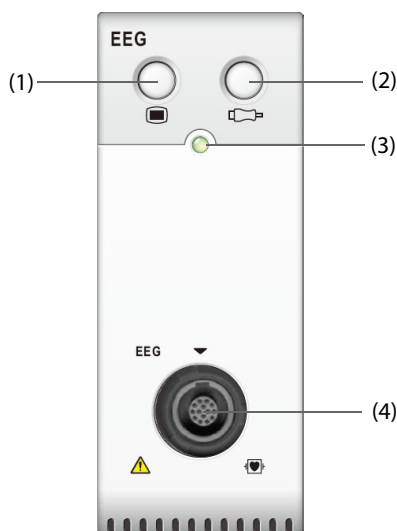

- | | |
|-----------------------------|---------------------------|
| (1) EEG dialog hard key | (2) Sensor check hard key |
| (3) Module status indicator | (4) EEG cable connector |

22.2 EEG Safety Information

WARNING

- **The conductive parts of electrodes and connectors should not contact other conductive parts, including electrically grounded parts.**
 - **To reduce the hazard of burns in the high-frequency surgical neutral electrode connection, the EEG sensor should not be located between the surgical site and the electrosurgical unit return electrode.**
 - **The EEG electrode must not be located between defibrillator pads when a defibrillator is used on a patient under monitoring.**
 - **To ensure proper defibrillator protection, use only recommended cables and leadwires.**
 - **EEG is a complex monitoring technology intended for use only as an adjunct to clinical judgment and training.**
-

CAUTION

- **Only use parts and accessories specified in this manual. Follow the instructions for use and adhere to all warnings and cautions.**
- **Implanted devices (for example cardiac pacemakers), other patient connected equipment, and other equipment near the patient (for example high-frequency surgical units) can cause interference on the waveform, numerics, and the CSA presentation.**

- External radiating devices may disturb the measurement. It is recommended to avoid the use of electrical radiating equipment in close proximity to the monitor.
- Interference from ECG can be eliminated by adjusting the filter settings.

NOTE

- The EEG accessories are purchased from EB Neuro S.p.A. Please contact EB Neuro or visit its website (www.ebneuro.com) for more information.
- In the event of electrode connection issues, the monitor provides an error indication only when it performs an auto sensor check according to the time interval that is set by the user. It is recommended to start a manual sensor check if an abnormal waveform or high noise is observed.

22.3 EEG Parameters

EEG monitoring provides ten parameters: SEF, MF, PPF, TP, SR, EMG, Delta, Theta, Alpha, and Beta. The numerics area of each EEG channel can display up to six parameters.

Label	Description
SEF (Spectrum Edge Frequency)	The frequency at which 95% of the total power lies below it and 5% lies above it. Its range is from 0.5 to 30.0 Hz.
MF (Median Frequency)	The frequency at which 50% of the total power lies below it and 50% lies above it. Its range is from 0.5 to 30.0Hz.
PPF (Peak Power Frequency)	The PPF is the frequency with the highest measured amplitude range from 0.5 to 30 Hz.
TP (Total Power)	TP numeric is a measure of the absolute total power in the frequency band from 0.5 to 30.0 Hz. The useful range is from 40 to 100 dB, where 0 dB = 0.0001uV2..
SR (Suppression Ratio)	SR numeric is the percentage of time in the past 60 seconds in which the EEG signal is considered suppressed.
EMG (Electromyography)	EMG bar graph reflects the electrical power of muscle activity and high frequency artifacts. Low EMG indicates that EMG activity is low.
Delta%, Theta%, Alpha%, Beta% (Frequency band ratio)	EEG is traditionally divided into four frequency bands: delta, theta, alpha and beta. Frequency band ratio is the percentage of total power falling in corresponding band. For example, Delta % = Power in delta band/Total power. Alpha waves: 8 to 13 Hz Beta waves: 13 to 30 Hz Theta waves: 4 to 8 Hz Delta waves: 0.5 to 4 Hz

22.4 EEG Display

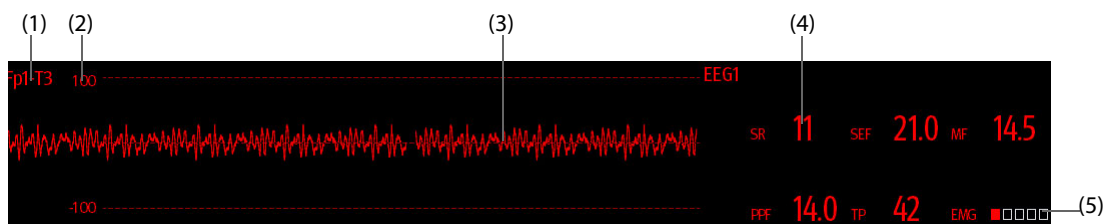

- (1) Lead label
- (2) EEG waveform scale. For more information, see 22.8.1 *Changing the EEG Scale*.

- (3) EEG waveform
You can configure the displayed EEG waveforms. A maximum of four EEG waveforms can be displayed.
- (4) EEG parameters
You can configure the displayed EEG parameters. A maximum of six EEG parameters can be displayed. For more information, see 22.8.5 *Changing Displayed EEG Parameters*.
- (5) EMG indicator
 - ◆ Empty: EMG < 30 dB. EEG monitoring conditions are optimal.
 - ◆ 1 to 4 bars: EMG 30 to 55 dB. EEG monitoring conditions are acceptable.
 - ◆ 5 bars: EMG > 55 dB. EEG monitoring conditions are unacceptable.

22.5 Accessing the On-screen EEG Guide

The monitor provides the on-screen EEG guide to help you understand EEG monitoring functions and operating procedure.

To access the on-screen EEG guide, follow this procedure:

1. Select the EEG numerics area or waveform area to enter the **EEG** dialog.
2. Select the **Introduction** tab.
3. Select a tab as required.
 - ◆ Select the **Summary** tab to view the EEG monitoring principles, intended use, and work modes.
 - ◆ Select the **Target Patients** tab to view the applicable patients for EEG monitoring.
 - ◆ Select the **Operation Guides** tab to view the EEG monitoring procedure.
 - ◆ Select the **CSA and DSA** tab to understand the CSA and DSA expand views.

22.6 Prepare for EEG Monitoring

To monitor EEG, follow this procedure:

1. Connect EEG module, patient cable and lead wires. For more information, see 22.6.1 *EEG Equipment to Patient Connection*.
2. Select Montage. You can select a predefined montage and you can also customize a montage. See 22.6.2.3 *Customizing an Electrode Montage*.
3. Mark the electrode sites on the patient's head according to the montage you have chosen.
4. Prepare the skin of the electrode application sites.
5. Apply the electrodes. For more information, see 22.6.3 *Attaching EEG Electrodes*.
6. Perform sensor check and observe the results.

22.6.1 EEG Equipment to Patient Connection

The following picture illustrates the connection between the EEG module and accessories.

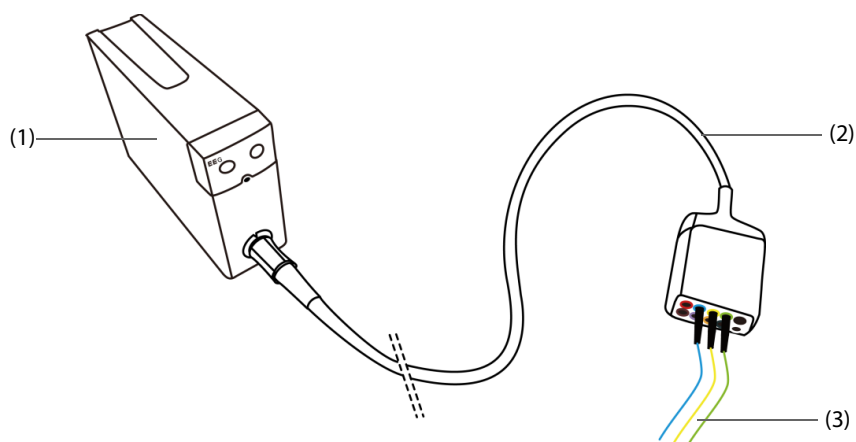

22.6.2 Choosing an EEG Electrode Montage

To choose a montage, follow this procedure:

1. Select the EEG numerics area or waveform area to enter the **EEG** dialog.
2. Select the **Montage Setup** tab.
3. Select **Montage**.

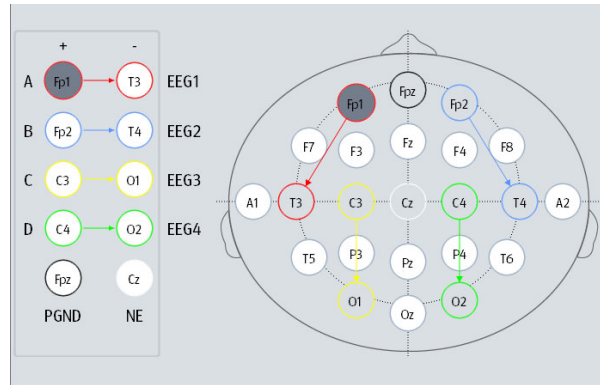

For each montage, the **Montage Setup** dialog shows the lead connection and electrode locations of each channel.

There are four predefined montages available. The following table shows electrode locations of each predefined montage.

Electrode		Montage 1	Montage 2	Montage 3	Montage 4
EEG1 (A)	Positive (+)	Fp1	F3	F3	Fp1
	Negative (-)	T3	C3	Cz	Cz
	Label	Fp1-T3	F3-C3	F3-Cz	Fp1-Cz
EEG2 (B)	Positive (+)	Fp2	C3	F4	Fp2
	Negative (-)	T4	P3	Cz	Cz
	Label	Fp2-T4	C3-P3	F4-Cz	Fp2-Cz
EEG3 (C)	Positive (+)	C3	F4	P3	O1
	Negative (-)	O1	C4	Cz	Cz
	Label	C3-O1	F4-C4	P3-Cz	O1-Cz
EEG4 (D)	Positive (+)	C4	C4	P4	O2
	Negative (-)	O2	P4	Cz	Cz
	Label	C4-O2	C4-P4	P4-Cz	O2-Cz

You can modify the predefined montage and rename it as customized montage. For more information, see [22.6.2.3 Customizing an Electrode Montage](#).

22.6.2.1 EEG Electrode Locations

The following pictures shows the electrode locations. The electrode locations are labeled according to the international 10-20 electrode placement system. The numbers and letters refer to electrode locations:

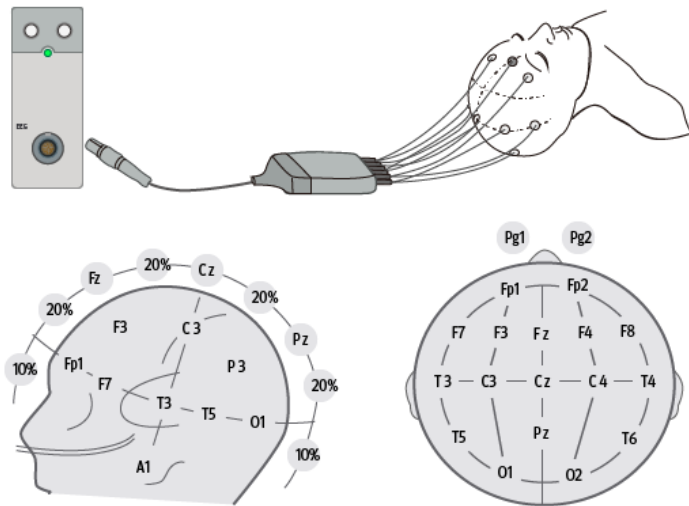

- Odd numbered electrodes: placed on the left
- Even numbered electrodes: placed on the right
- Letters: F = frontal, T = temporal, C = central, P = parietal, O = occipital, Z = midline electrodes

22.6.2.2 Bipolar Mode and Referential Mode

Measurement can be referential or bipolar.

- In bipolar mode, each channel (EEG1, EEG2, EEG3 and EEG4) uses two electrodes, a positive and a negative, to measure the potential difference between each pair.
- In referential mode, all channels use the same referential electrode (negative), and only use one electrode (positive) to measure the potential difference.

Montage 1 and Montage 2 are bipolar, while Montage 3 and Montage 4 are referential.

22.6.2.3 Customizing an Electrode Montage

To modify a predefined montage and save it as customized montage, follow this procedure:

1. Select the EEG numerics area or waveform area to enter the **EEG** dialog.
2. Select the **Montage Setup** tab.
3. Select a montage (for example **Montage 1**).
4. Modify the electrode locations and montage type: select an electrode from the channel area on the left, and then select the electrode position from the electrode map on the right. Repeat this operation until you have defined all the electrodes as desired.
5. Select **Save As** and input a new name for this montage, and then select **OK** to confirm the changes.

You can have up to three customized montages. Selecting **Delete** can delete a customized montage.

22.6.3 Attaching EEG Electrodes

WARNING

- Use only one type of electrode in the whole montage. Using different types of electrodes in the same montage may result in inaccurate readings.
-

NOTE

- Make sure that you have attached the ground electrode.
- The neutral electrode is usually more prone to artifact.

- For best results, use Ag/AgCl electrodes for the EEG measurement.
-

22.6.3.1 Attaching Cup Electrodes

1. Mark the spots on the patient's head according to the montage you have chosen.
2. Comb or cut the hair away from the spots and rub the skin with the abrasive paste to remove oil and grease.
3. Apply the conductive paste on the inside of each electrode and then press the electrodes on the spots.

NOTE

- Preferably use cup electrodes if montage includes placements within hair area.
-

22.6.3.2 Attaching Needle Electrodes

1. Clean the skin with alcohol.
2. Insert the needle into the subcutaneous area.
3. Secure the needles to prevent excess movement or detachment. You may also use a small amount of paste to attach the cable to the patient's hair. This prevents the cables from pulling the needles out of the skin.

WARNING

- Check that the package of needle electrodes is intact before use. Do not use the electrodes if the package is damaged.
 - Do not open the electrode package until immediately before use.
 - Needle electrodes are disposable. Do not reuse needle electrodes.
 - Replace any needle electrodes that are found to be bent. Using needles that have been previously bent may cause damage to the attachment site or inaccurate measurement.
-
-

22.7 Performing EEG Sensor Check

The monitor has an EEG sensor check function. The **Sensor Check** dialog displays the status of each electrode and the result of sensor check.

22.7.1 Setting the Interval of Auto Sensor Check

The sensor check is automatically initiated in the following situations:

- The EEG module is connected.
- The patient cable is connected.
- The Electrode montage is changed.
- The **Sensor Check** dialog is entered.

You can set the interval of performing the auto sensor check. To do so, follow this procedure:

1. Select the EEG numerics area or waveform area to enter the **EEG** dialog.
2. Select the **Sensor Check** tab.
3. Select an appropriate setting from **Interval** list. Selecting **Off** disables auto sensor check.

22.7.2 Displaying/Hiding Impedance Value

You can display the impedance value on the electrode map of **Sensor Check** dialog by clicking **Display Imped Values (K Ω)** key, or hide the value by clicking **Hide Imped Values (K Ω)** key.

22.7.3 Manually Starting a Sensor Check

To manually start sensor check, choose either of the following way:

- Press the sensor check  hard key on the EEG module.
- Select **Start Sensor Check** from the **Sensor Check** dialog.

At the completion of sensor check, the electrode status is shown. For more information, see 22.7.4 EEG Electrode Status.

22.7.4 EEG Electrode Status

EEG electrode status is color coded. The following table lists all electrode status options and actions to be taken.

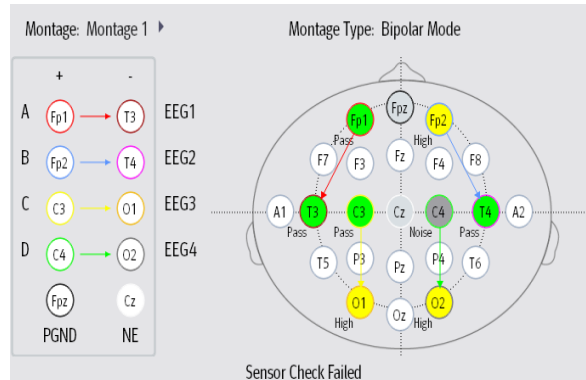

Color	Status	Description	Action
Red	Off	Electrode falls off and has no skin contact.	Reconnect electrodes: In the Bipolar mode, reconnect the electrode indicated as red, and PGND electrode. In the Referential mode, reconnect the electrode indicated as red, NE and PGND electrodes.
Grey	Noise	The EEG signal is too noisy. Impedance cannot be measured.	Check the sensor-to-skin contact. If necessary, reconnect the electrodes.
Yellow	High	The impedance is above the need.	Check the sensor-to-skin contact. If necessary, reconnect the electrodes.
Green	Pass	The impedance is within the need.	No action is necessary.

For each EEG channel, to get reliable results all electrodes for this channel should be in **Pass** status (green).

22.7.5 Stopping Sensor Check

Sensor check automatically stops if all the electrodes pass the impedance check. You can also manually stop the sensor check.

To stop sensor check, choose either of the following ways:

- Press the sensor check  hard key on the EEG module.
- Select **Stop Sensor Check** from the **Sensor Check** dialog.

22.8 Changing EEG Settings

22.8.1 Changing the EEG Scale

To set EEG waveform scale, follow this procedure:

1. Select the EEG numerics area or waveform area to enter the **EEG** dialog.

2. Select the **Setup** tab.
3. Select an appropriate setting from the **Scale** list.

22.8.2 Changing the EEG Sweep Speed

To set EEG sweep speed, follow this procedure:

1. Select the EEG numerics area or waveform area to enter the **EEG** dialog.
2. Select the **Setup** tab.
3. Select an appropriate setting from the **Speed** list.

22.8.3 Changing the High/Low Filter

The low and high filters can screen out undesirable interference which may come from respiration, movement, etc. The current EEG high and low filter settings are shown at the top of DSA and CSA view.

To change the filter settings, follow this procedure:

1. Select the EEG numerics area or waveform area to enter the **EEG** dialog.
2. Select an appropriate setting from the **Low Freq Cut-off** and **High Freq Cut-off** list.

22.8.4 Switching Off the Notch Filter

The notch filter can screen out 50Hz/60Hz power line noise. The notch filter is enabled by default. To disable the notch filter, follow this procedure:

1. Select the EEG numerics area or waveform area to enter the **EEG** dialog.
2. Select the **Setup** tab.
3. Set **Notch Filter** to **Off**.

22.8.5 Changing Displayed EEG Parameters

You can choose the displayed parameters. To do so, follow this procedure:

1. Select the EEG numerics area or waveform area to enter the **EEG** dialog.
2. Select the **Select Parameter** tab.
3. Select the parameters you want to display.

You can select at most six parameters. The selected parameters are applied to all EEG channels.

22.9 Displaying the EEG Expand View

To display the EEG expand view, follow this procedure:

1. Select the EEG numerics area or waveform area to enter the **EEG** dialog.
2. From the bottom of the **EEG** dialog, select **EEG Expand**.
3. Select the desired tab to enter corresponding view:
 - ◆ Select the **EEG** tab, and then select **EEG Channels**, **Scale**, and **Speed** to view corresponding EEG waveforms.
 - ◆ Select the **Parameters** tab to view parameter values of each EEG channel.
 - ◆ Select the **Trends** tab, and then select **EEG Channels**, **Parameters**, and **Trend Length** to view the trends of corresponding EEG channels and parameters.
 - ◆ Select the **CSA** tab to enter the CSA view. For more information, see 22.9.1 *CSA View*.
 - ◆ Select the **DSA** tab to enter the DSA view. For more information, see 22.9.2 *DSA View*.

22.9.1 CSA View

The continuous EEG signal is sampled periodically and this value is stored in a frame. Each frame is processed using Fast Fourier Transformation (FFT) to provide a frequency spectrum displayed as a compressed spectral array (CSA).

The CSA View provides an overview of the patient's EEG values over time.

To display the CSA View, follow this procedure:

1. Select the EEG numerics area or waveform area to enter the **EEG** dialog.
2. From the bottom of the **EEG** dialog, select **EEG Expand**.
3. Select the **CSA** tab.

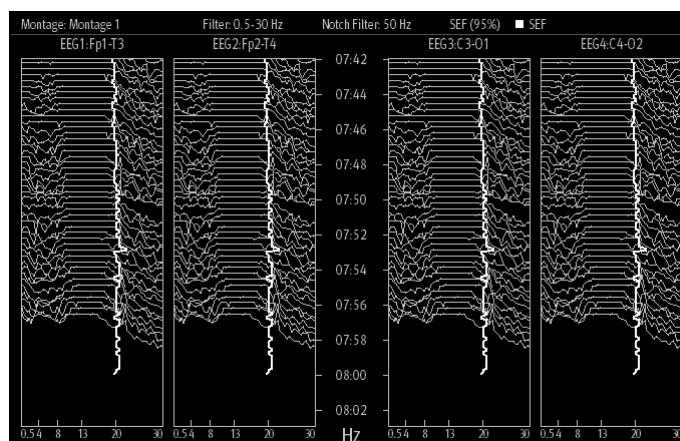

The CSA View provides up to CSA of four EEG channels. It provides the following information:

Displayed item	Description
Status bar	The first line displays the current montage, filter setting, notch frequency, SEF percentage (95%), and trendline labels and color codes. The second line displays the EEG channel labels and lead labels.
Frequency scale	It is the horizontal axis. The scale range depends on the filter settings (Low Freq Cut-off and High Freq Cut-off settings). The maximum displayed frequency is 30 Hz, so if you set High Freq Cut-off to 50 or 70, the upper scale remains 30.
Spectral lines	The energy at each frequency is computed and displayed as a spectral line.
Trendlines	EEG values are sampled at configured time intervals and displayed as color-coded trendlines. Trendlines are available for up to three frequency numerics (SEF, MF, and PPF). SEF trendline is white, MF trendline is purple, and PPF trendline is green.
"?" mark	Appears when artifact is detected, electrodes are off or disconnected, or montage is changed.

From the CSA view you can select the following items:

- **EEG Channels**
- **Parameters**
- **Trend Length**

To change **Power Scale** and **CSA Clipping** setting, select **CSA Setup**.

- Changing **Power Scale** can adjust the amplitude of spectral lines. The wider the power scale range, the greater amplitude of the spectral lines is.
- If **CSA Clipping** is switched on, the latest spectral line displays in a normal shape, in which area other go-through spectral lines will be cut out. If the **CSA Clipping** is switched off, all the spectral lines display normally.

22.9.2 DSA View

The Density Spectral Array (DSA) is to show changes in the power spectrum distribution over time.

To display the DSA View, follow this procedure:

1. Select the EEG numerics area or waveform area to enter the **EEG** dialog.
2. From the bottom of the **EEG** dialog, select **EEG Expand**.
3. Select the **DSA** tab.

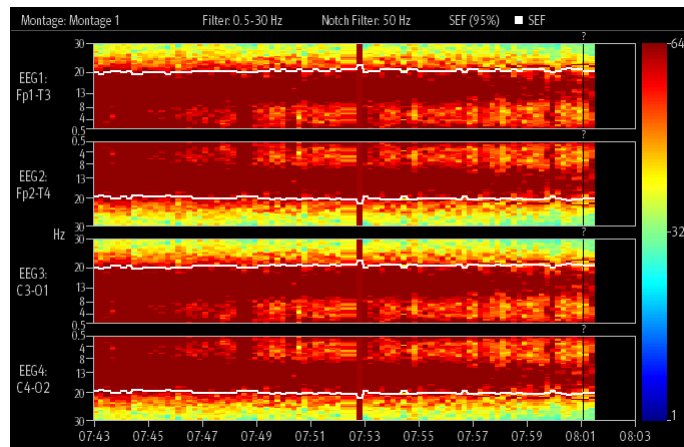

The DSA View displays DSA for up to four EEG channels. It provides the following information:

Displayed item	Description
Color bar	It is located at the right of the DSA view. The color bar color codes the power. You can change the setting of Power Scale to adjust the color of corresponding power.
Status bar	Displays the current montage, filter setting, notch frequency, SEF percentage (95%), and trendline labels and color codes.
Frequency scale	It is the vertical axis. The scale range depends on the filter settings (Low Freq Cut-off and High Freq Cut-off setting). The maximum displayed frequency is 30 Hz, so if you set High Freq Cut-off to 50 or 70, the upper scale remains 30.
Trendlines	EEG values are sampled at configured time intervals and displayed as color-coded trendlines. Trendlines are available for up to three frequency numerics (SEF, MF, and PPF). SEF trendline is white, MF trendline is purple, and PPF trendline is green.
"?" mark	Appears when high electrode impedance or artifact is detected, electrodes are off or disconnected is changed.

From the DSA view you can select the following items:

- **EEG Channels**
- **Parameters**
- **Trend Length**
- **Power Scale**

22.10 EEG Troubleshooting

This section lists the problems that might occur. If you encounter the problems when using the equipment or accessories, check the table below before requesting for services. If the problem persists after corrective actions have been taken, contact the service personnel.

Problem	Solution
EEG signal is noisy	<ol style="list-style-type: none">1. Check that the electrodes are properly connected and not dried out.2. Check that the electrodes properly contact with skin.3. Perform electrode impedance check.4. Calm the patient since frontal muscle activity can cause artifact.5. Remove sources of external electrical noise (for example, the lamps) from the vicinity of the patient's head.6. ECG monitoring may cause artifact; change electrode positioning.
EEG cable and electrodes properly connected, but no EEG waveforms.	<ol style="list-style-type: none">1. The number of channels in the montage is smaller than the number of channels connected to the patient. Check the number of channels.2. Select the Screen Setup quick key → Parameters On/Off. Make sure that EEG parameter is turned on.
The EEG numerics area displays "--".	The patient has high muscle activity in the head area, or noise from some interfering equipment is coupling to electrode cables. Relax the patient and remove the source of noise.
EEG waveform baseline fluctuates.	<ol style="list-style-type: none">1. Sweating may cause variations in the electrode impedance. Check the patient.2. If the fluctuation is disturbing, prepare the skin and replace the electrodes.
The electrode impedances show "--" and there is a message prompting to check the ground electrode?	The ground electrode is poorly connected to the patient. Check the electrode and cable. If the impedance of the electrode is too high, the measurement fails even if the electrode is properly attached. Use better electrodes or prepare the skin better.

NOTE

- For a comprehensive list of physiological and technical alarm messages, see *D Alarm Messages*.

This page intentionally left blank.

23 Monitoring Bispectral Index (BIS)

23.1 BIS Introduction

Bispectral Index (BIS) monitoring helps to monitor the level of consciousness of a patient under general anesthesia or sedation in OR and ICU. It is designed to monitor the hypnotic state of the brain based on acquisition and processing of EEG signals. Use of BIS monitoring to help guide anesthetic administration may be associated with the reduction of the incidence of awareness with recall during general anesthesia or sedation.

There are two BIS solutions available for use with the BIS module: the BISx or the BISx4. The BISx is for single side BIS monitoring, and the BISx4 is for both single side and bilateral BIS monitoring. The BISx4 provides bilateral BIS monitoring only when the BIS Bilateral Sensor is connected.

BIS monitoring is intended for adult and pediatric patients.

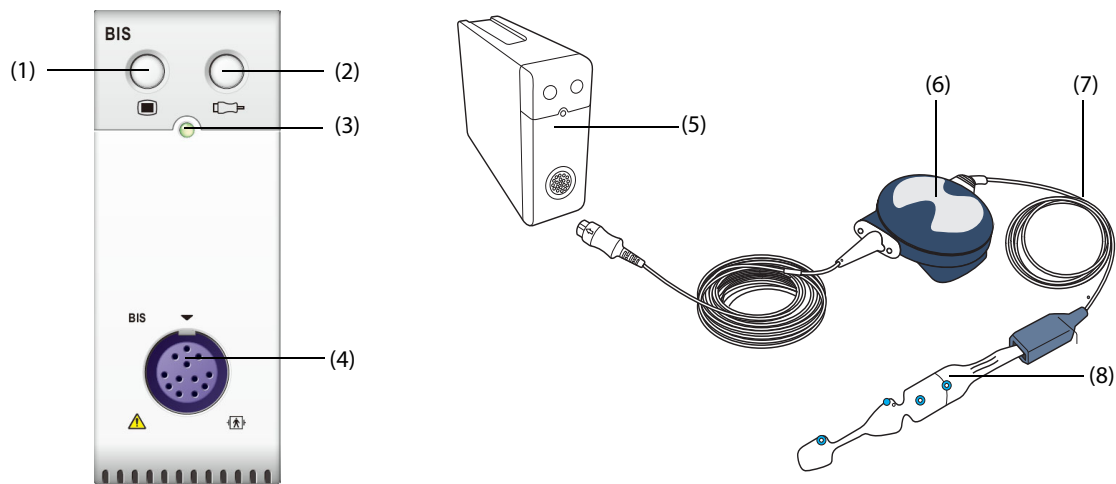

- (1) BIS dialog hard key
- (2) Sensor check hard key
- (3) Module status indicator
- (4) BIS cable connector

- (5) BIS module
- (6) BISx or BISx4
- (7) Patient cable
- (8) BIS sensor

23.2 BIS Safety Information

WARNING

- BIS monitoring is not intended for neonatal patients.
- The BIS technology used with this monitor is purchased from Covidien. It is important to recognize this index is derived using solely that company's proprietary technology. Therefore, it is recommended that clinicians have reviewed applicable information on its utility and/or risks in published articles and literature/web site information from Covidien, or contact Covidien at www.covidien.com for clinical-based BIS questions. Failure to do so could potentially result in the incorrect administration of anesthetic agents and/or other potential complications of anesthesia or sedation. It is recommended that clinicians also review the following practice advisory (that includes a section on BIS monitoring): The American Society of Anesthesiologists, Practice Advisory for Intraoperative Awareness and Brain Function Monitoring (Anesthesiology 2006;104:847-64). Clinicians are also recommended to maintain current knowledge of FDA or other federal-based regulatory, practice or research information on BIS and related topics.
- The conductive parts of sensors and connectors should not come into contact with other conductive parts, including earth conductors.
- To reduce the hazard of burns in the high-frequency surgical neutral electrode connection, the BIS sensor should not be located between the surgical site and the electrosurgical unit return electrode.
- To reduce the hazard of burns during use of brain-stimulating devices (e.g. transcranial electrical motor evoked potential), place stimulating electrodes as far as possible from the BIS sensor and make certain that sensor is placed according to package instructions.
- The BIS sensor must not be located between defibrillator pads when a defibrillator is used on a patient connected to the monitor.
- The clinical utility, risk/benefit and application of the BIS component have not undergone full evaluation in the pediatric population.
- Due to limited clinical experience for patients with neurological disorders, patients taking psychoactive medication, and children under one year old, BIS values from these patients should be interpreted cautiously.
- The BIS monitoring is a complex technology, intended for use only as an adjunct to clinical judgment and training. Clinical judgment should always be used when interpreting BIS in conjunction with other available clinical signs. Reliance on BIS alone for intraoperative anesthetic management is not recommended.
- Misinterpretation of BIS can result in incorrect administration of anesthetic agents and/or other potential complications of anesthesia or sedation.
- BIS values should be interpreted cautiously with certain anesthetic combinations, such as those relying primarily on either ketamine or nitrous oxide/narcotics to produce unconsciousness.

CAUTION

- Ensure that the BISx or BISx4 does not come into prolonged contact with the patient's skin, as it may generate heat and cause discomfort.
 - Do not use the BIS sensor if the sensor gel is dry. To avoid dryout, do not open the pack until you are ready to use the sensor.
 - When using electro-convulsive therapy (ECT) equipment during BIS monitoring, place ECT electrodes as far as possible from the BIS sensor to minimize the effect of interference. Certain ECT equipment may interfere with the proper function of the BIS monitoring system. Check for compatibility of equipment during patient setup.
 - The BIS measurement based on measuring the EEG signal is inherently very sensitive. Do not use electrical radiating equipment close to the BISx or BISx4.
 - Artifact may lead to inappropriate BIS values. Potential artifact may be caused by unusual or excessive electrical interference or high EMG activity like shivering, muscle activity or rigidity, sustained eye movements, head and body motion. Also, improper sensor placement and poor skin contact (high impedance) may cause artifact and interfere with the measurement.
 - External radiating devices may disturb the measurement.
 - Poor signal quality may lead to inappropriate BIS values.
-

23.3 BIS Parameters

Single side BIS monitoring provides the following parameters:

Parameter	Description
BIS (Bispectral Index)	The BIS numeric reflects the patient's level of consciousness. It ranges from 100 for wide awake to 0 in the absence of brain activity. 100: the patient is wide awake. 70: the patient is underdosed but still unlikely to become aware. 60: the patient is under general anesthesia and loses consciousness. 40: the patient is overdosed and in deep hypnosis. 0: the EEG is a flat line. The patient has no electrical brain activity.
SQI (Signal Quality Index)	The SQI numeric reflects signal quality and provides information about the reliability of the BIS, SEF, TP, and SR numerics during the last minute. The greater the SQI value, the better signal quality.
EMG (Electromyography)	EMG bar graph reflects the electrical power of muscle activity and high frequency artifacts. Low EMG indicates that EMG activity is low. BIS monitoring conditions are optimal when the bar is empty.
SR (Suppression Ratio)	SR numeric is the percentage of time over the last 63-second period during which the EEG is considered to be in a suppressed state.
SEF (Spectral Edge Frequency)	The SEF is a frequency below which 95% of the total power is measured.
TP (Total Power)	TP numeric is a measure of the absolute total power in the frequency ranging from 0.5 to 30.0 Hz. The useful range is from 40 to 100 db.
BC (Burst Count)	A burst means a period (at least 0.5 second) of EEG activity followed and preceded by inactivity. The BC numeric helps you quantify suppression by measuring the number of EEG bursts per minute. For single side BIS monitoring, this parameter is intended for the BIS module with the Extend sensor only. BC numeric is valid only when SQI \geq 15% and SR \geq 5%.

Bilateral BIS monitoring simultaneously monitors both cerebral hemispheres. When bilateral BIS is monitored, an "L" or "R" will be added to each of the numeric identifiers except ASYM. In addition to the above parameters, it also provides the following parameters:

Parameter	Description
sBIS (BIS Variability Index)	sBIS numeric represents the standard deviation of the BIS variable over the last three minutes.
sEMG (EMG Variability Index)	sEMG numeric represents the standard deviation of the EMG value over the last three minutes.
ASYM (Asymmetry)	ASYM is a processed variable indicating the percentage of EEG power presented in the left or right hemisphere with respect to total (left and right) EEG power. Designation 'L' of the asymmetry data indicates asymmetry to the left side. Designation 'R' of the asymmetry data indicates asymmetry to the right side.

23.4 BIS Display

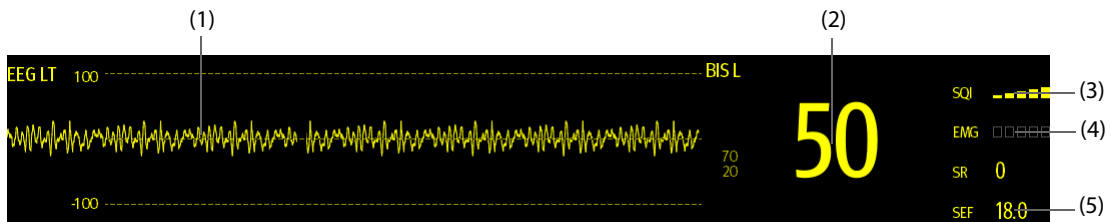

- (1) BIS waveform
The display of BIS waveform area depends on the setting of **Display** from the **BIS** dialog. For more information, see [23.7.3 Setting the Display of BIS Waveform Area](#).
- (2) BIS value
- (3) SQI indicator
 - ◆ Empty: SQI < 15%, unable to calculate BIS and secondary parameter values. BIS and secondary parameter values are displayed as "----".
 - ◆ 1 to 2 bars: SQI 15% - 49%, parameter values are unreliable.
 - ◆ 3 to 5 bars: SQI 50% - 100%, parameter values are reliable.
- (4) EMG indicator
 - ◆ Empty: EMG < 30 dB. BIS monitoring conditions are optimal.
 - ◆ 1 to 4 bars: EMG 30 - 55 dB. BIS monitoring conditions are acceptable.
 - ◆ 5 bars: EMG > 55 dB. BIS monitoring conditions are unacceptable.
- (5) Secondary parameters
The displayed secondary parameters are configurable. For more information, see [23.7.5 Setting the Displayed BIS Parameters](#).

23.5 Accessing the On-screen BIS Guide

The monitor provides the on-screen BIS guide to help you understand BIS monitoring functions and operating procedure.

To access the on-screen BIS guide, follow this procedure:

1. Select the BIS numerics area or waveform area to enter the **BIS** dialog.
2. Select the **Introduction** tab.
3. Select a tab as required.
 - ◆ Select the **Summary** tab to view the BIS monitoring principles.
 - ◆ Select the **Target Patients** tab to view the applicable patients for BIS monitoring.
 - ◆ Select the **Operation Guides** tab to view the BIS monitoring procedure.

23.6 Preparing for BIS Monitoring

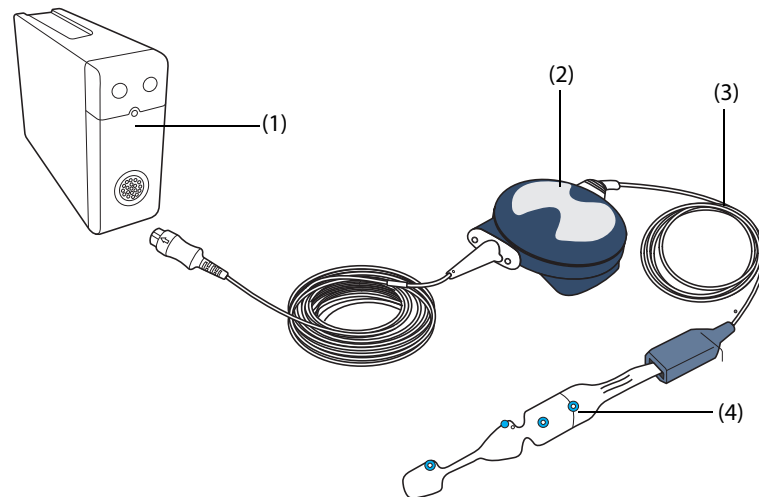

(1) BIS module

(2) BISx or BISx4

(3) Patient cable

(4) BIS sensor

To perform BIS monitoring, follow this procedure:

1. Connect the BISx or BISx4 to the BIS module.
2. Use the attachment clip to secure the BISx or BISx4 to a convenient location near the patient's head.
3. Connect the patient cable to the BISx or BISx4.
4. Attach the BIS sensor to the patient following the instructions supplied with the sensor.
5. Insert the BIS sensor into the patient cable connector until it is fully engaged.
6. Observe the results of the automatic sensor check in the numeric area.

Sensor Check is initiated automatically when the BIS sensor and the patient cable are connected to the BISx or BISx4. The measurement starts automatically after the sensor has passed the check.

WARNING

- **To minimize the risk of patient strangulation, the patient cable must be carefully placed and secured.**
-

CAUTION

- **Make sure the patient's skin is dry. A wet sensor or a salt bridge could result in erroneous BIS and impedance values.**
 - **Do not use if sensor gel is dry. To avoid dry out, do not open pack until ready for use.**
 - **Due to intimate skin contact, reuse may pose risk of infection. If skin rash or other unusual symptoms develop, stop using and remove.**
-

23.7 Changing BIS Settings

23.7.1 Setting BIS Alarm Properties

To set the BIS alarm properties, follow this procedure:

1. Select the BIS numeric area or waveform area to enter the **BIS** dialog.
2. In the **BIS** dialog, select the **Alarm** tab.
3. Enter the password if required. For more information, refer to 33.14.3 *Selecting Password for User Authentication*.
4. Set alarm properties as desired.

23.7.2 Choosing the BIS Smoothing Rate

The smoothing rate defines how the monitor averages the BIS value. With the smoothing rate becoming smaller, the monitor provides increased response to changes in the patient's state. Contrarily, the monitor provides a smoother BIS trend with decreased variability and sensitivity to artifacts.

To change the smoothing rate, follow this procedure:

1. Select the BIS numeric area or waveform area to enter the **BIS** dialog.
2. In the **BIS** dialog, select the **Setup** tab.
3. Set **Smoothing Rate** to **10 sec**, **15 sec**, or **30 sec**.

23.7.3 Setting the Display of BIS Waveform Area

To set the display of BIS waveform, follow this procedure:

1. Select the BIS numeric area or waveform area to enter the **BIS** dialog.
2. In the **BIS** dialog, select the **Setup** tab.
3. Set **Display**.
 - ◆ If you set **Display** to EEG waveforms, set **Scale** and **Speed** for EEG waveforms.
 - ◆ If you set **Display** to BIS parameter trends, set **Trend Length**.

23.7.4 Switching the Filter On or Off

The filter can remove undesired interference from the raw EEG wave display. It is switched on by default.

To enable/disable the filter, follow this procedure:

1. Select the BIS numeric area or waveform area to enter the **BIS** dialog.
2. In the **BIS** dialog, select the **Setup** tab.
3. Switch on/off **Filter**.

23.7.5 Setting the Displayed BIS Parameters

Besides the BIS value, you can also display up to four secondary parameters in the BIS numeric area. To select the displayed parameters, follow this procedure:

1. Select the BIS numeric area or waveform area to enter the **BIS** dialog.
2. In the **BIS** dialog, select the **Select Parameter** tab.
3. From the **BIS Tile** area, select a secondary parameter block, and then select a secondary parameter from the **Parameters** area.

23.8 Sensor Check

23.8.1 Automatic Sensor Check

Once the BIS sensor is connected, an automatic sensor check starts to check the sensor type, status, and impedance of all the electrodes, including the signal electrodes, the reference electrode and the ground electrode. During the sensor check, the message “Sensor Check In Progress” displays in the information area. If this message continuously displays, enter the **Sensor Check** dialog and check if the impedance of each electrode is acceptable.

After the initial sensor check, the monitor performs automatic checks during BIS monitoring. Automatic sensor checks includes the following items:

- The combined impedance of the signal electrodes plus the reference electrode. This is done automatically and continuously and does not affect the EEG waveform. As long as the impedances are within the valid range, there is no prompt message of this check or its results.
- The impedance of the ground electrode. This is done every ten minutes and takes approximately four seconds. It causes artifact in the EEG waveform, and the message **BIS: Checking Ground** is displayed on the monitor during the check. If the ground electrode does not pass this check, re-apply the electrode. Then another check will automatically initiate.

The monitor continually checks impedance levels during a procedure by generating a 128 Hz test signal. Occasionally this signal may interfere with other equipment. If this becomes a problem, you may need to disable the auto checking. Impedance levels will still be tested at startup, but once they pass, they will not be tested again until a new case is begun.

NOTE

- **Automatic sensor check may need to be disabled if the 1nA 128 Hz impedance check signal interferes with other equipment.**

23.8.2 Disabling automatic sensor check

To disable automatic sensor check, follow this procedure:

1. Select the BIS numeric area or waveform area to enter the **BIS** dialog.
2. Select the **Setup** tab.
3. Switch off **Auto Check**.

CAUTION

- **Switching the auto impedance check off will disable automatic prompt to the user of impedance value changes, which may lead to incorrect BIS values. Therefore, this should only be done if the check interferes with or disturbs other measurements.**

23.8.3 Manual Sensor Check

To manually start a sensor check, use either of the following methods:

- Press the sensor check hard key  on the BIS module.
- Select the **Sensor Check** tab from the **BIS** dialog.

The monitor enters the **Sensor Check** dialog after you start the sensor check. The **Sensor Check** dialog displays the following items:

- Sensor Type
- The status of each electrode
- Expiration time or usable cycles

NOTE

- **For different types of sensors the Sensor Check dialog may be different.**

23.8.4 BIS Sensor Status

The color of each electrode indicates its status:

Color	Status	Description	Action
Red	Lead off	Electrode has fallen off and has no skin contact.	Press the sensor more firmly to skin to ensure good sensor-to-skin contact. If necessary, remove the sensor, and then clean and dry the skin. Reapply the sensor or replace the sensor.
Grey	Noise	The EEG signal is too noisy. Impedance cannot be measured.	Press the sensor more firmly to skin to ensure good sensor-to-skin contact.
Yellow	High	The impedance is above the limit.	Press the sensor more firmly to skin to ensure good sensor-to-skin contact.
Green	Pass	The impedance is within valid range.	No action necessary.

Although BIS may still be measured when the electrode status is **Noise** or **High**, for best performance, all electrodes should be in the **Pass** status.

The sensor check may fail for the following reasons:

- Impedance too high
- Incorrect sensor application
- Poor sensor connection
- Defective patient interface cable or sensor

To correct the situation:

- Recheck the sensor
- Reapply the sensor according to instructions
- Check sensor connection
- Replace patient interface cable or sensor

23.9 Monitoring Bilateral BIS

By using BISx4 and the Bilateral sensor you can perform bilateral BIS monitoring. You can display the BIS expand view during bilateral BIS monitoring.

From the BIS expand view you can monitor 4-channel EEG and the density spectral array (DSA) which shows the degree of asymmetry in EEG power between the left and right hemispheres. The BIS expand view also provides BIS trend.

23.9.1 Entering the BIS Expand View

To enter the BIS expanded view, follow this procedure:

1. Select the BIS numeric area or waveform area to enter the **BIS** dialog.
2. Select **BIS Expand** at the bottom left corner to enter the BIS Expand View.

23.9.2 Selecting BIS Expand View Display

To configure what is displayed in the BIS Expand View screen, follow this procedure:

1. Select the BIS numeric area or waveform area to enter the **BIS** dialog.
2. Select **BIS Expand** at the bottom left corner to enter the BIS Expand View.
3. Select the **EEG**, **BIS Trend** or **DSA** tab.

23.9.2.1 Displaying the EEG waveforms

The **EEG** tab of the BIS Expand view shows the selected EEG waveforms. You can configure the EEG waveforms:

- Select **EEG Waveforms** to set which EEG waveforms you want to display.

- Select **Scale** to set EEG waveform scale.
- Select **Speed** to set EEG waveform speed.

23.9.2.2 Displaying the BIS Trend

The **BIS Trend** tab of the BIS Expand view shows the trend of selected parameters. You can configure the BIS trend:

- Select **Parameter 1** and **Parameter 2** to set the parameters whose trend you want to display.
- Set **Trend Length**.

23.9.2.3 Displaying BIS DSA

The Density Spectral Array (DSA) shows changes in the power spectrum distribution over a certain period of time.

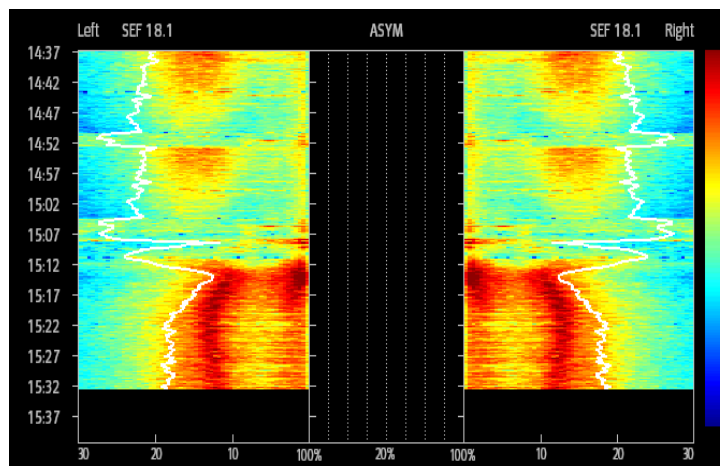

DSA view shows the following information:

- y-axis: time scale
- x-axis: signal frequency scale from 0 to 30 Hz
- Color bar: shows range of power. Red indicates maximum power and blue indicates minimum power.
- Spectral edge frequency (SEF) trend: It is the white Spectral Edge line superimposed on the graph where 95% of the total power lies on one side of the line (toward the inside of the graph) and 5% lies on the other.
- The current SEF value: displays above the graph.
- ASYM graph: displays in the center of the DSA view. It shows the degree of asymmetry in EEG power between the left and right hemispheres. The ASYM scale begins at 20% at the center line and runs left or right to 100%. Asymmetry data less than 20% are not displayed on the graph, but are available in the tabular trends.

23.10 BIS Troubleshooting

This section lists the problems that might occur. If you encounter the problems when using the equipment or accessories, check the table below before requesting for services. If the problem persists after corrective actions have been taken, contact the service personnel.

Problem	Solution
Measurement does not start	<ol style="list-style-type: none">1. Check the sensor attachment to the patient and the sensor placement. Check the sensor contact with skin.2. Check the sensor type.3. Check all connections and the patient cable.

NOTE

- For a comprehensive list of physiological and technical alarm messages, see *D Alarm Messages*.

23.11 Covidien Information

Covidien Patents

This posting serves as notice under 35 U.S.C. §287(a) for Covidien patents: <http://www.covidien.com/patents>.

No Implied License

Possession or purchase of this device does not convey any express or implied license to use the device with unauthorized replacement parts or consumables which would, alone, or in combination with this device, fall within the scope of one or more of the patents relating to this device.

24 Monitoring Neuromuscular Transmission (NMT)

24.1 NMT Introduction

The neuromuscular transmission (NMT) module evaluates muscle relaxation of patients under neuromuscular block by measuring the strength of muscle reaction after electrically stimulating the dedicated motor nerve. Two electrodes are placed on the patient's skin over dedicated nerve. A controllable current source delivers stimulation pulses to the two electrodes, and the acceleration of muscle contractions is measured with a 3-axis accelerometer.

NMT monitoring is intended for adult and pediatric patients.

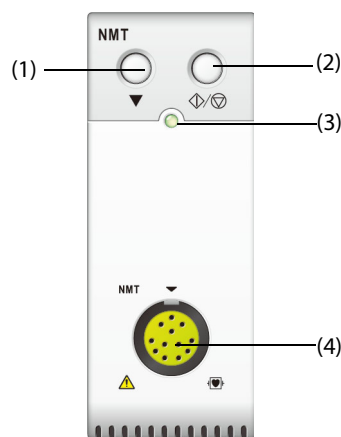

(1) Calibration hard key

(2) Start/stop key

(3) Module status indicator

(4) NMT patient cable connector

24.2 NMT Safety Information

WARNING

- **The NMT measurement is not intended for neonatal patients.**
- **The NMT stimulation should not be applied across or through the head, directly on the eyes, covering the mouth, on the front of the neck, especially the carotid sinus, or from electrodes placed on the chest and the upper back or cross over the heart.**
- **Application of electrodes near the thorax may increase the risk of cardiac fibrillation.**
- **Never apply electrodes to patients in areas where inflammation or injury is evident.**
- **When you are connecting the electrodes or the patient cable, make sure that the connectors do not touch any electrically conductive material including earth conductors.**
- **Patients with nerve damage or other neuromuscular problems may not respond properly to stimulation. The NMT measurement may show unusual patterns when monitoring muscle paralysis in these patients.**
- **NMT stimulation current pulses may interfere with other sensitive equipment, for example, implanted cardiac pacemakers. Do not use the NMT measurement on patients with implanted electronic devices unless so directed by a medical specialist.**
- **Simultaneous use of the NMT with high frequency electrosurgical equipment (ESU) may result in burns at the stimulation site and can also adversely affect measurement accuracy. Make sure the ESU return electrode is properly applied to the patient.**
- **Do not use the NMT in close proximity to shortwave or microtherapy devices, there is a risk of adversely affecting the NMT measurement.**

- **Never touch the electrodes unless the stimulation has been stopped.**
 - **Check each time before use that the material insulating the NMT sensor and the stimulation cable is intact and does not show signs of wear and tear.**
-
-

CAUTION

- **NMT monitoring is intended as an adjunct in patient assessment and must be used in conjunction with observation of clinical signs and symptoms.**
 - **NMT stimulation can be painful to a non-sedated patient. It is recommended not to stimulate before the patient is adequately sedated.**
 - **Use only electrodes suitable for nerve stimulation deemed appropriate by the attending physician.**
 - **Pay special attention to current densities exceeding 2 mA r.m.s/cm² for any electrodes.**
-

24.3 Stimulation Modes

The NMT module provides the following stimulation modes. Some stimulation modes require a minimum neurophysiological recovery time and during this recovery phase no new stimulation can be started. So you cannot start a measurement or calibration.

24.3.1 Train-Of-Four (TOF)

TOF mode is recommended for most cases.

In TOF mode, four stimulation pulses are generated at 0.5 second intervals. Each stimulation of the train causes the muscle to contract. The fade in the individual response to each single stimulation provides a basis for evaluation. The response is measured after each stimulus and the ratio of the fourth to the first response of the TOF sequence is calculated resulting in TOF-Ratio (TOF%).

When relaxation deepens, the TOF% declines until the fourth response disappears and no TOF% is calculated. Low response to the first stimulus (T1) also results in TOF% unavailable. When no TOF% is available, the degree of neuromuscular block is estimated from the number of responses or TOF counts. The fewer the response count is detected, the deeper is the relaxation.

If NMT calibration establishes the reference response amplitude, response to T1 as percentage of the reference value is calculated resulting in T1%.

In TOF mode, the minimum neurophysiological recovery time is 10 seconds. If NMT measurement or calibration is initiated during this period, it will be automatically delayed.

24.3.2 Single Twitch (ST)

In single twitch (ST) stimulation, the module delivers a single electrical pulse and measures the strength of the resulting twitch, the module then calculates the ratio of measured response to the reference twitch resulting in ST-Ratio.

ST mode is practical when using depolarizing relaxants since TOF% does not give any additional information about the patient status. Additionally, when the change of patient's relaxation level is considered, ST stimulation at a frequency of 1 Hz can indicate the relaxation change in a more real-time way.

24.3.3 Post-Tetanic Count (PTC)

When neuromuscular block deepens, different parameters are needed to measure the response. At first, when the response to the fourth TOF stimulation pulse disappears or the first twitch is very weak, the TOF% is not available and only the number of detected counts can be observed. When stimulation pulses no longer give any stimulation response, you do not get the TOF count either. To monitor the relaxation level, you can start tetanic stimulation and estimate the relaxation level from the Post Tetanic Count (PTC).

PTC stimulation mode starts with a sequence of four current pulses delivered at 2 Hz. If a muscle response is detected, the PTC sequence is stopped and the TOF result is reported. If there is no muscle response, the sequence continues with a five seconds long tetanic stimulation delivered at 50 Hz, followed by a pause of 3 seconds, followed by 20 single current pulses delivered at 1 Hz. The number of detected responses is counted and expressed as PTC. The fewer responses are detected, the deeper the relaxation is.

After tetanic stimulation, NMT measurements and calibration are disabled for 20 seconds and PTC is disabled for 2 minutes.

24.3.4 Double Burst Stimulation (DBS)

Double Burst Stimulation (DBS) enables better visual observing of the fading in the responses. DBS consists of two separate bursts at an interval of 750 ms, where each burst consists of certain pulses directly after each other at a frequency of 50 Hz. The response ratio of the second to the first burst is calculated resulting in DBS-Ratio, while the number of responses is detected and expressed as DBS Count.

The module supports DBS3.2 and DBS3.3.

- For DBS3.2 mode, the first burst consists of 3 consecutive pulses, and the second burst consists of 2 consecutive pulses.
- For DBS3.3 mode, both bursts consist of 3 consecutive pulses.

In DBS mode, the minimum neurophysiological recovery time is 15 seconds. If NMT measurement or calibration is initiated during this period, it will be automatically delayed.

24.4 NMT Parameters

The following table lists the NMT parameters in different stimulation modes.

Stimulation Mode	Parameter Label	Unit	Number of Bars
TOF	TOF-ratio	%	4
	TOF-count	/	4
	T1%	/	/
ST	ST-ratio	%	1
	ST-count	/	1
PTC	PTC	/	/
DBS	DBS ratio	%	2
	DBS count	/	2

24.5 NMT Display

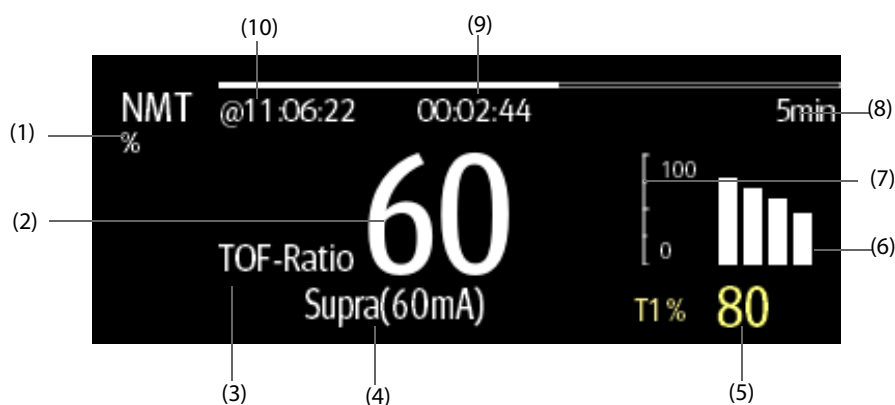

- (1) Parameter unit
- (2) Parameter value
- (3) Parameter label
- (4) Stimulation current

(5) T1%: responses to the first stimulus as percentage of the reference amplitude in TOF mode. This value is not shown if calibration fails.

(6) Bar graph: indicates the amplitude of response to the stimulation. The maximum height of the bar graph displayed is 120%. Bar graph is not shown if calibration is not completed successfully.

(7) Scale: indicates the amplitude of response to stimulation.

(8) Measurement interval: **Manual** is displayed if **Interval** is set to **Manual**.

(9) Measurement countdown: time to the next measurement. The measurement countdown is not shown if **Interval** is set to **Manual**.

(10) The last measurement time.

NOTE

- The NMT parameter values become outline font 15 minutes after the NMT measurement is taken.
- The PTC value is shown on the display for 20 seconds after which the NMT module returns to the preset stimulation mode.

24.6 Accessing the On-screen NMT Guide

The monitor provides the on-screen NMT guide to help you understand NMT monitoring functions and operating procedure.

To access the on-screen NMT guide, follow this procedure:

1. Select the NMT numerics area or waveform area to enter the **NMT** menu.
2. Select the **Introduction** tab.
3. Select a tab as required.
 - ◆ Select the **Summary** tab to view the NMT monitoring principles.
 - ◆ Select the **Target Patients** tab to view the applicable patients for NMT monitoring.
 - ◆ Select the **Points To Note** tab to view the precautions before NMT monitoring.
 - ◆ Select the **Operation Guides** tab to view the NMT monitoring procedure.

24.7 Preparing for NMT Monitoring

24.7.1 NMT Equipment to Patient Connection

The following picture shows NMT cable and patient connection.

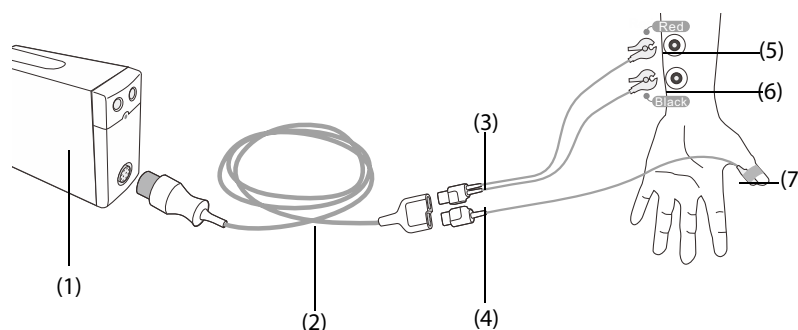

(1) NMT module

(2) NMT patient cable

(3) NMT stimulation cable

(4) NMT sensor cable

(5) Proximal electrode (red)

(6) Distal electrode (black)

(7) NMT sensor

24.7.2 Preparing the Skin

Good electrode-to-skin contact is important for good signal quality. Before applying the electrodes, clean the application site of oil and dirt and avoid placing the electrodes over excessive body hair or lesions. Insufficient cleaning of the skin can cause high skin impedance which could cause the stimulation to stop.

To properly prepare the skin, follow this procedure:

1. Select sites with intact skin, without lesion of any kind.
2. Shave hair from skin at chosen sites.
3. Gently rub skin surface at sites to remove dead skin cells.
4. Thoroughly cleanse the site with a mild soap and water solution.
5. Dry the skin completely before applying the electrodes.

24.7.3 Placing the Electrodes and Sensor

Stimulation of the ulnar nerve in the wrist and acceleration measurements at the adductor pollicis are preferred for routine monitoring. When monitoring neuromuscular transmission, round surface electrodes with snap connection are a must. Small (pediatric or neonatal) electrodes are advisable to obtain a sufficient current density. In order to ensure a steady signal quality, be sure only to use CE marked electrodes.

Ensure that the thumb can move freely before applying NMT electrodes and sensor. Follow this procedure to place the electrodes and sensor:

1. Place the distal electrode near the wrist.
2. Place the proximal electrode 2 to 3 cm proximal of the distal electrode.
3. Attach the red clamp to the proximal electrode.
4. Attach the black clamp to the distal electrode.
5. Affix the sensor with its large flat side against the palmar side of the thumb with a piece of tape. The cable should be attached in such a way that it does not 'pull' at the sensor and that movement of the thumb is not obstructed.

CAUTION

- **When placing the electrodes, make sure that they do not touch each other.**
 - **If the electrodes are placed incorrectly, wrong nerves are stimulated and this causes wrong muscle response.**
 - **When multiple nerves are stimulated, the measured response may be affected by activity of other muscles.**
 - **If the stimulation electrodes are placed very close to the palm of the hand, the muscles are stimulated directly by the stimulation pulses.**
 - **If the current is too strong, it may stimulate the muscles too much.**
 - **Moving or touching the patient during measurement may cause incorrect results.**
 - **Make sure that the NMT cables does not contact external pacemaker or catheter wires.**
 - **To avoid unintentional electrical shocks always make sure that the NMT stimulation has been stopped before touching the electrodes.**
 - **Take care to handle the NMT sensor, avoiding forcefully striking the sensor.**
 - **After repositioning the patient, check the NMT sensor application site and ensure that the sensor is still properly applied and the thumb can move freely.**
-

CAUTION

- **Correct positioning of the electrodes is important. Small displacements may result in considerable changes in stimulation current requirements. Furthermore, the electrodes must be positioned in such a way to avoid direct stimulation of the muscle.**
 - **The electrodes should be applied properly to the patient skin. It has been found that slight pressure on the electrodes may improve the stimulation considerably. Therefore, taping the electrodes to the skin may be advisable.**
 - **The more distal the sensor is placed on the thumb, the stronger the acceleration signal. This effect can be used to adjust the signal strength.**
 - **During NMT measurement, the arm applied with NMT electrodes and sensor should be kept immobile during the whole procedure.**
-

24.8 Calibrating the NMT Measurement

The size of the sensor signal varies from patient to patient. NMT calibration determines supramaximal stimulation current and the reference response amplitude. The reference response amplitude is the twitch at the supramaximal stimulation current when the patient is not paralyzed. The calibration must be done prior to administration of a muscle relaxant drug.

CAUTION

- **Start calibration before the administration of a muscle relaxant drug (but after the induction of sleep in general anesthesia) to prevent voluntary muscle contraction and tension from interfering with the reference search.**
-

24.8.1 Setting the Calibration Current

If you set **Stimulation Current** to **Supra (60 mA)**, the module automatically searches for supramaximal current to determine the reference response amplitude. If you select a value between 0 and 60 mA, the reference response amplitude is determined using the selected stimulation current. For adults, the supramaximal current is usually between 35 and 55 mA. For more information, see *24.11.2 Changing the Stimulation Current*.

24.8.2 Starting NMT Calibration

To Start NMT calibration, follow this procedure:

1. Select the NMT numeric area to enter the NMT menu.
2. Select the **Setup** tab.
3. Verify that the settings of **Stimulation Current** and **Pulse Width**.
4. Press the calibration hard key on the NMT module or select **Calibrate** at the bottom of the **NMT** menu to start calibration.

If calibration succeeds, the message **Calibration Completed** displays on the **NMT** menu. If calibration failed, the NMT module automatically uses the default value as the reference amplitude.

NOTE

- **It is recommended that the patient be anesthetized before setting up the calibration twitch as nerve stimulation can be painful.**
 - **Changing the stimulation current or pulse width after calibration invalidates the stored reference data, and therefore recalibration is required.**
-

24.9 Starting NMT Measurements

At the completion of NMT calibration, the monitor automatically starts a TOF mode measurement.

You can also choose either of the following ways to start NMT measurements:

- Press the Start/stop key on the NMT module.
- From the **Measure** tab of the **NMT** menu, select a measurement mode, set **Interval**, and select **Start (XX)** to start NMT measurement at corresponding mode.

NOTE

- **Stop NMT measurements if you need to change the NMT settings.**
 - **Take care when removing the sensor from the patient. Do not pull on the cable.**
-

24.10 Stopping NMT Measurements

Choose either of the following ways to stop an on-going NMT measurement.

- Press the **Start/stop** key on the NMT module.
- Select **Stop All** at the bottom of the **NMT** menu.

24.11 Changing NMT Measurement Settings

24.11.1 Selecting the NMT Measurement Mode

To select the NMT measurement mode, follow this procedure:

1. Select the NMT numeric area to enter the **NMT** menu.
2. Select the **Measure** tab.
3. Select the desired stimulation mode.
4. If you select **TOF Mode**, **ST Mode**, or **DBS** mode, select **Interval** to set the time interval between two measurements.

24.11.2 Changing the Stimulation Current

Before calibration and NMT measurement, confirm that the desired stimulus current is selected. To set the simulation current, follow this procedure:

1. Select the NMT numeric area to enter the **NMT** menu.
2. Select the **Setup** tab.
3. Set **Stimulation Current**.
 - ◆ When **Stimulation Current** is set to **Supra**, the module automatically searches for supramaximal current to determine the reference response amplitude. For adults, the supramaximal current is usually between 35 and 55 mA. Smaller currents may be desirable for children.
 - ◆ If **Stimulation Current** is set to a value between 0 and 60 mA, the reference response amplitude is determined using the selected stimulation current.

NOTE

- **Stimulation current is adjusted in increments of 5 mA.**
-

24.11.3 Changing the Pulse Width

You can increase the pulse width to increase the effect of the stimulation to help finding the supramaximal current. To set the pulse width, follow this procedure:

1. Select the NMT numeric area to enter the **NMT** menu.
2. Select the **Setup** tab.
3. Set **Pulse Width**.

24.11.4 Enabling Block Recovery Notification

A message “NMT Block Recovery” is displayed in the technical alarm information area to notify you when the set block recover limit is reached. This indicates that the patient is responding more clearly to the stimuli and the neuromuscular block is decreasing. This notification can be used, for example, to help maintain a certain relaxation level.

To enable the block recovery notation and set the limit for activating the note, follow this procedure:

1. Select the NMT numeric area to enter the **NMT** menu.
2. Select the **Setup** tab.
3. Set **Block Recovery**. If **Block Recovery** is set to **Off**, the monitor will not give a note.

24.11.5 Adjusting NMT Stimulation Beep Volume

The monitor gives a beep at the selected volume at each stimulation pulse if the setting is not zero. To adjust the volume of NMT stimulation beep, follow this procedure:

1. Select the NMT numeric area to enter the **NMT** menu.
2. Select the **Setup** tab.
3. Set **Stimulation Beep Volume**.

24.12 Recalling Calibration Information

In the situation that the NMT module is power down, or you want move the NMT module to another monitor along with the patient and you want to continue with the already determined calibration information, including stimulation current, pulse width, and reference response amplitude, you can use the recall function.

To recall the calibration information, follow this procedure:

1. Select the NMT numeric area to enter the **NMT** menu.
2. Select the **Recall Reference** tab.
3. Select **Recall Reference**.

24.13 NMT Troubleshooting

This section lists the problems that might occur. If you encounter the problems when using the equipment or accessories, check the table below before requesting for services. If the problem persists, contact the service personnel.

Problem	Solution
NMT calibration and measurement fails.	<ol style="list-style-type: none"> 1. Check that the electrodes are properly applied. 2. Replacing the electrodes.
NMT measurement is disturbed.	<ol style="list-style-type: none"> 1. Do not touch the arm where electrodes are applied. 2. Check that the electrodes and NMT sensor are properly applied.
Supramaximal current cannot be found.	Check that the electrodes are properly applied. Also, supramaximal current may not be found if the patient is already relaxed.

NOTE

- For a comprehensive list of physiological and technical alarm messages, see *D Alarm Messages*.

25 Monitoring Regional Oxygen Saturation (rSO₂)

25.1 rSO₂ Introduction

The rSO₂ (Regional Oxygen Saturation) monitoring provides noninvasive and continuous information of changes in regional oxygen saturation of blood. The measurement takes place in real time, providing an immediate indication of a change in the critical balance of regional oxygen delivery and oxygen consumption.

The harmless, near-infrared wavelengths generated by the INVOS System's light-emitting diodes pass through scalp and bone tissue beneath the sensor. Once in vivo they are either absorbed or scattered back up to the sensor's shallow and deep detectors. Red-colored hemoglobin molecules within red blood cells have the highest light absorption of the wavelengths used, and the exact shade of red of each hemoglobin molecule indicates the amount of oxygen it is carrying. The type and quantity of absorption data returned to the detectors reflects deoxyhemoglobin and total hemoglobin, from which a regional oxygen saturation (% rSO₂) value unique to the specific area under the sensor is calculated.

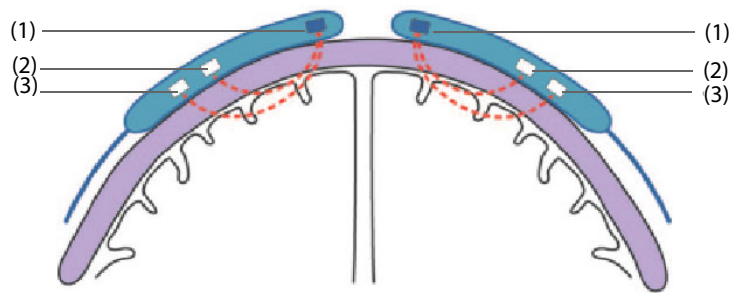

(1) Light source

(2) Shallow detector

(3) Deep detector

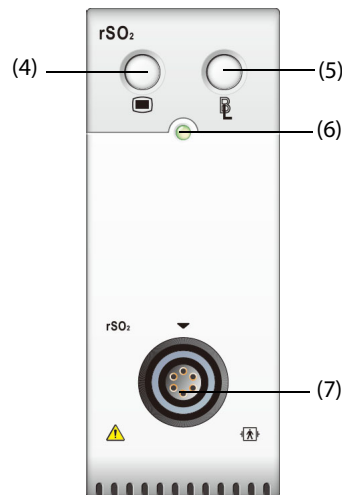

(4) rSO₂ dialog hard key

(5) Set the baseline for all rSO₂ channels

(6) Module status indicator

(7) rSO₂ cable connector

25.2 rSO₂ Safety Information

CAUTION

- rSO₂ monitoring is intended for use in individuals greater than 2.5 kg at risk for reduced-flow or no-flow ischemic states.
- Do not use the rSO₂ value as the sole basis for making decisions regarding diagnosis or therapy because the rSO₂ values represent a small volume of tissue beneath the sensor and may not reflect oxygenation disturbances that occur elsewhere.
- Use only recommended or provided accessories. Using any other sensor will compromise accuracy.
- Use of an electrosurgical instrument in the vicinity of the monitor may interfere with the signal and result in inaccurate rSO₂ measurement.

NOTE

- Environments with excessive ambient light such as bright sunlight or strong operating room lighting may require loosely covering the area of the sensor with an opaque drape.

25.3 rSO₂ Measurement Limitations

If present, the following may cause inaccurate readings:

- Cardiogreen, indigo carmine or other intravascular dyes
- Carboxyhemoglobin or other dyshemoglobins
- Hemoglobinopathies
- Conjugated hyperbilirubinemia (direct)
- Myoglobin (Mb) in muscle tissues

25.4 rSO₂ Display

rSO₂-1 and rSO₂-2 are from the first inserted rSO₂ module. rSO₂-1' and rSO₂-2' are from the second inserted rSO₂ module. Each rSO₂ numeric area displays one rSO₂ channel, which is shown as below:

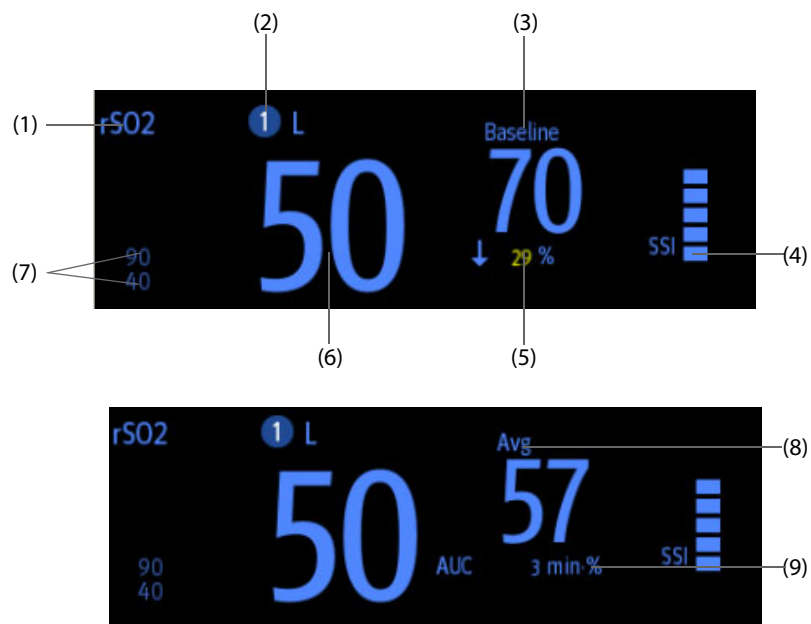

(1) rSO₂ label

(2) Channel indicator

(3) Baseline (BL)

(4) Signal Strength Indicator (SSI)

(5) Change percentage of the rSO₂ realtime value and baseline (If the rSO₂ value is greater than or equal to the baseline, the arrowhead is upward; If the rSO₂ value is smaller than the baseline, the arrowhead is downward)

(6) Realtime rSO₂ value

(7) Upper and lower rSO₂ alarm limits

(8)rSO₂ rolling average of latest 60 minutes

(9) Area Under the Curve (AUC)

25.5 Accessing the On-screen rSO₂ Guide

The monitor provides the on-screen rSO₂ guide to help you understand rSO₂ monitoring principles, functions, and operating procedure. To access the on-screen rSO₂ guide, follow this procedure:

1. Select the rSO₂ numeric area to enter the **rSO₂** dialog.
2. Select the **Introduction** tab.
3. Select the desired tab of **Summary Target Patients**, **Points To Note**, or **Operation Guides**.

25.6 Preparing for rSO₂ Monitoring

1. Select the site for sensor placement. For more information, see *25.6.1 rSO₂ Sensor Site Selection*.
2. Prepare the patient skin. For more information, see *25.6.2 Preparing the Skin*.
3. Apply the rSO₂ sensor. For more information, see *25.6.3 Applying the rSO₂ Sensor*.
4. Connect the rSO₂ parts. For more information, see *25.6.4 Connecting the rSO₂ Parts*.

25.6.1 rSO₂ Sensor Site Selection

The rSO₂ sensor can be placed on the proper cerebral or somatic site.

- Cerebral site selection: select sensor site on the right and/or left side of forehead. Placement of the sensor in other cerebral locations, or over hair, may cause inaccurate readings.
- Somatic site selection: select sensor site over tissue area of interest (site selection will determine which body region is monitored)

CAUTION

- **For cerebral site selection, do not place the sensor over nevi, sinus cavities, the superior sagittal sinus, subdural or epidural hematomas, injured skin or other anomalies such as arteriovenous malformations, as this may cause readings that are not reflective of brain tissue or no readings at all.**
- **For somatic site selection, avoid placing the sensor over thick fatty deposits, hair or bony protuberances. Do not place the sensor over nevi, hematomas or broken skin, as this may cause readings that are not reflective of somatic tissue or no readings at all.**

NOTE

- **For the somatic site selection, see the instruction for use of corresponding sensor for detailed information.**

25.6.2 Preparing the Skin

To achieve the optimal measurement result, the sensor application site should be clean and dry. To properly prepare the skin, follow this procedure:

1. Shave hair from skin at chosen sites.
2. Gently rub skin surface at sites to remove dead skin cells.
3. Thoroughly cleanse the site with a mild soap and water solution.
4. Dry the skin completely before applying the sensors.

25.6.3 Applying the rSO₂ Sensor

Follow this procedure to apply the rSO₂ sensor to patient:

1. Remove the protective backing label from the adhesive side of the sensor and apply the sensor to the skin.
2. Continue applying the sensor by smoothing it to the skin from the center outward. Ensure edges of the sensor are sealed to prevent light from entering.

CAUTION

- **The sensor is designed for single use only and can not be reused. Reuse may cause inaccurate readings, erratic readings, or no readings at all. Also, reuse may cause an increased risk of cross-contamination among patients.**
- **The sensor is designed for external use only as described in the instructions. Do not use the sensor internally for any reason.**
- **Do not place the sensor on regions with severe tissue edema to reduce the possibility of skin lesions.**
- **Do not autoclave or gas sterilize the sensor.**

NOTE

- **Use care when placing or removing sensor. Do not place on broken or undeveloped skin.**
- **For extended monitoring, it is recommended to use a new sensor every 24 hours or if adhesive is inadequate to seal the sensor to the skin.**
- **To avoid pressure sores do not apply external pressure (e.g. headbands, wraps, or tape) to sensor.**

25.6.4 Connecting the rSO₂ Parts

1. Connect Preamplifier(s) to the rSO₂ module. Align red dot on the silvery connector of the Preamplifier with red dot on rSO₂ cable connector.
2. Connect the following devices as per patient category:
 - ◆ For neonatal patients, connect the neonatal sensor directly to the Preamplifier.
 - ◆ For pediatric or adult patients, a reusable sensor cable is needed for the connection of the Preamplifier and the sensor. Use color-coding when connecting the Preamplifier and the reusable sensor cable.

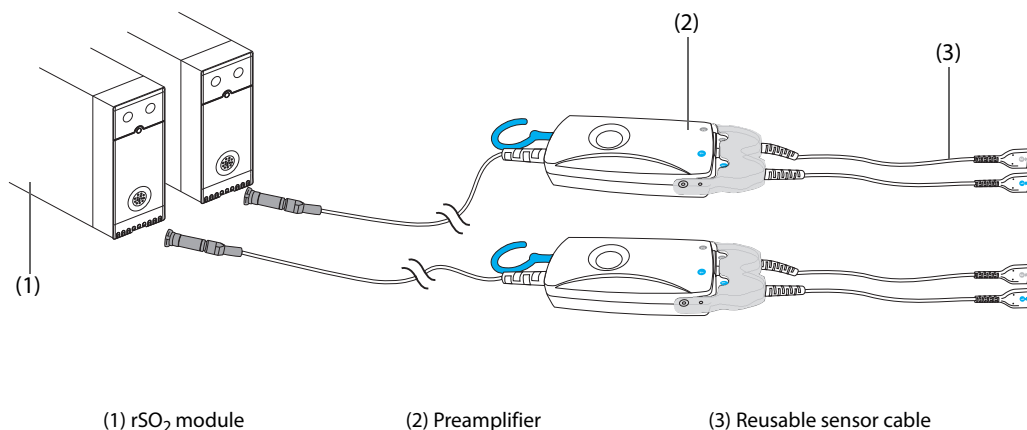

NOTE

- **Different sensors (adult, pediatric and infant/neonatal) cannot be used simultaneously on the same monitor. Cerebral sensors can be used with somatic sensors on the same monitor.**

25.7 Changing rSO₂ Settings

25.7.1 Changing rSO₂ Alarm Settings

To change the rSO₂ alarm settings, follow this procedure:

1. Select the rSO₂ numeric area to enter the **rSO2** dialog.
2. Select the **Alarm** tab.
3. Enter the password if required. For more information, refer to 33.14.3 *Selecting Password for User Authentication*.
4. Set alarm properties as desired.

25.7.2 Setting the rSO₂ Auto Low Limit Switch

To set the rSO₂ auto low alarm limit, follow this procedure:

1. Select the rSO₂ numeric area to enter the **rSO2** dialog.
2. Select the **Alarm** tab.
3. Set **Auto Low Limit** switch.
 - ◆ If **Auto Low Limit** is switched on, **rSO2-1 Variance** and **rSO2-2 Variance** are activated to allow you to set the percentage of rSO₂ low limits below the baseline. Then the monitor calculates the rSO₂ low limits automatically based on the setting.
 - ◆ If **Auto Low Limit** is switched off, the rSO₂ low limits should be set manually.

25.7.3 Setting the rSO₂ Label

To set the rSO₂ label, follow this procedure:

1. Select the rSO₂ numeric area to enter the **rSO2** dialog.
2. Select the **Setup** tab.
3. Set **rSO2-1 Label** and **rSO2-2 Label**.

25.7.4 Setting the AUC Mode

To set the AUC mode, follow this procedure:

1. Select the rSO₂ numeric area to enter the **rSO2** dialog.
2. Select the **Setup** tab.
3. Set **AUC Mode**.
 - ◆ Select **Fixed** to activate the item **Fixed Threshold**. In this case, AUC is calculated according to the configured fixed threshold.
 - ◆ Select **Below Base Percentage** to activate the item **Percentage Below Baseline**. In this case, AUC is calculated according to the configured percentage below baseline.

25.7.5 Setting the Baseline

To set the rSO₂ baseline for the respective channel, follow this procedure:

1. Select the rSO₂ numeric area to enter the **rSO2** dialog.
2. Select the **Baseline** tab.
3. Select **Set Baseline**. The monitor automatically sets the current rSO₂ value as the baseline.

You can also set the baselines for all rSO₂ channels by the following two methods:

- Select **Set Baselines** in the lower left corner of the rSO₂ dialog.
- Press the hard key at the upper right of the rSO₂ module.

Then the monitor set the baselines for all rSO₂ channels according to their respective current rSO₂ values.

NOTE

- **Set the rSO₂ value measured when patient is sober and eupractic as baseline. The baseline will be set automatically if it is not set within 5 to 6 minutes and current rSO₂ value is effective.**
-

25.7.6 Selecting rSO₂ Parameters for Display

In the rSO₂ numeric area, rSO₂ and SSI are permanently displayed parameters, and other parameters are selectable. To select the parameters for display, follow this procedure:

1. Select the rSO₂ numeric area to enter the **rSO₂** dialog.
2. Select the **Select Parameter** tab.
3. Select the parameters for display.

25.8 Covidien Information

Covidien Patents

This posting serves as notice under 35 U.S.C.§287(a) for Covidien patents: <http://www.covidien.com/patents>.

No Implied License

Possession or purchase of this device does not convey any express or implied license to use the device with unauthorized replacement parts or consumables which would, alone, or in combination with this device, fall within the scope of one or more of the patents relating to this device.

26 Review

26.1 Review Overview

Trends are patient data collected over time and displayed in graphic, tabular, or other forms to give you a picture of how the patient's condition is developing. The **Review** dialog also enables access to review the events, 12-lead ECG analysis results and waveforms, full disclosure waveforms, and so on.

26.2 Review Dialog

The **Review** dialog contains tabs to display trend data in tabular, graphic, or other forms.

26.2.1 Accessing the Review Dialog

Choose one of the following methods to enter the review dialog:



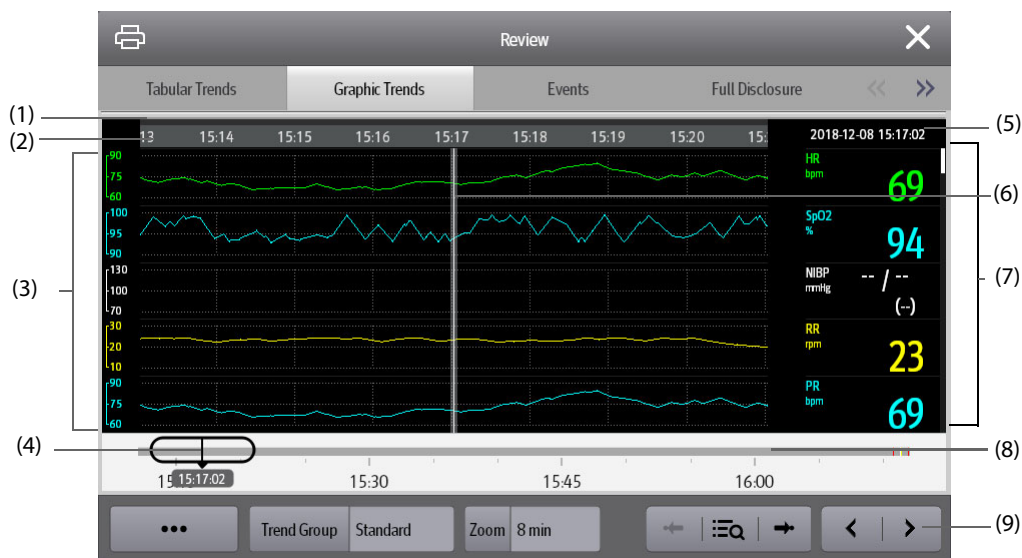

- Select the **Review** quick key.
- Select the **Main Menu** quick key → from the **Review** column select the desired option.

26.2.2 Example Review Dialog

The review pages have a common structure. The graphic trends review page is taken as an example:











- (1) Event type indicator: different color blocks match different types of events:
 - Red: high priority alarm event
 - Yellow: medium priority alarm event
 - Cyan: low priority alarm event
 - Green: manual event
 - White: operation-related event
- (2) Current screen time line: indicates the time length of the current screen.
- (3) Waveform area: displays trend curves. The color of trend curves is consistent with the color of parameter labels.

- (4) Time line: indicates the entire time length.
 - : indicates the time length of trend data.  can be moved within this time length.
 - : indicates the time length of no trend data.  cannot be moved within this time length.
 - Different color blocks along the time line indicate events of different types. See the color definition for the event type indicator.
- (5) Event area: displays the event of the cursor time. Selecting the event accesses the event list. If there is no event at the cursor time, the cursor time is displayed.
- (6) Cursor: this is adjusted by touching different locations. Adjusting this changes the data displayed in the Event area and Numeric area.
- (7) Numeric area: displays numeric values at the cursor indicated time. The background color of numeric values matches the alarm priority.
- (8) Slider: indicates the position of current screen time in the entire time length. Dragging this button left or right enables you to locate the trend data at a specific time and also refreshes trend data in current screen accordingly.
- (9) Button area.

26.2.3 Symbols on Review Pages

The following table lists the symbols on review pages.

Symbol	Description
	Slider: indicates the position of current screen time in the entire time length. Dragging the slider left or right enables you to locate the trend data at a specific time and also refreshes data in current screen accordingly.
 or 	Goes to the previous or next event.
	Event list: displays events in a chronological order. The most recent event is displayed at the top. The number of asterisk symbols before an event indicates alarm priority.
 or 	Selecting this symbol displays two review pages simultaneously.
	Record button: select it to output patient information and data through the recorder.
	Print button: select it to output patient information and data through the printer.
+	Indicates that the followed parameter is from an external device connected to the monitor via the BeneLink module.

26.2.4 Common Operations

This section describes common operations for all review pages.

26.2.4.1 Browsing Trend Data

Browse trend data in one of the following ways:



- Move the cursor.
- Move the slider .
- Slide your finger on the screen.

26.2.4.2 Viewing Events

You can view the following types of events:

- Manually triggered events
- Parameter-related operation events and alarm-related events, such as starting NIBP measurement
- Operation events not related to parameters, such as system time change

View events in either of the following ways:



- Select  and select the desired event.
- Select  or  to jump to the previous event or next event.

Events are displayed in a chronological order. The most recent event is displayed at the top. The number of asterisk symbols before an event indicates alarm priority as follows:

- ***: high priority alarm
- **: medium priority alarm
- *: low priority alarm

26.2.4.3 Displaying Two Review Pages Simultaneously

For N22/N19, you can display two review pages simultaneously. To do so, follow this procedure:

1. Enter the desired review page by one of the following methods:
 - ◆ Select the **Review** quick key → select the desired tab.
 - ◆ Select the **Main Menu** quick key → from the **Review** column select the desired item.
2. Select  (for landscape display) or  (for portrait display) to open a duplicate view that can be navigated independently.

26.2.5 Tabular Trends Review Page

The tabular trends review page displays trend data in a tabular form.

26.2.5.1 Entering the Tabular Trends Review Page

Choose one of the following methods to enter the tabular trends review page:

- Select the **Review** quick key → select the **Tabular Trends** tab.
- Select the **Main Menu** quick key → from the **Review** column select **Tabular Trends**.



26.2.5.2 Changing the Tabular Trend Group

To change the tabular trend group, follow this procedure:

1. Enter the tabular trends review page.
2. Set **Trend Group**.

26.2.5.3 Editing the Tabular Trend Group

The setting of the **Trend Group** defines the contents of displayed trends. It is possible to edit any trend group except for the **All** and **Standard** trend groups. To do so, follow this procedure:

1. Enter the tabular trends review page:
2. Select **Group Setup** → select the desired tab.
 - ◆ Rename the trend group (optional): select the  symbol at the upper left corner and input the desired name.
 - ◆ Add parameters: select desired parameters from the **Choices** column, and then select **Add**. Selecting **Add All** adds all parameters (up to the maximum of 83).
 - ◆ Delete parameters: select desired parameters from the **Selected** column, and then select **Delete**. Selecting **Delete All** deletes all parameters except for HR.
 - ◆ Move the position of parameters displayed on the trend page: select desired parameters from the **Selected** column, and then select **Move up**, **Move Down**, **Move to Top**, or **Move to Bottom**.
 - ◆ Display two parameters side by side: select two parameters from the **Selected** column, and then select **Overlap**. Then, the symbol  appears at the right of the overlapped parameters. The overlapped parameters will be displayed side by side in one numerics area and waveform area.
 - ◆ Unoverlap two parameters: select the overlapped parameters from the **Selected** column, and then select **Unoverlap**.

Selecting **Default** will restore the trend group settings to factory defaults.

NOTE

- **Trend groups labeled All or Standard cannot be edited.**
 - **The HR parameter and waveform are always displayed in the first row on the trend page. It cannot be deleted or moved.**
-

26.2.5.4 Changing the Resolution of Tabular Trend Data

The interval of tabular trends defines the interval of displaying trend data. A short interval is especially suited for neonatal applications, where the clinical situation may change very quickly. In adult monitoring, where the patient's status typically changes more gradually, a longer interval may be more informative.

To change the interval of trend data, follow this procedure:

1. Enter the tabular trends review page.
2. Select **Interval**.
 - ◆ **5 sec** or **30 sec**: select to view up to 4 hours of tabular trends at an interval of 5 seconds or 30 seconds.
 - ◆ **1 min, 5 min, 10 min, 15 min, 30 min, 1 hr, 2 hrs, or 3 hrs**: select to view up to 120 hours of tabular trends at selected interval.
 - ◆ Select parameters, such as NIBP, or GCS, to view the tabular trends when these parameter measurements are acquired.

NOTE

- **Changing between intervals does not typically change the position of the slider or cursor except to round it to the nearest interval, however changing intervals to be 30 seconds or less will move any cursor position more than 4 hours ago to the oldest data less than 4 hours ago.**
-

26.2.5.5 Printing a Tabular Trends Report

To print a tabular trends report, follow this procedure:

1. Enter the tabular trends review page.
2. Select  to enter the **Print Setup** dialog.
3. Set the tabular trends report as described in *30.6.3 Configuring Tabular Trends Reports*.
4. Select **Print** or **Print (All)**.
 - ◆ **Print**: the trend data before the above set **Time**, for the above set **Period**, and at the above set **Interval** will be printed.
 - ◆ **Print (All)**: all the stored trend data will be printed at the review interval.

26.2.5.6 Recording Tabular Trends

To print tabular trends with the recorder, follow this procedure:

1. Enter the tabular trends review page.
2. Select  to enter the **Record Setup** dialog.
3. Respectively set **Start Time** and **End Time** of the tabular trends data.
4. Select **Record** or **Record (All)**.
 - ◆ **Record**: the trend data between the **Start Time** and **End Time** will be recorded.
 - ◆ **Record (All)**: all the stored trend data at the review interval will be recorded.

26.2.6 Graphics Trends Review Page

The graphic trends review page displays trend data in a visual format.

26.2.6.1 Entering the Graphic Trends Review Page

Choose one of the following methods to enter the graphic trends review page:

- Select the **Review** quick key → select the **Graphic Trends** tab.
- Select the **Main Menu** quick key → from the **Review** column select **Graphic Trends**.

26.2.6.2 Changing the Graphic Trend Group

To change the graphic trend group, follow this procedure:

1. Enter the graphic trends review page.
2. Set **Trend Group**.

26.2.6.3 Editing the Graphic Trend Group

1. Enter the graphic trends review page.
2. Select **Group Setup**.

For more information, see 26.2.5.3 *Editing the Tabular Trend Group* for detail on how to edit the group.

26.2.6.4 Changing the Resolution of Trend Data

To change the length of trend data displayed on the current screen, follow this procedure:

1. Enter the graphic trends review page.
2. Select **Zoom**.
 - ◆ **8 min**: the screen displays eight minutes of trend data. You can view the most recent one hour of data.
 - ◆ **30 min, 1 hr, 2 hrs, 4 hrs**: the screen displays 30 minutes, one hour, two hours, or four hours of trend data. You can view the most recent four hours of data.
 - ◆ **8 hrs, 12 hrs, 24 hrs, 48 hrs**: the screen displays 8 hours, 12 hours, 24 hours, or 48 hours of trend data. You can view the most recent 120 hours of data.

26.2.6.5 Changing the Number of Waveforms

To change the number of waveforms displayed on the trend review page, follow this procedure:

1. Enter the graphic trends review page.
2. Select **Trends**.

26.2.6.6 Printing a Graphic Trends Report

To print a graphic trends report, follow this procedure:

1. Enter the graphic trends review page.
2. Select  to enter the **Print Setup** dialog.
3. Set the graphic trends report as described in 30.6.4 *Configuring Graphic Trends Reports*.
4. Select **Print** to print the graphic trend data before the above set **Time** and for the above set **Period**.

26.2.7 Events Review Page

The monitor stores events in real time, including technical alarm events, physiological alarm events, manual events, and operational events. When an event occurs, all the measurement numerics and three event-related waveforms 16 seconds before and after the event are stored.

NOTE

- **Alarms are saved as events and will be maintained if the equipment is powered down. The time of equipment power down is not recorded as an event and cannot be reviewed.**
- **Earlier events will be overwritten by later ones if the storage capacity is reached.**
- **A total loss of power does not affect the events already stored.**

26.2.7.1 Entering the Events Review Page

Choose one of the following methods to enter the events review page:

- Select the **Review** quick key → select the **Events** tab.
- Select the **Main Menu** quick key → from the **Review** column select **Events**.

The **Event** page displays the event list. Events are displayed in descending chronological order, with the most recent displayed at the top. The number of asterisk symbols before an event indicate alarm priority as described in 8.3.3 *Alarm Indicators*.

Different color blocks are displayed on the left of each event to indicate different event types.

- Red: high priority alarm event
- Yellow: medium priority alarm event
- Cyan: low priority alarm event
- Green: manual event
- White: operation-related event

The number of currently selected events and the total number of events are displayed at the top right corner of the event list. For example, 2/4 indicates that the selected event is the second event in the filtered events and the total number of filtered events is 4. **Total** indicates the total number of events. For example: **Total: 28** means that there are a total of 28 events.

26.2.7.2 Configuring the Filter

You can filter events to facilitate event review. To configure the filter, follow this procedure:

1. Enter the **Events** page.
2. Select **Filter**. From the drop-down list, select the desired filter item.

You can create up to two sets of custom filter. To do so, follow this procedure:

1. From the **Filter** drop-down list, select **Custom 1** or **Custom 2** to enter the **Filter Setup** menu.
2. Select the **Name** field to edit the name of the custom filter criterion.
3. Select the desired items.

If you want to review events which happened around certain time, select the  button → set the time → select **Ok**. The cursor then jumps to the event happened closest to the time entered.

26.2.7.3 Editing Events

To edit events, follow this procedure:

1. Enter the **Events** page and tick off the desired events.
2. Select  to edit the selected events.
 - ◆ **Lock**: manually lock the event. Locked events cannot be deleted.
 - ◆ **Note**: enter comments for the event.
 - ◆ **Rename**: allow renaming an event name. Only manual events and arrhythmia events can be renamed if enabled by the hospital's settings.

26.2.7.4 Viewing Event Details

To view waveforms and parameter values at the event time, follow this procedure:

1. Enter the **Events** page.
2. Select **Detail**.

To display beat labels on the first ECG waveform, switch on **Beat Anno**. The white beat labels indicate heart beats classification and may explain suspected, missed, or false arrhythmia calls. Heart beats are classified as follows:

- N = Normal
- V = Ventricular ectopic

- S = Supraventricular premature
- P = Paced
- L = Learning
- ? = Insufficient information to classify beat
- I = Inoperative (for example, Lead Off)
- M = Missed beat

If you switch on **Beat Anno** on the **Events** page, beat labels will also be displayed on the **Full Disclosure** page, and vice versa. Beat labels can be printed out.

26.2.7.5 Printing Event Reports

To print event reports via a printer, follow this procedure:

1. Enter the events review page.
2. Select  to enter the **Print Setup** dialog.
3. Select the desired options.
 - ◆ **Print All Event List:** print the entire event list.
 - ◆ **Print List of Selected Events:** print the list of selected events.
 - ◆ **Print Detail of Selected Events:** print the details of selected events.
 - ◆ **Print Displayed Event Detail:** print the waveforms and parameters of the currently displayed event.
4. Select **Print**.

26.2.7.6 Recording Event Details

To print events details via a recorder, follow this procedure:

1. Enter the events review page.
2. Select the **Detail** button.
3. Select  to print the details of the event.

NOTE

- **When a parameter label is prefixed with the plus sign (+) on a printout, it indicates that the data is from an external device.**

26.2.8 Full Disclosure Review Page

You can review up to 48 hours of waveform data on the full disclosure review page. You can view both the compressed waveforms and numeric values.

26.2.8.1 Entering the Full Disclosure Review Page

Choose one of the following methods to enter the full disclosure review page:

- Select the **Review** quick key → select the **Full Disclosure** tab.
- Select the **Main Menu** quick key → from the **Review** column select **Full Disclosure**.

26.2.8.2 Selecting Waveforms

You can select the waveforms to be displayed and stored. Up to 48 hours of waveforms for all parameters can be stored. When closing the **Select Waveform** dialog, a prompt will inform you of the duration of waveforms that can be saved if the amount is less than 48 hours. To save and display the desired waveforms, follow this procedure:

1. Enter the full disclosure review page.
2. Select **Setup** to enter the **Select Waveform** page.

3. Select the **Storage** tab and set the desired waveforms to be stored in the monitor. Select the **Display (Maximum: 3)** tab and set the desired waveforms to be displayed on the **Full Disclosure** page.

NOTE

- **Storing more waveforms may shorten the storage time to less than 48 hours. Please adjust the waveforms stored with this consideration.**
 - **Parameter labels from external devices are prefixed with the plus sign (+).**
-

In case of alarms, the background of the compressed waveform is highlighted with a colored block during the alarm time:

- Red: high alarm priority
- Yellow: medium alarm priority
- Cyan: low alarm priority

26.2.8.3 Setting the Scale and Duration

To set the length and size of displayed compressed waveforms, follow this procedure:

1. Enter the full disclosure review page.
2. Set the waveforms scale in either of the following ways:
 - ◆ Select the **Scale** button. If you do not see **Scale**, select the  button to show it.
 - ◆ Select the waveform label.
3. Select **Duration** to set the length of displayed waveforms.
4. Select the parameter label beside the waveforms to set scale for each parameter.

26.2.8.4 Viewing Details of Compressed Waveforms

To view the full waveforms and numeric values, follow this procedure:

1. Enter the full disclosure review page.
2. Select **Detail**.

You can perform the following operations on the this page:

- Switch on **Beat Anno**. For more information, see *26.2.7.4 Viewing Event Details*.
- Select **Speed**, **ECG Gain**, or **Save As Event**. If you do not see an option, then select the  button to show it.
- Select **Overview** to switch to the compressed waveform view.

26.2.8.5 Printing the Full Disclosure Waveform Report

To print a compressed waveform report, follow this procedure:

1. Enter the full disclosure review page.
2. Select  to enter the **Print Setup** dialog.
3. Select waveform type you want to print:
 - ◆ **Print Waveform Overview**: compressed waveform of selected period will be printed. This option is only available when printing from the Overview or compressed waveform view.
 - ◆ **Print Displayed Waveform Detail**: parameter values and all stored waveforms around the cursor time will be printed. This option is only available when printing from the Detail view.
4. Select **Print**.

NOTE

- **When a parameter label is prefixed with the plus sign (+) on a printout, it indicates that the data is from an external device.**
-

26.2.8.6 Recording the Details of the Compressed Waveform

To record a Full Disclosure Detail Record Report, follow this procedure:

1. Enter the **Full Disclosure** page.
2. Select **Detail**.
3. Select .

NOTE

- **When a parameter label is prefixed with the plus sign (+) on a printout, it indicates that the data is from an external device.**
-

26.2.9 Arrhy Statistics Review Page

The **Arrhy Statistics** review page shows arrhythmia events happened over the lastest 24 hours. This page is only available with the ECG 24h Summary option.

To enter the **Arrhy Statistics** review page, choose one of the following methods:

- Select the **Review** quick key → select the **Arrhy Statistics** tab.
- Select the **Main Menu** quick key → from the **Review** column select **Arrhy Statistics**.

Selecting each type of arrhythmia statistics bar shows compressed waveforms, the time and duration of each arrhythmia event. Selecting the compression waveform shows the event details.

26.2.10 OxyCRG Review Page

You can review up to 48 hours worth of 4 minute trend curves on the OxyCRG review page. The OxyCRG review functionality is available for neonatal monitoring only.

NOTE

- **OxyCRG Review Page is available only when Patient Category is set to Neo.**
-

26.2.10.1 Entering the OxyCRG Review Page

Choose one of the following methods to enter the OxyCRG review page:

- From the OxyCRG screen, select the ABD events list area.
- Select the **Review** quick key → select the **OxyCRG** tab.
- Select the **Main Menu** quick key → from the **Review** column select **OxyCRG**.

26.2.10.2 The Display of the OxyCRG Review Page

The following figure shows the OxyCRG screen:

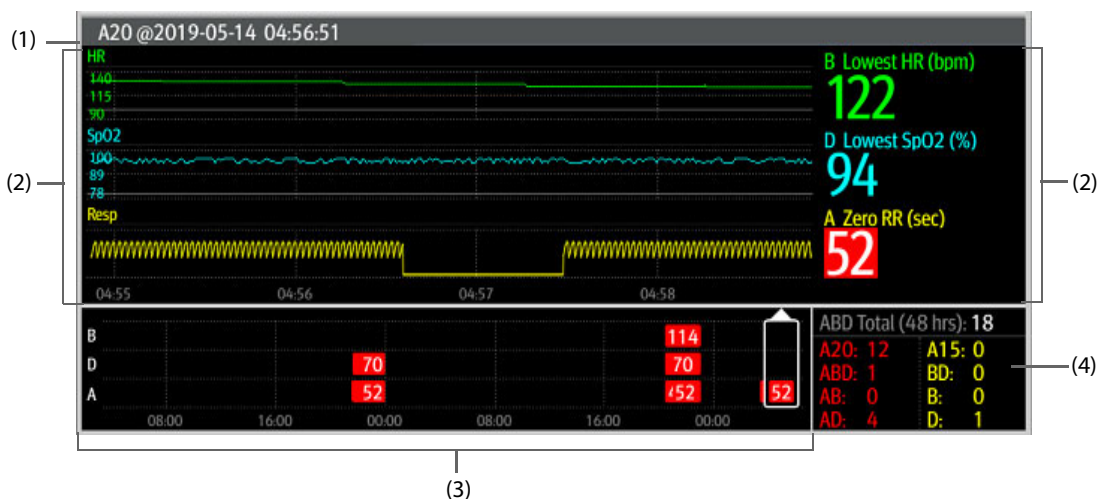

- (1) Event title area: displays information of the selected event, such as the event type and time.
- (2) Event detail area: displays 4 minutes of parameter trends and compressed waveform, and parameter values of the selected event.
- (3) Event summary area: displays ABD events within the **Zoom** period. The selected event is enclosed in a white frame.
- (4) Event statistics area: displays the total number of ABD events and the numbers of each event within the **Zoom** period.

26.2.10.3 Changing the Resolution of Trend Curves

To set the resolution of trend curves, follow this procedure:

1. Enter the OxyCRG review page.
2. Set **Zoom**.

NOTE

- If the **Zoom** is set for a large duration (for example, 8 hrs), the screen may show "No Patient Data" for the first several minutes of data collection (for example, 6 minutes), but data will be shown after enough data has been collected.

26.2.10.4 Printing an OxyCRG Review Report

To print an OxyCRG review report, follow this procedure:

1. Enter the OxyCRG review page.
2. Select  to enter the **Print Setup** dialog.
3. Select **Print**. The report duration corresponds to the duration of data shown on the screen.

26.2.11 12-Lead ECG Review Page

When 12-lead ECG analysis is performed, you can review the most recent 20 events of 12-lead analysis. For more information, see *10 Resting 12-Lead ECG Analysis*.

26.2.11.1 Entering the 12-Lead Review Page

Choose one of the following methods to enter the 12-lead ECG review page:

- Upon completion of 12-lead ECG analysis, select **Review** from the **12-Lead Interpretation** page. For more information, see *10 Resting 12-Lead ECG Analysis*.
- Select the **Review** quick key → select **12-Lead ECG**.
- Select the **Main Menu** quick key → from the **Review** column select **12-Lead ECG**.

26.2.11.2 Switching to Median Complex (for Glasgow Algorithm Only)

The median complex template displays 12-lead ECG waveforms on one page in 4 columns, with 3 lines in each column, and one rhythm lead waveform at the bottom. Additionally, a short vertical bar appears above each waveform, marking the start and end positions of the P-wave and the QRS-wave and the end position of T-wave.

To view Median Complex, follow this procedure:

1. Enter the 12-lead review page.
2. Select **Median Complex**.

Selecting **Waveform** can return to the 12-lead ECG waveform page.

26.2.11.3 Setting 12-Lead ECG Waveforms

To set the 12-lead ECG waveforms on the review page, follow this procedure:

1. Enter the 12-lead review page.
2. Set **Speed**, **Gain**, and **Layout**.

26.2.11.4 Printing the 12-Lead ECG Report

To print the 12-Lead ECG report, follow this procedure:

1. Enter the 12-lead review page.
2. Select .
3. Configure the 12-lead ECG report.
4. Select **Print**.

26.2.11.5 Recording the 12-Lead ECG Report

To print the 12-Lead ECG report via the recorder, follow this procedure:

1. Enter the 12-lead review page.
2. Select .

26.2.12 ST Review Page

When ST analysis is enabled, the monitor saves ST segments and values at an interval of one minute. You can review the latest 120 hours of ST data.

26.2.12.1 Entering the ST Review Page

Choose either of the following methods to enter the ST review page:

- Select the **Review quick key** → select the **ST** tab.
- Select the **Main Menu** quick key → from the **Review** column select **ST**.

26.2.12.2 Setting the ST Reference

You can set the currently displayed ST as reference. To do so, follow this procedure:

1. Enter the ST review page.
2. Select **Set Reference**.

NOTE

- **The ST baseline is used as ST reference by default.**

26.2.12.3 Displaying/Hiding the ST Reference

To display or hide ST reference, follow this procedure:

1. Enter the ST review page.
2. Select **Display Reference** or **Hide Reference**.

26.2.12.4 Displaying/Hiding Markers

To display or hide markers, follow this procedure:

1. Enter the ST review page.
2. Select **Display Marker** or **Hide Marker**.

26.2.12.5 Printing ST Data

To print ST data, follow this procedure:

1. Enter the ST review page.
2. Select .

26.3 Reviewing Discharged Patients

For discharged patients, you can review the trend data in the review page. You can also review the events and 12-lead ECG analysis results.

26.3.1 Checking the Data of a Discharged Patient

1. Access the **Discharged Patients** dialog box by either of the following ways:
 - ◆ Select the **Discharged Patients** quick key.
 - ◆ Select the **Main Menu** quick key → from the **Patient Management** column select **Discharged Patients**.
2. From the patient list select the desired patient.
3. Select **Detail**.

26.3.2 Checking the Information of a Discharged Patient

1. Access the data of the discharged patient as described in 26.3.1 *Checking the Data of a Discharged Patient*.
2. Select the  icon to enter the **Patient Management** dialog box.
3. Select **Ok** to exit the **Patient Management** dialog box.

27 Clinical Assistive Applications (CAA)

The Clinical Assistive Applications (CAA) function integrates some commonly used clinical guidelines and tools into the monitor. It puts the currently monitoring parameter measurements together and provides comprehensive analysis results.

CAA can improve the clinician's working efficiency. However, it is not directly used for diagnosis and cannot not replace the clinician's judgement.

27.1 Checking Software Licenses

Licenses are required to run the following CAA functions in the monitor:

- BoA Dashboard
- HemoSight
- Early Warning Score (EWS)
- SepsisSight
- CPR Record
- ECG 24h Summary

To check the licenses, select the **Main Menu** quick key → select **License** → **Local**.

To install the licenses, follow this procedure:

1. For N17/N15/N12, connect the USB drive with the licenses in to the monitor's USB connector. For N22/N19, connect the USB drive to the monitor's MSB connector.
2. Select the **Main Menu** quick key →select **License** → select **External**.
3. Select **Install**.

27.2 BoA Dashboard™

The Balance of Anesthesia (BoA) Dashboard helps the clinicians to monitor the patient's status during anesthetic induction, maintenance, and postoperative recovery.

NOTE

- **BoA Dashboard is only available when Department is set to OR.**
-

27.2.1 Accessing BoA Dashboard™

Access BoA Dashboard in any of the following ways:

- Select the **BoA Dashboard** quick key.
- Select the **Screen Setup** quick key → Select the **Choose Screen** tab → select **BoA Dashboard**.
- Select the **Main Menu** quick key → from the **CAA** column select **BoA Dashboard**.

BoA Dashboard has three pages:

- Induction
- Maintenance
- Recovery

27.2.2 Induction

Select the **Induction** tab to enter the **Induction** page. You can check parameter minitrends and apnea time from the **Induction** page.

Select **Induction** to start apnea detection, mark the induction event, and start an NIBP STAT measurement. The systolic pressure value will be saved as the reference.

The following figure shows the **Induction** page. Your display may be configured to look slightly different.

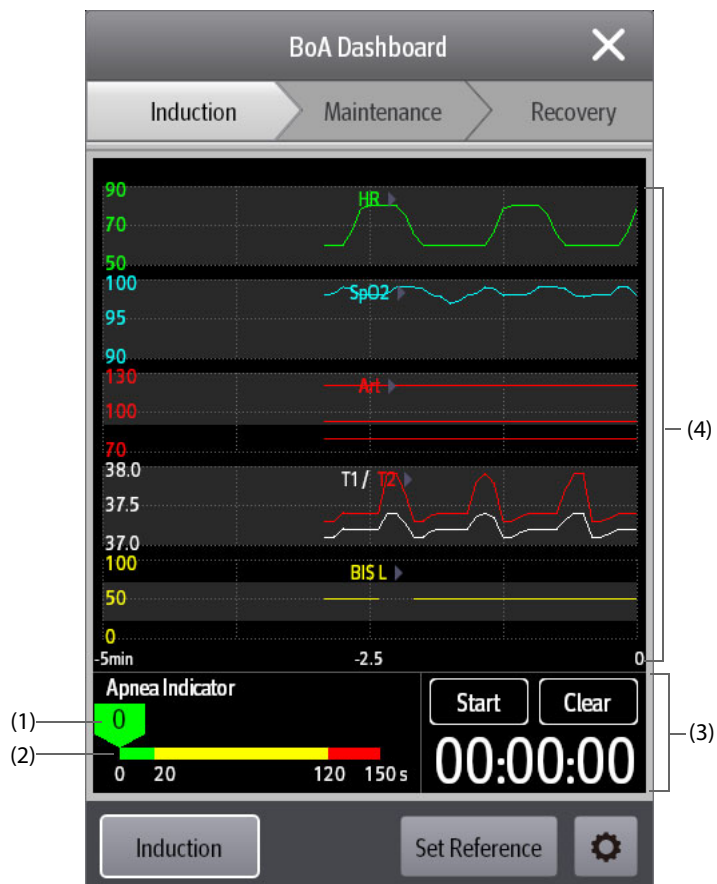

- (1) Cursor: indicates the current apnea time.
- (2) Apnea indicator: provides apnea time scale.
- (3) Timer: displays the time elapsed since the timer was started.
- (4) Minitrends area: provides parameter minitrends. You can select the parameters you want to view. For more information, see 27.2.5.1 *Selecting Parameters for Viewing Trends*.

27.2.3 Maintenance

You can check the patient's parameter trends, anesthesia status, and triple low status.

Select **Anesthesia Status** or **Triple Low** to choose the indicator.

The anesthesia status indicator presents the patient's status in terms of pain, consciousness, and neuromuscular blockage.

The triple low indicator presents BIS, MAC and mean pressure. Postoperative mortality and hospital stay are increased in patients having low MAC and low blood pressure. With low BIS value, the postoperative mortality and hospital stay are further increased. (Sessler et al: Hospital Stay and Mortality Are Increased in Patients Having a "Triple Low" of Low blood Pressure, Low Bispectral Index, and Low Minimum Alveolar Concentration of Volatile Anesthesia. *Anesthesiology* 2012; 116: 1195–203)

The following figures show the anesthesia status indicator and triple low indicator:

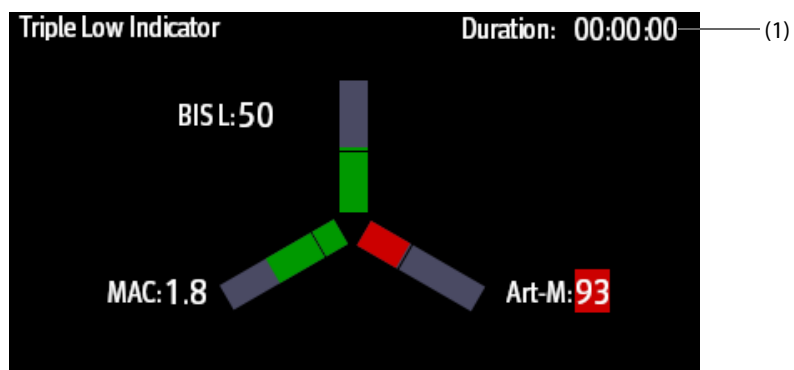
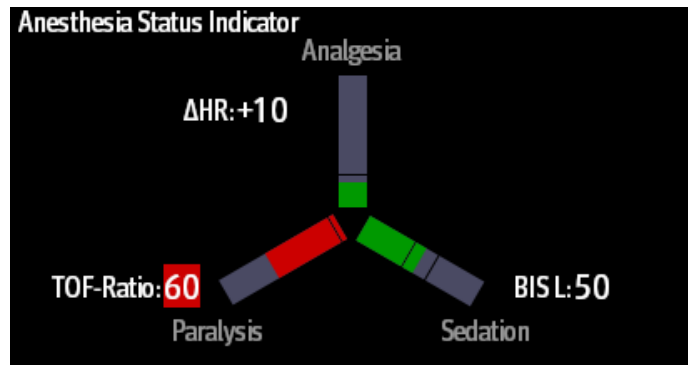

(1) Total triple low duration: if BIS, MAC, and Art-M values are lower than the threshold, the patient is in triple low status. For information on setting the triple low threshold, see 27.2.5.5 *Setting Thresholds for Triple Low Parameters*.

- The three arms of the anesthesia status indicator respectively indicate pain (Analgesia), consciousness (Sedation), and neuromuscular blockage (Paralysis). You can select parameters for the anesthesia status indicator. For more information, see 27.2.5.2 *Selecting Parameters for Anesthesia Status Indicator*.
- The three arms of the triple low indicator respectively indicate BIS, MAC, and mean blood pressure.
- The length of the filling indicates parameter value.
- The color of the arms indicates parameter status: green indicates that parameter value is within normal range. Red indicates that parameter value is beyond normal range. Gray indicates that parameter value is unavailable or invalid.
- The black lines on the parameter arms indicate the normal range of corresponding parameters.

27.2.4 Recovery

You can view parameter trends from the **Recovery** page.

Select **Aldrete Score** to show the latest score and scoring time. To understand the current patient status, select a score for each item and then select **Confirm** to get a new score.

WARNING

- **The Aldrete score and recommendation is for reference only. Clinicians must make the decision of discharging the patient from recovery according to the patient's actual condition.**
-
-

27.2.5 Setting the BoA Dashboard

From the BoA Dashboard, you can set the parameters, anesthesia status indicator, and triple low indicator.

27.2.5.1 Selecting Parameters for Viewing Trends

You can view the trends of up to 6 parameters from the **Maintenance** page and **Recovery** page.

To select the parameters you want to view, use either of the following ways:

- Select .
 - ◆ Select the **Maintenance** tab or **Recovery** tab to set the parameters you want to view.
 - ◆ Selecting **Defaults** resumes the default setting.
- Select a parameter on the trend view, and set which parameter you want to display in this position.

27.2.5.2 Selecting Parameters for Anesthesia Status Indicator

In the anesthesia maintenance stage, you can evaluate the patient's pain status by heart rate and/or blood pressure values. You can evaluate the patient's consciousness status by BIS or MAC value. The neuromuscular blockage status is evaluated by NMT.

To select parameters for the anesthesia status indicator, follow this procedure:

1. Select .
2. Select the **Maintenance** tab.
3. From the **Parameters** area, set **Analgesia** and **Sedation**.

27.2.5.3 Setting References for Heart Rate and Systolic Blood Pressure

The current heart rate and systolic blood pressure references are displayed as white lines in minitrends area. To set the references, follow this procedure:

1. Select **Set Reference**.
2. Select **Ok** to set the current HR and BP-S measurements as the reference. You can also input HR and BP-S values and then select **Ok**.

You can also follow this procedure to set HR and BP-S reference:

1. Select .
2. Select the **Maintenance** tab.
3. From the **Reference** area, set **HR** and **BP-S**.

27.2.5.4 Setting Thresholds for Anesthesia Status Parameters

To set low limits for anesthesia status parameters, follow this procedure:

1. Select .
2. Select the **Maintenance** tab.
3. From the **Threshold** area, set threshold for each parameter.

27.2.5.5 Setting Thresholds for Triple Low Parameters

To set low limits for triple low parameters, follow this procedure:

1. Select .
2. Select the **Maintenance** tab → **Triple Low** tab.
3. Set low limits for BIS, MAC, and MAP.

The ranges of the thresholds for triple low parameters are as follows:

Parameter	Range	Default setting
BIS	0 - 100	46
MAC	0 - 3.0	0.6
MAP	Adult: 20 -230 mmHg Pediatric: 20 - 165 mmHg Neonate: 20 - 110 mmHg	87 mmHg

27.3 Early Warning Score (EWS)

The Early Warning Scores (EWS) can help you recognize the early sign of deterioration in patients based on vital signs and clinical observations. It is based on the "Royal College of Physicians (2015) National Early Warning Score (NEWS2): Standardizing the assessment of acute illness severity in the NHS, Report of a Working Party. RCP, London. Depending on the score calculated, appropriate recommendations are displayed.

The monitor supports the following scores:

- MEWS (Modified Early Warning Score)
- NEWS (National Early Warning Score)
- NEWS2 (National Early Warning Score 2)
- Custom Score

There are two types of scoring tools:

Total score: A subscore is given for each parameter based on the measured or entered value. When all the required parameters are entered or measured, the subscores are added together to calculate the total early warning score. Each subscore has a color coding to indicate associated level of risk. When the total score is outside of the thresholds, actions are recommended. MEWS, NEWS and NEWS2 can give total scores.

- **IPS (individual parameter score):** A color-coded score is given for each parameter based on the measured or entered value. Each parameter has upper and lower thresholds. When an individual parameter measured or entered is outside of the thresholds, actions are recommended.

Custom Score is based on user-defined parameters. It can be a total score or an IPS, depending on the configuration.

MEWS, NEWS and NEWS2 are intended for adult patients only. The patient category applied to the Custom Score is defined by the Mindray Clinical Score Configuration Tool. For more information, see *Mindray Clinical Scoring Config Tool Instruction for Use (P/N: 046-012986-00)*.

WARNING

- **EWS is not intended for pediatric and neonatal patients.**
- **The default settings for IPS and Custom Scoring are based on the scoring system used by MEWS and NEWS, which have only been clinical validated in the adult population. If you choose to use this feature for pediatric patients, you may need to customize the scoring system to reflect any relevant differences between adult and pediatric patients.**
- **The EWS scores and recommended actions are for reference only and cannot be directly used for diagnostic interpretation.**
- **EWS cannot be used as an prognosis index. It is not a clinical judgement tool. Clinicians must use their clinical judgement in conjunction with the EWS tool at all times.**

- **MEWS and NEWS are intended for adult patients only. NEWS is not applicable to pregnant woman and COPD (Chronic Obstructive Pulmonary Disease) patients.**

NOTE

- **The EWS scores does not trigger any alarms and cannot used for continuous monitoring.**

27.3.1 Displaying the EWS Numerics Area

To display the EWS numerics area, follow this procedure:

1. Access **Tile Layout** in either of the following ways:
 - ◆ Select the **Screen Setup** quick key → select the **Tile Layout** tab.
 - ◆ Select the **Main Menu** quick key → from the **Display** column select **Tile Layout**.
2. Select the parameter area where you want to display the EWS score, and then from the popup list select **EWS**.

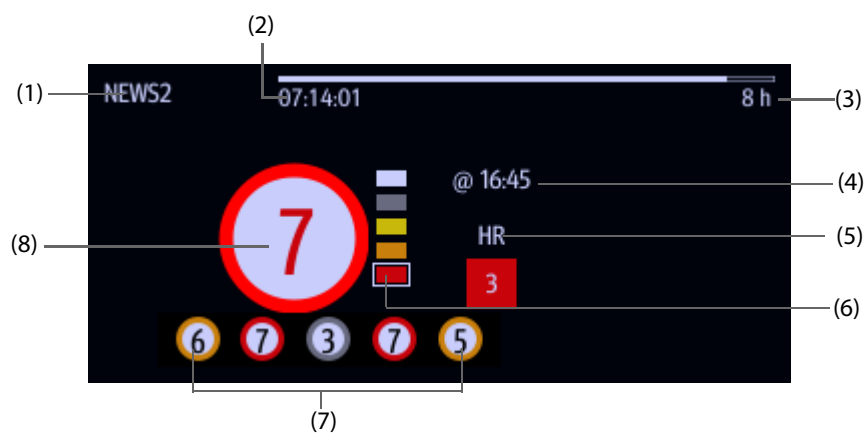

- (1) EWS protocol label
- (2) Scoring countdown: time to the next scoring.
- (3) Scoring interval
- (4) The scoring time
- (5) Single parameter whose score reaches 3
- (6) Risk level indicator. The level of risk increases from top down. For IPS, this indicator does not display. The current level is enclosed by a white square frame.
- (7) History total score. The rightmost one is the latest history score.
- (8) Total score. The color of the circle indicates the level of risk. For IPS, no score is displayed. Only level of risk is shown: white means normal and red indicates alert.

27.3.2 Accessing the EWS Screen

Access the EWS window in any of the following ways:

- Select the EWS parameter area
- Select the **EWS** quick key.
- Select the **Screen Setup** quick key → select the **Choose Screen** tab → select **EWS**.
- Select the **Main Menu** quick key → from the **CAA** column select **EWS**.

When the EWS screen is hidden as , you can also choose one of the following methods to quickly enter the EWS screen.

- Swipe left or right across the touchscreen with two fingers until you switch to the EWS screen.
- Swipe right across the touchscreen with a single finger,

- Select the  button,

Take NEWS2 as an example, the EWS screen is shown as follows. Your screen may be slightly different due to the configuration.

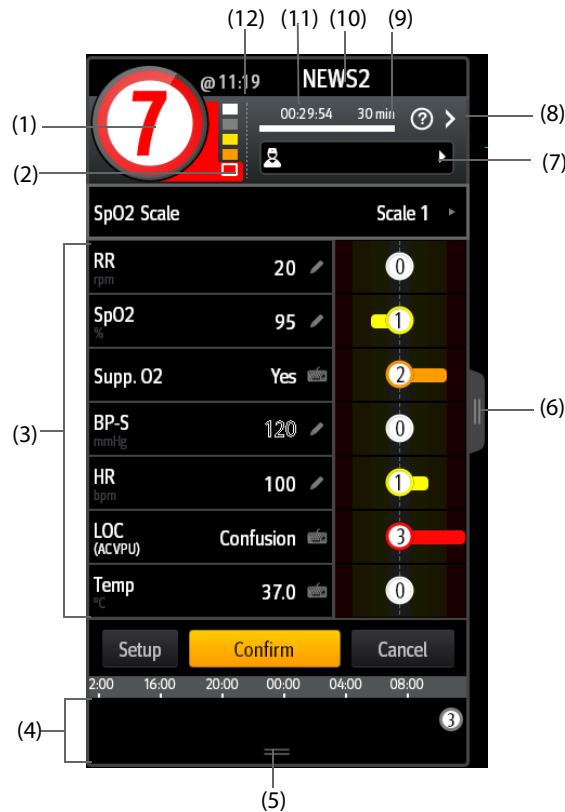

- (1) Total score. The color of the circle indicates the level of risk. For IPS, no numeric score is displayed. Only level of risk is shown: white means normal and red indicates alert by default.
- (2) Risk level indicator. The level of risk increases from top down. The current level is enclosed by a white frame. For IPS, this indicator does not display.
- (3) Parameter area: display the subscore and parameter value of each parameter. The keyboard symbol indicates that the parameter value is manually entered.
- (4) History total scores area: selecting this area or swiping up with one finger can review the trends of total score and each subscore
- (5) Selecting this button expands the History Total Scores area where you can review the trends of the total score and each subscore.
- (6) Selecting this button or swiping right across the screen with one finger displays the trends of total score and parameter values for scoring.
- (7) Clinician ID (displays only when the Clinician ID is enabled): allows inputting the Clinician ID to associate with the EWS score. For more information, see 33.4.1 *Enabling Inputting the Clinician ID*.
- (8) Select this button to see the clinical response to the current score
- (9) Scoring interval
- (10) EWS protocol label
- (11) Scoring countdown: time to the next scoring.
- (12) The scoring time

27.3.3 Performing EWS Scoring

To perform scoring, follow this procedure:

1. Select **Reset** to clear the previous score and update values of currently monitored parameters and relevant subscores.
2. For NEWS2, set the **SpO2 Scale**.
 - ◆ **Scale 1:** for patient without hypercapnic respiratory failure.
 - ◆ **Scale 2:** for patients with a prescribed oxygen saturation requirement of 88–92% (for example, in patients with hypercapnic respiratory failure).
3. Measure or manually enter other required parameters and observations.
4. If the clinician ID is enabled, input the clinician information by selecting , and then manually entering the information, or by scanning the clinician's barcode.
5. Select **Calculate** to get the total score.
6. If **Score Confirmation** is enabled, select **Confirm** to save current scoring, or select **Cancel** to give up current scoring. Refer to section 27.3.4.2 *Setting the Scoring Confirmation Switch* for more information.

CAUTION

- **The decision to use Scale 2 of the SpO2 Scale should be made by a competent clinical decision maker and should be recorded in the patient's clinical notes.**

NOTE

- **Before calculating the score, select Reset to clear the previous score.**
- **The keyboard symbol at the right of the parameter value indicates that the value is manually entered.**
- **You can get the score only when all required parameters have been measured or entered.**
- **When a patient is discharged, or the monitor is turned off, the clinician ID is cleared**

27.3.4 Changing EWS Settings

27.3.4.1 Changing the Scoring Protocol

The monitor is configured with a default scoring protocol. To change the scoring protocol, follow this procedure:

1. From the EWS page select **Setup**.
2. Set **Score**.

27.3.4.2 Setting the Scoring Confirmation Switch

To select if confirmation is required before saving score, follow this procedure:

1. From the EWS page select **Setup**.
2. Set **Score Confirmation** switch.
 - ◆ **Off:** the monitor automatically saves the scoring result after the scoring is completed.
 - ◆ **On:** you need to confirm that whether the scoring result is saved or not after the scoring is completed.

27.3.4.3 Setting the Manual Data Timeout

The manually input parameter data can be configured to become invalid after a preset time. To set the timeout period for the input data, follow this procedure:

1. From the EWS screen select **Setup**.
2. From the **Manual Data Timeout** area, select a desired parameter and set its timeout period.

NOTE

- **If the data is expired and not updated, the monitor displays the corresponding parameter score in outline font, and gives a timeout alarm.**

27.3.4.4 Setting Auto Scoring

The monitor automatically starts scoring at the preset interval. To set auto scoring, follow this procedure:

1. From the EWS page select **Setup**.
2. Set **Auto Scoring**:
 - ◆ **Interval**: the monitor automatically starts scoring at the preset interval.
 - ◆ **NIBP**: the monitor automatically starts scoring at the completion of each NIBP measurement.
 - ◆ **Alarm**: the monitor automatically starts scoring when an alarm occurs to the parameter for scoring.
 - ◆ If no option is selected, the monitor does not initiate auto scoring.

27.3.4.5 Setting Auto Scoring Interval

1. From the EWS page select **Setup**.
2. Set **Interval**:
 - ◆ **By Score**: the monitor automatically starts scoring as per the interval selected for corresponding total score.
 - ◆ **5 min - 24 h**: If **Auto Scoring** is set to **Interval**, the monitor automatically starts scoring as per the selected interval. If **Auto Scoring** is not set to **Interval**, the countdown timer of manual scoring is selected.

27.3.5 Viewing Historical Scores

From the EWS screen, you can view the total score or subscores of the past 24 hours. To do so, choose either of the following ways:

- Select the history total score area.
- From the history total score area, swipe up with a finger.

To return to the EWS screen, select  from the top of the historical score screen. Refer to 27.3.2 *Accessing the EWS Screen* for the position of the history total score area.

27.3.6 Viewing Parameter Trends

From the EWS screen, you can view the 24-hour graphic trends of each parameter used for scoring. To do so, choose either of the following ways:

- Select the  button.
- Swipe right across the EWS screen with a finger.

From the screen of parameter trends, selecting the  button or swiping left across the screen with a finger can return to the EWS screen.

Refer to 27.3.2 *Accessing the EWS Screen* for the position of the  button.

27.4 Glasgow Coma Scale (GCS)

The Glasgow Coma Scale (GCS) function is based on Teasdale's *Assessment of Coma and Impaired Consciousness-A Practical Scale (Lancet, 1974)*. Three aspects of behavior are independently measured: eye opening, verbal response, and motor response. The scores are added together to indicate that patient's level of consciousness.

GCS is intended for adults and pediatric patients.

CAUTION

- **GCS is intended as an adjunct in patient assessment and must be used in conjunction with observation of clinical signs and symptoms.**
- **GCS is not applied to patients that are sedated, muscularly relaxed, with artificial airway, drunk, hypothermia or in status epilepsies.**
- **Please refer to hospital policy regarding acceptable use of GCS.**

- When applied to children younger than five years old or to the elderly, the GCS score may not reflect actual function.

27.4.1 Displaying the GCS Parameter Area

To display the GCS parameter area, follow this procedure:

1. Access **Tile Layout** in either of the following ways:
 - ◆ Select the **Screen Setup** quick key → select the **Tile Layout** tab.
 - ◆ Select the **Main Menu** quick key → from the **Display** column select **Tile Layout**.
2. Select the parameter area where you want to display the GCS score, and then from the popup list select **GCS**.

The following figure shows the GCS parameter area. The display may be configured to look slightly different.

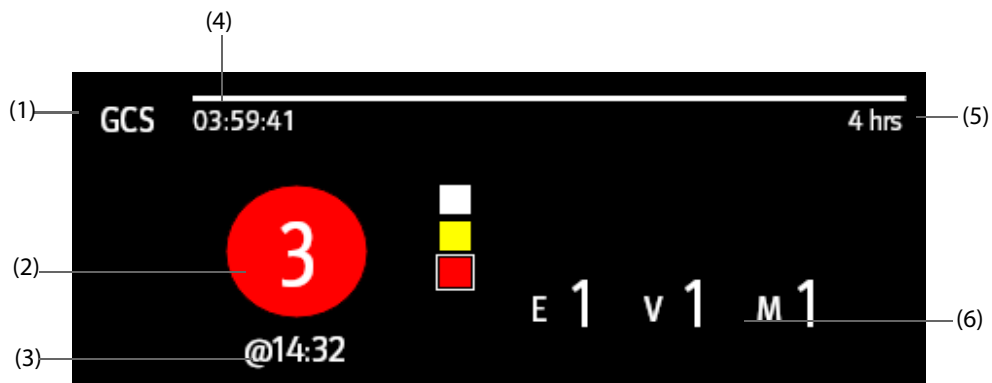

- (1) GCS label
- (2) Total score and level of consciousness. The color of the circle indicates the level of risk.
- (3) Scoring time
- (4) Scoring countdown: time to the next scoring
- (5) Scoring interval
- (6) Subscores
 - ◆ E: eye opening
 - ◆ V: verbal response
 - ◆ M: motor response

27.4.2 Accessing the GCS Dialog

Enter the GCS dialog in any of the following ways:

- Select the GCS parameter area.
- Select the **GCS** quick key.
- Select the **Main Menu** quick key → from the **CAA** column select **GCS**.

GCS		
* Eye Opening	* Verbal Response	* Motor Response
Eyes Opening Spontaneously (4)	Oriented and Converses (5)	Obey Verbal Commands (6)
Eyes Opening to Verbal Command (3)	Disoriented and Converses (4)	Localize to Pain (5)
Eyes Opening Only with Painful Stimuli (2)	Inappropriate Words (3)	Withdraw from Pain (4)
No Eye Opening (1)	Incomprehensible Sounds (2)	Flexor Response to Painful Stimuli (3)
	No Verbal Response (1)	Extensor Response to Painful Stimuli (2)
		No Motor Response (1)
Total Score 14		

(1) Subscore (2) Total score

27.4.3 Performing GCS Scoring

To perform scoring, follow this procedure:

1. From the **Eye Opening** area, **Verbal Response** area, and **Motor Response** area, respectively select an item that represents the patient's status.
2. Select **Ok** to accept the total score.

The following table lists the default score range and color of relevant consciousness level.

Level	Range	Color
Mild damage	13-15	White
Moderate damage	9 - 12	Yellow
Severe damage	3 - 8	Red

NOTE

- The GCS score range is adjustable. Refer to 33.4.4 *Setting GCS Threshold for Each Consciousness Level for the method of changing the high limit and low limit of each consciousness level.*

27.4.4 Setting GCS Scoring Interval

From the **GCS** dialog, select **Interval** to set GCS scoring interval. When the scoring interval is reached and you do not perform another scoring, the score will be invalidated and displayed as outline fonts.

27.4.5 Reviewing GCS Trend Data

From the **GCS** dialog, select **Review** to enter the **Review** dialog and view the GCS trend data from the **Tabular Trends**.

27.5 SepsisSight™

The SepsisSight™ function is based on Third International Consensus Definitions for Sepsis and Septic Shock (Sepsis-3) and Surviving Sepsis Campaign: International Guidelines for Management of Sepsis and Septic Shock: 2016 (SSC Guideline 2016). It assists you in recognizing the early signs and symptoms of sepsis by comparing the state of the patient to the defined criteria and then guides you through the recommended treatment protocol.

CAUTION

- SepsisSight is not a diagnostic or therapeutic tool and is not intended to replace the competent judgment of a clinician.
 - SepsisSight should not be used with intravenous immunoglobulins in adult patients with severe sepsis or septic shock.
 - SepsisSight should not be used with intravenous selenium for the treatment of severe sepsis.
 - SepsisSight should not be used with sodium bicarbonate therapy for the purpose of improving hemodynamics or reducing vasopressor requirements in patients with hypoperfusion-induced lactic acidemia with pH ≥ 7.15 .
-

NOTE

- SepsisSight is intended to perform routine screening of potentially infected seriously ill patients for severe sepsis to allow earlier implementation of therapy.
 - SepsisSight is intended to be followed by application of hospital-based performance improvement efforts in severe sepsis.
 - The Surviving Sepsis Campaign recommends to discuss goals of care and prognosis with patients and families.
 - The Surviving Sepsis Campaign recommends to incorporate goals of care into treatment and end-of-life care planning, utilizing palliative care principles where appropriate.
 - The SepsisSight goals of care are intended to be applied in a time defined by the SSC guidelines.
 - Due to space limitations on the screen, the recommendations cannot always be reproduced in the full detail available in the printed and on-line guidelines.
 - SepsisSight is intended for patients suffering from sepsis or suspicion of sepsis.
-

27.5.1 Accessing the SepsisSight Dialog

Enter the **SepsisSight** dialog in any of the following ways:

- Select the **SepsisSight** quick key.
- Select the **Main Menu** quick key → from the **CAA** column select **SepsisSight**.

27.5.2 Screening

As per Sepsis-3, SepsisSight supports quick Sepsis-Related Organ Failure Assessment (qSOFA, or quick SOFA) and Sepsis-Related Organ Failure Assessment (SOFA).

27.5.2.1 Performing qSOFA

qSOFA evaluates the patient's respiration rate, systolic blood pressure and altered mental status.

RR and BP-S being monitored are automatically obtained. You can also manually enter these values by selecting the  symbol. Select whether the patient's mental status is altered. Then qSOFA score is calculated.

If the qSOFA score is greater than or equal to 2, or sepsis is suspected, select **SOFA>>** to perform SOFA.

To clear the score, select **Reset**.

NOTE

- The keyboard symbol  indicates that the parameter value is manually entered.
 - The question mark (?) in the score circle indicates that more parameter values are required before a score can be calculated.
-

27.5.2.2 Performing SOFA

SOFA score is used to identify organ function or the rate of sepsis-related organ failure.

To perform SOFA, enter the value or select a range for each item, SOFA score will be automatically calculated.

To clear the score, select **Reset**.

If Sepsis criteria is met, make a comprehensive judgement on the clinical features.

27.5.2.3 Changing Screening Settings

From the **Screening** page select **Setup**. You can change the following settings:

- In the **Screening** area, set **RR (rpm)** high limit and **BP-S (mmHg)** low limit for qSOFA scoring.
- In the **Unit** area, set the unit of **Bilirubin** and **Creatinine**.

27.5.3 Recommendations

As per the SSC Guidelines 2016, SepsisSight provides graded recommendations. Pages **Part I** and **Part II** in the SepsisSight screen list these recommendations.

27.5.3.1 Viewing Detailed Recommendations

Select the ●●● icon at the right side of each item to view detailed recommendations of SSC Guideline 2016. The star symbol ★ indicates the grade of recommendation:

- ★ ★: strong recommendation
- ★: weak recommendation
- No ★ symbol: ungraded strong recommendation

27.5.3.2 Marking Implemented Items

Check off implemented items. Then the time and date are automatically recorded and displayed.

- You can select the  symbol to change the date and time.
- Select **Reset** to clear the current results.

27.5.4 Reviewing SepsisSight Trend Data

Select the **Graphic Trends** tab to view the trend of parameters of resuscitation.

When a recommended treatment is checked off on the **Part I** page and **Part II** page, relevant event is marked in the tabular trend. Vertical lines of different colors indicate the event type:

- White: inspection performed
- Blue: medication
- Green: goal achieved
- Purple: other treatment

27.6 Resus Mode

You can put the monitor into the Resus mode when rescuing a patient. The Resus mode has the following features:

- Displaying resuscitation-related parameter values and waveforms.
- Recording drugs and treatments through the CPR Record.

The Resus mode is intended for adult, pediatric, and neonatal patients.

WARNING

- **In the Resus mode, all physiological alarms and some of technical alarms are disabled.**
 - **Exit the Resus mode as soon as the resuscitation ends to resume normal patient monitoring.**
-
-

27.6.1 Entering the Resus Mode

To enter the Resus mode, choose either of the following ways:

- Select the **Resus Mode** quick key → select **OK**.
- Select the **Main Menu** quick key → from the **Alarm** column select **Resus Mode** → select **OK**.

27.6.2 CPR Record

The CPR Record helps you record the process of patient resuscitation. You can record the following items through the CPR Record:

- The time resuscitation starts and ends.
- Drug names and doses.
- Resuscitation treatments.

NOTE

- **A license is required for the CPR Record function.**

27.6.2.1 Accessing the CPR Record

The CPR Record automatically displays when you enter the Resus mode. If the CPR Record is closed, choose either of the following ways to open it:

- Select the **Main Menu** quick key → from the **CAA** column select **CPR Record**.
- Select the  button at the left of the screen and swipe right.

The following figure shows the CPR Record. Your display may be configured to look slightly different.

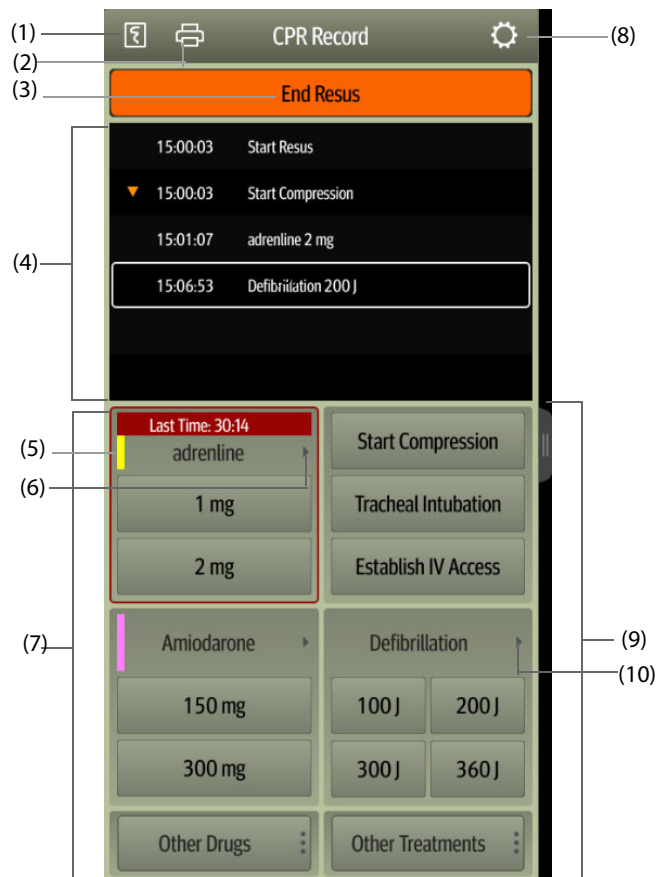

- (1) Press this key to output the resuscitation report through the recorder.
- (2) Press this key to output the resuscitation report through the printer.

- (3) Press this key to record the resuscitation start time/end time and result. The monitor automatically records the resuscitation start time when you enter the Resus mode.
- (4) Event area: lists drugs and treatments. Select any event to add an event, edit or delete this event. The resuscitation record saves automatically.
- (5) Drug color mark: is used to distinguish the type of drugs.
- (6) Press this key to select other doses. If adrenalin is used, you can define the injection interval. If the injection time is approaching, the time to the last injection will be highlighted in red, reminding that injection is required.
- (7) Drug record area: quickly records the names and doses of drugs used for patient resuscitation. Select **Other Drugs** to record other drugs or temporary drugs not included. You can edit these drugs later.
- (8) Press this key to enter the **Setup** menu. You can customize drugs and treatments.
- (9) Treatment record area: quickly records the treatments. Select **Other Treatments** to record other treatments. If an undefined treatment is selected, you can edit it later.
- (10) Press this key to select other defibrillation energy and the type of defibrillation waveform.

27.6.2.2 Customizing Drugs

You can customize drugs frequently used for resuscitation. To do so, follow this procedure:

1. From the **CPR Record** screen, select the  button to enter the **Setup** menu.
2. Define the name, unit, dose, and color of each drug as needed.

The CPR Record can list up to six frequently used drugs. The first two drugs directly shown on the **CPR Record** screen are the most frequently used. The other four drugs are displayed by selecting **Other Drugs**.

27.6.2.3 Customizing Treatment

Besides **Start Compression, Tracheal Intubation, Establish IV Access, Defibrillation, Mechanical Ventilation, Place Urinary Catheter**, you can customize defibrillation energy and two additional treatments. To do so, follow this procedure:

1. From the **CPR Record** screen, select the  button to enter the **Setup** menu.
2. Select the **Customized Treatment** tab to define the defibrillation energy and the names of two additional treatments.

27.6.2.4 Recording the Resuscitation Result

After the resuscitation is completed, select **End Resus** to record the resuscitation end time and result.

27.6.2.5 Outputting the Current Resuscitation Report

The resuscitation report automatically saves. You can output the resuscitation report through the recorder or printer. See *The following figure shows the CPR Record. Your display may be configured to look slightly different. for details.*

You can also export the resuscitation report using a USB drive. To do so, follow this procedure:

1. For N17/N15/N12/N12C, connect the USB drive in to the monitor's USB connector. For N22/N19, connect the USB drive to the monitor's MSB connector.
2. From the top of the **CPR Record** screen, select the  button to enter the **Print Setup** menu.
3. Select **Print Preview** → **Export to USB**.

27.6.2.6 Closing the CPR Record

The **CPR Record** automatically closes when you exit the Resus mode. You can select the  button at the right of the **CPR Record** screen and swipe left to close the **CPR Record**.

27.6.3 Exiting the Resus Mode

To exit the Resus mode, choose either of the following ways:

- Select the **Exit Resus Mode** quick key.
- Select the **Main Menu** quick key → from the **Alarm** column select **Exit Resus Mode**.

Exit the Resus mode as soon as resuscitation ends to return to normal patient monitoring.

27.6.4 Reviewing the Resuscitation Events

You can review the details of resuscitation events after exiting the Resus mode. To do so, follow this procedure:

1. Enter the **Events** page by choosing either of the following ways:
 - ◆ Select the **Review** quick key → select the **Event** tab.
 - ◆ Select the **Main Menu** quick key → from the **Review** column select the **Event** tab.
2. From the events list select the desired resuscitation event, and then select **Detail**.

27.6.4.1 Editing an Resuscitation Event

You can edit the history resuscitation event and result. To do so, follow this procedure.

1. Enter the **Events** page.
2. From the events list select the desired resuscitation event, and then select **Detail**.
3. Select any event to add an event, edit or delete this event.

27.6.4.2 Outputting History Resuscitation Record

You can print or export the history resuscitation record through event review. To do so, follow this procedure:

1. Enter the **Events** page.
2. From the events list select the desired resuscitation event, and then select **Detail**.
3. Select the  button to enter the **Print Setup** menu.
4. Print or export the resuscitation report:
 - ◆ Select **Print Preview** → **Print** to print this report.
 - ◆ Select **Print Preview** → **Export to USB** to export this report.

27.7 ECG 24h Summary

The ECG 24h Summary provides ECG statistics of the current patient over the latest 24 hours. You can view the following information through the ECG 24h Summary:

- Heart rate statistics
- Arrhythmia event statistics
- QT/QTc measurement statistics
- Maximum and minimum ST statistics of each lead
- Pacer statistics
- Typical ECG strips

NOTE

- **The ECG 24h Summary is intended for the current patient. It is not intended for discharged patients.**
- **Pacer statistics is intended for paced patients.**
- **Patient data is saved, collected and displayed together in the ECG 24h Summary. Data displayed in the ECG 24h Summary is not recalculated.**
- **If BeneView T1 is used to monitor a patient, when BeneView T1 is connected with the host monitor, data sent to the host monitor is not included in the ECG 24h Summary.**

- **A license is required for the ECG 24h Summary function.**
-

27.7.1 Viewing the ECG 24h Summary

To view the ECG 24h Summary, choose either of the following ways:

- Select the **ECG 24h Sum** quick key.
- Select the **Main Menu** quick key → from the **CAA** column select **ECG 24h Summary**.

27.7.2 Selecting Typical ECG Strips

The **Typical Strips** area displays ECG strips of the following situations:

- Maximum heart rate
- Minimum heart rate
- Four arrhythmia events

You can select a typical ECG strip of each situation. For example, to select the typical ECG strip of asystole, follow this procedure:

1. Select the currently displayed asystole strip.
2. From the popup strips, select the desired strip as the typical strip of asystole.

27.7.3 Reviewing ECG Summary

From the **ECG 24h Summary** dialog, you can review corresponding trends and events.

- Select the **Heart Rate** area to review HR graphic trends.
- Select the **Max ST/Min ST** area to review the current ST reference and ST graphic trends.
- Select the **Pace** area to review historic pace events.
- Select the **QT** area to review QT/QTc graphic trends.
- Select the **Arrhythmia** area to review arrhythmia statistics. For more information, refer to *26.2.9 Arrhy Statistics Review Page*.
- Select **Full Disclosure** to review ECG full disclosure waveforms. For more information, refer to *26.2.8 Full Disclosure Review Page*.

27.8 HemoSight™

This monitor provides the **HemoSight™** function. You can easily view and review hemodynamic parameters through the **HemoSight** dialog.

The **HemoSight** dialog is available when you are using the following modules:

- C.O. module
- ScvO₂ module
- CCO/SvO₂ module (measured from the Vigilance II, Vigileo, HemoSphere, and EV1000 monitor)

For detailed information on monitoring and setting hemodynamic-related parameters, see **16 Monitoring Cardiac Output (C.O.)**, **17 Monitoring Central Venous Oxygen Saturation (ScvO₂)**, and **18 Monitoring CCO/SvO₂**. This chapter only introduces functions operated through the **HemoSight** dialog.

27.8.1 Accessing the HemoSight Dialog

Access the **HemoSight** dialog by either of the following ways:

- Select the **HemoSight** quick key.
- Select the **CCO** numeric area, **ScvO2** numeric area, or **SvO2** numeric area → from the bottom of the dialog select **HemoSight**.
- Select the **Main Menu** quick key → from the **CAA** column select **HemoSight**.

27.8.2 Viewing Hemodynamic Parameters

To view hemodynamic parameters, select the desired tab on the **Diagnosis** page of the **HemoSight** dialog:

- ◆ Select **All** to view all hemodynamic parameters. For more information, see **32.2.1 Hemodynamic Parameters**.
- ◆ Select **Physiology Graphics** to view dynamic graphics for parameters' changes. For more information, see **27.8.3 Physiology Graphics**.
- ◆ Select **Physiology Relationship** to view the realtime relationship of parameters. For more information, see **27.8.4 Physiology Relationship**.

The symbols beside the hemodynamic parameters have the following meanings:

- *: indicates an intermittent parameter.
- **: indicates an oxygenation parameter.
- ***Measure Time**: refers to the measurement time of the intermittent parameter.
- ↑ or ↓: indicates that a parameter value exceeds its upper or lower limit. For setting the upper and lower limits of the hemodynamic parameters, see section **27.8.8 Setting Hemodynamic Parameter Ranges**.

27.8.2.1 Hemodynamic Parameters from ScvO₂ module

The following table lists the hemodynamic parameters from the ScvO₂ module.

	Abbreviation	Full Spelling	Unit
Oxygenation Parameters	ScvO ₂	Central Venous Oxygen Saturation	%
	Hb	Hemoglobin	g/L, g/dl, mmol/L
	Hct	Haematocrit	%
	DO ₂	Oxygen Delivery	ml/min
	DO ₂ I	Oxygen Delivery Index	ml/min/m ²
	VO ₂	Oxygen Consumption	ml/min
	VO ₂ I	Oxygen Consumption Index	ml/min/m ²
	SaO ₂	Arterial Oxygen Saturation	%

27.8.2.2 Hemodynamic Parameters from CCO/SvO₂ module

The following table lists the hemodynamic parameters from the Vigilance II, Vigileo, HemoSphere, and EV1000 monitors.

	Abbreviation	Full Spelling	Unit	Applicable Device
Output	CCO	Continuous Cardiac Output	L/min	All
	CCI	Continuous Cardiac Index	L/min/m ²	All
	C.O.	Cardiac Output	L/min	Vigilance II
	CI	Cardiac Index	L/min/m ²	Vigilance II
	SV	Stroke Volume	ml	All
	SVI	Stroke Volume Index	ml/m ²	All
	HR	Heart Rate	bpm	Vigilance II, HemoSphere
	PR	Pulse Rate	bpm	EV1000, HemoSphere
Contractility	ESV	End Systolic Volume	ml	Vigilance II
	ESVI	End Systolic Volume Index	ml/m ²	Vigilance II

	Abbreviation	Full Spelling	Unit	Applicable Device
	RVEF	Right Ventricular Ejection Fraction	%	Vigilance II, HemoSphere
	GEF	Global Ejection Fraction	%	EV1000
	CFI	Cardiac Function Index	l/min	EV1000
Preload Volume	CVP	Central Venous Pressure	cmH ₂ O, kPa, or mmHg	All
	EDV	End Diastolic Volume	ml	Vigilance II, HemoSphere
	EDVI	End Diastolic Volume Index	ml/m ²	Vigilance II, HemoSphere
	SVV	Stroke Volume Variation	%	Vigileo, EV1000, HemoSphere
	GEDV	Global End Diastolic Volume	ml	EV1000
	GEDI	Global End Diastolic Volume Index	ml/m ²	EV1000
	ITBV	Intrathoracic Blood Volume	ml	EV1000
	ITBI	Intrathoracic Blood Volume Index	ml/m ²	EV1000
	PPV	Pulse Pressure Variation	%	HemoSphere
Afterload	MAP	Mean Arterial Pressure	mmHg or kPa	Vigilance II
	SVR	Systemic Vascular Resistance	DS/cm ⁵ or kPa-s/l	All
	SVRI	Systemic Vascular Resistance Index	DS-m ² /cm ⁵ or kPa-s-m ² /l	All
	eArt-S	Systolic Arterial Pressure from the EV1000 monitor	mmHg or kPa	EV1000, HemoSphere
	eArt-M	Mean Arterial Pressure from the EV1000 monitor	mmHg or kPa	EV1000, HemoSphere
	eArt-D	Diastolic Arterial Pressure from the EV1000 monitor	mmHg or kPa	EV1000, HemoSphere
Oxygenation Parameters	SaO ₂	Arterial Oxygen Saturation	%	Vigilance II
	ScvO ₂	Central Venous Oxygen Saturation	%	All
	SvO ₂	Mixed Venous Oxygen Saturation	%	All
	DO ₂	Oxygen Delivery	ml/min	Vigilance II, EV1000, HemoSphere
	DO ₂ I	Oxygen Delivery Index	ml/min/m ²	EV1000, HemoSphere
	VO ₂	Oxygen Consumption	ml/min	Vigilance II, EV1000, HemoSphere
	VO ₂ I	Oxygen Consumption Index	ml/min/m ²	EV1000, HemoSphere
	VO ₂ E	Estimated Oxygen Consumption	ml/min	EV1000, EV1000, HemoSphere

	Abbreviation	Full Spelling	Unit	Applicable Device
	VO ₂ IE	Estimated Oxygen Consumption Index	ml/min/m ²	EV1000, HemoSphere
	O ₂ EI	Oxygen Extraction Index	%	Vigilance II
	Hb	Hemoglobin	g/L, g/dl, or mmol/L	EV1000, HemoSphere
	SpO ₂	Arterial Oxygen Saturation from Pulse Oximetry	%	EV1000, HemoSphere
Organ Function	EVLW	Extravascular Lung Water	ml	EV1000
	ELWI	Extravascular Lung Water Index	ml/kg	EV1000
	PVPI	Pulmonary Vascular Permeability Index	no unit	EV1000
	TB	Blood Temperature	°C or °F	EV1000, HemoSphere

27.8.3 Physiology Graphics

The lungs, heart and circulatory system vary according to the patient's condition at the time of the thermodilution measurement. The **Physiology Graphics** displays monitored parameters using animation, which gives a visual representation of the interaction between the heart, lungs, blood, and vascular system. The continuous parameter values are displayed in realtime. When the intermittent data is available, the animation changes to reflect this change. The heart rate showed by the animation is also a visual reflection of the patient's heart rate.

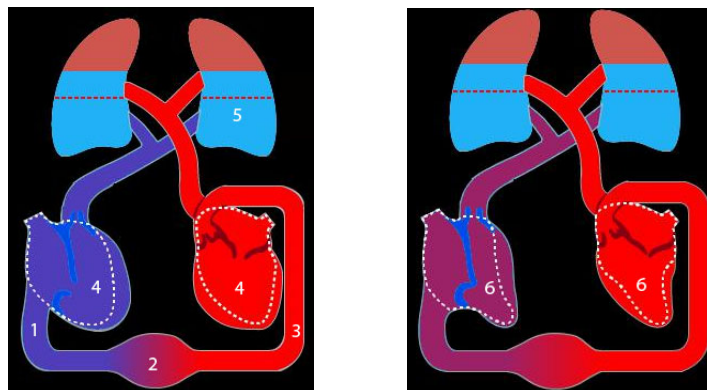

- (1) When ScvO₂ or SvO₂ is available, the color varies according to the value, so a change in color indicates a change of ScvO₂ or SvO₂ value.

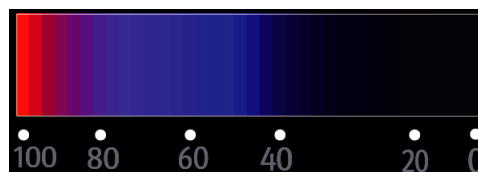

- (2) When CVP and SVRI are available, the change in blood vessel diameter indicates the change of SVRI values. For more information, see **27.8.3.1 Systemic Vascular Resistance Status**.
- (3) When SpO₂ is available, the color varies according to the SpO₂ value, so a change in color indicates a change of SpO₂ value.

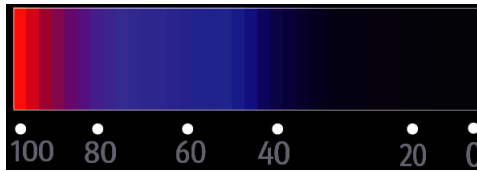

- (4) When EDVI or GEDI is available, the size change in the diastole indicates the change of end diastolic volume index. For more information, see **27.8.3.3 End Diastolic Volume Status**.
- (5) When ELWI is available, the change in liquid level of lung indicates the change of ELWI values. For more information, see **27.8.3.2 Lung Water Status**.
- (6) When RVEF or GEF is available, the size change in the systole indicates the change of ejection fraction. For more information, see **27.8.3.4 Ejection Fraction Status**.

27.8.3.1 Systemic Vascular Resistance Status

Systemic vascular resistance status is indicated by SVRI. The following pictures show the systemic vascular resistance status.

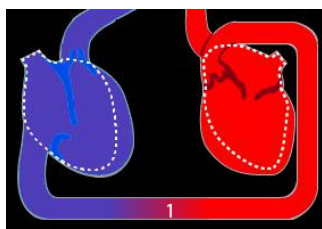

Normal resistance

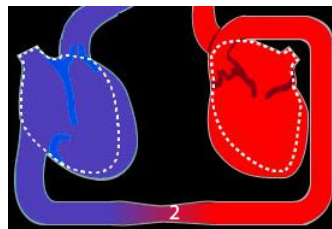

High resistance

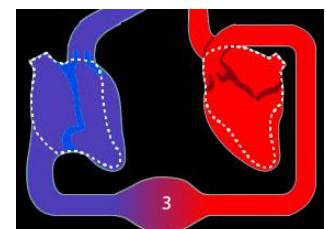

Low resistance

27.8.3.2 Lung Water Status

Lung water status is indicated by ELWI. The following picture shows the lung water status, which is indicated by the liquid level of lung. The dotted line marks the high limit of ELWI. The ELWI is considered too high if the liquid level exceeds the dotted line. When ELWI is not available, the lung is displayed in gray color.

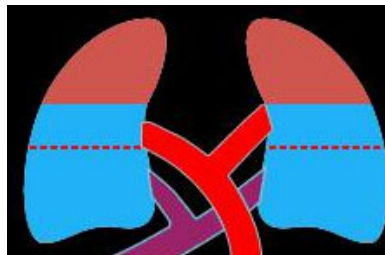

27.8.3.3 End Diastolic Volume Status

End diastolic volume status is indicated by EDVI (from the CCO/SvO₂ module). The following pictures show different end diastolic volume statuses. The dotted line marks the normal end diastolic volume status. When EDVI or GEDI is not available, the heart in the diastole is displayed in gray color.

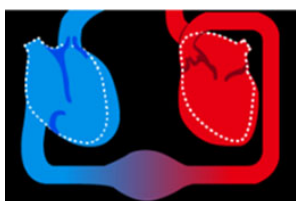

High end diastolic volume

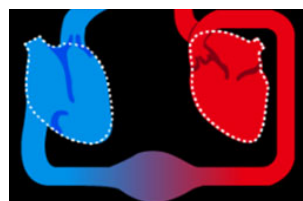

Normal end diastolic volume

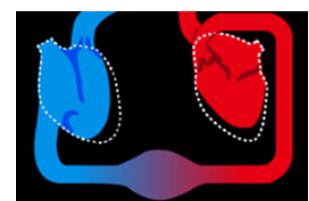

Low end diastolic volume

27.8.3.4 Ejection Fraction Status

Ejection fraction status is indicated by RVEF (from the CCO/SvO₂ module). The following pictures show different ejection fraction statuses. The dotted line marks the normal ejection fraction status. When RVEF or GEF is not available, the heart in the systole is displayed in gray color.

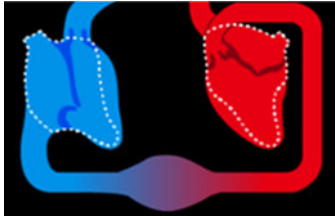

Low ejection fraction

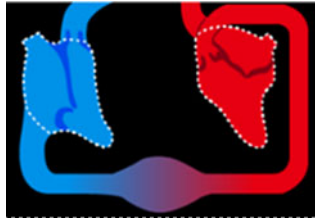

Normal ejection fraction

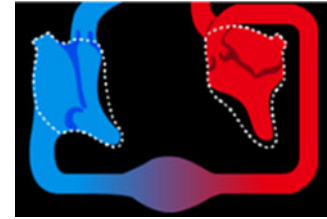

High ejection fraction

27.8.4 Physiology Relationship

The **Physiology Relationship** screen depicts the balance between oxygen delivery (DO₂) and estimated oxygen consumption (VO₂). It automatically updates as parameter values change so the displayed values are always current. The connecting lines highlight the relationship of the parameters to each other.

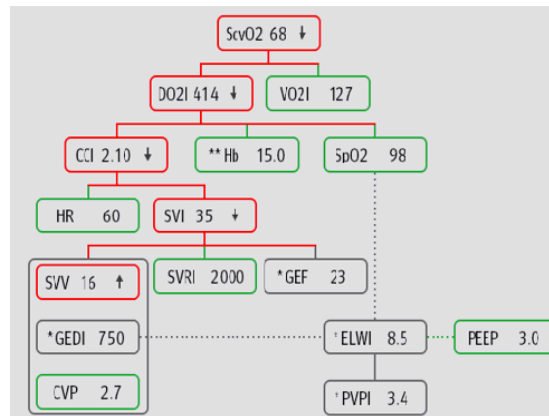

In the **Physiology Relationship** screen, the connecting lines have the following meanings:

- Solid line: indicates that connected parameters have a direct relationship.
- Dotted line: indicates that connected parameters have an indirect relationship.
- Red frame: the parameter value is out of its normal range.
- Green frame: the parameter value is within its normal range.
- Gray frame: the parameter value is not available.

In the **Physiology Relationship** screen, each parameter frame displays the following contents:

- Parameter name
- Parameter value ("—" if parameter value is not available)
- * (if the parameter is intermittent)
- ** (if the parameter value is input manually)
- ↑ or ↓ (if the parameter value exceeds its upper or lower limit, as defined in the **Setup** dialog. See section 27.8.8 *Setting Hemodynamic Parameter Ranges*)

NOTE

- **When measuring the hemodynamic parameters with different modules or devices, parameters displayed in the Physiology Relationship screen are different.**

27.8.5 Hemodynamic Test

The **Test** page in the **HemoSight** window provides the trends before and after a hemodynamic test. To access the **Test** page, follow this procedure:

1. Select the numeric area of **CCO**, **ScvO2**, or **SvO2**.
2. Select **HemoSight**.
3. Select the **Test** tab.

27.8.5.1 Renaming a Test

The passive leg raising (PLR) test and rapid fluid loading (RFL) test are default tests, and their names cannot be changed. To rename a custom defined test, follow this procedure:

1. Access the **HemoSight** dialog. For more information, refer to *27.8.1 Accessing the HemoSight Dialog*.
2. Select the **Test** tab.
3. Select **Custom 1**, **Custom 2**, **Custom 3** or **Custom 4**.
4. Select the  symbol at the upper left corner of the current dialog.
5. Input the test name in the input field.

27.8.5.2 Setting Test Time Duration

To set test time duration, follow this procedure:

1. Access the **HemoSight** dialog. For more information, refer to *27.8.1 Accessing the HemoSight Dialog*.
2. Select the **Test** tab.
3. Set **Test Duration**.

27.8.5.3 Selecting Parameters for Testing

To set test parameters, follow this procedure:

1. Access the **HemoSight** dialog. For more information, refer to *27.8.1 Accessing the HemoSight Dialog*.
2. Select the **Test** tab.
3. Select **Setup**.
4. From desired parameter page, select parameters for testing.

27.8.5.4 Performing a Hemodynamic Test

To measure and record a hemodynamic test, follow this procedure, along with hospital guidelines for the test to be administered:

1. Access the **HemoSight** dialog. For more information, refer to *27.8.1 Accessing the HemoSight Dialog*.
2. Select the **Test** tab.
3. Select **Setup** to select the involved parameters.
4. Select **Test Duration** to set test duration.
5. Prepare the patient and select the **Start** button to begin recording the measurements.
6. Wait until the test finishes automatically, or select the **Stop** button to end the test.
7. View the parameter trends. After the test, the **Test** page displays the current parameter value, reference parameter value, and Delta value (the variation of current value and reference value). For more information, see *26 Review*.

NOTE

- **Hemodynamic tests can also run in background. If the Test page is closed during a test or the HemoSight dialog is closed, then the monitor gives a prompt tone and pops up the Test page after the test ends.**

27.8.6 Following Up the Patient Hemodynamic Status

You can view the cardiac function curve, lung water curve and SVV/PPV slope indicator in the **Follow-up** page. To view these curves or indicator, follow this procedure:

1. Access the **HemoSight** dialog. For more information, refer to *27.8.1 Accessing the HemoSight Dialog*.
2. Select the **Follow-up** tab.
3. View the following curves or indicator:
 - ◆ Cardiac function curve
 - ◆ SVV/PPV slope indicator
 - ◆ Lung water curve

27.8.6.1 Cardiac Function Curve and Lung Water Curve

Cardiac function curve and the lung water curve are used to assess the fluid responsiveness.

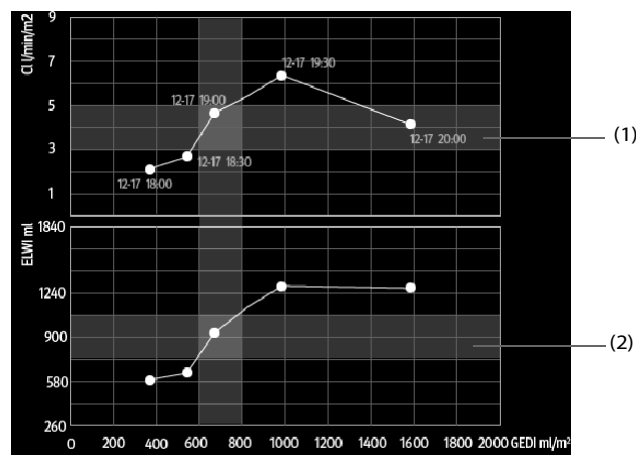

(1) Cardiac function curve (2) Lung water curve

For more information on the setup of X-axis or Y-axis parameter, see *27.8.6.2 Setting the Cardiac Function Curve and Lung Water Curve*.

27.8.6.2 Setting the Cardiac Function Curve and Lung Water Curve

To set the cardiac function curve and lung water curve, follow this procedure:

1. Access the **HemoSight** dialog. For more information, refer to *27.8.1 Accessing the HemoSight Dialog*.
2. Select the **Follow-up** tab.
3. Make the following settings:
 - ◆ **Interval:** set the time interval between coordinate points on the X-axis and Y-axis of the cardiac function curve and lung water curve. This setting is effective only when continuous parameters are selected at both the X-axis and Y-axis. When ELWI is unavailable and all the other parameters selected are continuous parameters, coordinate points will not be drawn on the lung water curve, but will be drawn on the cardiac function curve at the configured interval.
 - ◆ **Output:** set the Y-axis parameter for cardiac function curve.
 - ◆ **Preload Volume:** set the X-axis parameter for both cardiac function curve and lung water curve.

NOTE

- **If intermittent parameters are selected at either the X-axis or Y-axis, coordinate points will be drawn for all the intermittent parameters. In this case, coordinates drawn for continuous parameters and intermittent parameters are consistent.**

27.8.6.3 SVV/PPV Slope Indicator

The SVV/PPV slope indicator is a visual representation of the cardiac function curve used when assessing the stroke volume variation value or pulse pressure variation. The curved line indicates the SVV/PPV slope.

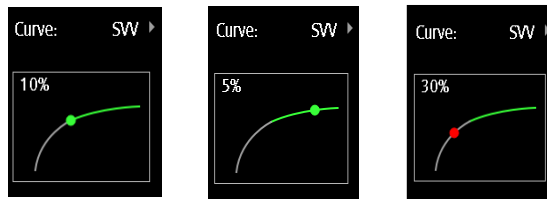

The dot moves up and down the curved line according to the SVV or PPV value. The color of the dot changes based upon set target ranges.

- SVV/PPV ≤ 10%: the dot is green, and may predict that the patient is fluid unresponsive.
- SVV/PPV > 10%: the dot is red, and may predict that the patient is fluid responsive.

CAUTION

- **PPV and SVV are only applicable in patients on controlled mechanical ventilation and sinus rhythm.**
-

27.8.6.4 Setting the SVV/PPV Slope Indicator

To set the SVV or PPV slope, follow this procedure:

1. Access the **HemoSight** dialog. For more information, refer to 27.8.1 *Accessing the HemoSight Dialog*.
2. Select the **Follow-up** tab.
3. Select **SVV** or **PPV** to set which **Curve** is the indicator. You can also set it to **Off** to hide the indicator.

27.8.7 Evaluating the Hemodynamic Parameters

You can review the hemodynamic parameter trends on the **Evaluation** page. The changes of hemodynamic parameters are shown by the trends or Spidervision diagram. The trends and Spidervision diagram display both current values and reference values of parameters, which let you conveniently see the hemodynamic status at different timepoints.

To enter the **Evaluation** page, follow this procedure:

1. Access the **HemoSight** dialog. For more information, refer to 27.8.1 *Accessing the HemoSight Dialog*.
2. Select the **Evaluation** tab.

27.8.7.1 Viewing the Spidervision Diagram

The Spidervision diagram shows hemodynamic parameters in dynamic conjunction. To enter the **Spidervision** diagram, follow this procedure:

1. Access the **HemoSight** dialog. For more information, refer to 27.8.1 *Accessing the HemoSight Dialog*.
2. Select the **Evaluation** tab.

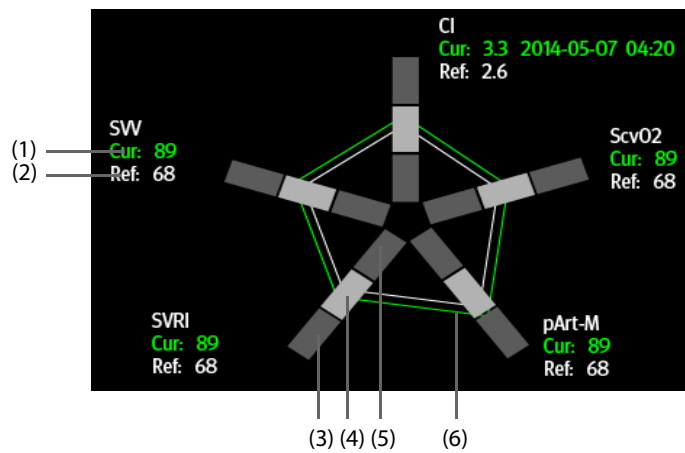

- | | | |
|--------------------|---------------------|------------------------------------|
| (1) Current value | (2) Reference value | (3) Outer segment |
| (4) Middle segment | (5) Inner segment | (6) Link between legs of the graph |

Each leg of the graph is divided into 3 segments indicating different value ranges for the respective parameters. The middle segment indicates the normal range for the respective parameter. The outer segment will be highlighted when corresponding parameter value exceeds the upper limit. The inner segment will be highlighted when its corresponding parameter value exceeds the lower limit.

- The links between legs of the graph are displayed in green when all displayed parameters are within the normal range.
- The links between legs of the graph and the corresponding spider segment are displayed in yellow when one of the displayed parameters is outside the normal range.
- The links between legs of the graph and the corresponding spider segments are displayed in red when two or more displayed parameters are outside the normal range.

27.8.7.2 Viewing Trends

To view the trends of hemodynamic parameters, follow this procedure:

1. Access the **HemoSight** dialog. For more information, refer to 27.8.1 *Accessing the HemoSight Dialog*.
2. Select the **Evaluation** tab.
3. Select the **Trends** tab.





For more information on trends review, see 26.2.2 *Example Review Dialog*.







27.8.7.3 Viewing Hemodynamic Parameters

You can view the hemodynamic parameters on the **Evaluation** page. The timeline below the **Spidervision** diagram indicates the entire time length. The timeline below the **Trends** page indicates the time length of current window (for more information, see 27.8.7.4 *Changing the Time Length of Trends*). Different color markers on the timeline indicate different types of events:

- Red: high priority physiological alarm event
- Yellow: medium priority physiological alarm event
- Cyan: low priority physiological alarm event
- Green: manual event
- White: operation-related event, such as accepting the C.O. average

To locate a hemodynamic event, choose any of the following methods:

- Move the slider  to the target position.
- Use the following buttons:
 - ◆ Select  or  beside  to go to the previous or next hemodynamic event.

- ◆ Select  to view the event list and select the desired hemodynamic event.
- ◆ Select  or  beside  to go to the previous or next C.O. average acceptance event.
- ◆ Select  to enter the list of C.O. average acceptance events, and select the desired C.O. average acceptance event.
- ◆ Select  or  to move the white vertical line to the left or right. Alternately, the cursor will move to any location you touch on the graph.

NOTE

- **If a physiological alarm event or manual event occurs simultaneously with a C.O. average acceptance event, this event will be displayed in preference to a C.O. average acceptance event.**

27.8.7.4 Changing the Time Length of Trends

To change the time length of trends, follow this procedure:

1. Access the **HemoSight** dialog. For more information, refer to *27.8.1 Accessing the HemoSight Dialog*.
2. Select the **Evaluation** tab.
3. Select **Trends** Tab.
4. Select **Zoom** and set the time length of trends.

27.8.7.5 Selecting the Spidervision Pattern

The pattern defines the hemodynamic parameters and their numbers displayed in the **Spidervision** diagram and **Trends** page. To select the pattern, follow this procedure:

1. Access the **HemoSight** dialog. For more information, refer to *27.8.1 Accessing the HemoSight Dialog*.
2. Select the **Evaluation** tab.
3. Select the **Spidervision** tab or **Trends** tab.
4. Click the **Pattern** button and select a Spidervision pattern.

For more information, see *27.8.10 Setting the Pattern* for detailed information of creating or updating a pattern.

27.8.7.6 Saving Reference Values

To save the hemodynamic parameter values of any moment as reference values, follow this procedure:

1. Access the **HemoSight** dialog. For more information, refer to *27.8.1 Accessing the HemoSight Dialog*.
2. Select the **Evaluation** tab.
3. Select the **Spidervision** tab or **Trends** tab.
4. Move the timeline below the trends or Spidervision graph to select a desired time, or refer to *27.8.7.3 Viewing Hemodynamic Parameters* to select an event.
5. Select **Set Reference** to save the parameter values at the selection time as reference values.

27.8.8 Setting Hemodynamic Parameter Ranges

To set the ranges of hemodynamic parameters, follow this procedure:

1. Access the **HemoSight** dialog. For more information, refer to *27.8.1 Accessing the HemoSight Dialog*.
2. Select the **Setup** button.
3. Select the **Range** tab.
4. Set the normal ranges of the hemodynamic parameters.

27.8.9 Restoring Default HemoSight Range Values

To restore the default values, follow this procedure:

1. Access the **HemoSight** dialog. For more information, refer to *27.8.1 Accessing the HemoSight Dialog*.
2. Select the **Setup** button.

3. Select the **Defaults** button.

NOTE

- **Selecting Defaults restores all the parameter ranges to default values.**
-

27.8.10 Setting the Pattern

To set the pattern, follow this procedure:

1. Access the **HemoSight** dialog. For more information, refer to *27.8.1 Accessing the HemoSight Dialog*.
2. Select the **Setup** button.
3. Select the **Spidervision** tab.
4. Make the following settings:
 - ◆ Select the number of parameters (three to seven).
 - ◆ Select the parameters to be displayed in Spidervision. The same parameters will show in the Trends as they are listed in Spidervision clockwise, starting at the top.
 - ◆ Select **Save**, **Save As** or **Delete** to save, create or delete a pattern.

NOTE

- **You cannot delete the default pattern or the pattern that is in use.**
-

28 Calculation

28.1 Calculation Overview

The monitor provides calculation functions. The calculated values, which are not directly measured, are computed based on the values you provide. The calculation function is independent of other monitoring functions and can therefore be used for patients being monitored by other monitors. Any operation in a calculation dialog does not affect the patient monitored by the current monitor.

You can perform the following calculations:

- Drug calculations
- Hemodynamic calculations
- Oxygenation calculations
- Ventilation calculations
- Renal calculations

28.2 Calculation Safety Information

WARNING

- **Decisions on the choice and dosage of drugs administered to patients must always be made by the physician in charge. The drug calculations are based on the values input; it does not check the plausibility of the calculation performed.**
 - **Check that the entered values are correct and the calculated values are appropriate. Mindray assumes no responsibility for any consequences caused by wrong entries and improper operations.**
-

28.3 Drug Calculations

28.3.1 Performing Drug Calculations

To perform drug calculations, follow this procedure:

1. Access the drug calculator by either of the following ways:
 - ◆ Select the **Calculations** quick key → select the **Drug** tab.
 - ◆ Select the **Main Menu** quick key → from the **Calculations** column select **Drug**.
2. Set **Drug Name** and **Patient Category**. If the dose of drug is weight dependent, you must input the patient's weight. The dose calculation program has a library of commonly used drugs, while Drug A through Drug E are user defined.
3. Enter the known values, for example **Drug Amount** and **Solution Volume**.
4. Select **Calculate**. The calculated values are indicated by red arrows.

NOTE

- **If available, the patient category and weight from the Patient Demographics dialog are automatically entered when you first access drug calculation. You can change the patient category and weight. This will not change the patient category and weight stored in the patient demographic information.**
-

28.3.2 Checking the Titration Table

The titration table shows information on the currently used drugs. Use the titration table to see what dose of a drug your patient will receive at different infusion rates. To access the titration table, follow this procedure:

1. Access drug calculator by either of the following ways:
 - ◆ Select the **Calculations** quick key.
 - ◆ Select the **Main Menu** quick key → from the **Calculations** column select **Drug**.
2. Select the **Titration Table** tab.
3. Select **Dose Type** to set the type of dose unit in the titration table.
4. Select **Interval** to set the interval between two adjacent titration table items.

You can select how to display the titration table:

- **Dose:** the titration table is listed in the sequence of increased drug dose.
- **Infusion Rate:** the titration table is listed in the sequence of increased infusion rate. By default the resolution of the infusion rate is one (1). By selecting **Exact Rate** the resolution of the infusion rate can reach 0.01 so that you can display the infusion rate more accurately.

28.3.3 Drug Calculation Formula

Description	Unit	Formula
Dose	Dose/hr Dose/min	$\text{Dose} = \text{Infusion Rate} \times \text{Concentration}$
Dose (weight based)	Dose/kg/hr Dose/kg/min	$\text{Dose (weight based)} = \text{Infusion Rate} \times \text{Concentration/Weight}$
Drug Amount	g series: mcg, mg, g unit series: Unit, KU, MU mEq series: mEq	$\text{Drug Amount} = \text{Dose} \times \text{Duration}$
Drug Amount (weight based)	g series: mcg, mg, g unit series: Unit, KU, MU mEq series: mEq	$\text{Drug Amount (weight based)} = \text{Dose} \times \text{Duration} \times \text{Weight}$
Duration	hr	$\text{Duration} = \text{Amount/Dose}$
Duration (weight based)	hr	$\text{Duration (weight based)} = \text{Amount}/(\text{Dose} \times \text{Weight})$
Concentration	mcg/ml, mg/ml, g/ml, Unit/ml, KU/ml, MU/ml, mEq/ml	$\text{Concentration} = \text{Drug Amount}/\text{Solution Volume}$
Solution volume	ml	$\text{Volume} = \text{Infusion Rate} \times \text{Duration}$
Infusion rate	ml/hr	$\text{Infusion Rate} = \text{Dose}/\text{Concentration}$
Infusion rate (weight based)	g·ml/hr	$\text{Infusion Rate} = \text{Dose} \times \text{Weight}/\text{Concentration}$

28.3.4 Titration Table Calculation Formula

Description	Unit	Formula
Infusion Rate	ml/hr	$\text{Infusion Rate} = \text{Dose}/\text{Concentration}$
Infusion Rate (weight based)	ml/hr	$\text{Infusion Rate} = \text{Weight} \times \text{Dose}/\text{Concentration}$
Dose	Dose/hr Dose/min	$\text{Dose} = \text{Infusion Rate} \times \text{Concentration}$
Dose (weight based)	Dose/kg/hr Dose/kg/min	$\text{Dose (weight based)} = \text{Infusion Rate} \times \text{Concentration/Weight}$

28.4 Hemodynamic Calculations

The monitor provides the hemodynamic calculation function and can save the results of up to 10 calculations, which are displayed in groups.

28.4.1 Performing Hemodynamic Calculations

To perform hemodynamic calculation, follow this procedure:

1. Access hemodynamic calculation by either of the following ways:
 - ◆ Select the **Calculations** quick key → **Hemodynamics** tab.
 - ◆ Select the **Main Menu** quick key → from the **Calculations** column select **Hemodynamics**.
2. Enter the known values. For a patient who is being monitored, the currently measured values are automatically entered.
3. Select **Calculate**.

A calculated value greater than the normal upper limit is indicated by an up arrow “↑”. A calculated value lower than the normal lower limit is indicated by a down arrow “↓”.

You can select **Range** to show the normal range of each parameter.

28.4.2 Input Parameters for Hemodynamic Calculations

Input Parameter	Label	Unit
cardiac output	C.O.	L/min
heart rate	HR	bpm
pulmonary artery wedge pressure	PAWP	mmHg
mean arterial pressure	MAP	mmHg
pulmonary artery mean pressure	PA-M	mmHg
central venous pressure	CVP	mmHg
end-diastolic volume	EDV	ml
height	Height	cm
weight	Weight	kg

NOTE

- If you enable Use PA-D as PAWP, PA-D value will be used to replace PAWP value for hemodynamic calculation. For more information, refer to 15.6.8 Setting the Use PA-D as PAWP Switch.

28.4.3 Calculated Parameters and Formulas for Hemodynamic Calculations

Calculated Parameters	Label	Unit	Formula
cardiac index	C.I.	L/min/m ²	C.I. (L/min/m ²) = C.O. (L/min)/BSA (m ²)
body surface area	BSA	m ²	BSA (m ²) = Wt ^{0.425} (kg) × Ht ^{0.725} (cm) × 0.007184
stroke volume	SV	ml	SV (ml) = 1000 × C.O. (L/min)/HR (bpm)
stroke index	SVI	ml/m ²	SVI (ml/m ²) = SV (ml)/BSA (m ²)
systemic vascular resistance	SVR	DS/cm ⁵	SVR (DS/cm ⁵) = 79.96 × [APMAP (mmHg) - CVP (mmHg)]/C.O. (L/min)

Calculated Parameters	Label	Unit	Formula
systemic vascular resistance index	SVRI	$DS \cdot m^2 / cm^5$	$SVRI (DS \cdot m^2 / cm^5) = SVR (DS / cm^5) \times BSA (m^2)$
pulmonary vascular resistance	PVR	DS / cm^5	$PVR (DS / cm^5) = 79.96 \times [PAMAP (mmHg) - PAWP (mmHg)] / C.O. (L/min)$
pulmonary vascular resistance index	PVRI	$DS \cdot m^2 / cm^5$	$PVRI (DS \cdot m^2 / cm^5) = PVR (DS / cm^5) \times BSA (m^2)$
left cardiac work	LCW	$kg \cdot m$	$LCW (kg \cdot m) = 0.0136 \times APMAP (mmHg) \times C.O. (L/min)$
left cardiac work index	LCWI	$kg \cdot m / m^2$	$LCWI (kg \cdot m / m^2) = LCW (kg \cdot m) / BSA (m^2)$
left ventricular stroke work	LVSW	$g \cdot m$	$LVSW (g \cdot m) = 0.0136 \times APMAP (mmHg) \times SV (ml)$
left ventricular stroke work index	LVSWI	$g \cdot m / m^2$	$LVSWI (g \cdot m / m^2) = LVSW (g \cdot m) / BSA (m^2)$
right cardiac work	RCW	$kg \cdot m$	$RCW (kg \cdot m) = 0.0136 \times PAMAP (mmHg) \times C.O. (L/min)$
right cardiac work index	RCWI	$kg \cdot m / m^2$	$RCWI (kg \cdot m / m^2) = RCW (kg \cdot m) / BSA (m^2)$
right ventricular stroke work	RVSW	$g \cdot m$	$RVSW (g \cdot m) = 0.0136 \times PAMAP (mmHg) \times SV (ml)$
right ventricular stroke work index	RVSWI	$g \cdot m / m^2$	$RVSWI (g \cdot m / m^2) = RVSW (g \cdot m) / BSA (m^2)$
ejection fraction	EF	%	$EF (\%) = 100 \times SV (ml) / EDV (ml)$
end-diastolic volume index	EDVI	ml / m^2	$EDVI (ml / m^2) = EDV (ml) / BSA (m^2)$
end-systolic volume	ESV	ml	$ESV (ml) = EDV (ml) - SV (ml)$
end-systolic volume index	ESVI	ml / m^2	$ESVI (ml / m^2) = ESV (ml) / BSA (m^2)$

28.5 Oxygenation Calculations

The monitor provides the oxygenation calculation function and can save the results of up to 10 calculations, which are displayed in groups.

28.5.1 Performing Oxygenation Calculations

To perform oxygenation calculations, follow this procedure:

1. Access oxygenation calculation by either of the following ways:
 - ◆ Select the **Calculations** quick key → **Oxygenation** tab.
 - ◆ Select the **Main Menu** quick key → from the **Calculations** column select **Oxygenation**.
2. Enter the known values. For a patient who is being monitored, the currently measured values are automatically entered.
3. Select **Calculate**.

A calculated value greater than the normal upper limit is indicated by an up arrow "↑". A calculated value lower than the normal lower limit is indicated by a down arrow "↓".

In the **Oxygenation** page, you can also perform the following operations:

- Select **OxyCont Unit**, **Hb Unit**, and **Pressure Unit**. Then corresponding parameter values will be automatically converted and updated accordingly.
- Select **Range** to show the normal range of each parameter.

28.5.2 Input Parameters for Oxygenation Calculations

Input Parameter	Label	Unit
cardiac output	C.O.	L/min
percentage fraction of inspired oxygen	FiO ₂	%
partial pressure of oxygen in the arteries	PaO ₂	mmHg, kPa
partial pressure of carbon dioxide in the arteries	PaCO ₂	mmHg, kPa
arterial oxygen saturation	SaO ₂	%
partial pressure of oxygen in venous blood	PvO ₂	mmHg, kPa
venous oxygen saturation	SvO ₂	%
hemoglobin	Hb	g/L, g/dl, mmol/L
respiratory quotient	RQ	None
atmospheric pressure	ATMP	mmHg, kPa
height	Height	cm, inch
weight	Weight	kg, lb

28.5.3 Calculated Parameters and Formulas for Oxygenation Calculations

Calculated Parameters	Label	Unit	Formula
body surface area	BSA	m ²	$BSA (m^2) = Wt^{0.425} (kg) \times Ht^{0.725} (cm) \times 0.007184$
oxygen consumption	VO ₂	ml/min	$VO_2 (ml/min) = C(a-v)O_2 (ml/L) \times C.O. (L/min)$
arterial oxygen content	CaO ₂	ml/L, ml/dL	$CaO_2 (ml/L) = 10 \times (0.0134 \times Hb (g/dl) \times SaO_2 (\%)) + 0.031 \times PaO_2 (mmHg)$
venous oxygen content	CvO ₂	ml/L, ml/dL	$CvO_2 (ml/L) = 10 \times (0.0134 \times Hb (g/dl) \times SvO_2 (\%)) + 0.031 \times PvO_2 (mmHg)$
arteriovenous oxygen content difference	C(a-v)O ₂	ml/L, ml/dl	$C(a-v)O_2 (ml/L) = CaO_2 (ml/L) - CvO_2 (ml/L)$
oxygen extraction ratio	O ₂ ER	%	$O_2ER (\%) = 100 \times C(a-v)O_2 (ml/L) / CaO_2 (ml/L)$
oxygen transport	DO ₂	ml/min	$DO_2 (ml/min) = C.O. (L/min) \times CaO_2 (ml/L)$
partial pressure of oxygen in the alveoli	PAO ₂	mmHg, kPa	$PAO_2 (mmHg) = [ATMP (mmHg) - 47 mmHg] \times FiO_2 (\%)/100 - PaCO_2 (mmHg) \times [FiO_2 (\%)/100 + (1 - FiO_2 (\%)/100)/RQ]$
alveolar-arterial oxygen difference	AaDO ₂	mmHg, kPa	$AaDO_2 (mmHg) = PAO_2 (mmHg) - PaO_2 (mmHg)$
capillary oxygen content	CcO ₂	ml/L, ml/dl	$CcO_2 (ml/L) = Hb (g/L) \times 1.34 + 0.031 \times PAO_2 (mmHg)$
venous admixture	QS/QT	%	$QS/QT (\%) = 100 \times [1.34 \times Hb (g/L) \times (1 - SaO_2 (\%)/100) + 0.031 \times (PAO_2 (mmHg) - PaO_2 (mmHg))] / [1.34 \times Hb (g/L) \times (1 - SvO_2 (\%)/100) + 0.031 \times (PAO_2 (mmHg) - PvO_2 (mmHg))]$
oxygen transport index	DO ₂ I	ml/min/m ²	$DO_2I (ml/min/m^2) = CaO_2 (ml/L) \times (C.O. (L/min) / BSA (m^2))$
oxygen consumption	VO ₂ I	ml/min/m ²	$VO_2I (ml/min/m^2) = C(a-v)O_2 (ml/L) \times (C.O. (L/min) / BSA (m^2))$

28.6 Ventilation Calculations

The monitor provides the ventilation calculation function and can save the results of up to 10 calculations, which are displayed in groups.

28.6.1 Performing Ventilation Calculations

To perform ventilation calculations, follow this procedure:

1. Access ventilation calculation by either of the following ways:
 - ◆ Select the **Calculations** quick key → **Ventilation** tab.
 - ◆ Select the **Main Menu** quick key → from the **Calculations** column select **Ventilation**.
2. Enter the known values. For a patient who is being monitored, the currently measured values are automatically taken. If the anesthesia machine or ventilator is connected, measured values for ventilation calculation are also automatically entered.
3. Select **Calculate**.

A calculated value greater than the normal upper limit is indicated by an up arrow "↑". A calculated value lower than the normal lower limit is indicated by a down arrow "↓".

On the **Ventilation** page, you can also perform the following operations:

- Select **Pressure Unit**. Then corresponding parameter values will be automatically converted and updated accordingly.
- Select **Range** to show the normal range of each parameter.

28.6.2 Input Parameters for Ventilation Calculations

Input Parameter	Label	Unit
percentage fraction of inspired oxygen	FiO ₂	%
respiration rate	RR	rpm
partial pressure of mixed expiratory CO ₂	PeCO ₂	mmHg, kPa
partial pressure of carbon dioxide in the arteries	PaCO ₂	mmHg, kPa
partial pressure of oxygen in the arteries	PaO ₂	mmHg, kPa
tidal volume	TV	ml
respiratory quotient	RQ	None
atmospheric pressure	ATMP	mmHg, kPa

28.6.3 Calculated Parameters and Formulas for Ventilation Calculations

Calculated Parameters	Label	Unit	Formula
partial pressure of oxygen in the alveoli	PAO ₂	mmHg, kPa	$PAO_2 \text{ (mmHg)} = [ATMP \text{ (mmHg)} - 47 \text{ mmHg}] \times FiO_2 \text{ (\%)/100} - PaCO_2 \text{ (mmHg)} \times [FiO_2 \text{ (\%)/100} + (1 - FiO_2 \text{ (\%)/100})/RQ]$
alveolar-arterial oxygen difference	AaDO ₂	mmHg, kPa	$AaDO_2 \text{ (mmHg)} = PAO_2 \text{ (mmHg)} - PaO_2 \text{ (mmHg)}$
oxygenation ratio	Pa/FiO ₂	mmHg, kPa	$Pa/FiO_2 \text{ (mmHg)} = 100 \times PaO_2 \text{ (mmHg)}/FiO_2 \text{ (\%)}$
arterial to alveolar oxygen ratio	a/AO ₂	%	$a/AO_2 \text{ (\%)} = 100 \times PaO_2 \text{ (mmHg)}/PAO_2 \text{ (mmHg)}$
minute volume	MV	L/min	$MV \text{ (L/min)} = [TV \text{ (ml)} \times RR \text{ (rpm)}]/1000$

Calculated Parameters	Label	Unit	Formula
volume of physiological dead space	Vd	ml	$Vd (ml) = TV (ml) \times [1 - PeCO_2 (mmHg)/PaCO_2 (mmHg)]$
physiologic dead space in percent of tidal volume	Vd/Vt	%	$Vd/Vt (\%) = 100 \times Vd (ml)/TV (ml)$
alveolar volume	VA	L/min	$VA (L/min) = [TV (ml) - Vd (ml)] \times RR (rpm) / 1000$

28.7 Renal Calculations

The monitor provides the renal calculation function and can save the results of up to 10 calculations, which are displayed in groups.

28.7.1 Performing Renal Calculations

To perform renal calculations, follow this procedure:

- Access renal calculation by either of the following ways:
 - ◆ Select the **Calculations** quick key → select the **Renal** tab.
 - ◆ Select the **Main Menu** quick key → from the **Calculations** column select **Renal**.
- Enter the known values.
- Select **Calculate**.

A calculated value greater than the normal upper limit is indicated by an up arrow "↑". A calculated value lower than the normal lower limit is indicated by a down arrow "↓".

You can select **Range** to show the normal range of each parameter.

28.7.2 Calculated Parameters and Formulas for Renal Calculations

Input Parameter	Label	Unit
urine potassium	URK	mmol/L
urinary sodium	URNa	mmol/L
urine	Urine	ml/24 hrs
plasm osmolality	Posm	mOsm/kgH ₂ O
urine osmolality	Uosm	mOsm/kgH ₂ O
serum sodium	SerNa	mmol/L
creatinine	Cr	μmol/L
urine creatinine	UCr	μmol/L
blood urea nitrogen	BUN	mmol/L
height	Height	cm
weight	Weight	kg

28.7.3 Calculated Parameters and Formulas for Renal Calculations

Calculated Parameters	Label	Unit	Formula
urine sodium excretion	URNaEx	mmol/24 hrs	$URNaEx \text{ (mmol/24 hrs)} = \text{Urine (ml/24 hrs)} \times URNa \text{ (mmol/L)}/1000$
urine potassium excretion	URKEx	mmol/24 hrs	$URKEx \text{ (mmol/24 hrs)} = \text{Urine (ml/24 hrs)} \times URK \text{ (mmol/L)}/1000$
sodium potassium ratio	Na/K	%	$Na/K \text{ (\%)} = 100 \times URNa \text{ (mmol/L)}/URK \text{ (mmol/L)}$
clearance of sodium	CNa	ml/24 hrs	$CNa \text{ (ml/24 hrs)} = URNa \text{ (mmol/L)} \times \text{Urine (ml/24 hrs)}/SerNa \text{ (mmol/L)}$
creatinine clearance rate	Clcr	ml/min	$Clcr \text{ (ml/min)} = Ucr \text{ (\mu mol/L)} \times \text{Urine (ml/24 hrs)}/[Cr \text{ (\mu mol/L)} \times (BSA \text{ (m}^2)/1.73) \times 1440]$
fractional excretion of sodium	FENa	%	$FENa \text{ (\%)} = 100 \times URNa \text{ (mmol/L)} \times Cr \text{ (\mu mol/L)}/[SerNa \text{ (mmol/L)} \times Ucr \text{ (\mu mol/L)}]$
osmolar clearance	Cosm	ml/min	$Cosm \text{ (ml/min)} = Uosm \text{ (mOsm/kgH}_2\text{O)} \times \text{Urine (ml/24 hrs)}/(Posm \text{ (mOsm/kgH}_2\text{O)} \times 1440)$
free water clearance	CH2O	ml/hr	$CH2O \text{ (ml/hr)} = \text{Urine (ml/24 hrs)} \times [1 - Uosm \text{ (mOsm/kgH}_2\text{O)}/Posm \text{ (mOsm/kgH}_2\text{O)}]/24$
urine to plasma osmolality ratio	U/P osm	None	$U/P \text{ osm} = Uosm \text{ (mOsm/kgH}_2\text{O)}/Posm \text{ (mOsm/kgH}_2\text{O)}$
blood urea nitrogen creatinine ratio	BUN/Cr*	Mmol/L	$BUN/Cr = 1000 \times BUN \text{ (mmol/L)}/Cr \text{ (\mu mol/L)}$
urine-serum creatinine ratio	U/Cr	None	$U/Cr \text{ (mmol/L)} = Ucr \text{ (\mu mol/L)}/Cr \text{ (\mu mol/L)}$

*: BUN/Cr is a ratio under the unit of mol.

29 Recording

29.1 Recorder

The thermal recorder records patient information, measurement data, and up to three waveforms.

N17/N15/N12 can be configured with a built-in recorder. If the built-in recorder is not configured, the monitor can be configured to use an external recorder module.

N22 and N19 do not have a built-in recorder. To perform recording, insert the recorder module into the SMR.

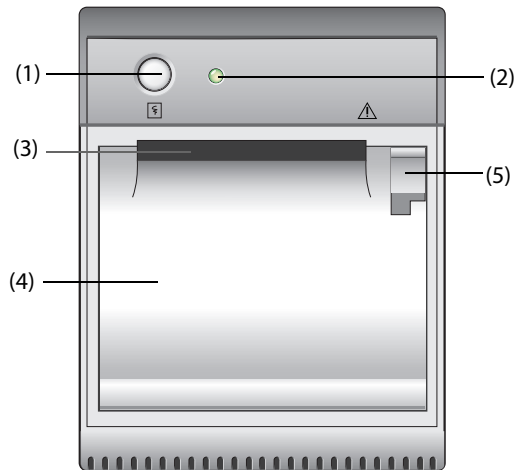



- (1) Start/Stop key: press to start a recording or stop the current recording.
- (2) Module status indicator
 - ◆ On: when the recorder is powered and ready for use.
 - ◆ Off: when the monitor is switched off.
 - ◆ Flashes: if an error has occurred with the recorder.
- (3) Paper outlet
- (4) Recorder door
- (5) Latch: pull it away from the recorder to open the recorder door.

29.2 Starting Recordings

Recordings can be started manually or automatically.

29.2.1 Manually Starting Recordings

To manually start a recording, you can either:

- Press the  hardkey on the front of the recorder to start a Realtime Segment Waveform Recording.
- Select  on the current dialog to start a recording corresponding to that dialog or page.

29.2.2 Automatic Recordings

In the following conditions, you can set the recorder to automatically start recording:

- At a preset interval. For more information, see *29.5 Setting up the Recorder*.
- When a parameter alarm is triggered. For more information, see *33.3.10.3 Enabling Automatic Recordings on an Alarm*.

29.3 Stopping Recordings

Recordings can be stopped manually or automatically.

29.3.1 Stopping Recordings Manually

To manually stop a recording, press the  hardkey while the recorder is creating a strip or select **Clear All Record Tasks** in the **Record Setup** menu.

29.3.2 Stopping Recordings Automatically

Recordings stop automatically in the following conditions:

- The recording is completed.
- The recorder runs out of paper.
- The recorder has an alarm condition.
- The recorder module is removed from the monitor.
- The monitor is turned off.

29.4 Recording Related Flags

You can find the following flags on the recording reports:

- For automatically stopped recordings, there are two columns of asterisks "*" at the end of the report.
- For manually or abnormally stopped recordings, there is one column of asterisks "*" at the end of the report.
- If the parameter data is from external devices connected to the monitor via the BeneLink module, the parameter label is prefixed with the plus sign "+".

29.5 Setting up the Recorder

To configure the recorder for waveforms and printing intervals, follow this procedure:

1. Select the **Main Menu** quick key → from the **Report** column select **Record Setup**.
2. In the **Record Setup** dialog, select the desired waveform for **Waveform 1**, **Waveform 2** and **Waveform 3** in turn. The recorder can record up to 3 waveforms at a time.
3. Switch on or off **IBP Overlap** to enable or disable IBP recordings in the overlapping format.
 - ◆ When the **IBP Overlap** is enabled: If two or more waveforms in the selected waveforms for recording are IBP waveforms, the IBP waveforms will be recorded in the overlapping format.
 - ◆ When the **IBP Overlap** is disabled: IBP waveforms will be recorded without overlap.
4. Select **Recording Duration** to set the duration of real-time recording.
5. Select **Interval** to set the time interval for automatic recording.
6. Select **Recorder Paper Speed** to set the speed for recording waveforms.

29.6 Clearing Recording Tasks

To clear recording tasks, follow this procedure:

1. Select the **Main Menu** quick key → from the **Report** column select **Record Setup**.
2. In the **Record Setup** dialog, select **Clear All Record Tasks**. This clears all queued recording tasks and stops the current recording.

29.7 Loading Paper

To load paper, follow this procedure:

1. Use the latch at the upper right of the recorder door to pull the door open.
2. Insert a new roll into the compartment as shown below. Feed the paper through and pull some paper out from the top of the roller.
3. Close the recorder door.

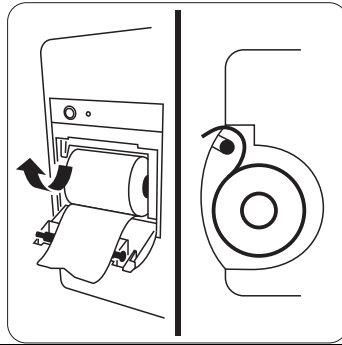

CAUTION

- **Use only specified thermal paper. Otherwise, it may cause damage to the recorder's printhead, the recorder may be unable to print, or poor print quality may result.**
 - **Never pull the recorder paper with force when a recording is in process. Otherwise, it may cause damage to the recorder.**
 - **Do not leave the recorder door open unless you are reloading paper or cleaning a paper jam.**
-

29.8 Removing Paper Jam

If the recorder works incorrectly or produces unusual sounds, check if there is a paper jam. If a paper jam is detected, follow this procedure to remove it:

1. Open the recorder door.
2. Take out the paper and tear off the draped part.
3. Reload the paper and close the recorder door.

29.9 List of Recording Reports

The recorder can output the following reports:

- Realtime reports
 - ◆ Realtime Segment Waveform Record
 - ◆ Realtime Continuous Waveform Record
 - ◆ Auto Realtime Record
 - ◆ ST Record
 - ◆ QT Record
 - ◆ 12-Lead Interpretation Record
 - ◆ Record on Alarm Report
 - ◆ 12-Lead Waveform Record
- History reports
 - ◆ Event Detail
 - ◆ Full Disclosure Detail Record
 - ◆ 12 Lead Review Record
 - ◆ ST Review Record

- ◆ Tabular Trend Report
- ◆ Graphic Trend Report

30 Printing

30.1 Supported Printer

The monitor can output patient reports via a connected network printer. The monitor supports the following printers:

- HP LaserJet Pro M202dw
- HP LaserJet Pro 400 M401n
- HP LaserJet P4015n
- HP LaserJet 600 M602
- HP LaserJet Enterprise M605
- HP LaserJet Enterprise M608n

NOTE

- **For more details about the printer, refer to the document accompanying the printer. With product upgrades, the monitor may support additional printers without prior notice. If you have any doubts about the compatibility of the printer used with this monitor, contact Mindray.**
-

30.2 End Case Reports

30.2.1 Printing the End Case Report

To print the end case report, choose one of the following ways:

- Select **Print** from the **End Case Report** menu.
- Select **Print End Case Report** when you discharge a patient.
- Select the **End Case Report** quick key.

30.2.2 Setting a Report as An End Case Report

The following reports can be set as end case reports:

- Tabular Trends Report
- Graphic Trends Report
- Event Report
- 12-lead Interpretation
- Alarm Limits Report
- Realtime Report
- ECG Report

To set a report as an end case report, follow this procedure:

1. Select the **Main Menu** quick key → from the **Report** column select **End Case Report**.
2. From the **Select Reports** page, select the desired report tab, for example **ECG Report**.

30.2.3 Configuring the End Case Reports

To configure the end case reports, follow this procedure:

1. Select the **Main Menu** quick key → from the **Report** column select **End Case Report**.

2. From the **Report Setup** page, set the following end case reports:
 - ◆ Select the **Tabular Trends Report, Graphic Trends Report, Realtime Report,** and **ECG Report** tab, and set these end case report by referring to section *30.6 Configuring Reports*.
 - ◆ Select the **Event Report** tab, and select the event that needs to be printed.
 - ◆ Select the **12-Lead Interpretation** tab, and set the switch of **Median Complex, Measurements, Interpretation,** or **Interpretation Summary**. For other settings, refer to section *30.6.1 Configuring ECG Reports*.

30.2.4 Setting the End Case Report Period

To set the end case report print period, follow this procedure:

1. Select the **Main Menu** quick key → from the **Report** column select **End Case Report**.
2. From the **Select Reports** page, set the **Period**.

NOTE

- **End case report print period is calculated from the patient discharged time to the configured period.**
- **Period setting is applicable to all of the end case reports.**

30.3 Manually Starting a Printing Task

This section describes different methods for manually printing a report.

30.3.1 Printing from the Screen

The  button will be shown at the top of dialogs that have associated reports. If the button is gray, then there is not enough information to begin the report, or the printer has not been set up.

When the icon is white, pressing it opens a **Print Setup** dialog or starts printing a report. If the **Print Setup** dialog is entered, configure the report and press **Print** to start printing.

30.3.2 Printing Realtime Reports

Select the **Print** quick key to print a realtime report. You can also print a realtime report from the **Report Setup** dialog. For more information, see *30.3.3 Printing Most Common Reports*.

30.3.3 Printing Most Common Reports

The following most common reports can be printed:

- ECG Report
- Realtime Report
- Tabular Trends Report
- Graphic Trend Report.

To print these reports, follow this procedure:

1. Select the **Main Menu** quick key → from the **Report** column select **Report Setup**.
2. Select the desired report tab.
3. Check the settings.
4. Select **Print**.

30.4 Automatically Printing Reports

When a parameter alarm switch is set to on and an alarm is triggered for this parameter, you can set the monitor to automatically print a Print on Alarm Report.

To do so, follow this procedure:

- Access alarm related tabs such as the **Alarm** tab for a parameter in one of the following ways:
 - ◆ Select the **Alarm Setup** quick key at the bottom of the screen.
 - ◆ Select the parameter or waveform area of the desired parameter → select the **Alarm** tab.
 - ◆ Select the **Parameters Setup** quick key at the bottom of the screen → select the desired parameter → select the **Alarm** tab.
 - ◆ Select the **Main Menu** quick key → from the **Parameters** column select **Setup** → select the desired parameter → select the **Alarm** tab.
- Switch on **Alarm Outputs** for desired parameters.

30.5 Stopping a Printing Task

To stop a printing task, follow this procedure:

- Select the **Main Menu** quick key → from the **Report** column select **Print Queue**.
- Select desired printing tasks and then select **Delete**. Alternately, select **Delete All** to stop all the printing tasks.

30.6 Configuring Reports

This section focuses on how to configure ECG reports, realtime reports, tabular trends reports, and graphic trends reports.

30.6.1 Configuring ECG Reports

To configure ECG reports, follow this procedure:

- Select the **Main Menu** quick key → from the **Report** column select **Report Setup**.
- Select the **ECG Report** tab.
- Set the desired options. The following table explains some of the less familiar options.

Menu item	Function	Description
Speed	Set the print speed of ECG waveforms	25 mm/sec: prints 25 mm of ECG waveform per second. 50 mm/sec: prints 50 mm of ECG waveform per second.
Auto Interval	Defines the spacing between the ECG waveforms on a printout	On: automatically adjusts the space between waveforms to avoid overlapping. Off: each waveform area has the same size on a printout.
		Note: Auto Interval is only enabled when 12x1 is selected for 12-Lead Format .
12-Lead Format	Select the format of 12-lead ECG waveforms on a printout.	12x1: displays 12-lead ECG waveforms on one page in one column. 6x2: displays 12-lead ECG waveforms on one page in two columns, with 6 lines in each column. 6x2+1: displays 12-lead ECG waveforms on one page in two columns, with 6 lines in each column, and one rhythm lead waveform at the bottom. 3x4+1: displays 12-lead ECG waveforms on one page in 4 columns, with 3 lines in each column, and one rhythm lead waveform at the bottom. 3x4+3: displays 12-lead ECG waveforms on one page in 4 columns, with 3 lines in each column, and three rhythm lead waveforms at the bottom.
Rhythm Lead 1 Rhythm Lead 2 Rhythm Lead 3	Select the lead that will be used as Rhythm Lead 1, 2, or 3.	I, II, III, aVR, aVL, aVF, V1, V2, V3, V4, V5, V6
		Note: Rhythm Lead setting is only enabled when 6x2+1 , 3x4+1 , or 3x4+3 is selected for 12-Lead Format .

Menu item	Function	Description
Format Sequence	Select the recording method of ECG report generated by auto measurement	Sequential: 12-lead ECG data are recorded sequentially and displayed in 3 lines and 4 columns with 2.5 seconds of ECG data for each column. Simultaneous: Record simultaneous 12-lead ECG data.

NOTE

- When ECG Lead Set is set to 3-Lead, the ECG report cannot be printed.

30.6.2 Configuring Realtime Reports

To configure tabular realtime reports, follow this procedure:

1. Select the **Main Menu** quick key → from the **Report** column select **Report Setup**.
1. Select the **Realtime Report** tab.
2. Set the desired options. The following table explains some of the options.

Menu item	Function	Description
Select Waveform	Select the desired waveform to print	Current Waveforms: prints the realtime report for the currently displayed waveforms and all the currently measured parameter values. Selected Waveforms: prints the realtime report for the waveforms configured in the Select Waveform dialog, accessed by clicking the Select Waveform button.

30.6.3 Configuring Tabular Trends Reports

To configure tabular trends reports, follow this procedure:

1. Select the **Main Menu** quick key → from the **Report** column select **Report Setup**.
2. Select the **Tabular Trends Report** tab.
3. Set the desired options.

The following table explains some of the options.

Menu Item	Function	Description
Time	Select the time before which a tabular trends report will be printed	/
Period	Select the period during which a tabular trends report will be printed.	Auto: one page of a tabular trends before the current time will be printed at the selected Interval . All: all stored tabular trends will be printed at the selected Interval . 30 min to 96 hrs: 30 min to 96 hrs of tabular trends before the selected Time will be printed at the selected Interval .
Interval	Select the resolution of the tabular trends printed on a report.	NIBP, EWS, GCS, C.O.: at an interval of acquiring the values of selected parameter. Auto: using the Interval setting of the Tabular Trends review page. 5 sec to 3 hrs: the tabular trends will be printed at the interval of 5 sec to 3 hrs .

Menu Item	Function	Description
Report Format	Select the printing principle.	<p>Parameter Oriented: print one page span of report with parameters listed by row and time listed by column when Interval is set to Auto.</p> <p>Time Oriented: print one page span of report with time listed by row and parameter listed by column when Interval is set to Auto.</p> <p>Note that Interval on Auto only limits the number of rows or columns for Time. The report may have multiple pages to accommodate the number of parameters. To limit the parameters, change the Trend Group.</p>

30.6.4 Configuring Graphic Trends Reports

To set graphic trends reports, follow this procedure:

1. Select the **Main Menu** quick key → from the **Report** column select **Report Setup**.
2. Select the **Graphic Trends Report** tab.
3. Set the desired options.

Menu Item	Function	Description
Period	Select the period during which a graphic trends report will be printed.	<p>Auto: one page of a graphic trends before the current time will be printed.</p> <p>All: all stored graphic trends will be printed..</p> <p>30 min to 96 hrs: 30 min to 96 hrs of graphic trends before the selected Time will be printed.</p>

30.7 Viewing Printer Status

You can view the status of the most recent ten printing tasks in the **Print Queue** dialog. To view the status of printing tasks, follow this procedure:

1. Select the **Main Menu** quick key → from the **Report** column select **Print Queue**.
2. View the status of printing tasks in the **Print Queue** dialog.

Each printing task includes the following information:

- Print time
- Report title
- Printer name (when using the printer server) or IP address (when using the network printer)
- Printing status, for example, printing, failed, retrying, and waiting.

30.8 Printer Out of Paper

When the printer runs out of paper, the print request will remain incomplete. If there are too many print jobs that remain incomplete, then a printer error may occur. To resolve the error, install paper. Some print requests may be lost if the incomplete tasks overflow the printer buffer. Missing or lost reports must be recreated and printed.

To reduce risks of printer errors, maintain enough paper in the printer.

30.9 List of Reports

The monitor can output the following reports to the printer:

- Realtime reports
 - ◆ Realtime Report
 - ◆ Freeze Report
 - ◆ ECG Report (5-lead, 6-lead, 12-lead)
 - ◆ 12-Lead Interpretation Report (realtime)

- ◆ Print on Alarm Report
- ◆ Alarm Limits Report
- ◆ Titration Table Report
- ◆ Hemodynamic Calculation Report
- ◆ Oxygenation Calculation Report
- ◆ Ventilation Calculation Report
- ◆ Renal Calculation Report
- ◆ EEG Report
- ◆ CSA Report (EEG expand View - CSA)
- ◆ EEG Report (EEG expand View - EEG)
- ◆ Hemodynamic Report (hemodynamic parameters)
- ◆ Hemodynamic Report (hemodynamic graphics)
- ◆ ST Report (Realtime)
- ◆ QT Report (Realtime)
- ◆ OxyCRG Report
- ◆ C.O. Measure Report
- ◆ PAWP Report
- ◆ ECG 24h Summary & Typical Strips
- ◆ Device Integration - Loops Report (BeneLink)
- History reports
 - ◆ Tabular Trends Report
 - ◆ Graphic Trends Report
 - ◆ Event List Report
 - ◆ Event Detail Report
 - ◆ Full Disclosure Overview Report
 - ◆ Full Disclosure Detail Report
 - ◆ 12-Lead Review Interpretation Report (review)
 - ◆ ST Report (review)
 - ◆ OxyCRG review Report (review)
- End Case Report
 - ◆ End Case Report - Realtime Report
 - ◆ End Case Report -ECG Report
 - ◆ End Case Report - Tabular Trends Report
 - ◆ End Case Report - Graphic Trends Report

31 Using the On-Screen Timers

The monitor has a Timer function to notify you when a preset time period is expired or how much time has elapsed. You can simultaneously display up to four timers.

31.1 Displaying Timers

To display a timer, follow this procedure:

1. Access **Tile Layout** in either of the following ways:
 - ◆ Select the **Screen Setup** quick key → select the **Tile Layout** tab.
 - ◆ Select the **Main Menu** quick key → from the **Display** column select **Tile Layout**.
2. Click the numeric tile area where the timer is to be displayed, and then select a timer from the popup list.

31.2 Controlling the Timer

The timer provides the following controls, depending on the state and settings of the timer:

- **Start:** starts the timer.
- **Pause:** pauses the timer.
- **Resume:** resumes the timer.
- **Reset:** clears the timer.

31.3 Setting the Timer

You can set each timer independently. To set the timer, follow this procedure:

1. Select the timer area to enter the **Timer Setup** dialog.
2. Set **Timer Type**:
 - ◆ **Normal:** The timer has a single and defined run time, and stops with a notification beep when the run time is reached.
 - ◆ **Advanced:** The timer has a single and defined run time. When the run time is reached, the timer makes a notification beep and continuously displays the time beyond the end of run time.
 - ◆ **Cycled:** The timer has a single and defined run time. When the run time is reached, the timer makes a notification beep and restarts automatically. The number of elapsed cycles is also displayed on the left of the Timer tile.
 - ◆ **Unlimited:** The timer displays the time elapsed since the timer was started.
 - ◆ **Clock:** The timer displays the system time.
3. Set **Direction**.
 - ◆ **Up:** the timer counts up, from zero to Run Time.
 - ◆ **Down:** the timer counts down, from Run Time to zero.
4. Set **Run Time**.
5. Set **Reminder Volume**.

A progress bar is shown with the run time. When the remaining time is 10 seconds, the monitor issues a reminder tone and the timer flashes in red, prompting you that the run time is about to expire.

NOTE

- You cannot change timer settings, other than Reminder Volume when a timer is running.
 - You can set Direct, Run Time, and Reminder Volume only for normal, advanced, and cycled timers.
-

This page intentionally left blank.

32 Managing Configurations

32.1 Configuration Introduction

When performing continuous monitoring on a patient, the clinical professional often needs to adjust the monitor's settings according to the patient's condition. The collection of all these settings is called a configuration. The system configuration items can be classified as: parameter configuration items, conventional configuration items, and user maintenance items. Allowing you to configure the monitor more efficiently, the monitor provides different sets of configurations to accommodate the varying patient categories and departments. You can change some settings from a certain set of configuration and then save the changed configuration as a user configuration.

The default configurations provided for your monitor are department-oriented. You can choose either from:

- General
- OR
- ICU
- Neonatology
- CCU

Each department has three different sets of configurations tailored for adult, pediatric and neonatal patients respectively.

WARNING

- **The configuration management function is password protected. The configuration management tasks must be performed by clinical professionals.**
-

32.2 Changing the Department

If the current department configuration is not the one you want to view, you can change the department by following this procedure:

1. Select the **Main Menu** quick key → from the **Configuration** column select **Manage** → input the required password → select .
2. Select **Change Department**.
3. Select a department.
4. Select **Ok**.

CAUTION

- **Changing the department will delete all current user configurations.**
-

32.3 Setting Default Patient Category

To set the default patient category when admitting a new patient, follow this procedure:

1. Select the **Main Menu** quick key → from the **Configuration** column select **Manage** → input the required password → select .
2. Set **Default Patient Category**.

32.4 Setting Default Configuration

The monitor will load the pre-set default configuration in the following cases:

- A patient is admitted.
- A patient is discharged.
- Patient category is changed.

To set the default configuration, follow this procedure:

1. Select the **Main Menu** quick key → from the **Configuration** column select **Manage** → input the required password → Select .
2. Select **Select Default Config.**
3. Select **Load the Latest Config** or **Load Specified Config.**
 - ◆ When you select **Load Specified Config**, the restored configuration is subject to the patient category (adult, pediatric or neonate). This configuration can be either factory configuration or a saved user configuration. As an example, select **Default Adult Config** and then select **Factory Default** or user configuration(s).
 - ◆ When you select **Load the Latest Config**, the latest configuration is loaded when the monitor is started or a patient is admitted.

32.5 Saving Current Settings

Current settings can be saved as a user configuration. Up to 25 user configurations can be saved.

To save current settings, follow this procedure:

1. Select the **Main Menu** quick key → from the **Configuration** column select **Manage** → input the required password → Select .
2. Select **Save Current Settings.**
3. Input the configuration name.
4. Select **Ok** to save current settings as a user configuration.

32.6 Deleting a Configuration

To delete a configuration, follow this procedure:

1. Select the **Main Menu** quick key → from the **Configuration** column select **Manage** → input the required password → Select .
2. Select **Delete Configuration.**
3. Select the configuration you want to delete:
 - ◆ In the **Delete Configuration** dialog, selecting **Local** tab shows the existing user configurations on the monitor.
 - ◆ In the **Delete Configuration** dialog, selecting **USB Drive** tab shows the existing user configurations on the USB drive.
4. Select **Delete.**
5. Select **Ok.**

32.7 Transferring a Configuration

When installing several monitors with identical user configurations, it is not necessary to set each unit separately. Use a USB drive to transfer the configuration from monitor to monitor.

32.7.1 Exporting a Configuration

To export the current monitor's configuration, follow this procedure:

1. Connect the USB drive to the monitor's USB port.
2. Select the **Main Menu** quick key → from the **Configuration** column select **Manage** → input the required password → Select .
3. Select **Export Configuration.**

4. Select the configurations and **User Maintenance Settings** to export.
5. Select **Export**.

32.7.2 Importing a Configuration

To import the configuration from the USB drive to the monitor, follow this procedure:

1. Connect the USB drive to the monitor's USB port.
2. Select the **Main Menu** quick key → from the **Configuration** column select **Manage** → input the required password → Select .
3. Select **Import Configuration**.
4. Select the configurations and **User Maintenance Settings** to import.
5. Select **Import**.

32.7.3 Loading a Configuration

You may make changes to some settings during operation. However, these changes or the pre-selected configuration may not be appropriate for the newly admitted patient. Therefore, the monitor allows you to load a desired configuration to ensure that all the settings are appropriate for your patient.

To load a configuration, follow this procedure:

1. Select the **Main Menu** quick key → from the **Configuration** column select **Load**.
2. Select the desired configuration.
 - ◆ Select the configuration on this monitor in the **Local** page.
 - ◆ Select the configuration on the USB drive in the **USB Drive** page.
3. Select **Load**.

NOTE

-
- **The monitor may configure some settings by default when you load a configuration of different software version with the current configuration.**
-

32.8 Printing Configurations

To print both factory configurations and user configurations, follow this procedure:

1. Select the **Main Menu** quick key → from the **Configuration** column select **Manage** → input the required password → select .
2. Select **Print Configuration**.
3. Select desired configurations.
4. Select **Print**.

32.9 Modifying Configuration Password

To modify the configuration password, follow this procedure:

1. Select the **Main Menu** quick key → from the **Configuration** column select **Manage** → input the required password → Select .
2. Select **Modify Password**.
3. Respectively input the old password and new password.
4. Select **OK**.

This page intentionally left blank.

33 Password-protected User Settings

This chapter describes the password-protected functions accessed in the **Maintenance** dialog.

33.1 Setting the Device Location

33.1.1 Setting Monitor Information

To set monitor information, follow this procedure:

1. Select the **Main Menu** quick key → from the **System** column select **Maintenance** → input the required password → select .
2. Select the **Device Location** tab.
3. Input monitor name, facility name and department name.

33.1.2 Setting Monitor Location

If your monitor is installed at a fixed position, or you do not need clinicians to change the room number and bed number, you can set **Monitor Location** to **Fixed**. To set the monitor location, follow this procedure:

1. Select the **Main Menu** quick key → from the **System** column select **Maintenance** → input the required password → select .
2. Select the **Device Location** tab.
3. Set **Location**.
 - ◆ **Fixed**: the **Patient Management** dialog displays **Bed No.** and **Room No.**, but you cannot change them.
 - ◆ **Unfixed**: you can change **Bed No.** and **Room No.** from the **Patient Management** dialog.
4. Input the room number and bed number.

NOTE

- If **Location** is set to **Unfixed**, **Bed No.** and **Room No.** are cleared from the **Device Location** tab each time you discharge a patient.
-

33.1.3 Enabling the Auto Obtain Bed Number Function

If the monitor is connected to the wired network, the monitor can automatically set the patient's bed number according to the bed number information bonded to the bedside network connector.

To enable this function, follow this procedure:

1. Select the **Main Menu** quick key → from the **System** column select **Maintenance** → input the required password → select .
2. Select the **Device Location** tab.
3. Select **Unfixed**.
4. Switch on **Auto Obtain Bed No.**

NOTE

- The **Auto Obtain Bed Number** function is available only when the switch connected to the monitor supports the **LLDP** or **CDP** protocol, and the corresponding protocol is enabled.
-

33.2 Changing Patient Management Settings

33.2.1 Selecting Displayed Patient Information

You can define which items can be displayed and edited from the **Patient Management** tab. To do so, follow this procedure:

1. Select the **Main Menu** quick key → from the **System** column select **Maintenance** → input the required password → select .
2. Select the **Patient Management** tab.
3. Select the fields you want to display in the **Patient Management** dialog.
4. If necessary, select the customized fields and input names for these fields.

NOTE

- **If the monitor is connected with the CMS, the patient information items and customized fields are loaded from the CMS.**

33.2.2 Setting the Length of Data Transferred by N1 or T1

When using N1 or T1 to transfer the patient data, you can set the data transfer length. To do so, follow this procedure:

1. Select the **Main Menu** quick key → from the **System** column select **Maintenance** → input the required password → select .
2. Select the **Patient Management** tab → select the **Transfer** tab.
3. Set **Transfer Data Length**.

33.2.3 Setting the Strategy of Transferring Patient Information

When N1, T1 or MPM is connected to the monitor, N1, T1 or MPM automatically uploads the data to the monitor if the patient demographic information in the monitor are consistent with those of in N1, T1 or MPM. However, the monitor needs a data transfer strategy if the patient demographic information in the monitor are not consistent with those of in the N1/T1/MPM. To set the data transfer strategy, follow this procedure:

1. Select the **Main Menu** quick key → from the **System** column select **Maintenance** → input the required password → select .
2. Select the **Patient Management** tab → select the **Transfer** tab.
3. Select **Data Transfer Strategy**.
 - ◆ **Always Ask:** always prompts a dialog box to ask for strategy.
 - ◆ **Continue Patient in Module:** continue to use the patient data in N1/T1/MPM. The monitor discharges the patient, and automatically admits a new patient and copies all data from N1/T1/MPM.
 - ◆ **Continue Patient in Monitor:** continue to use the patient information in the monitor. The monitor deletes all patient information in the N1/T1/MPM and copies the parameter settings in the monitor to the N1/T1/MPM.

33.2.4 Transferring the N1 or T1 Settings

When transferring the N1 or T1 data, the settings can also be transferred. To transfer settings, follow this procedure:

1. Select the **Main Menu** quick key → from the **System** column select **Maintenance** → input the required password → select .
2. Select the **Patient Management** tab → select the **Transfer** tab.
3. Set **Apply Module Settings** to **On**.

33.2.5 Auto Discharging a Patient after Monitor Power Off

You can let the monitor automatically discharge after the monitor has been switched off for a period of time.

To set the time period of discharging a patient, follow this procedure:

1. Select the **Main Menu** quick key → from the **System** column select **Maintenance** → input the required password → select .
2. Select the **Patient Management** tab → select the **Discharge** tab.
3. Select a time for **Auto Discharge When Power Off**. The monitor will automatically discharge the patient when it is turned off for the designated period of time. The default is **Never**. That is to say the monitor will not automatically discharge a patient, regardless of how long the monitor has been switched off.

33.2.6 Clearing All Patient Data

You can delete all patient information and data in the monitor. To do so, follow this procedure:

1. Select the **Main Menu** quick key → from the **System** column select **Maintenance** → input the required password → select .
2. Select the **Patient Management** tab → select the **Discharge** tab.
3. Select **Clear All Patient Data**.
4. Select **OK**. Select **OK** again for confirmation until a message indicating you that all data is cleared.

CAUTION

- **Clearing patient data will discharge the current patient. Make sure there is no patient is being monitored before you clear all data.**
-

33.2.7 Selecting Query Criteria for Searching Patients in ADT Server

You can define which criteria can be used to search patients in the ADT server. To do so, follow this procedure:

1. Select the **Main Menu** quick key → from the **System** column select **Maintenance** → input the required password → select .
2. Select the **Patient Management** tab → **ADT Query** tab.
3. Select the query criteria as desired.

33.2.8 Setting Patient Location Options for the Discharge Screen

To set options for patient location, follow this procedure:

1. Select the **Main Menu** quick key → from the **System** column select **Maintenance** → input the required password → select .
2. Select the **Patient Management** tab → select the **Location** tab.
3. Input or edit patient location options.

33.2.9 Hiding Patient Name

To hide patient name on specific screens, follow this procedure:

1. Select the **Main Menu** quick key → from the **System** column select **Maintenance** → input the required password → select .
2. Select the **Patient Management** tab → select the **Display** tab.
3. Set the following switches as desired:
 - ◆ Switch off **Primary Screen Display Full Name**: does not display patient name in the patient information area on the primary display.
 - ◆ Switch off **Secondary Screen Display Full Name**: does not display patient name in the patient information area on the secondary display, if configured.

- ◆ Switch off **Remote View Display Full Name**: does not display patient name in the patient information area on the remote monitors when this monitor is viewed by other monitors.
- ◆ Switch off **Remote View Bedlist Display Full Name**: does not display patient name in bed list on the remote monitors when this monitor is viewed by other monitors.

33.2.10 Select Whether a Prompt is Required When Auto Deleting Discharged Patients

The monitor automatically delete earlier discharged patients when the memory is limited. You can select whether an alarm is issued when discharged patients are automatically deleted and the monitor memory is very low.

1. Select the **Main Menu** quick key → from the **System** column select **Maintenance** → input the required password → select .
2. Set the **Review** tab → **Discharged Patients** tab.
3. Configure the alarms as needed:
 - ◆ **Prompt on patient auto deleted**: an alarm is issued when the monitor automatically deletes earlier discharged patients.
 - ◆ **Alarm on storage is nearly full**: selects whether an alarm is issued when the monitor memory is very low and the priority of this alarm.

33.3 Changing the Alarm Settings

33.3.1 Setting Alarm Tone Properties

33.3.1.1 Setting the Minimum Alarm Volume

To set the minimum alarm volume, follow this procedure:

1. Select the **Main Menu** quick key → from the **System** column select **Maintenance** → input the required password → select .
2. Select the **Alarm** tab → **Audio** tab.
3. Set **Minimum Alarm Volume**.

33.3.1.2 Setting the Audible Alarm Tone Pattern

You can distinguish the heart beat tone, pulse tone, and keystroke tone by frequency. You can choose any of the three tone patterns: ISO, Mode 1, and Mode 2. For more information, see **8.3.3 Alarm Indicators**.

To set the alarm tone pattern, follow this procedure:

1. Select the **Main Menu** quick key → from the **System** column select **Maintenance** → input the required password → select .
2. Select the **Alarm** tab → **Audio** tab.
3. Set **Alarm Sound** to **ISO, Mode 1** or **Mode 2**.

33.3.1.3 Setting the Interval between Alarm Sounds

If you choose the ISO pattern, you can change the interval between alarm tones. To change the interval between alarm tones, follow this procedure:

1. Select the **Main Menu** quick key → from the **System** column select **Maintenance** → input the required password → select .
2. Select the **Alarm** tab → **Audio** tab.
3. Set **High Alarm Interval**, **Med Alarm Interval**, and **Low Alarm Interval**.

33.3.1.4 Setting Alarm Volume Escalation

The monitor provides the function of automatically escalating the alarm tone volume. When this function is enabled, if an alarm is not reset within the designated delay time after the alarm occurs, the volume of the alarm tone increases automatically.

To set the alarm volume escalation, follow this procedure:

1. Select the **Main Menu** quick key → from the **System** column select **Maintenance** → input the required password → select .
2. Select the **Alarm** tab → **Audio** tab.
3. Set **Auto Increase Volume**.
 - ◆ **2 Steps:** if an alarm is not reset within the designated delay time after the alarm occurs, the alarm volume automatically increases by two levels.
 - ◆ **1 Step:** if an alarm is not reset within the designated delay time after the alarm occurs, the alarm volume automatically increases by one level.
 - ◆ **Off:** if an alarm is not reset within the designated delay time after the alarm occurs, the volume of the alarm tone does not change.
4. Select **Increase Volume Delay** to set the delay time of alarm volume escalation.

NOTE

-
- **The alarm volume escalation function is not applied to the latched alarms.**
-

33.3.2 Setting Alarm Pausing and Resetting Properties

33.3.3 Defining the Pause Function

You can either pause alarms or pause alarm tones. This depends on the pause setting. To set the pause function, follow this procedure:

1. Select the **Main Menu** quick key → from the **System** column select **Maintenance** → input the required password → select .
2. Select the **Alarm** tab → **Pause/Reset** tab.
3. Set **Pause** to **Alarm Pause** or **Audio Pause**.

33.3.3.1 Setting the Alarm Pause Time/Alarm Tone Pause Time

The alarm pause time or alarm tone pause time can be set to **1 min**, **2 min**, **3 min**, or **Permanent**. The default audio pause time is two minutes.

To set the alarm tone pause time, follow this procedure:

1. Select the **Main Menu** quick key → from the **System** column select **Maintenance** → input the required password → select .
2. Select the **Alarm** tab → **Pause/Reset** tab.
3. Set **Pause Time**.

33.3.3.2 Setting the Priority of Audio Paused Alarms

To select alarm of what priority can be paused or alarm sound of what priority can be paused, follow this procedure:

1. Select the **Main Menu** quick key → from the **System** column select **Maintenance** → input the required password → select .
2. Select the **Alarm** tab → **Pause/Reset** tab.
3. Set **Pause Priority**.
 - ◆ **All:** pressing the **Alarm Pause** quick key pauses all alarms.

- ◆ **Med & Low:** pressing the **Alarm Pause** quick key pauses alarms of medium and low priority. The high priority alarms will not be paused.
- ◆ **Disable:** the **Alarm Pause** quick key is disabled.

33.3.3.3 Disabling the Options of Prolonging Alarm Pause Time/Alarm Tone Pause Time

To disable specific options for the clinician when prolonging alarm pause time or the alarm tone pause time, follow this procedure:

1. Select the **Main Menu** quick key → from the **System** column select **Maintenance** → input the required password → select .
2. Select the **Alarm** tab → **Pause/Reset** tab.
3. Switch off **Pause 5 min**, **Pause 10 min**, or **Pause 15 min**.

33.3.3.4 Setting Alarm Light Status on Alarm Reset

When the alarm system is reset, the monitor presents the alarm light by default, but you can switch off the alarm light. To change the alarm light setting, follow this procedure:

1. Select the **Main Menu** quick key → from the **System** column select **Maintenance** → input the required password → select .
2. Select the **Alarm** tab → **Pause/Reset** tab.
3. Set **Alarm Light**.
 - ◆ **On When Reset:** when the alarm system is reset, the alarm tones of the current alarms are switched off, but the alarm lamp remains flashing.
 - ◆ **Off When Reset:** when the alarm system is reset, both the alarm tone and alarm lamp of the current alarms are switched off.

33.3.3.5 Setting the Reminder Tones

When the alarm volume is set to zero, or the alarm is reset or switched off, the monitor issues a periodical reminder tone. The reminder tone is enabled by default.

To set the reminder tone, follow this procedure:

1. Select the **Main Menu** quick key → from the **System** column select **Maintenance** → input the required password → select .
2. Select the **Alarm** tab → **Pause/Reset** tab.
3. Set **Alarm Reset Reminder** and **Alarm Off Reminder**.
 - ◆ **On:** the monitor issues reminder tones at a designated interval.
 - ◆ **Re-alarm:** if the alarm condition persists the alarms marked with “√” will be re-generated after the designated reminder tone interval.
 - ◆ **Off:** the monitor does not issue reminder tones at a designated interval. The alarms marked with “√” will be silenced.
4. Set **Reminder Interval** to **10 min**, **5 min**, **3 min**, **2 min**, or **1 min**.

33.3.4 Latching Physiological Alarms

To latch physiological alarms, follow this procedure:

1. Select the **Main Menu** quick key → from the **System** column select **Maintenance** → input the required password → select .
2. Select the **Alarm** tab → **Latching** tab.
3. Select how you want to latch the alarms.

Alarm latching rules are as follows:

- You can separately latch visible alarm signals and audible alarm signals.

- Latching audible alarm signals simultaneously latches the corresponding visible signals.
- Selecting alarms of lower priority simultaneously latches higher priority alarms.
- Switching **V-Tach Latching Lock** off allows you to switch on or off **V-Tach Latching**.
- When **V-Tach Latching Lock** is switched on, V-Tach latching follows the setting of **Lethal** alarm latching and you cannot control **V-Tach Latching**.

33.3.5 Changing Remote Alarm Settings

33.3.5.1 Resetting Alarms for Remote Devices

You can reset the alarms occurring on the remote devices that are viewed on the **Remote View** screen of the monitor. To enable this function, follow this procedure:

1. Select the **Main Menu** quick key → from the **System** column select **Maintenance** → input the required password → select .
2. Select the **Alarm** tab → **Remote View** tab.
3. Switch on **Reset Remote Bed Alarms**. Then the **Alarm Reset** button appears on the bottom left of the **Remote View** screen.

To reset any remote device alarms, the clinician may now select the **Alarm Reset** button at the bottom of the **Remote View** screen.

NOTE

- You can reset remote device alarms only if the **Alarm Reset By Other Bed** switch is on at the remote devices and alarms are occurring on the remote device.

33.3.5.2 Authorizing the Alarm Reset to Other Devices

Alarms on your monitor can be reset by remote devices if you enable this function. To do so, follow this procedure:

1. Select the **Main Menu** quick key → from the **System** column select **Maintenance** → input the required password → select .
2. Select the **Alarm** tab → **Remote View** tab.
3. Switch on **Alarm Reset By Other Bed**.

33.3.5.3 Selecting the Alarm Reminder for Remote Devices

You can configure what alarm indicators are necessary for the remote devices. To do so, follow this procedure:

1. Select the **Main Menu** quick key → from the **System** column select **Maintenance** → input the required password → select .
2. Select the **Alarm** tab → **Remote View** tab.
3. Select **Alarm Reminder**:
 - ◆ **Visible + Audible**: the monitor provides visual alarm indication, and continuous audible alarm indication if the alarm persists at the remote device.
 - ◆ **Visible + Single Tone**: the monitor provides visual alarm indication, and a single tone when the alarm occurs at the remote device.
 - ◆ **Visible Only**: the monitor only provides visual alarm indication.

33.3.5.4 Presenting Alarm Sound for Remote Devices as per Alarm Priority

You can configure what priority of remote device alarms are presented for audible notification. To do so, follow this procedure:

1. Select the **Main Menu** quick key → from the **System** column select **Maintenance** → input the required password → select .
2. Select the **Alarm** tab → **Remote View** tab.

3. Select **Alarm Priority**:
 - ◆ **All**: the monitor sounds if an alarm occurs.
 - ◆ **High & Med**: the monitor sounds if a high or medium priority alarm occurs.
 - ◆ **High Only**: the monitor sounds only if a high priority alarm occurs.

33.3.5.5 Setting the Tone Pattern for Alarms from Remote Devices

The monitor provides the same alarm tone pattern for the remote device alarms as those for your monitor alarms. For more information on alarm tone pattern, see 8.3.3 *Alarm Indicators*.

To set the alarm tone pattern for the remote device alarms, follow this procedure:

1. Select the **Main Menu** quick key → from the **System** column select **Maintenance** → input the required password → select .
2. Select the **Alarm** tab → select the **Remote View** tab.
3. Set **Alarm Sound** to **ISO, Mode 1** or **Mode 2**.

33.3.5.6 Switching Off the Remote Device Disconnection Alarm

The monitor can provide an alarm if remote devices, for example, a bedside monitor or a telemetry, are disconnected. By default, the function is enabled. To disable the alarm, follow this procedure:

1. Select the **Main Menu** quick key → from the **System** column select **Maintenance** → input the required password → select .
2. Select the **Alarm** tab → **Remote View** tab.

Switch off **Remote Disconnected Alarm**.

33.3.6 Setting Nurse Call Properties

33.3.6.1 Selecting Alarms to be Sent to the Nurse Call System

To set the type and priority of alarms that are sent to the nurse call system, follow this procedure:

1. Select the **Main Menu** quick key → from the **System** column select **Maintenance** → input the required password → select .
2. Select the **Alarm** tab → **Nurse Call** tab.
3. Select **Signal Type**
 - ◆ **Pulse**: the nurse call signal is a pulse signal and each pulse lasts one second. When multiple alarms simultaneously occur, only one pulse signal is outputted. If an alarm occurs but the previous one is not cleared, a new pulse signal will also be outputted.
 - ◆ **Continuous**: the nurse call signal lasts until the alarm ends. That is to say the duration of a nurse call signal is equal to that of the alarm condition.
4. Select **Contact Type** to set the work mode of the nurse call relay.
5. Select **Alarm Priority** to set the priority of alarms sent to the nurse call system.
6. Select **Alarm Type** to set the type of alarms sent to the nurse call system.

33.3.6.2 Disabling the Receiving Call Help Function

If a monitor in the same department calls for help, you can receive the calling signal. This function is enabled by default. To disable this function, follow this procedure:

1. Select the **Main Menu** quick key → from the **System** column select **Maintenance** → input the required password → select .
2. Select the **Alarm** tab → **Nurse Call** tab.
3. Switch off **Receive Call Help**.

33.3.6.3 Enabling Presenting the Nurse Call from the Telemetry

If the telemetry is connected, the monitor can pop up the nurse call dialog if nurse call is initiated from the telemetry. To enable this function, follow this procedure:

1. Select the **Main Menu** quick key → from the **System** column select **Maintenance** → input the required password → select .
2. Select the **Alarm** tab → **Nurse Call** tab.
3. Switch on **Telemetry Nurse Call**.

33.3.7 Changing Alarm Priority Settings

33.3.7.1 Setting the Priority of the ECG Lead Off Alarm

To set the priority of the ECG lead off alarm, follow this procedure:

1. Select the **Main Menu** quick key → from the **System** column select **Maintenance** → input the required password → select .
2. Select the **Alarm** tab → select the **Other** tab.
3. Set the priority of **ECG Lead Off**.

33.3.7.2 Setting the Priority of the SpO₂ Sensor Off Alarm

To set the priority of the SpO₂ sensor off alarm, follow this procedure:

1. Select the **Main Menu** quick key → from the **System** column select **Maintenance** → input the required password → select .
2. Select the **Alarm** tab → select the **Other** tab.
3. Set the priority of **SpO₂ Sensor Off**.

33.3.7.3 Setting the Priority of the IBP No Sensor Alarm

To set the priority of the IBP no sensor alarm, follow this procedure:

1. Select the **Main Menu** quick key → from the **System** column select **Maintenance** → input the required password → select .
2. Select the **Alarm** tab → select the **Other** tab.
3. Set the priority of **IBP No Sensor**.

33.3.7.4 Setting the Switch of the CMS and eGateway Disconnection Alarm

You can choose whether to issue an alarm when the monitor is not connected or disconnected from the CMS/eGateway. To do so, follow this procedure:

1. Select the **Main Menu** quick key → from the **System** column select **Maintenance** → input the required password → select .
2. Select the **Alarm** tab → **Other** tab.
3. In the Other block, switch on or off **CMS/eGW Disconnected Alarm**. If **CMS/eGW Disconnected Alarm** is switched off, the "Offline" alarm is not presented when the monitor is not connected or disconnected from the CMS/eGateway.

33.3.7.5 Setting the Priority of the CMS and eGateway Disconnection Alarm

To set the priority of the CMS and eGateway disconnection alarm, follow this procedure:

1. Select the **Main Menu** quick key → from the **System** column select **Maintenance** → input the required password → select .
2. Select the **Alarm** tab → **Other** tab.

3. Set **CMS/eGW Disconnected**.

33.3.7.6 Setting the Switch of the SpO₂ Desat Alarm Off

You can choose whether switching off the SpO₂ Desat alarm is permissible or not. To do so, follow this procedure:

1. Select the **Main Menu** quick key → from the **System** column select **Maintenance** → input the required password → select .
2. Select the **Alarm** tab → select the **Other** tab.
3. Set **SpO₂ Desat Alarm Off**.
 - ◆ **Disable:** the SpO₂ Desat alarm is always on. You cannot switch it off.
 - ◆ **Enable:** you can switch off the SpO₂ Desat alarm. For more information, see *12.6.1 Changing the SpO₂ Alarm Settings*.

WARNING

- **If a clinician switches off the SpO₂ Desat alarm, the monitor will not alarm when the patient's SpO₂ is extremely low. This may result in a hazard to the patient.**
-

33.3.7.7 Setting the Switch of the Apnea Alarm Off

You can choose whether switching off the apnea alarm is permissible or not. To do so, follow this procedure:

1. Select the **Main Menu** quick key → from the **System** column select **Maintenance** → input the required password → select .
2. Select the **Alarm** tab → select the **Other** tab.
3. Set **Apnea Alarm Off**.
 - ◆ **Disable:** the apnea alarm is always on. The clinician cannot switch it off.
 - ◆ **Enable:** the clinician can switch off the apnea alarm. For more information, see *11.5.1 Setting the Resp Alarm Properties*.

WARNING

- **If a clinician switches off the apnea alarm, the monitor will not issue the apnea alarm when that situation occurs. This may result in a hazard to the patient. Keep the patient under close surveillance.**
-

33.3.8 Changing Alarm Delay Settings

33.3.8.1 Setting the Alarm Delay Time

For continuously measured parameters, you can set the alarm delay time. If the alarm condition is resolved within the delay time, the monitor does not present the alarm.

To set the alarm delay time, follow this procedure:

1. Select the **Main Menu** quick key → from the **System** column select **Maintenance** → input the required password → select .
2. Select the **Alarm** tab → **Other** tab.
3. Set **Alarm Delay**.
 - ◆ **Off:** an alarm is presented as soon as the alarm condition occurs.
 - ◆ **1 sec ~ 8sec:** for continuously measured parameters, an alarm is not presented if the alarm condition is resolved within the designated delay time.

The setting of **Alarm Delay** is not applied to the apnea alarms and the ST alarms. You can set **Apnea Delay** and **ST Alarm Delay** separately.

WARNING

- **The alarm delay time can be set to a maximum of 8 seconds. Changing this setting to an inappropriate level could result in a hazard to the patient.**
-
-

33.3.8.2 Setting the ST Alarm Delay Time

1. Select the **Main Menu** quick key → from the **System** column select **Maintenance** → input the required password → select .
2. Select the **Alarm** tab → **Other** tab.
3. Set **ST Alarm Delay**.

33.3.9 Adjusting the Alarm Light Brightness

To adjust the alarm light brightness, follow this procedure:

1. Select the **Main Menu** quick key → from the **System** column select **Maintenance** → input the required password → select .
2. Select the **Alarm** tab → **Other** tab.
3. From the **Alarm Light Brightness** area, set **Primary Screen** (note that you may have to scroll up the dialog to see this option). If you set alarm light brightness to **Auto**, the monitor automatically adjusts the alarm light brightness according to the ambient light. The stronger the ambient light is, the brighter the alarm light is.

For N22/N19, if you are using a secondary display, set the **Secondary Screen** too.

33.3.10 Changing Other Alarm Settings

33.3.10.1 Setting the Lethal Arrhythmia Alarms Switch

To allow a clinician to disable the lethal arrhythmia alarms, follow this procedure:

1. Select the **Main Menu** quick key → from the **System** column select **Maintenance** → input the required password → select .
2. Select the **Alarm** tab → select the **Other** tab.
3. From the **Other** block, set **Lethal Arrh Alarms Off** as follows.
 - ◆ **Lethal Arrh Alarms Off** is set to **Disable** by default. In this case, a clinician cannot switch off lethal arrhythmia alarms.
 - ◆ If you set **Lethal Arrh Alarms Off** to **enable**, a clinician can switch off lethal arrhythmia alarms from the **ECG** dialog. For more information, see 9.6.4.1 *Changing Arrhythmia Alarm Settings*.

WARNING

- **If any of lethal arrhythmia alarms are switched off, the ECG waveform area displays a message to indicate that corresponding alarms are off.**
 - **If a clinician switches off all arrhythmia alarms, the monitor will not present arrhythmia alarms. Always keep the patient under close surveillance.**
-
-

33.3.10.2 Setting the Intubation Time

The default intubation time is 2 minutes. To change the intubation time, following this procedure:

1. Select the **Main Menu** quick key → from the **System** column select **Maintenance** → input the required password → select .
2. Select the **Alarm** tab → **Other** tab.
3. Set the **Intubation Mode Period**.

33.3.10.3 Enabling Automatic Recordings on an Alarm

Print on Alarm is set to **Printer** by default. To enable automatic recording via recorder when a parameter alarm is triggered, set **Print on Alarm** to **Recorder**. To do so, follow this procedure:

1. Select the **Main Menu** quick key → from the **System column** select **Maintenance** → input the required password → select .
2. Select the **Alarm** tab → select **Other**.
3. Set **Print on Alarm** to **Recorder**.

33.3.10.4 Setting Arrhythmia Alarm Timeout Period

The arrhythmia algorithm can disable alarm light and alarm tone for designated period of time when certain arrhythmia alarms are detected.

To set the arrhythmia alarm timeout period, follow this procedure:

1. Select the **Main Menu** quick key → from the **System** column select **Maintenance** → input the required password → select .
2. Select the **Alarm** tab → select the **Other** tab.
3. From the **Other** block, set **Arrhy Shield Time**.

NOTE

- **For the following alarms, alarm light and alarm tone cannot be disabled: HR high, HR low, Tachycardia, Bradycardia, Afib End, Irr Rhythm End.**
 - **The arrhythmia alarm timeout period is only applied to the medium priority chains and atrial fibrillation chain. For the alarms in the high priority chain, alarm tone and alarm light are presented as soon as the alarm condition is detected. Refer to 9.6.5.1 Arrhythmia Alarm Chains for more information on the arrhythmia alarm chain.**
 - **Alarm indication rules for alarms in the atrial fibrillation chain are the same with those for the medium priority chains.**
-

33.4 Changing CAA Settings

33.4.1 Enabling Inputting the Clinician ID

To display the clinician ID on the EWS screen, follow this procedure:

1. Select the **Main Menu** quick key → from the **System** column select **Maintenance** → input the required password → select .
2. Select the **CAA** tab → select the **EWS** tab.
3. Switch on **Clinician ID**.
4. Select **Clinician ID Timeout** to set how long the clinician ID will remain valid.

NOTE

- **The EWS tab is only available if a license for EWS is installed in the monitor.**
-

33.4.2 Selecting the Default Scoring Tool

To set the default scoring tool for different patient category, follow this procedure:

1. Select the **Main Menu** quick key → from the **System** column select **Maintenance** → input the required password → select .
2. Select the **CAA** tab → select **EWS** tab.
3. From the **Select Default Score** area, set **Default Adult Score**, **Default Ped Score**, and **Default Neo Score**.

33.4.3 Managing the Scoring Tools

To manage the scoring tool, follow this procedure:

1. Select the **Main Menu** quick key → from the **System** column select **Maintenance** → input the required password → select .
2. Select the **CAA** tab → select **EWS** tab.
3. Select the **Manage Score** button.
 - ◆ Delete local scoring tools: from the **Local** page, delete any unnecessary scoring tools.
 - ◆ Import the desired scoring tools to the monitor: from the USB drive page, select the scoring tools on the USB drive, and then select **Import**.

NOTE

- **The monitor provides MEWS and NEWS by default. You cannot delete them.**

33.4.4 Setting GCS Threshold for Each Consciousness Level

You can configure the threshold and color of each consciousness level. To do so, follow this procedure:

1. Select the **Main Menu** quick key → from the **System** column select **Maintenance** → input the required password → select .
2. Select the **CAA** tab → select the **GCS** tab.
3. Set high limit, low limit for each level.

33.5 Changing Module Settings

33.5.1 Selecting the ECG Standard

Select the ECG standard according to the leadwires you are using. To select the ECG standard, follow this procedure:

1. Select the **Main Menu** quick key → from the **System** column select **Maintenance** → input the required password → select .
2. Select the **Module** tab → **ECG** tab.
3. Set **ECG Standard** to **AHA** or **IEC**.

33.5.2 Changing the QTc Formula

The monitor uses the Hodges correction formula by default to correct the QT interval for heart rate. To select the QTc formula, follow this procedure:

1. Select the **Main Menu** quick key → from the **System** column select **Maintenance** → input the required password → select .
2. Select the **Module** tab → **ECG** tab.
3. Set **QTc Formula**.

- ◆ Hodges: $QTc = QT + 1.75 \times (HeartRate - 60)$

- ◆ Bazett: $QTc = QT \times \left(\frac{HeartRate}{60} \right)^{\frac{1}{2}}$

- ◆ Fridericia: $QTc = QT \times \left(\frac{HeartRate}{60} \right)^{\frac{1}{3}}$

◆ Framingham: $QTc = QT + 154 \times \left(1 - \frac{60}{HeartRate}\right)$

33.5.3 Setting the 12-Lead Order Switch

To set whether to send the order number of 12-lead interpretation report to the hospital information system while saving the report, follow this procedure:

1. Select the **Main Menu** quick key → from the **System** column select **Maintenance** → input the required password → select .
2. Select the **Module** tab.
3. Select the **ECG** tab.
4. Set **12-Lead Order**.

33.5.4 Calibrating ECG

The ECG signal may be inaccurate due to hardware or software problems. As a result, the ECG waveform amplitude becomes greater or smaller. In that case, you need to calibrate the ECG module. To do so, follow this procedure:

1. Select the **Main Menu** quick key → from the **System** column select **Maintenance** → input the required password → select .
2. Select the **Module** tab → **ECG** tab.
3. From the bottom left corner of the dialog select **Calibrate**.

33.5.5 Manually Zeroing the CO₂ Module

To zero the CO₂ module, follow this procedure:

1. Select the **Main Menu** quick key → from the **System** column select **Maintenance** → input the required password → select .
2. Select the **Module** tab → **CO2** tab.
3. From the bottom left corner of the dialog select **Zero**.

33.5.6 Hiding the Invalid Display after Zeroing the CO₂ Module

After the zero calibration is completed, the CO₂ module reacquires the CO₂ readings. During the reacquisition period, "**Zero Recovering**" is displayed in the CO₂ numeric area. Valid data will reappear 30 seconds after the zero calibration is started.

To hide the display of the "**Zero Recovering**" message, follow this procedure:

1. Select the **Main Menu** quick key → from the **System** column select **Maintenance** → input the required password → select .
2. Select the **Module** tab → **CO2** tab.
3. Switch off **Zero Recovery for 30s**.

Selecting **Defaults** from the bottom of the dialog can restore this setting to the factory default.

33.5.7 Manually Zeroing the AG Module

To zero the AG module, follow this procedure:

1. Select the **Main Menu** quick key → from the **System** column select **Maintenance** → input the required password → select .
2. Select the **Module** tab → **AG** tab.
3. From the bottom left corner of the dialog select **Zero**.

33.5.8 Hiding the Invalid Display after Zeroing the AG Module

After the zero calibration is completed, the AG module reacquires the AG readings. During the reacquisition period, “Zero Recovering” is displayed in the AG numeric area. Valid data will reappear 30 seconds after the zero calibration is started.

To hide the display of the “Zero Recovering” message, follow this procedure:

1. Select the **Main Menu** quick key → from the **System** column select **Maintenance** → input the required password → select .
2. Select the **Module** tab → **AG** tab.
3. Switch off **Zero Recovery for 30s**.

Selecting **Defaults** from the bottom of the dialog can restore this setting to the factory default.

33.5.9 Selecting the Gas Type for Measurement

You can select what gases detected by the monitor are used for measurements. To do so, follow this procedure:

1. Ensure that the AG module is inserted in the monitor.
2. Select the **Main Menu** quick key → from the **System** column select **Maintenance** → input the required password → select .
3. Select the **Module** tab → **AG** tab.
4. Set **Types of Gas Measurement**. Any gas that is not selected, will not be displayed or used for calculating the MAC value. When the concentration of any unselected gas is equal to or greater than 1%, you will be prompted to select the gas and enable the measurement (**Set XX measurement to On**).

Selecting **Defaults** from the bottom of the dialog can restore this setting to the factory default.

33.5.10 Setting Parameter Measurement Timeout

NIBP measurements become outline fonts after a preset time. This feature prevents older values being misinterpreted as current measurements. To adjust the timeout period for PAWP, C.O., and NIBP, follow this procedure:

1. Select the **Main Menu** quick key → from the **System** column select **Maintenance** → input the required password → select .
2. Select the **Module** tab → select the **Other** tab.
3. Set the timeout period for PAWP, C.O., and NIBP.

33.5.11 Setting Flow Rate (For Sidestream CO₂ Module Without O₂)

When you are using the sidestream CO₂ module without the O₂ monitoring function to monitor a neonatal patient, you can select flow rate. To do so, follow this procedure:

1. Ensure that the sidestream module without O₂ is inserted in the monitor.
2. Select the **Main Menu** quick key → from the **System** column select **Maintenance** → input the required password → select .
3. Select the **Module** tab → **Other** tab.
4. Set **CO2 Flow Rate For Neo**.

33.6 Hiding Undesired Review Tabs





If you do not need to review some items, you can hide them. To do so, follow this procedure:

1. Select the **Main Menu** quick key → from the **System** column select **Maintenance** → input the required password → select .
2. Select the **Review** tab.
3. From the **Tags** page, **Event** page or **Arrh Mark** page deselect those that do not need to be available to clinicians during review.

33.7 Setting the Printer

33.7.1 Setting the Printer Properties

To set a network printer, follow this procedure:

1. Select the **Main Menu** quick key → from the **System column** select **Maintenance** → input the required password → select .
2. Select the **Print** tab.
3. In the **Printer** tab, select **Connection Type** to choose whether you want to output patient reports via the print server or a network printer.
4. If you set **Connection Type** to **Print Server**, perform the following settings:
 - ◆ **Print Server Address**: select  to input the print server name or IP address.
 - ◆ **Port**: selects  to input the print server port. If the CMS is used as the print server, set **Port** to **6603**.
 - ◆ Set the report type in the **Report Type** area. For more information, see section 33.7.2 *Setting the Report Type*.
5. If you set **Connection Type** to **Printer**, perform the following settings:
 - ◆ Select **Printer IP Address**. Select  to input the IP address of the desired network printer.
 - ◆ Select **Paper Size**.
 - ◆ Select **Resolution**.

After finishing configurations, you can select the **Print Test Page** button to verify that the printer works properly.

33.7.2 Setting the Report Type

If the **Connection Type** is set to **Print Server**, you need to set the report type:

1. Select the **Main Menu** quick key → from the **System column** select **Maintenance** → input the required password → select .
2. Select the **Print** tab.
3. Set **Connection Type** to **Print Server**.
4. Select the report you intend to set, for example, **General Report**.
5. Set the **Print Action**:
 - ◆ **Paper**: outputs paper report.
 - ◆ **PDF**: outputs the electronic report in PDF format.
 - ◆ **Paper And PDF**: outputs both the paper report and the PDF report.
6. For paper report, respectively select **Printer** and **Printer Resolution** to set the default printer and the resolution for the default printer.
7. For PDF report, select the **PDF Resolution** to set the resolution.

NOTE

-
- **General reports refer to the reports other than the end case report and realtime alarm report.**
-

33.7.3 Setting the Report Layout

To set the patient information you want to display on general reports, follow this procedure:

1. Select the **Main Menu** quick key → from the **System column** select **Maintenance** → input the required password → select .
2. Select the **Print** tab.
3. Select the **Report Layout** tab.
4. Select the desired items under **Report Name**. **N/A** indicates that this item is not displayed on a report.

33.7.4 Setting Patient Information on 12-lead ECG Reports

To set the patient information you want to display on 12-lead ECG reports, follow this procedure:

1. Select the **Main Menu** quick key → from the **System** column select **Maintenance** → input the required password → select .
2. Select the **Print** tab.
3. select the **ECG Report** tab.
4. On the right of the **ECG Report** page, select the desired patient information items. Patient ID, Patient Name, Age, and Gender are displayed on an ECG report by default.

NOTE

-
- **You can only set the patient information to display on the ECG report from the ECG Report page. Patient information configured in the Report Layout page is not applied to ECG reports.**
-

33.7.5 Configuring the Name of PDF Files

If you use the print server to output patient reports, you can use the PDF printer to output PDF format reports. To configure the name of PDF files, follow this procedure:

1. Select the **Main Menu** quick key → from the **System** column select **Maintenance** → input the required password → select .
2. Select the **Print** tab → **PDF File Name** tab.
3. Select the desired items and their sequence under **PDF File Name**. **N/A** refers to no information.

33.7.6 Showing the Second Mark

To set whether you want to show second marks on the report output by the printer, follow this procedure.

1. Select the **Main Menu** quick key → from the **System** column select **Maintenance** → input the required password → select .
2. Select the **Print** tab → **Other** tab.
3. Enable or disable **Second Mark (Printer)**.

33.7.7 Setting the Arrhythmia Information to Output by the Recorder

To set whether you want to include arrhythmia thresholds and QRS thresholds in the report output by the recorder, follow this procedure.

1. Select the **Main Menu** quick key → from the **System** column select **Maintenance** → input the required password → select .
2. Select the **Print** tab → **Other** tab.
3. Enable or disable **Arrhy Settings (Recorder)**.

33.7.8 Setting Parameter Unit

To set parameter unit, follow this procedure:

1. Select the **Main Menu** quick key → from the **System** column select **Maintenance** → input the required password → select .
2. Set the **Unit** tab.
3. Set unit for each parameter.

33.8 Setting the Time

33.8.1 Setting the Time Synchronization

If the NTP Time Synchronization function is enabled, the monitor can automatically synchronize its time with a time server on which NTP (Network Time Protocol) is implemented. If there are many monitors connected within one network, you can enable the time synchronization to synchronize the time, and make it unnecessary to manually set the time for individual monitors.

33.8.1.1 Enabling NTP Time Synchronization

To enable the NTP Time Synchronization function, follow this procedure:

1. Select the **Main Menu** quick key → from the **System** column select **Maintenance** → input the required password → select .
2. Select the **Time** tab → **Time Synchronization** tab.
3. Switch on **Start NTP Time Sync**.

33.8.1.2 Setting the Time Server Address

To set the DNS name of the time server address, follow this procedure:

1. Select the **Main Menu** quick key → from the **System** column select **Maintenance** → input the required password → select .
2. Select the **Time** tab → **Time Synchronization** tab.
3. Input the name or IP address of the time server.

After configuring the NTP time server, select **Network Test** to verify that the NTP server is properly connected.

33.8.1.3 Setting the Time Synchronization Interval

To set the time synchronization interval, follow this procedure:

1. Select the **Main Menu** quick key → from the **System** column select **Maintenance** → input the required password → select .
2. Select the **Time** tab → **Time Synchronization** tab.
3. Set **Interval**.

33.8.1.4 Defining the Hours of Nighttime

To define the nighttime, follow this procedure:

1. Select the **Main Menu** quick key → from the **System** column select **Maintenance** → input the required password → select .
2. Select the **Time** tab → **Time Synchronization** tab.
3. Select **From** and **To** to define the beginning and end of Nighttime.

33.8.2 Enabling Auto Daylight Savings Time

By default, daylight savings time is disabled. If this function is needed, you need to manually enable the daylight savings time. To auto start the daylight savings time, follow this procedure:

1. Select the **Main Menu** quick key → from the **System** column select **Maintenance** → input the required password → select .
2. Select the **Time** tab → **Daylight Savings Time** tab..
3. Switch on **Auto Daylight Savings Time**.
4. Adjust daylight savings time settings as necessary.

NOTE

- **If you enable Auto Daylight Savings Time you cannot manually switch it on or off from the System Time dialog. For more information, see 3.8.2 Setting the Date and Time.**
-

33.9 Viewing Version Information

To view the system software version, module hardware and software version, and firmware version, follow this procedure:

1. Select the **Main Menu** quick key → from the **System** column select **Maintenance** → input the required password → select .
2. Select the **Version** tab.

You can also view the system software version by selecting the **Main Menu** quick key → from the **System** column select **Version**.

33.10 Checking Battery Information

To check the battery information, follow this procedure:

1. Select the **Main Menu** quick key → from the **System** column select **Maintenance** → input the required password → select .
2. Select the **Battery Information** tab.

33.11 Changing Secondary Display Settings (for N22/N19)

You can separately set the orientation, brightness, alarm indications, and the display contents of the secondary display.

NOTE

- **If you change the Maintenance dialog settings for the secondary display, you need to restart the monitor for the changes to take effect.**
 - **If you plug in a secondary display when the monitor is on, you need to restart the monitor before you use the secondary display.**
-

33.11.1 Configuring Secondary Display Screen Contents (for N22/N19/N17)

The contents of the secondary display is configurable. To do so, follow this procedure:

1. Select the **Main Menu** quick key → from the **System** column select **Maintenance** → input the required password → select .
2. Select the **Display** tab.
3. Set **Screen Contents**.
 - ◆ **Mirrored:** The contents of the secondary display is exactly the same with the primary display. The orientation of the secondary display is also the same with the primary display. It is not available for the N17 monitor.
 - ◆ **Independent:** You can separately configure the contents and layout of the primary display and secondary display. The independent secondary display cannot share the mouse and keyboard with the primary display. For N22/N19, separate mouse and keyboard connected to the MSB connectors of the secondary display is required.
 - ◆ **Extended:** You can separately configure the contents and layout of the primary display and secondary display. The extended secondary display shares the mouse and keyboard with the primary display. You cannot use separate mouse and keyboard to operate the extend secondary display.
4. If the **Screen Contents** is set to **Extended**, set **Secondary Screen Location**.

33.11.2 Enabling Secondary Display Alarm Indications (for N22/N19)

The secondary display can provide visual and audible indications. This function is disabled by default. To enable the secondary display to present alarm light and alarm sound, follow this procedure:

1. Select the **Main Menu** quick key → from the **System** column select **Maintenance** → input the required password → select .
2. Select the **Display** tab.
3. Switch on **Alarm Sound/Light**.

33.12 Changing Scanner Settings

For the 2D barcode reader, you can change the scanner settings.

33.12.1 Establish the Relationship between Patient Demographics and 2D Barcode Fields (for the Mindray Custom 2D Barcode Reader)

To configure 2D barcode reader, follow this procedure:

1. Select the **Main Menu** quick key → from the **System** column select **Maintenance** → input the required password → select .
2. Select the **Scanner** tab → **2D Barcode** tab.
3. Establish the relationship between the monitor data and hospital's barcode data for selectable patient demographics. For example, the monitor has an option of **Ped** for patient category. In your hospital barcode, the text may read as **Pediatric**. So input **Pediatric** for the field **Ped** to establish their relationship.

33.12.2 Setting the Barcode Reader Information

To set the barcode reader information, follow this procedure:

1. Select the **Main Menu** quick key → from the **System** column select **Maintenance** → input the required password → select .
2. Select the **Scanner** tab → **Scanner Info.** tab.
3. Set **Scanner Type**:
 - ◆ **1D Scanner**: select this option when using a 1D scanner or a 2D scanner other than the Mindray custom 2D scanner.
 - ◆ **2D Scanner**: select this option when using the Mindray custom scanner.

NOTE

- **When you set Scanner Type to 2D Scanner, default settings are applied to Data Encoding Type and Data Parse Mode. You do not need to change these setting.**
-

33.12.3 Identifying the Barcode Reader (for the non-Mindray Custom 2D Barcode Reader)

When you are using barcode readers other than the JADAK Flexpoint HS-1R or HS-1M, you should select the barcode reader from the USB device list, so that the monitor can identify the barcode reader. To do so, follow this procedure:

1. Select the **Main Menu** quick key → from the **System** column select **Maintenance** → input the required password → select .
2. Select the **Scanner** tab → **Identify Scanner** tab.
3. From the USB device list, select the barcode reader you are using.

33.12.4 Selecting Patient Information Read by the Barcode Reader (for the Mindray Custom 2D Barcode Reader)

To select desired patient information that will be read by the barcode reader, follow this procedure:

1. Select the **Main Menu** quick key → from the **System** column select **Maintenance** → input the required password → select .
2. Select the **Scanner** tab → **Field** tab.
3. Select the patient information. The selected information can be read by the barcode reader.

NOTE

- **The patient information read by the barcode reader is dependent on the patient information encoded in the hospital's barcodes.**

33.13 Configuring the Network

You can connect the monitor to the central monitoring system (CMS), eGateway, and other monitors through wired LAN or wireless LAN.

33.13.1 Network Safety Information

CAUTION

- **Wireless network designing, deploying, debugging, and maintenance should be executed by Mindray service personnel or authorized technicians.**
- **Always set the wireless network according to local wireless regulations.**
- **Keep network authentication information, for example passwords, safe, to protect the network from being accessed by unauthorized users.**
- **Do not connect non-medical devices to the monitor network.**
- **If wireless network signal is poor, there may be a risk of CMS-destined data loss.**
- **RF interference may result in wireless network disconnection.**
- **Disconnecting from the network may result in CMS-destined data loss and function failure. Check the patient in case of network disconnection and solve the network problem as soon as possible.**
- **Ensure that the monitor IP address setting is correct. Changing the network settings may result in network disconnection. Contact your service personnel if there are any problems with the IP address.**

33.13.2 Selecting a Network Type

To select network type, follow this procedure:

1. Select the **Main Menu** quick key → from the **System** column select **Maintenance** → input the required password → select .
2. Select the **Network Type** tab.
3. Set **Monitor** to **Auto**, **LAN1 IP**, or **WLAN** according to your network type. The default is **Auto**, which means the monitor will automatically use LAN1 IP when detected and the available WLAN when LAN1 IP is not detected..

33.13.3 Setting the Wired Network

To set the wired network, follow this procedure:

1. Select the **Main Menu** quick key → from the **System** column select **Maintenance** → input the required password → select .
2. Select the **Network Setup** tab → **LAN1 IP** tab.
3. Select how to get the IP address.
 - ◆ **Obtain IP Address Automatically:** the monitor automatically gets the IP address.



- ◆ **Use the following Address:** you need to input the **IP address**, **Subnet mask**, and **Gateway**.
4. Select how to get the DNS address:
 - ◆ **Obtain DNS Address Automatically:** the monitor automatically gets the DNS address.
 - ◆ **Use the following DNS Address:** you need to input the IP address of **Preferred DNS server** and **Alternate DNS server**.

33.13.4 Setting the Wireless Network

To add and set the wireless network, follow this procedure:

1. Select the **Main Menu** quick key → from the **System** column select **Maintenance** → input the required password → select .
2. Select the **Network Setup** tab → **WLAN** tab.
3. Select **Add WLAN**. In the popup dialog, input network name, SSID, and password. Set **Security**.
4. Select the **WLAN IP** tab and select how to get the IP address and DNS address.
 - ◆ **Obtain IP Address Automatically:** the monitor automatically gets the IP address.
 - ◆ **Use the Following Address:** you need to input the **IP address**, **Subnet Mask**, and **Gateway**.
 - ◆ **Obtain DNS Address Automatically:** the monitor automatically gets the DNS address.
 - ◆ **Use the following DNS Address:** you need to input the IP address of **Preferred DNS server** and **Alternate DNS server**.
5. Select the **WLAN Setup** tab and set WLAN band and channels. The default is **Auto**, which means the monitor can automatically identify the WLAN band.

After configuring the wireless network, select **Network Test** to verify that the wireless network can be properly connected.

If you need to change network settings, select  beside the desired wireless network. Selecting  deletes the wireless network.

33.13.5 Managing Certifications

You can delete certifications from the monitor, or import certifications from the USB memory device. To do so, follow this procedure:

1. Select the **Main Menu** quick key → from the **System** column select **Maintenance** → input the required password → select .
2. Select the **Network Setup** tab → **WLAN** tab.
3. Select the **Certificate Management** button from the bottom left corner of the dialog.
 - ◆ From the **Local** tab, select certifications you want to delete from the monitor, and then select **Delete**.
 - ◆ From the **USB Drive** tab, select certifications you want to import from the USB memory device, and then select **Import**.

33.13.6 Enabling Selecting a CMS

To enable selecting a CMS, follow this procedure:

1. Select the **Main Menu** quick key → from the **System** column select **Maintenance** → input the required password → select .
2. Select the **Network Setup** tab → **Central Station Setup** tab.
3. Switch on **Select CMS**.

33.13.7 Adding CMSs

You can add up to 30 central monitoring systems (CMS) for your monitor. To add CMSs, follow this procedure:

1. Select the **Main Menu** quick key → from the **System** column select **Maintenance** → input the required password → select .
2. Select the **Network Setup** tab → **Central Station Setup** tab.

3. Select **Add Central Station**, and then input the CMS name and IP address of this department.

33.13.8 Setting Multicast Parameters

Multicast helps device discovery between monitors and other devices on the network. Devices in the same multicast group can be mutually discovered.

To set multicast parameters, follow this procedure:

1. Select the **Main Menu** quick key → from the **System** column select **Maintenance** → input the required password → select .
2. Select the **Network Setup** tab → **Device Discover** tab.
3. Set **Multicast TTL**.
4. Set **Multicast Address**.

33.13.9 Setting the Master Server Address

To set the DNS name of the master server, follow this procedure:

1. Select the **Main Menu** quick key → from the **System** column select **Maintenance** → input the required password → select .
2. Select the **Network Setup** tab → **Device Discover** tab.
3. Select **Master Server Address** to input the DNS name or IP address of the master server.

33.13.10 Setting the Network Service Quality Level

To set the quality of service (QoS), follow this procedure:

1. Select the **Main Menu** quick key → from the **System** column select **Maintenance** → input the required password → select .
2. Select the **Network Setup** tab → **QoS** tab.
3. Select **QoS Level For Realtime Monitoring** to set the service quality of network connection for realtime monitoring, for example parameter measurements and waveforms, alarms, etc.
4. Select **QoS Level For Others** to set the service quality of network connection for non-realtime monitoring, for example history data, printing, etc.

33.13.11 Using the ADT Gateway

The ADT (admit-discharge-transfer) gateway is normally deployed in the eGateway. You can obtain patient information from the hospital ADT server through the ADT gateway.

To configure the ADT gateway, follow this procedure:

1. Select the **Main Menu** quick key → from the **System** column select **Maintenance** → input the required password → select .
2. Select the **Network Setup** tab → **ADT** tab.
3. Select **Server Address** to input the host name or IP address of the ADT gateway.
4. Select **Port** to input the port of the ADT gateway.

ADT Query is switched off by default. You can load patient information to the monitor from the ADT server only when this function is enabled.

After configuring the ADT gateway, select **Network Test** to verify that the ADT server is properly connected.

33.13.12 Sending Realtime Data, Waveforms and Alarms via HL7 Protocol

You can send the realtime data, waveforms, and alarms from the monitor to the hospital servers via HL7 protocol. To do so, follow this procedure:

1. Select the **Main Menu** quick key → from the **System** column select **Maintenance** → input the required password → select .
2. Select the **Network Setup** tab → **HL7 Configuration** tab.

3. From the **Data + Waveforms** area, select **Server Address** to input the name or IP address for the server receiving the realtime data and waveform. Set **Port**.
4. Switch on **Send Data** and **Send Waveform**, as needed. Set **Data Interval**.
5. From the **Alarms** area, select **Server Address** to input the name or IP address for the server receiving the alarm data. Set **Port**.
6. Switch on **Send Alarms** as needed.

This page also displays the server connection status.

33.13.13 Selecting Data Encryption Type

To set data encryption type, follow this procedure:

1. Select the **Main Menu** quick key → from the **System** column select **Maintenance** → input the required password → select .
2. Select the **Network Setup** tab → **Information Security** tab.
3. Select **Encryption Connection Type** to set data encryption type when connecting devices:
 - ◆ **Only Private Encryption:** Mindray private encryption is used to encrypt the transmitted data. You cannot connect devices supporting SSL (secure sockets layer) encryption.
 - ◆ **SSL Encryption Priority:** for devices supporting SSL encryption, SSL encryption is used when connecting the devices. For devices not supporting SSL encryption, private encryption is used when connecting the devices.

33.13.14 Disabling the Broadcasting Patient Demographics Function

When viewing other patients, device location and patient information of remote devices are displayed in the remote device list by default. To protect patient privacy, you can disable the broadcasting of patient demographics function to prevent the monitor from sending patient information via broadcast. To do so, follow this procedure:

1. Select the **Main Menu** quick key → from the **System** column select **Maintenance** → input the required password → select .
2. Select **Network Setup** tab → **Information Security** tab.
3. Switch off **Broadcast Patient Demographics**.

Thus, patient information will not display in the remote device list.

33.14 MLDAP

MLDAP refers to Mindray LDAP (Lightweight Directory Access Protocol). It is an independent process which can be installed on the eGateway or other application server (Windows). MLDAP provides user identity and authentication.

The MLDAP server is connected with the hospital LDAP server. All monitoring devices are connected to the MLDAP server to implement identity and authentication for the following operations:

- Changing alarm settings
- Changing arrhythmia settings
- Accessing the **Maintenance** dialog

33.14.1 Setting MLDAP

To access the MLDAP server, you should set your monitor as follows:

1. Select the **Main Menu** quick key → from the **System** column select **Maintenance** → input the required password → select .
2. Select the **Network Setup** tab → **MLDAP** tab.
3. Set Server address and port of the MLDAP server.

33.14.2 Testing MLDAP Server Connection

To test whether the monitor is properly connected with the MLDAP server, follow this procedure:

1. Select the **Main Menu** quick key → from the **System** column select **Maintenance** → input the required password → select .
2. Select the **Network Setup** tab → **MLDAP** tab.
3. Select **Network Test**.

33.14.3 Selecting Password for User Authentication

You can select what password is used when changing alarm settings, arrhythmia settings, and accessing the **Maintenance** dialog. To do so, follow this procedure:

1. Select the **Main Menu** quick key → from the **System** column select **Maintenance** → input the required password → select .
2. Select the **Authorization Setup** tab.
3. From the **Maintenance** area, set **User Maintenance** to select the password for accessing the monitor's **Maintenance** dialog.
 - ◆ **Local Password:** the monitor's password for accessing the **Maintenance** dialog is required.
 - ◆ **User Password:** the user name and password saved in the MLDAP server are required.
4. From the **Others** area, set **Alarm Setup:** select the password for changing alarm settings.
 - ◆ **No Password:** changing alarm settings is not password protected.
 - ◆ **Local Password:** changing alarm switch, alarm limit, and alarm priority is password protected. The monitor's password for changing alarm settings is required.
 - ◆ **User Password:** changing alarm switch, alarm limit, and alarm priority is password protected. The user name and password saved in the MLDAP server are required.
5. Set **Arrhythmia:** select the password for changing arrhythmia settings.
 - ◆ **No Password:** changing arrhythmia settings is not password protected.
 - ◆ **Local Password:** changing arrhythmia switch, alarm priority, and arrhythmia threshold is password protected. The monitor's password for changing arrhythmia settings is required.
 - ◆ **User Password:** changing arrhythmia switch, alarm priority, and arrhythmia threshold is password protected. The user name and password saved in the MLDAP server are required.

From the **Maintenance** area, selecting **Modify Local Password** can change the monitor's password for accessing the **Maintenance** dialog.

From the **Others** area, selecting **Modify Local Password** can change the monitor's password for accessing alarm settings and arrhythmia settings.

33.14.4 Setting the Password Timeout Period

If you use the password saved in the MLDAP server to access the **Maintenance** dialog, alarm settings and arrhythmia settings, you can set the password timeout period. Once the timeout period is reached, you will need to re-enter the password. To do so, follow this procedure:

1. Select the **Main Menu** quick key → from the **System** column select **Maintenance** → input the required password → select .
2. Select the **Authorization Setup** tab.
3. Set **Retention Time**.

33.15 Defining Other Functions

33.15.1 Setting Notch Filter Frequency

Set notch filter frequency according to the power line frequency of your country. To set notch filter frequency, follow this procedure:

1. Select the **Main Menu** quick key → from the **System** column select **Maintenance** → input the required password → select .
2. Select the **Other** tab.
3. Set **Notch Frequency** to **50 Hz** or **60 Hz** according to the power line frequency.

33.15.2 Setting Mouse Sensitivity

The mouse sensitivity is adjustable. To do so, follow this procedure:

1. Select the **Main Menu** quick key → from the **System** column select **Maintenance** → input the required password → select .
2. Select the **Other** tab.
3. Set **Mouse Sensitivity**.

33.15.3 Setting the SpO₂ Tone Mode

The monitor adjusts the QRS tone (pitch tone) according to the SpO₂ values. To set the SpO₂ tone mode, follow this procedure:

1. Select the **Main Menu** quick key → from the **System** column select **Maintenance** → input the required password → select .
2. Select the **Other** tab.
3. Set **SpO₂ Tone** to **Mode 1** or **Mode 2**. The pitch changes more rapidly in Mode 2 than in Mode 1, as saturation levels change.

The SpO₂ tone mode chart for SpO₂ between 40% to 100% is as follows:

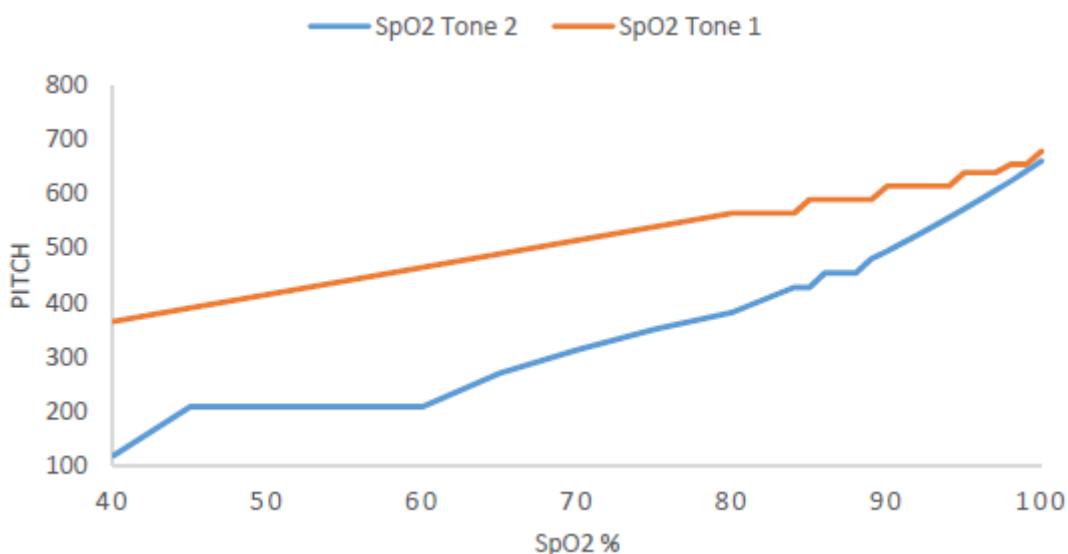

CAUTION

- It is highly recommended to use the same SpO₂ tone mode for the same monitors in a single area to prevent issues arising from inconsistent operation.
-

33.15.4 Selecting the Language

To set the user interface (UI) language, follow this procedure:

1. Select the **Main Menu** quick key → from the **System** column select **Maintenance** → input the required password → select .
2. Select the **Other** tab
3. Set **Language**.

33.15.5 Switching On or Off a Parameter

If there is no **Parameters On/Off** tab in the **Screen Setup** dialog then setting parameter switches is password protected. Follow this procedure to set parameter switches:

1. Select the **Main Menu** quick key → from the **System** column select **Maintenance** → input the required password → select .
2. Select the **Other** tab.
3. Select **Parameters On/Off**.
4. Enable or disable desired parameters.

When a parameter is switched off, the monitor stops data acquisition and alarming for this measurement.

NOTE

-
- **When a parameter is manually switched off and the corresponding parameter module is plugged in, you cannot monitor this parameter.**
-

33.15.6 Setting If Setting Parameter Switches is Protected

You can set whether setting parameter switches is password protected. To do so, follow this procedure:

1. Select the **Main Menu** quick key → from the **System** column select **Maintenance** → input the required password → select .
2. Select the **Other** tab.
3. Switch on or off **Parameters On/Off Protected**.

33.15.7 Setting If Parameter Switch is Influenced by Configuration

You can set if the settings of parameter switches are influenced by loading a configuration. To do so, follow this procedure:

1. Select the **Main Menu** quick key → from the **System** column select **Maintenance** → input the required password → select .
2. Select the **Other** tab.
3. Switch on or off **Parameters On/Off Config Influenced**.

33.15.8 Setting Whether the Monitor Stands by if MPM module is Removed

You can set whether the monitor enters the Standby mode if the MPM module, including the N1 and T1, is removed from the monitor. To do so, follow this procedure:

1. Select the **Main Menu** quick key → from the **System** column select **Maintenance** → input the required password → select .
2. Select the **Other** tab.
3. Set **Auto Standby after MPM Module Removed**. If **Off** is selected, the monitor does not enter the standby mode if the MPM module is removed.

This page intentionally left blank.

34 Battery

34.1 Battery Introduction

This monitor is designed to operate on battery power when the mains power is not available. The monitor uses mains power as primary power source. In case of mains power failure, the monitor automatically runs on the battery power.

NOTE

- If the mains power fails and the monitor runs on battery power, the display brightness automatically lowers to the value of Brightness on Battery (set in Screen Setup → Display). You can manually adjust the display brightness as required.
-

34.2 Battery Safety Information

WARNING

- Keep batteries out of the reach of children.
 - Use only Mindray specified batteries. Use of a different battery may present a risk of fire or explosion.
 - Keep the batteries in their original package until you are ready to use them.
 - Do not expose batteries to liquid.
 - Do not crush, drop or puncture the battery. Mechanical abuse can lead to internal damage and internal short circuits. If a battery has been dropped or banged against a hard surface, whether damage is externally visible or not, remove the battery from use and dispose of it properly.
 - If the battery shows signs of damage or signs of leakage, replace it immediately. Use caution in removing the battery. Avoid contacting the leakage.
 - Batteries should be charged only in this monitor.
 - Extremely high ambient temperature may cause battery overheat protection, resulting in monitor shutdown.
 - The lithium-ion battery has a service life of two years (for N22/N19) or three years (for N17/N15/N12). Replace the battery when it reaches the end of its service life. Failure to replace the battery may cause serious damage to the equipment from battery overheating.
 - Do not open batteries, heat batteries above 60 °C, incinerate batteries, or short battery terminals. They may ignite, explode, leak or heat up, causing personal injury.
-

CAUTION

- Remove the battery before shipping the monitor or when it will not be used for an extended period of time.
 - When the monitor runs on battery power, the monitor may automatically shutdown due to high power consumption if too many external modules are connected.
 - For N22/N19, the battery run time is about one hour. Connect the mains power as long as the mains power is available.
 - Use only the AC mains to power the monitor when the iView system is in use.
-

34.3 Installing or Replacing the Battery

No battery is installed when the monitor is shipped from the factory.

For N22/N19, the battery must only be installed or replaced by service personnel trained and authorized by Mindray.

For N12, to install the battery, follow this procedure:

1. Turn off the monitor. Disconnect the power cable and other cables.
2. Place the monitor on the worktable with monitor face down. Ensure that the worktable is free of dirt and debris where the monitor face will rest to reduce risk of damage to the monitor screen.
3. If the monitor is installed on a mounting arm, remove the monitor from the mounting arm and remove any mounting plates.
4. Open the battery door as indicated by Figure 1 below.
5. Turn the latch aside.
6. Insert the battery into the battery compartment with the battery terminal inwards. Turn the latch back to the middle as indicated by Figure 2 below. To replace the battery, remove the old battery and insert a new one.
7. Close the battery door.



Figure 1

Figure 2

For N17/N15, to install the battery, follow this procedure:

1. Turn off the monitor. Disconnect the power cable and other cables.
2. Place the monitor on the worktable with monitor face down.
3. If the monitor is installed on a mounting arm, remove the monitor from the mounting arm and remove any mounting plates.
4. Pull up the battery door to open the battery compartment as indicated by Figure 1 below.
5. Insert the battery into the battery compartment. Push the battery downwards till the battery terminal is plugged into the battery connector as indicated by Figure 2 below. To replace the battery, remove the old battery and insert a new one.
6. Close the battery door.



Figure 1

Figure 2

34.4 Battery Indications

The battery LED, on-screen battery power indicator, and related alarm messages indicate the battery status.





34.4.1 Battery LED

The battery LED indications are as follows:

- Green: the battery is fully charged.
- Yellow: the battery is being charged.
- Flashing green: the monitor is running on battery power.
- Off: no battery is installed, or the battery malfunctioned, or the AC mains is not connected when the monitor is powered off.

34.4.2 Battery symbols

The on-screen battery symbols indicate the battery status as follows:

-  indicates that the battery is working correctly. The green portion represents the remaining charge.
-  indicates that the battery power is low and needs to be charged.
-  indicates that the battery is almost depleted and needs to be charged immediately. Otherwise, the monitor will automatically shut down soon.
-  indicates that the battery is being charged.
-  indicates that no battery is installed or the battery has failed.

34.4.3 Battery-related Alarms

The capacity of the battery is limited. When the battery level is low, the monitor presents the **Low Battery** alarm, the alarm lamp flashes, and the monitor produces an alarm sound.

If the battery is almost depleted, the monitor presents the **Critically Low Battery** alarm. In this case, immediately connect the AC mains to power the monitor and charge the battery. Otherwise, the monitor will automatically shut down soon.

For N22/N19, if the battery is aged, the **Battery Service Required** alarm is presented each time the monitor is turned on, indicating that the battery has reached its lifetime.

For more information on battery-related alarms, see Appendix **D Alarm Messages**.

34.5 Charging the Battery

The battery is recharged automatically when the monitor is connected to AC mains power.

34.6 Maintaining the Battery

34.6.1 Conditioning the Battery

The performance of batteries deteriorates over time. For N22/N19, you should condition the batteries periodically or when you notice a degradation in performance. If the battery is not conditioned for a prolonged time, its charge indication may not be accurate and you may wrongly evaluate the remaining battery runtime.

To condition a battery, follow this procedure:

1. Disconnect the monitor from the patient and stop all monitoring and measuring procedures.
2. Turn off the monitor, and connect the monitor to the external power source.
3. Allow the battery to be charged uninterrupted until it is fully charged.
4. Disconnect the monitor from the external power source, and turn on the monitor.
5. Allow the monitor to run on the battery until the battery is completely depleted and the monitor automatically shuts down.
6. Fully charge the battery again for use or charge it to 40 - 60% for storage.

NOTE

- **Do not use the monitor to monitor a patient during battery conditioning.**

- **Do not interrupt battery conditioning. Interrupting battery conditioning to use the monitor will prevent completion of the conditioning cycle and require repeating the conditioning process completely to properly condition the battery.**
-

34.6.2 Checking Battery Performance

The performance of a rechargeable battery deteriorates over time. You should check the battery performance periodically or if you are concerned that the battery may fail.

See steps 1 to 5 of *34.6.1 Conditioning the Battery* to check battery performance. The operating time of the batteries reflects their performance directly. If the operating time of a battery is noticeably shorter than that stated in the specifications, the battery may have reached its service life or be malfunctioning. If the battery performance meets the requirement, fully charge the battery again for use or charge it to 40 - 60% for storage.

NOTE

- **Battery operating time depends on equipment configuration and operation. For example, high display brightness or measuring NIBP repeatedly will shorten the battery operating time.**
-

34.7 Storing Batteries

When storing batteries, make sure that the battery terminals do not come into contact with metallic objects. If batteries are stored for an extended period of time, place the batteries in a cool place with a partial charge of 40% to 60% capacity.

Condition the stored batteries every three months. For more information, see *34.6.1 Conditioning the Battery*.

NOTE

- **Remove the battery from the equipment if the equipment is not used for a prolonged time (for example, several weeks). Otherwise the battery may overdischarge.**
 - **Storing batteries at high temperature for an extended period of time will significantly shorten their life expectancy.**
 - **Storing batteries in a cool place can slow the aging process. Ideally the batteries should be stored at 15 °C.**
-

34.8 Recycling Batteries

Discard a battery in the following situations:

- The battery has visual signs of damage.
- The battery fails.
- The battery is aged and its runtime significantly less than the specification.
- The battery service life is reached.

Properly dispose of batteries according to local regulations.

WARNING

- **Do not open batteries, heat batteries above 60 °C, incinerate batteries, or short the battery terminals. They may ignite, explode, leak or heat up, causing personal injury.**
-

35 Care and Cleaning

35.1 Care and Cleaning Introduction

In this chapter we only describe cleaning and disinfection of the main unit, modules, satellite module rack (SMR) and certain accessories. For the cleaning and disinfection of other reusable accessories, refer to their instructions for use of the corresponding accessories.

Keep your equipment and accessories clean. To avoid damage to the equipment, follow these guidelines:

- Always follow the manufacturer's instructions for each cleaning / disinfecting agent.
- Do not immerse any part of the equipment or accessories into liquid.
- Do not pour liquid onto the equipment or accessories.
- Do not allow liquid to enter the case.
- Never use abrasive materials (such as steel wool or silver polish), or erosive cleaners (such as acetone or acetone-based cleaners).

35.2 Care and Cleaning Safety Information

WARNING

- **Be sure to turn off the system and disconnect all power cables from the outlets before cleaning the equipment.**
-

CAUTION

- **If you spill liquid on the equipment or accessories, contact Mindray or your service personnel.**
 - **Avoid wetting the pins and metal parts of the equipment, mounting kits or accessories during cleaning and disinfection.**
 - **Use only Mindray approved cleaners and disinfectants and methods listed in this chapter to clean or disinfect your equipment. Warranty does not cover damage caused by unapproved substances or methods.**
 - **We make no claims regarding the efficacy of the listed chemicals or methods as a means for controlling infection. For the method to control infection, consult your hospital's Infection Control Officer or Epidemiologist.**
 - **The responsible hospital or institution shall carry out all cleaning and disinfection procedures specified in this chapter.**
 - **Refer to the respective instructions for use of the cleaning agents and disinfectants.**
 - **Do not mix disinfecting solutions (such as bleach and ammonia) as hazardous gases may result.**
-

NOTE

- **To clean or disinfect reusable accessories, refer to the instructions delivered with the accessories.**
-

35.3 Cleaning and Disinfecting the Equipment and Mounting Kits

Use approved cleaning and disinfecting agents for cleaning or disinfecting the main unit, parameter modules, and SMR.

35.3.1 Approved Cleaning and Disinfecting Agents

The following table lists approved cleaning and disinfecting agents:

Product Name	Product Type	Active Ingredients
Sodium hypochlorite bleach	Liquid	Sodium hypochlorite bleach 0.5%
Hydrogen peroxide		Hydrogen peroxide 3%
Isopropanol		Isopropanol 70%
1-Propanol		1-Propanol 50%
Metrex CaviCide1™		Diisobutylphenoxyethoxyethyl dimethyl benzyl ammonium chloride 0.28%, Isopropanol 17.2%
Virex® II 256 (1:256)		Didecyl dimethyl ammonium chloride 8.704%, n-Alkydimethyl benzyl ammonium chloride 8.190%
Virex® TB		n-Alkyl dimethyl benzyl ammonium chlorides 0.105%, n-Alkyl dimethyl ethylbenzyl ammonium chlorides 0.105%
Rely+On™ Virkon® High Level Surface Disinfectant	Powder	Used as 1% solution Biocidal active: Pentapotassium bis (peroxymonosulphate) bis (sulphate)(500g/kg), Contains dipotassium peroxodisulphate.
Alpet® D2 Surface Sanitizing Wipes	Wipes	Isopropyl Alcohol 58.6000%, Octyl Decyl Dimethyl Ammonium chloride 0.0075%, Dioctyl Dimethyl Ammonium Chloride 0.0030%
Clorox Dispatch® Hospital Cleaner Disinfectant Towels with Bleach		Sodium Hypochlorite 0.65%
Clorox Healthcare® Bleach Germicidal Wipes		Sodium Hypochlorite 0.55%
Clorox Healthcare® Hydrogen Peroxide Cleaner Disinfectant Wipes		Hydrogen Peroxide 1.4%
Diversey Oxivir® TB Wipes		Hydrogen Peroxide 0.5%
Metrex CaviWipes™		Diisobutylphenoxyethoxyethyl dimethyl benzyl ammonium chloride 0.28%, Isopropanol 17.2%
PDI Sani-Cloth® AF3 Germicidal Disposable Wipe		n-Alkyl dimethyl ethylbenzyl ammonium chlorides 0.14%, n-Alkyl dimethyl benzyl ammonium chlorides 0.14%
PDI Sani-Cloth® Bleach Germicidal Disposable Wipe		Sodium Hypochlorite 0.63%, other ingredients 99.37%
PDI Sani-Cloth® HB Germicidal Disposable Wipe		n-Alkyl dimethyl ethylbenzyl ammonium chlorides 0.07%, n-Alkyl dimethyl benzyl ammonium chlorides 0.07%
PDI Sani-Cloth® Plus Germicidal Disposable Cloth		n-Alkyl dimethyl ethylbenzyl ammonium chlorides 0.125%, n-Alkyl dimethyl benzyl ammonium chlorides 0.125%
PDI Super Sani-Cloth® Germicidal Disposable Wipe	n-Alkyl dimethyl ethylbenzyl ammonium chlorides 0.25%, n-Alkyl dimethyl benzyl ammonium chlorides 0.25%, Isopropyl Alcohol 55.0%	

Product Name	Product Type	Active Ingredients
VIRAGUARD Hospital Surface Disinfectant Towelette	Wipes	Isopropanol 70%, Other ingredients 30%

NOTE

- For equipment with the symbol , all the listed cleaning and disinfecting agents are available for use.

35.3.2 Cleaning the Equipment and Mounting Kits

The main unit, parameter modules, and SMR should be cleaned on a regular basis. Before cleaning the equipment and mounting kits, consult your hospital's regulations for cleaning the equipment.

To clean your equipment, follow this procedure:

1. Shut down the monitor and disconnect it from the AC power.
2. Clean the display screen with wipes or a soft cloth moistened with one of the cleaning agents listed in *35.3.1 Approved Cleaning and Disinfecting Agents* only.
3. Clean the exterior surface of the equipment, module, and SMR with wipes or a soft cloth moistened with one of the cleaning agents listed in *35.3.1 Approved Cleaning and Disinfecting Agents* only.
4. Wipe off all the cleaning agent residue with a dry cloth.
5. Dry your equipment in a ventilated, cool place.

35.3.3 Disinfecting the Equipment and Mounting Kits

Disinfect the main unit, parameter modules, and SMR as required in your hospital's servicing schedule using the disinfecting agents listed in the table above. Cleaning equipment before disinfecting is recommended.

CAUTION

- Never use EtO or formaldehyde for disinfection.

35.4 Cleaning and Disinfecting the Accessories

For the NIBP air hose, SpO₂ cable, and NMT accessories, you should clean and disinfect them using the cleaners and disinfectants and methods listed in this section. For other accessories, you should consult the instructions delivered with the accessories.

CAUTION

- Fluids entering the NIBP air hose can damage the equipment. When cleaning and/or disinfecting the NIBP air hose, prevent liquid from entering the hose.
- Periodically inspect the NIBP air hose and connector for signs of wear or deterioration. Replace the NIBP air hose if you detect a leak. Dispose of damaged NIBP air hose according to local laws for disposal of hospital waste.
- Never immerse or soak the accessories in any liquid.
- Never clean or disinfect the metallic connectors at either end of the accessories.
- Use only Mindray approved cleaners and disinfectants and methods listed in this section to clean or disinfect the accessories. Warranty does not cover damage caused by unapproved substances or methods.
- To avoid long term damage, the accessories should be disinfected only when necessary as determined by your hospital's policy.

35.4.1 Approved Accessories Cleaning and Disinfecting Agents

The following table lists approved NIBP air hose cleaning and disinfecting agents:

Product Name	Product Type	Active Ingredients
Isopropanol	Liquid	Isopropanol 70%
1-Propanol		1-Propanol 50%
Metrex CaviCide1™		Diisobutylphenoxyethoxyethyl dimethyl benzyl ammonium chloride 0.28%, Isopropanol 17.2%
Virex® TB		n-Alkyl dimethyl benzyl ammonium chlorides 0.105%, n-Alkyl dimethyl ethylbenzyl ammonium chlorides 0.105%
Rely+On™ Virkon® High Level Surface Disinfectant	Powder	Used as 1% solution Biocidal active: Pentapotassium bis (peroxymonosulphate) bis (sulphate)(500g/kg), Contains dipotassium peroxodisulphate.
Alpet® D2 Surface Sanitizing Wipes	Wipes	Isopropyl Alcohol 58.6000%, Octyl Decyl Dimethyl Ammonium chloride 0.0075%, Dioctyl Dimethyl Ammonium Chloride 0.0030%
Clorox Dispatch® Hospital Cleaner Disinfectant Towels with Bleach		Sodium Hypochlorite 0.65%
Metrex CaviWipes™		Diisobutylphenoxyethoxyethyl dimethyl benzyl ammonium chloride 0.28%, Isopropanol 17.2%
PDI Sani-Cloth® AF3 Germicidal Disposable Wipe		n-Alkyl dimethyl ethylbenzyl ammonium chlorides 0.14%, n-Alkyl dimethyl benzyl ammonium chlorides 0.14%
PDI Sani-Cloth® Plus Germicidal Disposable Cloth		n-Alkyl dimethyl ethylbenzyl ammonium chlorides 0.125%, n-Alkyl dimethyl benzyl ammonium chlorides 0.125%
PDI Super Sani-Cloth® Germicidal Disposable Wipe		n-Alkyl dimethyl ethylbenzyl ammonium chlorides 0.25%, n-Alkyl dimethyl benzyl ammonium chlorides 0.25%, Isopropyl Alcohol 55.0%
VIRAGUARD Hospital Surface Disinfectant Towelette		Isopropanol 70%, Other ingredients 30%

The following table lists approved Masimo SpO₂ cable cleaning and disinfecting agents:

Product Name	Product Type	Active Ingredients
Isopropanol	Liquid	Isopropanol 70%

The following table lists approved Nellcor SpO₂ cable cleaning and disinfecting agents:

Product Name	Product Type	Active Ingredients
Sodium hypochlorite bleach	Liquid	Sodium hypochlorite bleach 0.5%
Isopropanol		Isopropanol 70%
1-Propanol		1-Propanol 50%
Virex® TB		n-Alkyl dimethyl benzyl ammonium chlorides 0.105%, n-Alkyl dimethyl ethylbenzyl ammonium chlorides 0.105%
Rely+On™ Virkon® High Level Surface Disinfectant	Powder	Used as 1% solution Biocidal active: Pentapotassium bis (peroxymonosulphate) bis (sulphate)(500g/kg), Contains dipotassium peroxodisulphate.
Clorox Dispatch® Hospital Cleaner Disinfectant Towels with Bleach	Wipes	Sodium Hypochlorite 0.65%
Clorox Healthcare® Bleach Germicidal Wipes		Sodium Hypochlorite 0.55%
Clorox Healthcare® Hydrogen Peroxide Cleaner Disinfectant Wipes		Hydrogen Peroxide 1.4%
Diversey Oxivir® TB Wipes		Hydrogen Peroxide 0.5%
PDI Super Sani-Cloth® Germicidal Disposable Wipe		n-Alkyl dimethyl ethylbenzyl ammonium chlorides 0.25%, n-Alkyl dimethyl benzyl ammonium chlorides 0.25%, Isopropyl Alcohol 55.0%
VIRAGUARD Hospital Surface Disinfectant Towelette		Isopropanol 70%, Other ingredients 30%

The following table lists approved NMT accessory cleaning and disinfecting agents:

Product Name	Product Type	Active Ingredients
Sodium hypochlorite bleach	Liquid	Sodium hypochlorite bleach 0.5%
Isopropanol		Isopropanol 70%
1-Propanol		1-Propanol 50%
Metrex CaviCide1™		Diisobutylphenoxyethoxyethyl dimethyl benzyl ammonium chloride 0.28%, Isopropanol 17.2%
Virex® TB		n-Alkyl dimethyl benzyl ammonium chlorides 0.105%, n-Alkyl dimethyl ethylbenzyl ammonium chlorides 0.105%
Rely+On™ Virkon® Powder (Used as 1% solution)	Powder	Used as 1% solution Biocidal active: Pentapotassium bis (peroxymonosulphate) bis (sulphate)(500g/kg), Contains dipotassium peroxodisulphate.

Product Name	Product Type	Active Ingredients
Alpet® D2 Surface Sanitizing Wipes	Wipes	Isopropyl Alcohol 58.6000%, Octyl Decyl Dimethyl Ammonium chloride 0.0075%, Dioctyl Dimethyl Ammonium Chloride 0.0030%
Clorox Dispatch® Hospital Cleaner Disinfectant Towels with Bleach		Sodium Hypochlorite 0.65%
Clorox Healthcare® Bleach Germicidal Wipes		Sodium Hypochlorite 0.55%
Clorox Healthcare® Hydrogen Peroxide Cleaner Disinfectant Wipes		Hydrogen Peroxide 1.4%
Diversey Oxivir® TB Wipes		Hydrogen Peroxide 0.5%
Metrex CaviWipes™		Diisobutylphenoxyethoxyethyl dimethyl benzyl ammonium chloride 0.28%, Isopropanol 17.2%
PDI Sani-Cloth® AF3 Germicidal Disposable Wipe		n-Alkyl dimethyl ethylbenzyl ammonium chlorides 0.14%, n-Alkyl dimethyl benzyl ammonium chlorides 0.14%
PDI Sani-Cloth® Bleach Germicidal Disposable Wipe		Sodium Hypochlorite 0.63%, other ingredients 99.37%
PDI Sani-Cloth® Plus Germicidal Disposable Cloth		n-Alkyl dimethyl ethylbenzyl ammonium chlorides 0.125%, n-Alkyl dimethyl benzyl ammonium chlorides 0.125%
PDI Super Sani-Cloth® Germicidal Disposable Wipe		n-Alkyl dimethyl ethylbenzyl ammonium chlorides 0.25%, n-Alkyl dimethyl benzyl ammonium chlorides 0.25%, Isopropyl Alcohol 55.0%
VIRAGUARD Hospital Surface Disinfectants	Isopropanol 70%, Other ingredients 30%	

35.4.2 Cleaning the Accessories

You should clean the accessories (NIBP air hose, Masimo SpO₂ cable, Nellcor SpO₂ cable and NMT accessories) on a regular basis. Before cleaning the accessories, consult your hospital's regulations for cleaning the accessories.

To clean the accessories, follow this procedure:

1. Clean the accessories with wipes or a soft cloth moistened with one of the cleaning agents listed in 35.4.1 *Approved Accessories Cleaning and Disinfecting Agents* only.
2. Wipe off all the cleaning agent residue with a dry cloth.
3. Allow the accessories to air dry.

35.4.3 Disinfecting the Accessories

We recommend that the accessories (NIBP air hose, SpO₂ cables, and NMT accessories) should be disinfected only when necessary as determined by your hospital's policy, to avoid long term damage to the accessories. Cleaning the accessories before disinfecting is recommended.

35.5 Sterilization

Sterilization is not recommended for this equipment, related products, accessories, or supplies unless otherwise indicated in the Instructions for Use that accompany the products, accessories or supplies.

36 Maintenance

36.1 Maintenance Introduction

Regular maintenance is essential to ensure that the equipment continues to function properly. This chapter contains information on periodic testing and maintenance.

36.2 Maintenance Safety Information

WARNING

- To avoid electric shock, stop using the equipment if you find the housing is damaged, and contact the service personnel.
 - Failure on the part of the responsible individual hospital or institution using this equipment to implement a recommended maintenance schedule may cause undue equipment failure and possible health hazards.
 - No modification of this equipment is allowed.
 - This equipment contains no user serviceable parts.
 - The safety checks or maintenance involving any disassembly of the equipment should be performed by professional service personnel. Otherwise, undue equipment failure and possible health hazards could result.
 - Do not open batteries, heat batteries to above 60 °C, incinerate batteries, or short the battery terminals. Batteries may ignite, explode, leak or heat up, causing personal injury.
 - The service personnel must be properly qualified and thoroughly familiar with the operation of the equipment.
-

CAUTION

- The equipment and accessories shall not be serviced or maintained while in use on a patient.
 - If you discover a problem with any of the equipment, contact your service personnel or Mindray.
 - Use and store the equipment within the specified temperature, humidity, and altitude ranges.
 - When disposing of the packaging material, be sure to observe the applicable waste control regulations and keep it out of the reach of children.
 - At the end of its service life, the equipment, as well as its accessories, must be disposed of in compliance with the guidelines regulating the disposal of such products. If you have any questions concerning disposal of the equipment, please contact Mindray.
-

36.3 Maintenance and Testing Schedule

Follow the maintenance and testing schedule or local regulations to perform testing and maintenance such as defined in section 36.5 *Testing Methods and Procedures*. Follow your hospital policy on cleaning and disinfecting the equipment before testing and maintenance.

The following table lists the maintenance and testing schedule:

Test/Maintenance Item		Recommended Frequency
Performance Tests		
Visual inspection		Every day, before first use.
Measurement module performance test and calibration		<ol style="list-style-type: none"> 1. If you suspect that the measurement values are incorrect. 2. Follow any repairs or replacement of relevant module. 3. Once a year for CO₂ and AG tests. 4. Once every two years for other parameter module performance tests.
Analog output test		If you suspect that the analog output function does not work properly.
Defibrillation synchronization test		If you suspect that the defibrillation synchronization function does not work properly.
Nurse call test		If you suspect that the nurse call function does not work properly.
Electrical Safety Tests		
Electrical safety tests		Once every two years.
Other Tests		
Power-on test		Before use
NMT sensor check		Once a year.
Recorder check		<ol style="list-style-type: none"> 1. When the recorder is used for the first time. 2. Follow any repair or replacement of the recorder.
Network printer tests		<ol style="list-style-type: none"> 1. When first installed. 2. Follow any repair or replacement of the printer.
Device integration check		<ol style="list-style-type: none"> 1. When first installed. 2. Following any repair or replacement of the external device.
Battery check	Functionality test	<ol style="list-style-type: none"> 1. When first installed. 2. When battery is replaced.
	Performance test	Every three months or if the battery runtime is reduced significantly.

36.4 Checking System Software Version

To view system software version information, select the **Main Menu** quick key → from the **System** column select **Version**.

You can check the detailed system software version, module hardware and software version, and firmware version only from the **Maintenance** dialog.

36.5 Testing Methods and Procedures

Except for the following maintenance tasks, all other test and maintenance tasks should be performed by Mindray-qualified service personnel only.

- Regular checks, including visual inspection and power-on test
- NMT sensor check

- Printer and recorder tests
- Battery check

If your monitor needs a safety test and performance test, contact the service personnel.

36.5.1 Performing Visual Inspection

Visually inspect the equipment before its first use every day. If you find any signs of damage, remove the monitor from use and contact the service personnel.

Verify that the equipment meets the following requirements:

- Environment and power supply specifications are met.
- The monitor housing and display screen are free from cracks or other damage.
- The power cord is not damaged and the insulation is in good condition.
- Connectors, plugs, and cables are not damaged or kinked.
- Power cord and patient cables are securely connected to the equipment and modules.

36.5.2 Performing Power-on Test

The monitor automatically performs a power-on test at startup. Verify the following items for the power-on test:

- The equipment powers on properly.
- The alarm system works properly, denoted by alarm sounds and display of all 3 alarm light colors.
- The monitor displays properly.

36.5.3 Checking the NMT Sensor

NMT sensor check is required once a year or when you doubt the measured values.

To calibrate the NMT sensor,

1. Select the **Main Menu** quick key → from the **System** column select **Maintenance** → input the required password → select .
2. Select the **Module** tab → **NMT** tab.
3. Follow the on-screen instructions to check the NMT sensor in four ways.

If sensor check completes successfully, the message “Test passed. The function of NMT sensor is OK” is presented. If any of the four steps fails, check if the sensor is placed correctly as instructed and perform the sensor check again. Replace the sensor or contact your service personnel if it cannot pass the sensor check.

NOTE

- **Stop NMT measurement or calibration before starting an NMT sensor check.**
- **Take care when handling the NMT sensor. Avoid forceful strikes to the sensor.**

36.5.4 Testing the Recorder

To test the recorder, follow this procedure:

1. Start a recording task to print waveforms and reports.
2. Check that the recorder functions correctly.
3. Check that the printout is clear without missing dots.

36.5.5 Testing the Network Printer

To check the printer, follow this procedure:

1. Start a printing task to print waveforms and reports.
2. Check that the printer is properly connected and functions correctly.

3. Check that the printout is clear with no missing information.

36.5.6 Checking the Battery

For information on battery check, see 34.6.2 *Checking Battery Performance*.

36.6 NIBP Maintenance

36.6.1 NIBP Leakage Test

The NIBP leakage test checks the integrity of the system and of the valve. The NIBP leakage test should be performed once every two years or when you doubt the NIBP measurements. The NIBP leakage test should be performed by Mindray-qualified service personnel only.

36.6.2 NIBP Accuracy Test

The NIBP accuracy test should be performed once every two years or when you doubt the NIBP measurements. The NIBP accuracy test should be performed by Mindray-qualified service personnel only.

36.7 Disposing of the Monitor

Dispose of the monitor and its accessories when its service life is reached. Follow local regulations regarding the disposal of such product.

WARNING

- **For disposal of parts and accessories, where not otherwise specified, follow local regulations regarding disposal of hospital waste.**
-
-

37 Accessories

The accessories listed in this chapter comply with the requirements of IEC 60601-1-2 when in use with the patient monitor. The accessory material that contacts the patients has undertaken the bio-compatibility test and is verified to be in compliance with ISO 10993-1. For details about the accessories, refer to the instructions for use provided with the accessory.

WARNING

- Use accessories specified in this chapter. Using other accessories may cause damage to the patient monitor or not meet the claimed specifications.
- Single-use accessories are not designed to be reused. Reuse may cause a risk of contamination and affect the measurement accuracy.

CAUTION

- The accessories may not meet the performance specifications if stored or used outside the specified temperature and humidity ranges. If accessory performance is degraded due to aging or environmental conditions, contact your service personnel.
- Check the accessories and their packages for any sign of damage. Do not use them if any damage is detected.
- Use the accessories before the expiration date if an expiration date is indicated.
- Discard disposable accessories according to hospital regulations.

NOTE

- This manual describes all the accessories that are validated for use. Not all accessories are available in every market.

37.1 ECG Accessories

37.1.1 ECG Electrodes Available for Purchase

Model	Part No.	Description	Usage	Applicable patient
31499224	0010-10-12304	Electrode, Kendall, pkg of 10	Disposable	Adult
1050NPSMKittyCat	0681-00-0098-01	NEO pre-wired electrode radio Opaque, pkg of 100	Disposable	Neonate
1051NPSMKittyCat	0681-00-0098-02	NEO pre-wired electrode radio Translucent, pkg of 100	Disposable	Neonate
H124SG	900E-10-04880	ECG electrode, Kendall, 10 pcs/ package	Disposable	Neonate

37.1.2 ECG Electrodes Also Compatible

Model	Part No.	Description	Usage	Applicable patient
2245-50	9000-10-07469	ECG electrode, 3M, pkg of 50	Disposable	Pediatric

37.1.3 12-Pin Trunk Cables Available for Purchase

Model	Part No.	Description	Usage	Applicable patient
EV6206	009-005266-00	ECG cable, 10' (3.1 m), defibrillation-proof, for N/T	Reusable	Adult/Pediatric
EV6207	009-005267-00	ECG cable, 20' (6.2 m), defibrillation-proof, for N/T	Reusable	Adult/Pediatric
EV6216	009-005268-00	ECG cable, 10' (3.1 m), ESU-proof, for N/T	Reusable	Adult/Pediatric
EV6217	009-005269-00	ECG cable, 20' (6.2 m), ESU-Proof, for N/T	Reusable	Adult/Pediatric

37.1.4 12-Pin Trunk Cables Also Compatible

Model	Part No.	Description	Usage	Applicable patient
EV6201	0010-30-42719	12Pin 3/5-Lead ECG trunk cable, defibrillation-proof	Reusable	Adult/Pediatric
EV6202	0010-30-42720	12Pin 3-Lead ECG trunk cable, defibrillation-proof	Reusable	Pediatric/Neonate
EV6203	0010-30-42721	12Pin 12-Lead trunk cable, defibrillation-proof	Reusable	Adult/Pediatric
EV6211	0010-30-42723	12Pin 3/5-Lead ECG trunk cable, ESU-proof	Reusable	Adult/Pediatric
EV6212	0010-30-42724	12Pin 3-Lead ECG trunk cable, ESU-proof	Reusable	Pediatric/Neonate
EV6222	040-000754-00	12Pin 3-Lead trunk cable, defibrillation-proof, DIN Conn	Reusable	Pediatric/Neonate

37.1.5 3-lead ECG Leadwires Available for Purchase

Model	Part No.	Description	Usage	Applicable patient
EY6316B	009-004765-00	3-Lead, N/T, AHA, snap, 24"	Reusable	Adult/Pediatric
EY6305B	009-004766-00	3-Lead, N/T, AHA, snap, 36"	Reusable	Adult/Pediatric
EY6316A	009-004771-00	3-Lead, N/T, AHA, clip, 24"	Reusable	Adult/Pediatric
EY6305A	009-004772-00	3-Lead, N/T, AHA, clip, 36"	Reusable	Adult/Pediatric
EY6310B	009-004777-00	3-Lead, N/T, AHA, snap, 24"	Disposable	Adult/Pediatric

37.1.6 3-lead ECG Leadwires Also Compatible

Model	Part No.	Description	Usage	Applicable patient
EL6305A	0010-30-42896	3-Lead leadset, AHA, clip	Reusable	Neonate
EL6303A	0010-30-42731	3-Lead leadset, AHA, clip, Long	Reusable	Adult/Pediatric
EL6301B	0010-30-42734	3-Lead leadset, AHA, snap	Reusable	Adult/Pediatric
EL6311B	040-000146-00	3-Lead leadset, AHA, snap	Disposable	Pediatric/Neonate
EL6311A	040-000148-00	3-Lead leadset, AHA, clip	Disposable	Pediatric/Neonate

37.1.7 5-lead ECG Leadwires Available for Purchase

Model	Part No.	Description	Usage	Applicable patient
EY6511B	009-004782-00	5-Lead, N/T, AHA, snap, 24"	Reusable	Adult/Pediatric
EY6512B	009-004783-00	5-Lead, N/T, AHA, snap, 36"	Reusable	Adult/Pediatric
EY6511A	009-004786-00	5-Lead, N/T, AHA, pinch, 24"	Reusable	Adult/Pediatric
EY6512A	009-004787-00	5-Lead, N/T, AHA, pinch, 36"	Reusable	Adult/Pediatric
EY6507B	009-004790-00	5-Lead, N/T, AHA, snap, 24"	Disposable	Adult/Pediatric

37.1.8 5-lead ECG Leadwires Also Compatible

Model	Part No.	Description	Usage	Applicable patient
EL6503A	0010-30-42729	5-Lead leadset, AHA, clip, Long	Reusable	Adult/Pediatric
EL6501B	0010-30-42735	5-Lead leadset, AHA, snap	Reusable	Adult/Pediatric
EL6501A	0010-30-42727	5-Lead leadset, AHA, clip	Reusable	Adult/Pediatric

37.1.9 6-lead ECG Leadwires Available for Purchase

Model	Part No.	Description	Usage	Applicable patient
EY6601B	009-004794-00	6-Lead, N/T, AHA, snap, 24"	Reusable	Adult/Pediatric
EY6602B	009-004795-00	6-Lead, N/T, AHA, snap, 36"	Reusable	Adult/Pediatric
EY6601A	009-004798-00	6-Lead, N/T, AHA, pinch, 24"	Reusable	Adult/Pediatric
EY6602A	009-004799-00	6-Lead, N/T, AHA, pinch, 36"	Reusable	Adult/Pediatric

37.1.10 12-lead ECG Chest Leadwires Available for Purchase

Model	Part No.	Description	Usage	Applicable patient
EL6803A	0010-30-42904	12-Lead leadset, chest, AHA, clip	Reusable	Adult/Pediatric
EL6803B	0010-30-42908	12-Lead leadset, chest, AHA, snap	Reusable	Adult/Pediatric

37.1.11 12-lead ECG Leadwires Also Compatible

Model	Part No.	Description	Usage	Applicable patient
EL6801A	0010-30-42902	12-Lead leadset, limb, AHA, clip	Reusable	Adult/Pediatric
EL6801B	0010-30-42906	12-Lead leadset, limb, AHA, snap	Reusable	Adult/Pediatric

37.2 SpO₂ Accessories

Wavelength emitted by the sensors is between 600 nm and 1000 nm. The maximum photic output consumption of the sensor is less than 18 mW.

The information about the wavelength range and maximum photic output consumption can be especially useful to clinicians, for example, when photodynamic therapy is performed.

37.2.1 Extension Cables and Adapter Cables Available for Purchase

Model	Part No.	Description	Usage	Applicable patient
572A	0010-20-42712	8-pin SpO2 extension cable, Nellcor	Reusable	/
583A	040-003310-00	8-pin, RD SET, Masimo	Reusable	/
4089	040-003381-00	RD to LNCS adapter cable, Masimo	Reusable	/
4092	040-003426-00	LNCS to RD adapter, Masimo	Reusable	/

37.2.2 Extension Cables and Adapter Cables Also Compatible

Model	Part No.	Description	Usage	Applicable patient
582A	115-020768-00	8-pin SpO2 extension cable, Masimo	Reusable	/

37.2.3 Masimo SpO₂ RD Set Sensors Available for Purchase

Model	Part No.	Description	Usage	Applicable patient
4050	040-003376-00	SpO2 sensor, RD SET DCI	Reusable	Adult (> 30 kg)
4051	040-003377-00	SpO2 sensor, RD SET DCI	Reusable	Pediatric (10-50 kg)
4053	040-003380-00	SpO2 sensor, RD Set TC-I, tip-clip ear sensor, 3ft	Reusable	Adult (> 30 kg)
4000	040-003382-00	SpO2 sensor, RD SET Adt, adhesive, pkg of 20	Disposable	Adult (> 30 kg)
4001	040-003383-00	SpO2 sensor, RD SET PDT, adhesive, pkg of 20	Disposable	Pediatric (10 to 50 kg)
4002	040-003384-00	SpO2 sensor, RD Set Inf, adhesive, pkg of 20	Disposable	Infant (3 to 20 kg)
4003	040-003385-00	SpO2 sensor, RD Set Neo, adhesive, pkg of 20	Disposable	Neonatal /Adult (<3Kg or >40Kg)
4004	040-003386-00	SpO2 sensor, RD Set NeoPt, adhesive, pkg of 20	Disposable	Neonate (<1 kg)
4005	040-003387-00	SpO2 sensor, RD Set NeoPt-500, non-adhesive, pkg of 20	Disposable	Neonate (<1 kg)

37.2.4 Masimo SpO₂ LNCS Sensors Also Compatible

Model	Part No.	Description	Usage	Applicable patient
LNCS DCI	0010-10-42600	SpO2 sensor, finger-clip	Reusable	Adult (>30 kg)
LNCS DCIP	0010-10-42634	SpO2 sensor, finger-clip	Reusable	Pediatric (10-50 kg)
LNCS YI	0010-10-43016	SpO2 sensor, multisite	Reusable	Adult/Pediatric/ Neonate
LNCS NeoPt-L	0010-10-42626	SpO2 sensor	Disposable	Neonate (<1 kg)
LNCS Neo-L	0010-10-42627	SpO2 sensor	Disposable	Neonate /Adult (<3 kg or >40 kg)
LNCS Inf-L	0010-10-42628	SpO2 sensor	Disposable	Infant (3-20 kg)

Model	Part No.	Description	Usage	Applicable patient
LNCS Pdtx	0010-10-42629	SpO2 sensor	Disposable	Pediatric (10-50 kg)
LNCS Adtx	0010-10-42630	SpO2 sensor	Disposable	Adult (>30 kg)
LNCS Adtx	0600-00-0121	SpO2 sensor, finger-clip, 20 pcs/box	Disposable	Adult (>30 kg)
LNCS Pdtx	0600-00-0122	SpO2 sensor, finger-clip, 20 pcs/box	Disposable	Pediatric (10-50 kg)
LNCS DCI	0600-00-0126	SpO2 sensor, finger-clip	Reusable	Adult (>30 kg)
LNCS DCIP	0600-00-0127	SpO2 sensor, finger-clip	Reusable	Pediatric (10-50 kg)
LNCS NeoPt	0600-00-0156	SpO2 sensor, finger-clip	Disposable	Neonate (<1Kg)
LNCS Neo-L	0600-00-0157	SpO2 sensor, 20 pcs/box	Disposable	Neonate /Adult (<3 kg or > 40 kg)
LNCS Inf	0600-00-0158	SpO2 sensor, 20 pcs/box	Disposable	Infant (3-20 kg)

37.2.5 Nellcor SpO₂ Sensors Also Compatible

Model	Part No.	Description	Usage	Applicable patient
DS-100A	9000-10-05161	SpO2 sensor, finger-clip	Reusable	Adult
D-YS	0010-10-12476	SpO2 sensor, with wraps	Reusable	/
OXI-P/I	9000-10-07308	SpO2 sensor, finger, band	Reusable	Pediatric/Infant
OXI-A/N	9000-10-07336	SpO2 sensor, finger/foot, band	Reusable	Adult/Neonate
MAX-AI	0010-10-12202	SpO2 sensor, 24 pcs/box	Disposable	Adult (>30 kg)
MAX-PI	0010-10-12203	SpO2 sensor, 24 pcs/box	Disposable	Pediatric (10-50 Kg)
MAX-II	0010-10-12204	SpO2 sensor, 24 pcs/box	Disposable	Infant (3-20 kg)
MAX-NI	0010-10-12205	SpO2 sensor, 24 pcs/box	Disposable	Adult/Neonate (<3 kg or >40 kg)

37.3 Temp Accessories

37.3.1 Temp Cable Available for Purchase

Model	Part No.	Description	Usage	Applicable patient
MR420B	040-001235-00	2-pin Temperature adapter cable	Reusable	/

37.3.2 Temp Probes Available for Purchase

Model	Part No.	Description	Usage	Applicable patient
MR401B	0011-30-37392	Temperature probe, endocavity	Reusable	Adult
MR402B	0011-30-37394	Temperature probe, endocavity	Reusable	Pediatric/Infant
MR403B	0011-30-37393	Temperature probe, skin surface	Reusable	Adult
MR404B	0011-30-37395	Temperature probe, skin surface	Reusable	Pediatric/Infant
MR411	040-003292-00	Temperature probe, esophageal/rectal, 9FR	Disposable	Adult/Pediatric

Model	Part No.	Description	Usage	Applicable patient
MR412	040-003293-00	Temp probe, skin surface	Disposable	All
ES400-12	0206-03-0112-02	PROBE,D TEMP,ES400-12 (box of 20)	Disposable	Adult
ES400-18	0206-03-0118-02	PROBE,D TEMP,ES400-18 (box of 20)	Disposable	Adult
ER400-9	0206-03-0209-02	PROBE,D TEMP,ER 400-9 (box of 20)	Disposable	Adult
ER400-12	0206-03-0212-02	PROBE,D TEMP,ER400-12 (box of 20)	Disposable	Adult
STS-400	0206-03-0300-02	PROBE,D TEMP,STS-400 (box of 20)	Disposable	Adult

37.4 NIBP Accessories

37.4.1 NIBP Hoses Available for Purchase

Model	Part No.	Description	Usage	Applicable patient
CM1903	6200-30-09688	NIBP hose, inbuilt connector, 3m	Reusable	Adult/Pediatric
CM1901	6200-30-11560	NIBP hose, inbuilt connector, 3m	Reusable	Neonate

37.4.2 Cuffs Available for Purchase

Model	Part No.	Description	Usage	Applicable patient
CM1301	115-027713-00	Cuff, 10-19 cm, bladderless	Reusable	Infant
CM1302	115-027714-00	Cuff, 18-26 cm, bladderless	Reusable	Small Adult
CM1303	115-027715-00	Cuff, 25-35 cm, bladderless	Reusable	Adult
CM1304	115-027716-00	Cuff, 33-47 cm, bladderless	Reusable	Adult
CM1305	115-027717-00	Cuff, 46-66 cm, bladderless	Reusable	Adult thigh
CM1306	115-027718-00	Cuff, 24-35 cm, bladderless	Reusable	Adult
CM1307	115-027719-00	Cuff, 33-47 cm, bladderless	Reusable	Adult
CM1501	115-027556-00	Cuff, 10-19 cm, bladderless	Disposable	Child
CM1502	115-027557-00	Cuff, 18-26 cm, bladderless	Disposable	Small adult
CM1503	115-027558-00	Cuff, 25-35 cm, bladderless	Disposable	Adult
CM1504	115-027559-00	Cuff, 33-47 cm, bladderless	Disposable	Large adult
CM1505	115-027560-00	Cuff, 46-66 cm, bladderless	Disposable	Adult thigh
CM1506	115-027561-00	Cuff, 25-35 cm, bladderless, long	Disposable	Adult
CM1507	115-027562-00	Cuff, 33-47 cm, bladderless, long	Disposable	Large adult
CM1500A	001B-30-70677	Cuff, 3.1-5.7 cm	Disposable	Neonate
CM1500B	001B-30-70678	Cuff, 4.3-8.0 cm	Disposable	Neonate
CM1500C	001B-30-70679	Cuff, 5.8-10.9 cm	Disposable	Neonate
CM1500D	001B-30-70680	Cuff, 7.1-13.1 cm	Disposable	Neonate
CM1500E	001B-30-70681	Cuff, 5#	Disposable	Neonate

37.5 IBP Accessories

37.5.1 IBP Accessories Available for Purchase

Model	Part No.	Description	Usage	Applicable patient
IM2202	001C-30-70757	12 Pin IBP cable, Argon	Reusable	/
IM2201	001C-30-70759	12 Pin IBP cable, ICU Medical	Reusable	/
IM2211	0010-21-12179	12 Pin IBP cable, Edwards	Reusable	/

37.5.2 IBP Accessories Also Compatible

Model	Part No.	Description	Usage	Applicable patient
DT-4812	6000-10-02107	Disposable transducer kit, Argon	Disposable	/
682275	0010-10-12156	Mounting background and accessory for IBP transducer, Argon	Reusable	/
42584	0010-10-42638	IBP transducer, ICU Medical	Disposable	/
42602	M90-000133---	Mounting background and accessory for IBP transducer, ICU Medical	Reusable	/
42394	M90-000134---	Mounting clamp for IBP transducer (send with the cable), ICU Medical	Reusable	/

37.5.3 ICP Accessories Available for Purchase

Model	Part No.	Description	Usage	Applicable patient
82-6653	040-002336-00	Codman ICP sensor kit, Johnson & Johnson, pkg of 1	Disposable	/
CP12601	009-005460-00	12 Pin ICP Cable	Reusable	/
CP12603	040-001368-00	Adapter for Camino cable	Reusable	/
/	009-004401-00	ICP adapting cable for Camino	Reusable	/

37.6 C.O. Accessories Available for Purchase

Model	Part No.	Description	Usage	Applicable patient
CO7702	0010-30-42743	12Pin C.O. cable, Edwards	Reusable	/
9850A	0012-00-1519	Cable, bath probe adapter	Reusable	/
SP4042	6000-10-02079	In-line injection temperature sensor, BD	Reusable	/
SP5045	6000-10-02080	In-line injection temperature sensor housing, BD, pkg of 25	Disposable	/
MX387	040-006154-00	12cc control syringe w/Rotator (MEDEX MX387)	Disposable	/
93522	0012-00-1520	In-line inject temperature probe	Reusable	/

37.7 ScvO₂ Accessories Available for Purchase

Model	Part No.	Description	Usage	Applicable patient
PC3030	115-008191-00	ScvO ₂ optical module	Reusable	/
PV2022-37	040-000919-00	CeVOX fiberoptic probe, 37 cm, pkg of 1	Disposable	/
PV2022-35	040-000920-00	CeVOX fiberoptic probe, 35 cm, pkg of 1	Disposable	/

37.8 CO₂ Accessories

37.8.1 Sidestream CO₂ Accessories Available for Purchase

Model	Part No.	Description	Usage	Applicable patient
4000	M02A-10-25937	CO ₂ Nasal sample cannula, 7" line	Disposable	Adult
4100	M02A-10-25938	CO ₂ Nasal sample cannula, 7" line	Disposable	Pediatric
4200	M02B-10-64509	CO ₂ Nasal sample cannula, 7" line	Disposable	Neonatal
60-15200-00	9200-10-10533	Sampling line, 2.5 m	Disposable	Adult/Pediatric
60-15300-00	9200-10-10555	Sampling line, 2.5 m	Disposable	Neonatal
60-14100-00	9000-10-07486	Dryline airway adapter, straight	Disposable	Adu/Ped
040-001187-00	040-001187-00	Airway Adapter	Disposable	Neonatal
60-14200-00	9000-10-07487	Dryline airway adapter, elbow	Disposable	/
100-000080-00	115-058733-00	DRYLINE II water trap, pkg of 10	Reusable	Adult/Pediatric
100-000081-00	115-058734-00	DRYLINE II water trap, pkg of 10	Reusable	Neonatal

37.8.2 Microstream CO₂ Accessories Also Compatible

Model	Part No.	Description	Usage	Applicable patient
MVAI	0010-10-42560	Adult-Pediatric Intubated CO ₂ FilterLine	Disposable	Adult, pediatric
MVAIH	0010-10-42561	Adult-Pediatric Intubated CO ₂ FilterLine	Disposable	Adult, pediatric
MVIIH	0010-10-42562	Neonatal-Infant Intubated CO ₂ FilterLine	Disposable	Neonate
MVAIL	0010-10-42563	Adult-Pediatric Intubated CO ₂ FilterLine	Disposable	Adult, pediatric
MVAIHL	0010-10-42564	Adult-Pediatric Intubated CO ₂ FilterLine	Disposable	Adult, pediatric
MVIIHL	0010-10-42565	Neonatal-Infant Intubated CO ₂ FilterLine	Disposable	Neonate
MVA	0010-10-42566	Adt Oral-Nasal CO ₂ FilterLine	Disposable	Adult
MVP	0010-10-42567	Ped Oral-Nasal CO ₂ FilterLine	Disposable	Pediatric
MVAO	0010-10-42568	Adt Oral-Nasal CO ₂ FilterLine w/O ₂	Disposable	Adult
MVPO	0010-10-42569	Ped Oral-Nasal CO ₂ FilterLine w/O ₂	Disposable	Pediatric
MVAOL	0010-10-42570	Adt Oral-Nasal CO ₂ FilterLine w/O ₂ L	Disposable	Adult
MVPOL	0010-10-42571	Ped Oral-Nasal CO ₂ FilterLine w/O ₂ L	Disposable	Pediatric
MVANH	0010-10-42572	Adult Nasal CO ₂ FilterLine	Disposable	Adult

Model	Part No.	Description	Usage	Applicable patient
MVINH	0010-10-42574	Neo-Inf Nasal CO2 FilterLine H	Disposable	Neonate
MVANOH	0010-10-42575	Adt Nasal CO2 FilterLine w/O2 H	Disposable	Adult
MVPNOH	0010-10-42576	Ped Nasal CO2 FilterLine w/O2 H	Disposable	Pediatric
MVAN	0010-10-42577	Adult Nasal CO2 FilterLine	Disposable	Adult
MVPN	0010-10-42578	Pediatric Nasal CO2 FilterLine	Disposable	Pediatric

37.9 AG Accessories

37.9.1 AG Accessories Available for Purchase

Model	Part No.	Description	Usage	Applicable patient
60-15200-00	9200-10-10533	Sampling line, 2.5 m	Disposable	Adult/Pediatric
60-15300-00	9200-10-10555	Sampling line, DRYLINE, 2.5m	Disposable	Neonate
60-14100-00	9000-10-07486	DRYLINE airway adapter, straight	Disposable	Adult/Pediatric
60-14200-00	9000-10-07487	DRYLINE airway adapter, elbow	Disposable	Adult/Pediatric
100-000080-00	115-058733-00	DRYLINE II water trap, pkg of 10	Reusable	Adult/Pediatric
100-000081-00	115-058734-00	DRYLINE II water trap, pkg of 10	Reusable	Neonate
040-001187-00	040-001187-00	Airway adapter	Reusable	/

37.10 EEG Accessories Available for Purchase

Model	Part No.	Description	Usage	Applicable patient
B8830085010	040-001594-00	Cable for EEG	Reusable	Adult/Pediatric
B9721104003	040-001598-00	Cup electrodes for EEG	Reusable	Adult/Pediatric
B9721105004	040-001602-00	Cup electrodes for EEG (D=6 mm)	Reusable	Pediatric

37.11 BIS Accessories

37.11.1 BIS Accessories Available for Purchase

Model	Part No.	Description	Usage	Applicable patient
186-0195-MR	6800-30-50761	Bispectral Index kit, Covidien	Reusable	/
186-0224-MR	115-005707-00	BISx4 cable kit, Covidien	Reusable	/

37.11.2 BIS Accessories Also Compatible

Model	Part No.	Description	Usage	Applicable patient
186-0106	0010-10-42672	BIS Sensor Quatro(186-0106), Covidien	Disposable	Adult

Model	Part No.	Description	Usage	Applicable patient
186-0200	0010-10-42673	BIS Pediatric sensor(186-0200), Covidien	Disposable	Pediatric
186-0212	040-000392-00	BISx4 Sensor(Bilateral)(186-0212), Covidien	Disposable	Adult
186-0160	6800-10-50652	BIS Extend Sensor(186-0160), Covidien	Disposable	Adult

37.12 RM Accessories

Model	Part No.	Description	Applicable patient
040-001947-00	040-001947-00	Flow sensor, 1.8 m	Adult, pediatric
040-001949-00	040-001949-00	Flow sensor, 3.3 m	Adult, pediatric

37.13 NMT Accessories Available for Purchase

Model	Part No.	Description	Usage	Applicable patient
NM13101	040-001462-00	NMT cable	Reusable	Adult, pediatric
NM13401	040-001463-00	NMT sensor cable	Reusable	Adult, pediatric
NM13701	040-001464-00	NMT stimulation cable	Reusable	Adult, pediatric
NM13901	040-002258-00	Bandage for NMT sensor, pkg of 20	Disposable	Adult, pediatric

37.14 rSO₂ Accessories

37.14.1 rSO₂ Accessories Available for Purchase

Model	Part No.	Description	Usage	Applicable patient
RSC-1	100-000164-00	Sensor cable, channel 1, INVOS 5100C	Reusable	/
RSC-2	100-000165-00	Sensor cable, channel 2, INVOS 5100C	Reusable	/
5100C-PA	100-000173-00	Preamplifier, channel 1 & 2, INVOS 5100C	Reusable	/

37.14.2 rSO₂ Accessories Also Compatible

Model	Part No.	Description	Usage	Applicable patient
SAFB-SM	100-000168-00	SomaSensor (>40 kg)	Disposable	Adult
SPFB	100-000169-00	SomaSensor (<40 kg)	Disposable	Pediatric
SNN	100-000181-00	OxyAlert NIRSensor (<5kg), somatic, with sensor cable	Disposable	Neonate
CNN	100-000180-00	OxyAlert NIRSensor (<5kg), cerebral, with sensor cable	Disposable	Neonate
CNN/SNN	100-000182-00	OxyAlert NIRSensor (<5kg), somatic/ cerebral, with sensor cable	Disposable	Neonate

37.15 CCO/SvO2 Accessories Available for Purchase

Model	Part No.	Description	Usage	Applicable patient
/	009-000259-00	CCO/SvO ₂ cable	Reusable	/

37.16 BeneLink Accessories

Part No.	Description
009-001767-00	Serial port adapting cable, type A
009-001768-00	Serial port adapting cable, type B
009-001769-00	Serial port adapting cable, type C
009-002943-00	Serial port adapting cable, type D
009-004613-00	Serial port adapting cable, type E
009-008485-00	Serial port adapting cable, type F
115-011465-00	ID Adapter kit (contains ID Adapter with label and RJ45 cable with label)
115-007277-00	ID Adapter
047-004857-00	ID adapter label
047-004859-00	Network line label
009-001770-00	RJ45 connecting cable

37.17 External Modules

Module	Part No.	Comments
MPM module	115-048463-00	3/5/6 lead ECG, NIBP, dual channel Temp, Masimo SpO ₂ , dual channel IBP
MPM module	115-048464-00	3/5/6 lead ECG, NIBP, dual channel Temp, Nellcor SpO ₂ , dual channel IBP
MPM module	115-048466-00	3/5/6 lead ECG, NIBP, dual channel Temp, Masimo SpO ₂
MPM module	115-048467-00	3/5/6 lead ECG, NIBP, dual channel Temp, Nellcor SpO ₂
MPM module	115-048469-00	3/5/6/12 lead ECG, NIBP, dual channel Temp, Nellcor SpO ₂ , dual channel IBP)
MPM module	115-048470-00	3/5/6/12 lead ECG, NIBP, dual channel Temp, Masimo SpO ₂ , dual channel IBP
SpO ₂ module	115-047230-00	Supports SpO ₂ monitoring, Masimo SpO ₂
SpO ₂ module	115-039629-00	Supports SpO ₂ monitoring, Nellcor SpO ₂
Temp module	115-039554-00	Supports temperature monitoring
C.O. module	115-047275-00	Supports C.O. monitoring
IBP module	115-047274-00	Supports IBP monitoring
CCO/SvO ₂ module	115-003480-00	Connects Edwards Vigilance II®, Vigileo™, EV1000, or HemoSphere monitor, supports CCO and SvO ₂ monitoring
ScvO ₂ module	115-007273-00	Supports ScvO ₂ monitoring
EEG module	115-018152-00	Supports EEG monitoring
NMT module	115-018518-00	Supports NMT monitoring
BIS module	6800-30-50486	Supports BIS monitoring
rSO ₂ module	115-031388-00	Supports rSO ₂ monitoring, INVOS
Microstream CO ₂ module	6800-30-50558	Supports CO ₂ monitoring, Oridion
CO ₂ module	115-048924-00	Supports CO ₂ monitoring, Sidestream CO ₂
CO ₂ module (with O ₂)	115-048925-00	Supports CO ₂ monitoring, integrates O ₂ (paramagnetic) monitoring, Sidestream CO ₂
AG module	115-045728-00	Supports AG monitoring, integrates O ₂ (paramagnetic) monitoring
AG module	115-045727-00	Supports AG monitoring, integrates O ₂ (paramagnetic) and BIS monitoring
RM module	115-022808-00	Supports RM monitoring
Benelink module	115-052998-00	Connects external devices
Recorder module	115-031386-00	Supports recording
SMR	115-046943-00	Satellite module rack

37.18 Mount and Mounting Accessories

Part No.	Description
115-033887-00	8-slot satellite module rack (SMR), with handle, hook, and 2 m cable
0010-30-11972	SMR clamp assembly
034-000457-00	GCX M series pivot arm, 12" VESA mount
034-000458-00	GCX M series articulating arm, 12" x 12" for SMR
042-014101-00	NIBP cuff holder
043-006060-00	Cable hooks
115-035995-00	SMR clamp mounting kit, w/ 6" post
034-000458-00	GCX M series articulating arm, 12" x 12" for SMR
115-033911-00	SMR cable management mounting kit
115-035995-00	SMR clamp mounting kit, w/ 6" post
115-045621-00	SMR clamp mounting kit, w/ 9" post

The following installation accessories are for N17/N15/N12 only.

Part No.	Description
045-000915-00	N17/N15 rolling stand with mounting plate
045-000953-00	N12 quick release mount for rolling stand
045-000955-00	N17/N15 quick release mount for rolling stand
045-001190-00	N12 transport stand (MR) with GCX shoe
045-003297-00	N17/N15/N12 Mount Transition Plate
045-003240-00	N17/N15/N12 M Series 12" arm with Transition Plate
045-003253-00	N17/N15/N12 GCX VHM Series arm with Transition Plate
045-003255-00	N12 rolling stand with quick release mount
115-045865-00	N12 Bedrail Hook
045-003254-00	TDS cross clamp with 9" riser post (for N17/N15/N12)

The following installation accessories are for N22/N19 only.

Part No.	Description
034-000456-00	GCX VHM arm
034-000454-00	GCX M series arm, 16", with 6" riser
045-001976-00	Rotatory assembly kit for display
045-002198-00	Dock install to bracket package
115-033880-00	Host to GCX mounting kit
115-033871-00	Keyboard kit with 9" downpost
115-051379-00	Separate host & display mounting kit, for rotation
041-017853-00	Host mounting block

37.19 Miscellaneous Accessories

Part No.	Description
009-005121-00	SMR cable, 2m
009-005122-00	SMR cable, 10m
009-006593-00	N series to N1/T1 docking station cable, 2 m
009-005123-00	N series to N1/T1 docking station cable, 4 m
009-006594-00	N series to N1/T1 docking station cable, 10 m
009-009766-00	N series to N1/T1 docking station cable, 20 m
009-005391-00	MPM analog output and defib sync cable
8000-21-10361	Nurse call cable
023-001566-00	HP LaserJet Enterprise M608n, black and white
0683-00-0505-02	Recording paper, 50 mm*20 m, pkg of 12 A30-000001---
115-056983-00	Clinical Scoring Custom CD
115-055522-00	Field-installed iView module (N22/N19)
023-001788-00	External display, 21.5"(for N17/N15/N12)
115-049288-00	Display assembly kit, 22", with AC adapter and 5 m video cable (for N22)
115-049289-00	Display assembly kit, 19", with AC adapter and 5 m video cable (for N19)
115-034030-00	Display handle, without encoder (for N22/N19)
115-037270-00	Display handle, with encoder (for N22/N19)
009-005115-00	Video cable, 2.3 m (for N22/N19)
009-007740-00	Video cable, 5 m (for N22/N19)
009-005117-00	Video cable, 10 m (for N22/N19)
009-005118-00	USB cable, 2.3 m (for N22/N19)
009-008237-00	USB cable, 5 m (for N22/N19)
009-005120-00	USB cable, 10 m (for N22/N19)
115-018012-00	Lithium-ion battery, LI23S002A (for N17/N15/N12)
115-065138-00	Lithium-ion battery, LI23S002A (for N17/N15/N12)
115-034132-00	Lithium-ion battery, LI23S003A (for N22/N19)
DA8K-10-14452	Power cord, USA
1000-21-00122	Grounding cable
009-003648-00	Cable protecting tube
009-003903-00	Accessory management tape
023-000247-00	Keyboard, wired USB connector, black
023-000248-00	Mouse, wired USB connector, black
023-000524-00	Wireless keyboard and mouse set
023-000525-00	Wired keyboard and mouse set
115-039575-00	2D Barcode reader, HS-1M, JADAK
115-039635-00	2D Barcode reader, HS-1R, JADAK
115-045643-00	Remote control

Part No.	Description
042-007382-00	Cable management hook
034-000666-00	Barcode reader holder (for JADAK Barcode reader)

This page intentionally left blank.

A Product Specifications

A.1 Monitor Safety Specifications

The monitor is classified, according to IEC 60601-1: 2005:

Degree of protection against electrical shock	Type CF defibrillation proof for ECG, Resp, TEMP, IBP, SpO ₂ , C.O., NIBP, EEG, and NMT Type BF defibrillation proof for ScvO ₂ , CO ₂ , AG, BIS, RM, and rSO ₂
Type of protection against electrical shock	Class I
Degree of protection against harmful ingress of water	IPX1
Degree of safety of application in the presence of flammable anesthetic mixture with air or with oxygen or nitrous oxide	The equipment is not suitable for use in the presence of a flammable anesthetic mixture with air or with oxygen or nitrous oxide
Mode of operation	Continuous

A.2 Physical Specifications

A.2.1 BeneVision N22/N19

Item	Maximum Weight (kg)	W × H × D (mm)	Comments
N19 monitor (main unit and primary display installed together)	10.30	509 × 423 × 115 (display horizontally installed) 584 × 348 × 115 (display vertically installed)	Including the battery, iView module, Wi-Fi module, display with the handle and navigation knob. Excluding SMR, modules, and accessories.
N22 monitor (main unit and primary display installed together)	11.50	566 × 458 × 115 (display horizontally installed) 641 × 383 × 115 (display vertically installed)	Including the battery, iView module, Wi-Fi module, display with the handle and navigation knob. Excluding SMR, modules, and accessories.
Main unit	3.40	268 × 268 × 68	Including the battery.
Display, 19 inch	6.20	509 × 348 × 48	Excluding the handle.
Display, 22 inch	7.40	566 × 383 × 48	Excluding the handle.

A.2.2 BeneVision N17/N15/N12

Item	Maximum Weight (kg)	W × H × D (mm)	Comments
N17	7.3	466×355×210	Excluding iView module, Wi-Fi module, SMR, measurement modules, recorder, battery and accessories.
N15	5.4	396×313×193	
N12	4.1	313×290×161	

A.2.3 SMR and Modules

Item	Maximum Weight (kg)	W × H × D (mm)	Comments
Satellite module rack (SMR)	2.30	403 × 221 × 145	Including the handle and cable hooks.
MPM module	0.63	136.5 × 80.5 × 102	/
SpO ₂ module	0.29	136.5 × 40 × 102	Masimo SpO ₂ or Nellcor SpO ₂
Temp module	0.25	136.5 × 40 × 102	/
C.O. module	0.25	136.5 × 40 × 102	/
IBP module	0.26	136.5 × 40 × 102	/
CCO/SvO ₂ module	0.26	136.5 × 40 × 102	/
ScvO ₂ module	0.26	136.5 × 40 × 102	/
EEG module	0.28	136.5 × 40 × 102	/
BIS module	0.26	136.5 × 40 × 102	/
NMT module	0.29	136.5 × 40 × 102	/
rSO ₂ module	0.30	136.5 × 40 × 102	/
Microstream CO ₂ module	0.38	136.5 × 40 × 102	/
Sidestream CO ₂ module	0.63	136.5 × 40 × 102	/
AG module	1.03	136.5 × 80.5 × 102	With built-in O ₂ module
RM module	0.38	136.5 × 40 × 102	/
BeneLink module	0.35	136.5 × 40 × 102	/
Recorder	0.40	136.5 × 80.5 × 102	/

A.3 Environmental Specifications

WARNING

- The monitor may not meet the performance specifications if stored or used outside the specified temperature and humidity ranges. If the performance of the equipment is degraded due to aging or environmental conditions, contact your service personnel.
- When the monitor and related products have differing environmental specifications, the effective range for the combined products is that range which is common to the specifications for all products.

NOTE

- The environmental specification of unspecified parameter modules are the same as those of the main unit.

Components	Property (unit)	Operating Condition	Storage Condition
Main Unit	Temperature (°C)	0 to 35 (for N17 configured with iView module) 0 to 40 for other configuration	-20 to 60
	Relative humidity (noncondensing) (%)	15 to 95	10 to 95
	Barometric (mmHg)	427.5 to 805.5	120 to 805.5

Components	Property (unit)	Operating Condition	Storage Condition
Microstream CO ₂ module	Temperature (°C)	0 to 40	-20 to 60
	Relative humidity (noncondensing) (%)	15 to 95	10 to 95
	Barometric (mmHg)	430 to 790	430 to 790
Sidestream CO ₂ module	Temperature (°C)	5 to 40	-20 to 60
	Relative humidity (noncondensing) (%)	15 to 95	10 to 95
	Barometric (mmHg)	430 to 790	430 to 790
AG module	Temperature (°C)	10 to 40	-20 to 60
	Relative humidity (noncondensing) (%)	15 to 95	10 to 95
	Barometric (mmHg)	525 to 805.5	525 to 805.5
RM module	Temperature (°C)	5 to 40	-20 to 60
	Relative humidity (noncondensing) (%)	15 to 95	10 to 95
	Barometric (mmHg)	427.5 to 805.5	120 to 805.5
ScvO ₂ module	Temperature (°C)	10 to 40	-20 to 60
	Relative humidity (noncondensing) (%)	15 to 75	10 to 90
	Barometric (mmHg)	427.5 to 805.5	120 to 805.5
rSO ₂ module	Temperature (°C)	16 to 32	-20 to 70
	Relative humidity (noncondensing) (%)	20 to 80	10 to 95
	Barometric (mmHg)	525 to 805.5	435.7 to 822

A.4 Power Supply Specifications

A.4.1 External Power Supply Specifications

Line voltage	100 to 240 VAC (±10%)
Input Current	N22/N19: 2.8 A to 1.6 A N17/N15/N12: 2.0 A to 0.9 A
Frequency	50/60 Hz (± 3 Hz)

A.4.2 Battery Specifications

A.4.2.1 N22/N19 Battery Specifications

Battery type	Rechargeable lithium-ion battery
Voltage	10.8 VDC
Capacity	5600 mAh

Run time	At least 1 hour continuously on a typical configuration, powered by a new, fully-charged battery. Note: A typical configuration is 12-lead ECG, Resp, SpO ₂ , 4-channel IBP, 2-channel Temp, CO ₂ , C.O., and NIBP module set at an interval of 15 minutes. WI-Fi is enabled. The screen brightness is set to the factory default.
Charge time	For a new battery: 5 hours to 90% when the monitor is off 9 hours to 90% when the monitor is on.
Shutdown delay	At least 15 minutes (after a low battery alarm first occurs)

A.4.3 N17/N15/N12 Battery Specifications

Battery type	Rechargeable lithium-ion battery
Voltage	10.95 VDC
Capacity	4500 mAh
Run time	At least 2 hours continuously for N17/N15 or at least 4 hours continuously for N12 on a typical configuration, powered by a new, fully charged battery. The monitor is powered by a new, fully-charged battery at 25 °C with a 5-lead ECG and SpO ₂ cable connected, auto NIBP measurements at an interval of 15 minutes, and the screen brightness is set to 1.
Charge time	No more than 4.5 hours to 90% when the monitor is off No more than 10 hours to 90% when the monitor is on
Shutdown delay	At least 15 minutes (after a low battery alarm first occurs)

A.5 Display Specifications

Screen type	Medical-grade color TFT LCD
Screen Size (diagonal)	N22: 22 inches N19: 19 inches N17: 18.5 inches N15: 15.6 inches N12: 12.1 inches
Resolution	N22/N19: 1680 x 1050 pixels N17/N15: 1920 x 1080 pixels N12: 1280 x 800 pixels

A.6 Recorder Specifications

Method	Thermal dot array
Horizontal resolution	16 dots/mm (25 mm/s paper speed)
Vertical resolution	8 dots/mm
Paper width	50 mm
Paper length	20 m
Paper speed	25 mm/s, 50 mm/s Accuracy: ±5%
Number of waveform channels	A maximum of 3

A.7 LEDs

Alarm lamp	1 (three color-coded: red, yellow, and cyan)
Power-on LED	1 (green)
AC power LED	1 (green)
Battery LED	1 (two color-coded: yellow and green)

A.8 Audio Indicator

Speaker	Give alarm tones (45 to 85 dB), reminder tones, key tones, QRS tones; support PITCH TONE and multi-level tone modulation; alarm tones comply with IEC 60601-1-8:2012.
---------	---

A.9 Monitor Interface Specifications

A.9.1 Interface Specifications of the N22/N19 Main Unit

AC power input	1
Network connector (LAN1, LAN2, LAN3)	3 standard RJ45 connectors (one on the iView module), 100 Base-TX, IEEE 802.3
Serial bus connector (MSB)	6: 3 connectors and each connector contains 2 sub-connectors
USB connector	4, USB 2.0 (for iView only)
Satellite module rack (SMR) connector	3
Video output connector (VP1, VP2)	2, VP1 connects the secondary display (DisplayPort). VP2 connects the display for iView system (DisplayPort)
Nurse call connector (NC)	1, standard BNC
Equipotential grounding terminal	1
Primary display connectors	1 set (VP3, SIG1, MSB4, and DC-in), for connecting to separate primary display, hidden when the display is integrated with the main unit.

A.9.2 Interface Specifications of the N22/N19 Separate Primary Display

Serial bus connector (MSB)	3
Serial bus hub connector (SBH)	1
Signal input connector (SIG1)	1
DC-in connector	1
Video input connector (VP)	1

A.9.3 Interface Specifications of the N22/N19 Integrated Primary Display

Serial bus connector (MSB)	1
----------------------------	---

A.9.4 Interface Specifications of the N22/N19 Secondary Display

Serial bus connector (MSB)	3
Serial bus hub connector (SBH)	1

Signal input connector (SIG1)	1
DC-in connector	1
Video input connector (VP)	1

A.9.5 Interface Specifications of the N17/N15/N12

AC power input	1
Network connector	N17: 2 standard RJ45 connectors (one on the iView module) N15/N12: 1 standard RJ45 connector
USB connector	4, USB 2.0
Satellite module rack (SMR)/Docking station connector	1 (For N17/N15, it connects the SMR or the docking station. For N12, it connects the N1/T1 docking station)
Video output connector	N17: 2, (configuration A: 1 mirrored (DVI), 1 independent (DVI); configuration B: 1 mirrored (DVI), 1 iView (DVI).) N15/N12: 1 mirrored (DVI)
Nurse call connector	1, standard BNC
Equipotential grounding terminal	1

A.10 Signal Outputs Specifications

Auxiliary Output	
Standard	Meets the requirements of IEC 60601-1:2005 for short-circuit protection and leakage current
ECG Analog Output	
Bandwidth (-3dB; reference frequency: 10Hz)	Diagnostic mode: 0.05 to 150 Hz Monitor mode: 0.5 to 40 Hz Surgical mode: 1 to 20 Hz ST mode: 0.05 to 40 Hz
Maximum QRS delay	25 ms (in diagnostic mode, and non-paced)
Gain (reference frequency 10Hz)	1V/mV ($\pm 5\%$)
Pace enhancement	Signal amplitude: $V_{oh} \geq 2.5V$ Pulse width: $10ms \pm 5\%$ Signal rise and fall time: $\leq 100\mu s$
IBP Analog Output	
Bandwidth (-3dB; reference frequency: 1Hz)	0 to 40 Hz
Maximum transmission delay	30 ms
Gain (reference frequency 1 Hz)	1 V/100 mmHg, $\pm 5\%$
Nurse Call Signal	
Amplitude	High level: 3.5 to 5 V, $\pm 5\%$, providing a minimum of 10 mA output current; Low level: $< 0.5 V$, receiving a minimum of 5 mA input current.
Rise and fall time	$\leq 1 ms$
Defib Sync Pulse	
Output impedance	$\leq 100 \Omega$
Maximum time delay	35 ms (R-wave peak to leading edge of pulse)

Amplitude	High level: 3.5 to 5 V, $\pm 5\%$, providing a maximum of 10 mA output current; Low level: < 0.5 V, receiving a maximum of 5 mA input current.
Pulse width	100 ms $\pm 10\%$
Maximum rise and fall time	1 ms
Alarm output	
Alarm delay time from the monitor to remote equipment	The alarm delay time measured at the monitor signal output connector: From the monitor to the CMS and remote monitors: ≤ 2 seconds From the monitor to the TM80 telemetry monitor: ≤ 3 seconds
Alarm signal sound pressure level range	45 dB(A) to 85 dB(A) within a range of one meter

A.11 Data Storage

Trends	A minimum of 120 hours of trend data for trend interval as low as 1 minute.
Events	1000 events
NIBP measurements	1000 sets
Interpretation of resting 12-lead ECG results	20 sets
Full-disclosure waveforms	48 hours at maximum. The specific storage time depends on the waveforms stored and the number of stored waveforms.
ST view	A maximum of 120 hours of ST segment waveforms. One group of ST segment waveforms is stored every minute.
OxyCRG view	A maximum of 48 hours of oxyCRG events

A.12 Wi-Fi Specifications

A.12.1 Wi-Fi Technical Specifications (MSD45N)

Protocol	IEEE 802.11a/b/g/n
Modulation mode	BPSK, QPSK, 16QAM, 64QAM
Operating frequency	2.4 GHz to 2.495 GHz. 5.15 GHz to 5.25 GHz, 5.725 GHz to 5.85 GHz
Channel spacing	IEEE 802.11b/g: 5 MHz IEEE 802.11n (at 2.4 GHz): 5 MHz IEEE802.11a: 20 MHz IEEE802.11n (at 5 GHz): 20 MHz
Wireless data rate	IEEE 802.11b: 1 Mbps to 11 Mbps IEEE 802.11g: 6 Mbps to 54 Mbps IEEE 802.11n: 6.5 Mbps to 72.2 Mbps (MCS0-MCS7) IEEE 802.11a: 6 Mbps to 54 Mbps
Output power	<20 dBm (CE requirements, detection mode: RMS) <30 dBm (FCC requirements, detection mode: peak power)
Operating mode	As station, access AP for data transmission
Data security	Standards: WPA-PSK, WPA2-PSK, WPA-Enterprise, WPA2-Enterprise, WPA CCKM, WPA2 CCKM EAP method: EAP-FAST, EAP-TLS, EAP-TTLS, PEAP-GTC, PEAP-MSCHAPv2, PEAP-TLS, LEAP Encryption: AES

A.12.2 Wi-Fi Technical Specifications (SX-SDMAC-2832S+)

Protocol	IEEE 802.11a/b/g/n
Modulation mode	BPSK, QPSK, 16QAM, 64QAM
Operating frequency	2412 MHz to 2462 MHz 5180 MHz to 5320 MHz, 5500 MHz to 5700 MHz, 5745 MHz to 5825 MHz WARNIGN: SX-SDMAC-2832S+ supports the DFS channels. When using the DFS channels, Wi-Fi performance stability and roaming time can be undermined due to avoiding interfering with Radar systems. DFS channels are disabled by default and not recommended. The operator should comprehensively assess the risk before using the DFS channels.
Channel spacing	IEEE 802.11b/g: 5 MHz IEEE 802.11n (at 2.4 GHz): 5 MHz IEEE802.11a: 20 MHz IEEE802.11n (at 5 GHz): 20 MHz
Wireless data rate	IEEE 802.11b: 1 Mbps to 11 Mbps IEEE 802.11g: 6 Mbps to 54 Mbps IEEE 802.11n: MCS0 - MCS7 IEEE 802.11a: 6 Mbps to 54 Mbps
Output power	<20 dBm (CE requirements, detection mode: RMS) <30 dBm (FCC requirements, detection mode: peak power)
Operating mode	As station, access AP for data transmission
Data security	Standards: WPA-PSK, WPA2-PSK, WPA-Enterprise, WPA2-Enterprise, WPA CCKM, WPA2 CCKM EAP method: EAP-FAST, EAP-TLS, EAP-TTLS, PEAP-GTC, PEAP-MSCHAPv2, PEAP-TLS, LEAP Encryption: AES

A.12.3 Wi-Fi Performance Specifications

WARNING

- **All network functions of data communication are designed to operate on a private network.**
-
-

A.12.3.1 System Capacity

Number of the monitors supported by a single AP: ≤ 12 (for N22/N19) or ≤ 16 (for N17/N15/N12).

Testing conditions are as follows:

- Each monitor can communicate with the CMS.
- Two monitors are used to view other monitors.
- Only one monitor can transmit history data.
- The weakest strength of the AP signal where the monitor is located cannot be less than -65 dBm.

A.12.3.2 Resistance to Wireless Interference

The distance between the interfering devices and the monitor is greater than 20 cm. A Wi-Fi interference (no greater than -85 dBm) in the same channel and a Wi-Fi interference (no greater than -50 dBm) in an adjacent-channel are presented synchronously. The interfering devices include, but are not limited to, 2.4 GHz wireless devices, cellular mobile networks, microwave ovens, intercoms, cordless phones, and ESU equipment. The interfering devices do not include Wi-Fi devices.

The monitoring network must support the following requirements:

- All the monitors do not encounter communication loss.
- The total delay of data transmission from the monitor to the CMS: ≤ 2 seconds.
- The delay for monitor-related settings configured at the CMS to be effective: ≤ 2 seconds.

- The total delay of data transmission from one monitor to the other: ≤ 2 seconds.
- The delay for the monitor to reset alarms of another to be effective: ≤ 2 seconds.

A.12.3.3 Wi-Fi Network Stability

The ratio of the communication data loss on the CMS from any monitor does not exceed 0.1% over a 24-hour period.

Testing conditions are as follows:

- Number of the monitors supported by a single AP: ≤ 12 (for N22/N19) or ≤ 16 (for N17/N15/N12).
- For N17/N15/N12, 12 of the 16 monitors connected to the network roam for 30 times
- Each monitor can communicate with the CMS.
- Two monitors are used to view other monitors.
- Only one monitor can transmit history data.
- The weakest strength of the AP signal where the monitor is located cannot be less than -65 dBm.

A.12.3.4 Line of Sight Distance

The line of sight distance between the monitor and the AP is no less than 50 meters.

A.13 Measurement Specifications

The adjustable range of alarm limits is the same with the measurement range of signals unless otherwise specified.

A.13.1 ECG Specifications

ECG	
Standards	Meets the requirements of IEC 60601-2-27: 2011 and IEC 60601-2-25: 2011
Lead set	3-lead: I, II, III 5-lead: I, II, III, aVR, aVL, aVF, V 6-lead: I, II, III, aVR, aVL, aVF, Va, Vb 12-lead: I, II, III, aVR, aVL, aVF, V1 to V6
ECG standard	AHA, IEC
Display sensitivity	1.25 mm/mV (×0.125), 2.5 mm/mV (×0.25), 5 mm/mV (×0.5), 10 mm/mV (×1), 20 mm/mV (×2), 40 mm/mV (×4), Auto, less than 5% error
Sweep speed	6.25 mm/s, 12.5 mm/s, 25 mm/s, 50 mm/s, less than 5% error
Bandwidth (-3dB)	Diagnostic mode: 0.05 to 150 Hz Monitor mode: 0.5 to 40 Hz Surgery mode: 1 to 20 Hz ST mode: 0.05 to 40 Hz High frequency cut-off (for 12-lead ECG analysis): 350 Hz (0.05 to 350 Hz), 150 Hz (0.05 to 150 Hz), 35 Hz (0.05 to 35 Hz), 20 Hz (0.05 to 20 Hz) selectable
Common mode rejection ratio (with Notch filter off)	Diagnostic mode: >90 dB Monitor mode: >105 dB (with notch filter on) Surgery mode: >105 dB (with notch filter on) ST mode: >105 dB (with notch filter on)
Notch filter	50/60 Hz Monitor, surgical, and ST mode: notch filter turns on automatically Diagnostic mode and High Freq Cut-off: notch filter is turned on/off manually
Differential input impedance	≥5 MΩ
Input signal range	±8 mV (peak-to-peak value)

Accuracy of signal reproduction	Use A and D methods based on IEC 60601-2-25: 2011 to determine frequency response.
Electrode offset potential tolerance	±500 mV
Lead-off detection current	Measuring electrode: <0.1 µA Drive electrode: <1 µA
Input offset current	≤0.1 µA, (drive lead≤1µA)
Defibrillation protection	Withstands 5000V (360 J) charge without data loss or corruption Baseline recovery time: <5 s Polarization recovery time: <10 s Defibrillation energy absorption: ≤10% (100 Ω load)
Patient leakage current	<10 uA
Calibration signal	1mV (peak-to-peak value) ±5%
ESU protection	Cut mode: 300 W Coagulate mode: 100 W Recovery time: ≤10 s In compliance with the requirements in clause 202.6.2.101 of IEC 60601-2-27: 2011
Pace Pulse	
Pace pulse markers	Pace pulses meeting the following conditions are labelled with a PACE marker: Amplitude: ±2 mV to ±700 mV Width: 0.1 ms to 2 ms Rise time: 10 µs to 100 µs (< 10% of pulse width) No overshoot
Pace pulse rejection	When tested in accordance with the IEC 60601-2-27: 2011: 201.12.1.101.13, the heart rate meter rejects all pulses meeting the following conditions. Amplitude: ±2 mV to ±700 mV Width: 0.1 ms to 2 ms Rise time: 10 µs to 100 µs (< 10% of pulse width) No overshoot

HR	
Measurement range	Neonate: 15 to 350 bpm Pediatric: 15 to 350 bpm Adult: 15 to 300 bpm
Resolution	1 bpm
Accuracy	±1 bpm or ±1%, whichever is greater.
Sensitivity	200 µV (lead II)
HR averaging method	In compliance with the requirements in Clause 201.7.9.2.9.101 b) 3) of IEC 60601-2-27: 2011, the following method is used: If the last 3 consecutive RR intervals are greater than 1200 ms, the 4 most recent RR intervals are averaged to compute the HR. Otherwise, heart rate is computed by subtracting the maximum and minimum ones from the most recent 12 RR intervals and then averaging the remaining 10 RR intervals. The HR value displayed on the monitor screen is updated every second.
Response to irregular rhythm	In compliance with the requirements in Clause 201.7.9.2.9.101 b) 4) of IEC 60601-2-27: 2011, the heart rates for the specified test signals after 20 seconds of stabilization are: Ventricular bigeminy (waveform A1): 80±1 bpm Slow alternating ventricular bigeminy (waveform A2): 60±1 bpm Rapid alternating ventricular bigeminy (waveform A3): 120±1 bpm Bidirectional systoles (waveform A4): 90±2 bpm

Response time to heart rate change	Meets the requirements of IEC 60601-2-27: 2011: Clause 201.7.9.2.9.101 b) 5). From 80 to 120 bpm: less than 11 s From 80 to 40 bpm: less than 11 s
Time to alarm for tachycardia	Meets the requirements in Clause 201.7.9.2.9.101 b) 6) of IEC 60601-2-27: 2011. Waveform B1h-range: <11 s B1-range: <11 s B1d-range: <11 s B2h-range: <11 s B2-range: <11 s B2d-range: <11 s
Tall T-wave rejection capability	When the test is performed based on Clause 201.12.1.101.17 of IEC 60601-2-27: 2011, the heart rate calculation is not affected for QRS of 1 mV amplitude and 100 ms duration, T-wave duration of 180 ms and amplitude lower than 1.2 mV, and QT interval of 350 ms.
Arrhythmia Analysis Classifications	Asystole, V-Fib/V-Tach, V-Tach, Vent Brady, Extreme Tachy, Extreme Brady, Vent Rhythm, PVCs/min, Pauses/min, Couplet, Bigeminy, Trigeminy, R on T, Run PVCs, PVC, Tachy, Brady, Missed Beats, Pacer Not Pacing, Pacer Not Capture, Multiform PVC, Nonsus V-Tach, Pause, Irr Rhythm, A-Fib
ST Segment Analysis	
Measurement range	-2.0 mV to +2.0 mV RTI
Accuracy	-0.8 mV to +0.8 mV: ± 0.02 mV or $\pm 10\%$, whichever is greater Beyond this range: not specified
Resolution	0.01mV
QT/QTc Analysis	
Measurement range	QT: 200 to 800 ms QTc: 200 to 800 ms QT-HR: 15 bpm to 150 bpm for adult, 15 bpm to 180 bpm for pediatric and neonate
Accuracy	QT: ± 30 ms
Resolution	QT: 4 ms QTc: 1 ms
12-lead ECG Interpretation	
Sampling rate	1000 samples/s (A/D) 500 samples/s (ECG algorithm)
Amplitude quantisation	24 bits

Alarm limit	Range	Step
HR High	HR \leq 40bpm: (low limit + 2 bpm) to 40 bpm HR > 40 bpm: (low limit + 5 bpm) to 295 bpm (Adult/Pediatric) (low limit + 5 bpm) to 300 bpm (Neonate)	HR \leq 40bpm: 1 bpm HR > 40 bpm: 5 bpm
HR Low	HR \leq 40bpm: 16 bpm to (high limit - 2 bpm) (Adult/Pediatric) 15 bpm to (high limit - 2 bpm) (Neonate) HR > 40 bpm: 40 bpm to (high limit - 5 bpm)	
ST High	(low limit + 0.2 mV) to 2.0 mV (ST alarm mode: Absolute) 0 mV to 2.0 mV (ST alarm mode: Relative)	0.05 mV
ST Low	-2.0 mV to (high limit - 0.2 mV) (ST alarm mode: Absolute) -2.0 mV to 0 mV (ST alarm mode: Relative)	

QTc High	200 ms to 800 ms	10 ms
ΔQTc High	30 ms to 200 ms	

A.13.2 Resp Specifications

Technique	Trans-thoracic impedance	
Lead	Options are lead I, II, and Auto.	
Respiration excitation waveform	<300 μA RMS, 62.8 kHz (±10%)	
Minimum respiration impedance threshold	0.3Ω	
Baseline impedance range	200 to 2500 Ω (using an ECG cable with 1kΩ resistance)	
Bandwidth	0.2 to 2.5 Hz (-3 dB)	
Sweep speed	3mm/s, 6.25 mm/s, 12.5 mm/s, 25 mm/s or 50 mm/s, less than 10% error	
Respiration Rate		
Measurement range	Adult: 0 to 120 rpm Pediatric, neonate: 0 to 150 rpm	
Resolution	1 rpm	
Accuracy	7 to 150 rpm: ±2 rpm or ±2%, whichever is greater 0 to 6 rpm: not specified	
Apnea alarm delay	10 s, 15 s, 20 s, 25 s, 30 s, 35 s, 40 s	
Alarm limit	Range (rpm)	Step (rpm)
RR High	Adult, pediatric: RR≤20 (low limit + 2) to 20 RR>20 (low limit + 5) to 100 Neonate: RR≤20 (low limit + 2) to 20 RR>20 (low limit + 5) to 150	RR≤20: 1 RR>20: 5
RR Low	RR≤20: 0 to (high limit - 2) RR>20: 20 to (high limit - 5)	

A.13.3 SpO₂ Specifications

Refer to Appendix F *SpO₂ Sensor Accuracy* for the clinical study results of SpO₂ sensor accuracy.

Alarm limit	Range (%)	Step (%)
SpO ₂ High	(low limit + 2) to 100	1
SpO ₂ Low	Masimo: (Desat+1) to (high limit - 2) Nellcor: (Desat+1) or 20 (whichever is greater) to (high limit - 2)	
ΔSpO ₂ High	0 to 50	
SpO ₂ Desat Low	0 to (SpO ₂ low limit - 1)	

Masimo SpO₂ Module

Standards	Meets the requirements of ISO 80601-2-61: 2017
Measurement range	1 to 100%
Resolution	1%

Response time	≤20 s (normal perfusion, no disturbance, SpO ₂ value sudden change from 70% to 100%)
Accuracy ¹	70 to 100%: ±2%ABS (adult/pediatric, without motion) 70 to 100%: ±3%ABS (adult/pediatric, with motion) 70 to 100%: ±3%ABS (neonate) 1% to 69%: Not specified.
Refresh rate	≤ 1 s
SpO ₂ averaging time	2-4 s, 4-6 s, 8 s, 10 s, 12 s, 14 s, 16 s
Low perfusion conditions	Pulse amplitude: >0.02% Light penetration: >5%
Low perfusion SpO ₂ accuracy ²	±2%
PI measurement range	0.02 to 20%
<p>¹ The Masimo pulse oximeter with sensors have been validated for no motion accuracy in human blood studies on healthy adult volunteers in induced hypoxia studies in the range of 70% to 100% SpO₂ against a laboratory co-oximeter and ECG monitor. This variation equals plus or minus one standard deviation. Plus or minus one standard deviation encompasses 68% of the population. One percent was added to the accuracies for neonatal sensors to account for accuracy variation due to properties of fetal hemoglobin.</p> <p>The Masimo pulse oximeter with sensors has been validated for motion accuracy in human blood studies on healthy adult volunteers in induced hypoxia studies while performing rubbing and tapping motions at 2 to 4 Hz. At an amplitude of 1 to 2 cm and non-repetitive motion between 1 to 5 Hz. At an amplitude of 2 to 3 cm in induced hypoxia studies in the range of 70% to 100% SpO₂ against a laboratory co-oximeter and ECG monitor. This variation equals plus or minus one standard deviation. Plus or minus one standard deviation encompasses 68% of the population.</p> <p>² The Masimo pulse oximeter has been validated for low perfusion accuracy in bench top testing against a Biotek Index 2 simulator and Masimo's simulator with signal strengths of greater than 0.02% and a % transmission of greater than 5% for saturations ranging from 70 to 100%. This variation equals plus or minus one standard deviation. Plus or minus one standard deviation encompasses 68% of the population.</p>	

Nellcor SpO₂ Module

Standard	Meet the requirements of ISO 80601-2-61 2017
Measurement range	0 to 100%
Resolution	1%
Refresh rate	≤1 s
Response time	≤30 s (normal perfusion, no disturbance, SpO ₂ value sudden changes from 70% to 100%)
Accuracy	70 to 100%: ±2%ABS (adult/pediatric) 70 to 100%: ±3%ABS (neonate) 0 to 69%: Not specified.
When the SpO ₂ sensor is applied for neonatal patients as indicated, the specified accuracy range is increased by ±1%, to compensate for the theoretical effect on oximeter measurements of fetal hemoglobin in neonatal blood.	

A.13.4 PR Specifications

Alarm limit	Range (bpm)	Step (bpm)
PR High	PR≤40: (low limit + 2) to 40 PR > 40: (low limit + 5) to 295 (Adult/Pediatric), (low limit + 5) to 300 (Neonate)	PR≤40: 1 PR>40: 5
PR Low	PR≤40: 16 to (high limit - 2) (Adult/Pediatric), 15 to (high limit - 2) (Neonate) PR > 40: 40 to (high limit - 5)	

PR from Masimo SpO₂

Measurement range	25 to 240 bpm
Resolution	1 bpm
Response time	≤20 s (with normal perfusion, no disturbance, and a PR value transition from 25 to 220 bpm)
Accuracy	±3 bpm (without motion) ±5 bpm (with motion)
Refresh rate	≤1 s

PR from Nellcor SpO₂

Measurement range	20 to 300 bpm
Resolution	1 bpm
Response time	≤30 s (with normal perfusion, no disturbance, and a PR value transition from 25 to 250 bpm)
Accuracy	20 to 250 bpm: ±3 bpm 251 to 300 bpm: not specified
Refresh rate	≤1 s

PR from NIBP

Measurement range	30 to 300 bpm
Resolution	1 bpm
Accuracy	±3 bpm or ±3%, whichever is greater

PR from IBP

Measurement range	25 to 350 bpm
Resolution	1 bpm
Accuracy	±1 bpm or ±1%, whichever is greater

A.13.5 Temp Specifications

Standard	Meets the requirements of ISO 80601-2-56: 2009	
Technique	Thermal resistance	
Operating mode	Direct mode	
Measurement range	0 to 50 °C (32 to 122 °F)	
Resolution	0.1°C	
Accuracy	±0.1 °C or ±0.2 °F (excluding probe error)	
Minimum time for accurate measurement	Body surface: <100 s Body cavity: <80 s	
Alarm limit	Range	Step

Txx High (xx refers to temperature site)	(low limit +1.0) to 50.0 °C (low limit +2.0) to 122.0 °F	0.1 °C 0.1 °F
Txx Low (xx refers to temperature site)	0.1 to (high limit - 1.0) °C 32.2 to (high limit - 2.0) °F	
ΔT High	0.1 to 50.0 °C 0.2 to 90.0 °F	

A.13.6 NIBP Specifications

Standard	Meets the requirements of IEC 80601-2-30: 2013			
Technique	Oscillometry			
Mode of operation	Manual, Auto, STAT, Sequence			
Auto mode repetition intervals	1, 2, 2.5, 3, 5, 10, 15, 20, 30, 60, 90, 120, 180, 240 or 480 min			
STAT mode cycle time	5 min			
Max measurement time	Adult, pediatric: 180 s Neonate: 90 s			
Heart rate range	30 to 300 bpm			
Measurement ranges (mmHg)		Adult	Pediatric	Neonate
	Systolic:	25 to 290	25 to 240	25 to 140
	Diastolic:	10 to 250	10 to 200	10 to 115
	Mean:	15 to 260	15 to 215	15 to 125
Accuracy	Max mean error: ±5 mmHg Max standard deviation: 8 mmHg			
Resolution	1 mmHg			
Initial cuff inflation pressure range (mmHg)	Adult: 80 to 280 Pediatric: 80 to 210 Neonate: 60 to 140			
Default initial cuff inflation pressure (mmHg)	Adult: 160 Pediatric: 140 Neonate: 90			
Software overpressure protection	Adult: 297±3 mmHg Pediatric: 297±3 mmHg Neonate: 147±3 mmHg			
Static pressure measurement range	0 mmHg to 300 mmHg			
Static pressure measurement accuracy	±3 mmHg			
Alarm limit	Range (mmHg)		Step (mmHg)	

NIBP-S High	Adult: (low limit + 5) to 285 Pediatric: (low limit + 5) to 235 Neonate: (low limit + 5) to 135	NIBP ≤ 50: 1 NIBP > 50: 5
NIBP-S Low	26 to (high limit - 5)	
NIBP-M High	Adult: (low limit + 5) to 255 Pediatric: (low limit + 5) to 210 Neonate: (low limit + 5) to 120	
NIBP-M Low	16 to (high limit - 5)	
NIBP-D High	Adult: (low limit + 5) to 245 Pediatric: (low limit + 5) to 195 Neonate: (low limit + 5) to 110	
NIBP-D Low	11 to (high limit - 5)	
NIBP-S Extreme High	NIBP-S high limit < 50 Adult: (NIBP-S high limit + 1) to 290 Pediatric: (NIBP-S high limit + 1) to 240 Neonate: (NIBP-S high limit + 1) to 140 NIBP-S high limit ≥ 50 Adult: (NIBP-S high limit + 5) to 290 Pediatric: (NIBP-S high limit + 5) to 240 Neonate: (NIBP-S high limit + 5) to 140	NIBP ≤ 50: 1 NIBP > 50: 5
NIBP-S Extreme Low	NIBP-S low limit ≤ 50 25 to (NIBP-S low limit - 1) NIBP-S low limit > 50 25 to (NIBP-S low limit - 5)	
NIBP-M Extreme High	NIBP-M high limit < 50 Adult: (NIBP-M high limit + 1) to 260 Pediatric: (NIBP-M high limit + 1) to 215 Neonate: (NIBP-M high limit + 1) to 125 NIBP-M high limit ≥ 50 Adult: (NIBP-M high limit + 5) to 260 Pediatric: (NIBP-M high limit + 5) to 215 Neonate: (NIBP-M high limit + 5) to 125	NIBP ≤ 50: 1 NIBP > 50: 5
NIBP-M Extreme Low	NIBP-M low limit ≤ 50 15 to (NIBP-M low limit - 1) NIBP-M low limit > 50 15 to (NIBP-M low limit - 5)	
NIBP-D Extreme High	NIBP-D high limit < 50 Adult: (NIBP-D high limit + 1) to 250 Pediatric: (NIBP-D high limit + 1) to 200 Neonate: (NIBP-D high limit + 1) to 115 NIBP-D high limit ≥ 50 Adult: (NIBP-D high limit + 5) to 250 Pediatric: (NIBP-D high limit + 5) to 200 Neonate: (NIBP-D high limit + 5) to 115	NIBP ≤ 50: 1 NIBP > 50: 5
NIBP-D Extreme Low	NIBP-D low limit ≤ 50 10 to (NIBP-D low limit - 1) NIBP-D low limit > 50 10 to (NIBP-D low limit - 5)	

*Measurement accuracy verification: In adult and pediatric modes, the blood pressure measurements measured with this device are in compliance with the Standard for Non-invasive sphygmomanometers (ISO 81060-2: 2013) in terms of mean error and standard deviation by comparing with intra-arterial or auscultatory measurements (depending on the configuration) in a typical patient population. For auscultatory reference, the 5th Korotkoff sound was used to determine the diastolic pressure.

In neonatal mode, the blood pressure measurements measured with this device are in compliance with the American National Standard for Non-invasive sphygmomanometers (ISO 81060-2) in terms of mean error and standard deviation by comparing with intra-arterial measurements (depending on the configuration) in a typical patient population.

A.13.7 IBP Specifications

Standard	Meets the requirements of IEC 60601-2-34: 2011	
Technique	Direct invasive measurement	
IBP		
Measurement range	-50 to 300 mmHg	
Resolution	1 mmHg	
Accuracy	±2% or ±1 mmHg, whichever is greater (excluding sensor error)	
PPV		
Measurement range	0% ~ 50%	
Pressure transducer		
Excitement voltage	5 VDC, ±2%	
Sensitivity	5 µV/V/mmHg	
Zero adjustment range	±200 mmHg	
Impedance range	300 to 3000Ω	
Volume displacement	<0.04 mm ³ /100 mmHg	
Alarm limit	Range (mmHg)	Step (mmHg)
Sys High	IBP ≤ 50: (low limit + 2) to 50 IBP > 50: (low limit + 5) to 295	IBP ≤ 50: 1 IBP > 50: 5
Mean High		
Dia High		
Sys Low	IBP ≤ 50: -49 to (high limit - 2) IBP > 50: 50 to (high limit - 5)	
Mean Low		
Dia Low		
Art-S Extreme High	High limit < 50: (High limit+ 1) to 300 High limit ≥ 50: (High limit+ 5) to 300	IBP ≤ 50: 1 IBP > 50: 5
Art-M Extreme High		
Art-D Extreme High		
Art-S Extreme Low	low limit ≤ 50: -50 to (low limit- 1) low limit > 50: -50 to (low limit- 5)	
Art-M Extreme Low		
Art-D Extreme Low		

A.13.8 C.O. Specifications

Measurement method	Thermodilution method
--------------------	-----------------------

Measurement range	C.O.:	0.1 to 20 L/min
	TB:	23 to 43 °C
	TI:	0 to 27 °C
Resolution	C.O.:	0.1 L/min
	TB, TI:	0.1 °C (excluding sensor)
Accuracy	C.O.:	±5% or ±0.1 L/min, whichever is greater
	TB, TI:	±0.1 °C (excluding sensor)
Repeatability	C.O.:	±2% or ±0.1 L/min, whichever is greater
Alarm range	TB:	23 to 43 °C
Alarm limit	Range	Step
TB High	(low limit + 1) to 43 °C (low limit + 2) to 109.4 °F	0.1 °C 0.1 °F
TB Low	23 to (high limit - 1) °C 73.4 to (high limit - 2) °F	

A.13.9 ScvO₂/SvO₂ Specifications from the Edwards Monitor

Operating mode	Interfaces with Edwards Vigilance II®, Vigileo™ monitor, EV1000, or HemoSphere monitor
Measured parameters	Consistent with SvO ₂ /ScvO ₂ -related parameters output by Vigilance II®, Vigileo™ monitor, EV1000, or HemoSphere monitor
Parameter alarms	SvO ₂ , ScvO ₂
Signal Output	
Standard	Meets the requirements of IEC 60601-1 for short-circuit protection and leakage current
Output impedance	≤1000Ω
Isolation voltage	1500 VAC
SpO₂ Analog Signal Output	
Output voltage	0 to 10V (0 to 100%)
Output voltage error	±5%

Alarm Limit	Range	Step
SvO ₂ /ScvO ₂ High	ScvO ₂ <60%: (Low limit + 5%) to 60% ScvO ₂ ≥60%: (Low limit + 1%) to 99%	ScvO ₂ <60%: 5% ScvO ₂ ≥60%: 1%
SvO ₂ /ScvO ₂ Low	ScvO ₂ <60%: 0 to (High limit - 5%) ScvO ₂ ≥60%: 60% to (Low limit - 1%)	

A.13.10 CCO Specifications from the Edwards Monitor

Operating mode	Interfaces with Edwards Vigilance II®, Vigileo™ monitor, EV1000, or HemoSphere monitor
Measured parameter	Consistent with CCO-related parameters output by Vigilance II®, Vigileo™ monitor, EV1000, or HemoSphere monitor
Parameter alarm	CCO, CCI

Signal Outputs

Standard	Meets the requirements of IEC 60601-1 for short-circuit protection and leakage current
Output impedance	≤1000Ω
Isolation voltage	1500 VAC
ECG Analog Output	
Bandwidth (-3dB; reference frequency: 10Hz)	Diagnostic mode: 0.05~150Hz Monitor mode: 0.5~40Hz Surgery mode: 1~20Hz ST mode: 0.05~40Hz
Sensitivity	2 V/mV ±5%
MAP Analog Signal Output	
Output voltage	0 to 5 V (0 to 500 mmHg)
Output voltage error	±5%
CVP Analog Signal Output	
Output voltage	0 to 5 V (0 to 100 mmHg)
Output voltage error	±5%

Alarm Limit	Range	Step
CCO High	(Low limit + 0.1) to 25 L/min	0.1 L/min
CCO Low	0.3 to (high limit - 0.1)L/min	
CCI High	(Low limit + 0.1) to 15 L/min/m ²	0.1 L/min/m ²
CCI Low	0.1 to (high limit - 0.1)L/min/m ²	

A.13.11 ScvO₂ Specifications

Measured parameters	Measurement range	Measurement accuracy
ScvO ₂	0 to 99%	50% to 80%: ±3% Other ranges: Not specified.
Alarm Limit	Range	Step
ScvO ₂ High	ScvO ₂ <60%: (Low limit + 5%) to 60% ScvO ₂ ≥60%: (Low limit + 1%) to 99%	ScvO ₂ <60%: 5% ScvO ₂ ≥60%: 1%
ScvO ₂ Low	ScvO ₂ <60%: 0 to (High limit - 5%) ScvO ₂ ≥60%: 60% to (High limit - 1%)	

A.13.12 CO₂ Specifications

Measurement mode	Sidestream, microstream	
Technique	Infrared absorption	
Apnea delay	10 s, 15 s, 20 s, 25 s, 30 s, 35 s, 40 s	
Alarm limit	Range	Step

EtCO ₂ High	(low limit + 2) to 99 mmHg	1 mmHg
EtCO ₂ Low	1 to (high limit - 2) mmHg	
FiCO ₂ High	1 to 99 mmHg	

Sidestream CO₂ Module

Standard	Meets the requirements of ISO 80601-2-55: 2011	
CO ₂ Measurement range	0 to 150 mmHg	
CO ₂ absolute accuracy*	Full accuracy mode: 0 - 40 mmHg: ±2mmHg 41 - 76 mmHg: ±5% of reading 77 - 99 mmHg: ±10% of reading 100 - 150mmHg: ±(3mmHg + 8% of reading) ISO accuracy mode: Add ±2mmHg to the full accuracy mode	
Accuracy specifications are affected by the breath rate and I:E. The EtCO ₂ accuracy is within specification for breath rate ≤ 60 rpm and I/E ratio ≤ 1:1, or breath rate ≤ 30 rpm and I/E ratio ≤ 2:1.		
CO ₂ resolution	1 mmHg	
O ₂ measurement range	0 to 100%	
O ₂ absolute accuracy	0 ≤ O ₂ concentration ≤ 25%:	±1%
	25 < O ₂ concentration ≤ 80%:	±2%
	80 < O ₂ concentration ≤ 100%:	±3%
O ₂ resolution	1%	
Accuracy drift	Meets the requirements for measurement accuracy within 6 hours	
Sample flowrate	For CO ₂ measurement (with O ₂ measurement): Connected a DRYLINE II watertrap for adult and pediatric patient: 120 ml/min Connected a DRYLINE II watertrap for neonatal patient: 90 ml/min For CO ₂ measurement (without O ₂ measurement): Connected a DRYLINE II watertrap for adult and pediatric patient: 120 ml/min Connected a DRYLINE II watertrap for neonatal patient: 70 ml/min, 90 ml/min	
Sample flowrate tolerance	±15% or ±15 ml/min, whichever is greater.	
Start-up time	Maximum: 90 s	

Rise time	<p>For CO₂ measurement (without O₂ measurement):</p> <p>Measured with a DRYLINE II neonatal watertrap and a 2.5-meter neonatal sampling line:</p> <p>≤250 ms@70 ml/min ≤250 ms@90 ml/min</p> <p>Measured with a DRYLINE II adult watertrap and a 2.5-meter adult sampling line:</p> <p>≤300 ms@120 ml/min</p> <p>For CO₂ measurement (with O₂ measurement):</p> <p>Measured with a DRYLINE II neonatal watertrap and a 2.5-meter neonatal sampling line:</p> <p>≤250 ms@90 ml/min</p> <p>Measured with a DRYLINE II adult watertrap and a 2.5-meter adult sampling line:</p> <p>≤300 ms@120 ml/min</p> <p>Measured with a DRYLINE II adult watertrap and a 2.5-meter adult sampling line (using with the RM module):</p> <p>≤240 ms@150 ml/min</p> <p>For O₂ measurements:</p> <p>Measured with a DRYLINE II neonatal watertrap and a 2.5-meter neonatal sampling line:</p> <p>≤800 ms@90 ml/min</p> <p>Measured with a DRYLINE II adult watertrap and a 2.5-meter adult sampling line:</p> <p>≤750 ms@120 ml/min</p> <p>Measured with a DRYLINE II adult watertrap and a 2.5-meter adult sampling line (using with the RM module):</p> <p>≤650 ms@150 ml/min</p>
Response time	<p>For CO₂ measurement (without O₂ measurement):</p> <p>Measured with a DRYLINE II neonatal watertrap and a 2.5-meter neonatal sampling line:</p> <p>≤5.0 s @ 70 ml/min ≤4.5 s @ 90 ml/min</p> <p>Measured with a DRYLINE II adult watertrap and a 2.5-meter adult sampling line:</p> <p>≤5.0 s @ 120 ml/min</p> <p>For CO₂ measurement (with O₂ measurement):</p> <p>Measured with a DRYLINE II neonatal watertrap and a 2.5-meter neonatal sampling line:</p> <p>≤4.5 s@90 ml/min</p> <p>Measured with a DRYLINE II adult watertrap and a 2.5-meter adult sampling line:</p> <p>≤5 s@120 ml/min</p> <p>Measured with a DRYLINE II adult watertrap and a 2.5-meter adult sampling line (using with the RM module):</p> <p>≤4.5 s@150 ml/min</p> <p>For O₂ measurements:</p> <p>Measured with a DRYLINE II neonatal watertrap and a 2.5-meter neonatal sampling line:</p> <p>≤4.5 s @ 90 ml/min</p> <p>Measured with a DRYLINE II adult watertrap and a 2.5-meter adult sampling line:</p> <p>≤5 s@120 ml/min</p> <p>Measured with a DRYLINE II adult watertrap and a 2.5-meter adult sampling line (using with the RM module):</p> <p>≤4.5 s@150 ml/min</p>
awRR measurement range	0 to 150 rpm
awRR measurement precision	≤60 rpm: ±1 rpm 61 to 150 rpm: ±2 rpm
awRR resolution	1 rpm
Data sample rate	50 Hz

Effect of interference gases on CO ₂ measurements		
Gas	Concentration (%)	Quantitative effect*
N ₂ O	≤60	±1 mmHg
Hal	≤4	
Sev	≤5	
Iso	≤5	
Enf	≤5	
Des	≤15	±2 mmHg
*: means an extra error should be added in case of gas interference when CO ₂ measurements are performed between 0 to 40mmHg.		
Effect of interference gases on O ₂ measurements		
Gas	Quantitative effect	
CO ₂	±0.2%	
N ₂ O	±0.2%	
Hal, Des, Sev, Iso, Enf	±1.0%	

Microstream CO₂ Module

Standard	Meets the requirements of ISO 80601-2-55: 2011	
CO ₂ Measurement range	0 to 99 mmHg	
Accuracy*	0 to 38 mmHg:	±2 mmHg
	39 to 99 mmHg:	±5% of the reading (0.08% of the reading increased in error for every 1 mmHg if the reading is more than 38 mmHg)
Accuracy drift	Meets the requirements for measurement accuracy within 6 hours	
* Accuracy applies for respiration rate up to 80 rpm. For respiration rate above 80 rpm and EtCO ₂ exceeding 18 mmHg, the accuracy is 4 mmHg or ±12% of the reading, whichever is greater. For respiration rate above 60 rpm, the above accuracy can be achieved by using the FilterLine H Set for Infant/Neonatal. In the presence of interfering gases, the above accuracy is maintained to within 4%.		
Resolution	1 mmHg	
Sample flow rate	50 (-7.5/+15) ml/min	
Initialization time	Maximum 180 s	
Response time	4.3 s (with any 2-meter FilterLine) 5.5 s (with any 4-meter FilterLine)	
Rise time	190 msec (with any 2-meter FilterLine) 210 msec (with any 4-meter FilterLine)	
awRR measurement range	0 to 150 rpm	
awRR measurement accuracy	0 to 70 rpm:	±1 rpm
	71 to 120 rpm:	±2 rpm
	121 to 150 rpm:	±3 rpm
awRR resolution	1 rpm	
Data sample rate	40 Hz	

A.13.13 AG Specifications

Standard	meets the requirements of ISO 80601-2-55: 2011	
Technique	Infrared absorption, paramagnetic properties for O ₂ monitoring	
Warm-up time	Iso accuracy mode:	≤45 s
	Full accuracy mode:	≤10 min
Sample flow rate	Adult, pediatric:	200 ml/min
	Neonate:	120 ml/min
	Accuracy:	±10 ml/min or ±10%, whichever is greater
Measurement range	CO ₂ :	0 to 30%
	O ₂ :	0 to 100%
	N ₂ O:	0 to 100%
	Des:	0 to 30%
	Sev:	0 to 30%
	Enf:	0 to 30%
	Iso:	0 to 30%
	Hal:	0 to 30%
	awRR:	2 to 100 rpm
Resolution	CO ₂ :	0.1%
	O ₂ :	1%
	N ₂ O:	1%
	Des:	0.1%
	Sev:	0.1%
	Enf:	0.1%
	Iso:	0.1%
	Hal:	0.1%
	awRR:	1 rpm
Iso accuracy	As full accuracy specifications, but derated as follows: Add ±0.3% _{ABS} to accuracy for CO ₂ Add ±8% _{REL} to accuracy for all anesthetic gases N ₂ O accuracy is ±(8% _{REL} +2% _{ABS})	

Full accuracy	Gases	Range (%REL) ¹	Accuracy (%ABS)
	CO ₂	0≤CO ₂ ≤1 1<CO ₂ ≤5 5<CO ₂ ≤7 7<CO ₂ ≤10 CO ₂ >10	±0.1 ±0.2 ±0.3 ±0.5 Not specified
	N ₂ O	0≤NO ₂ ≤20 20<NO ₂ ≤100	±2 ±3
	O ₂	0 to 25 25 to 80 80 to 100	±1 ±2 ±3
	Des	0 to 1 1 to 5 5 to 10 10 to 15 15 to 18 >18	±0.15 ±0.2 ±0.4 ±0.6 ±1 Not specified
	Sev	0 to 1 1 to 5 5 to 8 >8	±0.15 ±0.2 ±0.4 Not specified
	Enf, Iso, Hal	0 to 1 1 to 5 >5	±0.15 ±0.2 Not specified
	awRR	2 to 60 rpm >60 rpm	±1 rpm Not specified
	Note ¹ : The highest GAS LEVEL for a single halogenated anaesthetic gas in a gas mixture that is concealed when the anaesthetic concentration falls is 0.15/0.3% (Full/ISO accuracy).		
Accuracy drift	Meet the requirement for measurement accuracy within 6 hours		
Apnea alarm delay	10 s, 15 s, 20 s, 25 s, 30 s, 35 s, 40 s		
Refresh rate	1 s		
Rise time (10% ~ 90%)	Gas sample flow rate 120ml/min, using a DRYLINE II neonatal watertrap and sampling line (2.5m):		
	CO ₂ : ≤250 ms N ₂ O: ≤250 ms Hal, Iso, Sev, Des: ≤300 ms Enf: ≤350 ms O ₂ : ≤600 ms		
	Gas sample flow rate 200 ml/min, using the adult DRYLINE II water trap and sampling line (2.5 m):		
	CO ₂ : ≤250 ms N ₂ O: ≤250 ms Hal, Iso, Sev, Des: ≤300 ms Enf: ≤350 ms O ₂ : ≤500 ms		
Delay time	<4 s		

Response time	Measured with a DRYLINE II neonatal watertrap and a 2.5-meter neonatal sampling line:				
	120 ml/min: CO ₂ : ≤4s N ₂ O: ≤4.2s O ₂ : ≤4s Hal, Iso, Sev, Des, Enf: ≤4.4s				
Anesthetic agent limit	Measured with a DRYLINE II adult watertrap and a 2.5-meter adult sampling line:				
	200 ml/min: CO ₂ : ≤4.2s N ₂ O: ≤4.3s Hal, Iso, Sev, Des, Enf: ≤4.5s O ₂ : ≤4s				
Anesthetic agent limit	Primary anesthetic agent In full accuracy mode: 0.15%				
	Secondary anesthetic agent: In full accuracy mode: 5% of primary agent if primary agent is greater than 10%, 0.3% if primary agent is less than or equal to 10%.				
Data sample rate	25 Hz				
Accuracy specifications are affected by the breath rate and I:E change. The end-tidal gas reading is within specification for breath rate below 15 rpm and I:E ratio smaller than 1:1 relative to the gas readings without breath; Add ±6%REL to inaccuracy for Hal and O ₂ for breath rate larger than 15 rpm; Add ±6%REL to inaccuracy for all gases for breath rate larger than 30 rpm (inaccuracy for HAL and O ₂ are unspecified in this case); inaccuracy is unspecified for breath rate larger than 60 rpm.					
Effect of interference gases on AG measurements					
Gas	Concentration(%)	Quantitative effect(%ABS)3)			
		CO ₂	N ₂ O	Agent 1)	O ₂
CO ₂	/	/	0.1	0	0.2
N ₂ O	/	0.1	/	0.1	0.2
Agent 1) 2)	/	0.1	0.1	0.1	1
Xenon	<100%	0.1	0	0	0.5
Helium	<50%	0.1	0	0	0.5
Ethanol	<0.1%	0	0	0	0.5
Acetone	<1%	0.1	0.1	0	0.5
Methane	<1%	0.1	0.1	0	0.5
Saturated Isopropanol vapour	/	0.1	0	0	0.5
Metered dose inhaler propellants	/	Unspecified	Unspecified	Unspecified	Unspecified
O ₂	/	0.2	0.2	1.0	/
1) Agent represents one of Des, Iso, Enf, Sev, and Hal. 2) Multiple agent interference on CO ₂ , N ₂ O and O ₂ is typically the same as single agent interference. 3) For CO ₂ , N ₂ O and Agents, maximum interference from each gas at concentrations within specified accuracy ranges for each gas. The total interference of all gases is never larger than 5%REL.					
Alarm limit	Range			Step	
EtCO ₂ High	(low limit + 2) to 99 mmHg			1 mmHg	
EtCO ₂ Low	1 to (high limit - 2) mmHg				
FiCO ₂ High	0 to 99 mmHg				

EtO ₂ High	(low limit + 2%) to 100%	1%
EtO ₂ Low	0 to (high limit - 2)%	
FiO ₂ High	(low limit + 2%) to 100%	
FiO ₂ Low	18% to (high limit - 2)%	
EtN ₂ O High	(low limit + 2) to 100%	1%
EtN ₂ O Low	0 to (high limit - 2)%	
FiN ₂ O High	(low limit + 2) to 100%	
FiN ₂ O Low	0 to (high limit - 2)%	
EtHal/Enf/Iso High	(low limit + 0.2) to 5.0%	0.1%
EtHal/Enf/Iso Low	0 to (high limit - 0.2)%	
FiHal/Enf/Iso High	(low limit + 0.2) to 5.0%	
FiHal/Enf/Iso Low	0 to (high limit - 0.2)%	
EtSev High	(low limit + 0.2) to 8.0%	0.1%
EtSev Low	0 to (high limit - 0.2)%	
FiSev High	(low limit + 0.2) to 8.0%	
FiSev Low	0 to (high limit - 0.2)%	
EtDes High	(low limit + 0.2) to 18.0%	0.1%
EtDes Low	0 to (high limit - 0.2)%	
FiDes High	(low limit + 0.2) to 18.0%	
FiDes Low	0 to (high limit - 0.2)%	

A.13.14 RM Specifications

Technique	Differential pressure flow measurement technology
Flow	
Measurement range	Adult/pediatric: \pm (2 to 120) L/min
Accuracy	Adult/pediatric: 1.2 L/min or \pm 10% of the reading, whichever is greater
Resolution	0.1 L/min
Paw	
Measurement range	-20 to 120 cmH ₂ O
Accuracy	\pm 3% \times reading
Resolution	0.1 cmH ₂ O
MVe/MVi	
Measurement range	Adult/Pediatric: 2 to 60 L/min
Accuracy	\pm 10% \times reading
Resolution	0.01 L/min if airflow is less than 10 L/min, 0.1 L/min if airflow is equal to or more than 10 L/min
TVe/TVi	
Measurement range	Adult/Pediatric: 100 to 1500 ml
Resolution	1 ml

Accuracy	Adult/pediatric: $\pm 10\%$ or ± 15 ml, whichever is greater	
awRR		
Measurement range	4 to 120 rpm	
Resolution	1 rpm	
Accuracy	4 to 99 rpm	± 1 rpm
	100 to 120 rpm	± 2 rpm

Calculated Parameters	Measurement range	Measurement accuracy
I:E	4:1 to 1:8	Not specified
FEV1.0	0 to 100%	Not specified
Pmean	0 to 120 cmH ₂ O	$\pm 10\%$
PEEP	0 to 120 cmH ₂ O	Not specified
PEF	2 to 120 L/min	$\pm 10\%$
PIF	2 to 120 L/min	$\pm 10\%$
PIP	0 to 120 cmH ₂ O	$\pm 10\%$
Pplat	0 to 120 cmH ₂ O	Not specified
Compl	0 to 200 ml/cmH ₂ O	Not specified
RSBI	0 to 4095 rpm/L	Not specified

Specifications of parameters monitored when using with the sidestream CO₂ module or AG module configured with the paramagnetic oxygen sensor

Parameter	Measurement range	Measurement accuracy
VCO ₂	0 to 200 ml	$\pm 15\%$ or ± 15 ml, whichever is greater
VO ₂	0 to 200 ml	$\pm 15\%$ or ± 15 ml, whichever is greater

Parameter	Resolution	Parameters	Resolution	Parameters	Resolution
VCO ₂	1 mL	MVCO ₂	1 mL/min	VO ₂	1 mL
MVO ₂	1 mL/min	EE	1 kCal/day	RQ	0.01

Alarm limit	Range	Step
PEEP High	PEEP \leq 50 cmH ₂ O: (low limit + 1) to 50 cmH ₂ O PEEP $>$ 50 cmH ₂ O: (low limit + 5) to 120 cmH ₂ O	PEEP \leq 50 cmH ₂ O: 1 cmH ₂ O PEEP $>$ 50 cmH ₂ O: 5 cmH ₂ O
PEEP Low	PEEP \leq 50 cmH ₂ O: 0 to (high limit - 1) cmH ₂ O PEEP $>$ 50 cmH ₂ O: 50 to (high limit - 5) cmH ₂ O	
PIP High	PIP \leq 50 cmH ₂ O: (low limit + 1) to 50 cmH ₂ O PIP $>$ 50 cmH ₂ O: (low limit + 5) to 120 cmH ₂ O	PIP \leq 50 cmH ₂ O: 1 cmH ₂ O PIP $>$ 50 cmH ₂ O: 5 cmH ₂ O
PIP Low	PIP \leq 50 cmH ₂ O: 0 to (high limit - 1) cmH ₂ O PIP $>$ 50 cmH ₂ O: 50 to (high limit - 5) cmH ₂ O	
MVe High	Mve \leq 10 L/min: (low limit + 0.5 L/min) to 10.0 L/min Mve $>$ 10 L/min: (low limit + 2 L/min) to 60.0 L/min	Mve \leq 10 L/min: 0.5 L/min Mve $>$ 10 L/min: 2 L/min
MVe Low	Mve \leq 10 L/min: 0.5 L/min to (high limit - 0.5 L/min) Mve $>$ 10 L/min: 10 L/min to (high limit - 2 L/min)	

A.13.15 EEG Specifications

Standard	meets the requirements of IEC 60601-2-26: 2012	
Bandwidth	0.5 to 50 Hz (-3 dB)	
Input Signal Range	-2 mVp-p to +2 mVp-p	
Max. DC Input Offset	± 500 mV	
Common Mode Rejection Ratio	≥100 dB @51 kΩ imbalance and 60 Hz	
Noise Level	≤0.5 uV rms (1 Hz to 30 Hz)	
Differential Input Impedance	>15 MΩ @10 Hz	
Electrode Impedance	Range:	0 to 90 kΩ, Accuracy: ± 1 kΩ or ± 10%, whichever is greater

A.13.16 BIS Specifications

Standard	Meet the standard of IEC 60601-2-26: 2012	
Technique	Bispectral index	
Measured parameters	EEG BIS, BIS L, BIS R: 0 to 100	
Calculated parameters	SQI, SQI L, SQI R: 0 to 100% EMG, EMG L, EMG R: 0 to 100 dB SR, SR L, SR R: 0 to 100% SEF, SEF L, SEF R: 0.5 to 30.0 Hz TP, TP L, TP R: 40 to 100 dB BC, BC L, BC R: 0 to 30 sBIS L, sBIS R: 0 to 10.0 sEMG L, sEMG R: 0 to 10.0 ASYM: 0 to 100%	
Impedance range	0 to 999 kΩ	
Sweep speed	6.25 mm/s, 12.5 mm/s, 25 mm/s or 50 mm/s, ±10% error	
Input impedance	>5 MΩ	
Noise (RTI)	<0.3 μV (0.25 to 50 Hz)	
Input signal range	±1 mV	
EEG bandwidth	0.25 to 100 Hz	
Patient leakage current	<10 μA	
Alarm limit	Range	Step
BIS High	(low limit + 5) to 100	5
BIS Low	0 to (high limit - 5)	

A.13.17 NMT Specifications (NMT from Mindray NMT module)

Standard	meets the requirements of IEC 60601-2-10: 2012
----------	--

Stimulation output	Pulse width	100, 200, or 300 μ s; monophasic rectangle pulse Accuracy: \pm 10%
	Current range	0 to 60 mA in increments of 5 mA Accuracy: \pm 5% or \pm 2 mA, whichever is greater
	Max. skin impedance	3 k Ω @ 60 mA, 5 k Ω @ 40 mA
	Max. output voltage	300 V
ST mode	ST-Ratio	0 to 200%
	Measurement interval	Manual, 1 s, 10 s, 20 s
TOF mode	TOF-Count	0 to 4
	TOF-Ratio	5% to 160%
	TOF-T1%	0 to 200%
	Measurement interval	Manual, 12s, 15s, 20s, 30s, 1min, 5min, 15min, 30min, 60min
PTC mode	PTC-Count	0 to 20
	Measurement interval	Manual
DBS mode	Measurement interval	Manual, 15s, 20s, 30s, 1min, 5min, 15min, 30min, 60min
	DBS-Count	0 to 2
	DBS-Ratio	5% to 160%
NMT message	Threshold	
Block Recovery	Off, 1, 2, 3, 4, 5%, 10%, 20%, 30%, 40%, 50%, 60%, 70%, 80%, 90%, 100%	

A.13.18 rSO₂ Specifications

Measurement range	15% to 95%
-------------------	------------

This page intentionally left blank.

B EMC and Radio Regulatory Compliance

B.1 EMC

The device meets the requirements of IEC 60601-1-2: 2014.

WARNING

- **Use of accessories, transducers and cables other than those specified or provided by the manufacturer of this equipment could result in increased electromagnetic emissions or decreased electromagnetic immunity of this equipment and result in improper operation.**
- **The non-ME EQUIPMENT (e.g. information technology equipment (ITE)) that is a part of an ME SYSTEM may be disrupted by the electromagnetic interference of nearby equipment. It may be necessary to take mitigation measures, such as re-orienting or relocating the non-ME EQUIPMENT or shielding the location.**
- **Use of this equipment adjacent to, or stacked with, other equipment should be avoided because it could result in improper operation. If such use is necessary, this equipment and the other equipment should be observed to verify that they are operating normally.**
- **This equipment is intended for use in professional healthcare facility environment only. If it is used in a special environment, such as a magnetic resonance imaging environment, the equipment/system may be disrupted by the operation of nearby equipment.**
- **Portable RF communications equipment (including peripherals such as antenna cables and external antennas) should be used no closer than 30 cm (12 inches) to any part of the this device, including cables specified by the manufacturer. Otherwise, degradation of the performance of this equipment could result.**

Guidance and Declaration - Electromagnetic Emissions		
The device is intended for use in the electromagnetic environment specified below. The customer or the user of the device should assure that it is used in such an environment.		
Emission tests	Compliance	Electromagnetic environment - guidance
Conducted and radiated RF EMISSIONS CISPR 11	Group 1	The device is suitable for use in all establishments other than domestic and those directly connected to the public low-voltage power supply network that supplies buildings used for domestic purposes
Conducted and radiated RF EMISSIONS CISPR 11	Class A	
Harmonic distortion EMISSIONS IEC61000-3-2: 2014	Class A	
Voltage Fluctuations/Flicker EMISSIONS IEC61000-3-3: 2013	Complies	

If the system is operated within the electromagnetic environment listed in Table Guidance and Declaration – Electromagnetic Immunity, the system will remain safe and provide the following essential performance:

- Operating mode
- Accuracy
- Function
- Accessories identification
- Data stored
- Alarm

- Detect for connection

NOTE

- **If the essential performance is lost or degraded, it may be necessary to take mitigation measures, such as re-orienting or relocating the ME EQUIPMENT or ME SYSTEM or shielding the location. During this time, the user should stop using the monitor and contact the service personnel.**
- **The device needs special precautions regarding EMC and needs to be installed and put into service according to the EMC information provided below.**
- **Other devices may interfere with this device even though they meet the requirements of CISPR.**
- **When an input signal is below the minimum amplitude provided in technical specifications, erroneous measurements could result.**
- **The EMISSIONS characteristics of this device make it suitable for use in industrial areas and hospitals (CISPR 11 class A). If it is used in a residential environment (for which CISPR 11 class B is normally required) this device might not offer adequate protection to radio-frequency communication services. The user might need to take mitigation measures, such as relocating or re-orienting the device.**

Guidance and Declaration - Electromagnetic Immunity			
The device is intended for use in the electromagnetic environment specified below. The customer or the user of the device should assure that it is used in such an environment.			
Immunity test	IEC60601 test level	Compliance level	Electromagnetic environment - guidance
Electrostatic discharge (ESD) IEC 61000-4-2: 2008	±8 kV contact ±15 kV air	±8 kV contact ±15 kV air	Floors should be wood, concrete or ceramic tile. If floors are covered with synthetic material, the relative humidity should be at least 30%.
Electrical fast transient/burst IEC 61000-4-4: 2012	±2 kV for power supply lines ±1 kV for input/output lines (length greater than 3 m)	±2 kV for power supply lines ±1 kV for input/output lines (length greater than 3 m)	Mains power quality should be that of a typical commercial or hospital environment.
Surge IEC 61000-4-5: 2014	±1 kV line(s) to line(s) ±2 kV line(s) to earth	±1 kV line(s) to line(s) ±2 kV line(s) to earth	
Voltage dips and voltage interruptions IEC 61000-4-11: 2004	0 % U_T for 0.5 cycle: at 0°, 45°, 90°, 135°, 180°, 225°, 270° and 315° 0 % U_T for 1 cycle and 70 % U_T for 25/30 cycles: at 0° 0 % U_T for 250/300 cycle	0 % U_T for 0.5 cycle: at 0°, 45°, 90°, 135°, 180°, 225°, 270° and 315° 0 % U_T for 1 cycle and 70 % U_T for 25/30 cycles: at 0° 0 % U_T for 250/300 cycle	Mains power quality should be that of a typical commercial or hospital environment. If the user of our product requires continued operation during power mains interruptions, it is recommended that our product be powered from an uninterruptible power supply or a battery.
RATED power frequency magnetic fields IEC 61000-4-8: 2009	30 A/m 50 Hz/60 Hz	30 A/m 50 Hz/60 Hz	Power frequency magnetic fields should be at levels characteristic of a typical location in a typical commercial or hospital environment.
Note: U_T is the AC mains voltage prior to application of the test level.			

Guidance and Declaration - Electromagnetic Immunity
The device is intended for use in the specified electromagnetic environment. The customer or the user of the device should assure that it is used in such an environment as described below.

Guidance and Declaration - Electromagnetic Immunity			
Immunity test	IEC60601 test level	Compliance level	Electromagnetic environment - guidance
Conducted disturbances induced by RF fields IEC61000-4-6: 2013	3 Vrms 150 kHz to 80 MHz	3Vrms	Portable and mobile RF communications equipment should be used no closer to any part of the system, including cables, than the recommended separation distance calculated from the equation appropriate for the frequency of the transmitter. Recommended separation distances: $d = 1.2\sqrt{P}$
	6 Vrms in ISM bands ^a between 0.15 MHz and 80 MHz	6 Vrms	
Radiated RF EM fields IEC61000-4-3: 2006+A1:2007+A2:2010	3 V/m 80 MHz to 2.7 GHz	3V/m	Recommended separation distances: 80 MHz to 800 MHz: $d = 1.2\sqrt{P}$ 800MHz - 2.7GHz: $d = 2.3\sqrt{P}$ Where, P is the maximum output power rating of the transmitter in Watts (W) according to the transmitter manufacturer and d is the recommended separation distance in meters (m) ^b . Field strengths from fixed RF transmitters, as determined by an electromagnetic site survey ^a should be less than the compliance level in each frequency range ^b . Interference may occur in the vicinity of equipment marked with the following symbol: 
Proximity fields from RF wireless communications equipment IEC61000-4-3: 2006+A1:2007+A2:2010	27 V/m 380 - 390 MHz	27 V/m	/
	28 V/m 430 - 470 MHz, 800 - 960 MHz, 1700 - 1900 MHz, 2400 - 2570 MHz	28 V/m	
	9 V/m 704 - 787 MHz, 5100 - 5800 MHz	9 V/m	
<p>Note 1: At 80 MHz and 800 MHz, the higher frequency range applies.</p> <p>Note 2: These guidelines may not apply in all situations. Electromagnetic propagation is affected by absorption and reflection from structures, objects and people.</p>			
<p>^a: The ISM (industrial, scientific, and medical) bands between 150 kHz and 80 MHz are 6.765 MHz to 6.795 MHz; 13.553 MHz to 13.567 MHz; 26.957 MHz to 27.283 MHz; and 40.66 MHz to 40.70 MHz.</p> <p>^b: Field strengths from fixed transmitters, such as base stations for radio (cellular/cordless) telephones and land mobile radios, amateur radio, AM and FM radio broadcast and TV broadcast cannot be predicted theoretically with accuracy. To assess the electromagnetic environment due to fixed RF transmitters, an electromagnetic site survey should be considered. If the measured field strength in the location in which the ME EQUIPMENT or ME SYSTEM is used exceeds the applicable RF compliance level above, the ME EQUIPMENT or ME SYSTEM should be observed to verify normal operation. If abnormal performance is observed, additional measures may be necessary, such as re-orienting or relocating the ME EQUIPMENT or ME SYSTEM.</p> <p>^c: Over the frequency range 150 kHz to 80 MHz, field strengths should be less than 3V/m.</p>			

WARNING

- **The device is configured with a wireless network connector to receive wireless signal. Other devices may interfere with this device even though they meet the requirements of CISPR.**

Recommended separation distances between portable and mobile RF communications equipment and the device			
The device is intended for use in an electromagnetic environment in which radiated RF disturbances are controlled. The customer or the user of the device can help prevent electromagnetic interference by maintaining a minimum distance between portable and mobile RF communications equipment (transmitters) and the device as recommended below, according to the maximum output power of the communications equipment.			
Rated maximum output power of transmitter (W)	Separation distance in meters (m) according to frequency of the transmitter		
	150 kHz to 80 MHz $d = 1.2\sqrt{P}$	80 MHz to 800 MHz $d = 1.2\sqrt{P}$	800 MHz to 2.7 GHz $d = 2.3\sqrt{P}$
0.01	0.12	0.12	0.23
0.1	0.38	0.38	0.73
1	1.20	1.20	2.30
10	3.80	3.80	7.30
100	12.00	12.00	23.00
For transmitters rated at a maximum output power not listed above, the recommended separation distance d in metres (m) can be estimated using the equation applicable to the frequency of the transmitter, where P is the maximum output power rating of the transmitter in Watts (W) according to the transmitter manufacturer.			
Note 1: At 80 MHz and 800 MHz, the higher frequency range applies.			
Note 2: These guidelines may not apply in all situations. Electromagnetic propagation is affected by absorption and reflection from structures, objects and people.			

B.2 Radio Regulatory Compliance

This device complies with Part 15 of the FCC Rules and RSS-210 of Industry Canada. Operation is subject to the following two conditions: (1) this device may not cause harmful interference, and (2) this device must accept any interference received, including interference that may cause undesired operation.

Any changes or modifications to this equipment not expressly approved by Mindray may cause harmful radio frequency interference and void your authority to operate this equipment.

The maximum antenna gain permitted complies with the e.i.r.p. limits as stated in RSS-210.

The maximum antenna gain permitted complies with the e.i.r.p. limits specified for point-to-point operation, as stated in RSS-210.

WARNING

- **Changes or modifications not expressly approved by the party responsible compliance could void the user's authority to operate the equipment.**
-

C Default Settings

C.1 ECG, Arrhythmia, ST and QT Default Settings

C.1.1 ECG Default Settings

Item		Default Setting
HR	Alarm switch	On
	High limit	Adult: 120 bpm Pediatric: 160 bpm Neonate: 200 bpm
	Low limit	Adult: 50 bpm Pediatric: 75 bpm Neonate: 100 bpm
	Priority	Med
	Alarm Outputs	Off
	Alarm Source	Auto
ECG1		II
ECG2 (5-lead, 6-lead, 12-lead)		V (for 5-lead).Va (for 6-lead), V1 (for 12-lead)
Va (for 6-lead only)		Va
Vb(for 6-lead only)		Vb
ECG Gain		×1
Speed		25 mm/sec
Filter		OR: Surgery CCU: Diagnostic Other departments: Monitor
Notch Filter		On
Lead Set		Auto
Smart Lead		On
QRS Volume		General and OR: 2 Other departments: 0
Baseline Drift Removal (for 12-lead only)		On
Waveform Layout (for 12-lead only)		Standard
QRS Threshold		0.16 mV
Paced		Adult: Unspecified Pediatric/neonate: No
Pacer Reject		Off

C.1.2 Arrhythmia Default Settings

C.1.2.1 Arrhythmia Alarm Default Settings

Item	Alarm Switch	Priority	Alarm Outputs
Asystole	On	High, unadjustable	Off
V-Fib/V-Tach	On	High, unadjustable	Off
V-Tach	On	High, unadjustable	Off
Vent Brady	On	High, unadjustable	Off
Extreme Tachy	On	High, unadjustable	Off
Extreme Brady	On	High, unadjustable	Off
R on T	CCU: On Other departments: Off	Med	Off
Run PVCs	Off	Low	Off
Couplet	Off	Prompt	Off
Multiform PVC	Off	Med	Off
PVC	Off	Prompt	Off
Bigeminy	CCU: On Other departments: Off	Med	Off
Trigeminy	CCU: On Other departments: Off	Med	Off
Tachy	Off	Med	Off
Brady	Off	Med	Off
Pacer Not Capture	Off	Prompt	Off
Pacer Not Pacing	Off	Prompt	Off
Missed Beat	Off	Prompt	Off
Nonsus V-Tach	CCU: On Other departments: Off	Med	Off
Vent Rhythm	CCU: On Other departments: Off	Med	Off
Pause	Off	Low	Off
Irr Rhythm	Off	Prompt	Off
A-Fib	Off	Prompt	Off
PVCs/min	CCU: On Other departments: Off	Med	Off
Pauses/min	CCU: On Other departments: Off	Med	Off

C.1.2.2 Arrhythmia Threshold Default Settings

Item	Default Setting	
	Adult	Pediatric
Asystole Delay	5 sec	5 sec
Tachy	120 bpm	160 bpm
Brady	50 bpm	75 bpm
Extreme Tachy	160 bpm	180 bpm
Extreme Brady	35 bpm	50 bpm
Multif PVCs Window	15 beats	15 beats
PVCs/min	10	10
Pauses/min	8	8
Pause Threshold	2.0 sec	2.0 sec
AF/Irr Rhy End Time	2 min	2 min
V-Tach Rate	130 bpm	130 bpm
V-Brady Rate	40 bpm	40 bpm
V-Tach PVCs	6	6
V-Brady PVCs	5	5

C.1.3 ST Default Settings

Item	Default Setting	
ST Alarm Mode	Absolute	
ST Alarm Mode set to Absolute : ST-I, ST-II, ST-III, ST-aVR, ST-aVL, ST-aVF, ST-V1, ST-V2, ST-V3, ST-V4, ST-V5, ST-V6, ST-Va, ST-Vb	Alarm switch	Off
	High limit	0.2 mV
	Low limit	-0.2 mV
	Priority	Med
	Alarm Outputs	Off
ST Alarm Mode set to Relative : ST Single, ST Dual	Alarm switch	Off
	High limit	0.1 mV
	Low limit	-0.1 mV
	Priority	Med
	Alarm Outputs	Off
ST Analysis	Off	
ST Segment	Auto	
Show Marker	Off	
ST Point	J+60	
Auto Adjust	On	
J	48	
ISO	-80	

C.1.4 QT Default Settings

Item		Default Setting
QTc	Alarm switch	Off
	High limit	Adult: 500 Pediatric: 480 Neonate: 460
	Priority	Med
	Alarm Outputs	Off
ΔQTc	Alarm switch	Off
	High limit	60
	Priority	Med
	Alarm Outputs	Off
QT Analysis		Off
QT Lead		All

C.1.5 Glasgow 12-lead ECG Algorithm Default Settings

Item	Default Setting
High Freq Cut-off	35 Hz
Baseline Drift Removal	On
Tachy	100
Brady	50
Waveform Layout	Standard
Median Complex	Off
Measurements	On
Interpretation	On
Interpretation Summary	On

C.2 Respiration Default Settings

Item		Default Setting
RR	Alarm switch	On
	High limit	Adult: 30 Pediatric: 30 Neonate: 100
	Low limit	Adult: 8 Pediatric: 8 Neonate: 30
	Priority	Med
	Alarm Outputs	Off
Apnea	Alarm switch	On
	Priority	High, unadjustable
	Alarm Outputs	Off

Item	Default Setting
Apnea Delay	Adult: 20 sec Pediatric: 20 sec Neonate: 15 sec
RR Source	Auto
Resp Lead	Adult: Auto Pediatric: Auto Neonate: II
Gain	x2
Speed	6.25 mm/s
Auto Threshold Detection	On

C.3 SpO₂/SpO_{2b} Default Settings

Item	Default Setting	
SpO ₂ /SpO _{2b}	Alarm switch	On
	High limit	Adult: 100% Pediatric: 100% Neonate: 95%
	Low limit	90%
	Priority	Med
	Alarm Outputs	Off
SpO ₂ /SpO _{2b} Desat	Alarm switch	On
	Low limit	80%
	Priority	High
	Alarm Outputs	Off
ΔSpO ₂	Alarm switch	On
	High limit	10%
	Priority	Med
	Alarm Outputs	Off
Satsecond (for Nellcor SpO ₂)	Off	
NIBP Simul	Off	
FastSAT (for Masimo SpO ₂)	Off	
Display SIQ (for Masimo SpO ₂)	Off	
Display PI (for Masimo SpO ₂)	On	
Speed	25 mm/s	

Item		Default Setting
PR	Alarm switch	On
	High limit	Adult: 120 Pediatric: 160 Neonate: 200
	Low limit	Adult: 50 Pediatric: 75 Neonate: 100
	Priority	Med
	Alarm Outputs	Off
	Alarm Source	Auto
	PR Source	Auto
	Display PR	On
	QRS Volume	General, OR: 2 Other departments: 0

C.4 Temperature Default Settings

Item		Default Setting
Txx (xx refers to temperature site)	Alarm switch	On
	High limit	38.0 °C
	Low limit	35.0 °C
	Priority	Med
	Alarm Outputs	Off
ΔT	Alarm switch	On
	High limit	2.0 °C
	Priority	Med
	Alarm Outputs	Off

C.5 NIBP Default Settings

Item		Default Setting
NIBP-S	Alarm switch	On
	High limit	Adult: 160 mmHg Pediatric: 120 mmHg Neonate: 90 mmHg
	Low limit	Adult: 90 mmHg Pediatric: 70 mmHg Neonate: 40 mmHg
	Priority	Med
	Alarm Outputs	Off

Item		Default Setting
NIBP-D	Alarm switch	On
	High limit	Adult: 90 mmHg Pediatric: 70 mmHg Neonate: 60 mmHg
	Low limit	Adult: 50 mmHg Pediatric: 40 mmHg Neonate: 20 mmHg
	Priority	Med
	Alarm Outputs	Off
NIBP-M	Alarm switch	On
	High limit	Adult: 110 mmHg Pediatric: 90 mmHg Neonate: 70 mmHg
	Low limit	Adult: 60 mmHg Pediatric: 50 mmHg Neonate: 25 mmHg
	Priority	Med
	Alarm Outputs	Off
NIBP-S Extreme	Alarm switch	Off
	High limit	Adult: 175 mmHg Pediatric: 130 mmHg Neonate: 95 mmHg
	Low limit	Adult: 75 mmHg Pediatric: 60 mmHg Neonate: 35 mmHg
	Priority	High
	Alarm Outputs	Off
NIBP-D Extreme	Alarm switch	Off
	High limit	Adult: 105 mmHg Pediatric: 80 mmHg Neonate: 65 mmHg
	Low limit	Adult: 35 mmHg Pediatric: 30 mmHg Neonate: 15 mmHg
	Priority	High
	Alarm Outputs	Off
NIBP-M Extreme	Alarm switch	Off
	High limit	Adult: 125 mmHg Pediatric: 100 mmHg Neonate: 75 mmHg
	Low limit	Adult: 45 mmHg Pediatric: 40 mmHg Neonate: 20 mmHg
	Priority	High
	Alarm Outputs	Off

Item	Default Setting
Initial Pressure	Adult: 160 mmHg Pediatric: 140 mmHg Neonate: 90 mmHg
Interval	OR: 5 min Neonatology: 30 min Other departments: 15 min
Start Mode	Clock
NIBP End Tone	Off
Venipuncture Pressure	Auto
Display Format	Sys/Dia (Mean)
Display Alarm Limits	Off
Display PR	Off

C.6 IBP Default Settings

Item	Default Setting	
IBP-S	Alarm switch	On
	High limit	<ul style="list-style-type: none"> ■ Art/Ao/UAP/BAP/FAP/LV/P1-P2 arterial pressure Adult: 160 mmHg Pediatric: 120 mmHg Neonate: 90 mmHg ■ PA Adult: 35 mmHg Pediatric and neonate: 60 mmHg
	Low limit	<ul style="list-style-type: none"> ■ Art/Ao/UAP/BAP/FAP/LV/P1-P2 arterial pressure Adult: 90 mmHg Pediatric: 70 mmHg Neonate: 55 mmHg ■ PA Adult: 10 mmHg Pediatric and neonate: 24 mmHg
	Priority	Med
	Alarm Outputs	Off

Item		Default Setting
IBP-D	Alarm switch	On
	High limit	<ul style="list-style-type: none"> ■ Art/Ao/UAP/BAP/FAP/LV/P1-P2 arterial pressure Adult: 90 mmHg Pediatric: 70 mmHg Neonate: 60 mmHg ■ PA Adult: 16 mmHg Pediatric and neonate: 4 mmHg
	Low limit	<ul style="list-style-type: none"> ■ Art/Ao/UAP/BAP/FAP/LV/P1-P2 arterial pressure Adult: 50 mmHg Pediatric: 40 mmHg Neonate: 20 mmHg ■ PA Adult: 0 mmHg Pediatric and neonate: -4 mmHg
	Priority	Med
	Alarm Outputs	Off
IBP-M	Alarm switch	On
	High limit	<ul style="list-style-type: none"> ■ Art/pArt/Ao/UAP/BAP/FAP/LV/P1-P2 arterial pressure Adult: 110 mmHg Pediatric: 90 mmHg Neonate: 70 mmHg ■ PA Adult: 20 mmHg Pediatric and neonate: 26 mmHg ■ CVP Adult: 14 cmH₂O Pediatric and neonate: 5 cmH₂O ■ ICP/RAP/LAP/UVP/P3-P4 venous pressure Adult: 10 mmHg Pediatric and neonate: 4 mmHg
	Low limit	<ul style="list-style-type: none"> ■ Art/Ao/UAP/BAP/FAP/LV/P1-P2 arterial pressure Adult: 70 mmHg Pediatric: 50 mmHg Neonate: 35 mmHg ■ PA Adult: 0 mmHg Pediatric and neonate: 12 mmHg ■ CVP Adult: 0 cmH₂O Pediatric and neonate: 0 cmH₂O ■ ICP/RAP/LAP/UVP/P3-P4 venous pressure Adult: 0 mmHg Pediatric and neonate: 0 mmHg
	Priority	Med
	Alarm Outputs	Off

Item		Default Setting
Art-S Extreme	Alarm switch	Off
	High limit	Adult: 175 mmHg Pediatric: 130 mmHg Neonate: 95 mmHg
	Low limit	Adult: 75 mmHg Pediatric: 60 mmHg Neonate: 50 mmHg
	Priority	High
	Alarm Outputs	Off
Art-D Extreme	Alarm switch	Off
	High limit	Adult: 105 mmHg Pediatric: 80 mmHg Neonate: 65 mmHg
	Low limit	Adult: 35mmHg Pediatric: 30 mmHg Neonate: 15 mmHg
	Priority	High
	Alarm Outputs	Off
Art-M Extreme	Alarm switch	Off
	High limit	Adult: 125 mmHg Pediatric: 100 mmHg Neonate: 75 mmHg
	Low limit	Adult: 55 mmHg Pediatric: 40 mmHg Neonate: 30 mmHg
	Priority	High
	Alarm Outputs	Off
CPP	Alarm switch	On
	High limit	Adult: 130 mmHg Pediatric: 100 mmHg Neonate: 90 mmHg
	Low limit	Adult: 50 mmHg Pediatric: 40 mmHg Neonate: 30 mmHg
	Priority	Med
	Alarm Outputs	Off
Measure (for P1, P2)		All
Measure (for P3, P4)		Mean Only
Sensitivity		Med
Speed		25 mm/sec

Item		Default Setting
Scale	ICP/RAP/LAP/UV venous pressure	0- 20 mmHg
	Art/Ao/BAP/FAP/LV/P1/ P2 arterial pressure	0-160 mmHg
	UAP/P3/P4 venous pressure	0-80 mmHg
	CVP/PA	CVP: 0-30 cmH2O PA: 0 - 30 mmHg
Display Format		Sys/Dia (Mean)
Display Alarm Limits		Off
Use PA-D as PAWP (only available for independent external display)		Off
PPV Measure		Off
PPV Source		Auto
PAWP	Reference Waveform 1	II
	Reference Waveform 2	Resp
	Speed	12.5 mm/sec
	PA Scale	0-30 mmHg
Overlapping Waveform Setup	Left Scale	0-160 mmHg
	Right Scale	0-20 mmHg
	CVP Scale	0-30 cmH2O
	ICP Scale	0-20 mmHg
	PA Scale	0-30 mmHg
	Speed	25 mm/sec
	Gridlines	Off

C.7 C.O. Default Settings

Item		Default Setting
TB	Alarm switch	On
	High limit	39.0 °C
	Low limit	36.0 °C
	Priority	Med
	Alarm Outputs	Off
Comp const		0.542
Auto Start		On
Auto TI		On

C.8 ScvO₂ Default Settings

Item		Default Setting
ScvO ₂	Alarm switch	On
	High limit	90
	Low limit	40
	Priority	Med
	Alarm Outputs	Off
Hb/Hct		Hb

C.9 CCO Default Settings(Vigilance II/Vigileo/EV1000/HemoSphere)

Item		Default Setting
CCO	Alarm switch	On
	High limit	14.0
	Low limit	2.0
	Priority	Med
	Alarm Outputs	Off
CCI	Alarm switch	On
	High limit	10.0
	Low limit	1.0
	Priority	Med
	Alarm Outputs	Off
SVR Unit		DS/cm ⁵
Select Parameter		CCI, GEF, SVRI, ELWI, GEDI

C.10 ScvO₂/SvO₂ Default Settings(Vigilance II/Vigileo/EV1000/HemoSphere)

Item		Default Setting
SvO ₂ /ScvO ₂	Alarm switch	On
	High limit	90
	Low limit	40
	Priority	Med
	Alarm Outputs	Off

C.11 CO₂ Default Settings

C.11.1 General Settings

Item		Default Setting
EtCO ₂	Alarm switch	On
	High limit	Adult and pediatric: 50 mmHg Neonate: 45 mmHg
	Low limit	Adult and pediatric: 25mmHg Neonate: 30mmHg
	Priority	Med
	Alarm Outputs	Off
FiCO ₂	Alarm switch	On
	High limit	4 mmHg
	Priority	Med
	Alarm Outputs	Off
Apnea Delay		Adult and pediatric: 20 s Neonate: 15 s
RR Source		Auto
Speed		6.25 mm/s
Scale		50 mmHg
Waveform Type		Draw

C.11.2 Sidestream CO₂ Default Settings

Item		Default Setting
EtO ₂	Alarm switch	On
	High limit	88%
	Low limit	18%
	Priority	Med
	Alarm Outputs	Off
FiO ₂	Alarm switch	On
	High limit	Adult and pediatric: 100% Neonate: 90%
	Low limit	18%
	Priority	Med
	Alarm Outputs	Off
BTPS Compensation		Off
O ₂ Compensation (for CO ₂ module without O ₂ measurement)		OR: 100% Other departments: 21%
N ₂ O Compensation		0%
AG Compensation		0%
Auto Standby		60 min

Item	Default Setting
Operating Mode	Measure

C.11.3 Microstream CO₂ Default Settings

Item	Default Setting
BTPS Compen	Off
Maximum Hold	20 sec
Auto Standby	Off
Operating Mode	Measure

C.12 Gas Default Settings

Item	Default Setting	
EtCO ₂	Alarm switch	On
	High limit	Adult and pediatric: 50 mmHg Neonate: 45 mmHg
	Low limit	Adult and pediatric: 25 mmHg Neonate: 30 mmHg
	Priority	Med
	Alarm Outputs	Off
FiCO ₂	Alarm switch	On
	High limit	4 mmHg
	Priority	Med
	Alarm Outputs	Off
EtO ₂	Alarm switch	On
	High limit	88%
	Low limit	18%
	Priority	Med
	Alarm Outputs	Off
FiO ₂	Alarm switch	On
	High limit	Adult and pediatric: 100% Neonate: 90%
	Low limit	18%
	Priority	Med
	Alarm Outputs	Off
EtN ₂ O	Alarm switch	On
	High limit	55%
	Low limit	0%
	Priority	Med
	Alarm Outputs	Off

Item		Default Setting
FiN ₂ O	Alarm switch	On
	High limit	53%
	Low limit	0%
	Priority	Med
	Alarm Outputs	Off
EtAA/FiAA	Alarm switch	On
	High limit	30%
	Low limit	0.0%
	Priority	Med
	Alarm Outputs	Off
EtHal/EtEnf/EtIso	Alarm switch	On
	High limit	3.0%
	Low limit	0.0%
	Priority	Med
	Alarm Outputs	Off
FiHal/FiEnf/Filso	Alarm switch	On
	High limit	2.0%
	Low limit	0.0%
	Priority	Med
	Alarm Outputs	Off
EtSev	Alarm switch	On
	High limit	6.0%
	Low limit	0.0%
	Priority	Med
	Alarm Outputs	Off
FiSev	Alarm switch	On
	High limit	5.0%
	Low limit	0.0%
	Priority	Med
	Alarm Outputs	Off
EtDes	Alarm switch	On
	High limit	8.0%
	Low limit	0.0%
	Priority	Med
	Alarm Outputs	Off

Item		Default Setting
FiDes	Alarm switch	On
	High limit	6.0%
	Low limit	0.0%
	Priority	Med
	Alarm Outputs	Off
Apnea Delay		Adult and pediatric: 20 sec Neonate: 15 sec
RR Source		Auto
Operating Mode		Measure
Auto Standby		Off
RR Source		Auto
Speed		6.25 mm/sec
Scale		O2: 400 mmHg CO2: 50 mmHg N2O: 50 % Hal, Enf, and Iso: 2.5% Sev: 4.0% AA and Des: 9.0 %
Waveform Type		Draw (for CO ₂ only)
O2 compensation		OR: 100% Other departments: Off

C.13 RM Default Settings

Item		Default Setting
PEEP	Alarm switch	On
	High limit	10
	Low limit	0
	Priority	Med
	Alarm Outputs	Off
PIP	Alarm switch	On
	High limit	40
	Low limit	1
	Priority	Med
	Alarm Outputs	Off
MVe	Alarm switch	On
	High limit	30.0
	Low limit	2.0
	Priority	Med
	Alarm Outputs	Off
Apnea Delay		20 sec

Item	Default Setting
RR Source	Auto
Atmosphere Temp	25 °C
Relative Humidity	55 %
Paw Scale	40 cmH ₂ O
Flow Scale	60 L/min
Vol Scale	1200 ml
Speed	6.25 mm/s
Paw View	PIP, PEEP, Pmean, Pplat, RR
Flow View	PEF, PIF, Compl
Vol View	MVe, MVi, TVe, TVi

C.14 EEG Default Settings

Item	Default Setting	
Scale	100 µV	
Speed	25mm/s	
Low Filter	0.5 Hz	
High Filter	30 Hz	
Notch Filter	On	
EEG Expand View	Default Setting	
EEG	EEG Channels	All
	Scale	100 µV
	Speed	25mm/s
Trends	EEG Channels	EEG1, EEG2, EEG3, EEG4
	Parameters	SEF
	Trend Length	60 min
DSA	EEG Channels	All
	Parameters	SEF
	Trend Length	20 min
	Power Scale	1 - 64 dB
CSA	EEG Channels	All
	Parameters	SEF
	Trend Length	20 min
	Power Scale	1 - 64 dB
	CSA Clipping	On

C.15 BIS Default Settings

Item		Default Setting
BIS	Alarm switch	On
	High limit	70
	Low limit	20
	Priority	Med
	Alarm Outputs	Off
Smoothing Rate		30 sec
Display		OR: BIS Trend Other departments: EEG LT/RT
Scale		100 μ V
Speed		25mm/s
Filter		On
Auto Check		On
BIS Expand View		Default Setting
Parameter 1		BIS L
Parameter 2		EMG
Trend Length		60 min

C.16 NMT Default Settings

Item	Default Setting
Stimulation Current	Supra (60 mA)
Pulse Width	200 μ s
Block Recovery	Off
Stimulation Beep Volume	2
Interval	TOF Mode: 1 min ST Mode: 10 sec DBS Mode: 1 min
DBS Mode	3.3

C.17 rSO₂ Default Settings

Item		Default Setting
rSO2-1/rSO2-2/ rSO2-1'/rSO2-2'	Alarm switch	On
	High limit	90
	Low limit	40
	Priority	Med
	Alarm Outputs	Off

Item		Default Setting
rSO2-1/rSO2-2/ rSO2-1'/rSO2-2' Variance	Low Limit	-20
Auto Low Limit		Off
rSO2-1 Label		L
rSO2-2 Label		R
rSO2-1' Label		S1
rSO2-2' Label		S2
AUC Mode		Below Baseline Percentage
Fixed Threshold		50
Percentage Below Baseline		25
Select Parameter		Baseline, Baseline Variance

C.18 Alarm Default Settings

Item		Default Setting
Alarm Volume		2
High Alarm Volume		Alarm Volume + 2
Reminder Volume		2
Apnea Delay		Adult/Pediatric: 20 sec Neonate: 15 sec
Printing Duration on Alarm		20 sec
Auto Limits for New Patient		On

C.19 Display Default Settings

Item		Default Setting
Choose Screen		Normal Screen
Display	Screen Lock Duration	General: Permanent CCU: Permanent Other departments: 10 sec
	Brightness	5
	Brightness On Battery	1
Night Mode	Brightness	1
	Alarm Volume	2
	QRS Volume	1
	Key Volume	0
	NIBP End Tone	Off
	Stop NIBP	Off

This page intentionally left blank.

D Alarm Messages

This chapter lists only the physiological and technical alarm messages. Some messages appearing on your monitor may not be included. In the “Cause and solution” column, corresponding solutions are given instructing you to troubleshoot problems. If the problem persists, contact your service personnel.

D.1 Physiological Alarm Messages

D.1.1 General Physiological Alarm Messages

Alarm messages	Default priority	Cause and solution
XX High	Med	XX value has risen above the high alarm limit or fallen below the low alarm limit. Check the patient’s condition and check if the patient category and alarm limit settings are correct.
XX Low	Med	

Note: XX represents a measurement or parameter label, such as HR, NIBP, PVCs, RR, SpO₂, PR, etc.

D.1.2 Arrhythmia Alarm Messages

Alarm message	Default priority
Asystole	High
V-Fib/V-Tach	High
V-Tach	High
Vent Brady	High
Extreme Tachy	High
Extreme Brady	High
R on T	Med
Run PVCs	Low
Couplet	Prompt
Multiform PVC	Med
PVC	Prompt
Bigeminy	Med
Trigeminy	Med
Tachy	Med
Brady	Med
Pacer Not Pacing	Prompt
Pacer Not Capture	Prompt
Missed Beats	Prompt
Nonsus. Vtac	Med
Vent Rhythm	Med
Pause	Low

Alarm message	Default priority
Irr Rhythm	Prompt
PVCs/min	Med
Pauses/min	Med
A-Fib	Prompt

Note: When arrhythmia alarms occur, check the patient's condition and the ECG connections.

D.1.3 Resp Physiological Alarm Messages

Alarm message	Default priority	Cause and solution
Resp Artifact	High	The patient's heartbeat has interfered with the impedance respiration measurement. Check the patient's condition and the ECG connections.
Apnea	High	The respiration signal is so weak that the monitor cannot perform respiration analysis. Check the patient's condition, module and patient connections.

D.1.4 SpO₂ Physiological Alarm Messages

Alarm message	Default priority	Cause and solution
SpO ₂ /SpO _{2b} Desat	High	The SpO ₂ or SpO _{2b} value falls below the desaturation alarm limit. Check the patient's condition and check if the alarm limit settings are correct.
ΔSpO ₂ High	Med	The ΔSpO ₂ value exceeds the alarm limit. Check the patient's condition.

D.1.5 PR Physiological Alarm Messages

Alarm message	Default priority	Cause and solution
No Pulse	High	The pulse signal is so weak that the monitor cannot perform pulse analysis. Check the patient's condition and the source of the PR, such as IBP or SpO ₂ sensor, and measurement site.

D.1.6 NIBP Physiological Alarm Messages

Alarm message	Default priority	Cause and solution
NIBP-S Extremely High/NIBP-D Extremely High/NIBP-M Extremely High	High	The NIBP value is higher than the NIBP Extreme alarm high limit. Check the patient's condition and check if the alarm limit settings are correct.
NIBP-S Extremely High/NIBP-D Extremely High/NIBP-M Extremely Low	High	The NIBP value is lower than the NIBP Extreme alarm low limit. Check the patient's condition and check if the alarm limit settings are correct.

D.1.7 IBP Physiological Alarm Messages

Alarm message	Default priority	Cause and solution
Art-S/Art-D/Art-M Extremely High	High	The Art value is higher than the Art Extreme alarm high limit. Check the patient's condition and check if the alarm limit settings are correct.
Art-S/Art-D/Art-M Extremely Low	High	The Art value is lower than the Art Extreme alarm low limit. Check the patient's condition and check if the alarm limit settings are correct.

D.1.8 CO₂ Physiological Alarm Messages

Alarm message	Default priority	Cause and solution
FiO ₂ Shortage	High	FiO ₂ concentration is less than 18%. Check the patient's condition, the ventilated O ₂ content and the airway connection.

D.1.9 AG Physiological Alarm Messages

Alarm message	Default priority	Cause and solution
FiO ₂ Shortage	High	FiO ₂ concentration is less than 18%. Check the patient's condition, the ventilated O ₂ content and the AG connections.
Mixed Agent and MAC _≥ 3	Med	The mixed anaesthetic gases concentration is too high. Verify the MAC parameters are correct and adjust the anaesthetic gases concentration as necessary.
Apnea	High	The respiration signal was so weak that the monitor cannot perform respiration analysis. Check the patient's condition, module and patient connections.

D.1.10 RM Physiological Alarm Messages

Alarm message	Default priority	Cause and solution
Apnea	High	The respiration signal was so weak that the monitor cannot perform respiration analysis. Check the patient's condition, module and patient connections.

D.2 Technical Alarm Messages

This section lists technical alarms, their default priority, responses on alarm reset, and the actions that can be taken when an alarm occurs. Some of alarms may not be included.

Various technical alarms respond differently when the alarm system is reset. For easy clarification, in this section the technical alarms are classified into three categories of response when the alarm system is reset:

- A: technical alarms are cleared. The monitor gives no alarm indications.
- B: technical alarms are changed to the prompt messages.
- C: the alarm is silenced and a √ appears before the alarm message.

In the following tables A, B, and C are used to refer to the responses on alarm reset.

D.2.1 General Technical Alarm Messages

Alarm message	Default priority	Indication on alarm reset	Cause and solution
XX Module Error	High	C	XX module does not work properly. Reinsert the module, if the alarm persists, contact your service personnel.

Note: XX represents a measurement or parameter label, such as HR, RR, SpO₂, or EtCO₂, etc.

D.2.2 ECG Technical Alarm Messages

Alarm message	Default priority	Indication on alarm reset	Cause and solution
ECG Noisy	Low/Prompt	A	The ECG signal is noisy. Check for any possible sources of signal noise around the cable and electrode, and check the patient for excessive motion.
ECG Amplitude Too Small	Low	C	The ECG amplitude does not reach the detected threshold. Check for any possible source of interference around the cable and electrode.
ECG (XX) Lead Off	Low	B	The electrode has become detached from the patient or the lead wire has become disconnected from the adapter cable. Check the connections of the electrodes and leadwires.
ECG Signal Invalid	Low	A	Patient skin impedance is too high. Check ECG electrode application.
ECG Learning	Prompt	/	ECG learning is manually or automatically triggered.
Cannot Analyze QT	Prompt	/	/

Note: XX represents ECG lead name, for example RL, LL, V, Va, Vb, etc.

D.2.3 Resp Technical Alarm Messages

Alarm message	Default priority	Indication on alarm reset	Cause and solution
Resp Interference	Prompt	/	The respiration circuit is disturbed. Check for any possible sources of signal noise.
Electrode Poor Contact	Prompt	/	Check the electrode application. Reposition or replace the electrodes if necessary.

D.2.4 SpO₂ Technical Alarm Messages

Alarm message	Default priority	Indication on alarm reset	Cause and solution
SpO ₂ Sensor Off/SpO ₂ b Sensor Off	Low	B	The SpO ₂ sensor has become detached from the patient or the module. Check the sensor connection. If the alarm persists, replace the sensor.

Alarm message	Default priority	Indication on alarm reset	Cause and solution
SpO2 No Sensor/SpO2b No Sensor	Low	A	The SpO ₂ extension cable is detached from the SpO ₂ module, or the SpO ₂ sensor is detached from the SpO ₂ extension cable. Check the SpO ₂ cable and the sensor connection. If the alarm persists, replace the sensor.
SpO2 Excess Light/SpO2b Excess Light	Low	C	Ambient light is too strong. Move the sensor to a place with lower level of ambient light or cover the sensor to minimize the ambient light.
SpO2 No Pulse/SpO2b No Pulse	Low	C	The SpO ₂ sensor failed to obtain pulse signal. Check the patient's condition and replace the sensor application site. If the alarm persists, replace the sensor.
SpO2 Sensor Incompatible/SpO2b Sensor Incompatible	Low	C	Incompatible or an unspecified SpO ₂ sensor is used. Use specified sensors.
SpO2 Low Signal Quality/SpO2b Low Signal Quality	Low	C	1. Check the sensor and sensor position. 2. Make sure the patient is not shivering or moving. 3. The patient's pulse may be too low to be measured.
SpO2 Interference /SpO2b Interference	Low	C	The SpO ₂ signal has interference. Check for any possible sources of signal noise and check the patient for excessive motion.
SpO2 Sensor Error/SpO2b Sensor Error	Low	C	Replace the sensor and measure again.
SpO2 Searching Pulse/SpO2b Searching Pulse	Prompt	/	SpO ₂ is searching for pulse.
SpO2 Low Perfusion/SpO2b Low Perfusion	Prompt	/	The SpO ₂ sensor is not properly placed or the patient's perfusion index is too low. 1. Check the sensor and sensor position. 2. Reposition the sensor if necessary.

D.2.5 Temp Technical Alarm Messages

Alarm message	Default priority	Indication on alarm reset	Cause and solution
T1/T2 Sensor Off	Low	A	Check the sensor connection and reconnect the sensor.

D.2.6 NIBP Technical Alarm Messages

Alarm message	Default priority	Indication on alarm reset	Cause and solution
NIBP Loose Cuff	Low	A	There is a leak in the cuff or air tubing. Use a cuff of correct type based on the patient size. Apply the cuff and connect the air tubing as instructed in the manual.
NIBP Air Leak	Low	A	Check the NIBP cuff and pump for leakages.
NIBP Airway Error	Low	A	The air tubing may be occluded. Check the air tubing for an occlusion or kinking. If the alarm persists, contact your service personnel.

Alarm message	Default priority	Indication on alarm reset	Cause and solution
NIBP Weak Signal	Low	A	The patient's pulse is weak or the cuff is loose. Check the patient's condition and replace the cuff application site.
NIBP Overrange	Low	A	The measured NIBP value exceeds the module measurement range. Check the patient's condition.
NIBP Excessive Motion	Low	A	Check the patient's condition and reduce patient motion.
NIBP Cuff Overpress	Low	A	The NIBP airway may be occluded. Check the airway and measure again. If the alarm persists, contact your service personnel.
NIBP Timeout	Low	A	The measurement time exceeds 120 seconds in the adult or pediatric mode, or exceeds 90 seconds in the neonatal mode, and the BP value cannot be obtained. Check the patient's condition and NIBP connections, or replace the cuff and measure again.
NIBP Cuff and Patient Mismatch	Low	A	The cuff type mismatches the patient category. Verify the patient category or replace the cuff if necessary. If patient category is correct, check that the tubing is not bent and the airway is not occluded.
NIBP Airway Leak	Low	A	Airway leakage is found during the NIBP leakage test. Check the NIBP cuff and pump for leakages.

D.2.7 IBP Technical Alarm Messages

Alarm message	Default priority	Indication on alarm reset	Cause and solution
XX Sensor Error	Med	C	The IBP sensor fails. Replace the sensor.
XX No Sensor	Med	A	The IBP patient cable and/or corresponding IBP sensor is not connected or detached. Check the cable and sensor connection.
XX No Pulse	Low	A	The catheter may be occluded. Please flush the catheter.
XX Disconnected	High	C	The tubing is disconnected from the patient, or the three-way valve is open to the air. Check the connection of the tubing, or check the valve is open to the patient. If the alarm persists, contact your service personnel.
Monitor Version Low	Low	A	The N Series system software version is too low. In order for the N Series monitor to connect to the N1 which connects to the external IBP module and perform IBP monitoring, the system software of N 1 and N series monitor should be V01.62.00 and above.

Note: XX represents an IBP label, for example PA, CVP, FAP, P1, etc.

D.2.8 C.O. Technical Alarm Messages

Alarm message	Default priority	Indication on alarm reset	Cause and solution
TB Sensor Off	Low	A	Check the sensor connection and reconnect the sensor.
TI Sensor Off	Low	A	Check the sensor connection and reconnect the sensor.

D.2.9 ScvO₂ Technical Alarm Messages

Alarm message	Default priority	Indication on alarm reset	Cause and solution
ScvO ₂ High Signal	Low	C	Check the sensor and reposition the catheter. Recalibrate the sensor.
ScvO ₂ Low Signal	Low	C	Check the sensor and reposition the catheter. Recalibrate the sensor.
ScvO ₂ Excess Light	Low	C	Avoid excessively strong backlight.
Optical Module Disconnected	Low	A	Connect the optical module.
Unsupported CeVOX Version	Low	A	The module version is not compatible with the system. Contact your service personnel.
Disconnected from Vigilance	Low	A	The Vigilance monitor is disconnected. Check the connection between the CCO/SvO ₂ module and the Vigilance monitor.
Disconnected from Vigileo	Low	A	The Vigileo monitor is disconnected. Check the connection between the CCO/SvO ₂ module and the Vigileo monitor.
Disconnected from EV1000	Low	A	The EV1000 monitor is disconnected. Check the connection between the CCO/SvO ₂ module and the EV1000 monitor.
Disconnected from HemoSphere	Low	A	The HemoSphere monitor is disconnected. Check the connection between the CCO/SvO ₂ module and the HemoSphere monitor.

D.2.10 CO₂ Technical Alarm Messages

Alarm message	Default priority	Indication on alarm reset	Cause and solution
CO ₂ Module High Temp	Low	C	Ambient temperature is too high or there is a module failure. 1. Lower the operating temperature. 2. Reinsert the module. 3. If the alarm persists, the CO ₂ module may have failed, contact your service personnel.
CO ₂ Module Low Temp	Low	C	Ambient temperature is too low or there is a module failure. 1. Raise the operating temperature. 2. Reinsert the module. 3. If the alarm persists, the CO ₂ module may have failed, contact your service personnel.

Alarm message	Default priority	Indication on alarm reset	Cause and solution
CO2 Zero Failed	Low	C	Reinsert the module. If the alarm persists, contact your service personnel.
CO2 No Watertrap	Low	B	Check the watertrap connections.
CO2 High Airway Press.	Low	C	<ol style="list-style-type: none"> 1. Check the airway pressure settings of the ventilator/anesthesia machine. 2. Disconnect the module from the ventilator/anesthesia machine. 3. Reinsert the module. 4. If the alarm persists, contact your service personnel.
CO2 Low Airway Press.	Low	C	<ol style="list-style-type: none"> 1. Check the airway pressure settings of the ventilator/anesthesia machine. 2. Disconnect the module from the ventilator/anesthesia machine. 3. Reinsert the module. 4. If the alarm persists, contact your service personnel.
High Barometric	Low	C	<p>The ambient pressure exceeds the operating pressure range or CO₂ module fails.</p> <ol style="list-style-type: none"> 1. Make sure that the ambient pressure meets the specifications, and check for sources that affect the ambient pressure. 2. Reinsert the module. If the alarm persists, contact your service personnel.
Low Barometric	Low	C	<p>The ambient pressure exceeds the operating pressure range or CO₂ module fails.</p> <ol style="list-style-type: none"> 1. Make sure that the ambient pressure meets the specifications, and check for sources that affect the ambient pressure. 2. Reinsert the module. If the alarm persists, contact your service personnel.
CO2 Airway Occluded	Low	C	<ol style="list-style-type: none"> 1. Check if the sample line is kinked or occluded. 2. Replace the sample line. 3. Reinsert the module. 4. If the alarm persists, contact your service personnel.
CO2 No Filterline	Low	A	Make sure that the filterline is connected.
CO2 Calibration Required	Low	C	Perform a calibration.
CO2 Airway Error	Low	C	<ol style="list-style-type: none"> 1. Check if the sample line is kinked or occluded. 2. Replace the sample line. 3. Reinsert the module. 4. If the alarm persists, contact your service personnel.
CO2 Adapter Error	Low	A	Check, clean or replace the airway adapter. Perform a zero calibration.
CO2 No Sensor	Low	A	Make sure that the CO ₂ transducer is connected.
CO2: Change Watertrap	Low	C	Replace the watertrap.
CO2 Watertrap Mismatch	Low	C	Check the patient category and use a correct watertrap.

D.2.11 AG Technical Alarm Messages

Alarm message	Default priority	Indication on alarm reset	Cause and solution
AG No Watertrap	Low	B	Check the connections of the watertrap and re-connect it.
AG: Change Watertrap	Low	C	Replace the watertrap.
AG Watertrap and Patient Mismatch	Low	C	Check the patient category and use a correct watertrap.
AG Zero Failed	Low	C	There is external electromagnetic interference, airway occlusion or module failure. 1. Check for external inference sources. 2. Check for "AG Airway Occluded" alarm message. Remove the occlusion. 3. If the alarm persists, contact your service personnel.
Anesthetic Mixture	Low	C	Anesthetic mixture is detected.
AG Airway Occluded	Low	C	1. Check if the sample line is occluded. 2. Replace the sample line. 3. Reinsert the module. 4. If the alarm persists, contact your service personnel.

D.2.12 RM Technical Alarm Messages

Alarm message	Default priority	Indication on alarm reset	Cause and solution
RM No Sensor	Low	A	Check and reconnect the sensor.
RM Zero Failed	Low	C	Reinsert the module. If the alarm persists, contact your service personnel.
RM Sensor and Patient Mismatch	Low	C	Patient Category is set to Adult, but a neonatal sensor is used. Check patient category setting and use correct RM sensor.

D.2.13 EEG Technical Alarm Messages

Alarm message	Default priority	Indication on alarm reset	Cause and solution
EEG No Sensor	Low	A	The EEG patient cable is not connected. Connect the cable.
EEG Sensor Off	Low	A	EEG electrodes are not connected or detached. Check electrode connection and reconnect the electrodes.
EEG Electrode X + Y Off	Low	A	X + Y electrode is detached. Check the electrode connection and reconnect the electrode.
EEG Electrode X + Y Poor Contact	Low	A	X + Y electrode does not properly contact the patient. Check the electrode connection and reconnect the electrode.
EEG: Module Protected	High	C	EEG module may have failed. Disconnect the EEG module and reconnect it. If the alarm persists, replace the module, or contact your service personnel.

Note: X represents EEG channel and polarity, for example A+, A-, A+, A-, etc. Y represents electrode location, for example Fp1, T3, etc.

D.2.14 BIS Technical Alarm Messages

Alarm message	Default priority	Indication on alarm reset	Cause and solution
BIS Sensor Off	Low	A	Check and reconnect the BIS sensor. If the alarm persists, replace the sensor.
BIS Electrode XX Off	Low	A	Check the electrode connection, and re-attach the electrodes if necessary.
BIS Electrode XX Poor Contact	Low	A	Enter the Sensor Check menu, and check the connections of the sensor and electrodes.
BISx Error	High	C	Reinsert the module. If the alarm persists, contact your service personnel.
BIS No Sensor	Low	A	BIS sensor is not properly connected, BIS cable failure, BISx or BISx4 failure. 1. Check the BIS sensor connection. 2. Reinsert the BIS module. 3. Replace the BIS cable. 4. Replace BISx or BISx4.
BIS Sensor Too Many Uses	Low	A	Replace the sensor.
BIS Sensor Old	Low	A	Replace the sensor.
BIS XX Signal Quality Too Low	Low	A	SQL < 15% 1. Check the patient's condition. 2. Check the sensor position, and its contact with the patient's skin. 3. Check that BISx or BISx4 is away from electrically radiating equipment.
BIS XX Low Signal Quality	Low	A	SQL between 50% and 15%. 1. Check the patient's condition. 2. Check the sensor position, and its contact with the patient's skin. 3. Check that BISx or BISx4 is away from electrically radiating equipment.
BIS Wrong Sensor Type	Low	A	Check or replace the sensor.
BIS Sensor Error	Low	C	Replace the sensor.
BISx Disconnected	Low	A	BISx or BISx4 is not connected properly or fails, or BIS patient cable fails. 1. Check that BISx or BISx4 is connected properly. 2. Replug the BIS Module. 3. Replace the BIS patient cable. 4. Replace BISx or BISx4.
Reconnect BISx	Low	A	Reinsert the BIS Module.

Note: XX represents BIS label, for example G, C, LE, LT, RL-RA, L-R, F-R, 1, 2, etc.

D.2.15 NMT Technical Alarm Messages

Alarm message	Default priority	Indication on alarm reset	Cause and solution
NMT No Cable	Low	A	Check that NMT patient cable is properly connected to the NMT module.
NMT No Sensor	Low	A	Check that NMT sensor is properly connected to the NMT patient cable. If the alarm persists, replace the sensor.
NMT Stimulation Electrode Off	Low	A	Check that NMT sensor is properly connected to the NMT patient cable. If the alarm persists, check the application of electrodes.
NMT Sensor Error	Low	C	Contact your service personnel.

D.2.16 rSO₂ Technical Alarm Messages

Alarm message	Default priority	Indication on alarm reset	Cause and solution
rSO ₂ -1 No Sensor rSO ₂ -2 No Sensor rSO ₂ -1' No Sensor rSO ₂ -2' No Sensor	Low	A	rSO ₂ sensor is detached, or the sensor cable is disconnected from the pre-amplifier. Re-connect the sensor to the pre-amplifier.
rSO ₂ -1 Excess Light rSO ₂ -2 Excess Light rSO ₂ -1' Excess Light rSO ₂ -2' Excess Light	Low	C	The sensor is detached or ambient light is too strong. Re-attach the sensor or reduce the level of ambient light.
rSO ₂ -1 Low Signal Quality rSO ₂ -2 Low Signal Quality rSO ₂ -1' Low Signal Quality rSO ₂ -2' Low Signal Quality	Low	C	The signal acquired by the sensor was unstable or weak due to power supply noise. Check the sensor connection. If the alarm persists, contact your service personnel.
rSO ₂ -1/rSO ₂ -2 No Pre-amplifier rSO ₂ -1'/rSO ₂ -2' No Pre-amplifier	Low	A	Properly connect the pre-amplifier.
rSO ₂ -1: Change Sensor rSO ₂ -2: Change Sensor rSO ₂ -1': Change Sensor rSO ₂ : Change Sensor	Low	C	The sensor type mismatches patient category, the reusable sensor cable fails, the sensor reaches the lifetime, or the sensor type mismatches the monitor and patient category setting. Verify patient category and use sensors of correct patient category.
rSO ₂ -1/rSO ₂ -2 Interference rSO ₂ -1'/rSO ₂ -2' Interference	Low	C	There is noise interference (such as electrosurgical unit). Check for any possible sources of signal noise.
rSO ₂ -1 Auto Baseline rSO ₂ -2 Auto Baseline rSO ₂ -1' Auto Baseline rSO ₂ -2' Auto Baseline	Prompt	/	The monitor automatically sets the rSO ₂ baseline.
Disconnect/ Reconnect rSO ₂ -1/rSO ₂ -2 Disconnect/ Reconnect rSO ₂ -1'/rSO ₂ -2'	Low	A	Remove the rSO ₂ module and reconnect it.

D.2.17 Power Supply Technical Alarm Messages

Alarm message	Default priority	Indication on alarm reset	Cause and solution
Low Battery	Med	C	Connect the monitor to an AC power source and allow the batteries to charge.
Critically Low Battery	High	C	Connect the monitor to an AC power source and allow the batteries to charge.
Battery Service Required (N22/N19)	Low	B	The battery has reached its lifetime. Contact the service personnel.
Battery Overload (N22/N19)	High	C	Too many parameter modules are connected, causing system overload and high power consumption. Use AC power supply.
Power Board Comm Error	High	C	Shutdown and restart the monitor. If the alarm persists, contact your service personnel.
Battery Err	High	C	The battery may have failed. Contact your service personnel.
Battery Charging Error (N22/N19)	High	C	The charging circuit fails or the battery fails. Contact your service personnel.
RT Clock Need Reset	High	C	Contact your service personnel.
RT Clock Not Exist	High	C	Contact your service personnel.
XX V Too High	High	C	There is a problem with the system power supply. Shutdown and restart the monitor.
XX V Too Low	High	C	

Note: XX represents 2.5, 3.3, 5, or 12.

D.2.18 Recorder Technical Alarm Messages

Alarm message	Default priority	Indication on alarm reset	Cause and solution
Recorder Init Error	Low	A	An error occurred during the recorder initialization. Reinsert the module. If the alarm persists, contact your service personnel.
Recorder Comm Error	Low	A	Reinsert the recorder. Shutdown and restart the monitor. If the alarm persists, contact your service personnel.
Recorder Unavailable	Low	A	Recorder module failure. Replace the module.
Recorderhead Overheated	Low	C	The recorder has been printing for too long. Stop the recording and resume the recording after the recorder's print head cools down.
Recorder Initializing	Prompt	/	Wait until the recorder initialization is completed.
Recorder No Paper	Prompt	/	The recorder paper is not loaded or the recorder door is not closed. Check the recorder, load the recorder paper or close the recorder door.
Recorder Busy	Prompt	/	The buffer queue for recording is full.
Recorder Not Found	Prompt	/	The recorder module is not inserted in. Insert the module.

D.2.19 Printer Technical Alarm Messages

Alarm message	Default priority	Indication on alarm reset	Cause and solution
Printer Buffer Full	Prompt	/	The printer buffer is full. Wait until the printer finishes the printing task.
Printing Failed	Prompt	/	The printer ran out of paper or cannot be found on the network. Check the printer.
Printing Stopped	Prompt	/	Printing was manually stopped.
Printer Unavailable	Prompt	/	The printer may have failed. Check the printer.
PDF storage space is nearly full	Prompt	/	Delete the files saved under the PDF file path to release storage space. Otherwise you cannot save new PDF files.
Error storing PDF file	Prompt	/	The PDF file path settings on the print server and the PDF Creator are not consistent or the PDF storage space is full. Check the PDF file path settings for consistency, or delete the files saved under the PDF file path to release storage space.
Change the print server language to be consistent with this monitor	Prompt	/	Verify that the language settings of the print server and the monitor are consistent, Otherwise you cannot perform printing.
Print Server Disconnected	Prompt	/	Check that the monitor is properly connected with the print server.

D.2.20 Technical Alarm Messages Related to Networked Monitoring

Alarm message	Default priority	Indication on alarm reset	Cause and solution
CMS/eGW Disconnected	Low	B	The monitor is disconnected from the CMS. Check the network connection.
View Bed XX YY-ZZ, Network Disconnected.	Low	A	The network is interrupted when the monitor is viewing the remote device. Check the network connection.
Viewed by Bed XX YY-ZZ, Network Disconnected.	Low	A	The network is interrupted when the monitor is viewed by another remote device. Check the network connection.
WLAN IP Address Conflict	Low	C	There is a wireless network IP address conflicts. Check the network settings.
LAN1 IP Address Conflict	Low	C	There is a wired network IP address conflicts. Check the network settings.
Fail To Get WLAN IP Address	Low	C	Unable to automatically obtain the wireless network IP address. Check the network settings.
Fail To Get LAN1 IP Address	Low	C	Unable to automatically obtain the wired network IP address. Check the network settings.

Note: XX refers to the department name, YY refers to the room number, and ZZ refers to the bed number.

D.2.21 Technical Alarm Messages Related to Telemetry Monitors

Alarm message	Default priority	Indication on alarm reset	Cause and solution
Telemetry Disconnected	High	B	The telemetry is powered off, the monitor or the telemetry is not connected to the wireless network, or out of the network coverage. 1. Power on the telemetry. 2. Connect the monitor and the telemetry to the network. 3. Move the telemetry in the network coverage. 4. The exchanger network connected by the telemetry and the monitor does not support multicast data transfer. Contact your service personnel.
Telemetry Error	High	C	An error occurred to the telemetry. Restart the telemetry. If the problem still persists, replace with a known good telemetry.
Telemetry Low Battery	Med	C	The telemetry battery charge is low. Replace with a known good battery.
Telemetry Battery Depleted	High	C	The telemetry battery charge is critically low. Replace with known good batteries.
Telemetry Battery Maintenance Required	Med	C	The telemetry battery may reach its life. Replace with known good batteries.
Telemetry Battery Error	Med	C	The telemetry battery communication encounters an error. Replace with known good batteries.
Telemetry Battery Type Error	Med	C	The telemetry battery contacts may fail. Replace with known good batteries.

D.2.22 Other System Technical Alarm Messages

Alarm message	Default priority	Indication on alarm reset	Cause and solution
Primary Screen Alarm Error	High	C	The alarm signal communication between the primary display and the main unit is interrupted. The primary display cannot provide alarm indications. Check the connection between the main unit and the primary display.
Secondary Screen Alarm Error	High	C	The alarm signal communication between the secondary display and the main unit is interrupted. The secondary display cannot provide alarm indications. Check the connection between the main unit and the secondary display.
XX: Disconnected (XX refers to the name of the external device)	High	B	Corresponding external device is disconnected. Check the connection between the monitor and the external device.
Storage Error	High	C	The storage card failed or files are damaged. Shutdown and restart the monitor. Format the storage card (CAUTION: this will clear all patient data stored on this monitor). If the alarm persists, contact your service personnel.

Alarm message	Default priority	Indication on alarm reset	Cause and solution
Loading Default Config Failed	Low	A	The default configuration was not correctly loaded. The monitor will restore to the factory default configuration for the current patient category.
XX Conflicts (XX refers to the module label)	Prompt	/	The same type of corresponding module being used exceeds the supported number. Remove the conflict module.
XX Measurement has been closed (XX refers to the module label)	Prompt	/	The parameter module is disabled. Switch on the module if you want to use it. For more information, see <i>3.9.1 Switching On or Off a Parameter</i> .
The display setup for XX is disabled. (XX refers to the parameter label)	Prompt	/	The parameter of the newly inserted module is not displayed on the screen. Select a desired area to display the parameter numerics and waveforms. For more information, see <i>3.9.2 Displaying Parameter Numerics and Waveforms</i> .
The patient data storage space is nearly full. Please delete some discharged patients.	Med	B	The storage space of the monitor is full. Delete unnecessary discharged patients.

This page intentionally left blank.

E SpO₂ Sensor Accuracy

E.1 The Accuracy of Masimo SpO₂ Sensors

Table information for the plots below show A_{RMS} values measured with Masimo SET Oximetry Technology in a clinical study.

Adtx/Pdtx/4000/4001

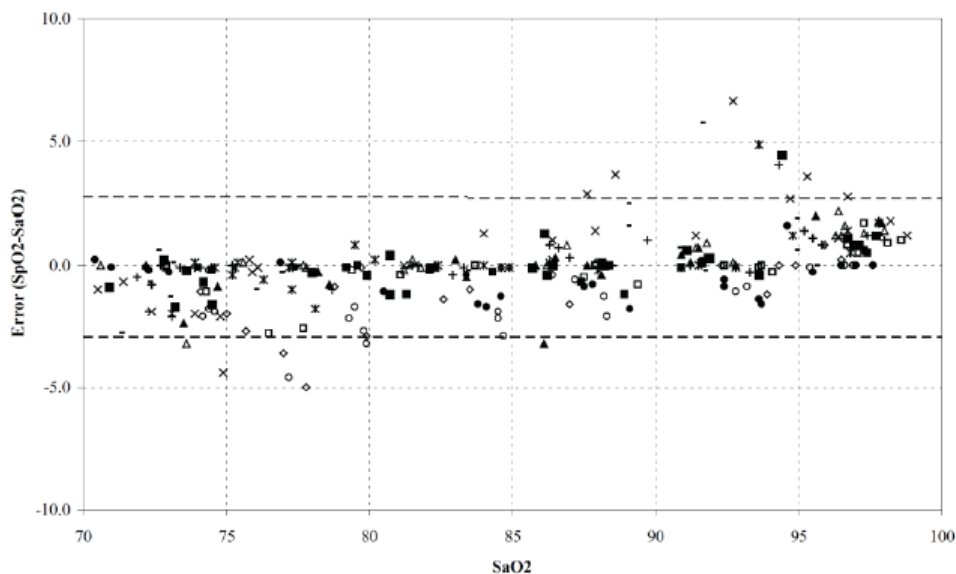

MEASURED A _{RMS} VALUES	
Range	A _{RMS}
90-100%	1.64%
80-90%	1.07%
70-80%	1.55%
Range	A _{RMS}
70-100%	± 2 %
Overall Claimed Accuracy Value	

Inf/Neo/NeoPt/4002/4003/4004/4005

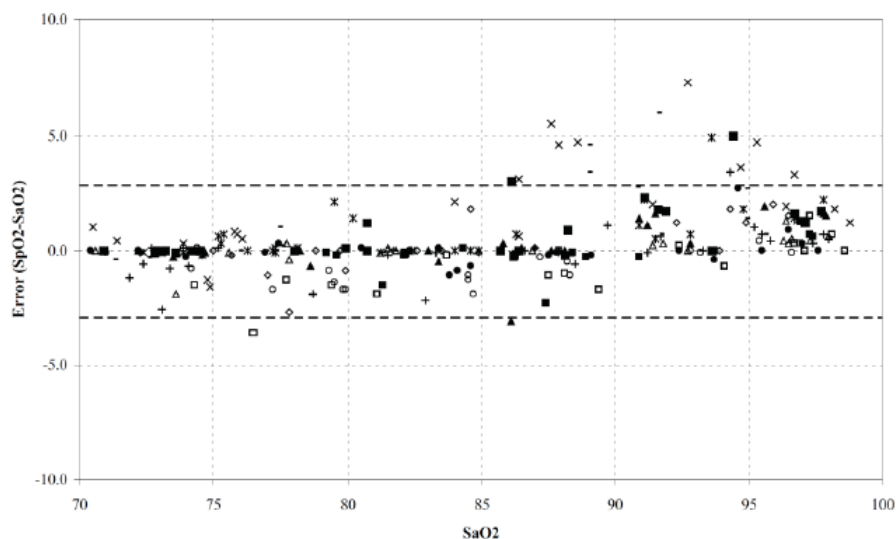

MEASURED A _{RMS} VALUES	
Range	A _{RMS}
90-100%	1.85%
80-90%	1.44%
70-80%	0.89%

Range	A _{RMS}		
	Inf	Neo*	Neo Pt*
70-100%	± 2 %	±2 % Adult ±3 % Neonatal	±3 %
Overall Claimed Accuracy Value			

*The saturation accuracy of the Neonate and Preterm sensors was validated on adult volunteers and 1% was added to account for the properties of fetal hemoglobin.

DCI/DCIP/4050/4051

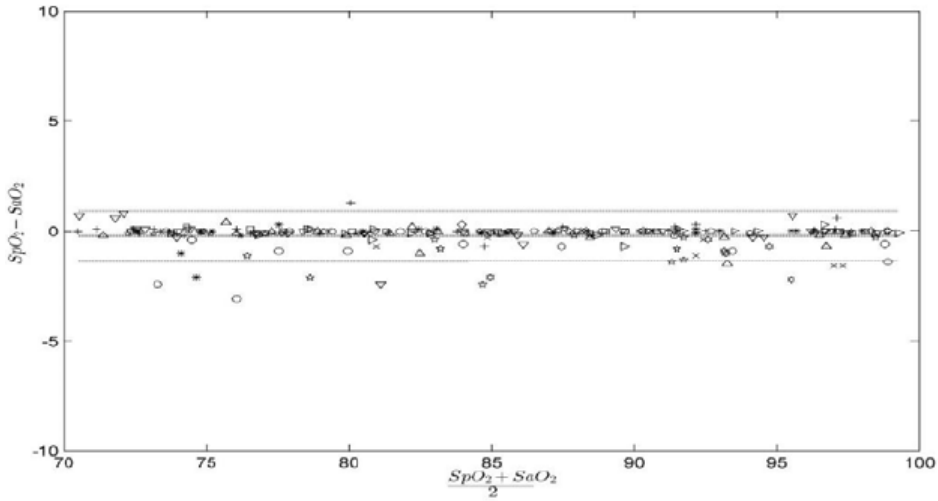

MEASURED A_{RMS} VALUES	
Range	A_{RMS}
90-100%	0.60%
80-90%	0.54%
70-80%	0.67%
Range	A_{RMS}
70-100%	2 %
Overall Claimed Accuracy Value	

LNCS YI

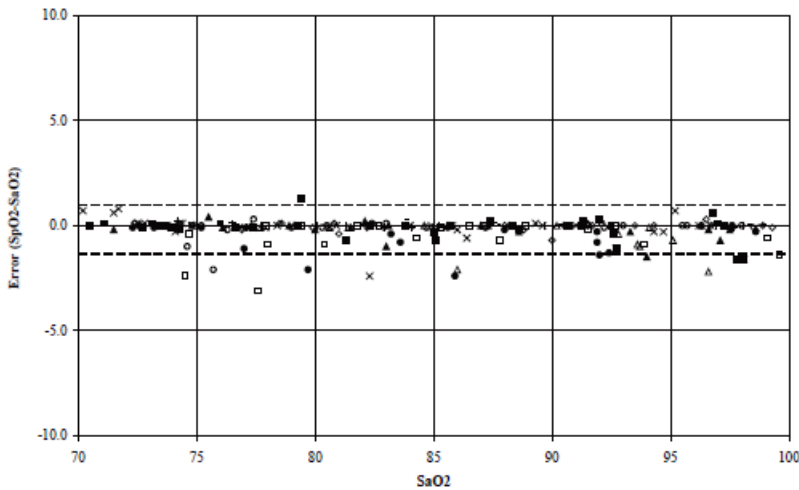

MEASURED A_{RMS} VALUES	
RANGE	A_{RMS}
90-100%	0.6%
80-90%	0.5%
70-80%	0.7%
OVERALL CLAIMED ACCURACY VALUE	
70-100%	$\pm 2\%$

4053

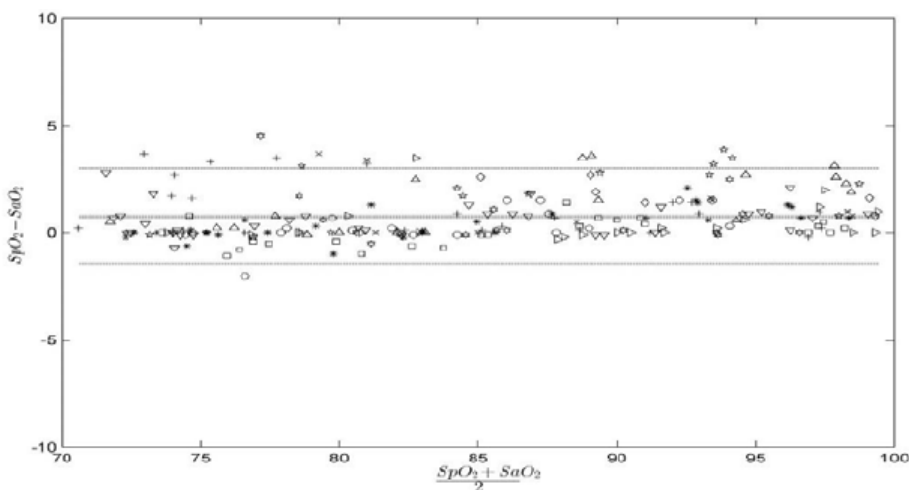

MEASURED A_{RMS} VALUES	
Range	A_{RMS}
90-100%	1.45%
80-90%	1.22%
70-80%	1.41%
Range	A_{RMS}
70-100%	2 %
Overall Claimed Accuracy Value	

E.2 The Accuracy of Nellcor SpO₂ Sensors

SpO₂ Accuracy for Nellcor Sensors vs. Co-Oximeters (Arms)

SpO ₂ Range	100% to 70%	100% to 90%	90% to 80%	80% to 70%
DS-100A	1.64%	1.16%	1.67%	2.25%
D-YS, OXI-P/I, OXI-A/N	2.41%	1.38%	2.50%	3.60%
MAXAI, MAXPI, MAXII	1.62%	1.49%	1.57%	2.50%
MAXNI	1.85%	1.71%	1.51%	1.59%

Modified Bland-Altman for SpO₂ - MAXAI, MAXPI, MAXII, MAXNI Sensors: (SpO₂ - SaO₂) vs.SaO₂

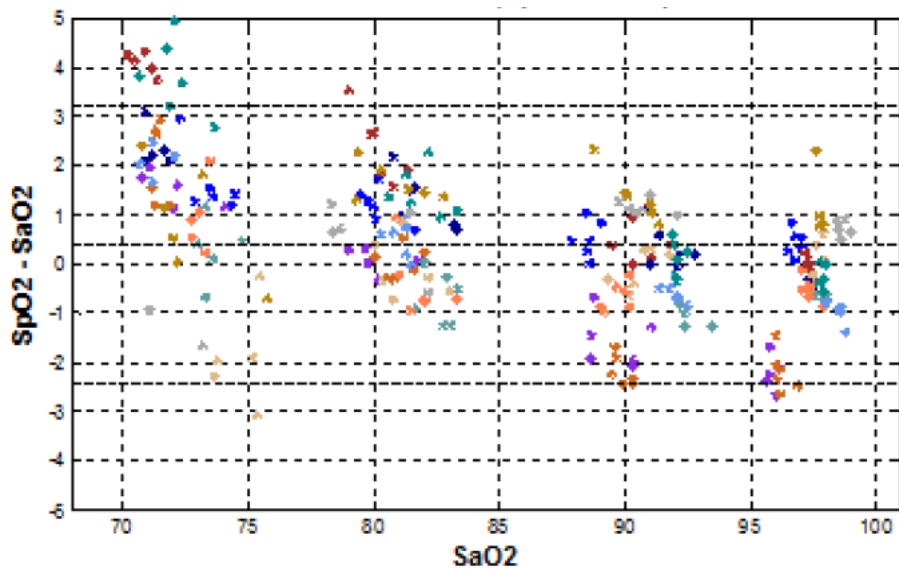

Modified Bland-Altman for SpO₂ - DS-100A Sensors: (SpO₂ - SaO₂) vs.SaO₂

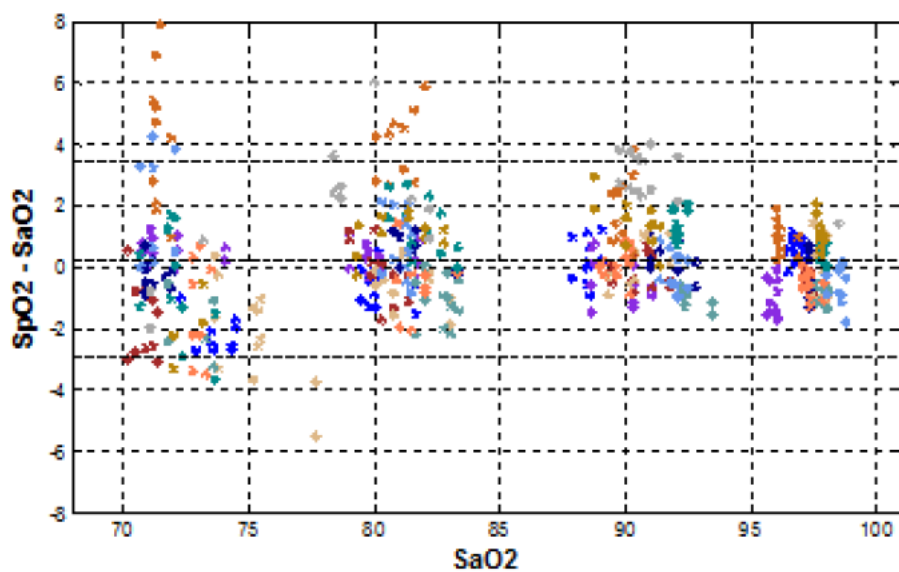

Modified Bland-Altman for SpO₂ - D-YS, OXI-A/N, OXI-P/I Sensors: (SpO₂ - SaO₂) vs.SaO₂

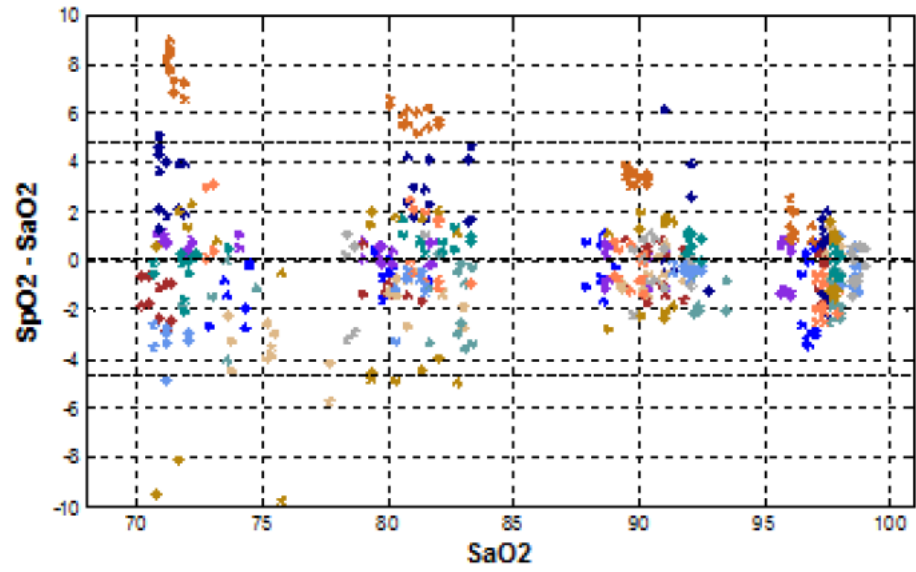

F Units, Symbols and Abbreviations

F.1 Units

Abbreviation	In Full
μA	microampere
μV	microvolt
μs	microsecond
A	Ampere
Ah	Ampere hour
bpm	beat per minute
bps	bits per second
°C	Celsius
cc	cubic centimeter
cm	centimeter
dB	decibel
DS	dyne second
°F	Fahrenheit
g	gram
GHz	gigahertz
GTT	gutta
h	hour
Hz	hertz
in	inch
k	kilo
kg	kilogram
kPa	kilopascal
L	litre
lb	pound
m	meter
mAh	milliampere hour
Mb	mega byte
mcg	microgram
mEq	milli-equivalents
mg	milligram
min	minute
ml	milliliter
mm	millimeter

Abbreviation	In Full
mmHg	millimeters of mercury
cmH ₂ O	centimeters of water
ms	millisecond
mV	millivolt
mW	milliwatt
MΩ	megaohm
nm	nanometer
rpm	breaths per minute
s	second
V	volt
VA	volt ampere
Ω	ohm
W	watt

F.2 Symbols

Symbol	Explanation
-	negative, minus
%	percent
/	per; divide; or
~	to
+	plus
=	equal to
<	less than
>	greater than
≤	less than or equal to
≥	greater than or equal to
±	plus or minus
×	multiply
©	copyright

F.3 Abbreviations

Abbreviation	In Full
AaDO ₂	alveolar-arterial oxygen gradient
AC	alternating current
ACI	acceleration index
Adu	adult
AG	anaesthesia gas
AHA	American Heart Association
Ao	aortic pressure
Art	arterial
ATMP	barometric pressure
AUC	area under the curve
Avg	rSO ₂ average
aVF	left foot augmented lead
aVL	left arm augmented lead
aVR	right arm augmented lead
awRR	airway respiratory rate
BAP	brachial arterial pressure
BC	burst count
BL	baseline
BoA	Balance of Anesthesia
BSA	body surface area
BT	blood temperature
BTPS	body temperature and pressure, saturated
CAA	Clinical Assistive Application
CaO ₂	arterial oxygen content
CCI	continuous cardiac index
CCO	continuous cardiac output
CCU	cardiac (coronary) care unit
CE	Conformité Européenne
CFI	cardiac function index
C.I.	cardiac index
CIS	clinical information system
CISPR	International Special Committee on Radio Interference
CMOS	complementary metal oxide semiconductor
CMS	central monitoring system
C.O.	cardiac output
CO ₂	carbon dioxide
COHb	carboxyhemoglobin

Abbreviation	In Full
Compl	compliance
COPD	chronic obstructive pulmonary disease
CPI	cardiac power index
CPO	cardiac power output
CVP	central venous pressure
DC	direct current
Des	desflurane
Dia	diastolic
dpi	dot per inch
dPmx	left ventricular contractility
DVI	digital video interface
DO ₂	oxygen delivery
DO ₂ I	oxygen delivery index
ECG	electrocardiograph
EDV	end-diastolic volume
EEC	European Economic Community
EEG	electroencephalogram
EMC	electromagnetic compatibility
EMG	electromyograph
EMI	electromagnetic interference
Enf	enflurane
ESV	end systolic volume
ESVI	end systolic volume index
ESU	electrosurgical unit
Et	end-tidal
EtAA	end-tidal anesthetic agent
EtDes	end-tidal anesthetic agent
EtEnf	
EtHal	
EtIso	
EtSev	
EtCO ₂	end-tidal carbon dioxide
EtN ₂ O	end-tidal nitrous oxide
EtO	ethylene oxide
EtO ₂	end-tidal oxygen
EVLW	extravascular lung water
ELWI	extravascular lung water index
EWS	Early Warning Score
FAP	femoral arterial pressure

Abbreviation	In Full
FCC	Federal Communication Commission
FDA	Food and Drug Administration
Fi	fraction of inspired
FiAA	inspired anesthetic agent
FiDes	inspired anesthetic agent
FiEnf	
FiHal	
Filso	
FiSev	
FiCO ₂	fraction of inspired carbon oxygen
FiN ₂ O	fraction of inspired nitrous oxide
FiO ₂	fraction of inspired oxygen
FPGA	field programmable gate array
FV	flow-volume
GCS	Glasgow Coma Scale
GEDV	global end diastolic volume
GEDI	global end diastolic volume index
GEF	global ejection fraction
Hal	halothane
Hb	hemoglobin
Hct	haematocrit
HIS	hospital information system
HR	heart rate
IBP	invasive blood pressure
IBW	ideal body weight
ICP	intracranial pressure
ICT/B	intracranial catheter tip pressure transducer
ICU	intensive care unit
ID	identification
I:E	inspiratory time: expiratory time ratio
IEC	International Electrotechnical Commission
IEEE	Institute of Electrical and Electronic Engineers
IP	internet protocol
Iso	isoflurane
ITBI	intrathoracic blood volume index
ITBV	intrathoracic blood volume
LA	left arm
LAP	left atrial pressure
LCD	liquid crystal display

Abbreviation	In Full
LCW	left cardiac work
LCWI	left cardiac work index
LDAP	Lightweight Directory Access Protocol
LED	light emitting diode
LL	left leg
LVET	left ventricular ejection time
LVSW	left ventricular stroke work
LVSWI	left ventricular stroke work index
MAC	minimum alveolar concentration
MAP	mean arterial pressure
Mb	myoglobin
MetHb	methemoglobin
MEWS	Modified Early Warning Score
MLDAP	Mindray LDAP, Mindray lightweight directory access protocol
MRI	magnetic resonance imaging
MV	minute volume
MVe	expiratory minute volume
MVi	inspiratory minute volume
N/A	not applied
N ₂	nitrogen
N ₂ O	nitrous oxide
Neo	neonate
NEWS	National Early Warning Score
NIBP	noninvasive blood pressure
NIF	negative inspiratory force
O ₂	oxygen
O ₂ %	oxygen concentration
OR	operating room
OxyCRG	oxygen cardio-respirogram
PA	pulmonary artery
Paw	airway pressure
PAWP	pulmonary artery wedge pressure
Ped	pediatric
PEEP	positive end expiratory pressure
PEF	peak expiratory flow
PEP	pre-ejection period
PIF	peak inspiratory flow
PIP	peak inspiratory pressure
Pleth	plethysmogram

Abbreviation	In Full
Pmean	mean pressure
PO ₂	oxygen supply pressure
Pplat	plateau pressure
PPV	pulse pressure variation
PR	pulse rate
PVC	premature ventricular contraction
PVPI	pulmonary vascular permeability index
PVR	pulmonary vascular resistance
PVRI	pulmonary vascular resistance index
qSOFA	quick Sepsis-Related Organ Failure Assessment
RA	right arm
RAP	right atrial pressure
Raw	airway resistance
Rec	record, recording
Resp	respiration
RL	right leg
RR	respiration rate
RSBI	rapid shallow breathing index
RVEF	right ventricular ejection fraction
rSO ₂	regional oxygen saturation
SaO ₂	arterial oxygen saturation
ScvO ₂	central venous oxygen saturation
SEF	spectral edge frequency
Sev	sevoflurane
SI	stroke index
SMR	satellite module rack
SOFA	Sepsis-Related Organ Failure Assessment
SpO ₂	arterial oxygen saturation from pulse oximetry
SQI	signal quality index
SR	suppression ratio
SSC	Surviving Sepsis Campaign
SSI	signal strength index
STR	systolic time ratio
SV	stroke volume
SVI	stroke volume index
SVR	systemic vascular resistance
SVRI	systemic vascular resistance index
SVV	stroke volume variation
SvO ₂	venous oxygen saturation

Abbreviation	In Full
Sync	synchronization
Sys	systolic pressure
TB	blood temperature
tcpCO ₂	transcutaneous carbon dioxide partial pressures
tcpO ₂	transcutaneous oxygen partial pressures
TD	temperature difference
Temp	temperature
TFC	thoracic fluid content
TFI	thoracic fluid index
TFT	thin-film technology
TI	injectate temperature
TP	total power
TRC	tube resistance compensation
TVe	expiratory tidal volume
TVi	inspiratory tidal volume
TV	tidal volume
UAP	umbilical arterial pressure
UPS	uninterruptible power supply
USB	universal serial bus
UVP	umbilical venous pressure
VAC	volts alternating current
VEPT	volume of electrically participating tissue
VI	velocity index
VPB	ventricular premature beat per minute
WOB	work of breathing

