

TE7/TE5/TE7 Max/TE5 Max/TE9

Diagnostic Ultrasound System

Operator's Manual

[Basic Volume]

Intellectual Property Statement

SHENZHEN MINDRAY BIO-MEDICAL ELECTRONICS CO., LTD. (hereinafter called Mindray) owns the intellectual property rights to this Mindray product and this manual. This manual may refer to information protected by copyright or patents and does not convey any license under the patent rights or copyright of Mindray, or of others.

Mindray intends to maintain the contents of this manual as confidential information. Disclosure of the information in this manual in any manner whatsoever without the written permission of Mindray is strictly forbidden.

Release, amendment, reproduction, distribution, rental, adaptation, translation or any other derivative work of this manual in any manner whatsoever without the written permission of Mindray is strictly forbidden.

mindray ,  and **MINDRAY** are the trademarks, registered or otherwise, of Mindray in China and other countries. All other trademarks that appear in this manual are used only for informational or editorial purposes. They are the property of their respective owners.

This posting serves as notice under 35 U.S.C.§287(a) for Mindray patents:

<http://www.mindrayna.com/patents>.

Responsibility on the Manufacturer Party

Contents of this manual are subject to change without prior notice.

All information contained in this manual is believed to be correct. Mindray shall not be liable for errors contained herein or for incidental or consequential damages in connection with the furnishing, performance, or use of this manual.

Mindray is responsible for the effects on safety, reliability and performance of this product, only if:

- all installation operations, expansions, changes, modifications and repairs of this product are conducted by Mindray authorized personnel;
- the electrical installation of the relevant room complies with the applicable national and local requirements; and
- the product is used in accordance with the instructions for use.

NOTE:

This equipment must be operated by skilled/trained clinical professionals.

WARNING

It is important for the hospital or organization that employs this equipment to carry out a reasonable service/maintenance plan. Neglect of this may result in machine breakdown or personal injury.

Warranty

THIS WARRANTY IS EXCLUSIVE AND IS IN LIEU OF ALL OTHER WARRANTIES, EXPRESSED OR IMPLIED, INCLUDING WARRANTIES OF MERCHANTABILITY OR FITNESS FOR ANY PARTICULAR PURPOSE.

Exemptions

Mindray's obligation or liability under this warranty does not include any transportation or other charges or liability for direct, indirect or consequential damages or delay resulting from the improper use or application of the product or the use of parts or accessories not approved by Mindray or repairs by people other than Mindray authorized personnel.

This warranty shall not extend to:

- Malfunction or damage caused by improper use or man-made failure.
- Malfunction or damage caused by unstable or out-of-range power input.
- Malfunction or damage caused by force majeure such as fire and earthquake.
- Malfunction or damage caused by improper operation or repair by unqualified or unauthorized service people.
- Malfunction of the instrument or part whose serial number is not legible enough.
- Others not caused by instrument or part itself.

Customer Service Department

Manufacturer:	Shenzhen Mindray Bio-Medical Electronics Co., Ltd.
Address:	Mindray Building, Keji 12th Road South, High-tech industrial park, Nanshan, Shenzhen 518057, P.R.China
Website:	www.mindray.com
E-mail Address:	service@mindray.com
Tel:	+86 755 81888998
Fax:	+86 755 26582680

Manufacturer:	Mindray DS USA, Inc.
Address:	800 MacArthur Blvd. Mahwah, NJ 07430-0619 USA
Tel:	+1(201) 995-8000
Toll Free:	+1 (800) 288-2121
Fax:	+1 (800) 926-4275

Important Information



- It is the customer's responsibility to maintain and manage the system after delivery.
- The warranty does not cover the following items, even during the warranty period:



- Damage or loss due to misuse or abuse.
 - Damage or loss caused by Acts of God such as fires, earthquakes, floods, lightning, etc.
 - Damage or loss caused by failure to meet the specified conditions for this system, such as inadequate power supply, improper installation or environmental conditions.
 - Damage or loss due to use of the system outside the region where the system was originally sold.
 - Damage or loss involving the system purchased from a source other than Mindray or its authorized agents.
- This system shall not be used by persons other than fully qualified and certified medical personnel.
 - DO NOT make changes or modifications to the software or hardware of this system.
 - In no event shall Mindray be liable for problems, damage, or loss caused by relocation, modification, or repair performed by personnel other than those designated by Mindray.
 - The purpose of this system is to provide physicians with data for clinical diagnosis. The physician is responsible for the results of diagnostic procedures. Mindray shall not be liable for the results of diagnostic procedures.
 - Important data must be backed up on external memory media.
 - Mindray shall not be liable for loss of data stored in the memory of this system caused by operator error or accidents.
 - This manual contains warnings regarding foreseeable potential dangers, but you shall also be continuously alert to dangers other than those indicated. Mindray shall not be liable for damage or loss resulting from negligence or ignorance of the precautions and operating instructions described in this operator’s manual.
 - If a new manager takes over this system, be sure to hand over this operator’s manual to the new manager.

About This Manual

This operator’s manual describes the operating procedures for this diagnostic ultrasound system and the compatible probes. To ensure safe and correct operation, carefully read and understand the manual before operating the system.

Meaning of Signal Words

In this manual, the signal words  **DANGER**,  **WARNING**,  **CAUTION**, **NOTE** and **TIP** are used regarding safety and other important instructions. The signal words and their meanings are defined as follows. Please understand their meanings clearly before reading this manual.

Signal word	Meaning
 DANGER	Indicates an imminently hazardous situation that, if not avoided, will result in death or serious injury.
 WARNING	Indicates a potentially hazardous situation that, if not avoided, could result in death or serious injury.
 CAUTION	Indicates a potentially hazardous situation that, if not avoided, may result in minor or moderate injury.
NOTE	Indicates a potentially hazardous situation that, if not avoided, may result in property damage.

Signal word	Meaning
TIP	Important information that helps you to use the system more effectively.

Hardcopy Manuals

- Operator's Manual [Basic Volume]
Describes the basic functions and operations of the system, safety precautions, exam modes, imaging modes, preset, maintenance and acoustic output, etc.
- Operator's Manual [Advanced Volume]
- Operator's Manual [Acoustic Power Data and Surface Temperature Data]
Contains data tables of acoustic output for transducers.
- Quick Reference Guide
Contains a quick reference guide for basic system operations.

NOTE:

- The accompanying manuals may vary depending on the specific system you purchased. Please refer to the packing list.
-

Software Interfaces in this Manual

Depending on the software version, preset settings and optional configuration, the actual interfaces may be different from those in this manual.

Conventions

In this manual, the following conventions are used to describe the buttons on the control panel, items in the menus, buttons in the dialog boxes and some basic operations:

- [Items in menu or buttons in dialog box]: square brackets indicate items in menus, on the soft menu or buttons in dialog boxes.
- Tap [Items or Buttons]: tap the corresponding item on the screen.
- [Items in menu] > [Items in submenu]: select a submenu item following the path.

Notification of Adverse Events

As a health care provider, you may report the occurrence of certain events to SHENZHEN MINDRAY BIO-MEDICAL ELECTRONICS CO., LTD., and possibly to the competent authority of the Member state in which the user and / or patient is established.

These events, include device-related death and serious injury or illness. In addition, as part of our Quality Assurance Program, SHENZHEN MINDRAY BIO-MEDICAL ELECTRONICS CO., LTD. requests to be notified of device failures or malfunctions. This information is required to ensure that SHENZHEN MINDRAY BIO-MEDICAL ELECTRONICS CO., LTD. provides only the highest quality products.

Operator's Manuals

The content of the operator manual, such as screens, menus or descriptions, may be different from what you see in your system. The content varies depending on the software version, options and configuration of the system.

Contents

Intellectual Property Statement	I
Responsibility on the Manufacturer Party	I
Warranty	II
Exemptions	II
Customer Service Department	II
Important Information	II
About This Manual	III
Meaning of Signal Words	III
Hardcopy Manuals	IV
Software Interfaces in this Manual	IV
Conventions	IV
Notification of Adverse Events	IV
Operator's Manuals	V
1 Important Information	1 - 1
1.1 Safety Precautions	1 - 1
1.2 Latex Alert	1 - 7
1.3 Parts that can be used within patient environment	1 - 8
2 System Overview	2 - 1
2.1 Intended Use	2 - 1
2.2 Contraindication	2 - 1
2.3 Safety Classifications	2 - 1
2.4 Product Specifications	2 - 2
2.4.1 Power supply	2 - 2
2.4.2 Environmental Conditions	2 - 2
2.4.3 Dimensions and Weight	2 - 3
2.5 Product Differences	2 - 3
2.6 System Configuration	2 - 4
2.6.1 Standard Configuration	2 - 4
2.6.2 Probes and Needle-guided Brackets Available	2 - 5
2.6.3 Options	2 - 5
2.6.4 Peripherals Supported	2 - 7
2.7 Introduction of Each Unit	2 - 7
2.8 ECG Module	2 - 9
2.9 Basic Operations	2 - 9
2.9.1 Screen Display	2 - 9
2.9.2 Control Panel	2 - 11
2.9.3 Select Exam Mode and Probe	2 - 12
2.9.4 Select the Imaging Mode	2 - 12
2.9.5 Imaging Adjustment	2 - 13
2.9.6 Quickly Saving Image Settings	2 - 13
2.9.7 Annotations and Body Marks	2 - 14
2.9.8 iVocal	2 - 15

2.9.9 Splitting Display	2 - 17
2.9.10 Image Magnification	2 - 17
2.9.11 iZoom (Full Screen View)	2 - 18
2.9.12 Freeze/Unfreeze the Image.	2 - 18
2.9.13 Imaging Mode Switching When Frozen	2 - 19
2.10 Cine Review	2 - 19
2.10.1 Entering/Exiting Cine Review	2 - 19
2.10.2 Manual Cine Review	2 - 20
2.10.3 Auto Review	2 - 21
2.10.4 Linked Cine Review	2 - 21
2.11 Symbols and Warning Labels	2 - 21
3 System Preparation	3 - 1
3.1 Move/Position the System	3 - 1
3.2 Connecting the Power Cord	3 - 1
3.2.1 Connecting Power	3 - 1
3.2.2 Powered by Batteries	3 - 1
3.3 Power ON/OFF	3 - 2
3.3.1 Check before Powering ON	3 - 3
3.3.2 Power the System ON	3 - 3
3.3.3 Check the system after it is powered on	3 - 4
3.3.4 Power the System Off	3 - 5
3.3.5 Standby	3 - 5
3.4 Monitor Brightness/Contrast Adjustment	3 - 6
3.5 Display Position Adjustment	3 - 6
3.6 Connecting/Disconnecting a Probe	3 - 6
3.6.1 Connecting a Probe	3 - 7
3.6.2 Disconnecting a probe	3 - 8
3.7 Connecting USB Devices	3 - 8
3.8 Connecting the Footswitch	3 - 9
3.9 Installing a Printer	3 - 9
3.9.1 Connecting a Graph/Text Printer	3 - 9
3.9.2 Connecting a Video Printer	3 - 9
4 Setup	4 - 1
4.1 System Preset	4 - 1
4.1.1 Region	4 - 1
4.1.2 General	4 - 2
4.1.3 Image Preset	4 - 3
4.1.4 Measure	4 - 4
4.1.5 OB	4 - 5
4.1.6 Footswitch Function	4 - 5
4.1.7 Probe Function	4 - 5
4.1.8 Option	4 - 5
4.1.9 Access Control	4 - 6
4.1.10 Scan Code Preset	4 - 8
4.1.11 Peripheral Preset	4 - 11
4.1.12 Maintenance	4 - 11
4.1.13 iVision	4 - 12

4.1.14 Security	4 - 13
4.1.15 System Information	4 - 14
4.2 Exam Related Preset	4 - 15
4.2.1 Exam Mode Preset	4 - 15
4.2.2 Measurement Preset	4 - 15
4.2.3 Body Mark/Comment Preset	4 - 16
4.2.4 iWorks Preset	4 - 17
4.3 Network Related Preset	4 - 18
4.3.1 DICOM Local Preset	4 - 18
4.3.2 DICOM Service Preset	4 - 20
4.3.3 eGateway Preset	4 - 25
4.3.4 Network Preset	4 - 27
4.3.5 Q-Path Preset	4 - 28
5 Exam Preparation	5 - 1
5.1 Patient Information	5 - 1
5.1.1 New Patient Information	5 - 1
5.1.2 Retrieve Patient Information	5 - 2
5.2 Activate an Exam	5 - 2
5.3 End an Exam	5 - 2
6 Image Acquisition	6 - 1
6.1 B Mode	6 - 1
6.1.1 B-mode Image Scanning	6 - 1
6.1.2 B-mode Image Parameters	6 - 1
6.2 Color Mode	6 - 4
6.2.1 Color Mode Image Scanning	6 - 4
6.2.2 Color Mode Image Parameters	6 - 4
6.3 Power Mode	6 - 6
6.3.1 Power Mode Image Scanning	6 - 6
6.3.2 Power Mode Image Parameters	6 - 6
6.4 M Mode	6 - 7
6.4.1 M Mode Image Scanning	6 - 7
6.4.2 M Mode Image Parameters	6 - 7
6.5 Color M Mode (CM)	6 - 8
6.5.1 CM Image Scanning	6 - 8
6.5.2 CM Image Parameters	6 - 8
6.6 Anatomical M Mode	6 - 8
6.6.1 Linear Anatomical M (Free Xros M)	6 - 9
6.6.2 Anatomical M Mode Parameters	6 - 9
6.7 PW/CW Mode	6 - 9
6.7.1 PW/CW Mode Image Scanning	6 - 9
6.7.2 PW/CW Mode Image Parameter	6 - 10
6.8 TDI	6 - 11
6.8.1 TDI Mode Image Scanning	6 - 12
6.8.2 TDI Mode Image Parameters	6 - 12
6.9 iScape View (Real-time Panoramic Imaging)	6 - 12
6.9.1 Basic Procedures for iScape Imaging	6 - 13
6.9.2 Image Review	6 - 14

6.9.3 Evaluate image quality	6 - 14
6.9.4 Cine Review	6 - 15
6.10 Smart B-line	6 - 15
6.10.1 Basic Procedures for Smart B-line	6 - 15
6.10.2 Overview	6 - 16
6.11 Smart VTI	6 - 17
6.12 Smart IVC	6 - 18
6.13 Contrast Imaging	6 - 19
6.13.1 Basic Procedures for Contrast Imaging	6 - 20
6.13.2 Left Ventricular Opacification	6 - 20
6.13.3 Image Parameters	6 - 21
6.14 Image Saving	6 - 22
6.15 Micro Flow Enhancement	6 - 22
6.16 Contrast Imaging QA	6 - 23
6.17 Auto GA	6 - 26
6.18 Smart FHR OB1	6 - 26
6.19 iWorks (Auto Workflow Protocol)	6 - 27
6.19.1 Overview	6 - 27
6.19.2 Normal iWorks Basic Procedure	6 - 27
6.19.3 View Operation	6 - 28
6.19.4 Manual Examination	6 - 28
6.19.5 Insert	6 - 29
7 Smart 3D	7 - 1
7.1 Overview	7 - 1
7.1.1 Terms	7 - 1
7.1.2 ROI and VOI	7 - 2
7.1.3 Render Mode	7 - 2
7.1.4 MPR	7 - 3
7.2 Note before Use	7 - 4
7.3 Smart 3D Image Acquisition	7 - 6
7.4 Smart 3D Image Viewing	7 - 7
7.5 Image Saving	7 - 10
8 Physiological Unit Signal	8 - 1
8.1 ECG	8 - 1
8.2 ECG Review	8 - 3
8.2.1 Review Principle	8 - 3
8.2.2 Linked Review of Waveforms, M/D Images and 2D Images	8 - 3
8.3 Parameter Description	8 - 3
9 Measurement, Annotations and Body Mark	9 - 1
9.1 Measurement	9 - 1
9.2 Annotations	9 - 2
9.2.1 Adding Annotations	9 - 2
9.2.2 Moving Annotations	9 - 3
9.2.3 Modifying (Editing) Annotations	9 - 3
9.2.4 Deleting Annotations	9 - 4
9.3 Body Mark	9 - 4

9.3.1 Adding Body Mark	9 - 4
9.3.2 Moving Body Marks	9 - 4
9.3.3 Deleting Body Marks	9 - 5
9.4 Voice Comments	9 - 5
9.4.1 Voice Comment Panel	9 - 5
9.4.2 Adding Voice Comments	9 - 5
9.4.3 Voice Comment Review	9 - 5
10 Patient Data Management	10 - 1
10.1 Image File Management	10 - 1
10.1.1 Storage Media	10 - 1
10.1.2 Image File Formats	10 - 1
10.1.3 Image Storage Setting	10 - 2
10.1.4 Saving Full Screen Images to the System	10 - 2
10.1.5 Image Review and Analysis	10 - 2
10.1.6 Sending Image Files	10 - 3
10.2 Report Management	10 - 3
10.2.1 Report storage	10 - 3
10.2.2 Importing, exporting and sending a report	10 - 3
10.3 iStation - Patient Data Management	10 - 4
10.3.1 Searching a Patient	10 - 4
10.3.2 Patient Data View & Management	10 - 4
10.3.3 Image Compare	10 - 5
10.4 Recycle bin	10 - 5
10.5 iStorage	10 - 6
10.6 Print	10 - 6
10.6.1 Image Printing	10 - 6
10.6.2 Report Printing	10 - 7
10.7 Back up Files using the DVD Drive	10 - 7
10.8 Patient Task Management	10 - 7
10.9 V-Access	10 - 9
10.10 Q-Path	10 - 9
11 DICOM/HL7	11 - 1
11.1 DICOM Storage	11 - 1
11.1.1 Send images on iStation/Review	11 - 1
11.1.2 To send images to storage after an exam ends	11 - 2
11.2 DICOM Print	11 - 2
11.2.1 Print images on iStation/Review	11 - 2
11.2.2 To send images to DICOM Print after an exam ends	11 - 2
11.2.3 To print images after saving image	11 - 2
11.3 Worklist	11 - 2
11.4 MPPS	11 - 3
11.5 Storage Commitment	11 - 3
11.5.1 After sending images on the iStation screen	11 - 3
11.5.2 Storage commitment after an exam ends	11 - 4
11.6 Query/Retrieve	11 - 4
11.7 DICOM Media Storage	11 - 4
11.7.1 Media Storage	11 - 4

11.7.2 Media review	11 - 5
11.7.3 Data Restore	11 - 5
11.8 Showcase Recording	11 - 5
11.9 Structured Report	11 - 6
11.9.1 Send structured reports for storage	11 - 6
11.9.2 Back up structured report	11 - 6
12 Probes and Biopsy	12 - 1
12.1 Probes	12 - 1
12.1.1 Probe Functions by Part	12 - 4
12.1.2 Orientation of the Ultrasound Image and the Probe Head	12 - 5
12.1.3 Procedures for Operating	12 - 6
12.1.4 Wearing the Probe Sheath	12 - 8
12.1.5 Probes Cleaning and Disinfection/Sterilization	12 - 10
12.1.6 Probe Environmental Conditions	12 - 14
12.1.7 Storage and Transportation	12 - 17
12.2 Biopsy Guide	12 - 17
12.2.1 Needle-guided Brackets Available	12 - 19
12.2.2 Needle-Guided Bracket Inspection and Installation	12 - 20
12.2.3 Verifying the Biopsy Guide Line	12 - 51
12.2.4 Starting the biopsy procedure	12 - 52
12.2.5 Clean and Sterilize the Needle-Guided Bracket	12 - 53
12.2.6 Storage and Transportation	12 - 55
12.2.7 Disposal	12 - 55
12.3 Middle Line	12 - 55
12.4 eSpacial Navi	12 - 56
12.4.1 Interface	12 - 57
12.4.2 Preset	12 - 58
12.4.3 Preparation Before Needle Guidance	12 - 58
12.4.4 Procedure	12 - 59
12.4.5 Magnetizer Cleaning and Disinfection	12 - 60
12.4.6 Storage and Transportation	12 - 62
12.4.7 Disposal	12 - 62
13 DVR Recording	13 - 1
13.1 Start Recording	13 - 1
13.2 Sending Image	13 - 1
13.3 DVR Video Replaying	13 - 2
13.3.1 Replay on PC	13 - 2
13.3.2 Replay on the ultrasound system	13 - 2
14 System Maintenance	14 - 1
14.1 Daily Maintenance	14 - 1
14.1.1 Cleaning the System	14 - 1
14.1.2 Disinfecting the Main Unit	14 - 4
14.1.3 Cleaning the peripherals	14 - 4
14.1.4 Checking the Probe	14 - 4
14.1.5 Checking the Power Cable and Plug	14 - 4
14.1.6 Checking Appearance	14 - 4
14.1.7 System Hard Drive Backup	14 - 4

14.2 Troubleshooting	14 - 5
A Barcode Reader	A - 1
A.1 1-D Barcode Reader	A - 1
A.1.1 Setting Up the Reader	A - 2
A.1.2 Setting	A - 2
A.1.3 Scanning in Hand-Held Mode	A - 5
A.1.4 Scanning in Hands-Free Mode	A - 6
A.2 2D Barcode Reader (Take DS4308 as an example)	A - 8
A.2.1 Overview	A - 8
A.2.2 Setting Up the Digital Imager Reader	A - 9
A.2.3 Setting	A - 9
A.2.4 Scanning in Hand-Held Mode	A - 13
A.3 Maintenance	A - 14
B Wireless LAN	B - 1
B.1 Use the Wireless feature	B - 2
B.2 IP Configure	B - 2
B.3 EAP Network	B - 2
B.4 Specifications	B - 3
B.5 Troubleshooting	B - 4
C Trolley and Accessories	C - 1
C.1 Trolley (UMT-400/UMT-400Plus)	C - 1
C.1.1 Trolley Accessories	C - 1
C.1.2 Introduction of Each Unit (taking UMT-400 as an example)	C - 2
C.1.3 Install Towelette Container	C - 3
C.2 Table Stand	C - 4
C.3 Wall Mount	C - 4
D iScanHelper	D - 1
D.1 Use iScanHelper for Reference	D - 1
D.2 Use iScanHelper for Learning or Training	D - 1
D.3 iScanhelper Menu	D - 2
D.3.1 View Selecting Area	D - 2
D.3.2 Help Information Area	D - 2
D.3.3 Single/quad-window Display	D - 3
D.4 Measurement, Comments, and Body Mark	D - 3
E iVision	E - 1
F List of Vocal Commands	F - 1
G Electrical Safety Inspection	G - 1
G.1 Power Cord Plug	G - 1
G.1.1 The Power Plug	G - 1
G.2 Device Enclosure and Accessories	G - 2
G.2.1 Visual Inspection	G - 2
G.2.2 Contextual Inspection	G - 2
G.3 Device Labeling	G - 2
G.4 Protective Earth Resistance	G - 2

G.5 Earth Leakage Test	G - 2
G.6 Enclosure Leakage Test	G - 3
G.7 Patient Leakage Current	G - 3
G.8 Mains on Applied Part Leakage	G - 4
G.9 Patient Auxiliary Current	G - 4
H EMC Guidance and Manufacturer’s Declaration	H - 1
I Acoustic Output	I - 1
I.1 Concerns with Bioeffects	I - 1
I.2 Prudent Use Statement	I - 1
I.3 ALARA Principle (As Low As Reasonably Achievable)	I - 1
I.4 MI/TI Explanation	I - 2
I.4.1 Basic Knowledge of MI and TI	I - 2
I.4.2 MI/TI Display	I - 3
I.5 Acoustic Power Setting	I - 3
I.6 Acoustic Power Control	I - 4
I.7 Acoustic Output	I - 4
I.7.1 Derated Ultrasonic Output Parameters	I - 4
I.7.2 Limits of Acoustic Output	I - 5
I.7.3 Differences between Actual and Displayed MI and TI	I - 5
I.8 Measurement Uncertainty	I - 5
I.9 References for Acoustic Power and Safety	I - 6
J Probe Dimensions	J - 1
K Indications for use	K - 1

1 Important Information

1.1 Safety Precautions

Please observe the following precautions to ensure patient and operator's safety when using this system.

CAUTION

U.S.A. Federal Law restricts this device to sale by or on the order of a physician.

DANGER

Do not operate this system and probes in an atmosphere containing flammable gases or liquids such as anesthetic gases, hydrogen, and ethanol, because there is danger of explosion.

WARNING

- Do not connect the three-wire cable of the system with a two-wire plug without protective grounding; otherwise, electric shock may result.
- Do connect the power plug of this system to wall receptacles that meet the ratings indicated on the rating nameplate. If adapters or multi-functional receptacles are used, it may cause the leakage current to exceed the safety requirement.
- In the environment that patient is 1.5 meters around, connect peripherals to the auxiliary power outlet, or power the peripherals by auxiliary output cable or isolation transformer complied with IEC60601-1 or the power input of the same safety level.
- DO NOT use power supply of different phases to power peripherals, like power supply of air-conditioning.
- When using peripherals not powered by the auxiliary output of the ultrasound system, or using peripherals other than permitted by Mindray, make sure the overall leakage current of peripherals and the ultrasound system meets the requirement of the local medical device electrical regulation (like enclosure leakage current should be no more than 500 uA of IEC60601-1), and the responsibility is held by the user.
- Connect the grounding conductor before turning ON the system. Disconnect the grounding cable after turning OFF the system. Otherwise, electric shock may result.

- For the connection of power and grounding, follow the appropriate procedures described in this operator's manual. Otherwise, there is risk of electric shock. Do not connect the grounding cable to a gas pipe or water pipe; otherwise, improper grounding may result or a gas explosion may occur.
- Before cleaning the system, disconnect the power cord from the outlet. System failure and electric shock may result.
- This system is not water-proof designed. Do Not use this system in any place where water or any liquid leakage may occur. If any water is sprayed on or into the system, electric shock may result or the system may be damaged. If water is accidentally sprayed on or into the system, contact Mindray Customer Service Department or sales representative.
- DO NOT use a probe that has a damaged, scratched surface, or exposed wiring of any kind. Immediately stop using the probe and contact Mindray Customer Service Department or sales representative. There is risk of electric shock if using a damaged or scratched transducer.
- Do not allow the patient to contact the live parts of the ultrasound system or other devices, e.g. signal I/O ports. Electric shock may occur.
- The operator SHOULD NOT touch Signal Input Ports/Signal Output Ports and the patient at the same time.
- Do not use an aftermarket probe other than those specified by Mindray. The probes may damage the system causing a profound failure, e.g. a fire in the worst case.
- Do not subject the transducers to knocks or drops. Use of a defective transducer may cause an electric shock.
- Do not open the covers and front panel of the system. Short circuit or electric shock may result when the system hardware is exposed and powered on.
- Do not use the system with the patient when the system is being serviced or maintained.
- Do not use this system when any digital device such as a high-frequency electrotonic, high-frequency therapeutic device or defibrillator is applied already. Otherwise, there is a risk of electric shock to the patient.
- Only use the ECG leads provided with the physiology module; otherwise, electric shock may be resulted.
- When moving the system, you should first fold the LCD display, disconnect the system from other devices (including probes) and disconnect the system from the power supply.
- When moving the system, disconnect the system from other devices (including probes) and disconnect the system from the power supply.
- The auxiliary power output outlet in the system is used to supply power for the recommended peripheral devices. Do not connect other devices to the outlet, otherwise, the rated output power may be exceeded and failure may be resulted.

- Accessory equipment (analog or digital) connected to the ultrasound system must comply with the relevant IEC standards (e.g., IEC 60950 information technology equipment safety standard and IEC 60601-1 medical equipment standard). Furthermore, all configurations must comply with the standard IEC60601-1. It is the responsibility of the person, who connects additional equipment to the signal input or output ports and configures a medical system, to verify that the system complies with the requirements of IEC60601-1. If you have any questions regarding these requirements, consult your vendor.
 - Prolonged and repeated use of keyboards may result in hand or arm nerve disorders for some individuals. Observe the local safety or health regulations concerning the use of keyboards.
 - When using intra-cavity transducers, do not activate the transducer outside the patient's body.
 - It is not allowed for the operator to have contact with other patients and the electronic parts (such as the input/output terminal of the signal) of other devices that are connected to the system. Otherwise, it may produce the electrical shock to the patient.
 - DO NOT block the cooling vent of the system.
 - Do not expose the device to a magnetic resonance (MR) environment.
-

CAUTION

- Precautions concerning clinical examination techniques:
 - This system must be used only by qualified medical professionals.
 - This operator's manual does not describe clinical examination techniques. The clinician should select the proper examination techniques based on specialized training and clinical experience.
- Malfunctions due to radio wave:
 - If a radio wave emitting device is used in the proximity of this system, it may interfere with operations. Do not use or take any devices transmitting RF signals (such as cellular phones, transceivers and radio controlled products) in the room placing the system.
 - If a person brings a device that generates radio waves near the system, ask him/her to immediately turn OFF the device.
- Precautions concerning movement of the system:
 - When you place the system on the mobile trolley and move them together, you must secure all objects on the mobile trolley to prevent them from falling. Otherwise you should separate the system from the mobile trolley and move them individually.
When you have to move the system with the mobile trolley upward or downward the stairs, you must separate them first and then move them individually.

- Object placed on the monitor may fall and injure an individual when moving.
- Confirm that there is no peripheral device connected to the system before moving the system. Otherwise, peripheral device may fall and injure an individual.
- If the circuit protector is tripped, it indicates that the system or a peripheral device was improperly shut down and the system is unstable. You cannot repair the system under this circumstance and must call the Mindray Customer Service Department or sales representative.
- There is no risk of high-temperature burns during normal ultrasound examinations. It is possible for the surface temperature of the transducer to exceed the body temperature of a patient due to environmental temperature and exam type combinations. Do not apply the transducer to the same region on the patient for a long time. Apply the transducer only for a period of time required for the purpose of diagnosis.
- Do not use the system to examine a fetus for a long period of time.
- Except accessories that have been stated as sterile, the system and its accessories are not disinfected or sterilized prior to delivery. The operator is responsible for the cleaning and disinfection of probes and sterilization of biopsy brackets according to the manuals, prior to the use. All items must be thoroughly processed to completely remove harmful residual chemicals, which will not only harmful to the human body, but also damage the accessory.
- It is necessary to end the current scan that is in progress and clear the current Patient Information field. Otherwise, new patient data may be combined with the previous patient data.
- Do not connect or disconnect the system's power cord or its accessories (e.g., a printer or a recorder) without turning OFF the system power first. This may damage the system and its accessories or cause electric shock.
- If the system is powered off improperly during operation, it may result in data damage of the system's hard disk or system failure.
- Do not use a USB memory device (e.g., a USB flash drive, removable hard disk) which has unsafe data. Otherwise, system damage may result.
- It is recommended to only use the video devices specified in this manual.
- Do not use gel, disinfectant, probes, probe sheath or needle-guided brackets that are not compatible with the system.
- The applied contrast agency should be compliant with the relevant local regulations.
- Read the Acoustic Output Principle in the operation manual carefully before operating this system on clinical examination.
- The cover contains natural rubber that can cause allergic reactions in some individuals.
- Please use the ultrasound gel compliant with the relevant local regulations.

- DO NOT expose the system to excessive vibration through transportation. Mechanical damage may result.
 - Always keep the system dry. Avoid transporting this system quickly from a cold place to a warm place; otherwise condensation or water droplets may form allowing a short circuit and possible electric shock.
-

NOTE:

- DO NOT use the system in the vicinity of strong electromagnetic field (such as a transformer), which may affect the performance of the system.
- Do not use the system in the vicinity of high-frequency radiation source (e.g. cellular phones), which may affect the performance of the system or even lead to failure.
- When using or placing the system, keep the system horizontal to avoid imbalance.
- To avoid damaging the system, do not use it in following environment:
 - Locations exposed to direct sunlight.
 - Locations subject to sudden changes in environmental temperature.
 - Dusty locations.
 - Locations subject to vibration.
 - Locations near heat generators.
 - Locations with high humidity.
- Turn ON the system only after the power has been turned OFF for a while. If the system is turned ON immediately after being turned OFF, the system may not be rebooted properly and could malfunction.
- Select the Freeze to freeze an image or turn off the power of the system before connecting or disconnecting a probe.
- Remove the ultrasound gel from the face of the transducer when the examination is completed. Water in the gel may enter the acoustic lens and adversely affect the performance and safety of the transducer.
- You should properly back up the system to a secure external storage media, including system configuration, settings and patient data. Data stored to the system's hard drive may be lost due to system failure, improper operation or accident.
- If the system is used in a small room, the room temperature may rise. Please provide proper ventilation and free air exchange.
- To dispose of the system or any part, contact Mindray Customer Service Department or sales representative. Mindray is not responsible for any system content or accessories that have been discarded improperly.
- Electrical and mechanical performance may be degraded due to long usage (such as current leakage or distortion and abrasion); the image sensitivity and precision may become worse too. To ensure optimal system operations, it is recommended that you maintain the system under a Mindray service agreement.
- Refer replacing job to Mindray service engineers or engineers authorized by Mindray only.
- Do not turn OFF the power supply of the system during printing, file storage or invoking other system operations. An interrupted process may not be completed, and can become lost or corrupted.
- Ensure that the current exam date and time are the same as the system date and time.

- Use detachable power supply cord as mains power breaking device. DO NOT set equipment in place where difficult for disconnection of detachable power supply cord.
-

Please read the following precautions carefully to ensure the safety of the patient and the operator when using the probes.

WARNING

- The ultrasound probe is only for use with the specified ultrasound diagnostic system.
 - The ultrasound probe must be used only by qualified professionals.
 - Confirm that the transducer and probe cable are normal before and after each examination. A defective probe may cause electric shock to the patient.
 - Do not subject the probe to shock. A defective probe may cause electric shock to the patient.
 - Do not disassemble the probe to avoid the possibility of electric shock.
 - Never immerse the probe connector into liquids such as water or disinfectant because the connector is not waterproof. Immersion may cause electric shock or malfunction.
 - A transducer sheath must be installed over the transducer before performing examination.
 - When using a probe, pay attention to the status of the ultrasound image. Do not use the probe to perform image acquisition when the image is frozen.
-

CAUTION

- When using the probe, wear sterile gloves to prevent infection.
 - Please use the ultrasound gel compliant with the relevant local regulations. And manage the ultrasound gel properly to ensure that it does not become a source of infection.
 - In normal diagnostic ultrasound mode, there is no danger of a normal-temperature burn; however, do not keep the probe on the same region of the patient for more than 10 minutes to avoid risk of burn.
 - Do not use the carrying case for storing the transducer. If the carrying case is used for storage, it may become a source of infection.
 - It is required to practice ALARA when operating ultrasound system. Minimize the acoustic power without compromising the quality of images.
 - The probe and accessories supplied with it are not delivered disinfected or sterilized. Sterilization (or high-level disinfect) before use is required.
 - Disposable components should be packaged sterile and for single-use only. Do not use if integrity of packaging violated or if expiration date has passed. Please use the disposable components compliant with the relevant local regulations.
-

- Please use the disinfection or sterilization solution recommended in this operator's manual; otherwise Mindray will not be liable for damage caused by other solutions. If you have any questions, please contact Mindray Customer Service Department or sales representative.
 - Do not use pre-lubricated condoms as a sheath. Lubricant may not be compatible with the probe material and damage may result.
 - The damage of the transducer may be caused by the contact of improper gel or cleaner:
 - DO NOT dip the transducer in the strong polar solution of ethanol, chloride of lime, ammonium chloride, acetone and formaldehyde.
 - DO NOT contact the transducer with solution or ultrasound gel containing oily medium such as mineral oil or lanoline.
-

NOTE:

- Read the following precautions to prevent the probe from malfunction:
 - Before connecting or disconnecting the probe, freeze or turn off the system.
 - Clean and disinfect the probe before and after each examination.
 - After the examination, wipe off the ultrasound gel thoroughly. Otherwise, the ultrasound gel may solidify and the image quality would be degraded.
 - Repeated disinfection will eventually damage the probe, please check the probe performance periodically.
-

1.2 Latex Alert

When choosing a probe sheath, it is recommended that you directly contact CIVCO for obtaining information regarding probe sheaths, pricing, samples and local distribution.

For CIVCO information, please contact the following:

CIVCO Medical Instruments

Tel: 1-800-445-6741

www.civco.com

WARNING

Allergic reactions in patients sensitive to latex (natural rubber) may range from mild skin reactions (irritation) to fatal anaphylactic shock, and may include difficulty breathing (wheezing), dizziness, shock, swelling of the face, hives, sneezing, or itching of the eyes (FDA Medical Alert on latex products, "Allergic Reactions to Latex-containing Medical Devices", issued on March 29, 1991).

1.3 Parts that can be used within patient environment

- The ultrasound system
-

- Video Printers

2 System Overview

2.1 Intended Use

NOTE:

The system is not intended for central cardiovascular or central nervous system use.

For FDA region

TE7/TE5/TE7 Max/TE5 Max/TE9 Diagnostic Ultrasound System is applicable for adults, pregnant women, pediatric patients and neonates. It is intended for use in fetal, Laparoscopic, abdominal, Intra-operative (abdominal, thoracic, and vascular), Pediatric, small organ (breast, thyroid, testes), neonatal and adult cephalic, trans-esoph. (Cardiac), trans-rectal, trans-vaginal, musculo-skeletal (conventional, superficial), urology, Peripheral vessel, Adult and Pediatric cardiac, ophthalmic, Thoracic/Pleural exams.

This device is a general purpose diagnostic ultrasound system intended for use by qualified and trained healthcare professionals for ultrasound imaging, measurement, display and analysis of the human body and fluid, which is intended to be used in a hospital or medical clinic.

Modes of operation include: B, M, PWD, CWD, Color Doppler, Amplitude Doppler, Combined mode (B+M, PW+B, Color+B, Power+B, PW+Color+B, Power+PW+B), Tissue Harmonic Imaging, Contrast imaging (Contrast agent for LVO), TDI, Color M, Smart 3D, Contrast imaging (Contrast agent for Liver), and iScape View.

For Canada region

TE7 Diagnostic Ultrasound System is applicable for adults, pregnant women, pediatric patients and neonates. It is intended for use in fetal, abdominal, intra-operative (abdominal, thoracic, and vascular), pediatric, small organ (breast, thyroid, testes), neonatal and adult cephalic, trans-esoph. (Cardiac), trans-rectal, trans-vaginal, musculo-skeletal (conventional, superficial), urology, peripheral vessel, adult and pediatric cardiac, ophthalmic exams.

2.2 Contraindication

This system is not intended for ophthalmic use.

2.3 Safety Classifications

- According to the type of protection against electric shock:
Class I equipment + internally powered equipment
- According to the degree of protection against electric shock:
Type-BF applied part
- According to the degree of protection against harmful ingress of water:
 - The main unit is rated IPX0
 - The probes are rated IPX7

- The foot switch (can be applied in the operating room) is rated IPX8.
- The power adapter is rated IPX1.
- According to the disinfection and sterilization method(s) recommended by manufacturer:
Equipment with disinfection and sterilization method(s) recommended by manufacturer.
According to the degree of safety of application in the presence of a FLAMMABLE ANESTHETIC MIXTURE WITH AIR OR WITH OXYGEN OR NITROUS OXIDE
EQUIPMENT not suitable for use in the presence of a FLAMMABLE ANESTHETIC MIXTURE WITH AIR OR WITH OXYGEN OR NITROUS OXIDE
- According to the mode of operation:
Continuous operation
- According to the installation and use:
Portable equipment
Mobile equipment (when the system is installed on the trolley)
- Does the equipment has any defibrillation-proof applied parts:
Non-defibrillation-proof applied part
- Permanently installed equipment or non-permanently installed equipment:
Non-permanently installed equipment

2.4 Product Specifications

NOTE:

The functions described in the operator's manual may vary depending on the specific system purchased.

2.4.1 Power supply

- Voltage: 100-240V~; 19Vdc (Main unit direct input)
- Frequency: 50/60Hz
- Power input: 2.0A (Power adapter); 3.5A (Trolley)
- Fuse: T5AL, 250VAC (Power adapter)
- Battery: 14.8Vdc

2.4.2 Environmental Conditions

- Operating conditions
 - Ambient temperature: 0 °C ~ 40 °C
 - Relative humidity: 30% ~ 85% (no condensation)
 - Atmospheric pressure: 700 hPa ~ 1060 hPa
- Storage and transportation conditions
 - Ambient temperature: -20 °C ~ 55 °C
 - Relative humidity: 20% ~ 95% (no condensation)
 - Atmospheric pressure: 700 hPa ~ 1060 hPa

⚠ WARNING

Do not use this system in conditions other than those specified.

2.4.3 Dimensions and Weight

15-inch screen

- Dimensions (including probe holder): 130±10 (Depth)×380±10 (Width)×380±5 (Height) mm
- Weight (including batteries, three-probe socket configuration and one probe): ≤ 7.2 kg

21.5-inch screen (For FDA region only)

- Dimensions (including probe holder): 128±10 (Depth)×410±10 (Width)×517±10 (Height) mm
- Weight (including batteries, three-probe socket configuration and one probe): ≤ 9 kg

2.5 Product Differences

Model	Double Dist	Depth	Parallel line	Spline length	Cross	Trace Len
TE7	√	√	√	√	√	√
TE5	×	×	√	√	√	√
TE7 Max	√	√	√	×	×	√
TE5 Max	√	×	×	×	√	√
TE9	√	√	√	√	√	×

NOTE:

Only TE7 is available in Canada.

2.6 System Configuration

NOTE:

The following features are available for FDA region only:

- Trolley: UMT-400Plus
- Probes: L12-3VNs, C9-3Ts, LAP13-4Cs, P8-2Ts, P8-3Ts, SP5-1Ns, SC5-1Ns
- Needle-guided brackets: NGB-043, NGB-044
- Options: Free Xros M, DICOM Small Parts SR, Smart FHR OB1, Auto GA, Smart Bladder.

2.6.1 Standard Configuration

- Main unit (select configuration between one-probe socket and three-probe socket)
- Batteries (built-in)
- System software

- Wireless adapter (built-in)
- Accessories
 - Operator’s manuals and Quick Reference Guide
 - Probe holder
 - Ultrasound gel
- Applied part: probes.

2.6.2 Probes and Needle-guided Brackets Available

Please refer to see “12 Probes and Biopsy”.

2.6.3 Options

No.	Item	Remarks
1.	ECG module	The ECG module should be configured.
2.	ECG cables	ECG module should be configured.
3.	DC-IN cable	ECG module should be configured.
4.	Travelling case	After the travelling case is configured, power adapter and cables must be selected.
5.	Trolley	See Appendix Trolley and Accessories for details.
6.	Wall mount/Table stand	After the wall mount/table stand is configured, power adapter and cables should be configured.
7.	VESA connector	After the VESA connector is configured, power adapter and cables should be configured.
8.	Power adapter	Table stand or wall mounting bracket should be configured.
9.	Power cable	The power adapter should be configured.
10.	External DVD recorder	/
11.	Footswitch	Types: 2-pedal/3-pedal
12.	Barcode reader	/
13.	iVocal microphone	iVocal should be configured.
14.	eSpacial Navi	/
15.	CW	/
16.	Free Xros M	/
17.	Contrast Imaging	/
18.	Contrast Imaging QA	Contrast Imaging should be configured.
19.	LVO	/
20.	iNeedle	/
21.	Tissue Doppler Imaging	Cardiology Package should be configured.
22.	Smart 3D	/
23.	iScape View	/

No.	Item	Remarks
24.	DICOM Basic	Including verify (SCU and SCP), task management, DICOM Storage, DICOM Print, DICOM Storage Commitment, DICOM Media Storage (including DICOM DIR)
25.	DICOM Worklist	DICOM Basic should be configured.
26.	DICOM MPPS	
27.	DICOM OB/GYN SR	
28.	DICOM Vascular SR	
29.	DICOM Cardiac SR	
30.	DICOM Query/Retrieve	
31.	DICOM Breast SR	
32.	DICOM Small Parts SR	
33.	Abdomen/General Package	/
34.	Obstetrics Package	/
35.	Gynecology Package	/
36.	Cardiology Package	/
37.	Small Parts Package	/
38.	Urology Package	/
39.	Vascular Package	/
40.	Pediatrics Package	
41.	Nerve Package	/
42.	Emergency & Critical Package	/
43.	IMT	Vascular Package should be configured.
44.	AutoEF	Cardiology Package should be configured.
45.	iVocal	iVocal microphone should be configured.
46.	iWorks	/
47.	DVR Module	/
48.	McAfee	/
49.	Smart IVC	/
50.	Smart VTI	Cardiology Package should be configured.
51.	Smart B-line	/
52.	Smart FHR OB1	Obstetrics Package should be configured.
53.	Auto GA	Abdomen Package should be configured.
54.	Smart Bladder	Abdomen Package or Urology Package should be configured.

2.6.4 Peripherals Supported

No.	Item	Model
1.	Black/white video printer(digital)	MITSUBISHI P95DW-N SONY UP-D898MD
2.	Black/white video printer (analog)	SONY UP-X898MD
3.	Digital color video Printer	SONY UP-D25MD
4.	Barcode reader	LS2208 DS4308 JADAK HS-1M JADAK HS-1R Honeywell HH1800
5.	Footswitch	971-SWNOM (2-pedals) 971-SWNOM (3-pedals)
6.	External DVD R/W drive	DVDRW HP GP70
7.	iVocal	SAMSONXPD2

2.7 Introduction of Each Unit

Figure 2-1 Overview of 21.5-inch screen

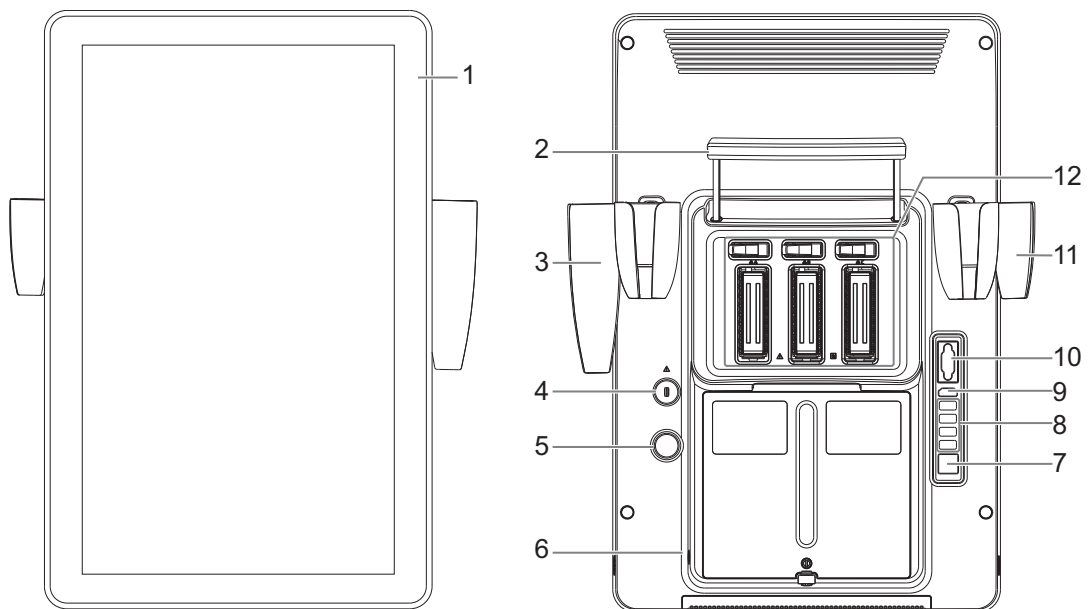
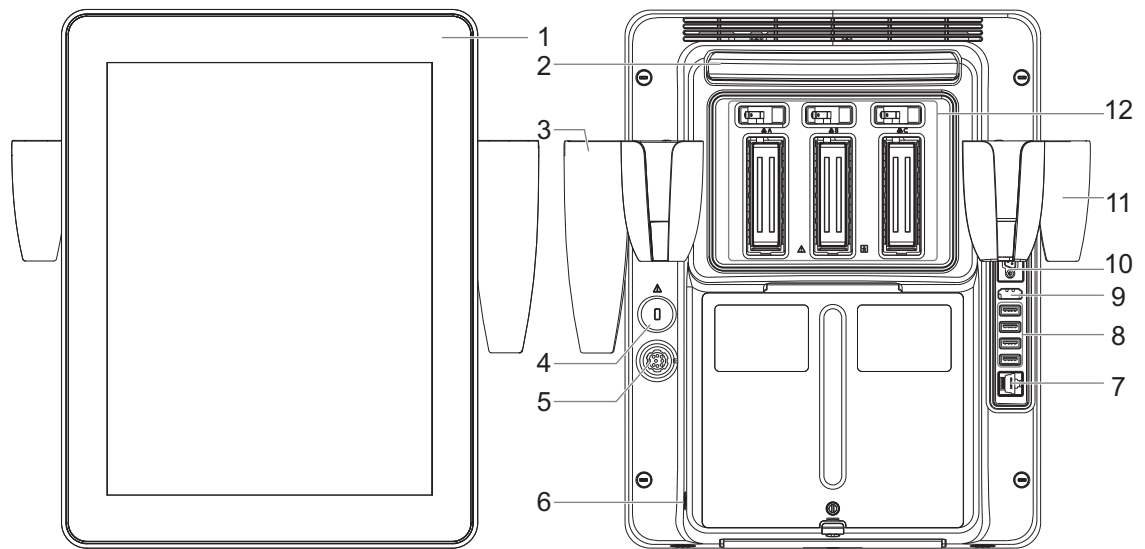





Figure 2-2 Overview of 15-inch screen



No.	Name	Function
1.	Touch screen and display	Operator-system interface or control; displays the image and parameters during the scan.
	 Battery status indicator	<ul style="list-style-type: none"> Charging status: It illuminates in orange when batteries are charging; It illuminates in green when batteries are charged fully. Discharging status: It illuminates in green color when the power of the batteries is sufficient; It blinks in orange color for low battery power.
	 AC indicator	The indicator is green at AC supply. The indicator is off when batteries are supplied without AC supply.
	 Standby indicator	Standby: blinking in orange. Other status: light off.
2.	Telescoping handle	Used for moving the system occasionally.
3.	Intra-cavity probe holder	Used for placing the probe.
4.	Probe locking switch	Locks or unlocks the probe connecting with the main unit.
5.	Power inlet	Connects with the power adapter.
6.	Power button	Press to turn on the system, the system enters the work status.
7.	Network port	Used for connecting router, ultrasound workstation, server, etc.
8.	USB ports	Used for connecting storage device such as USB disk, bar code reader, printer, footswitch, DVD recorder, etc.

No.	Name	Function
9.	HDMI	High definition multimedia interface. Used for connecting TV, projector, ultrasound workstation video capture card, etc.
10.	Serial port for connecting ECG	Connects to the serial port for connecting to ECG of the system.
11.	Probe holder	Used for placing the probe.
12.	Probe ports	Connects a probe to the main unit.

2.8 ECG Module

Figure 2-3 ECG module

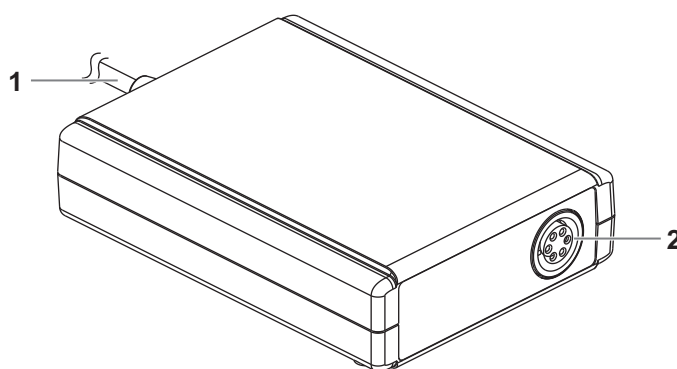

No.	Name	Description
1.	Serial connector	Connects to the serial port of the system. NOTE: Ensure the system is powered off before connecting the ECG module.
2.	ECG lead port	Used for ECG signal input.

2.9 Basic Operations

2.9.1 Screen Display

TIP:

The contents displayed on screen may differ depending on the screen size.

The screenshot displays the main ultrasound interface. At the top, a status bar shows the date and time (11-03-2021 18:28:22) and patient information (C5-2s Adult ABD). Technical parameters include AP 96.6%, MI 0.88, and TIS 0.6. A central B-mode image shows a cross-section of tissue with a blue 'm' marker. To the left of the image is a vertical scale labeled '1'. To the right is a depth scale labeled '10' and '9', with a green arrow indicating the current depth. Below the image are five buttons: 'Needle' (2), 'iTouch' (3), 'Image Quality' (4), and 'TGC' (5). On the far right, there are 'iScan Helper' (7) and navigation arrows (8). The bottom section features a 'Patient' menu (6) with sub-options: 'Image', 'Cine', 'Measure', 'Annotate', and 'iWorks'. The 'Image' sub-menu is active, showing settings for 'Middle Line' (toggle), 'iClear' (slider at 4), 'iBeam' (slider at 1), 'Dyn Ra.' (slider at 130), 'Gray Map' (slider at 1), 'Tint Map' (set to Off), and 'ExFOV' (set to Off with buttons for 1 and 2). To the right of these settings are buttons for 'Color', 'PW', 'M', 'Smart VTI', 'Smart IVC', and 'Smart B-line'. At the very bottom are buttons for 'End', 'Update', 'Save Image', 'Save Clip', 'Print', and 'Freeze'.

No.	Name	Function
1.	Parameter Area	Displays the image parameters for the active window. If there are more than one imaging modes, the parameters are displayed by each mode.
2.	iNeedle button	Select to enter/exit iNeedle
3.	iTouch button	Select to optimize the images.
4.	Image Quality button	Select to switch B/THI and adjusting the frequency.
5.	TGC button	Select to slide to adjust the depth gain.
6.	Control panel	Consists of imaging mode buttons, menu area and exam related buttons.
7.	iScanHelper button	Select to enter/exit iScanHelper status.
8.	iZoom button	Select to enter/exit full-screen zoom status.
9.	Depth control	Select to adjust the depth in real-time imaging.
10.	Gain control	Adjust the gain of the image in various modes.
11.	System tool button	Access the system tools.
12.	System icons area	Displays the relevant system icons, such as USB memory device, network, task manager, used space of the hard disk, etc.

2.9.2 Control Panel



No.	Name	Function
1.	Exam operating area	Tap each button to enter the screen. <ul style="list-style-type: none"> • Patient information • Exam mode and probe switching • iStation • Image review • Report review.
2.	Functional buttons	You can perform operations using those buttons, including End exam, Update, Save image, Save Clip, Print and Freeze/Unfreeze image.
3.	Imaging mode area	Tap imaging buttons to start imaging.
4.	Menu area	<ul style="list-style-type: none"> • Imaging parameter menu: swipe the menu downwards/upwards to see parameter controls. • Cine review menu (under frozen or cine review status). • Measurement menu. • Annotation and body mark menu.

2.9.3 Select Exam Mode and Probe

CAUTION

If the exam mode is changed during a measurement, all measurement calipers on the image will be cleared. The data of general measurements will be lost, but the data of application measurements will be stored in the reports.

Perform the following procedure:

1. Connect suitable probes to the system and tap [Probe] button on the operating control panel. The screen displays the Probe and Exam dialog box.

2. Select the probe type and exam mode.

The system exits the dialog box and enters the selected exam mode and probe.

Tap [Exit] or [Probe] again to cancel the selection and exit the screen.

2.9.4 Select the Imaging Mode

Switch between imaging modes according to the actual situation using the corresponding imaging button located in the imaging mode area.

2.9.5 Imaging Adjustment



Perform the following procedure:

1. Tap [Image] on the control panel to open the image parameter control menu under different imaging modes.
2. Swipe the menu downwards/upwards to check and change parameter controls.

2.9.6 Quickly Saving Image Settings

TIP:

The [Quick Save] and [Edit] controls are available under all imaging modes.

Create a new exam mode using current image settings (user-defined exam mode)

Perform the following procedure:

1. Tap [Quick Save] in the image menu to bring out the Quick Save dialogue box.

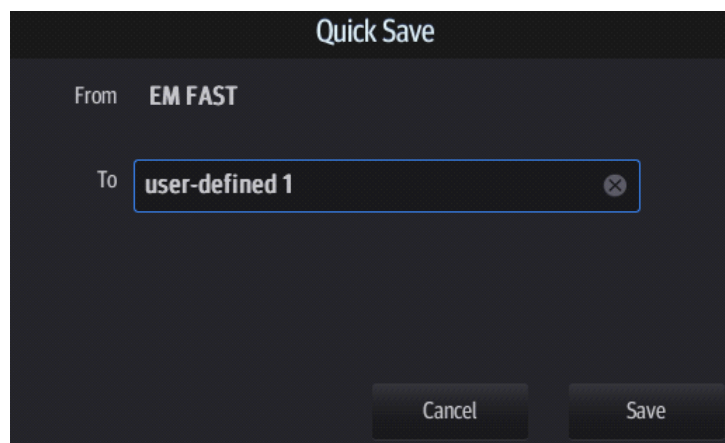

2. Enter the name in the box after “To” to assign a name for a user-defined exam mode.
3. Tap [Save] to save the current image parameters for the user-defined exam mode.

Check image parameter and change layout

Perform the following procedure:

1. Tap [Edit] in the image menu to enter the screen for checking the current image menu display for the current exam mode of the particular probe.
2. Tap and hold any parameter until it floats, then you can:
 - Drag upwards/downwards to change its position on the image menu;
 - Drag leftwards/rightwards to change its display on the image menu: drag it to the left “Options” list to delete its display or drag it to the right “Selected” list to display the parameter.
3. Tap [Save] to save the settings or tap [Cancel] to cancel changes you made.

2.9.7 Annotations and Body Marks

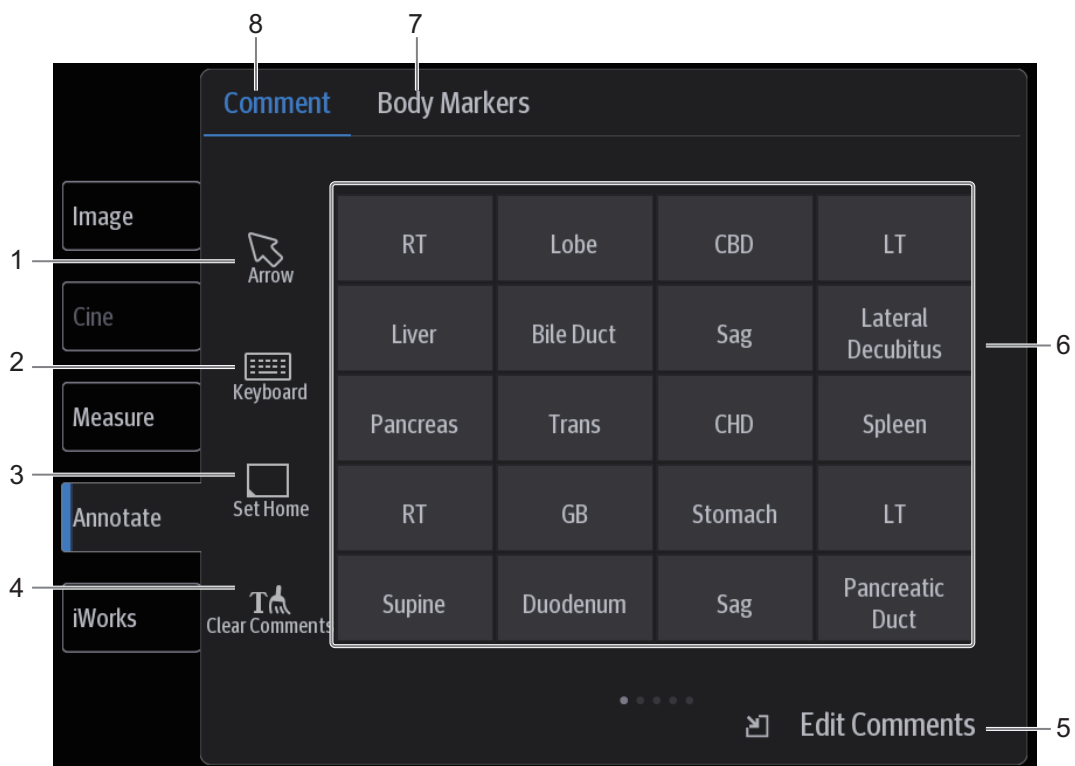

No.	Name	Function
1.	Arrow button	Tap to add arrow a comment to the image.
2.	Keyboard button	Tap to activate the soft keyboard to type the alphanumeric characters.

No.	Name	Function
3.	Set Home button	Tap to activate the home box, and move the home box to the target position, then Tap the Set Home button again to set the start position of the comment. NOTE: This function is only available for the system of 21.5-inch screen.
4.	Clear Comments button (on Comment menu)	Tap to delete all the annotations.
	Clear Markers button (on Body Markers menu)	Tap to delete the added body mark.
5.	Edit Comments button (on Comment menu)	Tap to enter comment preset page, you can add custom comments and change comment layout.
	Edit Markers button (on Body Markers menu)	Tap to enter body mark preset page, you can change body mark layout.
6.	Annotation text library	System preset comments. If there is more than one page of comment texts for the current exam mode, you can slide to view more.
7.	Body Markers tab	Tap to enter bodymark status.
8.	Comment tab	Tap to enter text/arrow comment status.

2.9.8 iVocal

TIP:

- If the microphone is not to be used for the moment, you can put the microphone into the vacant probe holder temporarily.
- When the iVocal function is enabled, the system can perform operations both through inputting vocal commands and through tapping icons on the touch screen.
- The ultrasound system can automatically recognize some vocal commands. For details about the vocal commands, see “F List of Vocal Commands”.
- Currently, only wireless microphone devices can be inserted to the system for inputting vocal commands.

Before enabling the iVocal function, ensure that the microphone device and the ultrasound system is properly connected through the USB extension wire.

Inputting vocal command

Perform the following procedure:

1. Tap the  icon in the Audio Control menu to start the vocal command recognition.

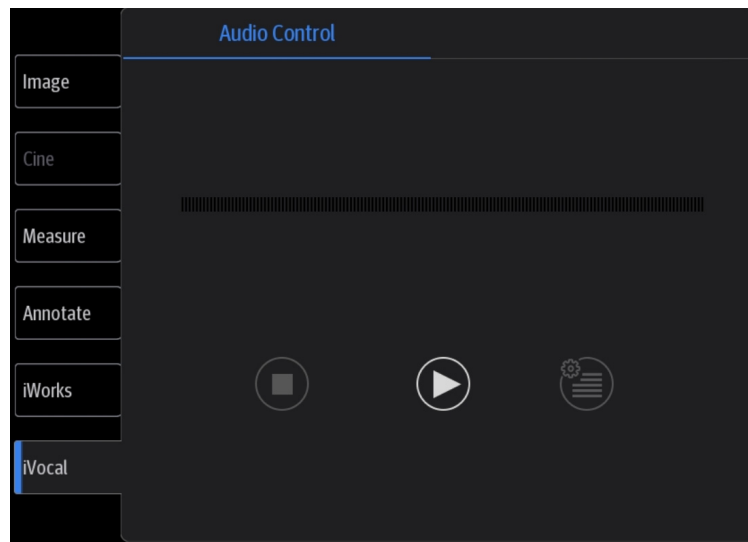

2. Input a vocal command using the microphone, and after the command is recognized, the system automatically performs the corresponding operation.

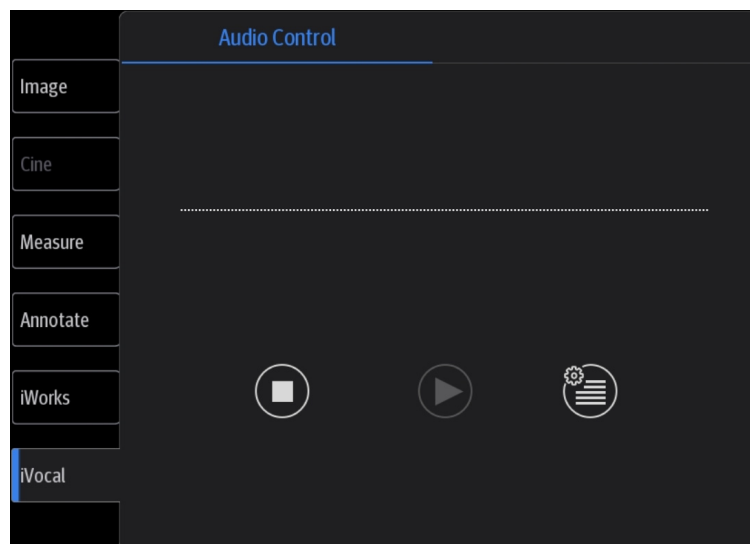

3. Tap the  icon in the Audio Control menu to pause the vocal command recognition.

Setup

Tap the  icon in the Audio Command menu to check the system recognizable commands and enter the iVocal Setup menu.





- Add: tap [Add] to enter the Adding New Command menu, tap [Function Description] to select the desired function, enter the user-defined command in the [Command] text box, and then select OK.

User-defined command naming rules: only Chinese characters, English letters, and digits are supported; the English letters are case-insensitive, consecutive blank spaces are not supported, and a maximum of 128 letters are allowed when entering the English letters; Blank spaces are not supported and a maximum of 30 characters are allowed when entering the Chinese characters; the user-defined commands cannot be empty; User defined commands that are already existed in the system but represent different functions are not supported to be added.

- **Test:** Tap [Test] and input a vocal command to the microphone device. After the vocal command is recognized, the Success Rate is displayed in fraction. Tap [Test] again to close the vocal command test.

If the vocal command is successfully recognized by the system, both the denominator and numerator of the Success Rate are added by 1 for each time; if the vocal command fails to be recognized by the system, the denominator of the Success Rate is added by 1 for each time through tapping the  icon, while the numerator remains the same. For example: 2/3 represents 2 times of success and 1 time of failure.

- **Clear:** Tap [Clear] to clear all the Success Rate test records.
- **Recover:** Tap [Recover] to enter the Confirm menu. You can select Yes to restore to the default settings.

Icon	Function
	Audition the vocal command
	Delete the vocal command
	Rename the vocal command
	Add the failure time by 1
	Clear the Success Rate test record of the selected vocal command

2.9.9 Splitting Display

The system supports dual-split display format. However, only one window is active.

Dual split:

1. Select [Dual] to be “on” from B image menu to enter dual-split mode.
2. Tap each window to switch the active window (marked with “m” icon.)
3. Tap [B] or select [Dual] to be “Off” to exit to single window.

2.9.10 Image Magnification

NOTE:

Zooming an image changes the frame rate which tends to change thermal indices. The position of the focal zones may also change which may cause the peak intensity to occur at a different location in the acoustic field. As a result, the MI may change.

Do one of the following to zoom in/out the image:

- Use two fingers to pinch on the image area to zoom in/out the image.
- Use [Zoom Value] in the image parameter control menu to change the magnification factor.
For the following mode, you need to tap [Image] > [B] to highlight B menu first.
 - B+Color
 - B+M

- B+PW/CW
- B+Color+PW/CW
- B+Power+PW/CW

The image magnification factor value will display in real time in the image parameter area.

2.9.11 iZoom (Full Screen View)

This feature magnifies the image area in full screen for a better observation.

For 21.5-inch screen

- To enter iZoom: Tap  on the screen.



- To exit iZoom: Tap  on the screen.

For 15-inch screen

- To enter iZoom: Swipe the screen from the top to the bottom.
- To exit iZoom: Tap [Exit iZoom] button on the screen; or, swipe the screen from the bottom to the top.

2.9.12 Freeze/Unfreeze the Image.

Tap [Freeze] in the bottom-right corner of the control panel to freeze a scanning image. In freeze mode, the probe stops transmitting acoustic power, and all images and parameters are frozen.

TIP:

After freezing an image, the system may enter cine review, measure, comment adding, body mark mode or current mode, depending on what has been preset.

Tap [UnFreeze] in freeze mode to unfreeze the image, and the system continues image scanning.

2.9.13 Imaging Mode Switching When Frozen

Imaging mode switching in freeze mode follows these principles:

- In splitting display B mode, tap each image window to switch between the windows.
- In freeze mode, the system supports imaging mode switching between the sub-modes (only for the activated window). For example, if the frozen image is in B+Color+PW mode, the system supports imaging mode switching between B+Color+PW, B+Color, B+PW and B by tapping [Color] or [PW].

2.10 Cine Review

After tapping [Freeze], the system allows you to review and edit the images prior to the image being frozen. This function is called cine review. You can perform zoom, measurements, add comments and body marks on the images being reviewed.

The system supports manual review as well as automatic review.

In addition, the system supports the images reviewed along with physiological waveforms, if the detection of physiological waveforms is performed.

⚠ CAUTION

- Cine Review images can be inadvertently combined in-between separate patient scans. The Cine Review memory must be cleared at the end of the current patient exam and before starting the next new patient exam by tapping [End] in the bottom-left corner of the control panel.
 - Cine files stored in the system's hard drive should contain patient information, to avoid the selection of an incorrect image file and potential misdiagnosis.
-

2.10.1 Entering/Exiting Cine Review

To Enter Cine Review

- Enter [Setup] > [System] > [Image] > “Freeze Config” screen to set “Status after Freeze” to “Cine.” The system enters manual cine review status once [Freeze] is tapped.
- Open cine files in Review screen. The system enters automatic cine review status.

Under cine review status, cine review control bar will be displayed on the cine menu.

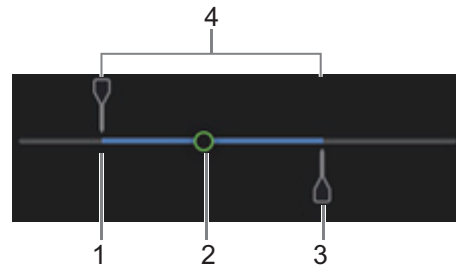

1	Start mark
2	Playback mark
3	End mark
4	Auto Review Region

For B/B+Color/B+Power mode, bottom-left corner will indicate current frame and total frames.

Frame:400/943

For B/B+M/B+PW/B+CW mode, bottom-left corner will indicate time played and total time.

Sec.3.1/3.1

To Exit Cine Review

Tap [Freeze] or [B] and the system will return to image scanning and exit cine review.

2.10.2 Manual Cine Review

After entering cine review in 2D mode, drag playback mark to review the cine images on the screen one by one.

Drag the playback mark to the left to display the earlier stored images; drag the playback mark to the right to display the recently stored images.

Or, swipe the image area to the right to display the earlier stored images; swipe the image area to the left to display the recently stored images.

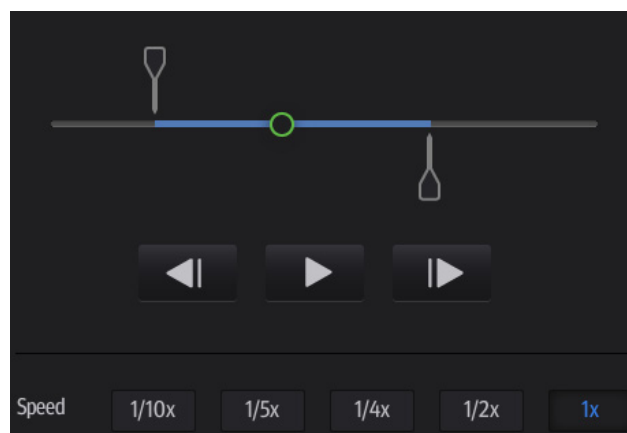

The cine progress control panel (as shown in the figure below):



2.10.3 Auto Review

Reviewing all



Perform the following procedure:

1. In manual cine review status, tap  to activate auto cine review.
2. Review speed: in auto cine review status, tap to select different speeds: 1/10x, 1/5x, 1/4x, 1/2x, 1x.
3. In auto play status, tap  to stop auto play.

Setting the Auto Review Region

You can set a segment of cine loop which can be reviewed automatically. After the auto review region is set, the auto cine review can only be performed within this region; but the manual cine review can be performed beyond this region.

Perform the following procedure:

1. Set first frame: drag the start mark to the frame as start point.
2. Set end frame: drag the end mark to the frame as end point.
3. Tap  to start play and select the speed.
4. Tap  to end auto play.

TIP:

When the cine file is saved, only images within the auto review region are saved.

2.10.4 Linked Cine Review

Linked cine review reviews images captured at the same moment.

- B+M
- Duplex mode (B+PW/CW)
- Triplex mode



1	Frame synchronization mark
---	----------------------------















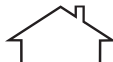

The frame mark on the time mark of the M/PW/CW image indicates the corresponding 2D image.











2.11 Symbols and Warning Labels

This system uses the symbols and warning labels listed in the following table to describe the important information and potential hazards.

The warning labels use the same signal words as those used in the operator's manual. Read operator's manual carefully before using the system.



The name, pattern and meaning of each symbol and warning label are described as follows:

Symbol	Description
	Type-BF applied part The ultrasound probes connected to this system are type-BF applied parts. The ECG leads within this system is type-BF applied part.
	Read this information carefully before using the system.
	Caution!
	Standby
	No user serviceable parts (applied to the power adapter)
	Battery installation position
	Indoor, dry location use only (applied to the power adapter)
	Transducer sockets
	AC (Alternating current)
	Foot switch
	USB port
	Extending port
HDMI	High definition multimedia interface
	Unlock position
	Lock position
	Network port
	Standby status indicator
	Battery status indicator

Symbol	Description
	Equipotentiality
	Product serial number
	Manufacture date
	Manufacturer
19V  7.9A MAX	Power consumption
 4kg/8.8lbs	Maximum load for printer bracket on the UMT-400 trolley
AC 100-240V 50/60Hz 240VA 	UMT-400 Trolley output
 3kg/6.8lbs	Maximum load for storage bin on the HMT-600 trolley
Rx Only	Federal law restricts this device to sale by or on the order of a licensed healthcare practitioner (USA).
<p>The following labels are available when the system works with the mobile trolley.</p> 	<ol style="list-style-type: none"> 1. Do not place the system with the mobile trolley on a sloped surface. Otherwise the system may slide, resulting in personal injury or the system malfunction. Two persons are required to move the system over a sloped surface. 2. DO NOT sit on the trolley. 3. When the casters are locked, DO NOT push the trolley.
<p>ETL CLASSIFIED</p>  <p>Intertek 3179617</p>	<p>CONFORMS TO AAMI Std. ES 60601-1, IEC Std. 60601-2-37, IEC Std. 60601-2-18; CERTIFIED TO CSA Std. C22.2 NO. 60601-1, 60601-2-37, 60601-2-18</p>
	MR Unsafe – the system is not intended to be used within magnetic resonance (MR) environment.

Symbol	Description
	Non-ionizing radiation

The general meaning assigned to geometric shapes, safety colors and contrast colors for safety signs are as follows:

Geometric shape	Meaning	Safety color	Contrast color	Graphical symbol color
	Prohibition	Red	White	Black
	Mandatory action	Blue	White	White
	Warning	Yellow	Black	Black

This page intentionally left blank.

3 System Preparation

3.1 Move/Position the System

Read and understand the safety precautions before positioning the system to ensure the safety of both the operator and the devices.

1. Switch off the power, and pull out the power plug.
2. Disconnect all cables from off-board peripheral devices.
3. Place the system in a desired location.

Leave at least 20 cm at the back and both sides of the system.

CAUTION

Maintain a generous, free air flowing space around the back and both sides of the system. Not doing so may result in failure due to the increased rise in the system's operating temperature.

3.2 Connecting the Power Cord

This system can work normally only when it is connected to the external power supply or the battery capacity is sufficient.

3.2.1 Connecting Power

1. Connect the connector of the power adapter to the adapter port in the system.
 2. Use a three-wire cable to connect the adapter with the external power supply.
- If you have any question about the power adapter, please contact your sales representative.

NOTE:

- You must use the specified power adapter.
 - Do not use this power adapter in the conditions other than those specified.
-

3.2.2 Powered by Batteries

When connected to the external power supply, the system is powered by the external power. The lithium ion batteries inside it are in the charging status, the indicator turns off when the capacity is full.

When disconnected from the external power supply, the system is powered by the lithium ion batteries.

WARNING

- The battery is inside the machine. Only Mindray technical professionals or engineers authorized by Mindray following training can perform battery installation and uninstallation.
 - If you need to change the battery or buy a new one, contact your sales representative.
 - The replacement of lithium batteries by inadequately trained personnel could result in a HAZARD (such as excessive temperatures, fire or explosion).
 - The lithium-ion battery has a service life of five years. Replace your battery when it reaches the end of its service life.
-

Battery Performance

When the system is working, the battery charges when its capacity is not full. The indicator turns off when the capacity is full.

- Under power off or standby status, charging time of the battery from capacity 0 to 100% takes less than 4 hours.
- The system lasts more than 22 hours in standby mode with full battery.

NOTE:





Power off the system if it will not be used for a long period of time (including storage/transportation condition). Do not leave the system in standby status, otherwise the batteries will be discharged and permanently damaged.

Battery specification

- Voltage: 14.8 V
- Capacity: 5800 mAh (single battery)

Battery Status Indicator

The battery status indicator is located in the top-right corner of the screen, indicating the battery status.

- For 15-inch screen:
 -  indicates charging status.
 -  indicates discharging status.
- For 21.5-inch screen:
 - : Indicates the battery capacity is nearly empty.
 - : Indicates the battery capacity is full.

3.3 Power ON/OFF

CAUTION

To ensure safe and effective system operation, you must perform daily maintenance and checks. If the system begins to function improperly,

immediately stop scanning. If the system continues to function improperly, fully shut down the system and contact the Mindray Customer Service Department or a sales representative. If you use the system in a persistent improperly functioning state, you may harm the patient or damage the equipment.

3.3.1 Check before Powering ON

Check before the system is powered on:

- The temperature, relative humidity and atmospheric pressure meet the requirements of the operating conditions. For details about the operating conditions, see the System Overview chapter.
- There is no condensation.
- There is no distortion, damage or dirt on the system and peripheral devices.
If any dirt is found, cleaning shall be performed, see the Probe and Biopsy chapter.
- There are no loose screws on the display or the trolley.
- There is no cable damage (e.g., power cord). Maintain secure connections to the system at all times.
- The probes and probe cables are free from damage or stains.
For details of probe cleaning and disinfection, see the Probe and Biopsy chapter.
- No miscellaneous odds and ends are attached or affixed to the display.
- Ensure that all connections are free from damage and remain clear of foreign object blockages.
There are no obstacles around the system and its air vent.
- Probe cleaning and disinfection.
- The entire scanning environment and field must be clean.
- The locking mechanism of the casters (if there is a trolley) works normally.

3.3.2 Power the System ON

Press the power button to power the system on.

If access control has been set by the system administrator, you can access data in the system only after logging onto the system. For details, see the Setup chapter.

You must log in again after system restart or dormancy.



To login onto the system

Perform the following procedure:

1. Select the login type (Local or LDAP), and user name in the drop-down list.
2. Enter the password and tap [Login].

To change users

Perform the following procedure:

1. Tap  in the top-right corner of the screen and select  to bring up the following dialog box:

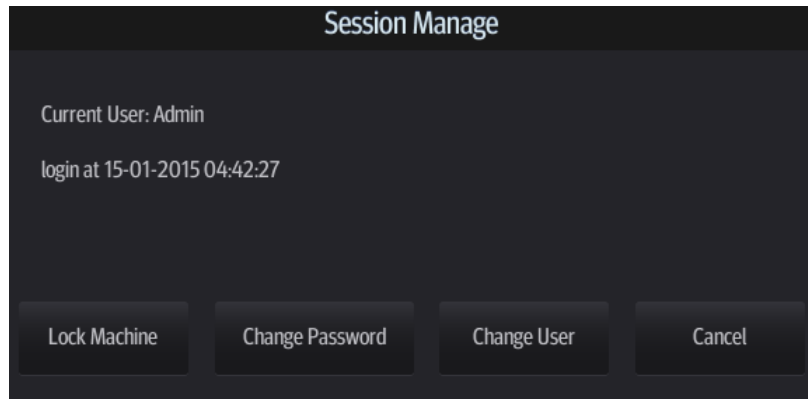



2. Tap [Change User] to bring up the Login dialog box.
3. Select the login type, and user name from the drop-down list.
4. Enter the password and tap [Login].



To modify password

General operators and administrators can modify the password.

Perform the following procedure:

1. Tap  in the top-right corner of the screen and select  to bring up the dialog box.
2. If you want to modify the current password, tap [Change Password] to bring up the Change Password dialog box.
3. Enter both the previous and new passwords, and confirm the new password in the dialog box.
4. Tap [OK] to exit.

To lock the system

Tap  in the top-right corner of the screen and select  to lock the system for 10 seconds.

3.3.3 Check the system after it is powered on

Check after the system is powered on:

- There are no unusual sounds or smells indicating possible overheating.
- There are no persistently displayed system error messages.
- There is no evident excessive noise, or discontinuous, absent or black items in the B mode image.
- Check whether there is abnormal heat on the surface of the probe during an ultrasound procedure. If you use a probe which is giving off excessive heat, it may burn the patient.
- The display (main screen) can respond functionally.
- The date and time are displayed correctly.

WARNING

- If you use a probe giving off excessive heat, it may burn the patient.
 - If you find anything not functioning properly, this may indicate that the system is defective. In this case, shut down the system immediately and contact Mindray Customer Service Department or sales representative.
-

NOTE:

When you start the system or switch between transducers, you will hear clicking sounds – this is expected behavior.

3.3.4 Power the System Off

You must follow the correct procedures to power the system off. Also, after you upgrade the software or when the system is down, you need to power off and restart it.

If you will not use the system for a long period of time, you shall:

- Disconnect the power adapter.
- Disconnect the mains power.
- Turn off powers of all peripherals connected to the system.

To power the system off

Perform the following procedure:

1. Press the power button to see the option:
 - Shut Down: to power the system off normally.
 - Standby: to enter standby status.
 - Cancel: to cancel the operation.
 2. Select [Shut Down] to power the system off.
-

NOTE:

- Press and hold the power button for a long time and the system will power off without displaying the “Shutdown Confirm” screen. However, shutting down the system this way may destroy the data.
 - DO NOT rush direct shutdown of the system. It may damage the data.
 - After the system is upgraded, use [Shut Down] to power the system off to make the upgraded data effective.
-

3.3.5 Standby

NOTE:

- Power off the system if you will not use the system for a long period of time (including storage/ transportation condition), and you should not allow the system in standby status, otherwise the batteries will be out of power and permanently damaged.
 - If the system will not be used for a long period of time, you should disconnect the power adapter, disconnect the mains power, and turn off the power to all peripherals connected to the system.
-

To enter standby

- Set the time for screen saver and standby, see the Setup chapter. If the system is not carrying out an operation, the screensaver appears after the screensaver delay period. If there is still no operation, the system enters standby after the standby delay period.
- Press the power button and select “Standby”.

To exit standby



- Touch the screen lightly.
- Press the power button.

3.4 Monitor Brightness/Contrast Adjustment

Perform the following procedure:

1. Tap  in the top-right corner of the screen to open the system tool bar.



2. Drag the slider to change the brightness/contrast on the brightness control  or contrast control .

NOTE:

Avoid operating in direct sunlight or the touch screen could be obscured.

3.5 Display Position Adjustment

Gently hold the bottom edge of the display when adjusting its position.

When positioned vertically, the display can be tilted for 5° backward and 5° forward.

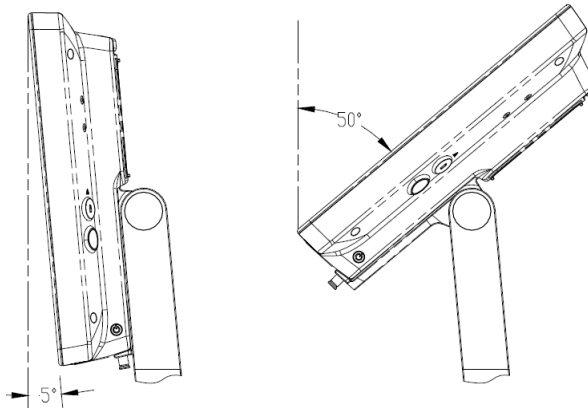

3.6 Connecting/Disconnecting a Probe

CAUTION

- Use [Freeze] to freeze an image or turn off the power of the system before connecting/disconnecting the probe. Otherwise, system or probe failure may occur.
- When connecting or disconnecting a probe, place it in the proper position to prevent the probe from falling off or becoming damaged.

- Only use probes provided by Mindray. Aftermarket probes may result in damage or cause a fire.

3.6.1 Connecting a Probe

WARNING

The probes, cables and connectors should be in proper operating order and free from surface defects, cracks and peeling. Otherwise, this may lead to electrical shock.

NOTE:

Before inserting the connector into the probe port, inspect the connector pin. If the pin is bent, do not use the probe until it has been inspected/repaired/replaced.

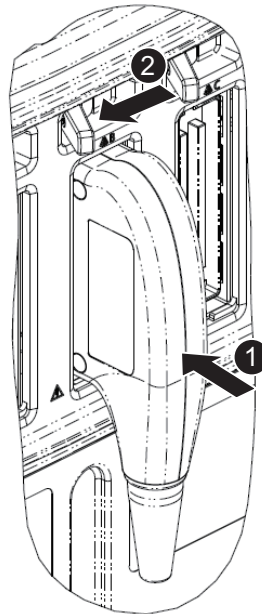

Perform the following procedure:

1. Keep the cable end of the transducer to the bottom side of the system; insert the connector into the system port, then press in fully.
2. Toggle the locking lever to the left position.
3. Position the probe properly to avoid it being treaded on or becoming wrapped around other devices. **DO NOT** allow the probe head to hang free.

3.6.2 Disconnecting a probe

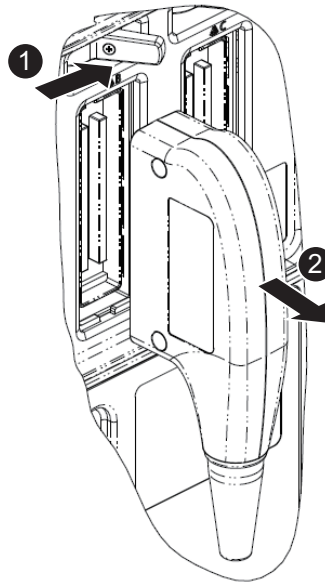

Perform the following procedure:

1. Turn the locking lever to the right position to unlock the connector.
2. Pull the probe connector straight out as shown in the figure.

3.7 Connecting USB Devices

⚠ WARNING

DO NOT directly remove a USB memory device, as the USB device and/or the system may become damaged.

- When connecting a USB memory device to the ultrasound system via a USB port, a sound is heard if it is connected successfully and the USB icon appears in the system icons area.
- To remove the USB device: tap the USB icon to open the [Remove USB Device] screen. Select the device to be removed and tap [OK]. A sound is heard when removing the USB memory device.
- The system supports option of external DVD R/W drive. The DVD R/W drive is connected to the ultrasound system via USB port.

NOTE:

- When connecting an external DVD R/W drive, connect the two cables of the drive to the ultrasound system or USB ports on the trolley if the drive provides 2 USB power cables. In this way, the DVD R/W drive can work more normally.
- If the USB disk cannot be recognized by the system, please try disconnecting and then connecting again several times, or try another USB disk. If the problem still exists, please contact Mindray service engineer.

3.8 Connecting the Footswitch

The system supports USB port-type foot switches.

The function of the foot switch can be preset. For details, see the Setup chapter.

3.9 Installing a Printer

TIP:

- Unless otherwise specified, printers listed in the System Overview chapter have drivers installed already.
- If the printer driver is required, please contact Mindray Customer Service Department or sales representative.
- Please refer to the accompanying manuals of the printers for more details.

3.9.1 Connecting a Graph/Text Printer

As shown in the figure below, a graph/text printer has a power cord and data cable. The power cord shall be directly connected to a wall receptacle as required.

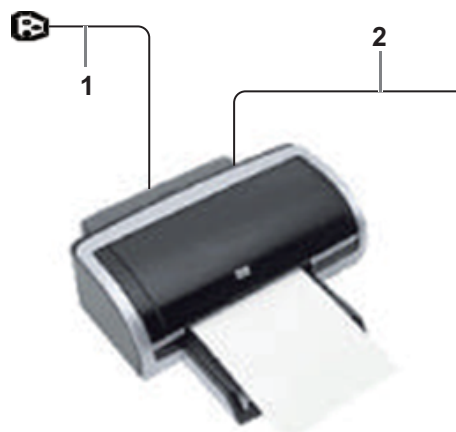

1	Power supply cable	Connect to power supply.
2	Data cable	Connect to the USB port of this system.

Perform the following procedure:

1. Connect the data cable to USB port of the ultrasound device.
2. Power on the system and the printer.
3. Preset the default report printer and its attribute:
 - a. Enter “[System] > [Peripheral] > [Print Service]” screen.
 - b. Select the “Report Print” column in the Service Type list.
 - c. In the “Property” frame, select printer from the driver list next to “Printer” in the lower screen and set the items.
 - d. Tap [Save] after you have finished setting.

3.9.2 Connecting a Video Printer

The digital video printers that system supports consist of the B/W printers and color printers.

Perform the following procedure:

1. Place the printer appropriately.
2. Connect the power cord of the printer to a receptacle. Connect the USB port of the system to the USB port of the printer with USB cable.
3. Load a paper roll and turn on the system and printer.
4. Add a print service:
 - a. Enter “[System] > [Peripheral] > [Print Service]” screen.
 - b. Tap [Add Service] to enter the page.

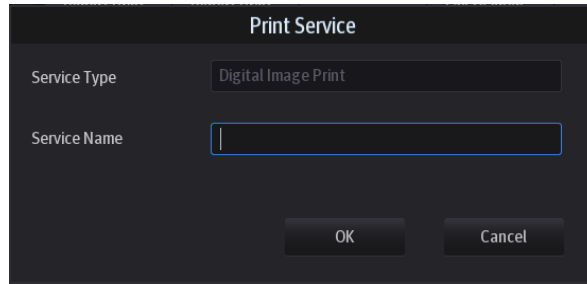



- c. Select the service type and enter the service name manually.
- d. Tap [OK] to return to the page.
- e. Select the target printer from the drop-down list in the “Property” box and set other printing properties.
- f. Tap [Save] to complete.

4 Setup

The Setup function is designed to set the configuration parameters of operating the system and maintaining user workflow setup data. The setup data of the user and system are stored to the hard drive, and should be backed up to CD/DVD or USB memory device.

CAUTION

When the preset data is changed, be sure to save the preset data according to the methods described in this chapter. Mindray is not responsible for the loss of preset data.

- To enter Setup: Tap  in the top-right corner of the screen and select  to enter the setup menu.
- To exit Setup:
Select [Save] in the Setup menu. The parameter settings are saved.
Select [Cancel] in the Setup menu to close the Setup menu.
If you change the system language and tap [Save] in the Setup menu, the system automatically shuts down to make the modification effective.

TIP:

configuration parameters may not be all fit on one screen view, swipe downwards to see more options.

4.1 System Preset

4.1.1 Region

Set the hospital name, language, time zone, time format and system date/time.

Item	Description
Hospital Information	To set the hospital-relevant information such as name, address, telephone, and so on.
Language	To select a language for the system.
Load Logo	Import image for logo loading. NOTE: For a better display effect, please try to use an image with 400*400 pixels.
Time Zone	To select the time zone.
Time Format	To select the time format.
Date Format	To set the date format.

Item	Description
System Date	To set the date for the system.
System Time	Move the cursor over the corresponding field and enter the time manually using the keyboard, or, move the cursor over the time segment.
Time Synch	To assign a time server and make the time of the ultrasound machine consistent with the server.

4.1.2 General

Set patient information, exam setup, patient management, storage, system dormancy, auxiliary output setting and so on.

Type	Item	Description
Patient Info	Info displays in an image banner	To select whether to display the available patient information items on the top of the screen.
	H&W Unit	To set the unit for calculating patient height and weight.
	Surface Formula	To set the surface formula.
	ID Display	To set whether to display ID or MRN on the top of the screen.
Exam Setup	Status after exam ends	To set the system status when an exam ends.
	Maximum number of exams to be kept	To set the maximum number of exams to be kept in iStation. NOTE: The patient exams which exceed the preset maximum will be deleted and unrecoverable, it is recommended to perform patient data backup before enabling this function to avoid data loss.
Patient Management	Sending/printing after End Exam	Select whether to automatically archive the exam data to the DICOM server for storage/print.
Live Capture (except for real-time contrast imaging mode)	Prospective Cine Length	To set the cine length for prospective live capture.
	Retrospective Cine Length	To set the cine length for retrospective live capture.
	Clip Length	To set the cine length and heart cycle.
	Save Clip	To set the mode for [Save Clip] button on the operating panel: Prospective or Retrospective.
Peak Hold (for real-time contrast imaging mode only)	Prospective Cine Length	To set the cine length for prospective live capture.
	Retrospective Cine Length	To set the cine length for retrospective live capture.
	Clip Length	To set the cine length and heart cycle.
	Save Clip	To set the mode for [Save Clip] button on the operating panel: Prospective or Retrospective.

Type	Item	Description
Image/clip Storage	While Storing Image to Hard Disk	To set if an image is sent to local default printer/DICOM Storage/DICOM Printer/iStorage/USB flash drive when the image is saved.
	While Storing Image to Hard Disk	To set if cine is sent to DICOM Storage/iStorage/USB flash drive when the cine is saved.
Storage	Image Size	To set the image size when saving an image or print an image.
	Save Image Beep	To set the key volume for saving single/multi-frame image.
Screen Saver	Screen Saver	<ul style="list-style-type: none"> To select a system dormancy type. After the screen saver function is enabled, tap [Browse] to select the figure used for the screen saver and tap [Preview] to see the effect. Only BMP format images with no more than 768*1024 pixels and 1-bit/8-bit/24-bit/32-bit depth are supported. To set the delay before the system enters dormancy/standby/iZoom status in the drop-down list beside "Wait."
iZoom (For 21.5-inch screen)	iZoom when Startup	To set enter the iZoom mode automatically when startup.
Comments and Body Markers	Clear Bodymark upon Unfreeze	To set if body marker is cleared when the system is unfrozen.
	Clear comments while unfreezing image or changing probe/exam	To set if body markers/comments are cleared during unfreeze or changing probe/exam.
AVI Encode	Export file format Setting	To set cine format in the [Send To] dialog box.
	Encode Quality	To set the quality of the cine.
iVocal	Automatically shut down waiting time(min)	To set the delay before voice recording stops automatically.
	Enable Voice Response	After it is ticked, the system will repeat recorded voice commands automatically.
Voice Annotation	Voice comment enabled	After it is ticked, the voice annotation function will be enabled.

4.1.3 Image Preset

Controls are as follows:

Type	Item	Description
Reset Config.	Probe	To set the default probe model for the system.
	Use the default set-ting when start a new exam	After it is ticked, when the exam of a new patient is started, image parameters will be preset parameters.
Probe/Exam mode	MITI	To set MI TI indexes displayed for current probe/exam mode.
Freeze Con-fig	Status after Freeze	To set the system status after the image is frozen.
Image	Steer	To set the steer mode in B + Color + PW imaging mode. <ul style="list-style-type: none"> • C&PW: select to adjust the sample volume in color mode and sample line in PW mode together. • C/PW: select to adjust the sample volume in color mode and sample line in PW mode separately.
	Auto Invert	The spectrum can automatically invert when the color flow is steered to a certain angle, thus accommodating the operator's wish to distinguish the flow direction.
	B+Color Refresh with PW/CW Sampling Line Movement	To set whether to turn on the function that when moving PW/CW sampling line, B image is activated under B+Color+PW/CW mode.
	Full Image (Linear)	After it is ticked, if a linear probe is used and the depth value is low, the image will be displayed completely.
	iScape Ruler Display	To set if the caliper is displayed on the iScape view image.
	Display Probe SN	To set if the probe SN is displayed next to the probe model.

4.1.4 Measure

Controls are as follows:

Item	Description
Cursor Type	Type of cursor displayed on the measurement caliper and results window. Value options: <ul style="list-style-type: none"> • Number: the cursor always displays as “+” while different measurements are marked with numbers. • Symbol: the cursor displays sequentially in 8 symbols to identify different measurements.
Cursor Size	The size of the cursor.

Item	Description
Heart Beat	The number of cardiac cycles in the heart rate calculation. (In heart rate measurement, the number of cardiac cycles should match the preset number.)
Cursor Line Display	If unselected, the connecting line between the measuring ends will be hidden after measurement.
Ellipse Cross Line Display	If unselected, the measuring axis within the ellipse area will be hidden after measurement.
Unit Setting	To set the units of measure items in batches.

4.1.5 OB

Perform the following procedure:

1. Set the default formula.
 - a. On the [Fetal Gestational Age], [Fetal Growth] or [Fetal Weight] page, select an Item in the left column.
 - b. Select a formula in the right column.

On the [Fetal Gestational Age] page, select whether to display the SD or EDD in the obstetric result.

2. Set the fetal weight display.
 - a. Enter the [Fetal Weight] page.
 - b. Tap [Fetal Weight Unit].
Select Metric, English or English & Metric from the drop-down list.
 - c. Select the formula for calculating the weight percentile.
Select the formula from the drop-down list of [EFW-GP].
3. Tap [Save] to confirm.

4.1.6 Footswitch Function

You can assign a function to the left/middle/right key of the foot switch.

4.1.7 Probe Function

You can assign a function to the user-defined keys of the selected probe.

Perform the following procedure:

1. Select the probe model to be set from the drop-down list of [Probe].
2. Set the key function from the drop-down list.

4.1.8 Option

The system enters the Option page after entering the Maintenance screen. In the Option list, the system lists all the system-supported options and their installation status (not installed or installed).

To install and uninstall:

- Tap [Install] to begin installing a disabled option.
- Tap [Uninstall] to begin uninstalling a previously-installed option.

Please contact the Mindray Customer Service Department or a sales representative for details.

4.1.9 Access Control

The system supports two types of users: administrator and operator.

- Administrator

The system administrator can access all function modules, and view all patient data, such as patient information, images and reports, etc. Only one administrator is configured by default. The administrator can add or delete operators.

- Operator

The operator can only access the function modules with assigned privileges. The operator can only view exam information saved in the system and operated by him or herself, such as patient information, images and reports, etc.

Enabling Access Control

The system administrator can preset the access controls, that is, whether an operator has the right to access data in the system.

Access control only can be set by the system administrator.

Open the “Access Control” page:

- If “Enable User Account Control” is selected, you must be authorized before accessing the data, and you can configure password policy and LDAP, and change password. If unselected, you can access all the data without authorization, and you cannot configure password policy and LDAP, and change password.
- If “Enable Emergency User” is selected, the administrator can edit privileges for emergency users. If unselected, the administrator cannot edit privileges for emergency users.

Adding a User/Assigning privilege

Turn on the access control function and log in to the system as Administrator before you add the user.

1. Tap [Add] to bring up the “Adding New User” dialog box.
2. Enter the user name and password, confirm password, and select or deselect the check box from the privilege list. Users can only access the function module with assigned privilege.
3. Tap [OK] to confirm the settings and exit the dialog box. The new user and the privilege will appear in the User List.

Deleting a User

Turn on the access control function and log in to the system as Administrator before you delete the user.

Select the user to be deleted in the User List. Tap [Delete] to delete the selected user.

Editing Privilege

Turn on the access control function and log in to the system as Administrator before you edit privileges.

1. Select a user, tap [Edit Privilege] to enter the "Edit user privilege" dialog box, and select or deselect the check box from the privilege list.
2. Tap [OK] to confirm the editing and exit the dialog box. The edited privileges will appear in the User List.

Modify Passwords

The system administrator can modify all user passwords. The administrator password is empty by factory default. You can set this password.

An operator can only modify his/her own password.

1. Select the user name to be modified in User List. Tap [Change Password] to open the dialog box.
2. Enter the new password and confirm the password, and then tap [OK].

Configure Password Policy

Turn on the access control function and log in to the system as Administrator before you configure the password policy.

Tap [Password Policy Config]:

Item	Description	Remark
Lockout Threshold	Set the maximum time that a user can input the wrong password. If you exceed the maximum times, your account will be locked.	For example, assume that the “Lockout Threshold” is set to 5, the “Reset Account Lockout Threshold after” is set to 60, and the “Lockout Duration” is set to 60. That is, a user inputs the wrong password for 5 times within 60 minutes, the account is locked, and the user can log in to the system only after 60 minutes. Other users with unlocked accounts can still log in to the system normally.
Reset Account Lockout Threshold after	Set the duration allowed for a user to continuously input the wrong password.	
Lockout Duration	Set the duration after an account is locked.	
Reset all lockout	Reset all locked accounts.	/
Enable strong password	<p>Enable strong password to improve security.</p> <ul style="list-style-type: none"> • If the strong password is enabled and you log in to the system with the account that is added before the strong password is enabled, the system prompts a warning message to inform you whether your password conforms to the password policy. The administrator can change password for administrator or operator. • If the strong password is enabled and you add a new user account, the system prompt an error message to inform you that the password is too weak, please modify the password according to the error message. 	/

LDAP Privilege Management

Turn on the access control function and log in to the system as Administrator before you edit privileges for the LDAP (Lightweight Directory Access Protocol) users.

1. Select the LDAP type: LDAP or AD.
2. Enter the server address in the field box.
3. If LDAP type is selected, enter “Root DN” at the same time, and you can also import SSL certificates if needed by checking “SSL”.

4. Enter the User name and password in the field boxes of the Authentication test area, and tap [Test LDAP server] to test whether the LDAP server is accessible. If the LDAP is accessible, the system prompts the following message “Server test succeeded.”

Item	Description
Days to keep cached password	<p>Set days to keep the cached passwords in the local system. Users can log in to the server even without accessing the network within the setting days.</p> <ul style="list-style-type: none"> • Empty: the passwords are kept in the local system permanently. • 0: no passwords are kept in the local system. • ≥ 1: for example, if it is set to 5, the passwords are kept in the local system for 5 days.
Member of filter/Privilege	<ul style="list-style-type: none"> • Enter the member name, and select or deselect privileges from the drop-down list of “Privilege”. • Tap [Add], and the new members and privileges will appear in the Member of filter list. • Select a member to be deleted, and tap [Delete]. • Select a member to be modified, modify the member name, and select or deselect privileges from the drop-down list of “Privilege”. Tap [Modify], and the modified member name and privileges will appear in the Member of filter list.
Logon Test	<ol style="list-style-type: none"> 1. Enter the User name and password in the field boxes of the Authentication test area. 2. Tap [Logon Test] to test whether the user is authenticated.
User field name	<p>Select [Use user field name] to customize the user field name. After that, the members and privileges cannot be edited.</p> <p>Enter the user field name in the field box of the “User field name” (the user field names are configured in the LDAP server. For details, please refer to the LDAP server manual).</p> <p>The user field name corresponding to privileges are as follows:</p> <ul style="list-style-type: none"> • iStation Access: 1 • Save Exam: 2 • Export Exam: 4 • Network Settings: 8 • Maintenance Menus: 16 • System Settings: 32 • Workflow Settings: 64 • Worklist Access: 128 <p>NOTE:</p> <p>The privilege items can be combined randomly. For example, if user A is assigned with all the above 8 privileges, the user field name for user A is $1+2+4+8+16+32+64+128=255$.</p>

4.1.10 Scan Code Preset

Set the code parameters for barcode reader.

1-dimension barcode reader (1D)

Item	Description
Scan Item	<p>After scanning 1D bar code, the regular expression is matched in the priority order: “Patient ID > Other ID > First name > Last name > Middle name > Accession# > Operator > Diagnostician”. If the regular expression is matched successfully, the data of 1D bar code will be displayed in this item in Patient page automatically.</p> <p>Example: The data of the bar code is 123 after scanning 1D bar code. The regular expression is matched in the priority order: “Patient ID > Other ID > First name > Last name > Middle name > Accession# > Operator > Diagnostician”. If the regular expression of “Other ID” is matched successfully, “123” will be displayed in “Other ID” item in Patient page automatically.</p>
Regular Expression	Set the regular expression according to the bar code format.
Append Options	<p>The information of operator or diagnostician can be appended after selecting the check box.</p> <p>For example, after scanning a 1D barcode of an operator or diagnostician, the obtained data is A, and A will be displayed in “Operator” or “Diagnostician” item in Patient page automatically.</p> <p>After scanning a 1D barcode of an operator or diagnostician for a second time, the obtained data is B, and A will be appended by B in “Operator” or “Diagnostician” item in Patient page automatically.</p>
Default Item	<p>If the default item is set to “No”, and both the 2D and 1D barcodes fail to be matched, the obtained data of the barcode is input as a string of characters. After selecting a default item from the drop down list of “Default Item”, the obtained data of the scanned barcode will be displayed in the corresponding selected default item.</p> <p>For example, if the default item is set to “Patient ID”, and both the 2D and 1D barcodes fail to be matched, the obtained data is displayed in the “Patient ID” item in Patient page automatically.</p>
Move Up/Down	Move up or Move down a selected item.
Add/Delete	Add or delete a selected item. (Only the default item can be added or deleted.)
Load default	Restore the parameter value to the default value.
Worklist Options	<ul style="list-style-type: none"> • Select “Worklist server” from the drop-down list, and the system searches the Worklist server according to the scanned data. • Select “No” from the drop-down list, and the system creates a new exam in the Patient page according to the scanned data.

Item	Description
Worklist Default	<ul style="list-style-type: none"> Select a default item for searching the Worklist server. For example, users select “Patient ID” from the drop down list of “Worklist Default”, and the system searches Patient ID in the Worklist server. Select “No”, and the system searches the Worklist server in the priority order: “Patient ID” > “Last name” > “Accession #”. <p>NOTE:</p> <p>The matching priority order is 2D item, 1D item, and Default Item, after the 1D/2D and default items are configured.</p>
Import/Export	Import and export configuration files to preset the barcode. For details, please contact the service engineer.

2-dimension barcode reader (2D)

- General Analysis Mode
Select “General” from “Analysis Mode” drop-down list: The scan codes consist of Patient ID, Other ID, Patient Name, Birth, etc.

Item	Description
Scan Barcode Example	Input a barcode example, barcode example is separated by separators (the separator is used to set the start and end position of each item), and the barcode data is displayed in the following items in turn.
Parameters	<ul style="list-style-type: none"> Input a barcode example, and you can change the information of Patient ID, Other ID, First Name, Last Name, Middle Name, Birth (Day), Birth (Month), Birth (Year), Age, Gender and etc. in the “Content” list. <p>Note: Ignore item is used to add one line below the selected item to hide unimportant patient information.</p> <ul style="list-style-type: none"> Set the start and end position of each item via separators. After inputting a barcode example, you can select item separators from the drop-down list of the Separator. (Only separators that are input in the field box of the Scan Barcode Example can be displayed in the drop-down list of the Separator.) <p>NOTE:</p> <p>You can customize the age unit of Birth (Day), Birth (Month), Birth (Year) in the Content column. If the DOB provided by the patient contains only digit, the system displayed an auto-generated age.</p>
Age Unit	Select an age unit from the drop-down list of the “Age Unit”: Year, Month, or Day.
Male/Female	Input the customized gender symbol besides the Male and Female field box, such as Male (M) or Female (F).
Select DOB format	Select DOB format.

- Advanced Analysis Mode
Select “Advanced” from “Analysis Mode” drop-down list: user enters scan barcode example and regular expression and click [Match], the system will match scan barcode example with

regular expression automatically, and if which is matched successfully, the scan item will display the barcode by separators.

4.1.11 Peripheral Preset

This screen is used to set up the printer and image printing.

Print Setting

The printer settings are as follows:

Item	Description
Add Service	Tap to begin adding print services.
Remove Service	Tap to delete the selected print service.
Rename Service	Tap to rename the selected print service.
Property	Preset print service properties.

Image Settings

Tap [Image Setting] to enter the page, you can set the brightness, contrast and saturation of image printing, or you can use the default values.

Display

Tap [Display] to enter the page, you can set output resolution and range for the connected external display.

4.1.12 Maintenance

The [Maintenance] function is designed for you to import or export user data, restore factory setting and export log. You may also execute self-test and option installation/trial through the maintenance menu. If you require other maintenance functions, please contact Mindray Customer Service Department or sales representative.

Exporting Setup Data

This function is used to write all setup data of the system into a disk for backup. The format of the data file is .PDP.

You can select the following types of preset data to export from the system:

- General module preset data.
- Exam mode related preset data.

Perform the following procedure:

1. Select the target module.
2. Tap [Export] to open the [Export Module Data] screen.
3. Select the path to save the data.
4. Select the exported file and type as PDP and tap [OK].

Importing Setup Data

This function is used to import the existing setup data to the setup data memory of the system. The system will reset and operate according to the setup preferences that were imported.

Perform the following procedure:

1. Tap [Import] to open the Load Data screen.

2. Select the imported file.
3. Tap [OK], a progress bar will appear and the setup data is imported to the specified path.
4. To restore the factory setup data, tap [Load Factory] on the right side of the screen.

Probe Check

This function is used to check the condition of transducer elements to evaluate the probe performance.

Before performing the probe check, ensure the probe head must be clean and the probe is in non-scanning state.

Tap [Probe Check] to enter the Probe Check screen:

- If a transducer element is in malfunction, it is displayed as a red spot.
- If a transducer element functions well, it is displayed as a green spot.

You can export the result image to the external device.

Other Settings

Other preset settings are described as follows:

Item	Description
Load Factory	Local factory default settings.

	Item	Description
Setup	Show Metrics Logs	Show the metrics logs, such as login count, total usage time, user metrics details, exam mode metrics details or probes.
	Extract Preset Data	/
	Export Log	Export the log.
	Self Test	Perform system self-test and restart the machine.
	Recover	To recover the system.
	Enter Windows	For password, please contact the service engineer.
	Needles List Replace	Update the list of needles that support eSpacial Navi function. NOTE: The list of needles must be release version provided by Mindray.
	Needles List Recover	Restore the list of needles that support eSpacial Navi function to the last version.
	Needles List Factory	Restore the list of needles that support eSpacial Navi function to the factory version.
	Fast Startup	To speed up the startup process. NOTE: After installing McAfee, please disable the Fast Startup function to avoid McAfee failure.
	Transducer Tracking	Enable the transducer and patient tracking function: <ul style="list-style-type: none"> Find transducers used with a patient by patient ID. Find patients who used a transducer by transducer SN. After enabling the tracking function, you can set the maximum number of days the data can be retained.
	Configure Cloud	Set to upload the configuration information to the assigned server.
Sound	Enable the stereo mix of the device. Tap [Sound], switch to the recording tab in the "Sound" window, press and hold [Stereo Mix] and tap [Enable].	

If you have any questions, please contact the service engineer or your sales representative.

4.1.13 iVision

The iVision function is used to demonstrate the stored images. Image files are played one by one according to file names (including system-relevant and PC-compatible format images).

Add the contents to be played and select demo mode.

Select an item in the list and tap [Start] (in the bottom-left corner of the screen) to begin the demonstration.

Demonstration item

Demonstration items are image files in formats supported by the system. You can add exam data from the patient database or system-supported image files and folders to the demonstration list. For files and folders in the demonstration list, the images in the directory and subdirectory are played one by one, and the system will automatically skip files that cannot be opened.

- [Add File]: to add files to the file list.
- [Delete]: to delete selected files or catalogs from the file list.
- [Export]: to export selected directories/files to external storage devices.

Interval

The system automatically plays all the image files in the list one by one.

The time interval between images played is the same and can be changed.

Repetition

You can choose whether to repeat the demonstration or exit after a demonstration is complete.

Exhibition

If the function is enabled, the system will play AVI/MP4 format files automatically.

4.1.14 Security

Drive Encryption/Secure Data Wipe

Encrypt the patient data stored in the hard disk. The system provides two encryption methods: Factory Default and User Define.

- Factory Default: the system is in factory state by default.
- User Define: add a user-defined password.

Perform the following procedure:

1. Select [User Define].
2. If no patient data are stored in the hard disk, tap [Confirm], input the password and tap [Confirm] to finish the password setting

If the patient data are already stored in the hard disk, the system will pop-up prompts, follow the steps below:

- a. Tap [OK].
- b. Tap [Wipe] or [Security Wipe] and operate according to the screen prompts to clear patient data.
- c. Select [User Define] again, and tap [Confirm].
- d. Input the password and tap [Confirm] to finish the password setting.

NOTE:

- If you want to switch to Factory Default, perform steps above again. The password is the same as that of the User Define.
 - When you set password, multi-language and Chinese characters are not supported.
 - [Security Wipe] has a higher security level but takes longer time than [Wipe].
-

Anti-Virus

The system provides two anti-virus software: Windows Defender and McAfee. They can effectively prevent the ultrasound system from being attacked by virus, spyware, or other malware.

If the McAfee software is installed, the system displays “McAfee is running”; if not, the system displays “McAfee is not installed”. The McAfee software is an option. If you want to buy McAfee, contact the service engineer.

NOTE:

- McAfee cannot be uninstalled after successful installation.
- McAfee can also be installed after installation of Windows Defender.
- If McAfee is improperly installed due to power-off, shut-down, closing of cmd.exe, or any other abnormal operation during the installation, please contact the service engineer.

Transmission Encryption

After accessing the network, tap [VPN Config] to enter the “VPN Config” interface.

Item	Description
Status	No driver: tap [Setup Driver] to enter the "TAP-Windows 9.21.2 Setup" interface, and do as instructed. <ul style="list-style-type: none"> • Ready: the VPN is ready for use. • Advance: VPN Advance Configuration • Connected: VPN is successfully connected. • Disconnected: VPN is disconnected. • Error: error connection.
Server IP	/
Group	
User Name	
Password	
Hide characters	The password is displayed as *.
Connect/ Disconnect	Connect or disconnect VPN.
Advance	Enters the “VPN Advance Config” interface. Reset: if the system does not respond after you tap [Config], tap [Reset]. Config: enters the “Open Connect-GUI VPN client” interface. For details about the settings, please refer to the TAP manual. Note: after exiting the “VPN Advance Config” interface, you need to reboot the system; otherwise, you cannot connect VPN normally.
Close	Close the “VPN Config” interface.

4.1.15 System Information

This screen displays the system software version and other versions of devices. You cannot edit the information, only view them. The information varies depending on the system configurations and version.

4.2 Exam Related Preset

You can assign exam modes for each probe or set measurement, body mark and annotation settings for current exam mode.

4.2.1 Exam Mode Preset

You can assign available exam modes for probes.

Perform the following procedure:

1. Select the probe model in the drop-down list beside Probe column.
2. Check current configured exam modes:
On the left side, you can view all the available exam modes in the exam library for the probe.
On the right side, you can view the current exam modes assigned to the probe. (Tapping [Probe] on the left side of the operating panel to see the list.)
3. Tap and hold any exam mode until it floats, then you can:
 - Drag the exam mode from “Library” column to “Selected” column to make the exam mode available for the probe.
 - Drag the exam mode from “Selected” column to “Library” column to make the exam mode unavailable for the probe.
4. Change default exam mode or delete user-defined exam mode if necessary:
 - Tap [Delete] to delete a user-defined exam in the Exam Mode Library area.
 - Tap [Default] to set a selected exam mode as the default exam mode. The default exam mode is marked by a “√”.
5. Tap [Save] to save the settings or tap [Cancel] to cancel changes you made.

4.2.2 Measurement Preset

Measurement tool preset

The preset operation of measure tools is the same as caliper tools preset. Here take caliper tools preset as an example.

Perform the following procedure:

1. Select the Exam Mode.
 - [Available Items]: basic measurement tools configured by the system in the current exam mode which are available but not assigned yet.
 - [Selected Items]: displays the tools to be added to the menu.
2. Add/Remove the item.
 - To add the item(s), select one or more items from the left column, hold until the items become “floating” and attached with the cursor, then drag them to the right column.
 - To remove the item(s), operate similarly with adding item(s) except to drag the item from right to left.
3. Set the default item.

Select an item from the [Selected Items], then tap [Default]. The item is marked with a √.

The default item is activated automatically when entering this general measurement menu.

4. Adjust the item position.

Select an item from the right column, hold and drag it to adjust the sequence in the menu.

5. Modify the property of a measurement item.

The following takes D trace as an example to show how to set the property of a measurement tool.

- a. Select [D Trace] from the [Selected Items] and tap [Property].

Descriptions of the attributes are shown in the following table.

Attributes	Descriptions
Item Name & Result	Results obtained from D trace are listed. The selected items will be displayed in the results window after measurement. If PV is selected, other results become deselected (except the temporary result “velocity”).
Unit	Select the measurement unit shown in result window and report. Tap “Unit” column of each item to select.
Calc. Method	Select the calculation method for the tool. The selected calculation tool influences only the final result on the report. Tap “CalcMethod” column of each item to select.

- b. Tap [OK] to confirm the setting.
6. Select the measurement sequence.
 - [Repeat]: after the current measurement is completed, the system automatically activates the current tool again.
 - [Next]: after the current measurement is completed, the system automatically activates the next tool in the menu.
 - [None]: after the current measurement is completed, the cursor returns to the end point of the caliper.
7. Tap [Save] to confirm.

Setting Default Report Template

Perform the following procedure:

1. Select the exam mode.
2. Select the report from the report template list.
3. Tap [Default].
4. Tap [Save] to confirm.



4.2.3 Body Mark/Comment Preset



You can change the annotation menu for current exam mode. The comments in the library are provided by the system or are user-defined ones.

In Body Mark preset page, you can change the body mark menu for current exam mode.

Here take comment preset as an example.

Perform the following procedure:

1. Add comments: directly enter user-defined comment texts, or select comment texts for the annotation menu for current exam mode.
 - Directly enter user-defined comment texts: tap in the field box besides “Custom”, enter the text comment through the soft keyboard, and then tap . Then the directly-entered comment will be added to the menu. Swipe downwards to see more comments.
 - Select available items: First select a comment library in the drop-down list beside “Exam Mode”, all available items will be displayed on the left.
Tap  to add the item from system library on the left into annotation menu on the right.
2. Change position of the selected items:

- Tap an item on the right side box to make it highlighted in blue, and tap the desired position to move the item to the position;
 - Use directional buttons below to make the change.
3. Withdraw a comment or delete a user-defined comment:
- Withdraw an item in the annotation menu:
Select an item in annotation menu on the right, and tap  to withdraw it.
 - Delete a user-defined item in the annotation menu:
Select a user-defined item in the annotation menu on the right, and tap .
You can only delete the user-defined items rather than the items in the system library.
After a user-defined item is deleted, it will not be available.
4. After you customize comments, tap [Save] to confirm and exit the screen.

4.2.4 iWorks Preset

You can customize the protocols and views in the iWorks preset screen.

Protocol Management

- Tap to select the protocol in the list. The protocol type can be checked on the lower part. Check to select applied exam modes in the “Exam Mode(s) applied to” column.
- Tap [Add Protocol] to create a new protocol. It can be customized.
- Tap to select a protocol in the iWorks list and tap [Copy]. A protocol named “XXX_Copy1” is created with the copied views, which can be customized.
- Tap [Delete] to delete a user-defined protocol.
- Tap [Up] or [Down] to move the selected protocol.
- Tap [Move to Top]/[Move to Bottom] to move the selected protocol to the top or bottom of the list.

View Management

- Tap to select the views in the list. The image, annotation, body mark and measurement settings can be checked on the right.
- Tap to select a user-defined protocol in the list. Tap [Add View] to add a view template to the protocol.

Create a New Protocol

You can create user-defined protocols and customize the automated procedure.

Perform the following procedure:

1. In the iWorks preset screen, tap [Add Protocol] to create a new protocol.
Or, select an existing protocol and tap [Copy] to customize the protocol based on the previous template.
2. Tap [Add View] to enter the view name and perform image settings.
3. Add comments, body marks and perform measurement settings.
In the measurement setting, if “Measurement on next section” is selected, the system will save two section images after finishing the section operation. One of the two sections will include the measurement result.
4. Select the checkbox for body mark display settings.
5. Tap [Save] to complete the setting and exit.

4.3 Network Related Preset

You can configure network related settings here, including DICOM setting, network setting, Q-Path setting and HIS setting.

4.3.1 DICOM Local Preset

TIP:

- AE Title should be the same with the SCU AE Title preset in the server (PACS/RIS/HIS), for example, if the AE Title of the server preset in the storage server is Storage, and the AE Title of the accepted SCU is preset as Machine, then in the figure above, the AE Title of Local should be Machine, and the AE Title of storage server should be Storage.
- The device name is random. If the server name is same with that in the DICOM server list, the information “the server added already exists”, tap [OK] to retype the name.
- IP address should be the address of the remote server.

DICOM local preset items are described as follows:

Name	Description	
DICOM Local	AE Title	Application Entity title.
	Port	DICOM communication port.
	PDU	Maximum PDU data package size, ranging from 16384 to 65536. If the value is less than 16384 or greater than 65536, the system automatically sets it to the value 32768.
	TLS/SSL Version	Select an appropriate TLS/SSL version. SSLv23 is set by default.
	Verify Certificate	After importing TLS certificates, and selecting this check box, the system verifies the effectiveness of the TLS function in the DICOM storage, print, and worklist services.
	Import TLS Certificates	Import trusted certificates.
	Clear TLS Certificates	Clear all certificates
Server Setting	Device	Name of the device supporting DICOM services.
	IP Address	IP address of the server.
	Ping	You can ping other machines after entering the correct IP address. You can also select a server in the device list below to ping it.
	Log Level	For engineer use only.
	Capture	

Add a Server

Perform the following procedure:

1. Enter the server device name and IP address.

2. Tap [Ping] to check the connection.
3. Tap [Add] to add the server to the device list, and its name and address are displayed in the list.

Delete a Server

Select a server in the device list, and then tap [Delete].

Set DICOM Strategy

TIP:

- The DICOM strategy must be configured by qualified personnel with good knowledge of DICOM standards.
 - The qualified personnel must ensure the validity of the DICOM strategy.
-

Perform the following procedure:

1. Tap [Set DICOM Strategy].
2. Edit the DICOM strategy:
 - Add: Enter strategy name and description, and tap [Add] to add a new strategy. Then the added strategy will be added to the Strategy List.
 - Delete: Select a strategy from the Strategy List, and tap [Delete].
 - Update: Select a strategy from the Strategy List, re-enter strategy name or description, and tap [Update].
3. Configure the item:

Select a strategy name from the Strategy List, and assign strategy items to the selected strategy.

 - Add: Set the function from the drop-list box, enter the parameter 1 and parameter 2, and tap [Add]. Then the added strategy item will be added to the Strategy Items List.
 - Delete: Select a strategy item from the Strategy Items List, and tap [Delete].
 - Update: Select a strategy from the Strategy Items List, reselect the function or re-enter the parameter 1/2, and tap [Update].
4. Import/Export strategy:
 - Import: tap [Import], browse the desired strategy file and operate according to the screen prompts to import.

The imported file for DICOM strategy must be a *.xml file.
 - Export: Select a strategy from the Strategy List, tap [Export] and then select the export path and type the file name.

E drive is default, and the file type is .xml.

4.3.2 DICOM Service Preset

The DICOM Service screen is used to set attributes of Storage, Print, WorkList, MPPS, Storage Commitment, and Query/Retrieve.

When the system is configured with DICOM basic function module, and installed with DICOM WorkList, MPPS, DICOM structured report, and DICOM query/retrieve modules, the corresponding preset can be found in DICOM Service screen.

TIP:

Not all SCPs can support verification. See the SCP properties to confirm whether the SCP can support this service. If not, the verification will not be successful.

Perform the following procedure:

1. Select the DICOM service tab to enter the corresponding settings screen.
2. Enter the correct AE Title, port, etc.
 - Tap [Add] to add the service to the Service List.
 - Select an item in the service list, change the parameters in the above area, and tap [Update] to update the item in the service list.
 - Click to delete the selected service in the service list.
 - Select an item in the service list, click [Default] and you can see “Y” in the Default column.
4. Tap [Verify] to verify that the two DICOM application entities are properly connected.

If the verification is successful, the system displays “xxx Verify Succeed.” Otherwise, it displays “xxx Verify Failed.”

If verification failed, possible causes may be: wrong IP address; not able to access IP address; remote DICOM server is not running; wrong port; incorrect application name.

Storage Service Preset

DICOM storage preset items are described as follows:

Item	Description
Device	After you set the server (s) in DICOM Preset screen, the name (s) will appear in the drop-down list, select the name of the storage server.
Service Name	Default is xxx-Storage, user-changeable.
AE Title	Application Entity title, here, it should be consistent with that of the storage server.
Port	DICOM communication port, 104 is default. Here, the port should be consistent with that of the storage server port.
Maximum Retries	Set the maximum retries (0-9). The default value is 3. If the DICOM task sending to the server fails, the retry times should be 3.
Interval Time(s)	Interval time.
Timeout	Refers to the amount of time after which the system will stop trying to establish a connection to the service.
TLS	Transport Layer Security. Select whether to encrypt the data during network transportation.
Compression Mode	Select the compression mode: original data (uncompressed), RLE (the image not compressed), JPEG, and JPEG2000.
Compression Ratio	Select the JPEG compression ratio: lossless, low, medium, and high. The compression ratio is inversely proportional to the image quality (reserved function).
Color Mode	Select the color mode. If you choose the mix or the grey, RLE/JPEG is unavailable. The image uses 24 bit when sending the image from the ultrasound device to the server; it depends on the image when choosing the mix. The image uses 8 bit if the image is captured in color mode or the image has the tint. All images use 8 bit when choosing the grey.
Allow Multiframe	If SCP supports this function, then select it.

Item	Description
Max Frame Rate	Set the frame range of transferring cin file into DCM multi-frame file. It is editable to the user.
SR Storage Option	To enable or disenable structured reporting sending.
Encapsulated PDF	Select if to encapsulate PDF format report in DICOM standard. It becomes available if SCP supports the function.
Storage mode	Set the storage mode for image and cine file: <ul style="list-style-type: none"> Parallel file: save the current file, and is ready for the storage of the next file. Parallel frame: send the current frame, and is ready for sending the next frame.
Transducer Tracking	Files of images that are saved in DCM format through DICOM or DICOMDIR contain transducer serial number information.
Strategy Name	Select the preset DICOM strategy.

TIP:

- If the server software supports the compression algorithm, select JPEG, RLE, JPEG2000. Otherwise, original data should be used (RLE is the default method).
- RLE, JPEG and JPEG2000 are not supported by all SCPs. Refer to the SCP's DICOM CONFORMANCE STATEMENT electronic file to check whether SCP supports it or not. Do not select these compression modes if the storage server does not support them.
- Images of PW/M mode (B image is not frozen) and images other than PW/M mode: if "Max Frame rate" is not "Full" and the actual frame rate is larger than the set value, the system will save the image files in a frame rate of the set value, and transfer in a frame rate of B mode.
- Images of PW/M mode (B image is frozen), the system will save/transfer the images files in frame rate of 6.

Print Service Preset

DICOM print preset items are described as follows:

Item	Description
Device	After you set the server (s) in DICOM Preset screen, the name (s) will appear in the drop-down list, select the name of the print server.
Service Name	Default is xxx-Print, user-changeable.
AE Title	Application Entity title, here, it should be consistent with that of the print server.
Port	DICOM communication port, 104 is default. Here, the port should be consistent with that of the print server port.
Maximum Retries	It starts retrying if it fails to send DICOM task to the server. The retry entry times should be this value.
Interval Time (s)	Reserved time.
Timeout	Refers to the amount of time after which the system will stop trying to establish a connection to the service.

Item	Description
TLS	Transport Layer Security. Select whether to encrypt the data during network transportation.
Copies	Refer to copies of printed files. You can select among 1 through 5, or directly enter the numeral.
Settings	The system supports RGB (color printing) and MONOCHROME2 (black and white printing). Please select the type the printer supports.
Film Orientation	Select between LANDSCAPE and PORTRAIT.
Priority	Specify printing task priority among HIGH, MED and LOW.
Film Size	Select film size among the selections listed in the drop-down list.
Display Format	Specify quantity of printed files, e.g. STANDARD\2, 3 indicates 6 images are printed for each page.
Medium Type	Specify print medium: Paper, Clear Film, Blue Film; select Blue Film or Clear Film for black and white printing; select Paper for color printing.
Trim	Specify whether you want a trim box to be printed around each image on the film: Yes or No.
Configuration Info	Enter configuration information in the field.
Min Density	Enter the minimum density of the film.
Max Density	Enter the maximum density of the film.
Destination	Specify where the file is exposed: MAGAZINE (stored in the magazine), or, PROCESSOR (exposed in the processor).
Strategy Name	Select the preset DICOM strategy.
Magnification Type	Select how the printer magnifies an image to fit the film. <ul style="list-style-type: none"> • Replicate: interpolated pixels belong to duplicate of adjacent pixels); • Bilinear: interpolated pixels are generated from bilinear interpolations between adjacent pixels; • Cubic: interpolated pixels are generated from cubic interpolations between adjacent pixels; • None: without interpolation.

Worklist Setting

DICOM service setting for Worklist is described as follows:

Item	Description
Device Name	After you set the server (s) in DICOM Server Setting screen, the name (s) will appear in the drop-down list, select the name of the Worklist server.
Service Name	Default is server-Worklist, and it can be modified.
AE Title	Application Entity title. It is consistent with that of the Worklist server.
Port	DICOM communication port, 104 by default. The port should be consistent with that of the Worklist server port.
Maximum Retries	Reserved feature.

Item	Description
Interval Time(s)	Reserved feature.
Timeout	Refers to time after which the system will stop trying to establish a connection to the service.
TLS	Transport Layer Security. Select whether to encrypt the data during network transportation.
Strategy Name	Select the preset DICOM strategy.
Remove Attributes (0)	Preset what DICOM elements that will not be used in worklist query.

MPPS Preset

MPPS setting items are described as follows:

Item	Description
Device Name	After you set the server (s) in DICOM Server Setting, the name (s) will appear in the drop-down list, select the name of the MPPS server.
Service Name	Default is server-MPPS, and it can be modified.
AE Title	Application Entity title. It should be consistent with that of the MPPS server.
Port	DICOM communication port, 104 by default. The port should be consistent with that of the MPPS server.
Maximum Retries	It starts retrying if it fails to send DICOM task to the server. The retry entry times should be this value.
Interval Time(s)	Reserved feature.
Timeout	Refers to the amount of time after which the system will stop trying to establish a connection to the service.

TIP:

Set the MPPS service as the default when using the MPPS.

Storage Commitment Setting

DICOM storage commitment setting items are described as follows:

Name	NOTE
Device Name	After you set the server (s) in DICOM Server Setting, the name (s) will appear in the drop-down list, select the name of the storage commitment server.
DICOM Service Name	Default is server-SC, and it can be modified.
AE Title	Application Entity title. Here, it should be consistent with that of the storage commitment server.
Port	DICOM communication port, 104 by default. Here, the port should be consistent with that of the storage commitment server port.
Maximum Retries	Reserved feature.
Interval Time(s)	Reserved feature.

Name	NOTE
Timeout	Refers to the amount of time after which the system will stop trying to establish a connection to the service.
Associated Storage Service	The associated storage server is preset before storage commitment, only after the exam is sent out, can storage commitment be created.

Query/Retrieve

DICOM query/retrieve setting items are described as follows:

Item	Description
Device Name	Select the name of a device that can be added (including the local).
Service Name	Default is server-queryRetrieve, and it can be modified.
AE Title	Application Entity title. Here, it should be consistent with that of the storage commitment server.
Port	DICOM communication port, 104 by default. Here, the port should be consistent with that of the storage commitment server port.
Maximum Retries	Reserved feature.
Interval Time(s)	Reserved feature.
Timeout	Refers to the amount of time after which the system will stop trying to establish a connection to the service.

HL7 Query Service Preset

The protocol version that the ultrasound system supports: V2.3, V2.4, V2.5, V2.6.

HL7 service setting for Worklist is described as follows:

Item	Description
Device Name	After you set the server (s) in DICOM Server Setting screen, the name (s) will appear in the drop-down list, select the name of the Worklist server.
Service Name	Default is server-HL7Query, and it can be modified.
AE Title	Application Entity title. here, it should be consistent with that of the HL7 server.
Port	DICOM communication port, 104 by default. Here, the port should be consistent with that of the HL7 server port.
Maximum Retries	Reserved feature.
Interval Time(s)	Reserved feature.
Timeout	Refers to the amount of time after which the system will stop trying to establish a connection to the service.
Listen mode	This function enables the ultrasound system to use the listen port for data receiving.
Listen port	Port for ultrasound system to receive data after the listen mode function is activated. Here, the port should be consistent with that of the HL7 server port. For details of listen port setting, refer to settings in the server.

4.3.3 eGateway Preset

Before using eGateway, the system should be in the same network segment with the eGateway server, and ensure that the eGateway software version is 7.1 or later versions.

For details of eGateway installation and configuration, see eGateway manual.

eGateway Query

Item	Description
Service Name	The name of the eGateway service.
IP Address	Input the ADT Source IP address in the eGateway Server configuration interface.
Port	Input the MAQ Server Port in the eGateway Server configuration interface.
Clear	Click to cancel the parameter setting.
Add	Click to add the Network service to the service list.
Update	Select an item in the service list, change the parameters in the above area, and click [Update] to update the item in the service list.
Delete	Click to delete the selected service in the service list
Default	Set the eGateway server as the default. Select an item in the service list, click [Default] and you can see “Y” in the Default column.
Connect	Click to verify whether the connection is normal.

To add an eGateway service

1. Set the eGateway server properties as described above.
2. Tap [Add] to add the service to the service list.

To modify a network service

1. Select the service to be updated in the service list.
2. Modify the parameters in the upper part of the screen and tap [Update] to update the setting.

eGateway Store

Before using the eGateway storage, ensure the Send Mode is set to “MDM with Reference” in the eGateway Server configuration interface.

Type	Item	Description
Configure Service	Service Name	The name of the eGateway service.
MultiBackend	IP Address	Input the ADT Source IP address in the eGateway Server configuration interface.
	Port	/

Type	Item	Description
DocServer	IP Address	Input the ADT Source IP address in the eGateway Server configuration interface.
	Port	Input the Document Sharing SSL Port in the eGateway Server configuration interface.
	Image/Cine/PDF Report	Set the shared document content.
/	Clear	Click to cancel the parameter setting.
	Add	Click to add the Network service to the service list.
	Update	Select an item in the service list, change the parameters in the above area, and click [Update] to update the item in the service list.
	Delete	Click to delete the selected service in the service list
	Default	Set the eGateway server as the default. Select an item in the service list, click [Default] and you can see “Y” in the Default column.
	Connect	Click to verify whether the connection is normal.

To add an iStorage service

1. Set the iStorage server properties as described above.
2. Tap [Add] to add the service to the service list.

To modify a network service

1. Select the service to be updated in the service list.
2. Modify the parameters in the upper part of the screen and tap [Update] to update the setting.

4.3.4 Network Preset

iStorage Preset

You can send exam data or images to the iStorage server and perform analysis using UltraAssist. For details about this feature, see the UltraAssist manual.

Item	Description
Service Name	The name of the iStorage service.
IP Address	IP address of the iStorage service device.
Port	Port for transmitting.

To add an iStorage service, perform the following procedure:

1. Set the iStorage server properties as described above.
2. Tap [Connect] to verify connection.
3. Tap [Add] to add the service to the Service list.

To edit a network service, perform the following procedure:

1. Select the service to be updated in the service list.
2. You can see properties in the Configure Service area.
3. Do one of the following to edit the network service:

- Modify the properties and tap [Update] to update the setting.
- Tap [Default] to set as the default service.
- Tap [Delete] to delete it from the service list.

Wireless Network Connection

Reserved.

MedTouch Preset

You can set environment for MedTouch here and then use the MedTouch function by mobile phone or tablet computers. See MedTouch manual for details.

Route Settings

The system can be set to connect to the local network and internet network through route settings at the same time. For details, please contact the service engineers.

MIOT Preset

After the MIOT (Mindray Internet of Things) service is enabled and configured, the Ultrasound device information such as Usage, Operating duration, can be transmitted to MIOT.

Item	Description
IP Address	IP address of the MIOT service device.
Port	Port for transmitting.
MIOT Service Switch On	Tap to enable MIOT service.

4.3.5 Q-Path Preset

Q-path is a network server provided by Telexy Healthcare Inc. for digital image storage. Q-View is a client viewing tool for the server. Telexy Healthcare developed technology and a command structure that allows any Q-view enabled ultrasound system to access Q-path directly from the ultrasound system using a single control. The primary purpose for Q-view is to provide remote access to Q-path from the ultrasound system to complete the exam report on the ultrasound system and submit for QA,

For details, please contact Q-Path service provider.

Item	Description
Advanced	Sets the sub URLs of “QView full” and “QView lite”. The sub URL is set by default. Users can modify the sub URL and click [Apply] to exit the “QView sub URL setting” window.
Worksheet Only	Sets whether to directly enter the Worksheet interface after opening the Q-Path server.
Password On Worksheet	Sets whether to display the Signature field box in a worksheet. Tap [Report] > [WorkSheet] or tap [Review] > [Report] > [WorkSheet], enter the worksheet password in the field box, and click [OK]. Users can query the corresponding worksheet by searching the worksheet password in the Q-Path server.
Password On End Exam	Sets whether to input the worksheet password after ending an exam.
Password Visible	Sets whether the password is visible.

Item	Description
Import	Imports a user-defined worksheet template from the USB storage (downloaded from the Q-Path server).
Backup	Backs up worksheets to the USB storage.
Restore	Restores the backup worksheet template from the USB storage to the ultrasound system.
Delete	Deletes a worksheet template.
Restore Factory	Restores the worksheet template to the default state.

Perform the following procedure:

1. Select “Enable Q-Path”.
2. Enter the website, account and password of the target service.
3. Select user type: Personal User or Default User.
 - Personal User: the personal user needs to enter the user name and password in every-time login.
 - Default User: after the default user enters the user name and password in the field box of the “User Name” and “Password”, and tap [Save], no login is required to access the Q-Path server later.
4. Select an appropriate item from the drop-down list of “Available Items”.
5. Select an exam mode in the left “Exam Mode” column.
6. Select a worksheet in the right “Worksheets” column.
7. Tap [Save] to exit, and the system will shut down.

This page intentionally left blank.

5 Exam Preparation

You can start a patient exam in the following situations:

- New patient information: to start a new patient exam, patient information must first be entered.
- New exam: to start a new exam for patient who is already registered, the recorded information can be obtained through either iStation or Worklist.
- Activate exam: to select an exam that has been completed within 24 hours, continue the exam with imported patient information and exam data.
- Continue an exam: to select an exam that has been paused within 24 hours, continue the exam with imported patient information and exam data.

5.1 Patient Information

5.1.1 New Patient Information

CAUTION

Before examining a new patient, tap the [End] to end the exam of the previous patient, update the patient ID and information, to avoid mixing data of the next new patient.

To start a new patient exam, it is better to type the detailed patient information. The system will set up a unique information database for each patient based on the patient information entered, so that the information of one patient will not be confused with that of another patient.

1. Tap [Info] on the touch screen to enter the patient information page.

Place the cursor onto the targeted box. The field box is highlighted and a flashing cursor appears. Information can be entered or selected from the options

NOTE:

- Patient ID is generated automatically by the system after starting a new patient, and can be modified manually. The characters “\”, “\”, “*”, “?” are not permitted.
- You can either enter the patient’s date of birth manually, or select the date from the calendar.
- The age unit can be “Years”, “Months” or “Days.” If the age is less than one year, the system will automatically calculate the age in months or days.

2. Exam Type

- Exam application type

Select the exam type tab to enter exam-specific information.

- General information:

Primary indications:	To enter the primary indications (reason for performing the exam.)
----------------------	--

Accession #	To enter the exam number used in DICOM.
MRN:	To enter the secondary indications.
Diagnostician:	Person responsible for the exam.
Operator:	Person responsible for image collection and scanning.
Ref. Physician:	Person who requires the operator to carry out the ultrasound.
Comment:	To enter the exam-specific explanation or remarks.

3. Functional keys

- [Patient List]/ [Worklist]: imports patient data from history exam list or Worklist.
- [Done]: saves the patient data entered and exits the screen.
- [Cancel]: cancels the patient data entered and exits the screen.

5.1.2 Retrieve Patient Information

You can import patient information from iStation or DICOM Worklist for anonymous patients.

Retrieve from iStation

Using iStation, the patient data can be obtained in iStation from the system hardware or USB memory device. You can enter search conditions for the patient.

1. In Patient screen, select [iStation] in the bottom-left corner to enter the screen.
2. Select an exam: you can either swipe the screen downwards to search or using the keyword filter.
3. The system enters the Patient screen, and the selected exam information is imported already.
4. Change the patient information if necessary and then tap [Done] to start exam.

Retrieve from Worklist

Tap [Worklist] in the Patient Info screen to query or import the patient data. For details, see the DICOM/HL7 chapter.

5.2 Activate an Exam

On the iStation screen, select an exam record which was completed within 24 hours and select [Options] > [Activate].

NOTE:

- The system can automatically load the patient information and exam data to continue the exam.
- If you want to continue an exam which data lies in an external memory database, you have to first allow the system to load the patient data to the system's patient database.
- For an only one re-activated exam, you can modify patient ID.

5.3 End an Exam

Be sure to avoid mixing data between patients.

Before examining a new patient, tap [End] in the bottom-left corner of the operating panel to end the exam of the previous patient.

6 Image Acquisition

WARNING

- The images displayed in this system are only reference for diagnosis. Mindray is not responsible for the correctness of diagnostic results.
 - Tissue Harmonic Imaging does not use contrast agents.
-

TIP:

Operations for switching between different image modes and optimizing images, see the System Overview chapter.

6.1 B Mode

B mode is the basic imaging mode that displays real-time views of anatomical tissues and organs.

6.1.1 B-mode Image Scanning

Tap [B] on the right side of the operating panel to enter B mode.

Tap [Image] to open the image menu. Adjust the parameters to optimize the image.

6.1.2 B-mode Image Parameters

Image Quality

To switch between the fundamental frequency and harmonic frequency as well as select the corresponding frequency type. The real-time frequency value is displayed in the image parameter area in the top-left corner of the screen, and if harmonic frequency is used “F H” is displayed as the harmonic frequency value.

The system provides an imaging mode using harmonics of echoes to optimize the image. Harmonic imaging enhances near-field resolution and reduces low-frequency and large amplitude noise, so as to improve small parts imaging.

Select the frequency according to the detection depth and current tissue features.

Gain

To adjust the gain of the whole receiving information in B mode. The real-time gain value is displayed in the image parameter area in the top-left corner of the screen.

Increasing the gain will brighten the image and you will see more received signals. However, noise may also be increased.

Depth

This function is used to adjust the sampling depth, the real-time value of which is displayed in the image parameter area in the top-left corner of the screen.

Increase the depth to see tissue in deeper locations, or decrease the depth to see tissue in shallower locations.

TGC

The system compensates the signals from deeper tissue by segments to optimize the image.

Acoustic power

Refers to the power of ultrasonic waves transmitted by the probe, the real-time value of which is displayed in the top-left part of the screen.

TIP:

You should perform exams according to actual situation and follow the ALARA Principle.

Focus

Refers to adjusting the focus of the ultrasonic beams, using the focus arrow symbols which are displayed to the right of the image.

Image Adjustment

More information can be obtained without moving the probe or changing the sampling position.

- FOV (Field of View): You can get a much larger field of view when selecting a larger FOV. The frame rate decreases when using a larger FOV.
- Steering: Use to adjust the steer angle.
- ExFOV (Extended FOV): Off represents no ExFOV effect.
 - For linear probes, the ExFOV function displays as trapezoid imaging.
 - For convex probes, the ExFOV function displays as extending the scanning angle.

TIP:

- The FOV position/range is available only for the convex and phased probes.
 - When the scan range is adjusted to the widest, the FOV position cannot be changed.
 - The steering function is available only for linear probes.
-

Dynamic Range

Adjusts contrast resolution of an image, compresses or expands gray display range.

The real-time dynamic range value is displayed on the image parameter area.

The more the dynamic range, the more specified the information, and the lower the contrast with more noise.

Gray Map

Adjusting grayscale contrast to optimize the image.

Tint Map

This function provides an imaging process based on color difference rather than gray distinction.

Line Density

The function determines the quality and information of the image.

The higher the line density is, the higher the resolution becomes.

iClear

The function is used to enhance the image profile so as to distinguish the image boundary for optimization.

Persistence

Used to superimpose and average adjacent B images, so as to optimize the image and remove noises.

Rotation/Invert (U/D Flip and L/R Flip)

This function provides a better observation for image display.

The “M” mark indicates the orientation of the image; the M mark is located on the top of the imaging area by default.

iBeam

This function is used to superimpose and average images of different steer angles to obtain image optimization.

TIP:

The phased probe does not support iBeam. iBeam is unavailable when ExFov is enabled.

TSI

The TSI function is used to optimize the image by selecting acoustic speed according to tissue characteristics.

iTouch

To optimize image parameters as per the current tissue characteristics for a better image effect. It is available for all real-time imaging in B mode.

H Scale

Display or hide the width scale (horizontal scale).

The scale of the horizontal scale is the same as that of vertical scale (depth), they change together in zoom mode, or when the number of the image window changes. The H Scale will be inverted when image is turned upwards/downwards.

Dual Live

Display different image effects of one probe for a better observation.

Two pages of adjustable parameters are displayed on the touch screen as well; where, shared parameters and left window parameters are displayed in the B (L) page, while right window parameters are displayed in the B(R) page.

In the image parameter area, parameters of the both windows are displayed.

It supports the magnification of the image.

Dual

Enter Dual mode in Non-Dual mode.

For linear probes, you can switch screen splitting between horizontal and vertical layout you can switch between the 2 modes by using “V1:1” parameter.

Zoom Value

Adjust to zoom in/out the image. The parameter “Z” refers to the magnification value.

Echo Boost

This function can improve contrast and decrease noise, so that a much clearer boundary can be seen.

Patient Temperature

If the current active probe is TEE probe, the parameter will display under the B mode menu. You can enter the patient temperature by this function.

WARNING

If the patient temperature is above 37°C (98.6 °F) and the [Patient Temperature] setting is below the actual reading, the system could overestimate the temperature of TEE transducer's distal tip. This could trigger the Auto-Cool feature. If the patient temperature reaches or is near 37 °C (98.6 °F) and the [Patient Temperature] setting is above the actual reading, the system could underestimate the temperature of the TEE transducer's distal tip. The patient is exposed to excessive temperatures.

6.2 Color Mode

The Color mode is used to detect color flow information, and the color is designed to judge the direction and speed of blood flow.

Generally, the color above the color bar indicates the flow towards the probe, while the color below the color bar indicates the flow away from the probe. The brighter the color, the faster the flow speed, while the darker the color, the slower the flow speed.

TIP:

In Color Mode, acoustic power is synchronous with that of B Mode. Adjustment of the depth or zoom to the B Mode image will lead to corresponding changes in Color Mode image.

6.2.1 Color Mode Image Scanning

Perform the following procedure:

1. Select a high-quality image during B mode scanning, and adjust to position the area of interest in the center of the B mode image.
2. Tap [Color] on the right side of the operating panel to enter Color mode.
3. Change the position and size of the Region of Interest (ROI).
 - Tap the corner of the ROI and drag to change the size.
 - Tap inside the ROI box and drag to change the position.
4. Tap [Image] to open the image menu. Adjust the parameters to optimize the image.

6.2.2 Color Mode Image Parameters

Color Gain

Refers to the overall sensitivity to flow signals. The real-time gain value is displayed in the image parameter area.

Increasing the gain will increase the flow signal presented as well as noise, while the signals may be missing when the gain is adjusted too low.

Image Quality

Refers to the transmitting frequency in Doppler mode of the probe, the real-time value of which is displayed in the image parameter area.

Frequency values vary according to probe types. Select the frequency according to the needs of the detection depth and the current tissue characteristics.

B/C Align

To set and constrain the maximum width of the B mode image to that of the Color ROI.

Steer

The feature is used to adjust the ROI of the color flow of different angles with immobility of the linear probe.

Dual Live

This function is used to display B image and Color image synchronously.

Line Density

The function determines the quality and information of the image.

The higher the line density is, the higher the resolution becomes.

Packet Size

This function is an indication of the ability to detect flow, which is used to adjust the accuracy of color flow.

The higher the sensitivity is, the more sensitive indication for low-velocity flow becomes.

Flow State

Refers to optimizing the various flow states.

Persistence

This function is to adjust the temporal smooth to optimize the image.

Smooth

This feature is used to reject the noise and smooth the image.

Scale

This function is used to adjust the speed range of color flow, which is adjusted through PRF in the system. The real-time PRF value is displayed in the image parameter area.

Aliasing may occur if low velocity scale is used and high velocities are encountered.

Low velocities may not be identified when a high velocity scale is used.

Baseline

Refers to the area where the velocity is zero in the scale. Adjust according to the actual situation so as to get an optimum flow display.

Invert

To set the display mode of the color flow. The color scale will be inverted when the function is turned on.

Color Map

This function is a combination of several image parameters, which indicates the display effect of color image.

WF (Wall Filter)

It filters out low-velocity signals to provide effective information, and this function is used to adjust the filtered frequency. The real-time value (WF) is displayed in the image parameter area.

Priority

This function is used to set levels of the flow display, to display the grayscale signal or color signal. The color image is preferred with higher value; while grayscale signals are displayed with the lower value.

iTouch

To optimize image parameters as per the current tissue characteristics for a better image effect.

Smart tracking

To optimize image parameters as per the current tissue characteristics for a better image effect. When Smart Tracking is turned on, the system optimizes ROI angle and position automatically to achieve an active tracking by reducing the impact of patient respiratory movement.

6.3 Power Mode

Power mode provides a non-directional display of the blood flow in terms of intensity as opposed to flow velocity.

DirPower (Directional Power mode) provides additional information of the flow direction toward or away from the probe.

TIP:

In Power mode, the acoustic power is synchronous with that of B mode. Adjustment of the depth to the B mode image will lead to corresponding changes in Power mode image.

6.3.1 Power Mode Image Scanning

Perform the following procedure:

1. Select a high-quality image during B mode or B + Color scanning, and adjust to position the area of interest in the center of the image.
2. Tap [Power] on the right side of the operating panel to enter Power mode.
3. Change the size and position of the ROI.
 - Tap the corner of the ROI and drag to change the size.
 - Tap inside the ROI box and drag to change the position.
4. Tap [Image] to open the image menu. Adjust the parameters to optimize the image.

6.3.2 Power Mode Image Parameters

Because both are based on Doppler color imaging, the adjustments of Power mode are same with these of Color mode's. Hence, only the adjustments of Power mode are introduced.

Power Gain

Refers to the overall sensitivity to flow signals, and this function is used to adjust the gain in Power mode. The real-time gain value is displayed in the image parameter area.

Color Map

This feature indicates the display effect of power image. The maps in Power mode image are grouped into two categories: Power maps and Directional Power maps.

- The Power maps provide information of blood flow, which are highly sensitive to the low-velocity flows.
- The Directional Power maps provide information of flow direction.

Dynamic Range

This function is to adjust the transformation of echo intensity into color signal.

Increasing dynamic range will lead to higher sensitivity to low-power signals, thus enhances the range of signals to display.

6.4 M Mode

6.4.1 M Mode Image Scanning

Perform the following procedure:

1. Select a high-quality image during B mode scanning, and adjust to position the area of interest in the center of the B mode image.
2. Tap [M] on the right side of the operating panel to enter M sampling line status, and drag the sampling line to the desired position.
3. Tap [M]/ [Update] or double-click the sampling line to enter M mode. You can then observe the tissue motion along with the anatomical images of B mode. During the scanning process, you can also adjust the sampling line accordingly when necessary.
4. Tap [Image] to open the image menu. Adjust the parameters to optimize the image.

6.4.2 M Mode Image Parameters

Gain

To adjust the gain of M mode image, the real-time gain value is displayed in the image parameter area.

Increasing the gain will brighten the image and you can see more received signals. However, noise may also be increased.

Display Format

To set the display format of B mode image and M mode image.

Adjust according to the actual situation and obtain a desired analysis through comparison.

Speed

This function is used to set the scan speed of M mode imaging, and the real-time speed value is displayed in the image parameter area.

Tint Map

This function provides an imaging process based on color difference rather than gray distinction.

Gray Map

Adjusting grayscale contrast to optimize the image.

Edge Enhance

This function is used to increase image profile, so as to distinguish the image boundary. Larger edge enhance may lead to noise increase.

Dynamic Range

Adjusts contrast resolution of an image, compresses or expands gray display range. The real-time dynamic range value will be displayed on the image parameter area on the top of the screen.

M Soften

This feature is used to process the scan lines of M images to reject noise, making the image details to be clearer.

6.5 Color M Mode (CM)

To know the cardiac motion state, CM is overlaid with flow based on M mode, which is more sensitive to the instantaneous signal changes. Then, it shows the diagnosis information in detail.

6.5.1 CM Image Scanning

Perform the following procedure:

1. To enter CM mode:
 - In B+M Mode, tap [Color].
 - In B+Color, B+ Color+ PW mode, tap [M].
2. Tap [Image] to open the image menu. Adjust the parameters to optimize the image.

6.5.2 CM Image Parameters

In CM mode, parameters that can be adjusted are in accordance with those in B, M and Color modes; please refer to relevant sections of B, Color and M mode for details.

The ROI size and position determine the size and position of the color flow displayed in the color M mode image.

6.6 Anatomical M Mode

For an image in the traditional M mode, the M-mark line goes along the beams transmitted from the probe. Thus it is difficult to obtain a good plane for difficult-to-image patients who cannot be moved easily. However, in the Anatomical M mode, you can manipulate the M-mark line and move it to any position at desired angles. The system supports anatomical M scanning in 2D imaging modes.

CAUTION

Anatomical M Mode images are provided for reference only, not for confirming diagnoses. Compare the image with those of other machines, or make diagnoses using non-ultrasound methods.

TIP:

Free Xros M imaging is an option.

6.6.1 Linear Anatomical M (Free Xros M)

Free Xros M imaging is supported on frozen B image, B+M image and B+Power/Color image. Perform the following procedure:

1. Adjust the probe and image to obtain the desired plane in real-time B mode or M mode.
Or select the B mode cine file to be observed.
2. Tap [Free Xros M] on the right side of the operating panel to enter Free Xros M mode.
3. Adjust the sampling line to obtain optimized images and necessary information.
 - Position Adjustment: When the M-mark line is activated, tap the dotted circle and drag the sampling line to change the position. The direction is recognized by the arrow at the end of the line.
 - Angle Adjustment: When the M-mark line is activated, tap the dotted circle and drag along the sampling line to adjust the fulcrum of the line, and adjust the angle by rotating the sampling line.
4. Tap [Image] to open the image menu. Adjust the parameters to optimize the image.

6.6.2 Anatomical M Mode Parameters

In anatomical M mode, adjustable parameters are similar with these in M mode.

6.7 PW/CW Mode

PW (Pulsed Wave Doppler) mode or CW (Continuous Wave Doppler) mode is used to provide blood flow velocity and direction utilizing a real-time spectrum display. The horizontal axis represents time, while the vertical axis represents Doppler frequency shift.

PW mode provides a function for examining flow at one specific site for its velocity, direction and features. CW mode proves to be much more sensitive to high-velocity flow display. Thus, a combination of both modes will contribute to a much more accurate analysis.

Only phased probes support CW mode.

6.7.1 PW/CW Mode Image Scanning

Perform the following procedure:

1. Select a high-quality image during B mode or B + Color (Power) mode scanning, and adjust to position the area of interest in the center of the image.
2. Tap [PW]/[CW] on the right side of the operating panel to enter PW sampling line adjustment status.

The sampling status will be displayed in the image parameter area in the top-left corner of the screen.

- Set the position of the sample line by dragging the sampling line; drag the SV gate to place the SV on the target.
 - Adjust the angle and SV size according to the actual situation: drag the PW angle line to change the angle, pinch on the image area to adjust SV size.
3. Tap [PW]/[CW]/[Update] or double-click the sampling line to enter PW mode and perform the examination.
You can also adjust the SV size, angle and depth in real-time scanning.
 4. Tap [Image] to open the image menu. Adjust the parameters to optimize the image.

6.7.2 PW/CW Mode Image Parameter

Gain

This function is intended to adjust the gain of spectrum map. The real-time gain value is displayed in the image parameter area.

SV

To adjust the SV position and size of sampling in PW mode, the real-time value of SV and SVD are displayed in the image parameter area in the top-left corner of the screen.

CW Focus Position

To adjust the CW mode SVD. The real-time focus position value is displayed in the image parameter area in the top-left corner of the screen.

Image Quality

Refers to the transmitting frequency in Doppler mode of the probe, the real-time value of which is displayed in the image parameter area.

Scale

This function is used to adjust the speed range of color flow, which is adjusted through PRF in the system. The real-time PRF value is displayed in the image parameter area.

To provide a much clearer color flow image.

Use low PRF to observe low-velocity flows, and use high PRF to observe high-velocity flows.

iTouch

To optimize image parameters as per the current tissue characteristics for a better image effect.

Auto Calculation

This function is used to trace the spectrum and calculate the PW mode image parameters. The results are displayed in the results window.

In real-time scanning, the results displayed are derived from the calculation of the latest cardiac cycle.

In the freeze and cine status, the results displayed are calculated from the current selected area.

- Auto Calculation Parameter: To set the calculation results to display.
- Auto Calculation Cycle: To set the heart cycle number for auto-calculation.
- Trace Area: To set the trace area of the Doppler wave in the spectrum map, applicable for auto calculation, V Max and V Mean display.
- Trace Smooth: To set the smooth level when tracing.
- Trace Sensitivity: This function is used to set the sensitivity of tracing in the spectrum.

Speed

This function is used to set the scan speed of PW mode imaging.

T/F Res

Adjusts for a balance between time resolution and spatial resolution.

WF (Wall Filter)

To display the image accurately, it adjusts the cut-off used in the wall filter, and filters out the flow noise which is produced by vessel wall vibration. The real-time value is displayed in the image parameter area.

Tint Map

This function provides an imaging process based on color difference rather than gray distinction.

Gray Map

Selects among post processing map curves to optimize grayscale images.

Display Format

Sets the display proportion of PW mode image and B mode image.

Duplex/Triplex

This function is used to set if B image or B+Color image (Power) is scanned synchronously.

HPRF

HPRF mode is used when detected velocities exceed the processing capabilities of the currently selected PW Doppler scale or when the selected anatomical site is too deep for the selective PW Doppler scale.

Baseline

Refers to the area where the velocity is zero in the spectrum. The map changes after being edited.

Angle

This function is used to adjust the angle between Doppler vector and flow to make the velocity more accurate.

The real-time adjusting angle value is displayed in the image parameter area.

Quick Angle

Adjusts the angle faster in increments of 60°, and the real-time value of which is displayed in the image parameter area.

Dynamic Range

The dynamic range conveys the information that being transformed from echo intensity to gray scale.

Audio

Adjusts the output audio in spectrum Doppler.

PW Steering

This function is used to adjust the angles for the sampling line. The PW Steer function is available only for linear probes.

6.8 TDI

TDI mode is intended to provide information of low-velocity and high-amplitude tissue motion, specifically for cardiac movement.

There are the following types of TDI mode available:

- Tissue Velocity Imaging (TVI): This imaging mode is used to detect tissue movement with direction and speed information. Generally the warm color indicates the movement towards the transducer, while the cool color indicates the movement away from the transducer.
- Tissue Energy Imaging (TEI): This imaging mode reflects the status of cardiac movement by providing the energy information, the larger the energy is, the brighter the color becomes.

- Tissue Velocity Doppler Mode (TVD): This imaging mode provides direction and speed information of the tissue.
- Tissue Velocity M Mode (TVM): This function assists to observe the cardiac motion through a direct angle.

6.8.1 TDI Mode Image Scanning

Perform the following procedure:

1. Select [TDI] button to enter the TDI mode.
 - In B or B+Color mode: to enter TVI Mode, parameters of TVI mode will be displayed.
 - In Power mode: to enter TEI Mode, parameters of TEI mode will be displayed.
 - PW mode: select [TDI] button and then select the PW mode button or [Update] button to enter TVD. The parameters of TCD are displayed.
 - M mode: select [TDI] button and then select the M mode button or [Update] button to enter TVM. The parameters of TVM are displayed.
2. Adjust the image parameters to obtain optimized images.
3. Select [TDI] button to exit from TDI mode and enter general imaging modes.
Or, select the B mode button to return to B mode.

6.8.2 TDI Mode Image Parameters

In each TDI mode, the parameters that can be adjusted are similar to those in the color flow modes (Color, PW, and Power). See the relevant sections for details. The following introduces the specific items in TDI mode.

Tissue State

This function is used for fast image optimization.

6.9 iScape View (Real-time Panoramic Imaging)

The iScape panoramic imaging feature extends your field of view by piecing together multiple B images into a single, extended B image. Use this feature, for example, to view a complete hand or thyroid.

When scanning, move the probe linearly and acquire a series of B images. The system pieces these images together into a single, extended B image in real time. The system also supports out-and-back image piecing.

After obtaining the extended image, you can rotate it, move it linearly, magnify it, add comments or body marks, or perform measurements on the extended image.

The system provides a color iScape function, so you can get more information from extended images.

CAUTION

- It is provided for reference, not for confirming a diagnosis.
- iScape panoramic imaging constructs an extended image from individual image frames. The quality of the resulting image is user-dependent and requires operator skill and additional practice to become fully proficient. Therefore, the measurement results can be inaccurate. Exercise caution

when you perform measurements in iScape mode. A smooth and even speed will help produce optimal image results.

NOTE:

- Guidance and precautions for even movement:
 - Make sure there is enough coupling gel along the scan path.
 - Always move the probe slowly and steadily.
 - Continuous contact is required throughout the length of the extended image. Do not lift the probe from the skin's surface.
 - Always keep the probe perpendicular to the skin's surface. Do not rock, rotate or tilt the probe during the scan.
 - The system accommodates a reasonable range of motion velocity. Do not make abrupt changes in motion speed.
 - Deeper scans generally require reduced acquisition speed.
-

NOTE:

Needle mark cannot be displayed in iScape imaging mode.

6.9.1 Basic Procedures for iScape Imaging

Perform the following procedure:

1. Connect an appropriate iScape compatible probe. Make sure there is enough coupling gel along the scan path.
2. Select [iScape] to enter iScape.
3. Optimize the B mode image:

In the capture preparation status, select the B mode page tab to select B mode image optimization. Do measurement or add comment/bodymark to the image if needed.

4. Switch to [iScape] page to enter the iScape acquisition preparation status.
5. Select [Start Capture] or [Update] button to begin the capture.

The system enters into image review status when the acquisition is completed. You can perform operations such as parameter adjusting.
6. Scan slowly to obtain a single extended field of view image. You can also erase and retrace if the image is not satisfactory.
 - During image acquisition, none of the parameters are adjustable, and functions such as measurement, comments and body marks are not available.
 - A green box on the image indicating the boundary between the merged images and the unfinished images.
 - During image slicing, the system gives feedback on the probe's moving speed in the form of colors and words. The meanings are as follows:

Status	ROI Color	Tip
Speed too low	Blue	Moving speed of the probe is too low.
Appropriate	Green	/

Status	ROI Color	Tip
Speed too high	Red	Moving speed of the probe is too high.

7. Do one of following to end image capture:

- Select [Stop Capture].
- Select [Update].
- Wait until the acquisition completes automatically.

After the acquisition is completed, the panoramic image will be displayed and the system enters iScape viewing mode.

6.9.2 Image Review

After the acquisition is completed, the panoramic image will be displayed and the system enters iScape viewing mode.

In iScape viewing mode, you can perform image parameters setting, zooming, rotation and adding measurements, comments and body marks.

Image size

Tap [Actual Size] to display the image in its actual size.

Tap [Fit Size] to display the image in a size that fits the current window.

Tint map

Tap [-] or [+] to change the value slightly or drag the control directly.

Ruler

Tap[Ruler] to hide or show the ruler around the image.

Rotation

Tap [-] or [+] to rotate the image clockwise or anticlockwise, or drag the control directly.

6.9.3 Evaluate image quality

Many variables may affect the overall image quality. It is important to evaluate the image content and quality before an image is used for diagnosis or measurements.



NOTE:

- iScape panoramic imaging is intended for use by well-trained ultrasound operators or physicians. The operator must recognize image items that will produce a sub-optimal or unreliable image.
 - If the image quality cannot satisfy the following criteria, you shall remove the image and capture it again.
 - The Image must be continuous (no part of an image moves suddenly or disappears.)
 - No shadow or absent signal along the scan plane.
 - Clear profile of anatomy through the entire scan plane without distortion.
 - Skin line is continuous.
 - The images are captured from the same plane.
 - There are no large black areas in the image.
-

6.9.4 Cine Review

Select [Review Cine] in panoramic image viewing status to enter cine reviewing mode. In cine reviewing mode, a frame marker indicates the sequence of the currently reviewed images in the panoramic image on the left-hand side of screen.

In cine review status:

- Drag the playback mark to the left to display the earlier stored images; drag the playback mark to the right to display the recently stored images. Or, swipe the image area to the right to display the earlier stored images; swipe the image area to the left to display the recently stored images.
- In manual cine review status, tap  to activate auto cine review.
- Review speed: in auto cine review status, tap to select different speeds
- Set first frame: drag the start mark to the frame as start point. Set end frame: drag the end mark to the frame as end point. Tap  to start auto play, and the review region is confined to the set start point and end point.
- Tap [Overview] to exit cine review mode. The panoramic image is displayed.
- In cine review mode, tap [UnFreeze] to return to the acquisition preparation status.

6.10 Smart B-line

The lung acoustic impedance difference increases with the increase of lung liquids. The ultrasound waves produce strong reverberations in the lung at different depth. After multiple reflections, the comet tail sign is formed, which is perpendicular to the pleura plane. Starting from the pleura line, the comet tail sign moves along with the lung and extends to the far field. The reverberation line perpendicular to the pleura plane is called Smart B-line.

Smart B-line is used to detect the B line of the lung in B mode. It supports B-line detecting in both real-time and freeze modes.

TIP:

Smart B-line is only available in Single B imaging mode.

- It supports single-frame and multi-frame image file detection in B mode.
-

6.10.1 Basic Procedures for Smart B-line

Perform the following procedure:

1. Select an appropriate probe and exam mode. The system enters the B mode by default.
2. Adjust the image parameters to obtain optimized images.
3. Select [Smart B-line] to enter Smart B-line mode.
Select the different zone combinations for examination.
4. Tap [Freeze] button to freeze the image.
5. Select a desired zone, and select the [Auto Calc] button.

The system automatically starts tracing the B line sampling area, and automatically recognizes and traces the B line in frame. The system automatically reviews the cine and calculates the quantitative index, and the calculation results are displayed on the screen.

- If necessary, you can reset the review region. For details, see “2.10.3 Auto Review”.
- If necessary, you can adjust the B line sampling area: Tap the dotted circle and drag the sampling line to change the position.

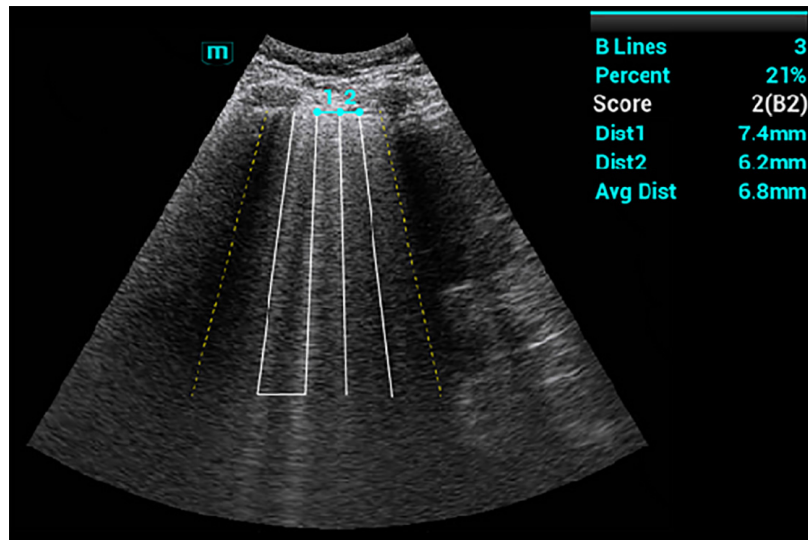

- B Lines: indicates the number of B lines of the current frame. The number can be 1, 2, 3, 4, or ≥ 5 . When the number is equal to or greater than 5, the system does not display a specific number.
- Percent: indicates the percent of the B lines area against the total sampling area.
- Score: the score is among 0 to 3.

Normal: when there are a lung sliding sign and A line, or isolated B lines (<3), it is marked as N in the brackets and the score is 0.

Moderate: when there are multiple clearly-distributed B lines, it is marked as B1 in the brackets and the score is 1.

Severe: when there are intensively fused B lines, it is marked as B2 in the brackets and the score is 2.

Lung consolidation: when the lung has a symptom that is similar to the liver lesion structure and air bronchogram, it is marked as C in the brackets and the score is 3. When the lung consolidation and pleural effusion occur at the same time, it is marked as C/P in the brackets and the score is 3.

- Dist n (B Line distance): indicates the distance between the 2 neighboring lines and is measured in the pleura line area, among which, n corresponds to the number between the 2 B lines.
- Avg Dist (B Line average distance): indicates the average distance of all B lines.

According to the quantitative index calculated by the system, you can add image and diagnosis information by clicking the check box beside the items.

6. Tap [Save Image] to save the single-frame image and B line calculation results.

If necessary, tap [Freeze] again to unfreeze the image. Repeat steps 4-6 to finish calculating other points.

6.10.2 Overview

After capturing images, tap [Overview] to display the color map of the lung and ultrasound image of a zone. The color map uses different colors to mark the ultrasound image analysis result of every lung zone. This analysis result is calculated from the ultrasound image with the highest percent of B line area.

6.11 Smart VTI

Smart VTI (Velocity-Time Integral) is used to calculate the CO (cardiac output) of the LVOT (left ventricular output tract), so as to quickly evaluate the cardiac function.

TIP:

Smart VTI supports calculation in real time.

Perform the following procedure:

1. Select a phased probe and Adult Cardiac exam mode.
2. Move the probe to capture an appropriate image of the long axis view of the left ventricular near the sternum.
3. Press the Measure button to enter the application measurement. Select the “LVOT Diam” item and the measurement cursor is displayed.
 - a. Tap and hold the hand icon to move the cursor to the desired position.

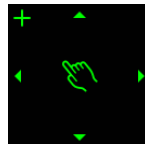

Tap the arrows around the hand icon to fine-tune the cursor position if needed.

- b. Tap the hand icon to fix the start point.
 - c. Tap and hold the hand icon to move the cursor to the desired position, you can also tap the arrows around the hand icon to fine-tune the cursor position.
 - d. Tap the hand icon to fix the end point.
4. Tap [Freeze] to unfreeze the image. Move the probe to capture an appropriate image of the apical five chamber view.
5. Tap [Smart VTI] on the right side of the operating panel to enter the Smart VTI mode.

The system will:

- Automatically trace the PW sampling line and sampling volume.
 - Automatically recognize the cardiac cycle: when there are ECG inputs, the ECG signals are preferred; when there are no ECG signals, the system automatically starts calculation.
 - Trace the LVOT spectrum in a cardiac cycle in real time to gain the VTI, HR, and CO results of the LVOT.
6. If necessary, adjust the PW sampling line and sampling volume:
Adjust the PW sampling line position and the PW sampling volume.
After adjustment, the LVOT spectrum tracing and calculation results display in real time.
 7. Tap [Freeze] to freeze the image, and check the Smart VTI calculation results.
If necessary, you can edit the LOVT spectrum manually:
 - a. Select [Edit VTI] to activate the cursor.
 - b. Move the cursor to the spectrum tracing line and tap the hand icon.
 - c. Move the cursor to trace a line.
After tracing, the calculation results display in real time.
 8. Select [Save VTI] to save the Smart VTI calculation results of the current cardiac cycle to the report.

9. Select [Graph] to check the quantitative index trend curve.

VTI, SV, and CO have different trend curves and are differentiated by colors. A maximum of 6 sets of Smart VTI results can be saved and displayed.

6.12 Smart IVC

Smart IVC is used to automatically measure the IVC inner diameter and calculate the change rate in the B mode image. Measure the IVC (Inferior Vena Cava) in real time, and the system automatically tracks and measures the changes of IVC inner diameter. It can be used to assist in treatments, such as volume estimation and fluid infusion.

TIP:

Smart IVC supports calculation in both real time and freeze modes:

- Enable Smart IVC in real time. The calculation starts from the current frame and ends after the image is frozen.
 - Enable Smart IVC in freeze mode or from the cine file. The calculation starts from the current frame and ends at the last frame. If the cine length is no longer than 10 seconds, it is allowed to calculate in retrospective from the current frame after the cine length reaches 10 seconds.
-

Perform the following procedure:

1. Select an appropriate probe and exam mode.
2. Move the probe to gain an appropriate IVC long axis image.
3. Tap [Smart IVC] on the right side of the operating panel to enter Smart IVC mode and start calculation.
 - a. Select a breath type: Spontaneous Breath or Mechanical Ventilation.
 - b. Select [Chg Resp time] > [Resp Rate] to set a respiratory time.

The system measures the IVC inner diameter of the image in every frame, calculates the maximum and minimum IVC diameters, and draws a quantitative index change curve in real time.

4. If necessary, you can adjust the IVC sampling line manually:
 - Position Adjustment: tap and hold the middle point of the IVC sampling to drag the sampling line.
 - Angle Adjustment: tap and hold any end point of the IVC sampling and drag to adjust the angle of the sampling line.
5. Tap [Freeze] to freeze the image and finish calculating IVC.

The calculation results and quantitative trend curve are displayed on the screen. Select the diagnostic Information item to add diagnostic information to the image.

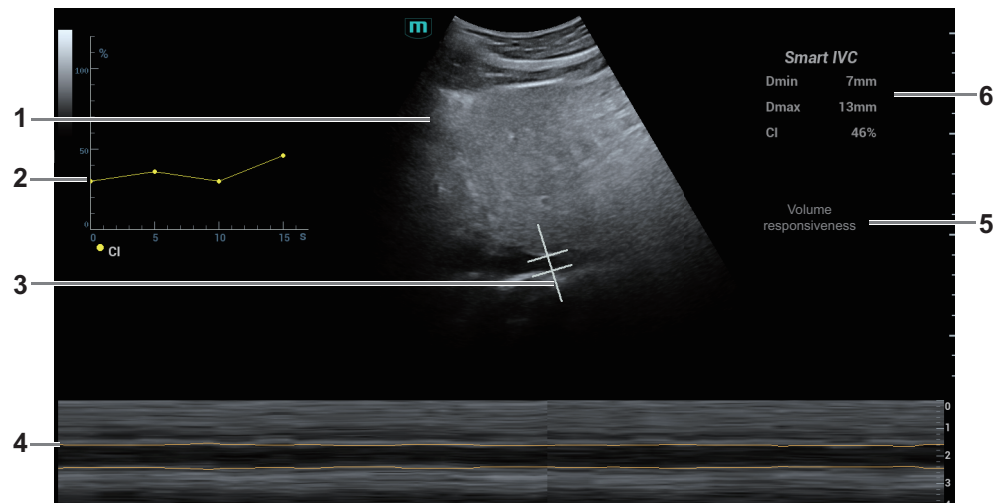

1	B Mode Image	/
2	IVC CI (Collapsibility Index), DI (Distensibility Index), IVCV trend curve	Corresponds to the selected breath type: <ul style="list-style-type: none"> • Spontaneous Breath: displays the CI curve. • Mechanical Ventilation: displays the DI and IVCV curve.
3	IVC Sampling Line	/
4	IVC Trending Line	The horizontal axis represents the time, which is displayed in the below Free Xros M image, and is traced along the IVC vessel wall.
5	Diagnostic Information	Displays the added diagnostic information.
6	Calculation Results Window	Displays the calculation results within the current calculation range. <ul style="list-style-type: none"> • Dmax: indicates the maximum IVC inner diameter within a respiratory cycle. • Dmin: indicates the minimum IVC inner diameter within a respiratory cycle. • IVC CI = $(D_{max}-D_{min})/D_{max}$ • IVC DI = $(D_{max}-D_{min})/D_{min}$ • IVCV = $(D_{max}-D_{min})/[(D_{max}+D_{min})/2]$

6. Select [Save Data] to save the calculating IVC results to the report.

6.13 Contrast Imaging

The contrast imaging is used in conjunction with ultrasound contrast agents to enhance imaging of blood flow and microcirculation. Injected contrast agents re-emit incident acoustic energy at a harmonic frequency much more efficient than the surrounding tissue. Blood containing the contrast agent stands out brightly against a dark background of normal tissue.

⚠ CAUTION

- Set MI index by instructions in the contrast agent accompanied manual.

- Read contrast agent accompanied manual carefully before using contrast function.
-

NOTE:

- Make sure to finish parameter setting before injecting the agent into the patient to avoid affecting image consistency. This is because the acting time of the agent is limited.
 - The applied contrast agency should be compliant with the relevant local regulations.
-

TIP:

Select an appropriate probe for Contrast Imaging, see the System Overview chapter.

6.13.1 Basic Procedures for Contrast Imaging

Perform the following procedure:

1. Select an appropriate probe, and perform 2D imaging to obtain the target image, and then fix the probe.
2. Select [Contrast] to enter the contrast imaging mode.
3. Adjust the acoustic power experientially to obtain a good image.
Set [Dual Live] to be “On” to activate the dual live function. Observe the tissue image to find the target view.
4. Inject the contrast agent, and set [Timer 1] at “ON” to start the contrast timing. When the timer begins to work, the time will be displayed on the screen.
5. Observe the image, use [Pro Capture] and [Retro Capture] button to save the images.
Select the Freeze button to end the live capture.

Perform several live captures if there are more than one interested sections.

For setting cine length in contrast imaging mode, see the Setup chapter.

6. At the end of a contrast imaging, set [Timer 1] at “OFF” to exit the timing function.

Perform steps 3-6 if necessary.

For every single contrast imaging procedure, use [Timer 2] for timing.

If necessary, activate destruction function by setting [Destruct] at “ON” to destruct the micro-bubbles left by the last contrast imaging; or to observe the reinfusion effect in a continuous agent injecting process.

7. Exit contrast imaging.

Select the B mode button to return to B mode.

6.13.2 Left Ventricular Opacification

Perform the following procedure:

1. Acquire ECG signal.
2. Select an appropriate probe and LVO exam mode.
3. Adjust the acoustic power experientially to obtain a good image.

Set [Dual Live] to be “On” to activate the dual live function. Observe the tissue image to find the target view.

4. Inject the contrast agent, and set [Timer 1] at “ON” to start the contrast timing. When the timer begins to work, the time will be displayed on the screen.
5. Observe the image, use [Pro Capture] and [Retro Capture] button to save the images.
Press the Freeze button to end the live capture.
Perform several live captures if there are more than one interested sections.
6. At the end of a contrast imaging, set [Timer 1] at “OFF” to exit the timing function.
Perform steps 3-6 if necessary.
For every single contrast imaging procedure, use [Timer 2] for timing.
If necessary, activate destruction function by setting [Destruct] at “ON” to destruct the micro-bubbles left by the last contrast imaging; or to observe the reinfusion effect in a continuous agent injecting process.
7. Exit contrast imaging.
Press the B mode button to return to B mode.

6.13.3 Image Parameters

When entering contrast imaging mode, the screen displays the contrast image, and if [Dual Live] item is “ON”, both the contrast image (marked with “C”) and tissue image (marked with “T”) are displayed (the two window position can be changed).

The parameters in Contrast mode are similar to those in B mode. See B mode imaging parameters for details. Special imaging parameters are introduced below.

Timer

NOTE:

The starting time displayed may be inconsistent with the actual one due to system error or some other man-made mistakes; please check the agent-injecting time.

The two timers are used to record total time of contrast imaging and single time of one contrast exam.

After the image is frozen, Timer 1 is still timing, and after unfreezing the image, the corresponding time can be seen.

Timer 2 stops timing when one contrast exam is frozen, and after unfreezing the image, the Timer 2 is off.

Set [Timer 1] as “ON” to start the timing at the moment you inject the contrast agent. Here, the screen displays the times at the lower corner.

Micro-bubble Destruction

CAUTION

Use the contrast imaging according to the residual level of the micro-bubbles, using contrast imaging continuously may result in human harm.

Destruct the micro-bubbles left by the last contrast imaging; or to observe the reinfusion effect in a continuous agent injecting process.

Select [Destruct] to enable the micro-bubble destruction function.

- DestructAP: Adjust the destruct acoustic power.

- Destruct Time: Adjust the destruct time.

Dual Live

In live mode or freeze mode, set [Dual Live] as “ON” to enable dual live function. Both the contrast mode and tissue mode are displayed. The THI and B image are displayed on the screen if the [Dual Live] is enabled.

Use [CEUS Pos: XX] to adjust the position of the contrast image.

When it is selected as “Left”, the image displays at the left part of the image area on the screen.

TIP:

- In dual live mode, the screen displays the contrast image and tissue image
 - In freeze mode, there displays only one cine review progress bar as the contrast image and tissue image are reviewed synchronously.
-

Mix Map

This function is to mix the contrast image with the tissue image, so that interested contrast regions can be located.

Use [Mix] to select different mixing mode.

- When dual live function is on, you can see the mixed effect on the contrast image.
- When dual live function is off, you can see the mixed effect on the full screen image.

Select the map through the [Mix Map] item.

iTouch

On contrast status, you can also get a better image effect by using iTouch function.

1. Select the iTouch button to turn on the function.

The symbol of iTouch will be displayed in the image parameter area once.

2. Select different levels of iTouch effect through [iTouch] parameter.
3. Select and hold the iTouch button to exit the function.

6.14 Image Saving

- Live capture

In live mode, you can save the interested images by selecting [Pro Capture] and [Retro Capture].

- Cine saving

In live mode, select the Freeze button to enter cine review status.

Tap [Save Clip] at the bottom of the operating panel.

6.15 Micro Flow Enhancement

MFE superimposes and processes multiple frames of contrast image during the cycle; it indicates tiny vessel structures in detail by recording and imaging microbubbles.

TIP:

- MFE imaging is available only for real-time imaging or cine file of auto review mode. If a MFE cine is reviewed manually, MFE effect cannot be displayed.

- In MFE status, patient should lie down and hold breath, and transducer should be kept still.

Perform the following procedure:

1. During real-time scanning, select [MFE] to start MFE imaging.
2. Use [MFE Period] to select different imaging period suitable for current flow. Where, MAX is the maximum superimposing effect.

6.16 Contrast Imaging QA

⚠ CAUTION

Contrast Imaging QA images are provided for reference only, not for confirming a diagnosis.

TIP:

- In case of inaccuracy of the data, do not adjust the depth and the pan-zoom when saving the cine.
- If the contrast signal inside the selected ROI does not meet the requirements of gamma fitting condition, that is the bulleting injection, curve fitting may not be available.

Contrast Imaging QA adopts time-intensity analysis to obtain perfusion quantification information of velocity flow. This is usually performed on both suspected tissue and normal tissue to get specific information of the suspected tissue.

Figure 6-1 Contrast QA Screen

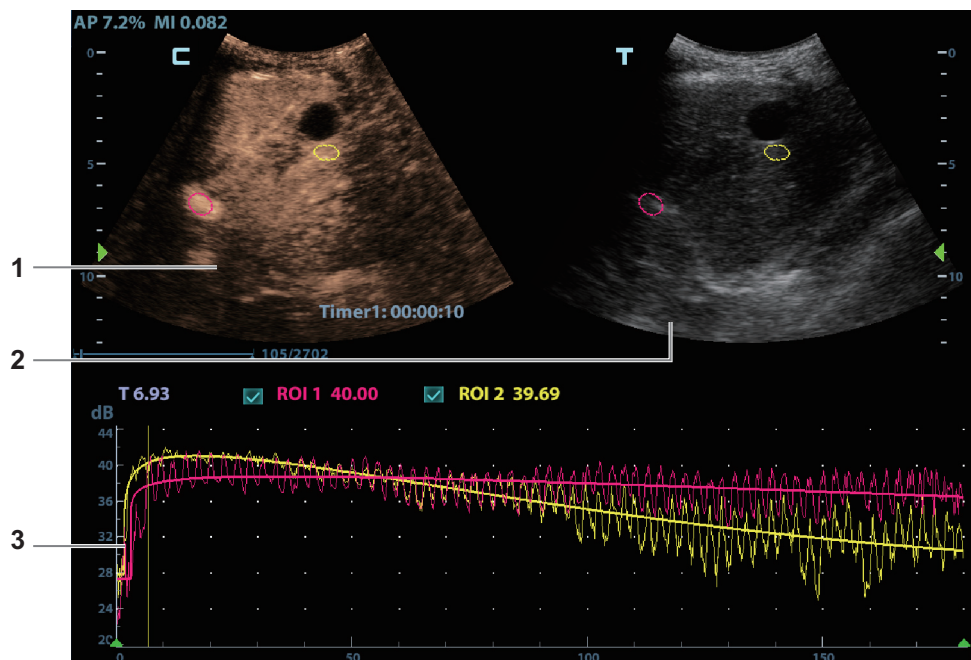

1	Contrast cineloop window	Sample area: indicates sampling position of the analysis curve. The sample area is color-coded, 8 (maximum) sample areas can be indicated.
---	--------------------------	--

2	B cineloop window	Sample areas are linked in the contrast cineloop window and B cineloop window.
3	Time-intensity curve	<ul style="list-style-type: none"> • Y axis represents the intensity (unit: dB), while X axis represents the time (unit: s). • Frame marker: a white line that is perpendicular to the X axis, can be moved horizontally left to right (right to left) by using the trackball. • Click the check box beside the ROI to set if to hide or to display the QA curve. • You can get the current X/Y axis value by moving the cursor onto one point on the curve; and if you press <Set> at this time, the frame marker will move to the spot.

Perform the following procedure:

1. Perform image scanning, freeze the image and select a range of images for analysis; or select a desired cine loop from the stored images.

The system set the starting time and ending time of the cine to be first frame and last frame of QA analysis range.

2. Review the image to a desired frame.
3. Select [Contrast QA] to activate the function.
4. Mark out the interested part (ROI).

Up to 8 ROIs can be saved on the reference image, with the corresponding eight traces plotted simultaneously on the graph. Each ROI display has a different color, and its corresponding trace data is plotted using that same color.

- a. Use [ROI Type] to select the method for determining the shapes of the sample area: Trace ROI and Ellipse ROI.

The cursor is evolved in the image review area.

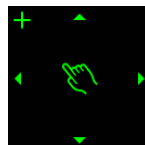

- b. Move the cursor to position the caliper on the reference image at the start point.
Tap the arrows around the hand icon to fine-tune the cursor position if needed.
- c. Tap the hand icon to fix the start point.

Trace ROI	<p>Follow the steps below:</p> <ol style="list-style-type: none"> 1. Tap and hold the hand icon to move the cursor to the desired position, you can also tap the arrows around the hand icon to fine-tune the cursor position. 2. Tap the hand icon to fix the second point. 3. Repeat steps 1~2 above to fix more points. 4. When a suitable ROI has been drawn, confirm the ROI by double tapping the hand icon. <p>The system automatically links the start point to the end point by drawing a line between them.</p>
-----------	---

Ellipse ROI	<p>Follow the steps below:</p> <ol style="list-style-type: none"> 1. Tap and hold the hand icon to move the cursor to the desired position, you can also tap the arrows around the hand icon to fine-tune the cursor position. 2. Tap the hand icon to fix the end point. 3. Tap and hold the hand icon to depict the ROI. Tap the arrows around the hand icon to fine-tune the cursor position if needed. 4. When a suitable ROI has been drawn, confirm the ROI by double tapping the hand icon. The system automatically links the start point to the end point by drawing a line between them.
-------------	--

- Select [Delete All] to clear out all ROIs.

The corresponding traces for the deleted ROIs are erased from the plot.

- Select [Copy ROI] to create a new ROI similar to the current or latest added ROI

5. Select [Motion Tracking] to enable the Motion Tracking function.

This function provides a motion compensated ROI as precise time-intensity information can be acquired using active tracking. It can enhance the calculation accuracy as reducing the impact of probe or patient respiratory movement.

6. If necessary, select [Fit Curve] to perform curve fitting on the time-intensity curve, where color of the fitted curve is consistent with color of the current ROI curve.

The system can calculate characteristic parameters according to curve fitting formula and data, display fit curve for time-intensity curve, and perform data analysis on time-intensity curve for data table.

- Select [Raw Curve] to hide/display raw curve.
- Select [Table Display] to check parameters:

Item	Description
GOF (Goodness of Fit)	Calculate the fit degree of the curve; range: 0-1, where 1 means the fit curve fits the raw curve perfectly.
BI (Base Intensity)	Basic intensity of no contrast agent perfusion status.
AT (Arrival Time)	Time point where contrast intensity appears, generally, the actual time value is 110% higher than the base intensity.
TTP (Time To Peak)	Time when the contrast intensity reaches peak value.
PI (Peak Intensity)	Contrast peak intensity.
AS (Ascending Slope)	Ascending slope of contrast, the slope between the start point of lesion perfusion to the peak.
DT/2	Time when the intensity is half the value of the peak intensity.
DS (Descending Slope)	Descending slope of the curve.
AUC (Area Under Curve)	To calculate the area under the time-intensity curves during contrast.

You can set range for the fit curve. After the range is set, the system displays fit curve within the range only. Use the trackball to the time-intensity curve to move the frame marker position.

- a. Set starting point of the fit curve: Use the trackball to select the starting time and select [Set Fit Start].
- b. Set end of the fit curve: Use the trackball to select the end time and select [Set Fit End].
7. Use [X Scale] on the touch screen to choose different value, so that the X scale display manner will be changed.

This function can be used to track detailed tissue information.

8. Save the curved image, export the data and do parameter analysis.
 - a. Select [Export].
 - b. Select the drive and enter the file name in the displayed window.
 - c. Select [OK] to save the data and return to the QA Analysis screen.

All displayed ROI traces are saved in the exported file.

The parameters are included in the trace file if the user has fixed a ROI.

Only data from the user selected image range is included in the exported trace file.
9. Select [Exit] to exit Contrast QA.

6.17 Auto GA

NOTE:

Auto GA must be used with convex probe.

After acquired image(s) of gastric antrum, by freezing image and tapping the Auto GA button, the feature shows boundary of gastric antrum and calculates the area of gastric antrum.

Perform the following procedure:

1. Scan and obtain the gastric antrum image and freeze the image.
2. Select [Auto GA], the system will automatically recognize and trace the target boundary to calculate.

The calculation result is displayed on the screen.
3. If the calculation result is not satisfactory, adjust the trace to recalculate.
 - a. Tap the traced contour to activate the cursor.
 - b. Tap to anchor the desired point on the traced contour.
 - c. Tap and hold the hand icon to move the cursor to the desired position, you can also tap the arrows around the hand icon to fine-tune the cursor position.
 - d. Repeat steps *b* to *c* above to adjust more points if needed.

The calculation results display in real time.
4. Tap [Accept Results] to accept the result.

After accepting the result, if the accepted result is not satisfactory, tap [Remeasure] and repeat step 3 above to update the result.
5. Select [Trend Curve] to check the trend curve of all the accepted results.

6.18 Smart FHR OB1

This feature is to manually select ROI (region of interest) of fetal heart in B mode, and then automatically calculate period of fetal heart motion and FHR (fetal heart rate).

NOTE:

- Different imaging presets or setups may affect the frame rate. Improve the frame rate by adjusting the image parameters to ensure the frame rate is at least 20 frame per second.
- Place the ROI on the target area after the fetal heart position remains stable, and keep the fetal heart located in the ROI box. When fetal heart remains inside the ROI placed by the operator, its position is considered to be stable.

Perform the following procedure:

1. Perform B-mode scanning under OB1, EM OB, ABD or EM ABD exam mode.
2. Adjust the image parameters to obtain a good image.
3. In real-time or frozen mode, select [Smart FHR OB1].
4. Tap the fetal heart area to position the ROI. The fetal heart rate measurement result will be displayed on the screen automatically.

If necessary, perform the following operation to update the measurement result.

Adjust the Region of Interest (ROI) if necessary:

- Tap the corner (green dot) of the ROI and drag to change the size.
- Tap inside the ROI box and drag to change the position.

In frozen mode, you can also use the start/end mark on the cine menu to reselect the time period.

The measurement result is updated simultaneously.

5. Tap [Accept Results] to save the calculation result to the report.

6.19 iWorks (Auto Workflow Protocol)

6.19.1 Overview

The main objective of ultrasound workflow automation (iWorks) is to speed up exam times and reduce the excessive number of user interface manual key strokes that can lead to repetitive strain injuries over time. It automates a clinical workflow in common exam protocols in a logical “step by step” manner. It also prevents missing important parts of examinations as well as decreasing exam times.

A Protocol Event contains series workflow events (annotation comments, body marks and measurements) and image modal commands to assist the user in routine ultrasound examinations.

The system provides different protocol events based on the different application regions.

6.19.2 Normal iWorks Basic Procedure

Perform the following procedure:

1. Enter the patient information.
2. Select [iWorks] to enter the protocol selection screen, and select the corresponding protocol to enter the status.
3. After the system enters the iWorks screen, the available protocol is displayed. Perform the scanning and saving according to the screen prompt.

Perform measurements or add comments/body marks to the image according to the screen prompt.

4. After a view scanning is complete, tap [Save Image] to switch to the next view according to the screen prompt.
5. Repeat step 3 and step 4 to acquire all the necessary images.
 - If a pathology is discovered, select [Insert] to select a protocol outside of the normal routine to start scanning.
 - [Repeat]: add a copy of the selected view to work on if necessary.
 - [Replace]: to delete images and operations for the selected view and restart operations on that view.
 - [Delete]: delete the currently activated view.
 - [Suspend]: start a manual scan when an unusual or atypical workflow is required, and select [Resume iWorks] to restart the iWorks procedure.
6. After all views are finished, the system will prompt you to exit iWorks. Select [Yes] to exit.

6.19.3 View Operation

In iWorks status, you can perform view selection, repeat, replacement and delete operations using the touch screen.

For some views, the system switches to the relevant imaging modes if necessary.

The comment for the current view has been automatically added to the image, ready for you to scan the specified anatomy.

View Selection

Tap view name to select the view to be scanned. The name of the current view is in blue.

View Operation

In the current active view, you can perform image scanning, measurements, and adding comments and body marks, etc. Operations are the same as those for manual operation. See the relevant chapters for details.

If the selected view is configured with measurement items, you can tap [Freeze] and then tap [Update] to start measurement.

Repeat View

If necessary, tap [Repeat] to insert another template of the current view. You can then perform an extra examination.

View Replacement

The previous image will be deleted and replaced by the new image.

Delete View

Tap the view name to select the view to be deleted. Tap [Delete] to delete the selected view.

6.19.4 Manual Examination

Suspend - Exit the protocol so the user can run the system manually. This is used when an unusual or atypical workflow is required.

You can run the system manually if necessary.

- Start manual examination: select [Suspend] to pause the current iWorks protocol. The system enters manual examination status.
- Return to iWorks: select [iWorks] to return to automated status. You can continue the previous iWorks scan.

6.19.5 Insert

Insert is a specialized protocol event within iWorks and iWorks OB. It assists with the workflow for documenting and measuring common pathological (disease) states (i.e. Mass, Cyst, Stenosis, Thrombus) that occurs outside a routine, normal examination.

1. Select [Insert] to enter the status.
2. Select the necessary protocol and the system adds the protocol events to the current protocol.
3. Perform measurements or add comments/body marks to the image if necessary.

This page intentionally left blank.

7 Smart 3D

The operator moves the probe to change its position/angle when performing the scanning. After the scanning, the system carries out image reconstruction, and then displays a single frame of 3D image.

NOTE:

Smart 3D imaging is largely environment-dependent, so the images obtained are provided for reference only, not for confirming a diagnosis.

7.1 Overview

The ordinary 2D imaging has the limitations on viewing the overall structure and different planes of the target. However, 3D imaging can obtain the reference information by overall observation.

7.1.1 Terms

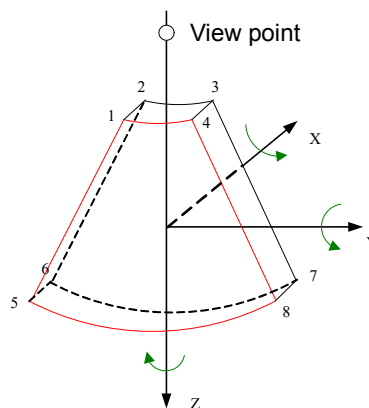

- Volume data: to obtain the data collection of three-dimensional object via the sequence reconstruction to two-dimensional object.
- 3D image Volume Rendering (VR): the 3D image on the screen.
- View point: the position for viewing volume data/3D image.
- MultiPlaner Rendering (MPR): a tangent plane of the 3D image that obtained by algorithm. Of which, XY-paralleled plane is C-plane, XZ-paralleled plane is B-plane, and YZ-paralleled plane is A-plane. YZ-paralleled plane is B-section. The probe is moved along the X-axis.
- ROI (Region of Interest): a volume box used to determine the height and width of scanning volume.
- VOI (Volume of Interest): a volume box used to display 3D image (VR) by adjusting interesting region in MPR.

7.1.2 ROI and VOI

After the system enters 3D imaging, a B image with ROI displays on the screen. A line (shown in the following figure) that shows the upper edge position of VOI is inside ROI.

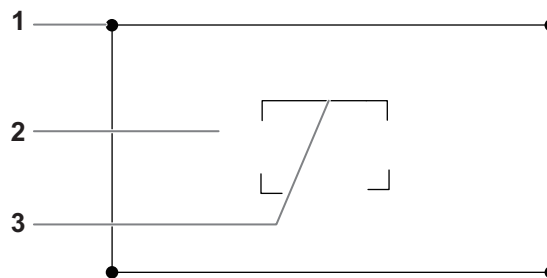

1	ROI size adjustment
2	ROI position adjustment
3	Cut plane

NOTE:

- To define a ROI, please remove the useless data as to reduce the volume data and shorten the time for image storing, processing and reconstruction.
- Set ROI on the 2D image with the largest section area of the fetal face.
- Set ROI a little larger than the fetal head.

ROI size and position

Perform the following procedure:

1. Tap the corner (green dot) of the ROI and drag to change the size.
2. Tap inside the ROI box and drag to change the position.

Curved VOI adjustment

Depending on the view direction, the orientation and the shape (line or dot) of curved VOI vary:

View	Curved VOI
U/D	At the upper part of curved VOI
D/U	At the lower part of curved VOI
L/R	At the left part of curved VOI
R/L	At the right part of curved VOI
F/B	Displays as a dot
B/F	Displays as a dot

7.1.3 Render Mode

Surface

Set 3D image rendering mode as Surface.

This is helpful for surface imaging, such as fetus face/hand or foot.

TIP:

You may have to adjust the threshold to obtain a clear body boundary.

Max

Set Max as 3D image rendering mode, displays the maximum echo intensity in the observation direction.

This is helpful for viewing bony structures.

Min

Set Min as 3D image rendering mode. Display the minimum echo intensity in the observation direction.

This is helpful for viewing vessels and hollow structures.

X Ray

Set X-ray as 3D image rendering mode. Display the average value of all gray values in the ROI.

This is used for imaging tissues with different structure inside or tissues with tumor.

7.1.4 MPR

MPR represents three different views of 3D image.

In the quad display format view, the screen displays 3 MPRs (A, B and C) and the 3D image.

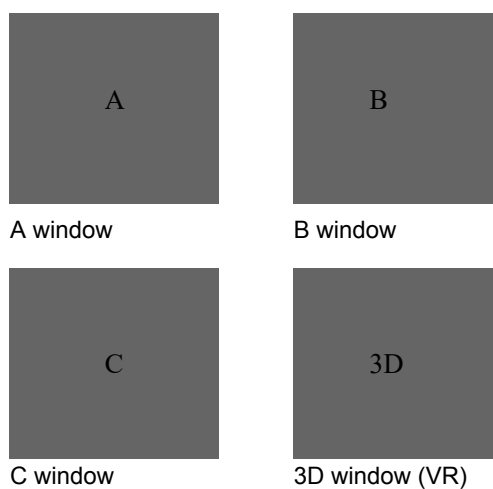

A, B, C sectional images are corresponding to the following sections of 3D image.

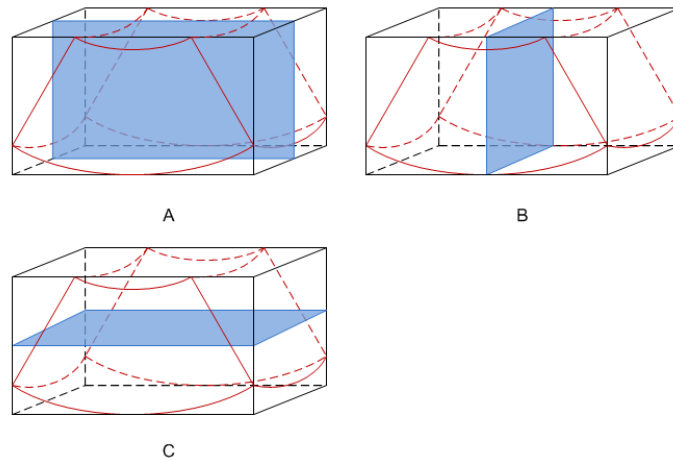

- Section A: corresponds to the 2D image in B mode. Section A is the sagittal section in fetal face up posture, as shown in the figure A above.
- Section B: it is the horizontal section in fetal face up posture, as shown in the figure B above.
- Section C: it is the coronal section in fetal face up posture, as shown in the figure C above.

⚠ CAUTION

The ultrasound images are provided for reference only, not for confirming a diagnosis. Please use caution to avoid misdiagnosis.

7.2 Note before Use

The quality of images reconstructed in the freehand 3D mode is closely related to the fetal condition, angle of a B tangent plane and scanning technique. The following Smart 3D description uses the fetal face imaging as an example, the other parts imaging are same as 3D imaging.

NOTE:

- In accordance with the ALARA (As Low As Reasonably Achievable) principle, please try to shorten the sweeping time after a good 3D imaging is obtained.
- A region with qualified image in B mode may not be optimal for 3D imaging. E.g. adequate AF isolation for one section plane of 2D image doesn't mean the whole desired region is isolated by AF for 3D imaging.
- More practices are needed for a high success of qualified 3D imaging.
- Even with good imaging condition, to acquire an approving 3D image may need more than one scanning.

Fetal Condition

- Gestational age
Fetuses of 24~30 weeks old are the most appropriate to 3D imaging.
- Fetal body posture
Recommended: Cephalic face up (figure a) or face aside (figure b); NOT recommended: Cephalic face down (figure c).

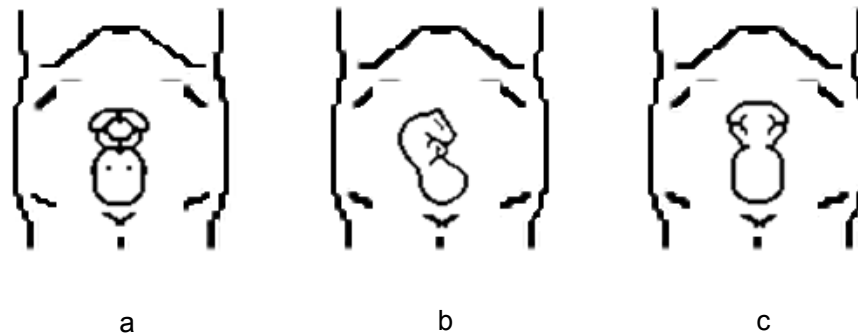

- Amniotic fluid (AF) isolation
 - The region desired is isolated by amniotic fluid adequately.
 - The region for imaging is not covered by limbs or umbilical cord.
- The fetus keeps still. If there is a fetal movement, you need a rescan when the fetus is still.

Angle of a B tangent plane

The optimum tangent plane to the fetal face 3D imaging is the sagittal section of the face. To ensure high image quality, you'd better scan maximum face area and keep edge continuity.

Image quality in B mode (2D image quality)

Before entering 3D capture, optimize the B mode image to ensure:

- High contrast between the desired region and the amniotic fluid surrounded.
- Clear boundary of the desired region.
- Low noise of the amniotic fluid area.

Scanning technique (only for Smart 3D)

- Stability: body, arm and wrist must move smoothly, otherwise, the restructured 3D image distorts.
- Slowness: Move or rotate the transducer slowly. The speed of linear scan is about 2 cm/s and the rotation rate of the fan scan is about $10^{\circ}/s \sim 15^{\circ}/s$.
- Evenness: move or rotate the transducer at a steady speed or rate.
- Method

Capture images using Linear scan or Rocked scan.

- Linear scanning

Move the probe across the surface. See the following figure.



- Rocked scanning

Rotate the probe once from the left to the right side (or from the right to the left) to include the entire desired region. See the following figure.

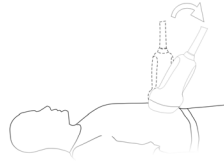

Scanning plane and probe movement

Move the probe across the body surface.

The arrow in the figure below indicates the movement of the probe.

You can move the probe in the opposite direction to the arrow.

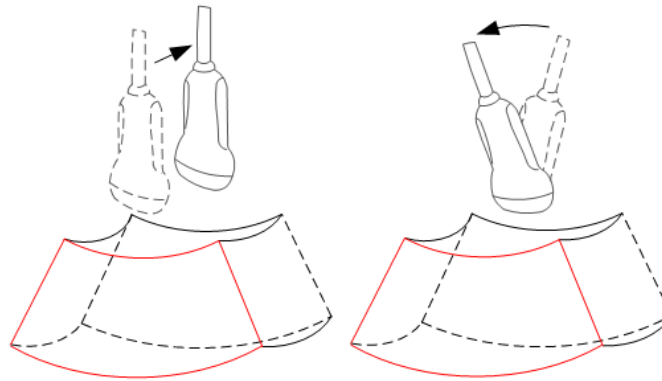

7.3 Smart 3D Image Acquisition

NOTE:

In Smart 3D image scanning, if the probe orientation mark is oriented to the operator's finger, perform the scan from right to left in linear scan, or rotate the probe from left to right in rocked scanning. Otherwise, the VR direction will be wrong.

TIP:

The probes L7-3s, L14-6s, 7LT4s, L14-5sp, L20-5s, 7L4s, L9-3s, L11-3VNs, L12-3RCs, L14-5Ws, L12-3VNs support Smart 3D imaging in the FDA region only.

Perform the following procedure:

1. Select the proper probe and exam mode; make sure there is sufficient gel on the probe for scanning.
2. Obtain a 2D image, and optimize the image if necessary.
3. Tap [Smart 3D] to enter Smart 3D imaging mode.
 - Adjust ROI size and position and the position of VOI.
 - Select the render mode.
 - Set the scan method and the movement of the probe.
4. Tap [Update] to start the 3D image acquisition.

The system enters into 3D image review status when the acquisition is completed; or, you can finish the acquisition ahead by tapping [Freeze] or [Update].

5. Exit Smart 3D
 - Tap [Update] or [Freeze] to return to Smart 3D acquisition preparation status.
 - Or tap [B] to exit the mode.

7.4 Smart 3D Image Viewing

Activate MPR

Tap [A], [B], [C] or [VR] to activate MPR or 3D image (VR).

MPR Viewing

In actual display, different colors of the window box and the section line are used to identify the section A, B and C.

- The color of window A is blue, and the color of the lines (representing section A) displayed in the other two windows is blue as well.
- The color of window B is yellow, and the color of the lines (representing section B) displayed in the other two windows is yellow as well.
- The color of window C is orange, and the color of the lines (representing section C) displayed in the other two windows is orange as well.

Positions of the other two sectional planes are indicated in the selected plane. You can roll the track ball to change the position.

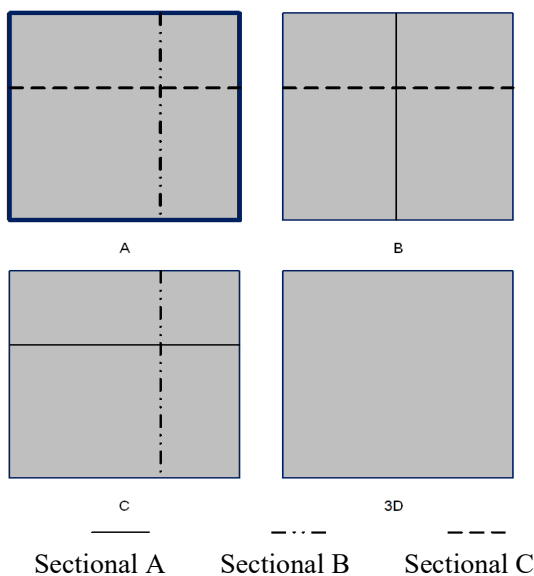

Display Format

Tap to select the display format of VR and MPR images: [Single], [Quad] and [A4:1].

MPR Only

Tap [MPR Only] to display MPR only. The adjustable image parameters are changed to MPR parameters automatically.

Only A, B and C MPR are displayed, and VR is not displayed.

View Direction

The Region of Interest (ROI) contains the section of the volume you want to render. You can adjust the view direction of the ROI.

The system supports the observation of 3D image from 6 directions.

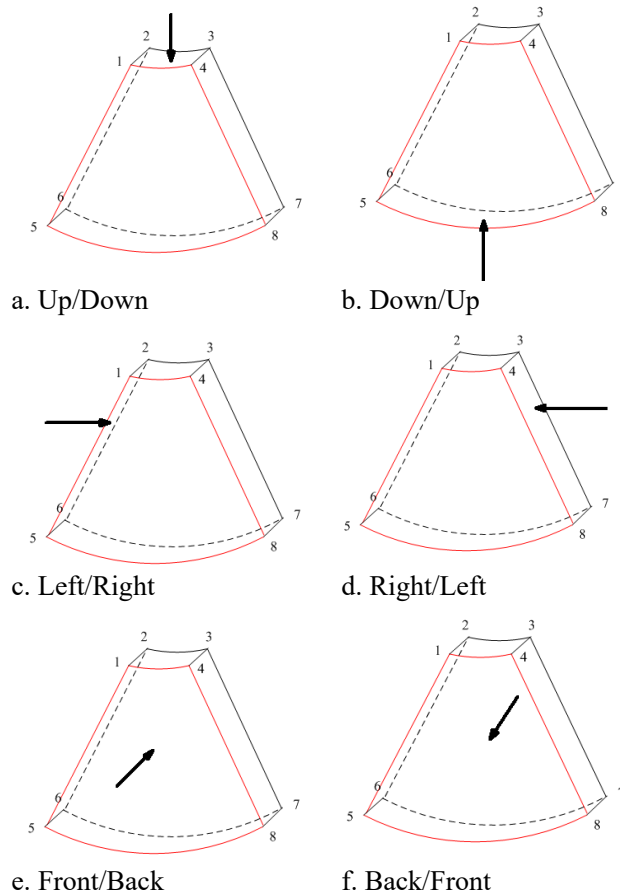

Tap [Up/Down], [Left/Right] or [Front/Back] to select the direction of the figure a, c and e.

Tap [Flip] on the first page to observe by the converse direction of the current direction, which is equivalent of the 180° rotation of current VOI, as shown in the figure b, d, e and f.

Adjust VOI

Adjusting the VOI box size and position is to select the volume data needed to restructure the 3D image and improve the reconstruction effect.

- VOI On
 - 3D image (VR) image displays VOI information.
 - a. In image viewing status, tap [VOI] to be “On”.
 - b. Select a desired section plane by tapping [A], [B] or [C] or [VR].
 - c. Change the VOI position, size and curved VOI if necessary.
- VOI Off
 - 3D image (VR) image displays ROI information.
 - Tap [VOI] to be Off, then the ROI image is displayed on the screen. Swipe the image in different directions to observe the MPR..

Accept VOI

This function is usually used for section image observation and to determine the relative position of the section image to the VR.

1. Tap [Accept VOI].
2. Select a desired MPR image by tapping [A], [B], [C] or [VR].
3. Swipe on the current active MPR to view the image. The other two MPRs change correspondingly.

The adjustment of Rendering Parameters

In image viewing status, you can render the image by adjusting the relevant parameters.

Tap [VR] or [MPR] to select the VR parameters or MPR parameters.

- When [VR] button is highlighted, adjust parameters of 3D image (VR).
- When [MPR] button is highlighted, adjust parameters of sectional image.

You can adjust:

Item	Description
Threshold	Set the threshold for 3D image rendering. 3D image is rendered on the signal above thresholds by eliminating noise via the Threshold parameter. Lower threshold can eliminate lower range noises and echo, which will contribute to a clearer and smoother image. Available only in Surface rendering mode.
Opacity	Adjust the transparency value for 3D image rendering. It implies the transparency of the light. The higher the value is, the tougher the surface becomes. The lower the number is, the more transparent the gray scale information will be. Available only in Surface rendering mode.
Smooth	Set the smoothness of 3D image. NOTE: Insufficient smoothness can result in a fuzzy image; however, too much smoothness will lead to image distortion.
Brightness	Set the brightness of image. NOTE: The adjustment is for 3D (VR) and MPR.
Contrast	Set the contrast scale of the image. As long as the contrast becomes larger, the bright spot and dark spot on the image change as well. NOTE: The adjustment is for 3D (VR) and MPR.
Tint	Enable/disable tint map. The color of image change according the tint value.
VR Orientation	Rotate the 3D image quickly.
iClear	Enhances the B mode image profile for better boundary details.

Reset Curve

Do one of the following to reset the curve:

Item	Description
Ori	To reset the volume rotation, shifting and zooming of 3D image to original status.
All	To reset the parameters, rendering rotation, VOI and image effect.
Reset Curve	To reset the curve to be the original beeline.

Render Mode

Set 3D image rendering mode.

The rendering manners can be applied to inversion mode.

Inversion

This function is to inverse the echo of the 3D image, so as to enhance observation for low-echo region, applicable for vessel, cyst and etc.

When the Inversion is turned on, the rendering mode parameters change into the corresponding inversion parameters.

Vessel shape is correct with the capture target. The vessel wall is smooth and clear.

Rotate the Image

Positions of the other two MPRs are indicated in the selected plane by arrows in different colors.

Using axial rotation function, you can rotate the currently activated image around the X-, Y- or Z-axis.

- Be sure to rotate the image by tapping the image window and move slowly.
- Swipe along the X/Y/Z-axis to rotate the image against the X/Y/Z-axis. Take rotation on window A for example:
 - To rotate along the X-axis: swipe from top to bottom and the image rotates right along the X-axis. Swipe from bottom to top and the image rotates to the left.
 - To rotate along the Y-axis: swipe from left to right and the image rotates right along the Y-axis. Swipe right to left and the image rotates to the left.

Image Zooming

Zoom in/out MPR and VR images by pinching the two fingers on the image.

Sync

This function switches the view direction perpendicular to the current active plane, so as to get a better view of VR.

Comments and Body Marks

Add comments and body marks to the MPR and VR.

The operation is the same as adding comments and body marks in B image mode.

Section image (MPR) measurement.

2D related measurements can be performed on MPR. For details, see [Advanced Volume].

Measurement is not available in acquisition preparation status.

7.5 Image Saving

Image saving

In the 3D Review mode, tap [Save Image] to save the current image and volume data to the patient information management system in the set format.

Image review

Open an image file to enter the image review mode. In this mode, you can perform the same operations as what you can in review mode.

This page intentionally left blank.

8

Physiological Unit Signal

The physiological unit signal waveform is used for checking ultrasound image in ultrasound exam (cardiac exam mainly).

WARNING

- Do not use the physiological traces for diagnosis and monitoring.
 - To avoid electric shock, the following checks shall be performed prior to an operation:
 - The ECG electrode cable must not be cracked, frayed or show any signs of damage or strain.
 - The ECG electrode cable must be correctly connected.
 - You must use the ECG leads provided with the physiological unit module. Failure to do so may result in electric shock.
 - The ECG electrode cable must be connected to the system first. Only after the cable is connected to the system, can the patient be connected to the ECG electrodes. Failure to follow these instructions may subject the patient to electric shock.
 - Do not place the ECG electrodes directly in contact the patient's heart; otherwise it may lead to stop of the patient's heartbeat.
 - Do not use this system when any digital device such as a high-frequency electrotome, high-frequency therapeutic device or defibrillator is applied already.
 - Conductive parts of electrodes and associated connectors for ECG should not contact other conductive parts including earth/grounding.
 - Frequent trampling or squeezing on the cables may result in cable breakdown or fracture.
 - Display effect of respiratory curve depends on the patient breathing status. While a very slow or smooth breathing may lead to an inapparent respiratory curve, breathing in a large amplitude may cause an incomplete display of the respiratory curve. Display effect is linked to the connected parts of the body. Generally, signals by connecting to limbs are stronger than by connecting to the chest.
-

8.1 ECG

Perform the following procedure:

1. Connect the device and place ECG electrodes.
 - a. Connect the ECG module to the serial port of the system.

- b. Place the ECG electrodes on the patient's body (as shown in the following figure).

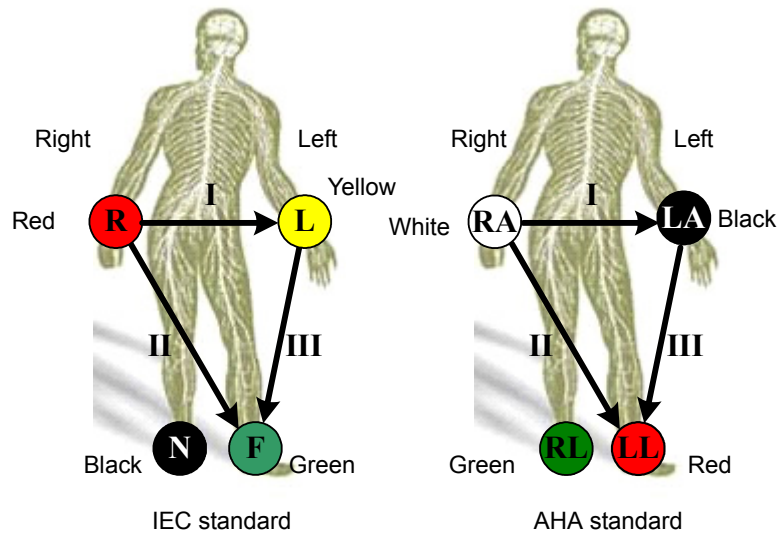

2. Tap [Physio] to enter physio operation interface.
3. Switch the imaging modes and display formats, adjusting the parameters to get an optimized image.
4. Parameter adjusting:
In image menu, tap [ECG] to enable or disable ECG waveform curve. Adjust the [Speed], [ECG Gain], [Position] and [Invert].
5. Trigger:
Tap [Trig Mode] to open the triggering function and set the trigger time.
6. Freeze the triggering image and the curve, and then review them.
7. Exit ECG mode, and remove ECG electrodes from the patient.

ECG Triggering

ECG triggering means that image scanning is activated at some time points of ECG signals, thus obtaining B images at these time points. The triggering image should be in 2D-mode.

When ECG triggering occurs, some marks (frame triggering mark) appear on the ECG waveform (relative R wave, the time for delay set), indicating the time points when the 2D images are captured.

TIP:

- The triggering mark is displayed in both freeze mode and live mode
 - The marks in Dual trigger are in different colors.
 - Triggering function is unavailable if the ECG trace is disappeared. Only the live 2D image can be triggered.
 - No delay time or time interval shall be less than the time required to scan a single image.
 - If the delay time is longer than a heart cycle, then the heart cycle in the delay time is omitted, that is to say no trigger is occurred when R waveform is detected in the duration.
-

Triggering Mode

This system supports single trigger.

Single Trigger: When an R waveform is detected, an image will be triggered after delay time T1. The time of T1 can be edited in single mode.

The image triggering operation is described as follows (Take single trigger as an example):

1. Select exam mode.
2. Select [Trig Mode] on the touch screen to enable the trigger.
3. Set the delay time.

8.2 ECG Review

8.2.1 Review Principle

When an image is frozen, the ECG waveform where the image is triggered will be frozen at the same time. In the Dual triggering mode, the two window images are frozen at the same time. When images are reviewed with the ECG electrodes connected, the ECG trace is the reference for time.

After the images are frozen, all real time images are in the status of linked review.

8.2.2 Linked Review of Waveforms, M/D Images and 2D Images

If the physio unit signal, time curve and 2D image are frozen at the same time, the replay of them is displayed at the same time.

8.3 Parameter Description

The physio parameters are described as follows:

Parameter	Description
ECG Source	Select ECG source.
Gain	Set the amplitude of the trace.
Position	Set the vertical position of the both traces on the image display.
Speed	Change the speed of the physio trace.
Trig Mode	Turn on/off the triggering function.
T1	Set the delay time T1 in Single trigger or Dual trigger.
Invert	Invert the display.

This page intentionally left blank.

9 Measurement, Annotations and Body Mark

9.1 Measurement

There are general measurements and application measurement. You can perform measurements on a zoomed image, cine reviewing image, real-time image, or frozen image. For measurement details, please refer to the *Advanced Volume*.

WARNING

- Be sure to measure areas of interest from the most optimal image plane to avoid misdiagnosis from inaccurate measurement values.
 - To obtain accurate Doppler flow measurement values, make sure the transmitting beam is not perpendicular to the flow, otherwise false readings and potential misdiagnosis may result.
-

CAUTION

- If an image is unfrozen or the mode is changed during a measurement, the calipers and measurement data will be cleared from the screen, but the measurement data will be stored in the report.
 - If the system is turned off or the End Exam button is selected during a measurement, the data not saved will be lost.
 - In Dual-B imaging mode, the measurement results of the merged image may be inaccurate. Therefore, the results are provided for reference only, not for confirming a diagnosis.
-

Measurement Accuracy

Table 9-1 Basic Dimension Measurements

Parameter	Range	Error
Distance	Full Screen	Within $\pm 4\%$
Distance (iScape View, linear probes)	Full Screen	Within $\pm 5\%$
Area (ellipse, circle)	Full Screen	Within $\pm 7\%$
Trace Area	Full Screen	Within $\pm 7\%$
Circ	Full Screen	Within $\pm 10\%$

Table 9-1 Basic Dimension Measurements

Parameter	Range	Error
Angle	Full Screen	Within $\pm 3\%$
Volume	Full Screen	Within $\pm 12\%$

Table 9-2 Basic Time Motion Measurements

Parameter	Range	Error
Distance	Full Screen	Within $\pm 4\%$
Time	Timeline Display	Within $\pm 2\%$
Heart Rate	Timeline Display	Within $\pm 5\%$
Velocity (PW mode)	10-200 cm/s (for non-transcranial application) 10-300cm/s (for transcranial application)	When angle $\leq 60^\circ$, $\leq 5\%$
Velocity (CW mode)	10-200 cm/s (for non-transcranial application) 10-300 cm/s (for transcranial application)	When angle $\leq 60^\circ$, $\leq 5\%$.

Table 9-3 Auto Measurements

Measurement Item	Error
Smart IVC	Within $\pm 10\%$
Smart VTI	Within $\pm 10\%$
Smart B-line	Within $\pm 10\%$
AutoEF	Within $\pm 10\%$
Smart FHR OB1	Within $\pm 10\%$
Auto GA	Within $\pm 10\%$
Smart Bladder	Within $\pm 20\%$

NOTE:

Within the selected field range, the measurement accuracy is ensured within the range mentioned above. The accuracy specifications are performance in the worst conditions, or based on the real test for the system, regardless of acoustic speed error.

9.2 Annotations

WARNING

Ensure that the entered annotations are correct. Incorrect annotations may lead to misdiagnosis!

Annotations can be added to an ultrasound image to bring attention, notate or communicate information observed during the examination. You can add annotations to: zoomed images, cine review images, real-time images, frozen images. You can type annotations as characters, insert pre-defined annotations from the annotations library or insert arrow markers.

9.2.1 Adding Annotations

Adding an Annotation Text

Perform the following procedure:

1. Select [Annotate] > [Comment] tab to enter the annotation status.
2. Tap to position the cursor on the desired location within the image area.
3. Do one of the following to add a comment:
 - Tap to select the desired annotation text on the annotation menu.
 - Tap the keyboard to bring up the soft keyboard, then type the alphanumeric characters.

In edit status (the characters are green in color), tap [Enter] on the soft keyboard to move the cursor to the new line. The cursor is aligned with the first line.

4. In edit status, tap regions other than the annotation on the image area to confirm the added character. The color of the added character turns to yellow.

Adding an Arrow

You can add an arrow to a location where you want to pay attention.

Perform the following procedure:

1. Select [Annotate] > [Comment] tab to enter the annotation status.
2. Adjust the shape and position of the arrow:

To position the arrow on the area of interest and change the orientation: tap and rotate the arrow icon to change the arrow position; tap and rotate the dotted line under arrow icon to change the arrow orientation.
3. Tap regions other than the added arrow on the image area to confirm the arrow position. The arrow turns yellow. Repeat the above steps to add more arrows.

9.2.2 Moving Annotations

Perform the following procedure:

1. Under annotation status (annotation menu is highlighted in blue), tap to select the annotation to be moved.
2. Tap the desired position to move the annotation to current position.
3. Tap regions other than the moved annotation on the image area to confirm the position.

9.2.3 Modifying (Editing) Annotations

Modifying (Editing) characters

Perform the following procedure:

1. In annotation status, tap to select the annotations to be modified.
2. Tap to select the added annotation, the annotation turns into green in editing status.
 - Tap [Keyboard] to show the soft keyboard and use the direction keys to move the cursor to the desired location to insert/delete characters. Either type characters by tapping the corresponding keys or select the new annotation text from the menu directly.
 - Tap  to delete the annotation character or text on the left side of the cursor.
3. Tap regions other than the edited comment on the image area to confirm the modification and exit the edit status. The annotation turns to yellow.

Modifying (Editing) Arrows

Perform the following procedure:

1. Tap to select the arrow that needs to be modified, the arrow then turns green.

To position the arrow on the area of interest and change the orientation: tap and rotate the arrow icon to change the arrow position; tap and rotate the dotted line under arrow icon to change the arrow orientation.
2. Tap regions other than the modified arrow on the image area to confirm the change.

9.2.4 Deleting Annotations

Deleting annotation characters, texts or arrows

Perform the following procedure:

1. Tap to select the annotation to be deleted, a [Delete] button displays on the bottom of the image area.
2. Tap [Delete] to delete the annotation.

Delete all annotations

Tap [Clear Comments] on the annotation menu to delete all the annotations.

9.3 Body Mark

WARNING

Ensure that the entered body mark is correct. Incorrect body mark may lead to misdiagnosis!

NOTE:

After powering off, the system will clear all comments on the image.

The Body Mark feature is used for indicating the exam position of the patient and transducer position and orientation.

9.3.1 Adding Body Mark

Perform the following procedure:

1. Select [Annotate] > [Body Markers] on the operating panel to enter Body Mark status as well as open the body marker menu.
2. Tap to select the desired body mark to bring out the Position Probe Marker dialog box.
3. To adjust the probe position and orientation marker:
 - Tap and rotate the bold solid green line to position the probe marker.
 - Tap and rotate the dotted line to adjust the probe marker orientation.
4. Tap [Set] to confirm the position and orientation of the probe marker and add the mark.

9.3.2 Moving Body Marks

You can move the body mark graphics to any desired position within the image area.

NOTE:

In Dual B Mode, a Body Mark cannot be moved between the separate image windows.

Perform the following procedure:

1. Tap to select the body mark. The body mark is covered by a green frame, indicating you can move it to a new position.
2. Tap the desired position to place the body mark.

9.3.3 Deleting Body Marks

Tap [Clear Markers] to delete the added body mark on the body marker menu.

9.4 Voice Comments

The system supports adding voice comment to the frozen images.

TIP:

- In voice comment recording status, you can perform measurements, comments adding, body marks adding, print tasks and DICOM tasks.
 - If you tap [Freeze] during the recording course, the already recorded voice comment cannot be saved.
-

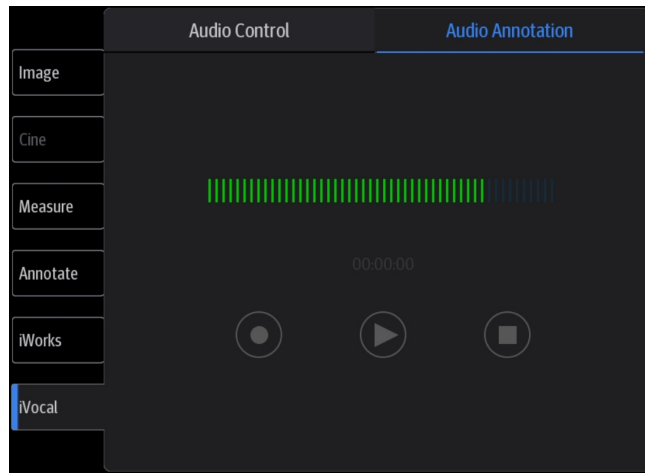

9.4.1 Voice Comment Panel

After the system enters the voice comment status, the voice comment panel will be displayed.



9.4.2 Adding Voice Comments

Perform the following procedure:

1. To perform voice comments adding, the function should be enabled, see “4.1.2 General”.
2. Connect the microphone to the mic port of the physic unit panel.
3. Acquire the necessary images and tap [Freeze] to freeze the image.
4. Select [iVocal] > [Audio Annotation] to enter the voice comment panel.
5. Tap  to start recording.
6. After the voice recording ends, tap  to end recording.
7. Tap [Save Clip] to save the cine.

9.4.3 Voice Comment Review

Open a cine file with voice comment, and during the cine review mode, voice comments are played as well.

10 Patient Data Management

An exam record consists of all information and data of one exam.

An exam record consists of the following information:

- Patient basic information and exam data
- Image files
- Report

NOTE:

- DO NOT use the internal hard drive for long-term image storage. Daily backup is recommended. External storage media is recommended for archiving images.
 - The system patient database space is limited, please back up or clear patient data in time.
 - Mindray is not responsible for lost data if you DO NOT follow suggested backup procedures.
-

10.1 Image File Management

You can store the image files either in the patient database in the system, or to external memory devices. For a save image, you can perform operations like image reviewing, analyzing and demonstration.

10.1.1 Storage Media

System supported memory media including:

- System hard disk
- USB memory devices: USB flash drive, removable USB hard disk
- Optical disk.

10.1.2 Image File Formats

The system supports file formats which belong to the system and file formats which are PC-compatible.

System-relevant formats

- Single-frame image file (FRM)
Refers to single-frame static image files not to be compressed; you can perform measurements and comments adding on this type of files.
- Cine file (CIN)
System-defined multi-frame file format; you can perform manual or auto cine review, and perform measurements or add comments for the reviewed images. After you open a stored CIN file, the system automatically enters cine review status.

PC-compatible formats



- Screen file (BMP)

- Single-frame file format, used to save the current screen, non-compressed format;
- JPG: Single frame export format.
- TIFF: Single frame export format
- Multi-medium files (AVI): Multi-frame export format.
- DICOM files (DCM)
 - DICOM standard files format, single-frame or multi-frame format, used to record patient information and images; you can only open DCM files to view rather than to edit.
- MP4: Multi-frame export format.

10.1.3 Image Storage Setting

Before using the image storage, see the Setup chapter for image storage settings.

10.1.4 Saving Full Screen Images to the System

Tap  in the top-right corner of the screen and select  to save single frame image (full screen). The image is saved in BMP format, you can check the image in Review screen.

10.1.5 Image Review and Analysis

You can review and analyze stored images (only refer to images stored in the system default path).

To review images

You can review all images stored in an exam, and send, delete or analyze the stored images.

Tap [Review] to enter Review screen or double-click the exam in iStation screen. Images of the current exam and the current patient are displayed.

Controls on the Review screen:

Item	Description
Patient tab	Select [Patient] tab to review or edit the currently-selected patient information.
Image operations	<ul style="list-style-type: none"> • [Select All]: tap to select all images in the thumbnail window. • [Deselect All]: after selecting [Select All], the button changes to [Deselect All]. Cancel all selections by selecting [Deselect All]. • [Send To]: tap to send the selected image to another location, DICOM server, printer, etc. • [Delete]: tap to delete the selected image. • : Tap to change the layout.
Done	Tap [Done] to exit Review.

Image Analysis

In image analysis status, you can view, zoom, perform image parameter adjustment and measurements, add comments and perform cine (multi-frame) review for a stored image. The operation steps are the same as those for real-time scanning. See the relevant sections for details.

1. To enter image analysis

In image review status, double-click the selected thumbnail to open the image.

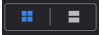
You can perform cine review operations in image analysis status.

2. Tap [Return] to exit image analysis.

10.1.6 Sending Image Files

NOTE:

Data saved this way can only be reviewed on the PC and cannot be restored to the ultrasound system.

Perform the following procedure:

1. Do one of the following to bring up the “Send To” screen:
 - In the iStation screen, select a stored image thumbnail and tap [Send To].
 - In the Review screen, select a image and tap [Send To].
2. Select the desired destination.

NOTE:

If MedTouch is set as the desination, the file sent to MedTouch is transferred into PNG format, and the cine file is transferred into AVI format.

10.2 Report Management

10.2.1 Report storage

The exam reports are stored under the directory of the exam of the patient.

10.2.2 Importing, exporting and sending a report

Import/export report via Backup

In iStation screen, select patient data, tap [Options] > [Back up]/[Restore] in the popped up menu to import or export patient information, images and reports from or to an external memory device.

Perform the following procedure:

1. Select the destination.
2. Select whether to remove from local HD after Backup.

If “Remove from local HD after backup” is selected, the exam are removed.

3. Select whether to encrypt backup exams for USB only: input the password and confirm password in the field box, and then tap [Backup]. A “Patient.7z” compressed package is backed up to the USB device, and you need to input the password to open the package.

NOTE:

- If the password is forgotten, you cannot open the backup package.
- The password cannot be multi-language or Chinese characters.

Export report via Send To

In the iStation or Review screen, use [Send To] to send patient data to an external memory device or network storage, you can choose if reports are exported.

Perform the following procedure:

1. Check “Export Report” on the screen.
2. Select report type to be exported.
3. Tap [Send] to confirm.

Export reports in Report screen

Perform the following procedure:

1. Tap [Report] on the operating panel to enter the report preview page.
2. Tap [Export] to open the exporting dialog box.
3. Select the path to export.

Report printing

Use a connected graph/text printer to print a report.

For details on report-related operations, see [Advanced Volume]

10.3 iStation - Patient Data Management

The patient data include basic patient information, exam information, image files and reports. You can search, view, backup, send, restore, delete or export patient data in iStation.

Tap [iStation] to enter iStation screen.

10.3.1 Searching a Patient

Perform the following procedure:

1. Select the data source.
 - Tap [Data Source] to select the data source of patient data, the system patient database is default.
2. Enter the search condition:
 - Filter: including Name, ID, DOB, Operator and Exam Date, etc. Then enter a keyword in accordance with the Item selected.
 - Tap [Find in results] to make it highlighted, then the system can search on the keyword in the existing searched results.
3. The system searches and displays the results in the patient list.
4. Swipe the screen from left to right to check other information of the patient.

10.3.2 Patient Data View & Management

Tap to select the desired patient exam in the list, you can:

Item	Description
Delete Exam	Select an exam record, tap [Delete] to delete the record. You cannot delete patient data which is being printed, exported or sent, or delete the current exam.
Backup/ Restore	You can back up the selected patient data to the system-supported media in order to view it on PC, or restore the patient data to the system from an external media. <ul style="list-style-type: none"> • [Options] > [Back Up]: back up the selected patient data to the system-supported media. • [Options] > [Restore]: import patient data from an external media.

Item	Description
Send Exam	<p>The system supports sending data to external memory devices, print or iStorage. You can use this function to export the exam data to external devices (in PC data or DICOMDIR data format) and then import to PC or restore to the ultrasound system to review the data (DICOMDIR).</p> <ol style="list-style-type: none"> 1. Select the patient record, tap [Send To] to send exam data and images of the selected record. Select from the destination, and set related settings. 2. Select the desired destination, and set related settings.
Activate an Exam	<p>After you select an exam, which has been performed within 24 hours, tap [Options] > [Activate] to activate the exam and load the basic patient information and measurement data to continue the exam.</p> <p>If you want to select a patient data in an external memory database to start a new exam or recover the exam, you have to first allow the system to load the patient data to the system's patient database.</p>
Query/Retrieve	For details of DICOM Query/Retrieve function, see the DICOM/HL7 chapter.

Double-click the patient exam to enter review screen, you can check patient information data and images.

10.3.3 Image Compare

Perform the following steps to perform image compare.



1. Tap [iStation] to enter the iStation screen, and select the exam to be compared.
2. Tap [Compare] to enter the Compare screen, and select the images to be compared.

Tip: for B/B+COLOR/B+TVI/B+POWER/B+TEI mode image, you can select at most 2 images; for PW/M/CW/TVI/contrast single mode image, you can select at most 2 images.
3. Tap [Done] to enter image comparison mode.
4. Review images from different image windows. Tap the single-frame image to switch the active image window; or, tap the cine twice to switch the active image window.

The window with the highlighted "M" mark is the currently activated window.
5. Save the image if necessary.
6. Tap [Return] on the screen or tap [UnFreeze] to exit image compare.

10.4 Recycle bin

The recycle bin is used to store deleted patient data, exam data and images.

To recover deleted patient data, tap  in the top-right corner of the screen and select  to enter the Patient Recycle Bin screen.

To recover deleted patient data

NOTE:

if the capacity of the recycle bin exceeds 200. The system reminds the user to clean. Follow the procedures to clean the recycle bin.

Perform the following procedure:

1. Select items in the list. Select operations:

- Tap [Restore Items] to restore the item to iStation.
 - Tap [Delete] to delete the item permanently. The item can never be restored again.
2. Tap [Done] to exit the screen.

To set maximum number of days for deleted data to be kept in the recycle bin

NOTE:

The patient exams which exceed the preset maximum will be deleted and unrecoverable, it is recommended to perform patient data backup before enabling this function to avoid data loss.

Perform the following procedure:

1. Input the desired number besides “Maximum number of days to be kept”.
If the input box is left blank, the feature will not be enabled.
Only the whole number ranging from 1 to 365 can be input.
2. Tap [Modify].

10.5 iStorage

Network storage is used to save image files and measurement reports to the remote PC server. For network storage setting, see the Setup chapter.

Perform the following procedure:

1. Enter iStation, select one (or more than one) patient data or image in the local data source.
2. Tap [Send To].
3. Select [iStorage] in the Send To dialog box, and select the PC server of the right side.
4. Select PC transfer format and check whether to send report.
5. Tap [Send] to start sending.

10.6 Print

For printer connection, see the System Preparation chapter.

For details about printer selection and print service setting, see the Setup chapter.

10.6.1 Image Printing

For DICOM image printing, refer to relevant chapters. Video printer is applied in image print service.

Print current screen image

In the main screen, use [Freeze] to freeze the image and tap [Print] to print the current screen image.

Image print via send to function

Perform the following procedure:

1. Select the desired image in the iStation or Review screen.
2. Tap [Send To] and select the printer in the dialog box which appears.
3. Tap [Send] to start printing.

4. See the accompanying printer manuals for more details.

10.6.2 Report Printing

Both reports and images can be printed on a graph/text printer.

1. Tap [Report] to enter the report dialog box.
2. Tap [Preview] to enter report preview screen.
3. Select [Print] to print the report.

See the accompanying printer manuals for more details.

10.7 Back up Files using the DVD Drive

CAUTION

During the backup process, if a CD/DVD is forcibly taken out or you perform other operations, the backup process will fail or the system may malfunction.



The system supports writing data to CD/DVD using the DVD-RW/DVD+RW drive and reading data from CD/DVD on the PC.

Perform the following procedure:

1. Put a CD/DVD in the external DVD R/W drive.
2. Select the data to be backed up and then select [Option] > [Back up] in the iStation screen. Select the target drive in the Back Up Patient Record dialog box.
3. Tap [Back up] to begin writing.

You can check the data writing procedure in the patient task manager.

10.8 Patient Task Management

Tap  (21.5-inch screen)/ (15-inch screen) in the top-right part of the screen to bring up the following dialog box.

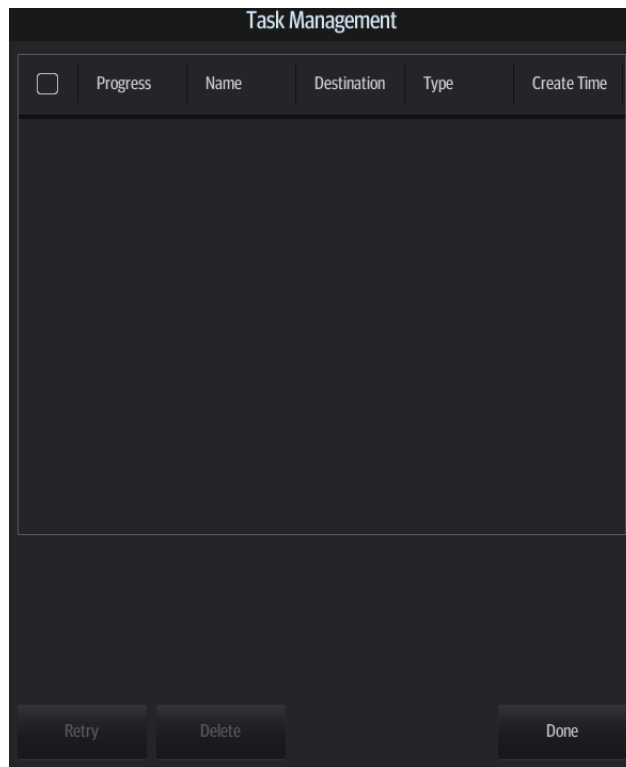

In the Task Management dialog box, the patient name, destination, progress, type and task created time are displayed.

You can perform the following operations:

- Tap [Delete] to delete the task.
- Tap [Retry] to retry the failed task.

Storage Task

Displays the DICOM storage task.



DICOM Print Task



Displays the DICOM print task.

Media Storage Task

- Storage Task: displays the DICOM storage task.
- DICOM media storage task (USB devices): in iStation screen, select the target exam and tap [Send To], then select DICOMDIR in the menu which appears.
- Back up task (system-relevant format): select the exam to be backed up in iStation and tap [Options] > [Back Up].
- Send to external devices (USB devices): select exam data or images in the iStation or Review screen. Tap [Send To] for the image.
- iStorage task: in iStation screen, select the target exam and tap [Send To], then select iStorage in the menu which appears.
- MedTouch storage task: In iStation screen, send exam to MedTouch devices.

Task Status

- When there are tasks underway, the task management icon displays as  ().

- When tasks have failed, the task management icon displays as . Tap the icon to check the reason for the failure.
- When the task management icon displays as , it means no task is underway.

Troubleshooting

If a serious error occurs, such as network disconnection or operation timeout, the system can try to reconnect the network. The interval time and maximum retries can be set as desired. For details, see the Setup chapter.

10.9 V-Access

The ultrasound system can be used to log on to a remote server to check or modify patient data on the server.

Perform the following procedure:

1. Tap  from the system tool bar in the top-right corner of the screen to enter the function.
2. The system brings up a dialog box for entering the IP address of the remote server.

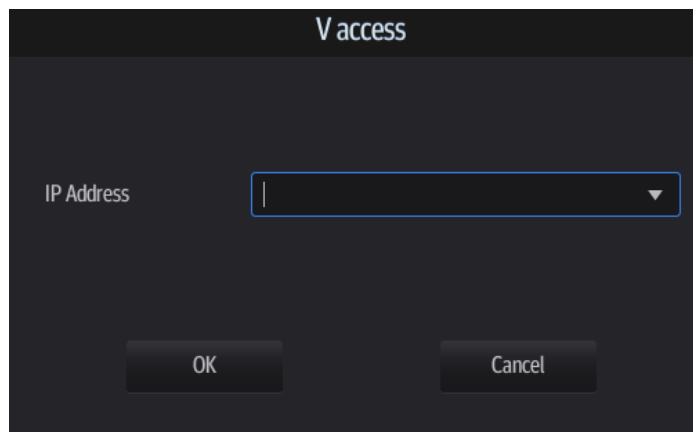

3. Enter the IP address and tap [OK].
4. Log on with the server account and password.
5. Check the data transferred and carry out operations as necessary.

10.10 Q-Path



You can use the ultrasound system to check data on browser directly. After you have ordered storage service of a network website service, you can check data using the website, authorized account and password (provided by the service vendor).

Q-path is a network server provided by Telexy Healthcare Inc. for digital image storage. For details, please contact Q-Path service provider.

NOTE:

- For Q-path settings, see the Setup chapter.
- If you use Q-Path function to connect to websites other than Q-Path applications (website setting is described above), the system will prompt the following information: Only Q-Path application is allowed to be loaded!

Perform the following procedure:

1. Set the DICOM storage server.
2. Send stored images or worksheet reports from iStation/Review to the Q-Path server.
3. Tap  in the top-right corner of the screen and select .
4. Log in to the Q-Path server through the Q-View browser to check the stored images and worksheet reports.

If network connection is not normal, the system will prompt “Loading Q-path application, please wait....”.

5. Tap  to exit the function.

11 DICOM/HL7

NOTE:

Before using DICOM, please read the electronic file DICOM CONFORMANCE STATEMENT along with the device.

TIP:

The DICOM package is optional, so the description here is only applicable for the system configured with the DICOM package.

This system supports the following DICOM functions:

- Verify Connectivity
- DICOM Storage
- DICOM Print
- DICOM Worklist
- MPPS (Modality Performed Procedure Step)
- Storage Commitment
- Query/Retrieve
- Structured Report
- DICOM Medium Storage (DICOMDIR Review)
- DICOM Task Management

If all the DICOM presets on the DICOM Service Preset screen are completed, you are ready for the Storage, Print, Worklist (HL7 Query), MPPS, Storage Commitment and Query/Retrieve applications. For detailed information about DICOM presets, see “4.3 Network Related Preset”.

11.1 DICOM Storage

DICOM Storage is used to send images (single-frame or multi-frame) or structured report to the DICOM storage server for storage.

11.1.1 Send images on iStation/Review

Perform the following procedure:

1. Do one of the following to select images:
 - Tap [iStation] to open the iStation screen. Tap to select an exam record in the list. Or
 - Tap [Review] to enter the Review screen. Tap to select a thumbnail or several thumbnails.
2. Tap [Send To] to bring up the Send To dialog box.
3. Tap to select “DICOM” in the Target box on the left side, then select the DICOM storage server in the Choose Storage Server box on the right side.
4. Tap [Send] to start sending.

11.1.2 To send images to storage after an exam ends

TIP:

To preset Sending/printing after End Exam and set a default storage server, for details see the Setup chapter.

Start the ultrasound exam scan. Tap [End] to send the image or the cine to DICOM storage automatically.

If images are successfully sent to the storage server, in the iStation screen, “Send to PACS, OK” is displayed in the list below “Storage Commitment”.

11.2 DICOM Print

DICOM Print is used to send images to the DICOM print server for printing.

11.2.1 Print images on iStation/Review

Perform the following procedure:

1. Do one of the following to select images:
 - Tap [iStation] to open the iStation screen. Tap to select an exam record in the list. Or
 - Tap [Review] to enter the Review screen. Tap to select a thumbnail or several thumbnails.
2. Tap [Send To] to bring up the Send To dialog box.
3. In the Send To dialog box, select a DICOM print server.
4. Tap [Send] to begin printing.

11.2.2 To send images to DICOM Print after an exam ends

TIP:

To preset Sending/printing after End Exam, for details, see the Setup chapter.

Start the scan and obtain the image. Each time [End] is tapped, the system will send the image to the default DICOM print server for printing.

11.2.3 To print images after saving image

TIP:

To preset “While Storing Image to Hard Disk, Send to DICOM Printer” and set a default DICOM print server, for details see the Setup chapter.

After finishing the setting, perform image scanning. Each time you use [Save Image] to save image, the system will send the image to the default DICOM print server for printing.

11.3 Worklist

When the DICOM basic package is configured and the Worklist server has been set, tap [Worklist] in the “Patient Info” screen to query or import the patient data.

Perform the following procedure:

1. In Patient screen, select [Worklist] in the bottom-left corner to enter the import screen.
2. Select the data source: select the server type, choose a Worklist server in the “Server Type” drop-down list.
All the patient exam records are listed.
3. Enter the search condition:
 - Set query criteria, or select the search key, enter the keywords, then tap [Query] to search. Enable “Query on Display” in [Worklist setting], the Query function will be activated automatically when entering the import screen.
 - To reset the criteria, tap [Clear].
4. Select the desired patient record in the displayed patient list.
 - When there is no exam, select the patient to start the exam.
 - When an exam is available, select the patient and a dialog box is displayed.
Start New: Ends the current exam and creates an exam with the selected patient information.
Merge: Merge the selected patient information with the patient information of the current exam.

11.4 MPPS

MPPS is used to send exam state information to the configured server. This facilitates the other systems in obtaining the exam progress in time.

The status information is described as follows:

- When you begin an exam or send images during an exam, the system sends “Active” status information to the MPPS server.
- When the exam is complete, the system sends “End” status information to the MPPS server.
- When a paused exam is continued, the system sends “Active” status information to the MPPS server.
- When an exam is canceled, the system sends “Canceled” status information to MPPS server.

11.5 Storage Commitment

Storage commitment is used to confirm whether the images or structured reports are successfully stored on the DICOM storage server.

Before using storage commitment, set the associated storage service.

If images are successfully sent to the storage server, in the iStation screen, “PACS received, OK” is displayed in the list below “Storage Commitment”.

Multi-frame storage is not allowed if “Allow Multiframe” is not selected (For details, see *DICOM Service Preset* in the Setup chapter). For example, even if there is a multi-frame file in the exam to be sent, only single-frame image storage will be performed.

11.5.1 After sending images on the iStation screen

Perform the following procedure:

1. Open the iStation screen.

2. Select an exam (a suspended exam or an inactive exam) (images are stored in the exam record).
3. Tap [Send To] to open the Send To dialog box.
4. Tap to select “DICOM” in the Target box on the left side, then select the DICOM storage server in the Choose Storage Server box on the right side.
5. Tap [Send] to start sending. The system will send all the images stored in the exam record to the storage server. Meanwhile, it will send storage commitment to the storage commitment server.

11.5.2 Storage commitment after an exam ends

Perform the following procedure:

1. Preset Sending/printing after End Exam, for details the Setup chapter.
2. Set the default storage server and storage commitment server.
3. After finishing the presets, perform image scanning. Each time [End] is tapped, the system will send the image to the default DICOM storage server for storage and send storage commitment to the storage commitment server.

Storage commitment is confined to the whole exam. Not each image sending can be indicated.

11.6 Query/Retrieve

The query/retrieve function is used to query and retrieve patient exam records in a designated server.

After setting the DICOM query/retrieve server, you can perform the query/retrieve function in the iStation screen.

1. Tap [iStation] to enter iStation screen.
2. Tap [Query/Retrieve] to open Query/Retrieve screen.
3. Select the server (both the source and the destination).
4. Enter the query information, such as Patient ID, Patient Name, Accession #, Exam Date or key words.
Tap [Clear] to empty the entered query information.
5. Tap [Query]. The system performs the query and lists the results in the patient (source) list.
You can perform further queries based on the results by entering new query information.
6. Select patient records according to the actual situation.
7. Tap [Retrieve] to retrieve the patient records in the DICOM query/retrieve server to the local machine.
8. Tap [Done]. The retrieved patient records are listed in the iStation screen.

11.7 DICOM Media Storage

Patient data in the ultrasound system can be saved on external media in DCM format, while DCM files can be accessed in the ultrasound system.

11.7.1 Media Storage

Perform the following procedure:

1. Select patient records in the iStation screen.

2. Tap [Send To] in the menu which appears to open the dialog box.
3. Select the destination to “DICOMDIR” and DICOM Format as well as compression mode. You can select to delete the exam or the image after the backup, and select to hide patient information.
4. Tap [OK]. The image from the current exam is sent to the external storage media in DICOM format.

If the backup is successful, a tick will appear in the Backup list in the iStation screen. If not, there will be no tick.

TIP:

There must be no DICOMDIR/DCMIMG/IHE_PDI files on the external storage media of the same name as the one being backed up. Otherwise, the backup cannot proceed. Ensure there is enough storage space, or the backup may fail due to shortage of space.

11.7.2 Media review

Perform the following procedure:

1. Connect the external media with DCM files to the system.
2. Select the data source in iStation screen, and the visible data will be shown.
3. If there are several types of data on the media, the system will ask you to select the format. Then, tap [DICOMDIR].

11.7.3 Data Restore

NOTE:

Only system-accessible media can be selected.

After the DICOM format data are saved to external media, restore the data to the ultrasound system. Connect the external media containing DCM files to the system.

1. In iStation, review the data stored on the external media.
2. Select the data to be restored in iStation.
3. Tap [Option] > [Restore] on the iStation screen.

11.8 Showcase Recording

Showcase software can be employed for DICOM image file viewing.

When files and structured reports are saved in DCM format through DICOMDIR and sent to storage devices, the showcase can be sent to the storage devices together. Connect the storage device, and the user can view files in DCM format through showcase.

NOTE:

To view the DCM files successfully, it is suggested to install NET Framework (Visual Studio.Net) of a version later than 2.0, if your computer was installed with TortoiseSVN.

11.9 Structured Report

The Structured Report (SR) can be sent with meeting the following procedures:

- DICOM structured report installed with the corresponding exam mode;
- The state of the SR should be “Cancel” or “Stop”.
- Set the storage option to “Attach SR When Store Images” or “Only Store SR”, see the Setup chapter.

NOTE:

Only the PACS system from the Medstreaming company (<http://www.medstreaming.com/default.aspx>) supports sending self-defined measurements by DICOM SR.

11.9.1 Send structured reports for storage

Perform the following procedure:

1. Create new patient information or load scheduled patient information.
2. Perform measurements.
3. Save the images.
4. End the exam.
5. Open the iStation screen, select the patient exam, and tap [Send To] to open the Send To dialog box.
6. Select “DICOM” in the Target box on the left side, then select the DICOM storage server in the Storage Server box on the right side.
7. Tap [Send]. Check for the result in the DICOM Task Management dialog box.



The structured report can be sent automatically.





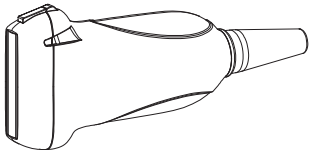

11.9.2 Back up structured report

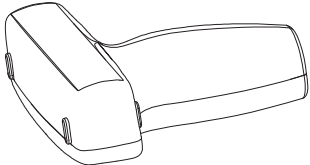
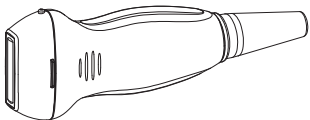
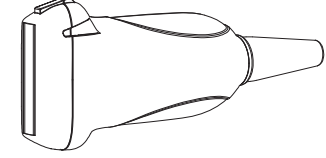
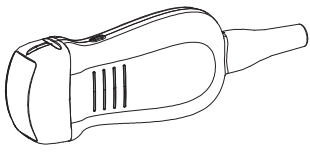
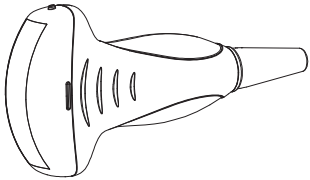
When recording or storing exams that have structured reports to external media (DICOMDIR), the structured reports can be backed up together.

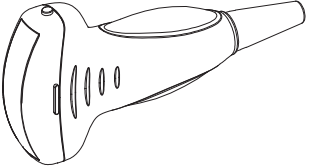
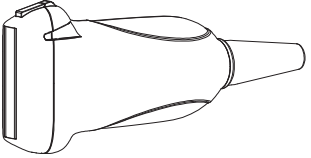

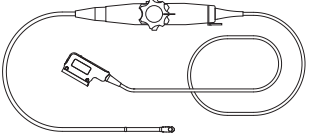
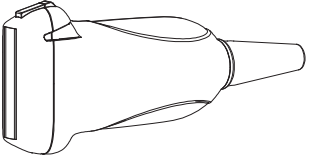
12 Probes and Biopsy

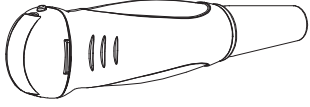
12.1 Probes

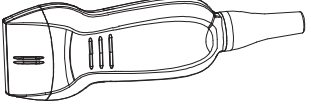
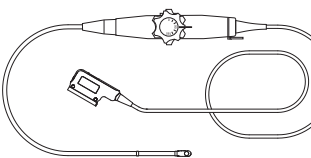
Probe model	Probe Type	Probe Figure
7L4s	Linear	
6CV1s	Convex	
7LT4s	Linear	
L14-6s	Linear	
L7-3s	Linear	
C4-1s	Convex	
C5-2s	Convex	

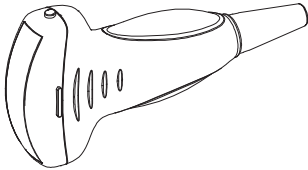
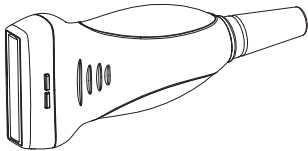
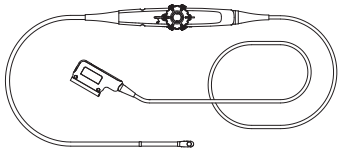
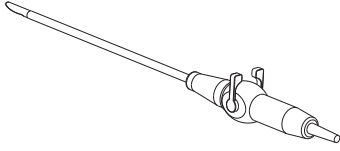
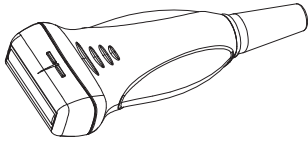
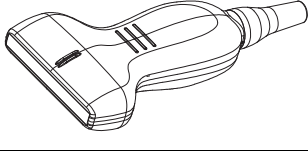
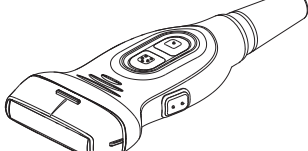
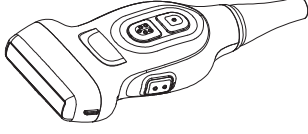
Probe model	Probe Type	Probe Figure
C5-1s	Convex	
L12-4s	Linear	
P10-4s	Phased	
P7-3Ts	Phased	
L14-6Ns	Linear	
V11-3Ws	Convex	
C11-3s	Convex	
SP5-1s	Phased	
P7-3s	Phased	
L20-5s	Linear	
P8-3Ts	Phased	

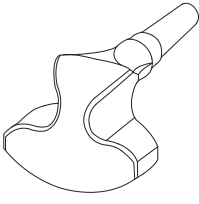
Probe model	Probe Type	Probe Figure
P4-2s	Phased	
SC6-1s	Convex	
L9-3s	Linear	
P8-2Ts	Phased	
LAP13-4Cs	Convex	
L11-3VNs	Linear	
L14-5Ws	Linear	
L12-3RCs	Linear	
L12-3VNs	Linear	

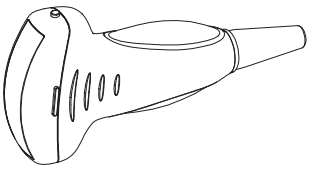
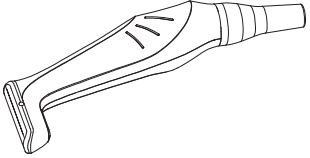
Probe model	Probe Type	Probe Figure
C9-3Ts	Convex	
SP5-1Ns	Phased	
SC5-1Ns	Convex	
L14-5sp	Linear	

TIP:

For details of TEE probe, see the relevant Operator’s Manual.

12.1.1 Probe Functions by Part

The basic structures and corresponding functions of probes are basically the same; take the following probe as an example.

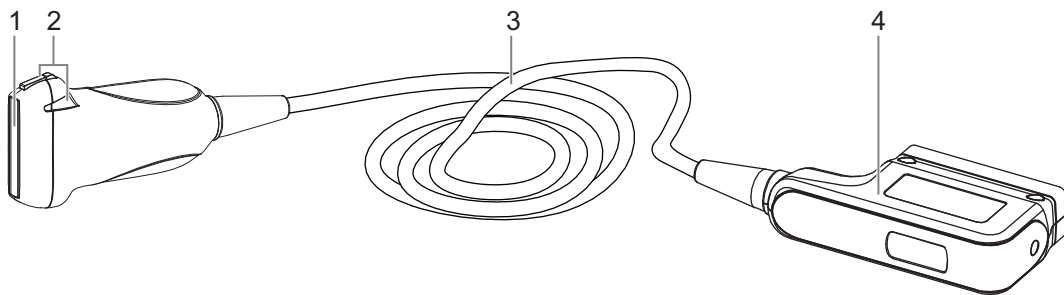

No.	Item	Description
1.	Probe head	Converts the electrical signal into an ultrasonic signal, focusing the sound beams in a given direction; meanwhile, it receives the reflected ultrasonic signal and converts it into an electrical signal for transmission over the cable. The lens on the surface is the acoustic lens. Apply ultrasound gel on the acoustic lens for correct operation.

No.	Item	Description
2.	Needle-guided bracket fix tabs and grooves	Provides mounting support of the needle-guided bracket. NOTE: This structure of probes in the figure above may vary with the matched needle-guided brackets.
3.	Probe cable	Transmits electrical signals between the probe body and connector.
4.	Probe connector	Connects the probe and cable to the ultrasonic diagnostic system.

12.1.2 Orientation of the Ultrasound Image and the Probe Head

The orientation of the ultrasound image and the probe are shown as below. The “M” side of the ultrasound image on the monitor corresponds to the mark side of the probe, for the laparoscopic probe, the probe orientation starting side is located on the end of the distal tip away from the handle. Check the orientation before the examination (Using a linear probe as an example).

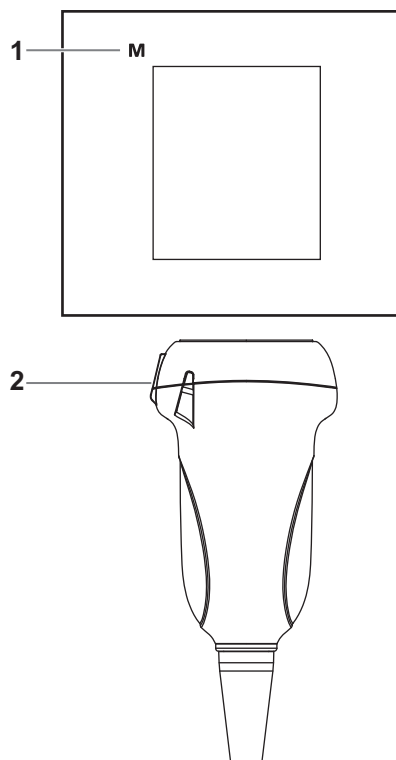

1	Orientation mark
2	Mark

12.1.3 Procedures for Operating

⚠ WARNING

Disinfect the probe and sterilize the needle-guided bracket before and after an ultrasound-guided biopsy procedure. Failure to do so may cause the probe and the needle-guided bracket becomes a source of infection.

This section describes general procedures for operating the probe. The proper clinical technique to be used for operating the probe should be selected on the basis of specialized training and clinical experience.

Procedures for operating (with biopsy function)

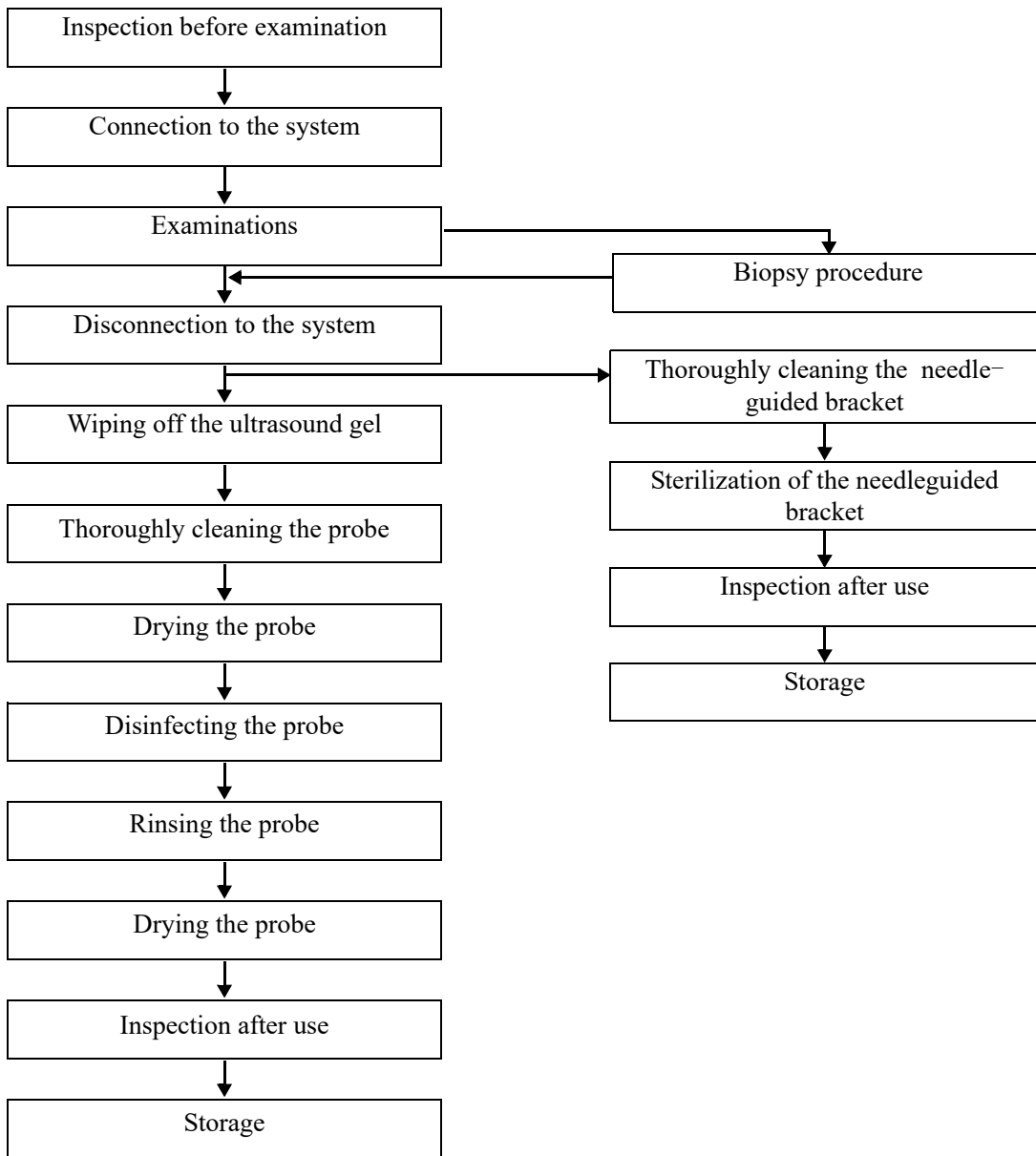

Procedures for operating (with no biopsy function)

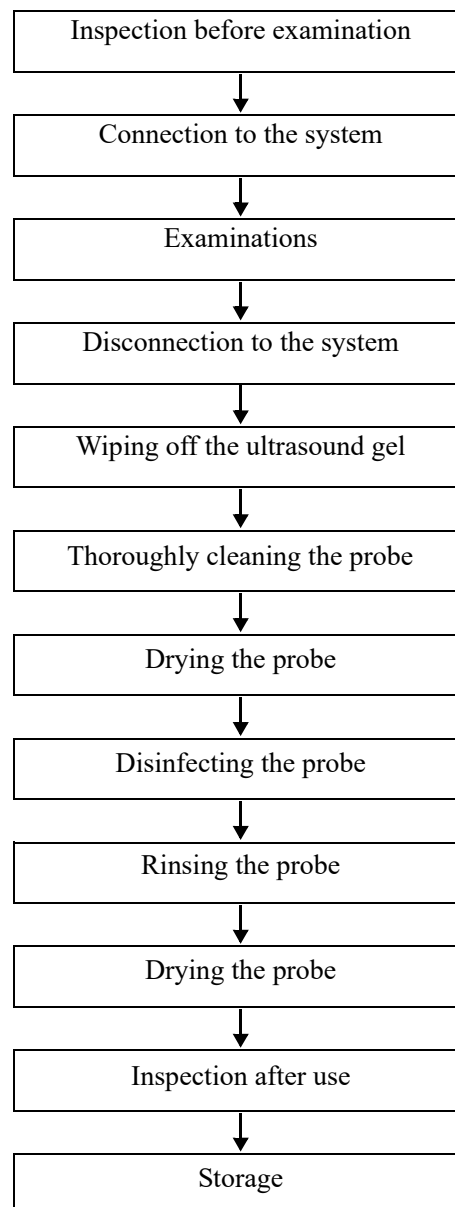

12.1.4 Wearing the Probe Sheath

CAUTION

- Be sure to cover the probe with a new (unused) probe sheath to prevent infection during examination. If the package of a probe sheath is open or broken, the sterilization of the probe sheath may not be sufficient. DO NOT use such a probe sheath.
- The cover contains natural rubber latex and talc that can cause allergic reactions in some individuals.
- DO NOT use an expired probe sheath. Before using a probe sheath, verify whether the term of validity has expired.

A legally marketed probe sheath must be installed over the probe before performing intra-cavitary and intra-operative examination. Protective barriers may be required to minimize disease transmission. Probe sheaths are available for use with all clinical situations where infection is a concern.

To order probe sheath, contact:

CIVCO Medical Instruments Co.

102 First Street South, Kalona, IA 52247-9589 USA

Tel: 1-319-656-4447

E-mail: info@civco.com

<http://www.civco.com>

Refer to the probe dimensions listed the Probe Dimensions chapter to choose the necessary probe sheath type.

Perform the following procedure to install the probe sheath:

1. Place an appropriate amount of gel inside the sheath or on the probe acoustic lens. Poor imaging may result if no gel is used.

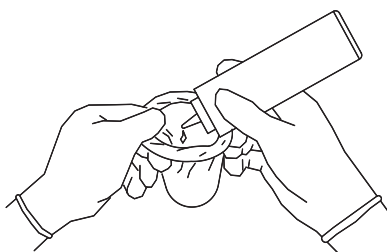

2. Insert the probe into the sheath; make sure to use proper sterile technique. Pull cover tightly over probe acoustic lens to remove wrinkles and air bubbles, and taking care to avoid puncturing the sheath.

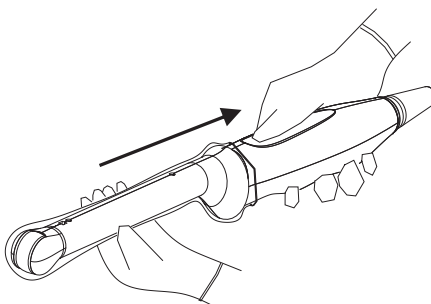

3. Secure the sheath with the enclosed elastic bands.

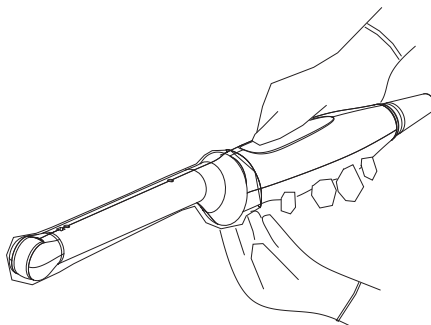

4. Inspect the sheath to ensure there is no hole or tear.

12.1.5 Probes Cleaning and Disinfection/Sterilization

Before and after completing each examination, clean and disinfect (or sterilize) the probes as required. When biopsy procedures have been performed, be sure to sterilize the needle-guided bracket. Fail to do so may result in the probe and the needle-guided bracket to becoming sources of infection. Please follow the instructions in the manual for cleaning.

WARNING

Never immerse the probe connector into liquid such as water or disinfectant. Immersion may cause electrical shock or malfunction.

CAUTION

- No cleaning and disinfecting may result in the probe becoming a source of infection.
 - Please follow the disinfectant manufacturer's manual for performing cleaning and disinfection, including preparing sterile water and cleaning and disinfection time.
-

NOTE:

- After the examination, wipe off the ultrasound gel thoroughly. Otherwise, the ultrasound gel may solidify and degrade the image quality of the probe.
 - DO NOT make the probe to become overheated (more than 55 °C) during cleaning and disinfections. High temperature may cause the probe to become deformed or damaged.
 - Observe the graph here carefully to immerse the probe. Only soak parts of the probe below the strain relief.
 - Repeated disinfection will eventually damage the probe, please check the probe performance periodically.
-

Cleaning and Disinfection/Sterilization Overview

Cleaning and disinfection refer to two distinct processes. According to the Centers for Disease Control and Prevention (CDC) "Guideline for Disinfection and Sterilization in Healthcare Facilities" (2008):

- Cleaning is the removal of visible soil (e.g. organic and inorganic material) from objects and surfaces and normally is accomplished manually or mechanically using water with detergents or enzymatic products. Thorough cleaning is essential before high-level disinfection and sterilization because inorganic and organic material that remains on the surfaces of instruments interfere with the effectiveness of these processes.
- Disinfection describes a process that eliminates many or all pathogenic microorganisms, except bacterial spores.
 - Low-Level Disinfection—Destruction of most bacteria, some viruses, and some fungi. Low-level disinfection will not necessarily inactivate *Mycobacterium tuberculosis* or bacterial spores.
 - High-Level Disinfection (HLD)—Destruction/removal of all microorganisms except bacterial spores.

- Sterilization describes a process that destroys or eliminates all forms of microbial life and is carried out in healthcare facilities by physical or chemical methods.

Selecting a Microbicidal Method

Probes can be divided into three categories based on their intended use. Some probes may fall into more than one category (e.g. probes use for biopsy procedures). When selecting a disinfectant, determine the required level of disinfection based on intended use and possibility of cross-contamination.

- **Contacts intact skin:** Probes that only come into contact with clean, intact skin are considered noncritical devices and require cleaning after every use. Cleaning may be followed by a low-level disinfectant spray or wipe.
- **Contacts mucous membranes and non-intact skin:** This category includes all endocavity probes - intravaginal, transrectal, and transesophageal (TEE) and probes use for biopsy procedures. These semi-critical probes must be cleaned with an appropriate cleaner after use followed by high-level disinfection.
- **Contacts otherwise sterile tissue or body-space:** These probes are considered critical and include all intraoperative probes. These probes must be cleaned with an appropriate cleaner after each use, followed by a sterilization process.

Cleaning

Please refer to the instructions in the manual and follow your hospital policy and procedures for cleaning.

Perform the following procedure:

1. Wear a pair of gloves to prevent infection.
2. Disconnect the probe from the system. If the sheath is used, take off the sheath and discard it.
3. Wipe off the ultrasound gel or other visible dirt on the surface of the probe by using a damp piece of disposable lint-free soft cloth or tissue.
4. Choose an appropriate cleaning agent including mild detergents, enzymatic cleaners and specially designed enzymatic sponges.
5. Immerse the probe fully in the cleaning fluid for at least 1 minute or according to manufacturer's instructions. Lightly mechanical clean the probe with a piece of lint-free soft cloth or soft sponge until no dirt is visible. When necessary, clean the seams or biopsy guide features by using disposable cotton swabs. Avoid using a brush to wash the lens because it may damage the probe.
6. Rinse the probe thoroughly by using a large amount of clean water (about 7.5 L/2 gallons) at room temperature for about 30 s to remove the residual dirt and cleaning solvent. Repeat the rinsing operation twice.
7. Dry the probe by wiping with a piece of disposable lint-free soft cloth or tissue.
Do not dry the probe by heating.
8. Inspect the probe. If visible dirt still exists, repeat the preceding steps to wash the probe until it is all clean.
9. Check whether the probe has defects such as peeling, rifts, bumps, cracks, or liquid spill. If such defects exist, the probe has reached the end of its service life. In this case, stop using it and contact the Mindray service department.

Low-level disinfection of a non-critical probe

CAUTION

Use protective eyewear when disinfecting using sprays.

Perform the following procedure:

1. Wear a pair of gloves to prevent infection.
2. Clean the probe thoroughly in accordance with the cleaning procedure before disinfection.
3. Disinfect the probe by using an appropriate low-level disinfectant. Follow the disinfection agent manufacturer's instructions for preparation and use of the disinfectant.
 - Wipes: Wipe all the surface of the probe according to the wiping duration specified in the operator's manual provided by the manufacturer.
 - Spray: Spray the disinfectant directly on the surface of the probe or spray the disinfectant on a piece of disposable lint-free soft cloth and wipe the probe according to the wiping duration in the operator's manual provided by the manufacturer.

Observe the graph here carefully to perform disinfection. Do not spray the strain relief on the connector end or the connector.

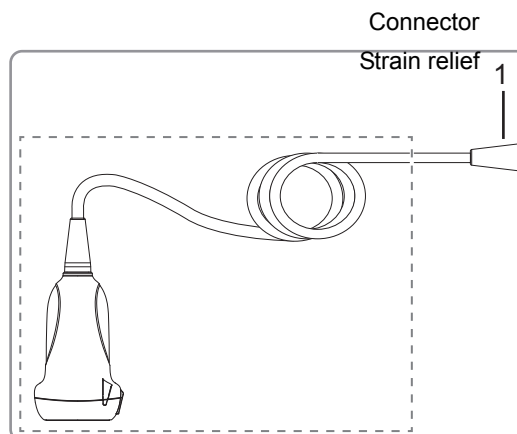

4. Wipe away the residual disinfectant on the probe by using a piece of lint-free soft cloth soaked with clean water. Wipe three times. Or rinse the probe thoroughly by using a large amount of clean water (about 7.5 L/2 gallons) at room temperature.
5. Dry the probe by wiping with a piece of disposable lint-free soft cloth. Do not dry the probe by heating.
6. Check whether the probe has defects such as peeling, rifts, bumps, cracks, or liquid spill. If such defects exist, the probe has reached the end of its service life. In this case, stop using it and contact the Mindray service department.
7. Store the probe in a cool, clean and dry environment. And repeat the cleaning and disinfection process before the next use.

High-level disinfection of a semi-critical probe

Perform the following procedure:

1. Wear a pair of gloves to prevent infection.
2. Clean the probe thoroughly in accordance with the cleaning procedure before disinfection.

3. Disinfect the probe by using an appropriate high-level disinfectant or system. For how to use a high-level disinfectant or system, see the operator's manual provided by the manufacturer. Prepare a disinfectant by using sterile distilled or softened water when necessary.

- Soaking: Immerse the probe head in the disinfectant and shake the probe appropriately to remove any bubbles on the probe surface. For details about the probe immersion duration, see the operator's manual provided by the manufacturer.

Observe the graph here carefully to immerse the probe. Only soak parts of the probe below the strain relief.

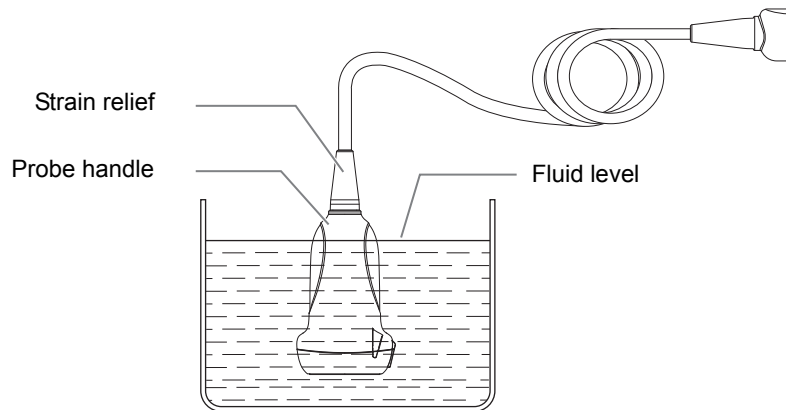

- Wiping: Use a market disinfection wipe product or sterile disposable lint-free soft cloth wetted with disinfection spray and wipe all surfaces of the probe for a duration according to the manufacturer instructions.
4. Rinse the probe thoroughly by using a large amount of clean water (about 7.5 L/2 gallons) at room temperature for about 30 s to remove the residual disinfectant. Repeat the operation twice. Or follow the disinfectant manufacturer's instructions regarding rinsing.
 5. Dry the probe by wiping with a piece of clean disposable lint-free soft cloth. Do not dry the probe by heating.
 6. Check whether the probe has defects such as peeling, rifts, bumps, cracks, or liquid spill. If such defects exist, the probe has reached the end of its service life. In this case, stop using it and contact the Mindray service department.
 7. Store the probe in a cool, clean and dry environment. And repeat the cleaning and disinfection process before the next use.

Sterilization of a critical probe

⚠ CAUTION

Repeated sterilization will eventually damage the probe, please check the probe's performance periodically.

For intra-operative probes, they have to be thoroughly cleaned and sterilized after completing each examination.

Perform the following procedure:

1. Wear a pair of gloves to prevent infection.
2. Clean the probe thoroughly in accordance with the cleaning procedure before sterilization.
3. Sterilize the probe by using an appropriate sterilant or system.

For how to use a system, see the operator's manual provided by the manufacturer.

When using a sterilant, follow the following steps:

- a. Prepare a sterilant by using sterile distilled or softened water when necessary.
- b. Immerse the probe head in the sterilant and shake the probe appropriately to remove any bubbles on the probe surface.

For details about the probe immersion duration, see the operator's manual provided by the manufacturer.

Figure 12-1 Immerse the intra-operative probe in the solution (for reference)

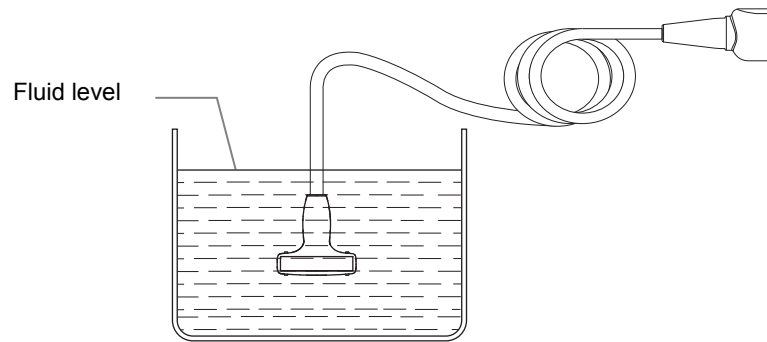

- c. Rinse the probe thoroughly by using a large amount of sterile distilled or softened water (about 2 gallons) at room temperature for about 30 s to remove the residual sterilant. Repeat the operation twice. Or follow the sterilant manufacturer's instructions regarding rinsing.
 - d. Dry the probe by wiping with a piece of sterile disposable lint-free soft cloth. Do not dry the probe by heating.
4. Check whether the probe has defects such as peeling, rifts, bumps, cracks, or liquid spill. If such defects exist, the probe has reached the end of its service life. In this case, stop using it and contact the Mindray service department.
 5. Store the probe in a cool, clean and dry environment. And repeat the cleaning and sterilization process before the next use.

Compatible Cleaner, Disinfectants/Sterilants

For the cleaner, disinfectants and sterilants information, please refer to Mindray Transducer Disinfectant Recommendation.

12.1.6 Probe Environmental Conditions

Table 12-2 Probe Environmental Conditions

Probe Model	Conditions	Ambient temperature	Relative humidity (no condensation)	Atmospheric pressure
C4-1s	Operating	0°C ~ 35°C	15% ~ 90%	700 hPa ~ 1060 hPa
	Storage and transportation	-20°C ~ 60°C	15% ~ 90%	700 hPa ~ 1060 hPa
C5-1s	Operating	0°C ~ 40°C	30% ~ 85%	700 hPa ~ 1060 hPa
	Storage and transportation	-20°C ~ 55°C	30% ~ 95%	700 hPa ~ 1060 hPa

Table 12-2 Probe Environmental Conditions

Probe Model	Conditions	Ambient temperature	Relative humidity (no condensation)	Atmospheric pressure
C5-2s	Operating	0°C ~ 40°C	30% ~ 85%	700 hPa ~ 1060 hPa
	Storage and transportation	-20°C ~ 55°C	30% ~ 95%	700 hPa ~ 1060 hPa
C11-3s	Operating	0°C ~ 40°C	30% ~ 85%	700 hPa ~ 1060 hPa
	Storage and transportation	-20°C ~ 55°C	30% ~ 95%	700 hPa ~ 1060 hPa
SC5-1Ns	Operating	0°C ~ 40°C	20% ~ 85%	700 hPa ~ 1060 hPa
	Storage and transportation	-20°C ~ 55°C	20% ~ 95%	700 hPa ~ 1060 hPa
L9-3s	Operating	0°C ~ 40°C	20% ~ 85%	700 hPa ~ 1060 hPa
	Storage and transportation	-20°C ~ 55°C	20% ~ 95%	700 hPa ~ 1060 hPa
L11-3VNs	Operating	0°C ~ 40°C	20% ~ 85%	700 hPa ~ 1060 hPa
	Storage and transportation	-20°C ~ 55°C	20% ~ 95%	700 hPa ~ 1060 hPa
L12-3VNs	Operating	0°C ~ 40°C	20% ~ 85%	700 hPa ~ 1060 hPa
	Storage and transportation	-20°C ~ 55°C	20% ~ 95%	700 hPa ~ 1060 hPa
L12-3RCs	Operating	0°C ~ 40°C	20% ~ 85%	700 hPa ~ 1060 hPa
	Storage and transportation	-20°C ~ 55°C	20% ~ 95%	700 hPa ~ 1060 hPa
L14-6Ns	Operating	0°C ~ 40°C	30% ~ 85%	700 hPa ~ 1060 hPa
	Storage and transportation	-20°C ~ 55°C	30% ~ 95%	700 hPa ~ 1060 hPa
L20-5s	Operating	0°C ~ 35°C	15% ~ 80%	700 hPa ~ 1060 hPa
	Storage and transportation	-20°C ~ 60°C	15% ~ 90%	500 hPa ~ 1060 hPa
7LT4s	Operating	0°C ~ 40°C	25% ~ 90%	550 hPa ~ 1060 hPa
	Storage and transportation	-20°C ~ 60°C	10% ~ 95%	500 hPa ~ 1060 hPa
P4-2s	Operating	0°C ~ 40°C	30% ~ 85%	700 hPa ~ 1060 hPa
	Storage and transportation	-20°C ~ 55°C	30% ~ 95%	700 hPa ~ 1060 hPa
P10-4s	Operating	0°C ~ 40°C	30% ~ 85%	700 hPa ~ 1060 hPa
	Storage and transportation	-20°C ~ 55°C	30% ~ 95%	700 hPa ~ 1060 hPa
SP5-1Ns	Operating	0°C ~ 40°C	20% ~ 85%	700 hPa ~ 1060 hPa
	Storage and transportation	-20°C ~ 55°C	20% ~ 95%	700 hPa ~ 1060 hPa

Table 12-2 Probe Environmental Conditions

Probe Model	Conditions	Ambient temperature	Relative humidity (no condensation)	Atmospheric pressure
L12-4s	Operating	0°C ~ 40°C	30% ~ 85%	700 hPa ~ 1060 hPa
	Storage and transportation	-20°C ~ 55°C	30% ~ 95%	700 hPa ~ 1060 hPa
V11-3Ws	Operating	0°C ~ 40°C	30% ~ 85%	700 hPa ~ 1060 hPa
	Storage and transportation	-20°C ~ 55°C	30% ~ 95%	700 hPa ~ 1060 hPa
SP5-1s	Operating	0°C ~ 40°C	20% ~ 85%	700 hPa ~ 1060 hPa
	Storage and transportation	-20°C ~ 55°C	20% ~ 95%	700 hPa ~ 1060 hPa
P7-3s	Operating	10°C ~ 40°C	30% ~ 85%	700 hPa ~ 1060 hPa
	Storage and transportation	-20°C ~ 55°C	30% ~ 95%	700 hPa ~ 1060 hPa
SC6-1s	Operating	0°C ~ 40°C	20% ~ 85%	700 hPa ~ 1060 hPa
	Storage and transportation	-20°C ~ 55°C	20% ~ 95%	700 hPa ~ 1060 hPa
LAP13-4Cs	Operating	0°C ~ 40°C	20% ~ 85%	700 hPa ~ 1060 hPa
	Storage and transportation	-20°C ~ 55°C	20% ~ 95%	700 hPa ~ 1060 hPa
L14-5sp	Operating	10°C ~ 40°C	30% ~ 85%	700 hPa ~ 1060 hPa
	Storage and transportation	0°C ~ 60°C	30% ~ 95%	700 hPa ~ 1060 hPa
L7-3s	Operating	0°C~40°C	30%~85%	700 hPa ~ 1060 hPa
	Storage and transportation	-20°C~55°C	30%~95%	700 hPa ~ 1060 hPa
L14-6s	Operating	0°C~40°C	30%~85%	700 hPa ~ 1060 hPa
	Storage and transportation	-20°C~55°C	30%~95%	700 hPa ~ 1060 hPa
6CV1s	Operating	0°C~40°C	25%~90%	550 hPa ~ 1060 hPa
	Storage and transportation	-20°C~55°C	10%~95%	500 hPa ~ 1060 hPa
7L4s	Operating	0°C~40°C	30%~85%	700 hPa ~ 1060 hPa
	Storage and transportation	-20°C~55°C	30%~95%	700 hPa ~ 1060 hPa
L14-5Ws	Operating	0°C~40°C	20%~85%	700 hPa ~ 1060 hPa
	Storage and transportation	-20°C~55°C	20%~95%	700 hPa ~ 1060 hPa
C9-3Ts	Operating	0°C~40°C	20%~85%	700 hPa ~ 1060 hPa
	Storage and transportation	-20°C~55°C	20%~95%	700 hPa ~ 1060 hPa

12.1.7 Storage and Transportation

When all examinations for the day have been completed, confirm that the probe is in good condition. After disinfecting the probe, confirm that the probe is in good condition and stored in a suitable place

- To prevent the probe from being damaged, DO NOT store it in locations where it may be exposed to:
 - Direct sunlight or X-rays
 - Sudden changes in temperature
 - Dust
 - Excessive vibration
 - Heat generators
- When the probe is sent to MINDRAY Customer Service Department or sales representative for repair, be sure to disinfect it and keep it in the carrying case to prevent infection.

12.2 Biopsy Guide

WARNING

- The person performing biopsy procedures must understand diagnostic ultrasound thoroughly and have been trained adequately, otherwise, side effects may be caused to the patient.
- In situations listed below, the biopsy needle may fail to penetrate the target. The incorrect biopsy may cause various side effects in the patient.
 - Use a needle-guided bracket other than that provided.
 - Mount the needle-guided bracket incorrectly.
 - Use a biopsy needle that is unsuitable for the type of biopsy being performed.
 - Use a biopsy needle that is unsuitable for the needle guide.
- Before and after a biopsy procedure is performed, confirm that the needle-guided bracket is normal. Manually confirm that the parts of the needle-guided bracket do not slip off or move from their proper positions. If the needle-guided bracket is used when parts are not securely and correctly installed, the patient may be injured. If an abnormality is found on the needle-guided bracket, immediately stop using it and contact MINDRAY Customer Service Department or sales representative.
- Needle guided brackets are required to be verified before each biopsy. If the verification fails, it indicates that the needle-guided brackets are out of service life.
- Disposable brackets are packaged sterile and are single-use only, and the method of sterilization is irradiation. Do not use if the sterile packaging is open or broken, and do not reuse or resterilize the disposable brackets.
- DO NOT use a needle-guided bracket when scanning is performed. The needle may advance in an incorrect direction and possibly injure the patient.

Never perform a biopsy during image scanning.

- DO NOT freeze an image while performing biopsy procedure.
- During biopsy procedures, the needle may deviate from the desired course due to the tissue characteristics or the type of needle. In particular, needles of small diameters may deviate to a greater degree.
- Disinfect the probe and sterilize needle-guided bracket before and after each ultrasound-guided biopsy procedure is performed. Failure to do so may cause the probe and the needle-guided bracket to become sources of infection.
- The needle mark displayed on the ultrasound image does not indicate the actual position of the biopsy needle. Therefore, it should only be used as a reference. Always monitor the relative positions of the biopsy needle during the procedures.
- Adjust the needle mark before the biopsy procedure is performed.
- When performing biopsy procedures, use only sterile ultrasound gel that is certified to be safe. And manage the ultrasound gel properly to ensure that it does not become a source of infection.
- When performing the operation concerning biopsy, wear sterile gloves.
- Image of the biopsy target and the actual position of the biopsy needle:
Diagnostic ultrasound systems produce tomographic plane images with information of a certain thickness in the thickness direction of the probe. (That is to say, the information shown in the images consists of all the information scanned in the thickness direction of the probe.) So, even though the biopsy needle appears to have penetrated the target object in the image, it may not actually have done so. When the target for biopsy is small, dispersion of the ultrasound beam may lead to image deviation from the actual position. Pay attention to this.

If the target object and the biopsy needle appear in the image as shown in the figures below (For reference only):

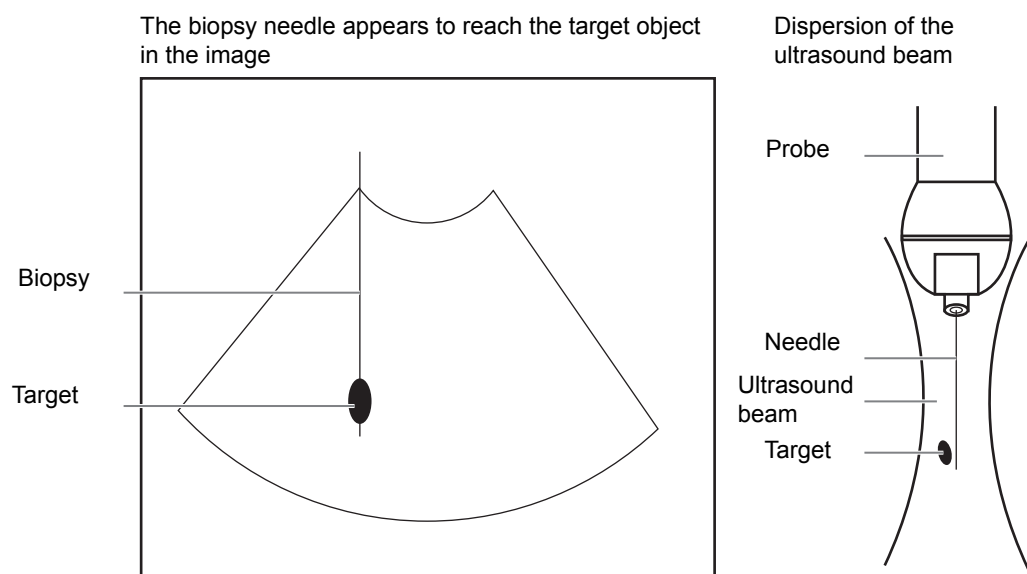

The biopsy needle may not have actually entered the target object even though it appears to have done so in the image. To avoid this, note the points below:

- Do not rely only on the needle tip in the image. Pay careful attention to the fact that when the biopsy needle enters the target object or comes into contact with it, the object should shift slightly.
- Before performing the biopsy, evaluate the size of the object and confirm whether the biopsy can be carried out.

12.2.1 Needle-guided Brackets Available

Table 12-3 Needle-guided Brackets Available

Probe model	Needle-guided Bracket Model	Biopsy angle/ depth ($\pm 1^\circ$)	Applicable Biopsy Needle
V11-3Ws/ 6CV1s	NGB-004 metal/needle non-detachable	/	16G, 17G, 18G
L12-4s/ L7-3s/L14-6Ns/7L4s	NGB-007 plastic/needle detachable metal/needle detachable	40°, 50°, 60°	Metal: 14G, 16G, 18G, 20G, 22G Plastic: 13G, 15G, 16G, 18G, 20G
7LT4s	NGB-010 metal-needle detachable	30°, 40°, 50°	13G, 15G, 16G, 18G, 20G
P4-2s/SP5-1s/SP5-1Ns	NGB-011 metal/needle undetachable	11°, 23°	13G, 15G, 16G, 18G, 20G
C5-2s	NGB-015 Metal-needle detachable	25°, 35°, 45°	14G, 16G, 18G, 20G, 22G
L14-6s	NGB-016 metal/needle detachable	30°, 40°, 50°	14G, 16G, 18G, 20G, 22G
C11-3s	NGB-018 metal/needle detachable	15°, 25°, 35°	14G, 16G, 18G, 20G, 22G
SC6-1s/C5-1s/SC5-1Ns	NGB-022 metal/needle detachable	25°, 35°, 45°	14G, 16G, 18G, 20G, 22G
L9-3s	NGB-034 metal/needle detachable	40°, 50°, 60	14G, 16G, 18G, 20G, 22G
L14-5Ws	NGB-035 Metal-needle detachable	47°, 53°, 59°, 65°	14G, 16G, 18G, 20G, 22G
C4-1s	NGB-036 metal-needle detachable	7°, 25°, 35°	14G, 16G, 18G, 20G, 22G
L12-3RCs	NGB-043 metal-needle detachable	Angle range: 35° ~ 80°	20G, 21G, 22G, 23G

Table 12-3 Needle-guided Brackets Available

Probe model	Needle-guided Bracket Model	Biopsy angle/ depth ($\pm 1^\circ$)	Applicable Biopsy Needle
L12-3RCs	NGB-044 metal-needle detachable	Biopsy depth: 5mm, 10mm, 15mm, 25mm, 35mm	18G, 20G, 21G

Disposable Bracket

Probe model	Needle-guided Bracket Model
L14-6Ns, L12-4s	CIVCO 658-001
C5-2s	CIVCO 658-002
L14-5sp	CIVCO 698-006
C4-1s	CIVCO 698-019
	CIVCO 698-013
V11-3Ws	CIVCO 610-543
	CIVCO 610-1274
L14-5Ws	CIVCO 698-007
	CIVCO 698-012

NOTE:

Mindray does not offer the biopsy needle; please purchase it according to your own needs.

12.2.2 Needle-Guided Bracket Inspection and Installation

A needle-guided bracket is available for purchase as an optional accessory; it is used in combination with the probe. Some of the probes have matched needle-guided bracket and needles. To order needle-guided brackets, contact MINDRAY Customer Service Department or sales representative.

For biopsy or treatment, ultrasound-guided biopsy procedures can be performed using the probe in combination with a needle-guided bracket (optional accessory) and a biopsy needle (provided by the user).

Be sure to perform inspections before and after use of the needle-guided bracket. If an abnormality is found on the needle-guided bracket, immediately stop using it and contact MINDRAY Customer Service Department or sales representative.

- Sterilize the needle-guided bracket before and after use.
- Put on the sterile probe sheath before installing to the probe.
- Confirm that the needle-guided bracket is free of damage, deformation, stripping, malfunction, loose, or missing parts.
- Confirm that the needle-guided bracket is securely mounted in the correct position.
- Select the proper needle according to the specification above, and adjust the needle shift to the same specification of the selected needle.

NGB-004 Metal-needle undetachable needle-guided bracket

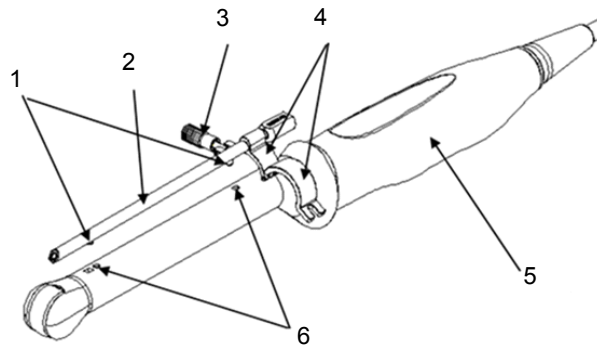

1	Locating bulge
2	Needle guide
3	Locking nut
4	Retaining clamp
5	Probe
6	Locating groove

Perform the following procedure:

1. Install the needle-guided bracket:
 - a. Put on the sterile probe sheath.

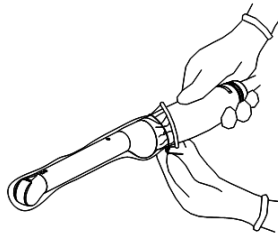

- b. Open the retaining clamp, align the needle-guided bracket with the probe to align the locating bulge on the needle guide with the locating grooves on the probe, then turn the retaining clamp to align it with the probe.

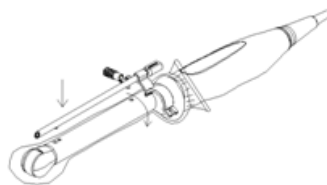

- c. When the retaining clamp is turned to the correct position, the locking nut will lock the retaining clamp and the needle-guided bracket is then mounted in the correct position.

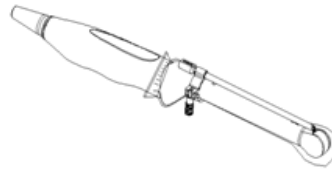

2. Remove the needle-guided bracket:

Hold the probe in your left hand. Unscrew the locking nut with your right hand to open the retaining clamp, then raise the needle-guided bracket to separate the locating bulge from the locating grooves.

NGB-007 Metal/needle detachable needle-guided bracket

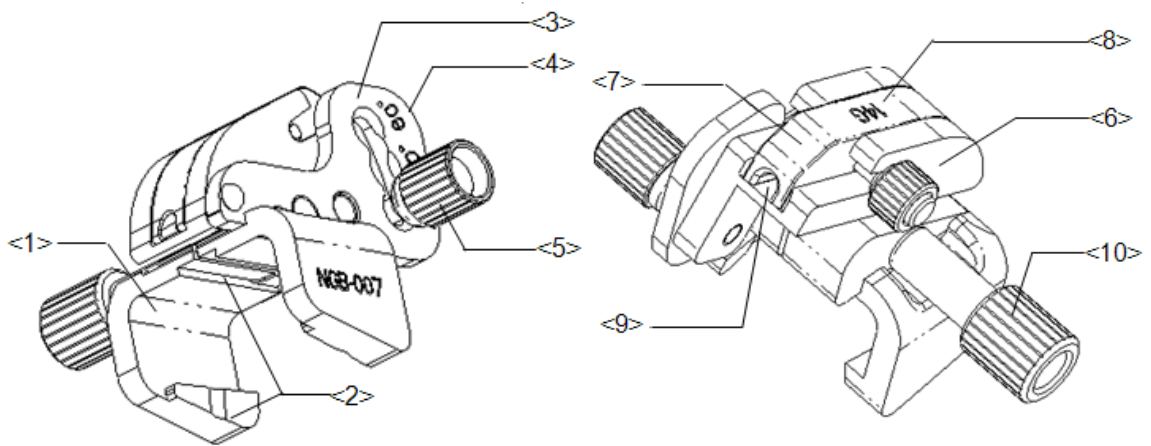

1	Support for needle-guided bracket
2	Tab and groove for the needle-guided bracket
3	Angle-adjusting base
4	Angle shift sign
5	Angle pinch nut
6	Angle block
7	Guiding block
8	Guiding block specification
9	Needle guide hole
10	Needle-guided bracket pinch nut

Perform the following procedure:

1. Install the needle-guided bracket:
 - a. Put on the sterile probe sheath.
 - b. Hold the probe in one hand, select the correct needle-guided bracket and hold it with the other hand. Match the groove and tab with the tab and groove of the probe respectively. Mount the bracket onto the probe.

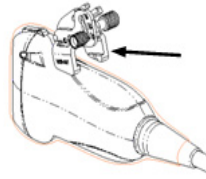

- c. Screw the pinch nut of the needle-guided bracket to ensure that the needle-guided bracket is properly installed on the probe.

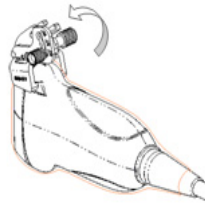

- 2. Adjust the needle angle to the proper shift as required:
 - a. Loosen the angle pinch nut.
 - b. Adjust the angle block to the desired level.
 - c. Tighten the angle pinch nut.
- 3. Install the guiding block
 - a. Select a suitable guiding block and push it into the groove above the angle block, then clamp it tightly

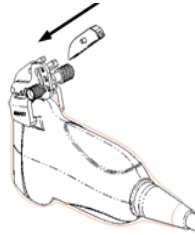

- b. Screw the block's nut to secure the block.

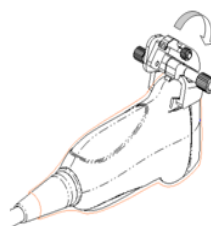

- c. Insert a biopsy needle with the same specification as that of the guiding block into the guiding block hole.

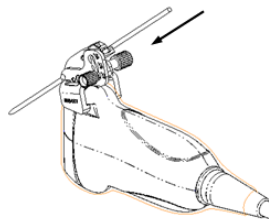

- 4. Release the needle from the bracket:

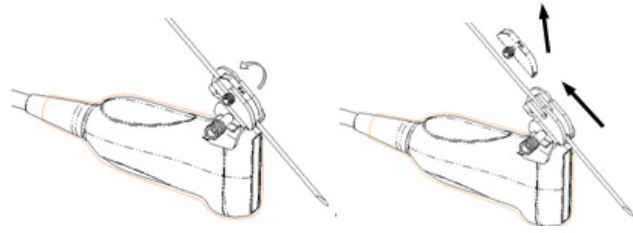

- a. Screw the nut of the guiding block and remove the guiding block slightly along the direction of the needle's tail.
 - b. Separate the residual part of the needle-guide bracket and the probe from the needle.
5. Remove the needle-guided bracket:

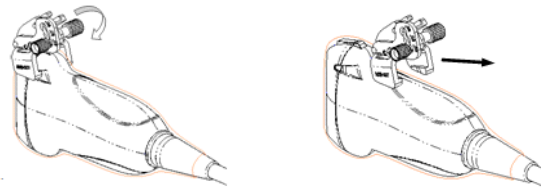

- a. Unscrew the Needle-guided bracket pinch nut, and remove the needle-guided bracket from the probe.
- b. Separate the probe and the needle-guided bracket.

NGB-007 Plastic/needle detachable needle-guided bracket

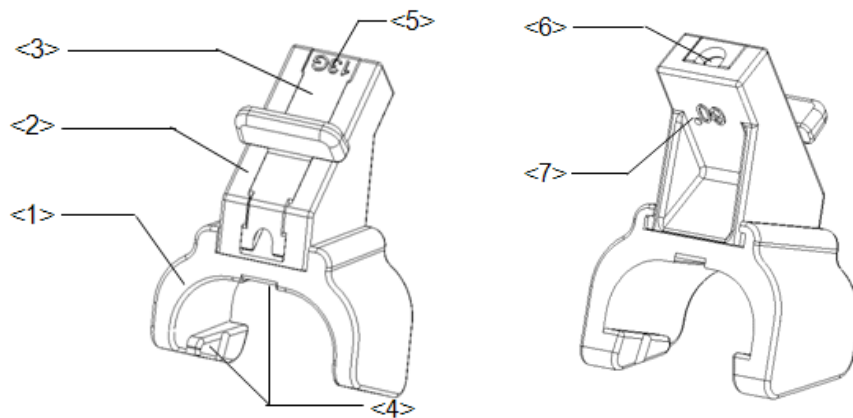

1	Support of needle-guided bracket
2	Angle block
3	Guiding block
4	Groove and tab of the needle-guided bracket
5	Specification of guiding block
6	Guiding hole of the biopsy needle
7	Specification of angle block

Perform the following procedure:

1. Install the needle-guided bracket:
 - a. Put on the sterile probe sheath.
 - b. Hold the probe by one hand, select the proper needle-guided bracket, and hold it with the other hand. Align the narrow end tab of the needle-guided bracket with the groove of the probe, then push the needle-guided bracket forward, making the tabs and the grooves of the needle-guided bracket to match with the grooves and tabs of the probe.

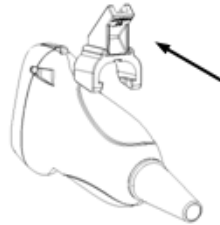

- c. Check manually to confirm that the needle-guided bracket is securely installed on the probe.
2. Install the guiding block:
 - a. Select a proper guiding block and push it into the groove above the angle block, and clamp it tightly.

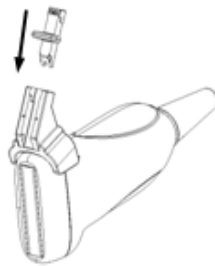

- b. Insert a biopsy needle with the same specification as that of the guiding block into the hole of the guiding block.

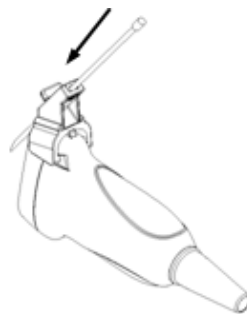

3. Release the needle from the bracket:

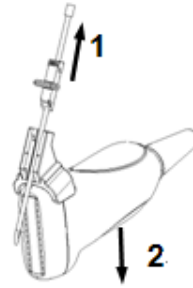

- a. Remove the guiding block slightly along the direction of the needle's tail.
 - b. Separate the residual part of the needle-guide bracket and the probe from the needle.
4. Remove the needle-guided bracket:



Remove the support of needle-guided bracket from the probe.

NGB-010 Metal-needle detachable needle-guided bracket

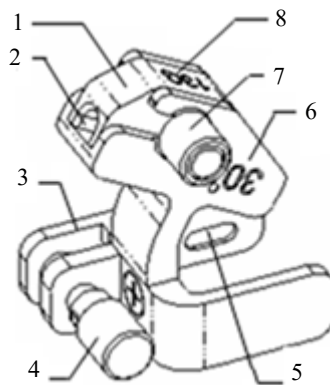

1	Guiding block
2	Guiding hole of the biopsy needle
3	Support of needle-guided bracket
4	Knob of fixing needle-guided bracket
5	Grooves of the needle-guided bracket
6	Needle guide angle
7	Knob of fixing the guiding block
8	Specification of guiding block

Perform the following procedure:

1. Install the needle-guided bracket:
 - a. Put on the sterile probe sheath.



- b. Hold the probe by one hand, select the proper needle-guided bracket, and hold it with the other hand. Match the groove of the bracket with the tab of the probe. Amount the bracket onto the probe.
 - c. Hold the probe by one hand, select proper needle-guided bracket, and hold it with the other hand, and align the grooves of the needle-guided bracket with the tabs of the probe, then push the needle-guided bracket forward, making the grooves of the needle-guided bracket to match with the tabs of the probe. Set the needle-guided bracket at the desired position, turn tightly the knob of fixing needle-guided bracket to fix the needle-guided bracket.

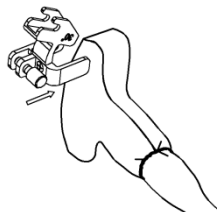

- d. Check manually to confirm the needle-guided bracket is securely installed on the probe.
 2. Install the guiding block:
 - a. Select a proper guiding block and push it into the groove above the support of needle-guided bracket, then turn tightly the knob of fixing the guiding block to fix the guiding block on the support of needle-guided bracket.



- b. Insert a biopsy needle with the same specification as that of the guiding block into the hole of the guiding block

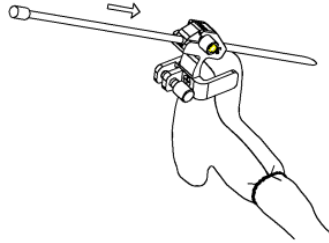

3. Remove the needle-guided bracket:

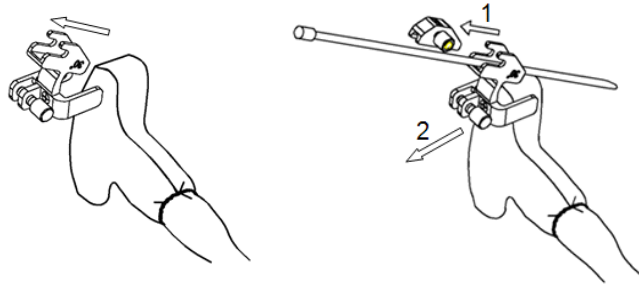

- a. Remove the guiding block slightly along the direction of the needle's tail, and separate the residual part of the needle-guide bracket and the probe from the needle.
- b. Remove the support of needle-guided bracket from the probe.

NGB-011 Metal-needle undetachable needle-guided bracket

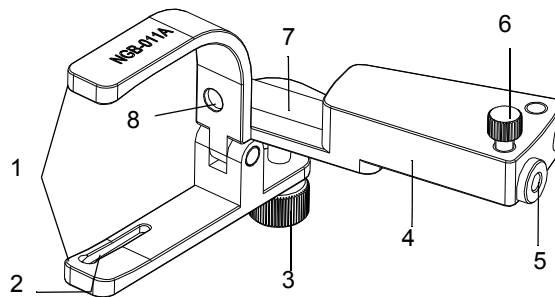

1	Clamp
2	Locating groove
3	Grip knob
4	Needle guide rack
5	Needle guide hole
6	Needle guide clamping knob
7	Needle guide
8	Locating pit

Perform the following procedure:

1. Install the needle-guided bracket:
 - a. Put on the sterile probe sheath.

- b. Connect the locating groove on the clamp with the two raised edges on the probe head and align the locating pit of the clamp with the convex point on the probe head.
 - c. Turn the grip knob at the tail of the needle-guided bracket tightly.
2. Remove the needle-guided bracket:

Hold the probe and the needle-guided bracket, then open the grip knob of the needle-guided bracket.

NGB-015 Metal-needle detachable needle-guided bracket

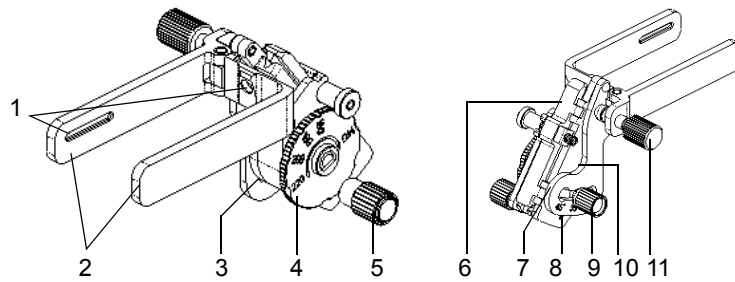

1	Groove
2	Clamp
3	Needle type adjusting base
4	Needle type dial scale
5	Needle fixing nut
6	V-shaped cover
7	Angle adjusting base
8	Angle shift sign
9	Angle pinch nut
10	Angle block
11	Pinch nut

Perform the following procedure:

1. Install the needle-guided bracket:
 - a. Put on the sterile probe sheath.
 - b. Hold the probe by one hand, select the proper needle-guided bracket, and hold it with the other hand. Match the groove of the bracket with the tab of the probe. Amount the bracket onto the probe.

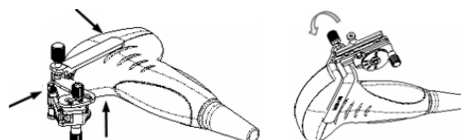

- c. Screw the pinch nut of the needle-guided bracket to confirm that the needle-guided bracket is properly installed on the probe.
2. Adjust the needle angle to the proper shift as required:

- a. Loosen the angle pinch nut.
 - b. Adjust the angle block to the desired level.
 - c. Tighten the angle pinch nut.
3. Insert the biopsy needle:

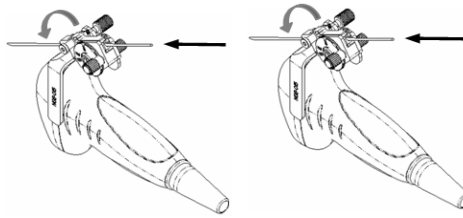

- a. Adjust the dial scale to the required needle type shift, and then screw the needle fixing nut to lock the dial scale. (To adjust the dial scale you have to loosen the needle fixing nut first.)
 - b. Pull the lock pin and close the V-shaped cover to fix the lock pin in the groove of the needle type adjusting base, so as to install the needle into the guiding hole.
4. Release the needle from the bracket:

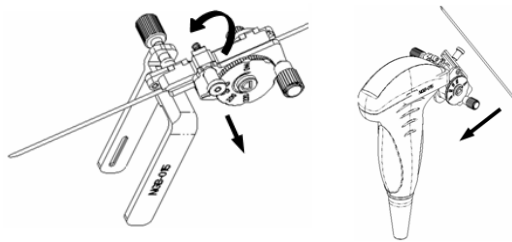

- a. Pull the lock pin and open up the V-shaped cover to expose the needle.
 - b. Separate the bracket and the probe from the needle.
5. Remove the needle-guided bracket:

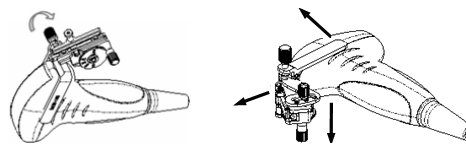

- a. Screw the pinch nut to release the needle-guided bracket.
- b. Separate the bracket and the probe.

NGB-016 Metal-needle detachable needle-guided bracket

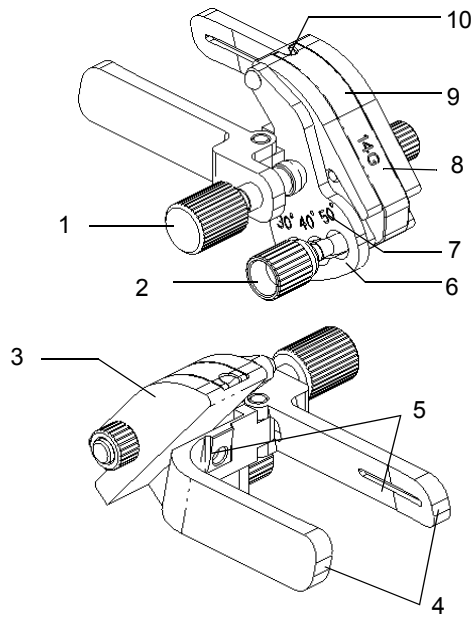

1	Pinch nut of bracket
2	Angle pinch nut
3	Angle block
4	Clamp
5	Groove
6	Angle-adjusting base
7	Angle shift sign
8	Guiding block specification
9	Guiding block
10	Needle guide hole

Perform the following procedure:

1. Install the needle-guided bracket:

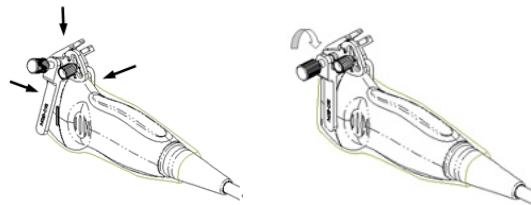

- a. Put on the sterile probe sheath.
 - b. Select a suitable needle-guided bracket and match the groove to the tab of the probe. Mount the bracket onto the probe.
 - c. Screw the pinch nut of the needle-guided bracket to ensure that the needle-guided bracket is properly installed on the probe.
2. Adjust the needle angle to the proper shift as required:

- a. Loosen the angle pinch nut.
 - b. Adjust the angle block to the desired level.
 - c. Tighten the angle pinch nut.
3. Install the guiding block:

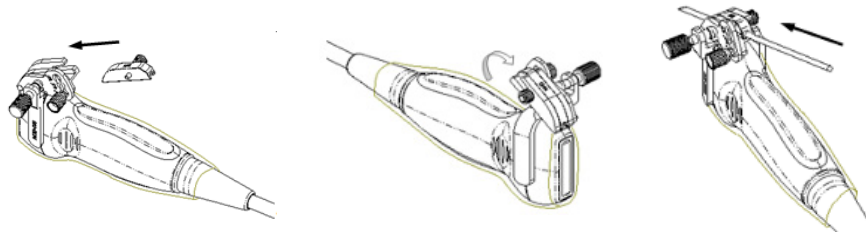

- a. Select a suitable guiding block and push it into the groove above the angle block
 - b. Screw the block's nut to secure the block.
 - c. Insert a biopsy needle with the same specification as that of the guiding block into the guiding block hole.
4. Release the needle from the bracket:

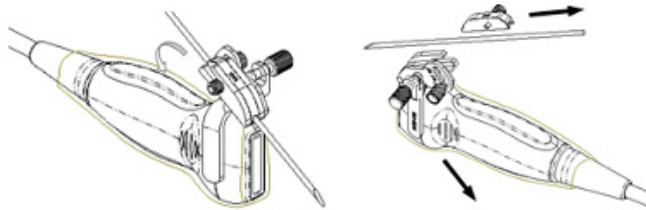

- a. Loosen the guiding block's nut and slightly move the guiding block in the direction of the needle's tail.
 - b. Separate the residual part of the needle-guide bracket and the probe from the needle.
5. Remove the needle-guided bracket:

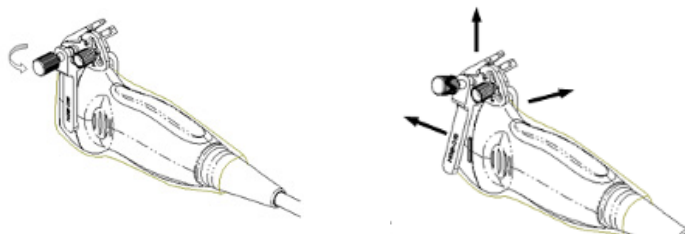

- a. Screw the pinch nut to release the needle-guided bracket
- b. Separate the bracket and the probe.

NGB-018 Metal-needle detachable needle-guided bracket

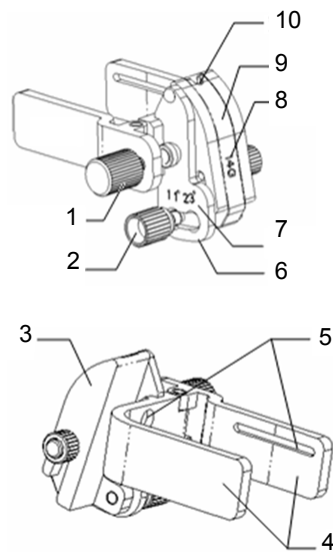

1	Pinch nut of bracket
2	Angle pinch nut
3	Angle block
4	Clamp
5	Groove
6	Angle-adjusting base
7	Angle shift sign
8	Guiding block specification
9	Guiding block
10	Needle guide hole

Perform the following procedure:

1. Install the needle-guided bracket:

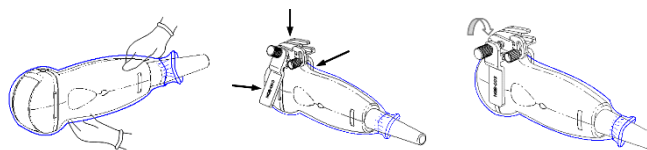

- a. Put on the sterile probe sheath.
 - b. Select a suitable needle-guided bracket and match the groove to the tab of the probe. Mount the bracket onto the probe.
 - c. Screw the pinch nut of the needle-guided bracket to ensure that the needle-guided bracket is properly installed on the probe.
2. Adjust the needle angle to the proper shift as required:
 - a. Loosen the angle pinch nut.
 - b. Adjust the angle block to the desired level.
 - c. Tighten the angle pinch nut.

3. Install the guiding block:

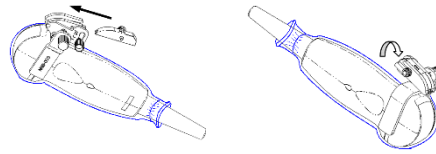

- a. Select a suitable guiding block and push it into the groove above the angle block
- b. Screw the block's nut to secure the block.
- c. Insert a biopsy needle with the same specification as that of the guiding block into the guiding block hole.

4. Release the needle from the bracket:

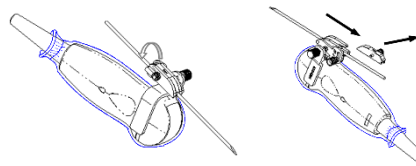

- a. Loosen the guiding block's nut and slightly move the guiding block in the direction of the needle's tail.
- b. Separate the residual part of the needle-guide bracket and the probe from the needle.

5. Remove the needle-guided bracket:

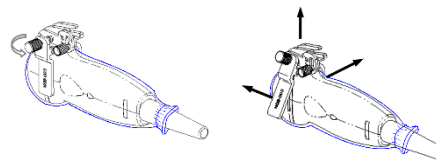

- a. Screw the pinch nut to release the needle-guided bracket
- b. Separate the bracket and the probe.

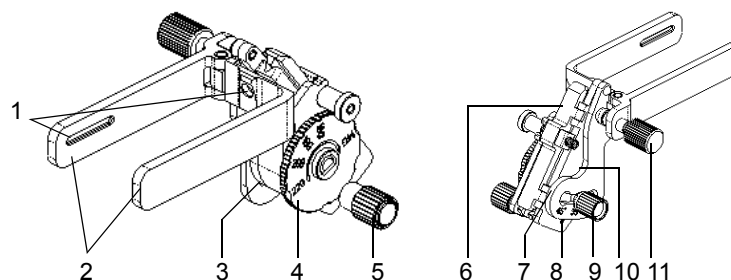
NGB-022 Metal-needle detachable needle-guided bracket

1	Groove
2	Clamp
3	Needle type adjusting base
4	Needle type dial scale
5	Needle fixing nut

6	V-shaped cover
7	Angle adjusting base
8	Angle shift sign
9	Angle pinch nut
10	Angle block
11	Pinch nut

Perform the following procedure:

1. Install the needle-guided bracket:
 - a. Put on the sterile probe sheath.
 - b. Hold the probe by one hand, select the proper needle-guided bracket, and hold it with the other hand. Match the groove of the bracket with the tab of the probe. Amount the bracket onto the probe.

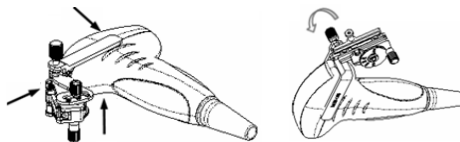

- c. Screw the pinch nut of the needle-guided bracket to confirm that the needle-guided bracket is properly installed on the probe.
2. Adjust the needle angle to the proper shift as required:
 - a. Loosen the angle pinch nut.
 - b. Adjust the angle block to the desired level.
 - c. Tighten the angle pinch nut.
3. Insert the biopsy needle:

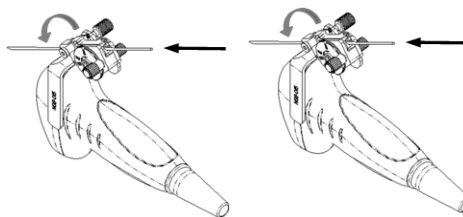

- a. Adjust the dial scale to the required needle type shift, and then screw the needle fixing nut to lock the dial scale. (To adjust the dial scale you have to loosen the needle fixing nut first.)
 - b. Pull the lock pin and close the V-shaped cover to fix the lock pin in the groove of the needle type adjusting base, so as to install the needle into the guiding hole.
4. Release the needle from the bracket:

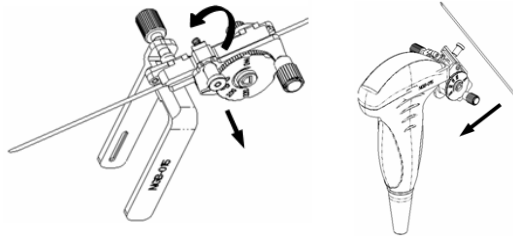

- a. Pull the lock pin and open up the V-shaped cover to expose the needle.
 - b. Separate the bracket and the probe from the needle.
5. Remove the needle-guided bracket:

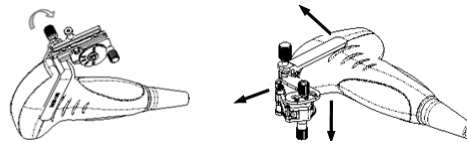

- a. Screw the pinch nut to release the needle-guided bracket.
- b. Separate the bracket and the probe.

NGB-034 Metal-needle detachable needle-guided bracket

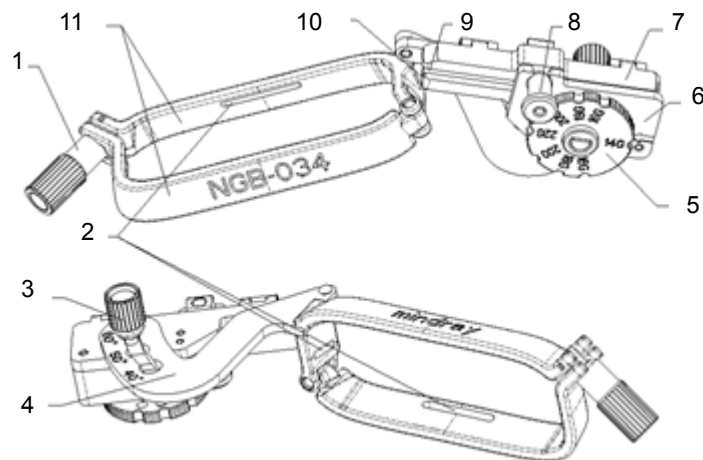

1	Needle fixing nut
2	Guiding groove
3	Angle fixing nut
4	Angle adjusting base
5	Needle type dial scale
6	Needle adjusting base
7	V-shape cover
8	Lock pin
9	Needle guide hole
10	V-shaped guiding block

11	Clamp
----	-------

Perform the following procedure:

1. Install the needle-guided bracket:

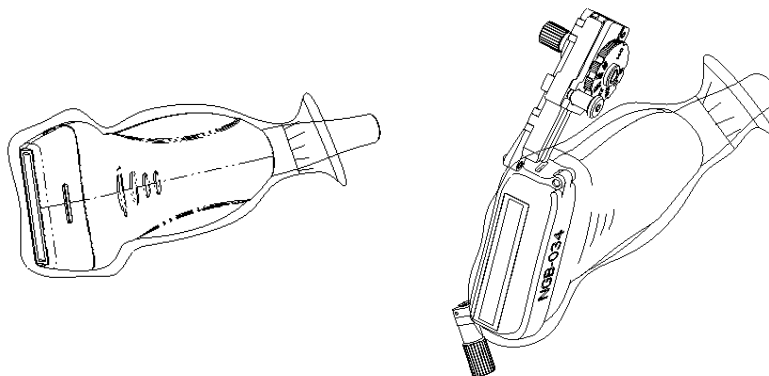

- a. Put on the sterile probe sheath.
 - b. Select a proper needle-guided bracket, and match the locating groove with the tab of the probe. Mount the bracket onto the probe.
 - c. Tighten the pinch nut of the needle-guided bracket to confirm that the needle-guided bracket is properly installed on the probe.
2. Adjust the needle angle to the proper shift as required:
 - a. Loosen the angle pinch nut.
 - b. Adjust the angle block to the desired level.
 - c. Tighten the angle pinch nut.
 3. Insert the biopsy needle:
 - a. Adjust the dial scale to the required needle type shift.
 - b. Pull the lock pin and close the V-shaped cover to fix the lock pin in the groove of the needle type adjusting base, so as to install the needle into the guiding hole.
 4. Release the needle from the bracket:

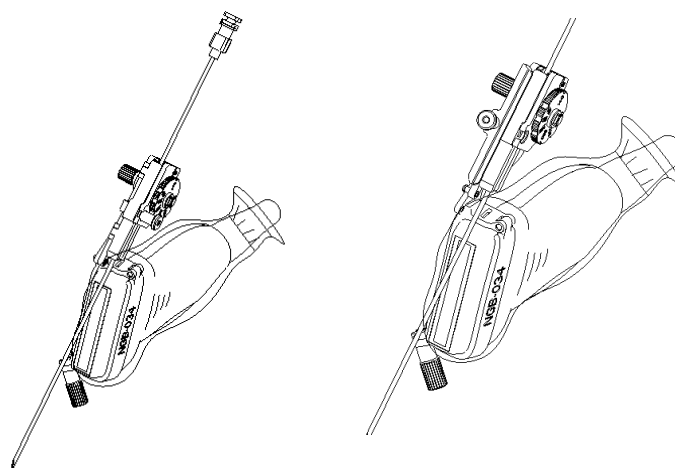

- a. Pull the lock pin out until the V-shaped cover can be turned and opened up.
 - b. Turn over the V-shaped cover to expose the needle. Remove the probe and bracket.
5. Remove the needle-guided bracket:

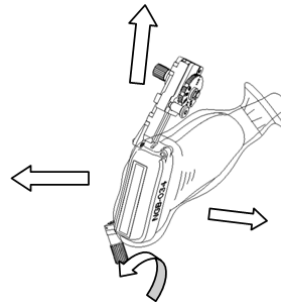

- a. Unscrew the pinch nut to release the needle-guided bracket.
- b. Hold the probe and take out the bracket.

NGB-035 Metal-needle detachable needle-guided bracket

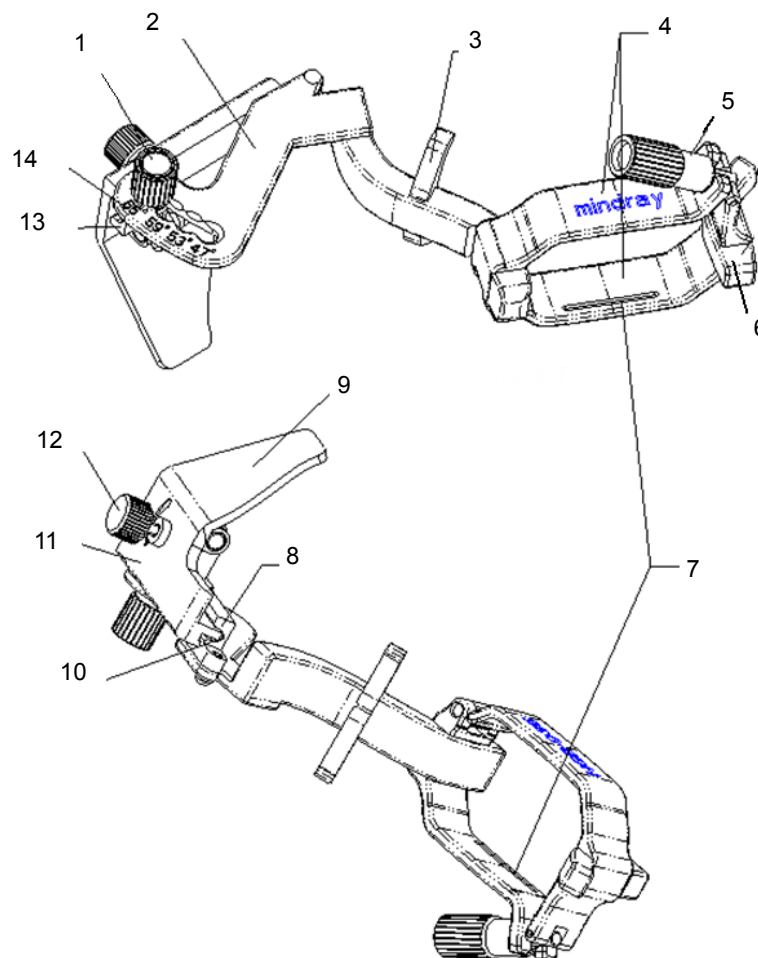

1	Angle locking nut
2	Angle adjusting block
3	Buckle
4	Clamp
5	The clamping nut of left/right clamp
6	The locating position block

7	Groove
8	V-shaped guiding block
9	The Pressing block for separating needle
10	Needle guide hole
11	Needle clamping cover of needle guided bracket
12	Needle adjusting nut of needle-guided bracket
13	Angle adjusting base
14	Angle mark

Perform the following procedure:

1. Install the needle-guided bracket:

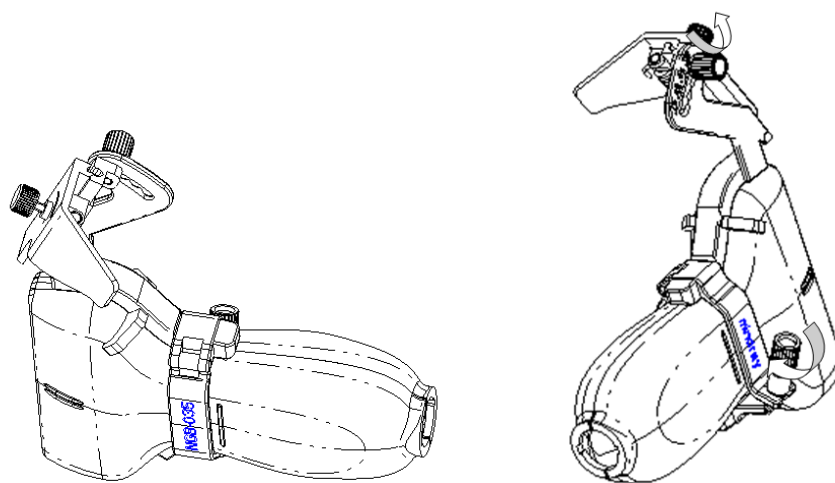

- a. Put on the sterile probe sheath.
 - b. Select a proper needle-guided bracket, and match the locating groove with the tab of the probe. Mount the bracket onto the probe.
 - c. Tighten the pinch nut of the needle-guided bracket to confirm that the needle-guided bracket is properly installed on the probe. Loosen the angle adjusting nut.
2. Adjust the needle angle to the proper shift as required:
 - a. Loosen the angle pinch nut.
 - b. Adjust the angle block to the desired level.
 - c. Tighten the angle pinch nut.
 3. Insert the biopsy needle:

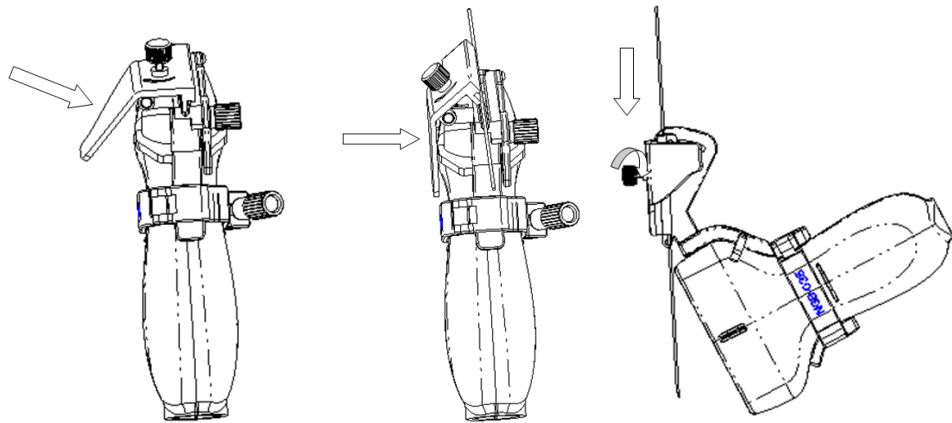

- a. Hold the probe and press the pressing block to separate V-shaped guiding block from the pressing block.
 - b. Insert the needle into V-shaped guided block.
 - c. Release the pressing block, adjust the angle adjusting nut to confirm that the needle can freely slide in a vertical direction.
4. Remove the needle-guided bracket:

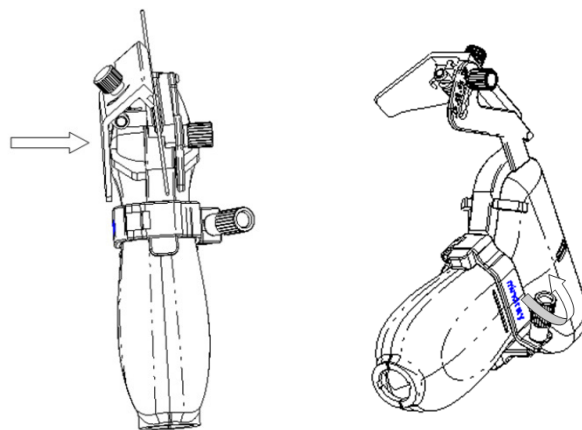

- a. Hold the probe and press the pressing block to separate V-shaped guiding block from the pressing block.
- b. Remove the needle.
- c. Rotate the clamping nut to separate the bracket from the probe.

NGB-036 Metal-needle detachable needle-guided bracket

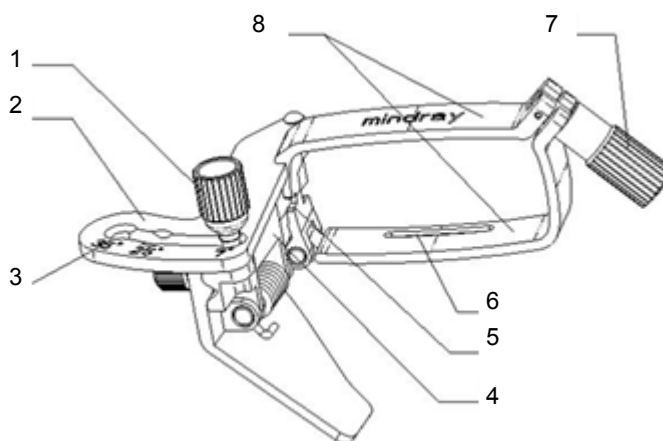

1	Angle locking nut
2	Angle adjusting block
3	Angle marker
4	Angle adjusting base
5	Groove
6	Slot
7	Right, left retaining nut
8	Right, left clamp

Perform the following procedure:

1. Install the needle-guided bracket:
 - a. Put on the sterile probe sheath.
 - b. Select the needle-guided bracket, and match the groove with the tab of the probe. Mount the bracket onto the probe.

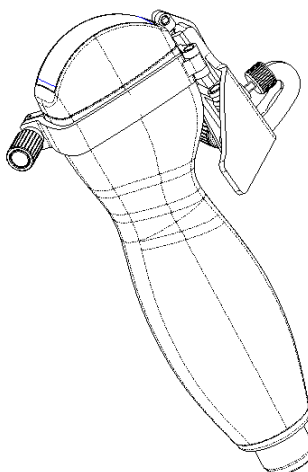

- c. Rotate the retaining nut to fix the bracket and the probe.

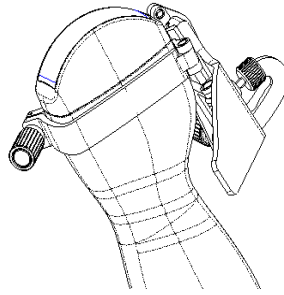

2. Adjust the needle angle to the proper shift as required:
 - a. Loosen the angle pinch nut.
 - b. Adjust the angle block to the desired level.
 - c. Tighten the angle pinch nut.
3. Insert the biopsy needle:
 - a. Hold the probe. Press the biopsy needle to separate needle guided V-shaped block from pressure position of the needle

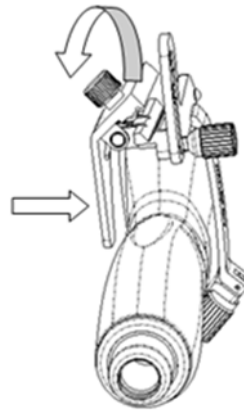

- b. Put the needle into the needle guided-bracket, and the needle leans to V-shaped block.

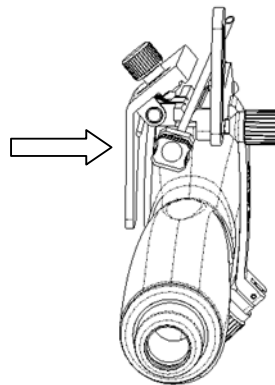

- c. Hold the probe, and release the pressure position of the needle. Adjust the needle-type adjusting nut manually (following the direction of the arrow). The needle moves smoothly at the vertical direction due to its gravity.

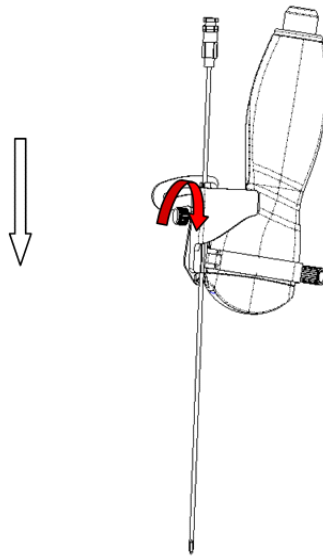

4. Release the needle from the bracket:

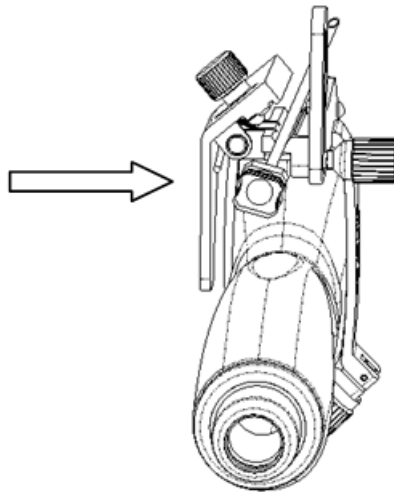

- a. Hold the probe. Press the biopsy needle to separate the needle from pressure position of the needle.
 - b. Separate the bracket and the probe from the needle.
5. Remove the needle-guided bracket:

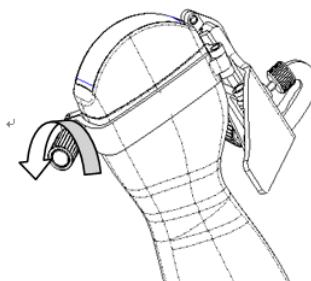

- a. Rotate the clamping nuts of the needle guided-bracket on right and left side (following the direction of the arrow). The needle guided-bracket is separate from the probe.

- b. Hold the probe and take out the bracket.

NGB-043 Metal-needle detachable needle-guided bracket

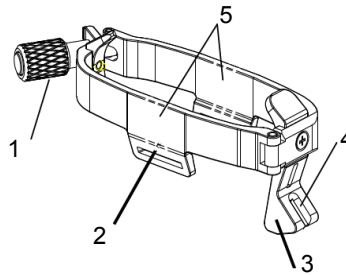

1	Locking nut of left and right clamps
2	Groove
3	Guide frame
4	Guide block hole
5	Clamps

Perform the following procedure:

1. Install the needle-guided bracket:
 - a. Put on the sterile probe sheath.
 - b. Hold the probe in one hand, select the correct needle-guided bracket and hold it with the other hand. Match the grooves of the needle-guided bracket to the tabs of the probe.
 - c. Mount the bracket onto the probe, and rotate the locking nut to fix the bracket.
2. Insert the biopsy needle:

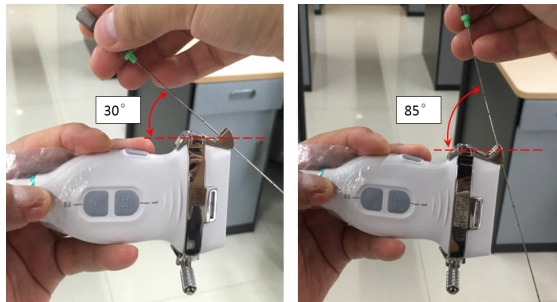

- a. Insert a biopsy needle into the guiding block hole.
 - b. Adjust the biopsy angle of the needle, and ensure that the needle can be adjusted continuously within the range of 30° to 85°.
3. Release the needle from the bracket:

Hold the probe, and remove the biopsy needle from the guiding hole of the guiding block.
 4. Remove the needle-guided bracket:



- a. Rotate the locking nut in the direction of the arrow shown on the figure to separate the bracket from the probe.
- b. Hold the probe and take out the bracket.

NGB-044 Metal-needle detachable needle-guided bracket

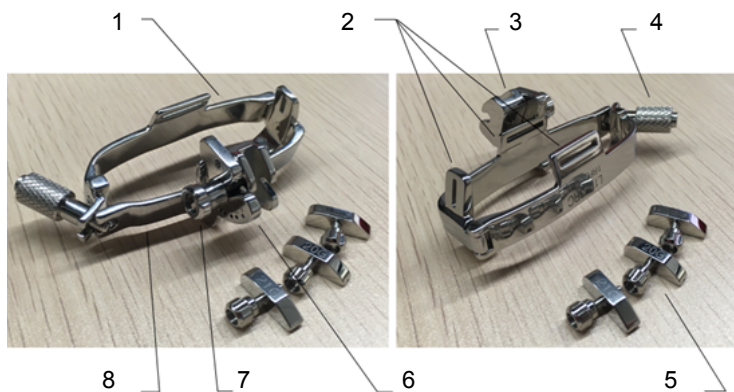

1	Right clamp
2	Groove
3	Guiding block fixing frame
4	Locking nut of left and right clamps
5	Guiding blocks
6	Depth shift sign
7	Depth pinch nut
8	Left clamp

Perform the following procedure:

- 1. Install the needle-guided bracket:



- a. Put on the sterile probe sheath.
 - b. Hold the probe in one hand, select the correct needle-guided bracket and hold it with the other hand. Match the grooves of the needle-guided bracket to the tabs of the probe.
 - c. Mount the bracket onto the probe, and rotate the locking nut to fix the bracket.
2. Adjust the needle angle to the proper shift as required:



- a. Loosen the depth pinch nut.
 - b. Adjust the depth shift to the desired level.
 - c. Tighten the depth pinch nut.
3. Insert the biopsy needle:
- a. Select a suitable guiding block and loosen its nut, install the guiding block to the guiding block fixing frame, then tighten the block nut tightly.

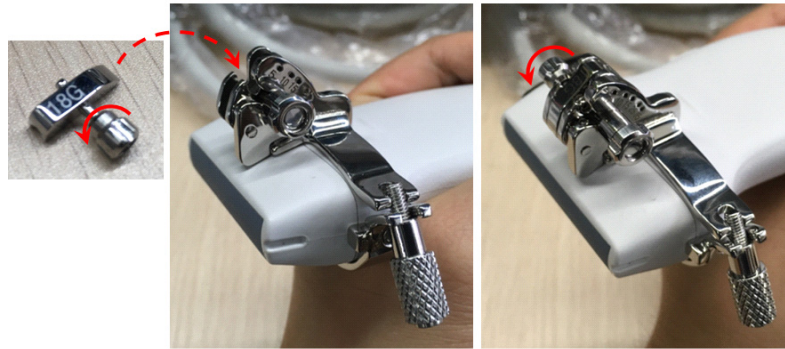

- b. Insert a biopsy needle with the same specification as that of the guiding block into the guiding block hole

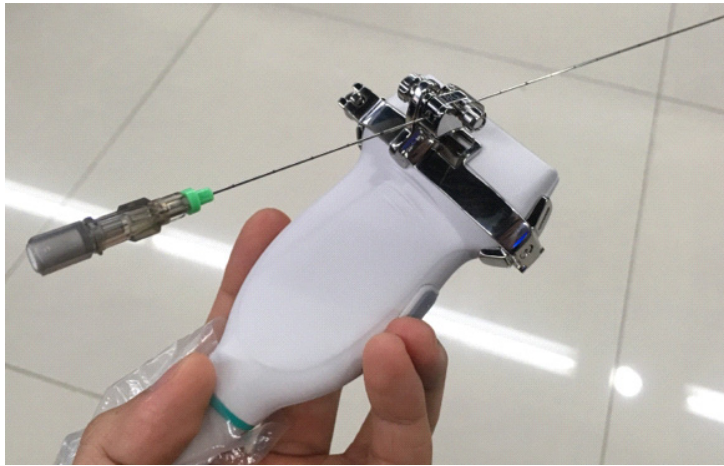

- 4. Remove the needle-guided bracket:
 - a. Hold the probe and remove the needle.
 - b. Loosen the guiding block nut, and remove it from the guiding block fixing frame.



- c. Rotate the clamping nuts of the needle guided-bracket. The needle guided-bracket is separate from the probe. Hold the probe and take out the bracket.



12.2.3 Verifying the Biopsy Guide Line

⚠ WARNING

- Prior to each biopsy procedure, be sure to verify the guide line.
 - If the needle is not consistent with the guide line, **DO NOT** perform the biopsy procedure.
-

NOTE:

You can perform guide line verification on a single live B/C image, and all biopsy-irrelevant operations are forbidden.

Adjusting the needle mark is necessary before each biopsy procedure.

Perform the following procedure:

1. Confirm that the needle-guided bracket has been installed securely in the correct position.
2. Prepare a container filled with sterile water.
3. Place the head of the probe in the sterile water and place a biopsy needle in the needle guide.
4. When the biopsy needle appears on the image, confirm that the biopsy needle is displayed at almost the same position as the selected needle mark.
5. Enter Biopsy.
 - Select the biopsy bracket angle/guide line: If the needle-guided bracket supports more than one biopsy angle, select the angle/guideline by using [Biopsy Kit].
 - Select the guide line dot size by using [Dot Size].

NOTE:

- The distance between two dots is depth-dependent. Move the cursor over the big dot and a numeral, representing the biopsy depth, is displayed.
 - The biopsy guidezone adjusts along with image adjustments, such as image inversion/rotations, zoom and depth changes.
 - When the imaging depth and area are changed, the guide line is adjusted.
6. Select [Verify] in the Biopsy menu to open the Biopsy Verify menu.

- Adjust the guide line position: Use [Position] to change the position of the guide line.
 - Adjust the angle: Use [Angle] to change the guide line angle.
 - Save the verified settings: After the position and angle of the guide line are adjusted, select [Save] and the system saves the current guide line settings. If biopsy is entered again, the displayed Position and Angle are the verified value.
 - Restore the factory default settings: select [Load Factory] and the position and angle of the guide line are restored to the factory default settings.
 - Exit biopsy verify status: select [Exit] and the system exits the guide line verification status.
7. Select [Alignment] in the Biopsy menu to open the Biopsy Verify menu.
- Adjust the guide line position
Tap and drag the top dot on the line to change the position of the guide line.
 - Adjust the angle
Tap and drag the bottom dot on the line to change the guide line angle.
 - Save the verified settings
After the position and angle of the guide line are adjusted, tap [Save] and the system saves the current guide line settings. If biopsy is entered again, the displayed Position and Angle are the verified value.
 - Restore the factory default settings
Tap [Load Default] and the position and angle of the guide line are restored to the factory default settings.
 - Exit biopsy verify status
Tap [Exit] and the system exits the guide line verification status.

12.2.4 Starting the biopsy procedure

DANGER

- Ensure that all guide parts are properly fixed prior to performing a biopsy.
- If you changed the probe or needle-guided bracket during the biopsy, verify the guide line again.
- Failure to match the guide zone displayed to the guide may cause the needle to track a path outside the zone.
- It is extremely important that when using the adjustable angle biopsy guides, the angle displayed on the screen matches the angle set on the guide, otherwise the needle will not follow the displayed guide zone and this could result in repeated biopsies or patient injury.

Perform the following procedure:

1. Select the correct needle-guided bracket and needle and install them properly.
2. Enter the biopsy.

If the current probe has no corresponding bracket, or the image is frozen and the guide line was hidden before the image was frozen, then you cannot enter the Biopsy menu.

3. Select the bracket and guide line according to the actual situation.

Select [Alignment] to enter Biopsy Verify menu to fine tune the guide line if needed.

4. If available, use iNeedle function to help enhance the needle visualization when the needle display is not clear.

iNeedle is an option.

- a. Select [iNeedle].

The parameters that can be adjusted appear on the menu:

[B/iNeedle]: select to display B image and iNeedle image synchronously.

[Needle Dir.]: select to adjust the needle direction display according to actual direction of needle insertion. The iNeedle affecting region changes correspondingly.

- b. Select [iNeedle] again to exit.

5. Scan to locate the target. Center the target in the electronic guidezone path.
6. Direct the needle into the area of interest for specimen.
7. After extracting the biopsy sample is complete, gently remove the probe from the body.
8. Exit the Biopsy menu.
9. Disassemble the items and properly dispose of these items as required.

12.2.5 Clean and Sterilize the Needle-Guided Bracket

CAUTION

- Needle-guided brackets whose name starts with NGB are reusable, and need thorough cleaning and sterilization before and after each biopsy.
- Follow local regulations when selecting and using the disinfectant.
- Repeated sterilization may degrade the safety and performance of the needle-guided bracket. Before use, please check whether the needle-guided bracket has defects such as deformation and rusting. If such defects exist, the bracket has reached the end of its service life. In this case, stop using it and contact the Mindray service department.
- It is recommended to use immersion sterilization for plastic needle-guided brackets and high-pressure steam sterilization for metal needle-guided brackets.
- For detailed operations about the cleaning solvent, sterilant and high-temperature steam sterilizer, see the respective operator's manuals provided by the manufacturer.

NOTE:

Disposable components are packaged sterile and are single-use only. Do not use if integrity of packaging is violated or if expiration date has passed. Please use the disposable components compliant with the relevant local regulations.

Cleaning

Perform the following procedure:

1. Wear a pair of gloves to prevent infection.
2. After use, immerse the needle-guided bracket in distilled water immediately to prevent dirt from drying. Wipe the entire surface of the needle-guided bracket by using a piece of disposable lint-free soft cloth to remove coarse dirt.

3. Prepare a cleaning solvent (enzymatic or neutral pH detergent, e.g., liquinox, MetriZyme) by using distilled or softened water in accordance with the operator's manual provided by the manufacturer.
4. Detach all the detachable parts of the needle-guided bracket and immerse the needle-guided bracket and all its parts fully in the cleaning solvent for at least 1 minute or a period specified by the manufacturer.
5. Immerse the needle-guided bracket and all its parts fully in the cleaning solvent. Wipe and wash the surface and connecting parts of the needle-guided bracket gently by using a soft brush until no dirt is visible. Place the needle-guided bracket inside an ultrasonic cleaner and perform ultrasonic cleaning for 3–5 minutes.
6. Rinse the needle-guided bracket thoroughly by using a large amount of distilled or softened water (about 2 gallons) at room temperature for about 30 s to remove the residual dirt and cleaning solvent. Repeat the operation twice.
7. Wipe away the water on the needle-guided bracket by using a piece of disposable lint-free soft cloth.
8. Inspect the needle-guided bracket. If visible dirt still exists, repeat the preceding steps to wash the bracket until it is all clean.

Sterilization with a sterilant

Perform the following procedure:

1. Wear a pair of gloves to prevent infection.
2. Clean thoroughly in accordance with the cleaning procedure before sterilization.
3. Prepare a sterilant by using sterile distilled water when necessary.

Table 12-4 Recommended sterilization solution

Chemical name	Trade name	Procedures
Glutaraldehyde (2.4%)	Cidex Activated Dialdehyde Solution (applicable for FDA region only)	Refer to the instructions provided by the solution manufacturer for details.
22% Hydrogen Peroxide 4.5% Peroxyacetic Acid	Minnicare liquid disinfectant (applicable for Canada only)	Refer to the instructions provided by the solution manufacturer for details.
Glutaraldehyde (2.6%)	Metricide	Refer to the instructions provided by the solution manufacturer for details.

4. Immerse the needle-guided bracket fully in the sterilant and shake the bracket appropriately to remove any bubbles on the surface. Use a syringe to draw an appropriate amount of sterilant and inject the sterilant into the hole to remove the bubbles inside the hole if necessary.
For details about the immersion duration, see the operator's manual provided by the manufacturer.
5. After sterilization, wash the needle-guided bracket thoroughly by using a large amount of sterile distilled water (about 2 gallons) at room temperature for about 30s to remove the residual sterilant. Repeat the operation twice.
6. Dry the needle-guided bracket by using a piece of sterile disposable lint-free soft cloth.
7. Store the needle-guided bracket in a cool, clean and dry environment.

High-pressure steam sterilization

High-pressure steam sterilization is preferred for the metal guided brackets. And the sterilizer and accessories should be cleared by FDA for the intended sterilization cycle.

Perform the following procedure:

1. Wear a pair of gloves to prevent infection.
2. Clean thoroughly in accordance with the cleaning procedure before sterilization.
3. Package the needle-guided bracket in accordance with the sterilization requirements of surgical instruments using the sterilization wrap or pouch cleared by FDA.
4. Place the packaged needle-guided bracket inside a high-temperature steam sterilizer and perform sterilization. The sterilization parameters are 121 °C and 30 minutes for a gravity displacement steam sterilizer and are 132 °C and 4 minutes for a dynamic-air-removal steam sterilizer.
5. Take out the sterilization package after sterilization and dry it in an oven at 60 °C for 20 minutes to 30 minutes.

Keep the sterilization package together with other sterilized surgical instruments in a sterile item storage area.

12.2.6 Storage and Transportation

- Do not use the carrying case for storing the needle-guided bracket. If the carrying case is used for storage, it may become a source of infection.
- Between examinations, keep the needle-guided bracket in a sterile environment.
- If the needle-guided bracket is sent to your MINDRAY representative for repair, be sure to disinfect or sterilize it and keep it in the carrying case to prevent infection.
- Sterilize the carrying case as necessary.
- Store or transport the needle-guided bracket under the following ambient conditions:
 - Ambient temperature: -20 °C to 55 °C
 - Relative humidity: 20% to 85% (no condensation)

12.2.7 Disposal

Be sure to sterilize the needle-guided bracket before disposing of it.

Disposal of the needle-guided brackets is in accordance with SanPiN 2.1.7.2790-10.

Contact your MINDRAY representative when disposing of this device.

12.3 Middle Line

Middle Line helps to locate and observe the focus point of lithotripsy wave during lithotripsy treatment. By means of providing information for the lithotripsy machine as well as a tool for watching the procedure of lithotripsy in real-time, you can adjust the intension and frequency of the lithotripsy wave through lithotripsy machine.

NOTE:

This function in the ultrasound system is for lesion (stone) location and observation only. For details, please refer to lithotripsy machine accompanying manuals.

Turn on Middle Line function.

- The middle line is a vertical dotted line located in the middle of the screen, the position and direction of which cannot be changed.
- There is a mark icon of “×” located on the middle line which can be moved up and down along the line.
- To use the Middle Line function of the ultrasound system:
 - a. Change the mark position and by adjusting lithotripsy machine tools or patient posture to locate the stone center at the mark.
 - b. Read the depth of the mark by observing the depth caliper on the screen.
 - c. After the stone is located, refer to lithotripsy machine manuals to perform the lithotripsy.
 - d. The depth of the mark is displayed in the image parameter area of the screen.

12.4 eSpacial Navi

The eSpacial Navi function builds up the connection between the ultrasound system and the processed needles. The needle position appears on the image in real time. Meanwhile, the virtual needle mark guides the needle path on the ultrasound image. Based on the magnetic induction technology, the eSpacial Navi function aids in and enhance the ultrasound needle guidance.

WARNING

- Ultrasound images should be referenced during the whole process of needle guidance.
- The magnetizer should be used with the needle cap. Disinfect the magnetizer after use.
- The magnetizer is a single use device. Dispose of the magnetizer properly after use.
- The needle cap is a sterile, single use device. To maintain procedural sterility, it is important that the needle cap is isolated from non-sterile objects.

CAUTION

- Keep the magnetizer away from any device that is sensitive to magnetic fields. Never place or hold the magnetizer within 1 m of the probe.
- The eSpacial Navi system supports only the needle types listed on the needle list. For details, see “12.4.1 Interface”.
- Keep the eSpacial Navi probe away from the source of disturbance, such as metal objects and magnetized objects. Do not use or store the eSpacial Navi probe in the vicinity of strong electric or magnetic fields.





NOTE:

- When used under optimal operating conditions by an experienced medical professional, the eSpacial Navi system can achieve precision as high as ± 2.4 mm.
- Place the magnetizer in the proper position to prevent the magnetizer from falling off or becoming damaged.

- DO NOT make the magnetizer overheated (more than 50 °C) during cleaning and disinfections. High temperature may cause the magnetizer to become deformed or damaged.

12.4.1 Interface

During biopsy, the selected needle type and prompt icons are displayed on the screen. The meaning of prompt icons are as follows:

	Alignment indicator (plan view)
	Alignment indicator (plan view)
	Filed strength
	Maximum depth at which the needle can be detected
	Appears when the insertion angle of a needle relative to the skin surface exceeds 60° to notify users to adjust the angle.

In Plane Needle Guidance GUI

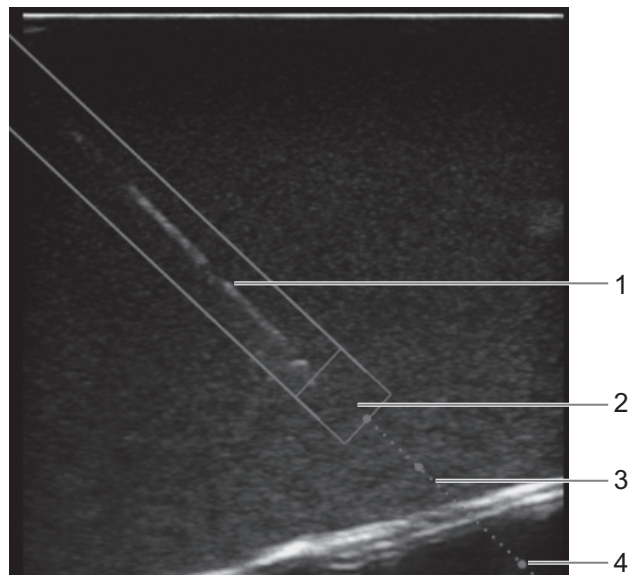

1	Needle position in the ultrasound plane
2	Needle tip position in the ultrasound plane
3	Needle guidance trajectory
4	Scale of guideline (5 mm/scale)

Out of Plane Needle Guidance GUI

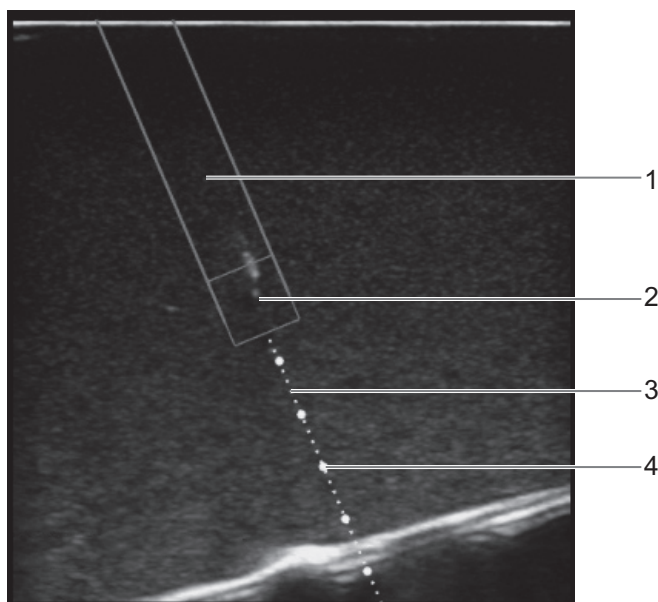

1	Needle projection position in the ultrasound plane
2	Position at which the needle cross the ultrasound plane
3	Projection position of the needle guidance trajectory in the ultrasound plane
4	Scale of guideline (5mm/scale)

12.4.2 Preset

eSpatial Navi Needle Menu

Enter the Needle menu, and controls are as shown in Table 12-5.

Table 12-5 eSpatial Navi Needle settings

Item	Description
Needle	Select the desired needle from the drop-down list. You can set the most frequently used needle to a favorite one.
Display Favourite Only	After it is ticked, only the favorite needles are displayed on the needles list.
Auto Optimize	After it is ticked, the system adjusts focus position automatically according to the position of the needle tip, and enable or disable ExFOV function.

eSpatial Navi Settings Menu

Enter the eSpatial Navi Settings menu, and select the items to be displayed on the screen.

12.4.3 Preparation Before Needle Guidance

NOTE:

Before and during calibration, keep the probe away from the magnetic sources, such as metal objects, electrical motors, switching power supplies, nerve stimulators and similar medical devices.

Perform the following procedure:

1. Scan the target tissue and adjust the image parameters.
2. Check the field strength to ensure that the field strength indicator is . If the field strength is low, hold the probe and select [Calibrate] on the eSpacial Navi Needle menu. Do not move the probe during the calibration.

Indicator Colors	Description
Green	Low magnetic interference: appropriate for needle guidance.
Yellow	Medium magnetic interference: be cautious for needle guidance.
Red	High magnetic interference: do not perform needle guidance.

3. Magnetize a needle cap.
 - a. Place an appropriate sterile needle cap (length: 3.5cm to 4.5cm, diameter < 7 mm, with bottom closed) into the magnetizer.



- b. Introduce a needle into the cap, and ensure that the needle tip contacts the bottom of the needle cap.

If the needle cap associated with the needle does not meet the requirements, you are recommended to use BBraunSterican <35 mm needles cap or B&D Microlance <35 mm needles cap.





- c. Hold the needle for 1 or 2 seconds and then withdraw it quickly from the magnetizer.

12.4.4 Procedure

NOTE:

- The Pan Zoom function is not supported on eSpacial Navi mode.
- Do not freeze the ultrasound image during the procedure. Otherwise, biopsy guidance information will disappear.

- When the insertion angle of a needle relative to the skin surface exceeds 60°,  is displayed on screen to notify users to adjust the angle. After the angle is smaller than 60°,  disappears.
-

Perform the following procedure:

1. Hold the probe stably and put the needle close to the probe for connection. After the needle and probe are successfully connected, the system automatically calculate the maximum depth at which the needle can be detected in real time, and display the depth value in the touch screen.

When the actual depth is greater than the maximum value, the needle guidance information disappears temporally.
2. Adjust the needle position and angle to define the position for inserting the needle.

Pay attention to the field strength during the needle guidance process.

13 DVR Recording

NOTE:

Strictly observe the procedures described here to perform the recording and replaying operations; otherwise it may result in data loss or system malfunction.

The system provides built-in DVR recording function. You can use the DVR to record and replay videos and audios that can be stored in DVD disc or hard disc.



The recorded video is AVI format; you can save it in the hard disk drive, burn to the DVD or export to the USB disk.

When the built-in DVR is in normal status, the icon  is displayed in the system tool bar menu.

13.1 Start Recording

After recording, the system will save the recording file automatically, you can select to save in local disk, U disk or optical disk.

Perform the following procedure:

1. Perform ultrasound exams, select appropriate views and adjust parameters to prepare for recording.
2. Tap  to open the dialog box and select desired recording type.
3. Tap [Record] to start recording, and the DVR icon displays as  in recording status.

During the recording process, you can perform imaging mode switching, comments adding, body mark adding and measurements.

4. Tap [Stop] to stop recording, the DVR icon turns into data transfer status .
 - If USB/CDROM is selected, the system sends the recorded file to the target storage media (USB disk or DVD optical disk drive) in the meantime.
 - If Hard disk is selected, the system saves the file to the path: D:\Hepatus\DVR.

In the task management screen, you can check transferring status.

13.2 Sending Image

The system also supports exporting recorded images that are saved in the local disk.

1. Tap  to open the dialog box, and tap [Local Video Manage] to enter the managing dialog box.

Tap [Rename] to rename the video file.

2. Select the destination and the target file, tap [Send] to send the file to the selected path. During sending progress, the icon displays as .

13.3 DVR Video Replaying

You can replay the video and audio record.

13.3.1 Replay on PC

Connect the USB disk or optical disk with the file to the PC, and open the file directly.

13.3.2 Replay on the ultrasound system

Perform the following procedure:

1. Tap  to open the dialog box and select desired playing type.
2. Tap [Play] to open the dialog box.
3. Select the path and name for the file and then tap [OK] to replay the file, or double-click the file name directly.
4. Tap the screen to exit.

14 System Maintenance

Routine system maintenance shall be carried out by the user. System maintenance after the warranty has expired is the full responsibility of the owner/operator.

The responsibility for maintenance and management of the product after delivery resides with the customer who has purchased the product.

If you have any questions, please contact Mindray Customer Service Department or sales representative.

WARNING

- Only an authorized Mindray service engineer can perform maintenance not specified in this operator's manual.
 - For the sake of the system performance and safety, you should perform periodical checks for the system.
-

14.1 Daily Maintenance

You are responsible for daily maintenance.

14.1.1 Cleaning the System

WARNING

- The display can be cleaned on power-on status while the power is "On" by selecting  > [Screen Lock] to lock the system for 10 seconds. Before cleaning other parts of the system, ensure to turn off the power and disconnect the power cord from the outlet; or, it may result in electric shock while the power is "On".
 - DO NOT directly spray solution onto the monitor, system control panel or hard surfaces that is under pressure or pumped. Ingress fluid leakage into the monitor or system can damage the monitor or system, causing possible electric shock or system failure.
-

CAUTION

Do not spill water or other liquid into the system while you perform the cleaning. Otherwise it may result in malfunction or electric shock.

NOTE:

- DO NOT use hydrocarbon glass cleaner or cleaner for OA (Office Automation) equipment to clean the monitor. These substances may cause deterioration of the monitor.
 - Please clean the control panel periodically, otherwise the button may be blocked by dirt and the system will be buzzing while the button makes no response.
-

Cleaning probes

Tools: mild soapy water , dry soft cloth, soft brush

Method:

1. Wipe out the dust attached to surface of probe head, connector and cable.
 2. Use soft brush to brush the dust inside probe connector gently.
 3. Remained stain or dust attached to surface of cable or surface of connector should be washed out by cloth with a little soapy water, and then air-dry.
-

NOTE:

Don't use cloth with water to clean the probe connector.

Cleaning holders

Tools: soft dry cloth, soapy water, soft brush.

Remaining stains should be wiped away using a cloth with clean or soapy water and the surface left to air dry.

Perform the following procedure:



1. Use a soft dry cloth to wipe away dust attached to the inside, outside and gaps in the probe holder. Use a soft brush to brush away dust or stains from the small intra-cavity probe holder or its gap.
2. Remaining stains on the inside and outside of the holder should be wiped away using a cloth with a little soapy water and then air dried.

Cleaning the display**NOTE:**

Do not use chemical solvents, acid or alkaline solution to clean the display.

The ultrasound system has passed puncture test and leakage current test, and thus can be cleaned on power-on status.

Tools: soft dry cloth, clean water or neutral detergent.

Clean the system in power off status; or in power on status, tap  in the top-right corner of the screen and select  to lock the system for 10 seconds.

Clean the display surface with a soft dry cloth. Remaining stains should be wiped away using a cloth with a little neutral detergent or clean water and then leave to air dry.

Cleaning the cover

Tools: soft dry cloth, soapy water

Use a soft dry cloth to clean the system's cover. If the system is dirty, moisten the soft cloth with neutral soapy water, wipe away any stains, and dry the system in the air.

NOTE:

Use a soft brush to brush away dust attached to all visible sockets or interfaces (such as probe sockets, sockets or interfaces in the IO panel and power supply panel). Do not use a cloth and water.

Cleaning the dust-proof cover**⚠ CAUTION**

Please clean all the system's dustproof covers periodically (once per month). Failure to do so may result in system damage. Cleaning times can be increased when the system is used in the open air or somewhere more dusty.

Perform the following procedure:

1. Press the clip of the dust-proof cover and unfold it outwards (shown in the figure below).

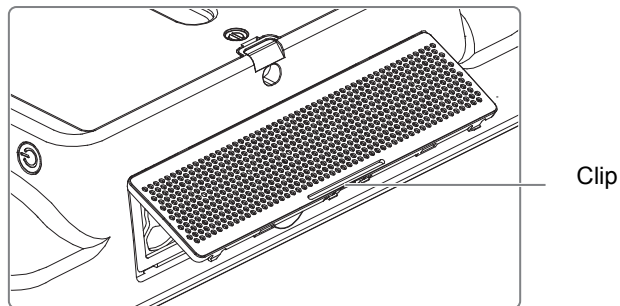

2. To remove the fixing frame of the dust-proof cover and the cover itself, press two clips on the fixing frame of the dust-proof cover towards arrow's direction (shown in the figure below).

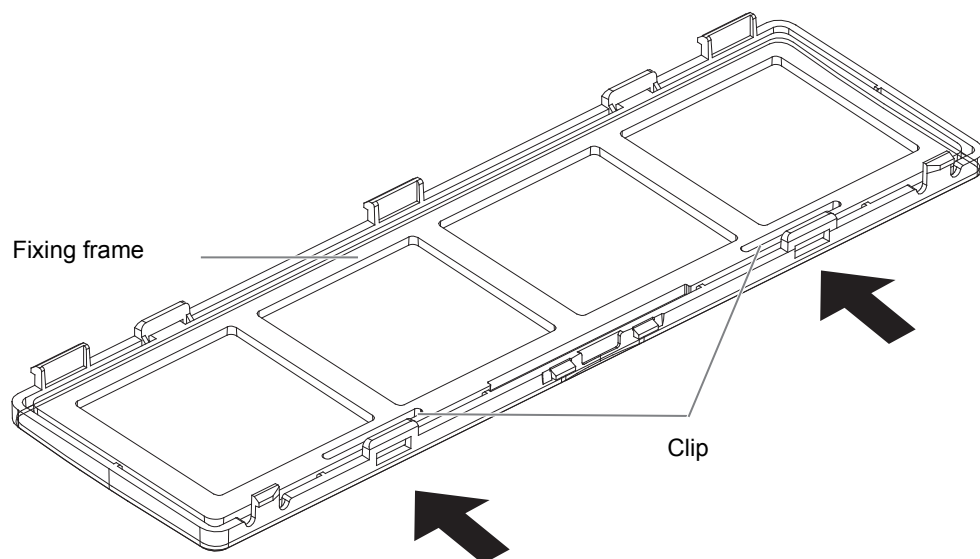

3. Clean the dust-proof mesh with water or soft brush.

14.1.2 Disinfecting the Main Unit

For details about disinfecting the main unit, please refer to the Cleaning, Disinfection & Sterilization Guide.

14.1.3 Cleaning the peripherals

Do the cleaning maintenance according to your actual peripheral configuration; items which are not configured can be skipped.

Content	Description
Color and B/W video printer	First wipe off dust or stain attached to the cover of printer with soft dry cloth, then clean the inside of printer. Be sure to do the cleaning maintenance according to the operation manual if necessary.
Graph / text printer	First wipe off dust or stain attached to the cover of printer with soft dry cloth, then clean the inside of printer. Be sure to do the cleaning maintenance according to the operation manual if necessary.
Footswitch	Use soft dry cloth with a little mild soap water to wipe off the dust or stain attached to the pedals or cable of foot switch.
Barcode reader	First use soft dry cloth to wipe off dust attached to glass panel of the reader, then the dust or strain attached to cable and bracket.

14.1.4 Checking the Probe

- Visually check to confirm that there are no cracks or expansion of the probe head.
- Visually check to confirm that there is no deterioration or erosion of the probe cable.
- Visually check to confirm that none of the connector pins are bent, destroyed or falling off.

14.1.5 Checking the Power Cable and Plug

Visually check to confirm that there are no wrinkles, cracks or deterioration, and no cracks or expansion on the surface of the adapter.

Manually check to confirm that there is no looseness or rupture. The connection of the plug is reliable.

14.1.6 Checking Appearance

Check if there are any cracks in the covers:

- Ultrasound system covers.
- Probe appearance.
- External appearance of the ECG lead.

14.1.7 System Hard Drive Backup

To prevent deterioration or loss of data stored in the system hard drive (including patient info data, preset data, etc.), create a backup copy of the hard drive at regular intervals.

14.2 Troubleshooting

If any persistent system malfunction is experienced, e.g., an onscreen error message, blank imaging screen, absent menus, see the table below. If the failure cannot be resolved, contact the Mindray Customer Service Department or a sales representative.

No.	Failure	Cause	Measure
1	The system cannot be powered on.	Abnormal power system or incorrect connection of the power cord.	Check that the system is plugged in.
			Check that the plug has not become loose or dislodged from the back of the system.
2	The display has no output.	The interval between turning off and restarting the system is too short - wait at least 20 seconds.	Turn off the system and wait at least 1 minute, then restart the system.
		The display brightness or contrast may be improperly set.	Adjust the display brightness and contrast.
3	The touch screen displays the characters and menus but no images.	The acoustic power, gain or TGC controls are improperly set.	Adjust the acoustic power output, gain or TGC control.
		Check that a probe is connected and/or fully connected.	Check probe connection.
		The system is in frozen status.	Unfreeze the image.
4	The image quality is degraded	The exam mode is incorrect.	Select an appropriate exam mode.
		The image parameter settings are incorrect.	Adjust the image parameters.

This page intentionally left blank.

A Barcode Reader

The system supports logging data as patient ID by using the barcode reader.

⚠ CAUTION

Ensure the information acquired by barcode reader is consistent with the actual information.

TIP:

The reader does not support decoding of Multi-language.

A.1 1-D Barcode Reader

The laser transmitted by SYMBOL LS2208 is Class 2 laser.

⚠ WARNING

Class 2 laser adopts low power, visible LED. DO NOT stare into beam because of unknown hazards of transient radiation provided by class 2 laser.

There are 2 operation modes for 1-D barcode readers:

- Hand-held mode: press the trigger to decode.
- Hands-free mode: seat the reader in the stand to enter the mode, the reader decodes automatically.



1	LED	<ul style="list-style-type: none">• Green: A barcode was successfully decoded.• Red: A data transmission error or reader malfunction occurred.
2	Scan window	Scan the barcode.

3	Trigger	Press to decode.
---	---------	------------------

A.1.1 Setting Up the Reader

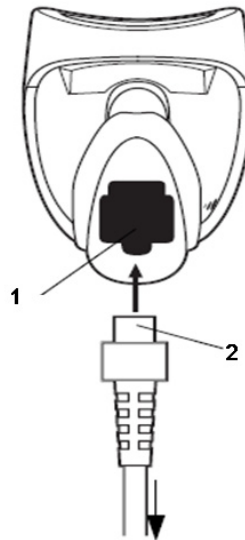

1	Cable interface port
2	Interface cable modular connector

Perform the following procedure:

1. Plug the interface cable modular connector into the cable interface port on the bottom of the reader handle, and ensure the connector is properly secured.
2. Connect the other end of the interface cable to the host.

A.1.2 Setting

The reader has factory settings, refer to the following table for parameter defaults:

Parameter	Defaults	Parameter	Defaults
1-D Symbolologies		Interleaved 2 of 5 (ITF)	
UPC/EAN		Interleaved 2 of 5 (ITF) Enable	Enable
UPC-A	Enable	Set Lengths for I 2 of 5	14
UPC-E	Enable	I 2 of 5 Check Digit Verification	Disable
UPC-E1	Disable	Transmit I 2 of 5 Check Digit	Disable
EAN-8/JAN 8	Enable	Convert I 2 of 5 to EAN 13	Disable
EAN-13/JAN 13	Enable	Codabar (NW - 7)	
Bookland EAN	Disable	Codabar	Enable
Decode UPC/EAN/JAN Supplementals (2 and 5 digits)	Ignore	Set Lengths for Codabar	5 to 55
UPC/EAN/JAN Supplemental Redundancy	10	CLSI Editing	Disable
Transmit UPC-A Check Digit	Enable	NOTIS Editing	Disable

Parameter	Defaults	Parameter	Defaults
Transmit UPC-E Check Digit	Enable		
Transmit UPC-E1 Check Digit	Enable	2-D Symbologies	
UPC-A Preamble	System Character	PDF417	Enable
UPC-E Preamble	System Character	MicroPDF417	Disable
UPC-E1 Preamble	System Character	Code 128 Emulation	Disable
Convert UPC-E to A	Disable	Data Matrix	Enable
Convert UPC-E1 to A	Disable	Maxicode	Enable
EAN-8/JAN-8 Extend	Disable	QR Code	Enable
UCC Coupon Extended Code	Disable		
Code 128			
Code 128	Enable		
UCC/EAN-128	Enable		
ISBT 128	Enable		
Code 39			
Code 39	Enable		
Trioptic Code 39	Disable		
Convert Code 39 to Code 32 (Italian Pharmacy Code)	Disable		
Code 32 Prefix	Disable		
Set Length(s) for Code 39	2 to 55		
Code 39 Check Digit Verification	Disable		
Transmit Code 39 Check Digit	Disable		
Code 39 Full ASCII Conversion	Disable		
Buffer Code 39	Disable		
Code 93			
Code 93	Enable		
Set Length(s) for Code 93	4 to 55		

The reader supports some user-defined functions as introduced below.

For more details, please contact the SYMBOL reader agents or Mindray Customer Service Department.

Volume setting

Scan the following barcode to set the volume parameter.

- Low Volume:



Low Volume

- Medium Volume:



Medium Volume

- High Volume:



High Volume

Code 93 and codebar scanning

- To enable or disable Code 93, scan the appropriate barcode below.



Enable Code 93

- To enable Codebar, scan the appropriate barcode below.



Enable Codebar

Code 39 full ASCII scanning

Code 39 Full ASCII is a variant of Code 39 which pairs characters to encode the full ASCII character set. To enable or disable Code 39 Full ASCII, scan the appropriate barcode below.



Enable Code 39 Full ASCII



Disable Code 39 Full ASCII

I 2 of 5 symbols setting:



I 2 of 5 - One Discrete Length

Select this option to decode only I 2 of 5 symbols containing a selected length. Select the length using the numeric barcodes below. For example, to decode only I 2 of 5 symbols with 8 characters, scan I 2 of 5 - One Discrete Length, then scan 0 followed by 8.



A.1.3 Scanning in Hand-Held Mode

Perform the following procedure:

1. Ensure all connections are secure.
2. Aim the reader at the barcode. Press the trigger.

Ensure the scan line crosses every bar and space of the symbol, see the figure below.

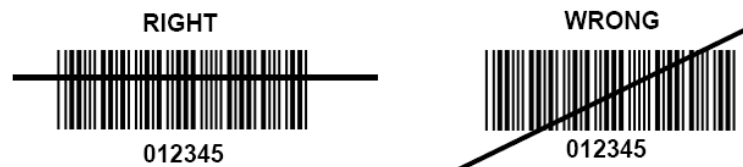

3. Upon successful decode, the reader beeps and the LED turns green.

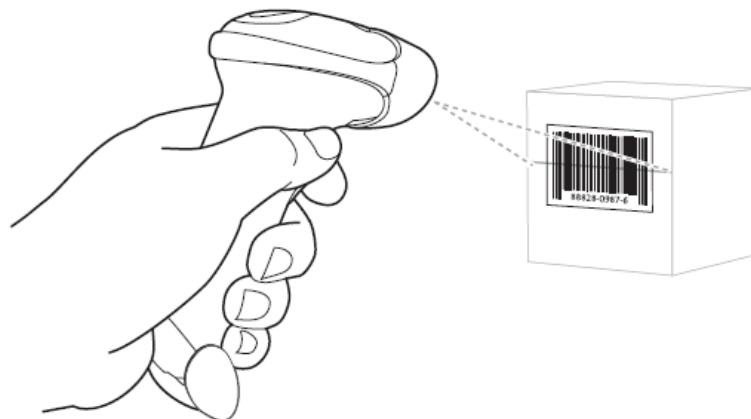

Do not hold the reader directly over the barcode. Laser light reflecting directly back into the reader from the barcode is known as specular reflection. This specular reflection can make decoding difficult. You can tilt the reader up to 55° forward or back and achieve a successful decode.

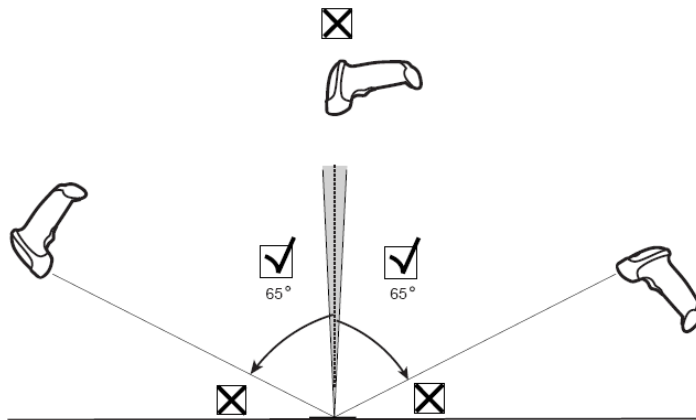

A.1.4 Scanning in Hands-Free Mode

Assembling the Intellistand

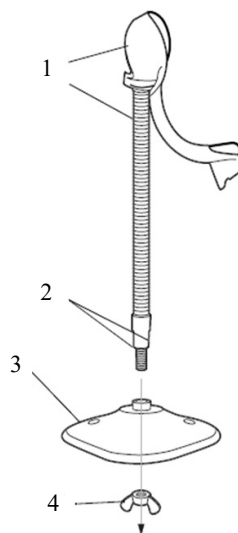

1	One piece scanner “cup” with flexible neck
2	Flat areas
3	Stand base
4	Wingnut

Perform the following procedure:

1. Unscrew the wingnut from the bottom of the one piece scanner “cup”.
2. Fit the bottom of the neck piece into the opening on the top of the stand base.
3. Tighten the wingnut underneath the base to secure the cup and neck piece to the base.

Before tightening the wingnut under the base, ensure that the flat areas on the flexible neck fit securely in the grooves in the base.

4. Bend the neck to the desired position for scanning.

Mounting the Stand (optional)

You can attach the base of the reader's stand to a flat surface using two screws or double-sided tape (not provided).

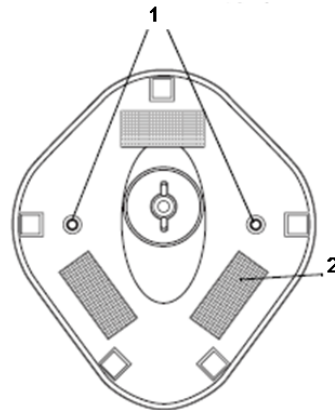

1	Two screw-mount holes	<p>For Screw Mount, follow the steps below:</p> <ol style="list-style-type: none"> 1. Position the assembled base on a flat surface. 2. Screw one #10 wood screw into each screw-mount hole until the base of the stand is secure
2	Double-side tap areas (3 places, dimensions: 1"×2")	<p>For Tape Mount, follow the steps below:</p> <ol style="list-style-type: none"> 1. Peel the paper liner off one side of each piece of tape and place the sticky surface over each of the three rectangular tape holders. 2. Peel the paper liner off the exposed sides of each piece of tape and press the stand on a flat surface until it is secure.

Perform Scanning in Hands-Free Mode

When the reader is seated in the scanner cup, the reader's built-in sensor places the reader in hands-free mode. When you remove the reader from the stand it operates in its normal hand-held mode.

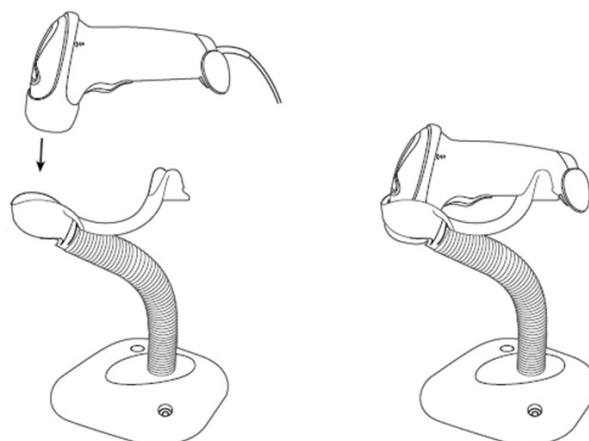

A.2 2D Barcode Reader (Take DS4308 as an example)

SYMBOL DS4308 is classified as “EXEMPT RISK GROUP” according to IEC 62471:2006 and EN 62471:2008.

⚠ WARNING

DO NOT stare into beam emitted by SYMBOL DS4308 for more than 10 s.

The 2-D barcode reader supports hand-held operation mode.

Hand-held mode: press the trigger to decode.

A.2.1 Overview

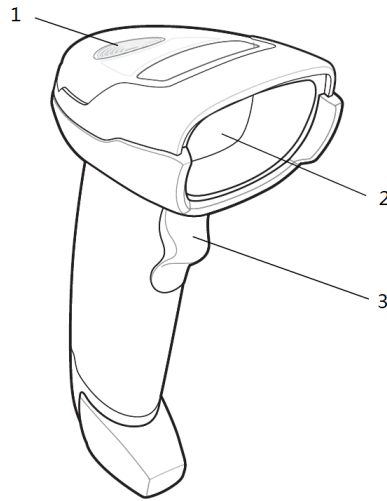

1	LED	<ul style="list-style-type: none">• Green: A barcode was successfully decoded.• Red: A data transmission error or reader malfunction occurred.
2	Scan window	Scan the barcode.
3	Trigger	Press to decode.

A.2.2 Setting Up the Digital Imager Reader

Installing the Interface Cable

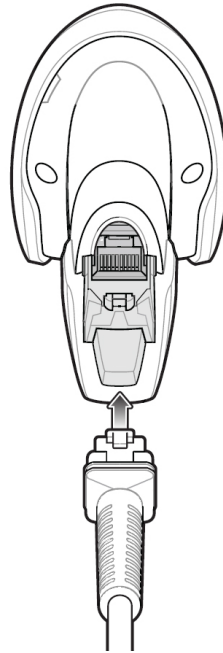

Perform the following procedure:

1. Plug the interface cable modular connector into the cable interface port on the bottom of the reader handle and ensure the connector is properly secure.
2. Connect the other end of the interface cable to the host.

Removing the Interface Cable

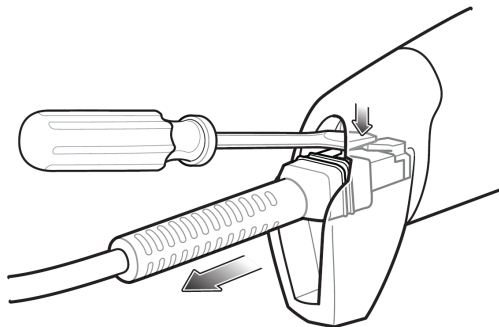

Perform the following procedure:

1. Using the tip of a screwdriver or some other tools with a sharp head, depress the cable's modular connector clip.
2. Carefully slide out the cable.

A.2.3 Setting

The reader has factory settings, refer to the following table for parameter defaults:

Parameter	Defaults	Parameter	Defaults
1-D Symbologies		Interleaved 2 of 5 (ITF)	

Parameter	Defaults	Parameter	Defaults
UPC/EAN		Interleaved 2 of 5 (ITF) Enable	Enable
UPC-A	Enable	Set Lengths for I 2 of 5	14
UPC-E	Enable	I 2 of 5 Check Digit Verification	Disable
UPC-E1	Disable	Transmit I 2 of 5 Check Digit	Disable
EAN-8/JAN 8	Enable	Convert I 2 of 5 to EAN 13	Disable
EAN-13/JAN 13	Enable	Codabar (NW - 7)	
Bookland EAN	Disable	Codabar	Enable
Decode UPC/EAN/JAN Supplementals (2and 5 digits)	Ignore	Set Lengths for Codabar	5 to 55
UPC/EAN/JAN Supplemental Redundancy	10	CLSI Editing	Disable
Transmit UPC-A Check Digit	Enable	NOTIS Editing	Disable
Transmit UPC-E Check Digit	Enable		
Transmit UPC-E1 Check Digit	Enable	2-D Symbologies	
UPC-A Preamble	System Character	PDF417	Enable
UPC-E Preamble	System Character	MicroPDF417	Disable
UPC-E1 Preamble	System Character	Code 128 Emulation	Disable
Convert UPC-E to A	Disable	Data Matrix	Enable
Convert UPC-E1 to A	Disable	Maxicode	Enable
EAN-8/JAN-8 Extend	Disable	QR Code	Enable
UCC Coupon Extended Code	Disable		
Code 128			
Code 128	Enable		
UCC/EAN-128	Enable		
ISBT 128	Enable		
Code 39			
Code 39	Enable		
Trioptic Code 39	Disable		
Convert Code 39 to Code 32 (Italian Pharmacy Code)	Disable		
Code 32 Prefix	Disable		
Set Length(s) for Code 39	2 to 55		
Code 39 Check Digit Verification	Disable		
Transmit Code 39 Check Digit	Disable		
Code 39 Full ASCII Conversion	Disable		

Parameter	Defaults	Parameter	Defaults
Buffer Code 39	Disable		
Code 93			
Code 93	Enable		
Set Length(s) for Code 93	4 to 55		

The reader supports some user-defined functions as introduced below.

For more details, please contact the SYMBOL reader agents or Mindray Customer Service Department.

Volume setting

Scan the following barcode to set the volume parameter.

- Low Volume



Low Volume
(2)

- Medium Volume



Medium Volume
(1)

- High Volume



***High Volume**
(0)

Code 93 and codabar setting

- To enable Code 93, scan the appropriate barcode below.



***Enable Code 93**
(1)

- To enable Codabar, scan the appropriate barcode below



***Enable Codabar
(1)**

Code 39 full ASCII setting

Code 39 Full ASCII is a variant of Code 39 which pairs characters to encode the full ASCII character set. To enable or disable Code 39 Full ASCII, scan the appropriate barcode below.



**Enable Code 39 Full ASCII
(1)**



***Disable Code 39 Full ASCII
(0)**

I 2 of 5 symbols setting



I 2 of 5 - One Discrete Length

Select this option to decode only I 2 of 5 symbols containing a selected length. Select the length using the numeric barcodes below. For example, to decode only I 2 of 5 symbols with 8 characters, scan I 2 of 5 - One Discrete Length, then scan 0 followed by 8.



0



1



2



3



4



5



6



7



A.2.4 Scanning in Hand-Held Mode

Perform the following procedure:

1. Ensure all connections are secure (see the appropriate host chapter.)
2. Aim the digital imager reader at the barcode.

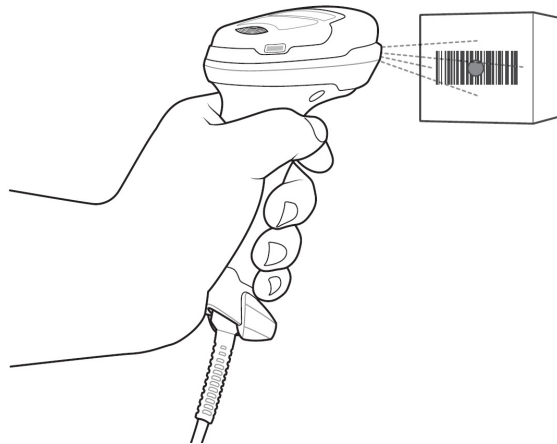

3. When the digital imager reader senses movement, in its default Auto Aim trigger mode, it projects a red LED dot which allows positioning the barcode within the field of view.

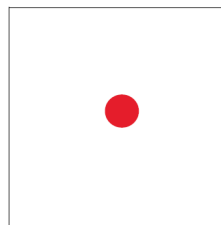

If necessary, the digital imager reader turns on its red LEDs to illuminate the target barcode.

4. Center the symbol. Be sure the entire symbol is within the rectangular area formed by the illumination LEDs.

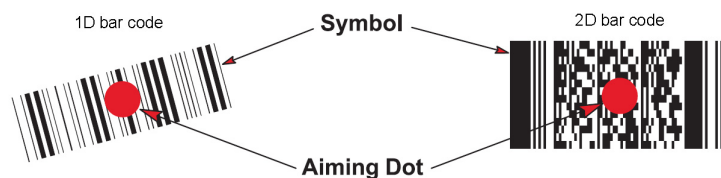

5. Hold the trigger until the digital imager reader beeps, indicating the barcode is successfully decoded.

Steps 2 - 4 above may be required to repeat on poor quality or difficult barcodes.

The aiming pattern is smaller when the digital imager reader is closer to the symbol and larger when it is farther from the symbol. Scan symbols with smaller bars or elements (mil size)

closer to the digital imager reader, and those with larger bars or elements (mil size) farther from the digital imager reader.

The digital imager reader can also read a barcode presented within the aiming dot not centered. The top examples in show acceptable aiming options, while the bottom examples cannot be decoded.

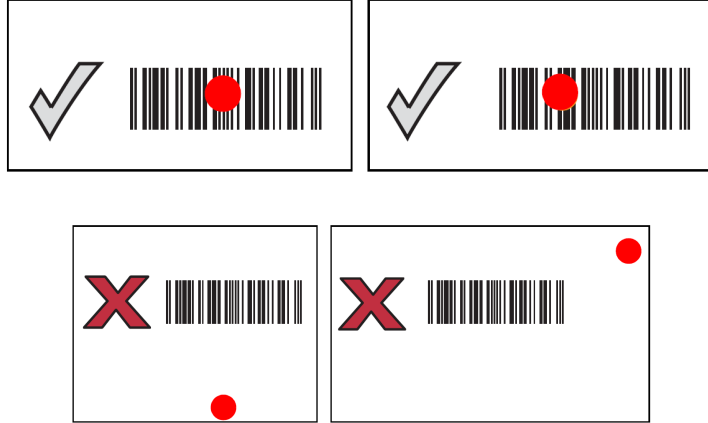

A.3 Maintenance

Cleaning the exit window is the only maintenance required. A dirty window can affect scanning accuracy.

- Do not allow any abrasive material to touch the window.
- Remove any dirt particles with a damp cloth.
- Wipe the window using a tissue moistened with ammonia/water.

Do not spray water or other cleaning liquids directly into the window.

B Wireless LAN

The system provides wireless net adapter configuration, so as to assist information query and unlimited network service. The ultrasound system can be connected to router, mobile phone, tablet, ultrasound workstation, server network device and so on via wireless network.

WARNING

- Use the wireless LAN function prudently in OR/ICU/CCU as it may interfere with other devices.
 - When the wireless LAN function is turned on, the ultrasound system may suffer interference from other equipment, even if that other equipment complies with CISPR EMISSION requirements.
 - Keep at least 20 cm away from the ultrasound system when the wireless LAN function is in use.
-



NOTE:

- For a better wireless LAN transmission effect, please take the following settings:
 - SSID>80% with stable WLAN network;
 - Wireless router and the server are in the same network segment;
 - Router setting:
 - Wireless standard 802.11n
 - Maximum transmission speed $\geq 300\text{M}$
 - Use AP (access point) setting;
 - Number of the devices connected to the same router ≤ 5 .
 - Target server setting:
 - Network is stable and not under overloading state (e.g. high CPU/memory usage, fast HDD speed, limited HDD space);
 - Level other than the highest level of firewall is adopted;
 - Operating system is Win8 or higher versions and supports a Gigabit Ethernet.
 - Disconnection may be caused if the devices connected excess the router capacity (please refer to settings of the router, generally it should be ≤ 5 .)
 - DO NOT connect devices other than specified into the LAN.
 - Medical devices within the same LAN may interfere with each other, the operator should be cautious. (Do not connect devices that may cause strong interference. For example, life-supporting devices should not be connected in the same LAN.)
 - Other non-medical devices in the same frequency band may cause interference, please be cautious.
-

Wi-Fi function is not affected when the system is imposed with radiation interference complied with IEC60601-1-2:2014 standard.

B.1 Use the Wireless feature

Perform the following procedure:

1. Tap  icon to open the wireless network manager.
2. Tap to select the target network, tap [Connect] to connect to the network.
When connecting an encrypted network, enter the password in the box first. You can select to hide password characters or not.
3. The system tries to connect to the selected network. The icon turns into  after successful connection.
4. Tap [Refresh] to refresh the “Wireless Network Connection” list.

B.2 IP Configure

NOTE:

- When the system background is processing network task (DICOM sending for example), please do not enter network setting to change the IP, otherwise the background task may fail. You can check if there are tasks undergoing in the task manager.
 - If the IP address displays as 0.0.0.0, this means that the network is abnormal. The reason for the failure may be disconnection or the system cannot obtain the IP address.
-

IP config is used for setting local network parameters, which is also applied to DICOM connection.

Perform the following procedure:

1. In Wireless network manager screen, tap [IP Config] to open the configuration page.
 - If “DHCP” is selected, the IP address will be automatically obtained from the DNS server. Tap [Refresh] to check current IP address.
 - If “Static” is selected (using a static IP address), enter the IP address.
IP address of the system should be in the same network segment with the server.
Subnet Mask: set different network segment.
Gateway: set the gateway IP.
Host Name: displays the machine name of the system, if changed, the system should be restarted.
2. Tap [Save] to save current setting or tap [Cancel] to exit.

B.3 EAP Network

For setting EAP network, contact Mindray Customer Service Department or the sales representatives.

B.4 Specifications

Table B-1 Wireless specification and technology

Item	Specifications
Standards	IEEE 802.11 b/g/n
Modulation mode	802.11b: DSSS 802.11g/n: OFDM
Operating frequency	2.412-2.472 GHz, 2.484 GHz
Channel spacing	5 MHz
Output power	≤17dbm
Wireless network mode	Infrastructure, ad-hoc

Table B-2 Wireless Quality of Service

Item	Specifications
Data rate	802.11b: up to 11 Mbps @ 2.4 GHz 802.11g: up to 54 Mbps @ 2.4 GHz 802.11n: up to 300 Mbps @ 2.4 GHz and 5 GHz
Data security	WPA2-PSK encryption
Application-layer reliability	Application failure will be notified to the user immediately.
System capacity	No more than one device can be allowed to link to the ultrasound system.
System anti-interference	Can be coexistent with other Wi-Fi devices.
Network interruption alarm	Network interruption is notified by disconnection icon and failure in transmission is notified by the dialog box.
EMC test process	Wi-Fi function is not affected when the system is imposed with radiation interference complied with IEC60601-1-2:2014 standard.

B.5 Troubleshooting

Failure	Measure
Unable to connect the network.	<ul style="list-style-type: none">• Verify that network is available.• The SSID and password of the device should be consistent with those of the wireless AP.• Check for IP address conflict. If yes, set the IP address correctly.• Check if Mindray recommended wireless AP is used. If not, verify the AP effective transmission rate meets the throughput requirements of the connected devices.
The ultrasonic device is frequently off line or disconnects from the network. The transmission delay is too long.	<ul style="list-style-type: none">• Check if Mindray recommended wireless AP is used. If not, verify the AP effective transmission rate meets the throughput requirements of the connected devices.• Verify that no unauthorized devices are connected to the wireless AP.

C Trolley and Accessories

WARNING

- DO NOT connect the trolley to the outlets with the same circuit breakers and fuses that control the current to devices such as life-support systems. If the trolley or the system malfunctions and generates over-current, or when there is an instantaneous current at power ON, the circuit breakers and fuses of the building's supply circuit may be tripped.
 - Be sure to connect the equipotential wire before inserting the power plug into the receptacle; be sure to remove the power plug from the receptacle before disconnecting the equipotential wire; otherwise electric shock may result.
 - When you connect another device to the trolley, you should use the equipotential wire to connect each of equipotential terminals; otherwise electric shock may result.
 - Pay extra attention when moving the system on a sloping ground, do not move it on a more than 10°-sloped plane to avoid system toppling.
 - Connect the earth cable before powering ON. Disconnect the earth cable after powering OFF. Otherwise, electric shock may result.
-

CAUTION

- When moving the trolley with mounted system, please take care of the connector of the power adapter in case of damage.
 - DO NOT insert fingers into the gap next to the plug in case of injury.
-

C.1 Trolley (UMT-400/UMT-400Plus)

C.1.1 Trolley Accessories

- Probe holder
- Storage bin
- Printer tray
- Power cables
- Towelette holster

C.1.2 Introduction of Each Unit (taking UMT-400 as an example)

NOTE:

Retractable cable and telescoping mechanism of the trolley are options before factory. For details, please contact Mindray service engineer.

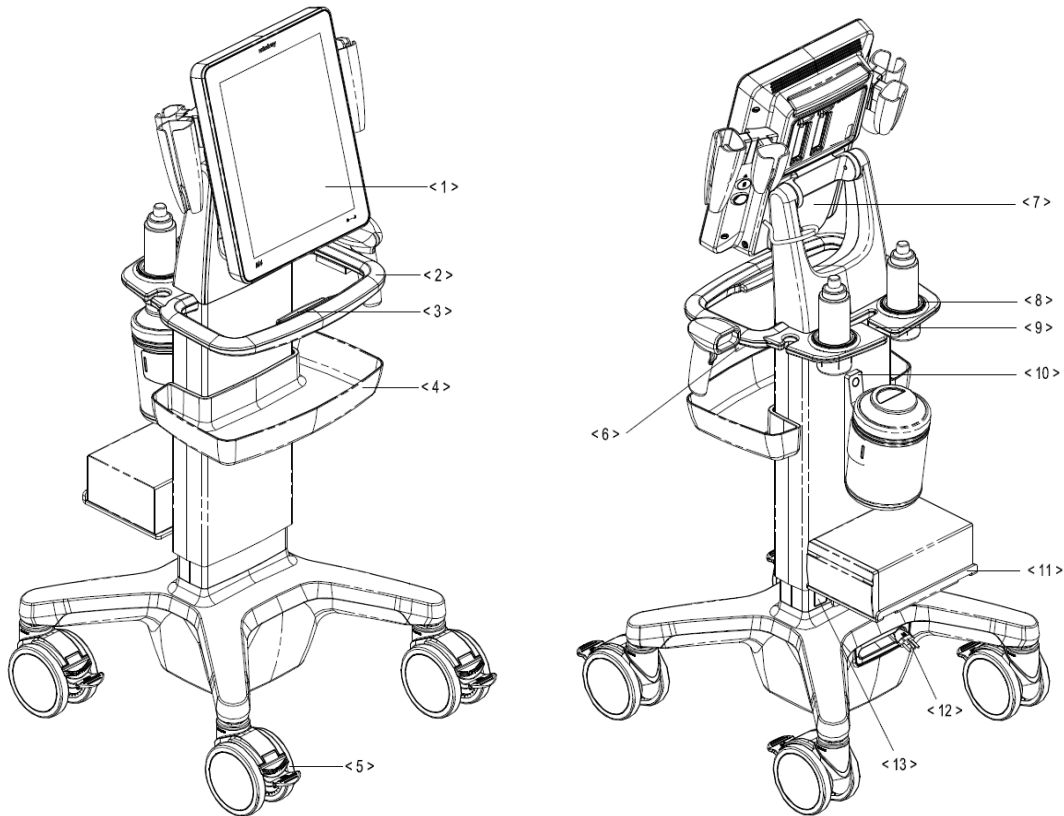

No.	Name	Function
<1>	Main unit of ultrasound system	/
<2>	Trolley handle	Used for ascending/descending the trolley or moving the trolley.
<3>	Height lever	Press to adjust the height of the stand.
<4>	Storage bin	Used for keeping the cases, towelette, etc.
<5>	Caster	Used for securing or moving the system.
<6>	Reader support	Used for placing the barcode reader.
<7>	Main unit support	Used for fixing the ultrasound system.
<8>	Gel holder	Used for placing the gel.
<9>	Cable management slot	Used for organizing the probe cables and peripheral cables.
<10>	Towelette holster	Used for placing the towelette container.

No.	Name	Function
<11>	Printer bracket	Used for placing the printer. NOTE: Use a power cable no less than 1.5 m and no longer than 1.8 m for the printer on the trolley.
<12>	Retractable cable	AC power supply cable.
<13>	Power outlet	Supplies the power for peripheral devices.

C.1.3 Install Towelette Container

Perform the following procedure:

1. Thread the velcro tape through the holes of the towelette holster. Fasten the tape properly.

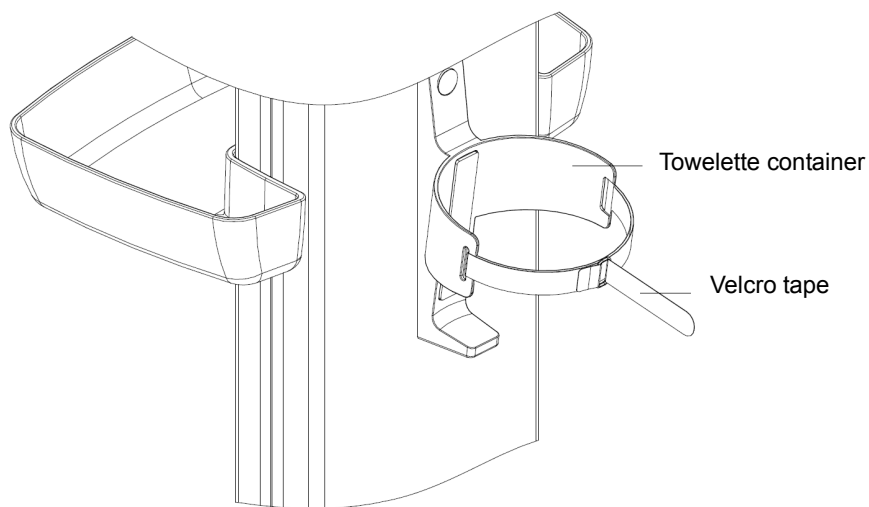

2. Put the container into the holster, and fasten the velcro tape of the towelette container.

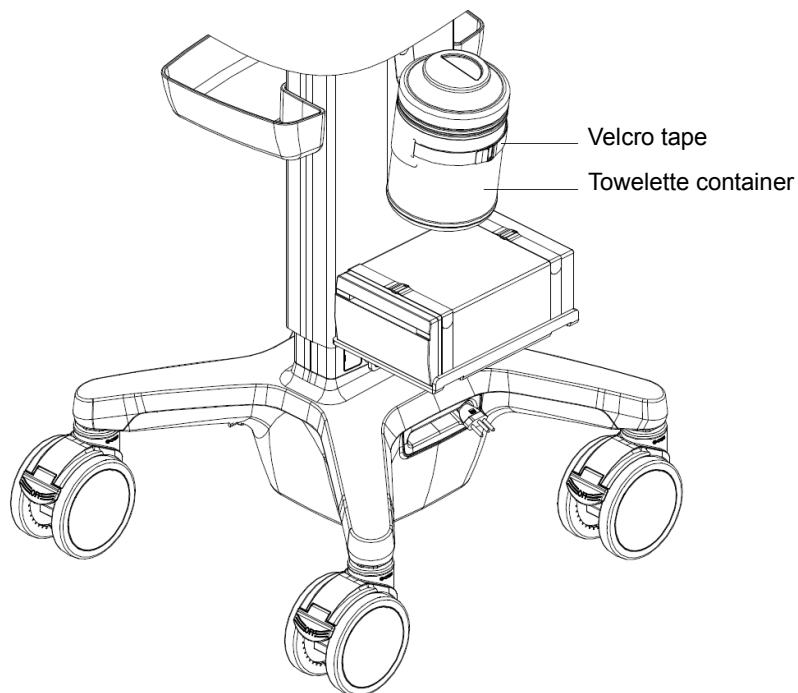

C.2 Table Stand

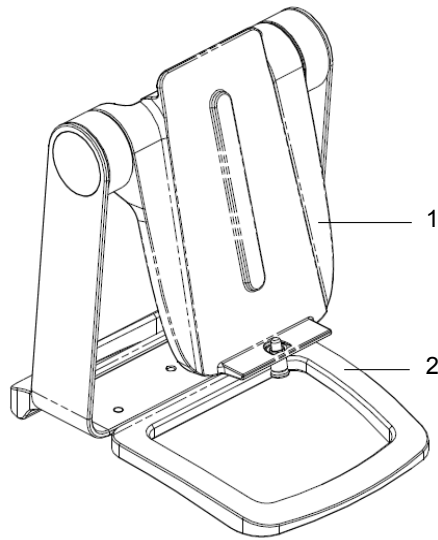

No.	Name	Function
1	Main unit support	Used for fixing the ultrasound system.
2	Base	Used for fixing the main unit support.

C.3 Wall Mount

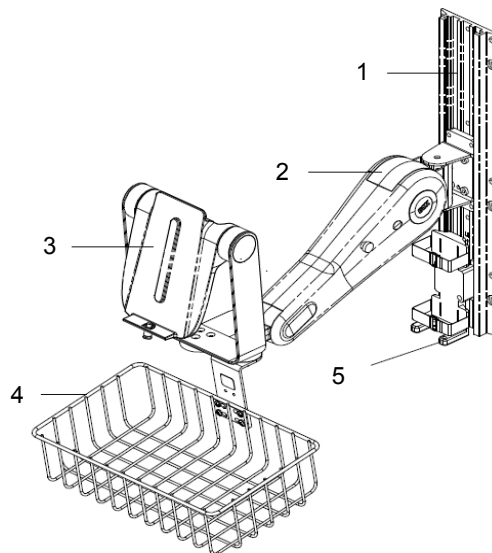

No.	Name	Function
1	Guide way of wall mount	Used for fixing the wall mount.

No.	Name	Function
2	Support arm of wall mount	Used for adjusting the angle of wall mount.
3	Main unit support	Used for fixing the ultrasound system.
4	Storage tray	Used for holding tissue, etc.
5	Adapter holder	Used for fixing the external adapter.

This page intentionally left blank.

D iScanHelper

By providing the referential information, such as, the ultrasonic image, the anatomic graphic, scanning pictures/other scanning tips or diagnosis comments, the system helps the doctors to operate the scanning by iScanHelper. Furthermore, it is a good platform for the self-learning and training of ultrasound scanning technique for doctors. The system also plays a role in the assistant software system in fulfilling training and education.

NOTE:



THIS “iScanHelper” IS FOR REFERENCE OR TUTORIAL PURPOSES ONLY, AND THE MANUFACTURER WILL NOT BE LIABLE FOR DAMAGES AND/OR OTHER UNDESIRABLE CONSEQUENCE IN ANY KIND THAT MAY OCCUR TO THE PATIENT OR THE USERS BY USING THE SOFTWARE.

TIP:

iScanHelper feature is available under abdominal, gynecological, urological, obstetrical, small parts and nerve block area.

D.1 Use iScanHelper for Reference

Perform the following procedure:

1. Perform ordinary scanning procedure.
2. Enter iScanHelper status:
 - For 15-inch screen: tap  in the top-right corner of the screen and tap  [iScanHelper] button.
 - For 21.5-inch screen: tap [iScanHelper] button on the main screen.
3. Select the target view name in the menu and tap to see the details.
4. Swipe the menu to select the view.
5. Perform scanning according to information displayed on the help information area.

You can zoom in a single window in the help information area to see the window more clearly. For details, see “D.3.3 Single/quad-window Display”Single/quad-window Display.
6. Tap [Exit] or [iScanHelper] again to exit.

D.2 Use iScanHelper for Learning or Training

Perform the following procedure:

1. Switch to the exam modes that support iScanHelper.
2. Enter iScanHelper status.
3. Learn and practise views by system defaulted sequence according to the information displayed on help information area; or select unfamiliar views to practise.

You can zoom in a single window in the help information area to see the information. For details, see “D.3.3 Single/quad-window Display”Single/quad-window Display.

4. Tap [Exit] or [iScanHelper] again to exit.

D.3 iScanhelper Menu

iScanHelper information area is displayed on the menu.

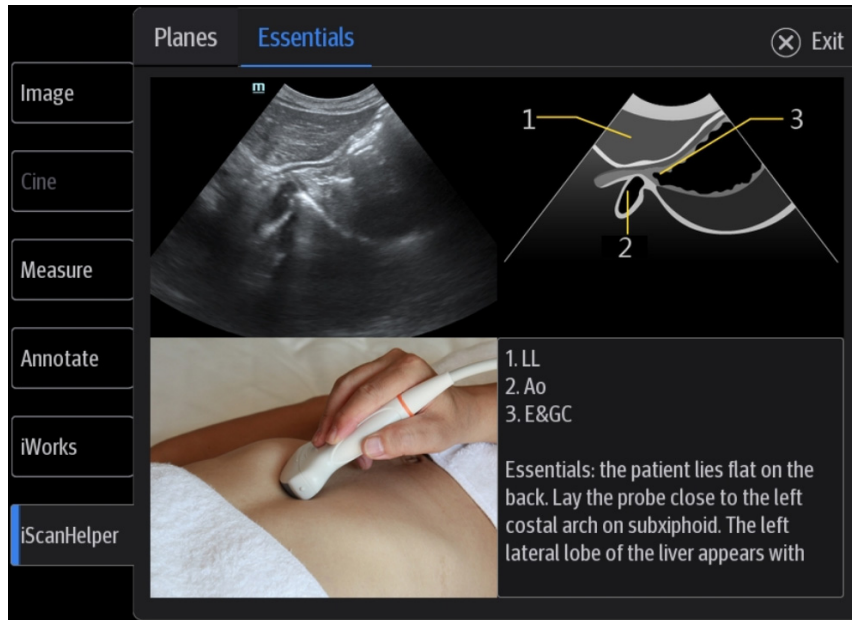

D.3.1 View Selecting Area

Swipe the menu to select target view.

D.3.2 Help Information Area

Ultrasonic image, anatomic graphic, scanning picture and scanning tips are provided in the “View” menu.

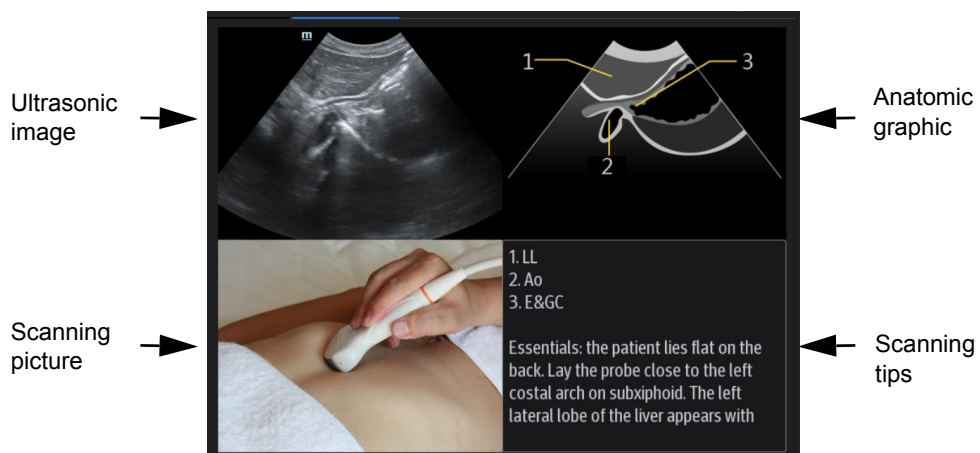

- Ultrasonic image
It is used to compare with images scanned by the operator.
- Anatomic graphic

Related anatomical tissue information are provided here.

- Scanning picture
Ordinary scanning tips can be observed here, including posture, probe mark, probe swing/sweep techniques.
- Scanning tips
You can read tissue related anatomical information and adjacent tissue information here.

D.3.3 Single/quad-window Display

You can zoom in the anatomic graphic, ultrasonic image as well as scanning picture to view those information more conveniently.

Tap on the anatomic graphic, the ultrasonic image or scanning tips to go to the single window of each of them. Tap again to return to quad-window display.

D.4 Measurement, Comments, and Body Mark

Switching probe or exam, measurement, comments and the body mark are available under iScanHelper status.

This page intentionally left blank.

E iVision

The iVision function is used to demonstrate the stored images. Image files are played one by one according to file names (including system-relevant and PC-compatible format images).

Perform the following procedure:

1. Select [Setup] > [System] > [iVision] to enter the iVision setting screen.
2. Add the contents to be played and select demo mode.
 - Demonstration item
Demonstration items are image files in formats supported by the system. You can add exam data from the patient database or system-supported image files and folders to the demonstration list. For files and folders in the demonstration list, the images in the directory and subdirectory are played one by one, and the system will automatically skip files that cannot be opened.
[Add File]: to add files to the file list.
[Delete]: to delete selected files or catalogs from the file list.
[Export]: to export selected directories/files to external storage devices.
 - Interval
The system automatically plays all the image files in the list one by one.
The time interval between images played is the same and can be changed.
 - Repetition
You can choose whether to repeat the demonstration or exit after a demonstration is complete.
 - Exhibition
If the function is enabled, the system will play AVI/MP4 format files automatically.
3. Select an item in the list and tap [Start] (in the bottom-left corner of the screen) to begin the demonstration.
4. Tap [Exit] to exit iVision status.

This page intentionally left blank.

F List of Vocal Commands

The ultrasound system can automatically recognize some vocal commands. You can use a microphone device to input the vocal commands as shown in the following table. After the input command is recognized, the system automatically performs the corresponding operations.

Vocal command	Operation
Hello Mindray	Turn On Audio Control
Turn Off	Turn Off Audio Control
B Mode	Back to B Mode
CDI Mode	Turn on/off CDI Mode
Power Mode	Turn on/off Power Mode
M Mode	Turn on/off M Mode
PW Mode	Turn on/off PW Mode
3D	Turn on/off 3D Mode
Freeze	Freeze Image
UnFreeze	UnFreeze Image
Clear	Clear
Dual	Enter Dual Windows Format
QSave	QSave
Update	Update
Full Image	Turn on/off Full Image Mode
Middle Line	Display/Hide Middle Line
iNeedle	Turn on/off iNeedle Mode
iTouch	Turn on iTouch Mode
Depth Increase	Depth Increase One
Depth Decrease	Depth Decrease One
Focus Position Up	Increase the Focus Position
Focus Position Down	Decrease the Focus Position
Gain Increase	Gain Increase One
Gain Decrease	Gain Decrease One
Gain Auto Increase	Gain Auto Increase
Gain Auto Decrease	Gain Auto Decrease
Gain Stop	Gain Stop Auto Increase/Decrease

Vocal command	Operation
Zoom In	Zoom In Image
Zoom Out	Zoom Out Image
Open Smart Track	Turn on Smart Track Mode
Close Smart Track	Turn off Smart Track Mode
Sound Volume Up	Turn Sound Volume Up
Sound Volume Down	Turn Sound Volume Down
Angle More	Angle More One
Angle Less	Angle Less One
Left Steer	Left Steer the Color ROI or Linear Image
Right Steer	Right Steer the Color ROI or Linear Image
BaseLine Down	Decrease the Baseline Position
BaseLine Up	Increase the Baseline Position
Auto Calculate	Turn on/off Auto Calc Function
Save Image	Save Image
Save Clip	Save Clip
Save Screen	Save Screen
Next Probe	Switch probe to the next in the list
Nerve Block	Switch Exam Mode to Nerve Block
Deep Nerve	Switch Exam Mode to Deep Nerve
Superficial N	Switch Exam Mode to Superficial Nerve
Needle Visualized Optimization	Switch Exam Mode to Needle Visualized Optimization
Emergency Abdomen	Switch Exam Mode to Emergency Abdomen
Emergency FAST	Switch Exam Mode to Emergency Focused Assessment with Sonography for Trauma
Emergency Obstetrics	Switch Exam Mode to Emergency Obstetrics
Emergency Vascular	Switch Exam Mode to Emergency Vascular
Emergency Superficial	Switch Exam Mode to Emergency Superficial
Emergency AAA	Switch Exam Mode to Emergency Abdomen Aorta Aneurysm
Emergency Cardiac	Switch Exam Mode to Emergency Cardiac
Ocular	Switch Exam Mode to Ocular
Adult Cardiac	Switch Exam Mode to Adult Cardiac
Cardiac Difficult	Switch Exam Mode to Adult Cardiac Difficult
Pediatric Cardiac	Switch Exam Mode to Pediatric Cardiac
Lung	Switch Exam Mode to Lung
Intraoperative	Switch Exam Mode to Intraoperative
Musculoskeletal	Switch Exam Mode to Musculoskeletal

Vocal command	Operation
Superficial	Switch Exam Mode to Superficial
Adult Abdomen	Switch Exam Mode to Adult Abdomen
Pediatric Abdomen	Switch Exam Mode to Pediatric Abdomen
Left ventricular opacification	Switch Exam Mode to LVO
TEE Cardiac	Switch Exam Mode to TEE Cardiac
Vascular	Switch Exam Mode to Vascular
Carotid	Switch Exam Mode to Carotid
Transcranial Imaging	Switch Exam Mode to Transcranial Imaging
Urology	Switch Exam Mode to Urology
Thyroid	Switch Exam Mode to Thyroid
Breast	Switch Exam Mode to Breast
Testicle	Switch Exam Mode to Testicle
Orthopedic	Switch Exam Mode to Orthopedic
Neonatal Head	Switch Exam Mode to Neonatal Head
Neonatal Cardiac	Switch Exam Mode to Neonatal Cardiac
Neonatal Abdomen	Switch Exam Mode to Neonatal Abdomen
Gynecology	Switch Exam Mode to Gynecology
1st Trimester	Switch Exam Mode to 1st Trimester
2nd & 3rd Trimester	Switch Exam Mode to 2nd & 3rd Trimester
Open Patient Info Dialog	Open Patient Info Dialog
Close Patient Info Dialog	Close Patient Info Dialog
Open Probe Dialog	Open Probe Dialog
Close Probe Dialog	Close Probe Dialog
Open Review Dialog	Open Review Dialog
Close Review Dialog	Close Review Dialog
Open Report Dialog	Open Report Dialog
Close Report Dialog	Close Report Dialog
Open Preset Dialog	Open Preset Dialog
Close Preset Dialog	Close Preset Dialog
Start Measure	Start Measurement Function

This page intentionally left blank.

G

Electrical Safety Inspection

The following electrical safety tests are recommended as part of a comprehensive preventive maintenance program. They are a proven means of detecting abnormalities that, if undetected, could prove dangerous to either the patient or the operator. Additional tests may be required according to local regulations.

All tests can be performed using commercially-available safety analyzer test equipment. These procedures assume the use of a 601PROXL International Safety Analyzer or equivalent safety analyzer. Other popular testers which comply with IEC 60601-1 and are used in Europe, such as Fluke, Metron or Gerb, may require modifications to the procedure. Follow the analyzer manufacturer's instructions.

An electrical safety inspection should be periodically performed every two years. The safety analyzer is also an excellent troubleshooting tool for detecting abnormalities in line voltage and grounding, as well as total current loads.

NOTE:

Make sure the safety analyzer is authorized and complies with the requirements of IEC 61010-1. Follow the analyzer manufacturer's instructions.

G.1 Power Cord Plug

G.1.1 The Power Plug

Test Item		Acceptance Criteria
The power plug	The power plug pins	No broken or bent pins. No discolored pins.
	The plug body	No physical damage to the plug body.
	The strain relief	No physical damage to the strain relief. No plug warmth when device is in use.
	The power plug	No loose connections.
The power cord		No physical damage to the cord. No deterioration to the cord.
		For devices with detachable power cords, inspect the connection with the device.
		For devices with non-detachable power cords, inspect the strain relief at the device.

G.2 Device Enclosure and Accessories

G.2.1 Visual Inspection

Test Item	Acceptance Criteria
The enclosure and accessories	No physical damage to the enclosure and accessories.
	No physical damage to meters, switches, connectors, etc.
	No residue of fluid spillage (e.g., water, coffee, chemicals, etc.).
	No loose or missing parts (e.g., knobs, dials, terminals, etc.).

G.2.2 Contextual Inspection

Test Item	Acceptance Criteria
The enclosure and accessories	No unusual noises (e.g., rattles inside the case).
	No unusual smells (e.g., burning or smoky smells, particularly from ventilation holes).
	No taped notes that may suggest device deficiencies or operator concerns.

G.3 Device Labeling

Check that the labels provided by the manufacturer or the healthcare facility are present and legible.

- Main unit label
- Integrated warning labels

G.4 Protective Earth Resistance

1. Plug the analyzer probes into the device's protective earth terminal and the protective earth terminal of the AC power cord.
2. Test the earth resistance with a current of 25 A.
3. Verify the resistance is less than the limits.

LIMITS

ALL COUNTRIES $R = 0.2 \Omega$ Maximum

G.5 Earth Leakage Test

Run an Earth Leakage test on the device being tested before performing any other leakage tests.

The following outlet conditions apply when performing the Earth Leakage test.

- normal polarity (Normal Condition);
- reverse polarity (Normal Condition);

- normal polarity with open neutral (Single Fault Condition);
- reverse polarity with open neutral (Single Fault Condition).

LIMITS

- For ES 60601-1:
 - 300 μA in Normal Condition.
 - 1000 μA in Single Fault Condition.
- For IEC 60601-1:
 - 500 μA in Normal Condition.
 - 1000 μA in Single Fault Condition.

G.6 Enclosure Leakage Test

The following outlet conditions apply when performing the Enclosure Leakage test.

- normal polarity (Normal Condition);
- reverse polarity (Normal Condition);
- normal polarity with open neutral (Single Fault Condition);
- reverse polarity with open neutral (Single Fault Condition);
- normal polarity with open earth (Single Fault Condition);
- reverse polarity with open earth (Single Fault Condition).

LIMITS

- For ES 60601-1
 - 100 μA in Normal Condition.
 - 300 μA in Single Fault Condition.
- For IEC 60601-1:
 - 100 μA in Normal Condition.
 - 500 μA in Single Fault Condition.

G.7 Patient Leakage Current

Patient leakage currents are measured between a selected applied part and mains earth. All measurements have a true RMS only.

The following outlet conditions apply when performing the Patient Leakage Current test.

- normal polarity (Normal Condition);
- reverse polarity (Normal Condition);
- normal polarity with open neutral (Single Fault Condition);
- reverse polarity with open neutral (Single Fault Condition).
- normal polarity with open earth (Single Fault Condition);
- reverse polarity with open earth (Single Fault Condition).

LIMITS

For BF  applied parts:

- 100 μA in Normal Condition.
- 500 μA in Single Fault Condition.

G.8 Mains on Applied Part Leakage

The Mains on Applied Part test applies a test voltage, which is 110% of the mains voltage using a limiting resistance, to selected applied part terminals. Current measurements are then taken between the selected applied part and earth. Measurements are taken with the test voltage (110% of mains) on applied parts in the normal and reverse polarity conditions.

The following outlet conditions apply when performing the Mains on Applied Part test.

- Normal Polarity;
- Reversed Polarity.

LIMITS

For BF  applied parts: 5000 μA .

G.9 Patient Auxiliary Current

Patient Auxiliary currents are measured between any selected Applied Part connector and the remaining Applied Part connectors. All measurements may have a true RMS response.

The following outlet conditions apply when performing the Patient Auxiliary Current test.

- normal polarity (Normal Condition);
- reverse polarity (Normal Condition);
- normal polarity with open neutral (Single Fault Condition);
- reverse polarity with open neutral (Single Fault Condition);
- normal polarity with open earth (Single Fault Condition);
- reverse polarity with open earth (Single Fault Condition).

LIMITS

For BF  applied parts,

- 100 μA in Normal Condition.
- 500 μA in Single Fault Condition.

H EMC Guidance and Manufacturer's Declaration

TE7 series complies with the EMC standard IEC 60601-1-2: 2014+A1:2020.

Intended Environments: HOME HEALTHCARE ENVIRONMENT (except for near active HF SURGICAL EQUIPMENT and the RF shielded room of an ME SYSTEM for magnetic resonance imaging).

WARNING

- The use of unapproved accessories may diminish system performance.
- Use of components, accessories, probes, and cables other than those specified may result in increased emission or decreased immunity of system.
- Operation of system, in the case that the patient physiological signal is lower than the minimum amplitude or value specified in the product specifications, results may not be obtained (results can be obtained when the HR is in the range of 30-250 bmp or when the QRS wave amplitude is between 0.5-5 mV.)
- Use of this equipment adjacent to or stacked with other equipment should be avoided because it could result in improper operation. If such use is necessary, this equipment and the other equipment should be observed to verify that they are operating normally.
- Use of accessories, transducers and cables other than those specified or provided by the manufacturer of this equipment could result in increased electromagnetic emissions or decreased electromagnetic immunity of this equipment and result in improper operation.
- Portable RF communications equipment (including peripherals such as antenna cables and external antennas) should be used no closer than 30 cm (12 inches) to any part of the system, including cables specified by the manufacturer. Otherwise, degradation of the performance of this equipment could result.
- Keep a distance of at least 20 cm away from the monitor when WiFi function is in use.
- TE7 series needs special precautions regarding EMC and needs to be installed and put into service according to the EMC information provided below.
- Other devices may interfere with this equipment even though they meet the requirements of CISPR.

- Preventing conducted RF immunity. Due to technological limitations, the conducted RF immunity level are limited to 3Vrms level, conducted RF interference above 3Vrms may cause wrong diagnosis and measurements. We suggest that you position system further from sources of conducted RF noise.
 - Portable and mobile RF communications equipment could affect system. See below tables.
 - TE7 Series should be away from RFID, MRI, diathermy, and electrocautery testing wireless power transfer, 5G cellular and security equipment (such as electromagnetic anti-theft system and metal detector). If the devices are near and are interfered by the concealed and undiscovered RF transmitter (for example, scanning mode changes or image disturbances affecting diagnosis), the user should immediately take mitigation measures, such as redirecting, repositioning or shielding the RF transmitter.
 - This device complies with part 15 of the FCC Rules. Operation is subject to the following two conditions: (1) This device may not cause harmful interference, and (2) this device must accept any interference received, including interference that may cause undesired operation.
 - This equipment has been tested and found to comply with the limits for a Class B digital device, pursuant to part 15 of the FCC Rules. These limits are designed to provide reasonable protection against harmful interference in a residential installation. This equipment generates, uses and can radiate radio frequency energy and, if not installed and used in accordance with the instructions, may cause harmful interference to radio communications. However, there is no guarantee that interference will not occur in a particular installation. If this equipment does cause harmful interference to radio or television reception, which can be determined by turning the equipment off and on, the user is encouraged to try to correct the interference by one or more of the following measures:
 - Reorient or relocate the receiving antenna. Increase the separation between the equipment and receiver.
 - Connect the equipment into an outlet on a circuit different from that to which the receiver is connected.
 - Consult the dealer or an experienced radio/TV technician for help. Any Changes or modifications not expressly approved by the party responsible for compliance could void the user's authority to operate the equipment.The device has been evaluated to meet general RF exposure requirement.
The device can be used in portable exposure condition without restriction
-

If TE7 series is operated within the electromagnetic environment listed in Table H-1, Table H-2, Table H-3, Table H-4, Table H-5, Table H-6 and Table H-7, the TE7 series will remain safe and will provide the following basic performances:

- Imaging;
- Doppler acoustic spectral displaying;
- Taking measurements;
- Patient information;
- Date/time information.

Table H-1

GUIDANCE AND MINDRAY DECLARATION-ELECTROMAGNETIC EMISSIONS		
TE7 series is intended for use in the electromagnetic environment specified below. The customer or the user of system should assure that it is used in such an environment.		
EMISSIONS TEST	COMPLIANCE	ELECTROMAGNETIC ENVIROMENT - GUIDANCE
RF emissions CISPR 11	Group 1	TE7 series uses RF energy only for its internal function. Therefore, its RF emissions are very low and are not likely to cause any interference in nearby electronic equipment.
RF emissions CISPR 11	Class B	TE7 series is suitable for use in all establishments including domestic establishments and those directly connected to the public low-voltage power supply network that supplies buildings used for domestic purposes
Harmonic Emissions IEC 61000-3-2	Class A	
Voltage Fluctuations/ Flicker Emissions IEC 61000-3-3	Compliance	

NOTE: The probes P7-3Ts/P8-3Ts/P8-2Ts/LAP13-4Cs which integrated in TE7 series was declared to the category of CISSPR11 Group1 Class A. The EMISSIONS characteristics of TE7 series make it suitable for use in industrial areas and hospitals (CISPR 11 class A). If it is used in a residential environment (for which CISPR 11 class B is normally required) TE7 series might not offer adequate protection to radio-frequency communication services. The user might need to take mitigation measures, such as relocating or re-orienting the equipment.

Table H-2

GUIDANCE AND MINDRAY DECLARATION-ELECTROMAGNETIC EMISSIONS		
The Probe P7-3Ts/P8-3Ts/P8-2Ts/LAP13-4Cs which integrated in the TE7 series is intended for use in the electromagnetic environment specified below. The customer or the user of system should assure that it is used in such an environment.		
EMISSIONS TEST	COMPLIANCE	ELECTROMAGNETIC ENVIROMENT - GUIDANCE
RF emissions CISPR 11	Group 1	TE7 series uses RF energy only for its internal function. Therefore, its RF emissions are very low and are not likely to cause any interference in nearby electronic equipment.

Table H-2

GUIDANCE AND MINDRAY DECLARATION-ELECTROMAGNETIC EMISSIONS		
The Probe P7-3Ts/P8-3Ts/P8-2Ts/LAP13-4Cs which integrated in the TE7 series is intended for use in the electromagnetic environment specified below. The customer or the user of system should assure that it is used in such an environment.		
EMISSIONS TEST	COMPLIANCE	ELECTROMAGNETIC ENVIRONMENT - GUIDANCE
RF emissions CISPR 11	Class A	TE7 series is suitable for use in all establishments other than domestic and those directly connected to the public low-voltage power supply network that supplies buildings used for domestic purposes
Harmonic Emissions IEC 61000-3-2	Class A	
Voltage Fluctuations/ Flicker Emissions IEC 61000-3-3	Compliance	

Table H-3

GUIDANCE AND MINDRAY DECLARATION-ELECTROMAGNETIC IMMUNITY			
TE7 series is intended for use in the electromagnetic environment specified below. The customer or the user of system should assure that it is used in such an environment.			
IMMUNITY TEST	IEC 60601 TEST LEVEL	COMPLIANCE LEVEL	ELECTROMAGNETIC ENVIRONMENT- GUIDANCE
Electrostatic Discharge (ESD) IEC 61000-4-2	±8 kV contact; ±2 kV, ±4 kV, ±8 kV, ±15 kV air	±8 kV contact; ±2 kV, ±4 kV, ±8 kV, ±15 kV air	Floors should be wood, concrete or ceramic tile. If floors are covered with synthetic material, the relative humidity should be at least 30%.
Electrical fast Transient / burst IEC 61000-4-4	±2 kV for power supply lines; ±1 kV for input/output lines	±2 kV for power supply lines; ±1 kV for input/output lines	Mains power quality should be that of a typical commercial or hospital environment.
Surge IEC 61000-4-5	±0,5 kV, ±1 kV line(s) to line(s); ±0,5 kV, ±1 kV, ±2 kV line(s) to earth	±0,5 kV, ±1 kV line(s) to line(s); ±0,5 kV, ±1 kV, ±2 kV line(s) to earth	Mains power quality should be that of a typical commercial or hospital environment.

Table H-3

GUIDANCE AND MINDRAY DECLARATION-ELECTROMAGNETIC IMMUNITY			
TE7 series is intended for use in the electromagnetic environment specified below. The customer or the user of system should assure that it is used in such an environment.			
IMMUNITY TEST	IEC 60601 TEST LEVEL	COMPLIANCE LEVEL	ELECTROMAGNETIC ENVIRONMENT-GUIDANCE
Voltage dips, Short interruptions and voltage variation on power supply input voltage IEC 61000-4-11	0 % U _T ; 0,5 cycle At 0°, 45°, 90°, 135°, 180°, 225°, 270° and 315° 0 % U _T ; 1 cycle 70% U _T for 25/30 cycle at 0° 0 % U _T ; 250/300 cycle	0 % U _T ; 0,5 cycle At 0°, 45°, 90°, 135°, 180°, 225°, 270° and 315° 0 % U _T ; 1 cycle 70% U _T for 25/30 cycle at 0° 0 % U _T ; 250/300 cycle	Mains power quality should be that of a typical commercial or hospital environment. If you require continued operation during power mains interruptions, it is recommended that our product be powered from an uninterruptible power supply or a battery.
Power frequency (50/60 HZ) magnetic field IEC 61000-4-8	30 A/m	30 A/m	Power frequency magnetic fields should be at levels characteristic of a typical location in a typical commercial or hospital environment.
NOTE: U _T is the A.C. mains voltage prior to application of the test level.			

Table H-4

GUIDANCE AND MINDRAY DECLARATION-ELECTROMAGNETIC IMMUNITY			
TE7 series is intended for use in the electromagnetic environment specified below. The customer or the user of system should assure that it is used in such an environment.			
IMMUNITY TEST	IEC 60601 TEST LEVEL	COMPLIANCE LEVEL	ELECTROMAGNETIC ENVIRONMENT-GUIDANCE
Conducted RF IEC 61000-4-6	3 Vrms 0,15 MHz – 80 MHz 6 Vrms in ISM ^a and amateur radio bands between 0,15 MHz and 80 MHz	3 Vrms 0,15 MHz – 80 MHz 6 Vrms in ISM and amateur radio bands between 0,15 MHz and 80 MHz	Portable and mobile RF communications equipment should be used no closer to any part of system, including cables, than the recommended separation distance calculated from the equation applicable to the frequency of the transmitter. Recommended separation distance $d = 1.2 \times \sqrt{P}$ $d = 2 \times \sqrt{P}$

Table H-4

GUIDANCE AND MINDRAY DECLARATION-ELECTROMAGNETIC IMMUNITY			
TE7 series is intended for use in the electromagnetic environment specified below. The customer or the user of system should assure that it is used in such an environment.			
IMMUNITY TEST	IEC 60601 TEST LEVEL	COMPLIANCE LEVEL	ELECTROMAGNETIC ENVIRONMENT-GUIDANCE
Radiated RF IEC 61000-4-3	10 V/m 80MHz - 2.7GHz	10 V/m 80MHz - 2.7GHz	<p>$d = 1.2 \times \sqrt{P}$ 80 MHz to 800 MHz</p> <p>$d = 2.3 \times \sqrt{P}$ 800 MHz to 2.7GHz</p> <p>Where, P is the maximum output power rating of the transmitter in watts (W) according to the transmitter manufacturer and d is the recommended separation distance in meters (m).</p> <p>Field strengths from fixed RF transmitters, as determined by an electromagnetic site survey^b, should be less than the compliance level in each frequency range^c.</p> <p>Interference may occur in the vicinity of equipment marked with the following symbol:</p> 

Note 1: At 80 MHz and 800 MHz, the higher frequency range applies.

Note 2: These guidelines may not apply in all situations. Electromagnetic propagation is affected by absorption and reflection from structures, objects and people.

a: The ISM (industrial, scientific, and medical) bands between 150 kHz and 80 MHz are 6,765 MHz to 6,795 MHz; 13,553 MHz to 13,567 MHz; 26,957 MHz to 27,283 MHz; and 40,66 MHz to 40,70 MHz. The amateur radio bands between 0,15 MHz and 80 MHz are 1,8 MHz to 2,0 MHz, 3,5 MHz to 4,0 MHz, 5,3 MHz to 5,4 MHz, 7 MHz to 7,3 MHz, 10,1 MHz to 10,15 MHz, 14 MHz to 14,2 MHz, 18,07 MHz to 18,17 MHz, 21,0 MHz to 21,4 MHz, 24,89 MHz to 24,99 MHz, 28,0 MHz to 29,7 MHz and 50,0 MHz to 54,0 MHz.

b: Field strengths from fixed transmitters, such as base stations for radio (cellular/cordless) telephones and land mobile radios, amateur radio, AM and FM radio broadcast and TV broadcast cannot be predicted theoretically with accuracy. To assess the electromagnetic environment due to fixed RF transmitters, an electromagnetic site survey should be considered. If the measured field strength in the location in which the device is used exceeds the applicable RF compliance level above, the device should be observed to verify normal operation. If abnormal performance is observed, additional measures may be necessary, such as re-orienting or relocating the device.

c: Over the frequency range 150 kHz to 80 MHz, field strengths should be less than 3 V/m.

Table H-5

GUIDANCE AND MINDRAY DECLARATION—ELECTROMAGNETIC IMMUNITY			
TE7 series is intended for use in the electromagnetic environment specified below. The customer or the user of system should assure that it is used in such an environment.			
IMMUNITY TEST	IEC 60601 TEST LEVEL	COMPLIANCE LEVEL	ELECTROMAGNETIC ENVIRONMENT – GUIDANCE
Proximity magnetic fields IEC 61000-4-39	8 A/m 30 kHz CW	8 A/m 30 kHz CW	/
	65 A/m 134,2 kHz Pulse modulation 2,1 kHz	65 A/m 134,2 kHz Pulse modulation 2,1 kHz	
	7,5 A/m 13,56 MHz Pulse modulation 50 kHz	7,5 A/m 13,56 MHz Pulse modulation 50 kHz	

Table H-6 Test specifications and minimum distances

Recommended separation distances between portable and mobile RF communications equipment and system						
TE7 series is intended for use in an electromagnetic environment in which radiated RF disturbances are controlled. The customer or the user of system can help prevent electromagnetic interference by maintaining a minimum distance between portable and mobile RF communications equipment (transmitters) and TE7 series as recommended below, according to the maximum output power of the communications equipment. Portable and mobile radio communications equipment (e.g. two-way radio, cellular/ cordless telephones and similar equipment) should be used no closer to any part of this system, including cables, than determined according to the following method:						
Test frequency (MHz)	Band(MHz)	Service	Modulation	Maximum power (W)	Distance (m)	Immunity test level (V/m)
385	380 - 390	TETRA 400	Pulse modulation 18Hz	1.8	0.3	27
450	430 -470	GMRS 460 FRS 460	FM ± 5 kHz deviation 1 kHz sine	2	0.3	28
710	704 - 787	LTE Band 13,17	Pulse modulation 217 Hz	0.2	0.3	9
745						
780						

Recommended separation distances between portable and mobile RF communications equipment and system

TE7 series is intended for use in an electromagnetic environment in which radiated RF disturbances are controlled. The customer or the user of system can help prevent electromagnetic interference by maintaining a minimum distance between portable and mobile RF communications equipment (transmitters) and TE7 series as recommended below, according to the maximum output power of the communications equipment. Portable and mobile radio communications equipment (e.g. two-way radio, cellular/ cordless telephones and similar equipment) should be used no closer to any part of this system, including cables, than determined according to the following method:

Test frequency (MHz)	Band(MHz)	Service	Modulation	Maximum power (W)	Distance (m)	Immunity test level (V/m)
810	800 - 960	GSM 800/900, tetra 800, iDEN 820, CDMA 850, LTE Band 5	Pulse modulation 18 Hz	2	0.3	28
870						
930						
1720	1700 -1990	GSM 1800, CDMA 1900, GSM 1900, DECT, LTE Band 1, 3, 4, 25, UMTS	Pulse modulation 217 Hz	2	0.3	28
1845						
1970						
2450	2400 -2570	Bluetooth, WLAN, 802.11 b/g/n, RFID 2450, LTE Band 7	Pulse modulation 217 Hz	2	0.3	28
5240	5100 -5800	WLAN, 802.11 a/n	Pulse modulation 217 Hz	0.2	0.3	9
5500						
5785						

Table H-7

RECOMMENDED SEPARATION DISTANCES BETWEEN PORTABLE AND MOBILE RF COMMUNICATION DEVICE AND THE SYSTEM				
TE7 series is intended for use in an electromagnetic environment in which radiated RF disturbance are controlled. The customer or the user of system can help prevent electromagnetic interference by maintaining a minimum distance between portable and mobile RF communication equipment (transmitters) and system as recommended below, according to the maximum output power of the communication equipment.				
Rated Maximum Output power of Transmitter (W)	Separation Distance According to Frequency of Transmitter			
	150kHz -80MHz Out ISM and amateur radio bands $d=1.2 \sqrt{P}$	150kHz -80MHz in ISM and amateur radio bands $d=2 \sqrt{P}$	80MHz-800MHz $d=1.2 \sqrt{P}$	800MHz-2.7GHz $d=2.3 \sqrt{P}$
0.01	0.12	0.2	0.12	0.23
0.1	0.38	0.64	0.38	0.73
1	1.2	2	1.2	2.3
10	3.8	6.4	3.8	7.3
100	12	20	12	23

For transmitters at a maximum output power not listed above, the recommended separation distanced in meters (m) can be determined using the equation applicable to the frequency of the transmitter, where P is the maximum output power rating of the transmitter in watts (W) according to the transmitter manufacturer.

If system image distortion occurs, it may be necessary to position system further from sources of conducted RF noise or to install external power source filter to minimize RF noise to an acceptable level.

Note 1: At 80 MHz and 800 MHz, the higher frequency range applies.

Note 2: These guidelines may not apply in all situations. Electromagnetic propagation is affected by absorption and reflection from structures, objects and people.

Table H-8

No.	Name	Cable length (m)	Shield or not	Remarks
1	Power input	2.5 m	Not shielded	/
2	SIP/SOP	< 3.0 m	Shielded	/
3	ECG cable	4.0 m	Shielded	/
4	Probe Cable	< 3.0 m	Shielded	/
5	Footswitch Cable	2.9 m	Shielded	/

Radio Regulatory Compliance

RF parameter

Features	2.4GHz	5GHz
Frequency Range	2.412 ~ 2.472 GHz	5.180 ~ 5.825 GHz

Modulation	DSSS and OFDM	OFDM
Output Power	≤20dBm	

NOTE:

Keep a distance of at least 20cm away from the monitor when Wi-Fi function is in use.

Acoustic Output

This section of the operator's manual applies to the overall system including the main unit, probes, accessories and peripherals. This section contains important safety information for operators of the device, pertaining to acoustic output and how to control patient exposure through use of the ALARA (as low as reasonably achievable) principle. Also this section contains information regarding the acoustic output testing and the real-time output display.

Read this information carefully before using the system.

I.1 Concerns with Bioeffects

Diagnostic ultrasound is recognized as being safe. In fact, there have been no reports of injuries to patients caused by diagnostic ultrasound.

It cannot be stated categorically that ultrasound is 100% safe. Studies have revealed that ultrasound with extremely high intensity is harmful to body tissues.

Diagnostic ultrasound technology has made a great leap forward during the last several years. This rapid advance has generated concerns about the potential risk of bioeffects when new applications or diagnostic technologies become available.

I.2 Prudent Use Statement

Although there are no confirmed biological effects on patients caused by exposures from present diagnostic ultrasound instruments, the possibility exists that such biological effects may be identified in the future. Thus ultrasound should be used in a prudent manner to provide medical benefit to the patient. High exposure levels and long exposure times should be avoided while acquiring necessary clinical information.

I.3 ALARA Principle (As Low As Reasonably Achievable)

It is required to practice ALARA when using ultrasound energy. Practicing ALARA ensures that the total energy level is controlled below a low enough level at which bioeffects are not generated while diagnostic information is being accumulated. The total energy is controlled by output intensity and total radiation time. The output intensity necessary for examinations differs depending on the patient and the clinical case.

Not all examinations can be performed with an extremely low level of acoustic energy. Controlling the acoustic level at an extremely low level leads to low-quality images or insufficient Doppler signals, adversely affecting the reliability of the diagnosis. However, increasing the acoustic power more than necessary does not always contribute to an increase in quality of information required for diagnosis, rather increasing the risk of generating bioeffects.

Users must take responsibility for the safety of patients and utilize ultrasound deliberately. Deliberate use of ultrasound means that output power of ultrasound must be selected based on ALARA.

Additional information regarding the concept of ALARA and the possible bioeffects of Ultrasound is available in a document from the AIUM (American Institute of Ultrasound Medicine) title “Medical Ultrasound Safety”.

I.4 MI/TI Explanation

I.4.1 Basic Knowledge of MI and TI

Mechanical Bioeffect and Thermal Bioeffect

The relationship of various ultrasound output parameters (frequency, acoustic pressure and intensity, etc.) to bioeffects is not fully understood presently. It is recognized that two fundamental mechanisms may induce bioeffects. One is a thermal bioeffect with tissue absorption of ultrasound, and another one is a mechanical bioeffect based on cavitations. Thermal Index (TI) gives the relative index of temperature increase by thermal bioeffect, and Mechanical Index (MI) gives the relative index of mechanical bioeffect. TI and MI indices reflect instantaneous output conditions, so they DO NOT consider the cumulative effects of the total examination time. TI and MI models contain practical simplifications to complex bioeffects interaction. Then the operator should be aware that the actual worst case temperature rise may be up to several times higher than the displayed TI value.

MI (Mechanical Index)

The mechanical bioeffects are the result of compression and decompression of insonated tissues with the formation of micro bubbles that may be referred to as cavitations.

MI is an index that shows the possibility of the cavitations generation based on acoustic pressure, and the value in which the peak-rarefactional acoustic pressure is divided by the square root of the frequency. Therefore MI value becomes smaller when the frequency is higher or the peak-rarefactional acoustic pressure is lower, it becomes difficult to generate the cavitations.

$$MI = \frac{P_{r, \alpha}}{\sqrt{f_{awf}} \times C_{MI}}$$

$$C_{MI} = 1 \text{ (MPa} / \sqrt{\text{MHz}})$$

For the frequency 1 MHz and the peak rarefactional acoustic pressure 1 MPa, MI becomes 1. It is possible to think MI to be one threshold of the cavitations generation. Especially, it is important to keep MI value to be low when both gases and the soft tissues exist together, for such as lung exposure in cardiac scanning and bowel gas in abdominal scanning.

TI (Thermal Index)

TI is determined by the ratio of the total acoustic power to the acoustic power required to raise the tissue temperature by 1 degree C. In addition, because the temperature rises is greatly different according to tissue structures, TI is divided three kinds: TIS (Soft-tissue Thermal Index), TIB (Bone Thermal Index) and TIC (Cranial-bone Thermal Index).

- TIS: Thermal index related to soft tissues, such as abdominal and cardiac applications.
- TIB: Thermal index for applications, such as fetal (second and third trimester) or neonatal cephalic (through the fontanel), in which the ultrasound beam passes through soft tissue and a focal region is in the immediate vicinity of bone.
- TIC: Thermal index for applications, such as pediatric and adult cranial applications, in which the ultrasound beam passes through bone near the beam entrance into the body.

Although the output power is automatically controlled for the selected applications, high TI values should be kept to a minimum or avoided in obstetric applications. WFUMB (World Federation for Ultrasound in Medicine and Biology) guidelines: state that temperature increase of 4 degree C for 5 min or more should be considered as potentially hazardous to embryonic and fetal tissue.

The smaller the MI/TI values, the lower the bioeffects.

I.4.2 MI/TI Display

TI and MI values are displayed in the upper part of the screen in real-time. The operator should monitor these index values during examinations and ensure that exposure time and output values are maintained at the minimum amounts needed for effective diagnosis.

NOTE:

If there is a value of MI or TI exceeds 1.0, you must be careful to practice the ALARA principle.

The display precision is 0.1.

Real-time Display accuracy: MI within $\pm 28.5\%$, TI within $\pm 38.7\%$

I.5 Acoustic Power Setting

Acoustic power adjustment

Use the [A.power] to adjust the acoustic power percentage, and its value is displayed on the corresponding item, as well as at the top of the screen. The greater the acoustic power percentage, the greater the current acoustic output. When the image is frozen, the system stops transmitting acoustic power.

Default setting of acoustic power

Selection of diagnostic applications is the most important factor for controlling ultrasound output. The permissible level of intensity of ultrasound differs depending on the region of interest. For fetal examinations, in particular, much care must be exercised.

In this system, imaging setups can be created using the ultrasound output set by you.

Once you perform preset settings, default setting values of the system may be changed and invalid. It is the user's responsibility for any change to the default settings.

Adjusting range

Initial power: 3.2% to 100%*

Definition of 100%: The maximum acoustic power of a probe determined by the increase in probe surface temperature in the selected mode and the acoustic power restrictions specified by the FDA.

Default settings of acoustic power value refer to the best image quality of the probe. The larger the acoustic power value, the better the image quality.

In the product, to obtain optimum images for applications under the requirements of safety and ALARA principle, we set acoustic power default values in factory to be maximum 96.6% in all exam modes for a better image quality. The user can make adjustments according to the imaging effect in practical use.

NOTE:

This system automatically returns to the settings whenever changes are made to the values (when you turn on the power, switch between probes, end the exam, or select OK or Cancel in

the Setup menu). In the factory default settings, the Acoustic Output is limited below 100%. Following the ALARA restriction, you are allowed to increase the acoustic power under FDA 510 (k) Guidance-Track 3 limits and to set it in the image preset screen.

The acoustic output of the system has been measured and calculated in accordance with IEC60601-2-37: 2015, FDA 510(K) GUIDANCE, IEC 62359: 2017, Ultrasonics-Field characterization-Test methods for the determination of thermal and mechanical indices related to medical diagnostic ultrasonic fields.

I.6 Acoustic Power Control

The qualified operator may use the system controls to limit the ultrasound output and to adjust the quality of the images. There are three categories of system controls relative to output. They are,

- Controls that have direct effect on the output
- Controls that indirectly control output
- Controls that are receiver controls

Direct controls

It is possible to control, if necessary, the acoustic output with the “A.power” item. In this case, the maximum value of the acoustic output never exceeds an MI of 1.9 and an $I_{SPTA,3}$ of 720 mW/cm² in any mode of operation.

Indirect controls

The controls that indirectly affect output are the many imaging parameters. These are operating modes, frequency, focal point positions, overall depth, and PRF.

The operating mode determines whether the ultrasound beam is scanning or non-scanning. Thermal bioeffect is closely connected to M mode, Doppler and Color mode. Acoustic attenuation of tissue is directly related to probe frequency. The focal point is related to active aperture of probe and beam width. For the higher PRF (pulse repetition frequency), the more output pulses occur over a period of time.

Receiver controls

The receiver controls (for example, gain, dynamic range, and image post-processing, etc.) won't affect output. These controls should be used, when possible, to improve the image quality before using controls that directly or indirectly affect output.

I.7 Acoustic Output

I.7.1 Derated Ultrasonic Output Parameters

In order to determine the relevant Ultrasonic Output Parameters, a method is used which allows for the comparison of ultrasound systems which operate at different frequencies and are focused at different depths. This approach, called “derating” or “attenuating”, adjusts the acoustic output as measured in a water tank to account for the effect of ultrasound propagation through tissue. By convention, a specific average intensity attenuation value is used, which corresponds to a loss of 0.3 dB/cm/MHz. That is, the intensity of ultrasound will be reduced by 0.3 dB/MHz for every centimeter of travel from the probe. This can be expressed by the following equation:

$$I_{atten} = I_{water} \times 10^{((-0.3)/10 \times f_c \times z)}$$

Where I_{atten} is the attenuated intensity, I_{water} is the intensity measured in a water tank (at distance z), f_c is the center frequency of the ultrasound wave (as measured in water), and z is the distance from the probe. The equation for attenuating pressure values is similar except that the attenuation coefficient is 0.15 dB/cm/MHz, or one-half the intensity coefficient. The intensity coefficient is double the pressure coefficient because intensity is proportional to the square of pressure.

Although the attenuation coefficient chosen, 0.3 dB/cm/MHz, is significantly lower than any specific solid tissue in the body, this value was chosen to account for fetal examinations. In early trimester ultrasound fetal examinations, there may be a significant fluid path between the probe and the fetus, and the attenuation of fluid is very small. Therefore the attenuation coefficient was lowered to account for this case.

I.7.2 Limits of Acoustic Output

In accordance with the FDA Track 3 requirements, the derating (or attenuated) approach was incorporated into the FDA Acoustic Output Limits, as listed below. The maximum acoustic output level from any probe in any operating mode is expected to fall below these limits.

FDA Maximum Acoustic Output Limits for Track 3 (Attenuated Values)

Application: Regions (except eyes)	$I_{\text{spta.3}} \text{ (mW/cm}^2\text{)} \leq 720$	$I_{\text{sppa.3}} \text{ (W/cm}^2\text{)} \leq 190$ or $\text{MI} \leq 1.9$
Application: Ophthalmic	$I_{\text{spta.3}} \text{ (mW/cm}^2\text{)} \leq 50$	$\text{MI} \leq 0.23$

I.7.3 Differences between Actual and Displayed MI and TI

In operation, the system will display to the operator the Acoustic Output Parameters Thermal Index, TI, or Mechanical Index, MI (or sometimes both parameters simultaneously). These parameters were developed as general indicators of risk from either thermal or mechanical action of the ultrasound wave. They serve to indicate to the operator whether a particular setting of the system increases or decreases the possibility of Thermal or Mechanical effect. More specifically, they were designed to assist in the implementation of the ALARA principle. As an operator changes a given system control, the potential effect of the change in output will be indicated. However, the Thermal Index is not the same as temperature rise in the body, for several reasons. First of all, in order to provide a single display index to you, a number of simplifying assumptions had to be made. The biggest assumption was the use of the attenuating formula described above, which is much lower than the actual value for most tissues within the body. Scanning through muscle or organ tissue, for example, will produce much higher attenuation than 0.3 dB/cm/MHz. There were also significant simplifications made for the thermal properties of tissue. Therefore, scanning through highly perfused tissue, such as the heart or vasculature, will produce significantly less thermal effect than that suggested by the Thermal Index.

Similarly, the Mechanical Index was derived to indicate the relative possibility of mechanical (cavitation) effects. The MI is based on the derated peak-rarefactional pressure and the center frequency of the ultrasound wave. The actual peak-rarefactional pressure is affected by the actual attenuation caused by tissue in the path between the probe and the focal point. Again, all solid tissues within the body have higher attenuation than the prescribed 0.3 dB/cm/MHz value, and therefore, the actual peak-rarefactional pressure will be lower. Further, the actual peak-rarefactional pressure will change depending upon the region of the body being scanned.

For these reasons, the TI and MI displays should only be used to assist the operator in implementing ALARA at the time of the patient examination.

I.8 Measurement Uncertainty

The total estimated measurement uncertainty (where the total uncertainty includes the uncertainties in hydrophone response, measurement, calculation, and positioning) are:

Acoustic Quantities	Total Uncertainties (Standard)
Power	26.48% for non-scan modes; 6.03% for scan modes.
Frequency	0.22%
Pressure	13.01%
Ita	26.48% for non-scan modes; 26.95% for scan modes.
Ipa	26.5%
Mechanical Index	13.01%
Total Uncertainty for TIS	26.48% for non-scan modes; 6.03% for scan modes.
Total Uncertainty for TIB	26.48% or 18.72% for non-scan modes; 6.03% for scan modes.
Total Uncertainty for TIC	26.48% for non-scan modes; 6.03% for scan modes.

I.9 References for Acoustic Power and Safety

- “Bioeffects and Safety of Diagnostic Ultrasound” issued by AIUM in 1993
- “Medical Ultrasound Safety” issued by AIUM in 1994
- Marketing Clearance of Diagnostic Ultrasound Systems and Transducers, June 27, 2019. Center for Devices and Radiological Health.
- Medical electrical equipment-Part 2-37: Particular requirements for the basic safety and essential performance of ultrasonic medical diagnostic and monitoring equipment issued by IEC in 2015
- IEC 62359, Ultrasonics-Field characterization-Test methods for the determination of thermal and mechanical indices related to medical diagnostic ultrasonic fields, 2017.

J

Probe Dimensions

Model	Length (mm)	Width (mm)	Height (mm)	Cable Length (mm)
C5-1s	111.9	76.7	28	2050±50
L12-4s	101.6	61	25.7	2050±50
P10-4s	82.5	28.5	21.2	2050±50
P7-3Ts	1500	59.6	59.1	1530±50
L14-6Ns	101.6	61	25.7	2050±50
V11-3Ws	320.5	41.5	32.5	2050±50
C11-3s	96.4	32.8	25	2050±50
SP5-1s	102.6	38.2	30.4	2050±50
P7-3s	79	34	25.3	1630±50
P8-3Ts	720	63	67.8	1770±50
L20-5s	98	43	24.1	2050±50
SC6-1s	111.9	76.7	28	2050±50
L14-5sp	95.1	70.8	25.4	2350±50
L9-3s	103.5	58.6	23.3	2050±50
P8-2Ts	1417.5	61.8	60.7	1800±50
LAP13-4Cs	560	66.5	51	2050±50
C5-2s	112.4	76.3	25.6	2050±50
C9-3Ts	44.5	46	37.3	2525±50
SP5-1Ns	102.6	38.1	30.4	2050±50
SC5-1Ns	111.9	76.7	28	2050±50
L12-3VNs	101.8	56.8	25.3	2050±50
L12-3RCs	101.9	55.6	22	2050±50
L14-5Ws	98	66.4	25.6	2050±50
7LT4s	50	49.1	20.4	2050±50
C4-1s	98.1	45.8	25.4	2050±50
L11-3VNs	103.4	56.9	24	2050±50
L7-3s	101.6	61	25.7	2050±50
L14-6s	93.8	47.1	22.8	2050±50
P4-2s	102.6	38.1	30.4	2050±50

Model	Length (mm)	Width (mm)	Height (mm)	Cable Length (mm)
L14-5sp	95.1	70.8	25.4	2350±50
6CV1s	318.2	41	32.5	2050±50
7L4s	101.6	61	25.7	2050±50

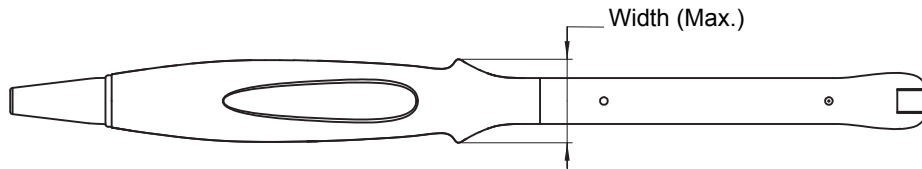
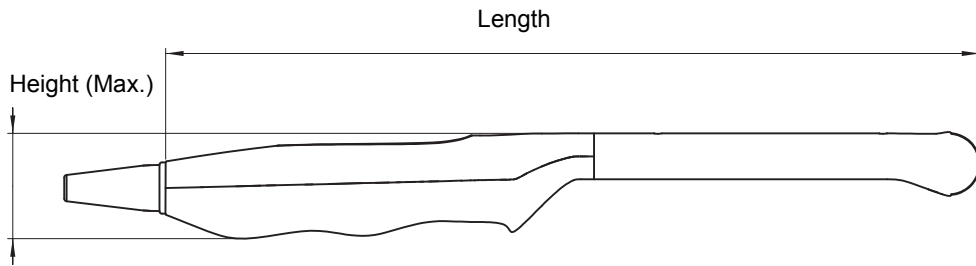

K Indications for use

Transducer:		C11-3s							
Intended Use:		Diagnostic ultrasound imaging or fluid flow analysis of the human body as follows:							
Clinical Application		Mode of Operation							
General (Track 1 Only)	Specific (Track 1 & 3)	B	M	PWD	CWD	Color Doppler	Amplitude Doppler	Combined (specify)	Other (specify)
Ophthalmic	Ophthalmic								
Fetal Imaging & Other	Fetal								
	Abdominal	N	N	N		N	N	N	Note 1,4
	Intra-operative (Specify*)								
	Intra-operative (Neuro)								
	Laparoscopic								
	Pediatric	N	N	N		N	N	N	Note 1,4
	Small Organ (Specify**)								
	Neonatal Cephalic	N	N	N		N	N	N	Note 1,4
	Adult Cephalic								
	Trans-rectal								
	Trans-vaginal								
	Trans-urethral								
	Trans-esoph. (non-Card.)								
	Musculo-skeletal (Conventional)								
	Musculo-skeletal (Superficial)								
	Intravascular								
Thoracic/Pleural (Specify****)	N	N	N		N	N	N	Note 1,4	
Cardiac	Cardiac Adult								
	Cardiac Pediatric	N	N	N		N	N	N	Note 1,4
	Intravascular (Cardiac)								
	Trans-esoph. (Cardiac)								
Peripheral vessel	Intra-cardiac								
	Peripheral vessel	N	N	N		N	N	N	Note 1,4
	Other (Specify***)								
N=new indication ; P=previously cleared by FDA ; E=added under Appendix E									
Additional comments: Combined modes--B+M, PW+B, Color + B, Power + B, PW +Color+ B, Power + PW +B.									
*Intraoperative includes abdominal, thoracic, and vascular etc.									
**Small organ-breast, thyroid, testes.									
***Other use includes Urology.									
****For detection of fluid and pleural motion/sliding.									
Note 1: Tissue Harmonic Imaging. The feature does not use contrast agents.									
Note 2: Contrast imaging (Contrast agent for LVO)									
Note 3: TDI									
Note 4: Color M									
Note 5: Smart 3D									
Note 6: Contrast imaging (Contrast agent for Liver)									
Note 7: iScape View									

K Indications for use

Transducer:	C5-2s								
Intended Use:	Diagnostic ultrasound imaging or fluid flow analysis of the human body as follows:								
	Clinical Application	Mode of Operation							
General (Track 1 Only)	Specific (Track 1 & 3)	B	M	PWD	CWD	Color Doppler	Amplitude Doppler	Combined (specify)	Other (specify)
Ophthalmic	Ophthalmic								
Fetal Imaging & Other	Fetal	N	N	N		N	N	N	Note 1,4
	Abdominal	N	N	N		N	N	N	Note 1,4,6
	Intra-operative (Specify*)								
	Intra-operative (Neuro)								
	Laparoscopic								
	Pediatric	N	N	N		N	N	N	Note 1,4
	Small Organ (Specify**)								
	Neonatal Cephalic								
	Adult Cephalic								
	Trans-rectal								
	Trans-vaginal								
	Trans-urethral								
	Trans-esoph. (non-Card.)								
	Musculo-skeletal (Conventional)								
	Musculo-skeletal (Superficial)								
Intravascular									
Thoracic/Pleural (Specify****)	N	N	N		N	N	N	Note 1,4	
Cardiac	Cardiac Adult								
	Cardiac Pediatric								
	Intravascular (Cardiac)								
	Trans-esoph. (Cardiac)								
	Intra-cardiac								
Peripheral vessel	Peripheral vessel	N	N	N		N	N	N	Note 1,4
	Other (Specify***)								
N=new indication ; P=previously cleared by FDA ; E=added under Appendix E									
Additional comments: Combined modes--B+M, PW+B, Color + B, Power + B, PW +Color+ B, Power + PW +B.									
*Intraoperative includes abdominal, thoracic, and vascular etc.									
**Small organ-breast, thyroid, testes.									
***Other use includes Urology.									
****For detection of fluid and pleural motion/sliding.									
Note 1: Tissue Harmonic Imaging. The feature does not use contrast agents.									
Note 2: Contrast imaging (Contrast agent for LVO)									
Note 3: TDI									
Note 4: Color M									
Note 5: Smart 3D									
Note 6: Contrast imaging (Contrast agent for Liver)									
Note 7: iScape View									

Transducer:		P7-3Ts							
Intended Use:		Diagnostic ultrasound imaging or fluid flow analysis of the human body as follows:							
Clinical Application		Mode of Operation							
General (Track 1 Only)	Specific (Track 1 & 3)	B	M	PWD	CWD	Color Doppler	Amplitude Doppler	Combined (specify)	Other (specify)
Ophthalmic	Ophthalmic								
Fetal Imaging & Other	Fetal								
	Abdominal								
	Intra-operative (Specify*)								
	Intra-operative (Neuro)								
	Laparoscopic								
	Pediatric								
	Small Organ (Specify**)								
	Neonatal Cephalic								
	Adult Cephalic								
	Trans-rectal								
	Trans-vaginal								
	Trans-urethral								
	Trans-esoph. (non-Card.)								
	Musculo-skeletal (Conventional)								
	Musculo-skeletal (Superficial)								
Intravascular									
Thoracic/Pleural (Specify****)									
Cardiac	Cardiac Adult								
	Cardiac Pediatric								
	Intravascular (Cardiac)								
	Trans-esoph. (Cardiac)	N	N	N	N	N	N	N	Note 1,3,4
	Intra-cardiac								
Peripheral vessel	Peripheral vessel								
	Other (Specify***)								
N=new indication ; P=previously cleared by FDA ; E=added under Appendix E									
Additional comments: Combined modes--B+M, PW+B, Color + B, Power + B, PW +Color+ B, Power + PW +B.									
*Intraoperative includes abdominal, thoracic, and vascular etc.									
**Small organ-breast, thyroid, testes.									
***Other use includes Urology.									
****For detection of fluid and pleural motion/sliding.									
Note 1: Tissue Harmonic Imaging. The feature does not use contrast agents.									
Note 2: Contrast imaging (Contrast agent for LVO)									
Note 3: TDI									
Note 4: Color M									
Note 5: Smart 3D									
Note 6: Contrast imaging (Contrast agent for Liver)									
Note 7: iScape View									

K Indications for use

Transducer:	L12-4s								
Intended Use:	Diagnostic ultrasound imaging or fluid flow analysis of the human body as follows:								
	Clinical Application	Mode of Operation							
General (Track 1 Only)	Specific (Track 1 & 3)	B	M	PWD	CWD	Color Doppler	Amplitude Doppler	Combined (specify)	Other (specify)
Ophthalmic	Ophthalmic	N	N	N		N	N	N	Note 1,5
Fetal Imaging & Other	Fetal								
	Abdominal	N	N	N		N	N	N	Note 1,5,7
	Intra-operative (Specify*)								
	Intra-operative (Neuro)								
	Laparoscopic								
	Pediatric	N	N	N		N	N	N	Note 1,5,7
	Small Organ (Specify**)	N	N	N		N	N	N	Note 1,5,7
	Neonatal Cephalic								
	Adult Cephalic								
	Trans-rectal								
	Trans-vaginal								
	Trans-urethral								
	Trans-esoph. (non-Card.)								
	Musculo-skeletal (Conventional)	N	N	N		N	N	N	Note 1,5,7
	Musculo-skeletal (Superficial)	N	N	N		N	N	N	Note 1,5,7
Intravascular									
Thoracic/Pleural (Specify****)	N	N	N		N	N	N	Note 1,5,7	
Cardiac	Cardiac Adult								
	Cardiac Pediatric								
	Intravascular (Cardiac)								
	Trans-esoph. (Cardiac)								
	Intra-cardiac								
Peripheral vessel	Peripheral vessel	N	N	N		N	N	N	Note 1,5,7
	Other (Specify***)								
N=new indication ; P=previously cleared by FDA ; E=added under Appendix E									
Additional comments: Combined modes--B+M, PW+B, Color + B, Power + B, PW +Color+ B, Power + PW +B.									
*Intraoperative includes abdominal, thoracic, and vascular etc.									
**Small organ-breast, thyroid, testes.									
***Other use includes Urology.									
****For detection of fluid and pleural motion/sliding.									
Note 1: Tissue Harmonic Imaging. The feature does not use contrast agents.									
Note 2: Contrast imaging (Contrast agent for LVO)									
Note 3: TDI									
Note 4: Color M									
Note 5: Smart 3D									
Note 6: Contrast imaging (Contrast agent for Liver)									
Note 7: iScape View									

Transducer:	L7-3s								
Intended Use:	Diagnostic ultrasound imaging or fluid flow analysis of the human body as follows:								
	Clinical Application	Mode of Operation							
General (Track 1 Only)	Specific (Track 1 & 3)	B	M	PWD	CWD	Color Doppler	Amplitude Doppler	Combined (specify)	Other (specify)
Ophthalmic	Ophthalmic								
Fetal Imaging & Other	Fetal								
	Abdominal	N	N	N		N	N	N	Note 1,5,7
	Intra-operative (Specify*)								
	Intra-operative (Neuro)								
	Laparoscopic								
	Pediatric	N	N	N		N	N	N	Note 1,5,7
	Small Organ (Specify**)	N	N	N		N	N	N	Note 1,5,7
	Neonatal Cephalic								
	Adult Cephalic								
	Trans-rectal								
	Trans-vaginal								
	Trans-urethral								
	Trans-esoph. (non-Card.)								
	Musculo-skeletal (Conventional)	N	N	N		N	N	N	Note 1,5,7
	Musculo-skeletal (Superficial)	N	N	N		N	N	N	Note 1,5,7
Intravascular									
Thoracic/Pleural (Specify****)	N	N	N		N	N	N	Note 1,5,7	
Cardiac	Cardiac Adult								
	Cardiac Pediatric								
	Intravascular (Cardiac)								
	Trans-esoph. (Cardiac)								
	Intra-cardiac								
Peripheral vessel	Peripheral vessel	N	N	N		N	N	N	Note 1,5,7
	Other (Specify***)								
N=new indication ; P=previously cleared by FDA ; E=added under Appendix E									
Additional comments: Combined modes--B+M, PW+B, Color + B, Power + B, PW +Color+ B, Power + PW +B.									
*Intraoperative includes abdominal, thoracic, and vascular etc.									
**Small organ-breast, thyroid, testes.									
***Other use includes Urology.									
****For detection of fluid and pleural motion/sliding.									
Note 1: Tissue Harmonic Imaging. The feature does not use contrast agents.									
Note 2: Contrast imaging (Contrast agent for LVO)									
Note 3: TDI									
Note 4: Color M									
Note 5: Smart 3D									
Note 6: Contrast imaging (Contrast agent for Liver)									
Note 7: iScape View									

K Indications for use

Transducer:	L14-6s								
Intended Use:	Diagnostic ultrasound imaging or fluid flow analysis of the human body as follows:								
	Clinical Application	Mode of Operation							
General (Track 1 Only)	Specific (Track 1 & 3)	B	M	PWD	CWD	Color Doppler	Amplitude Doppler	Combined (specify)	Other (specify)
Ophthalmic	Ophthalmic								
Fetal Imaging & Other	Fetal								
	Abdominal								
	Intra-operative (Specify*)								
	Intra-operative (Neuro)								
	Laparoscopic								
	Pediatric	N	N	N		N	N	N	Note 1,5,7
	Small Organ (Specify**)	N	N	N		N	N	N	Note 1,5,7
	Neonatal Cephalic	N	N	N		N	N	N	Note 1,5,7
	Adult Cephalic								
	Trans-rectal								
	Trans-vaginal								
	Trans-urethral								
	Trans-esoph. (non-Card.)								
	Musculo-skeletal (Conventional)	N	N	N		N	N	N	Note 1,5,7
	Musculo-skeletal (Superficial)	N	N	N		N	N	N	Note 1,5,7
Intravascular									
Thoracic/Pleural (Specify****)	N	N	N		N	N	N	Note 1,5,7	
Cardiac	Cardiac Adult								
	Cardiac Pediatric								
	Intravascular (Cardiac)								
	Trans-esoph. (Cardiac)								
	Intra-cardiac								
Peripheral vessel	Peripheral vessel	N	N	N		N	N	N	Note 1,5,7
	Other (Specify***)								
N=new indication ; P=previously cleared by FDA ; E=added under Appendix E									
Additional comments: Combined modes--B+M, PW+B, Color + B, Power + B, PW +Color+ B, Power + PW +B.									
*Intraoperative includes abdominal, thoracic, and vascular etc.									
**Small organ-breast, thyroid, testes.									
***Other use includes Urology.									
****For detection of fluid and pleural motion/sliding.									
Note 1: Tissue Harmonic Imaging. The feature does not use contrast agents.									
Note 2: Contrast imaging (Contrast agent for LVO)									
Note 3: TDI									
Note 4: Color M									
Note 5: Smart 3D									
Note 6: Contrast imaging (Contrast agent for Liver)									
Note 7: iScape View									

Transducer:	L14-6Ns								
Intended Use:	Diagnostic ultrasound imaging or fluid flow analysis of the human body as follows:								
	Clinical Application	Mode of Operation							
General (Track 1 Only)	Specific (Track 1 & 3)	B	M	PWD	CWD	Color Doppler	Amplitude Doppler	Combined (specify)	Other (specify)
Ophthalmic	Ophthalmic	N	N	N		N	N	N	Note 1,5
Fetal Imaging & Other	Fetal								
	Abdominal								
	Intra-operative (Specify*)								
	Intra-operative (Neuro)								
	Laparoscopic								
	Pediatric	N	N	N		N	N	N	Note 1,5,7
	Small Organ (Specify**)	N	N	N		N	N	N	Note 1,5,7
	Neonatal Cephalic								
	Adult Cephalic								
	Trans-rectal								
	Trans-vaginal								
	Trans-urethral								
	Trans-esoph. (non-Card.)								
	Musculo-skeletal (Conventional)	N	N	N		N	N	N	Note 1,5,7
	Musculo-skeletal (Superficial)	N	N	N		N	N	N	Note 1,5,7
Intravascular									
Thoracic/Pleural (Specify****)	N	N	N		N	N	N	Note 1,5,7	
Cardiac	Cardiac Adult								
	Cardiac Pediatric								
	Intravascular (Cardiac)								
	Trans-esoph. (Cardiac)								
	Intra-cardiac								
Peripheral vessel	Peripheral vessel	N	N	N		N	N	N	Note 1,5,7
	Other (Specify***)								
N=new indication ; P=previously cleared by FDA ; E=added under Appendix E									
Additional comments: Combined modes--B+M, PW+B, Color + B, Power + B, PW +Color+ B, Power + PW +B.									
*Intraoperative includes abdominal, thoracic, and vascular etc.									
**Small organ-breast, thyroid, testes.									
***Other use includes Urology.									
****For detection of fluid and pleural motion/sliding.									
Note 1: Tissue Harmonic Imaging. The feature does not use contrast agents.									
Note 2: Contrast imaging (Contrast agent for LVO)									
Note 3: TDI									
Note 4: Color M									
Note 5: Smart 3D									
Note 6: Contrast imaging (Contrast agent for Liver)									
Note 7: iScape View									

K Indications for use

Transducer:	P4-2s								
Intended Use:	Diagnostic ultrasound imaging or fluid flow analysis of the human body as follows:								
	Clinical Application	Mode of Operation							
General (Track 1 Only)	Specific (Track 1 & 3)	B	M	PWD	CWD	Color Doppler	Amplitude Doppler	Combined (specify)	Other (specify)
Ophthalmic	Ophthalmic								
Fetal Imaging & Other	Fetal	N	N	N	N	N	N	N	Note 1,4
	Abdominal	N	N	N	N	N	N	N	Note 1,4
	Intra-operative (Specify*)								
	Intra-operative (Neuro)								
	Laparoscopic								
	Pediatric	N	N	N	N	N	N	N	Note 1,4
	Small Organ (Specify**)								
	Neonatal Cephalic	N	N	N	N	N	N	N	Note 1,4
	Adult Cephalic	N	N	N	N	N	N	N	Note 1,4
	Trans-rectal								
	Trans-vaginal								
	Trans-urethral								
	Trans-esoph. (non-Card.)								
	Musculo-skeletal (Conventional)								
	Musculo-skeletal (Superficial)								
	Intravascular								
Thoracic/Pleural (Specify****)	N	N	N			N	N	N	Note 1,4
Cardiac	Cardiac Adult	N	N	N	N	N	N	N	Note 1, 2,3,4
	Cardiac Pediatric	N	N	N	N	N	N	N	Note 1,3,4
	Intravascular (Cardiac)								
	Trans-esoph. (Cardiac)								
	Intra-cardiac								
Peripheral vessel	Peripheral vessel								
	Other (Specify***)								
N=new indication ; P=previously cleared by FDA ; E=added under Appendix E									
Additional comments: Combined modes--B+M、 PW+B、 Color + B、 Power + B、 PW +Color+ B、 Power + PW +B.									
*Intraoperative includes abdominal, thoracic, and vascular etc.									
**Small organ-breast, thyroid, testes.									
***Other use includes Urology.									
****For detection of fluid and pleural motion/sliding.									
Note 1: Tissue Harmonic Imaging. The feature does not use contrast agents.									
Note 2: Contrast imaging (Contrast agent for LVO)									
Note 3: TDI									
Note 4: Color M									
Note 5: Smart 3D									
Note 6: Contrast imaging (Contrast agent for Liver)									
Note 7: iScape View									

Transducer:	V11-3Ws								
Intended Use:	Diagnostic ultrasound imaging or fluid flow analysis of the human body as follows:								
	Clinical Application	Mode of Operation							
General (Track 1 Only)	Specific (Track 1 & 3)	B	M	PWD	CWD	Color Doppler	Amplitude Doppler	Combined (specify)	Other (specify)
Ophthalmic	Ophthalmic								
Fetal Imaging & Other	Fetal	N	N	N		N	N	N	Note 1,4
	Abdominal								
	Intra-operative (Specify*)								
	Intra-operative (Neuro)								
	Laparoscopic								
	Pediatric								
	Small Organ (Specify**)								
	Neonatal Cephalic								
	Adult Cephalic								
	Trans-rectal	N	N	N		N	N	N	Note 1,4
	Trans-vaginal	N	N	N		N	N	N	Note 1,4
	Trans-urethral								
	Trans-esoph. (non-Card.)								
	Musculo-skeletal (Conventional)								
	Musculo-skeletal (Superficial)								
	Intravascular								
Thoracic/Pleural (Specify****)									
Cardiac	Cardiac Adult								
	Cardiac Pediatric								
	Intravascular (Cardiac)								
	Trans-esoph. (Cardiac)								
	Intra-cardiac								
Peripheral vessel	Peripheral vessel								
	Other (Specify***)	N	N	N		N	N	N	Note 1,4
N=new indication ; P=previously cleared by FDA ; E=added under Appendix E									
Additional comments: Combined modes--B+M, PW+B, Color + B, Power + B, PW +Color+ B, Power + PW +B.									
*Intraoperative includes abdominal, thoracic, and vascular etc.									
**Small organ-breast, thyroid, testes.									
***Other use includes Urology.									
****For detection of fluid and pleural motion/sliding.									
Note 1: Tissue Harmonic Imaging. The feature does not use contrast agents.									
Note 2: Contrast imaging (Contrast agent for LVO)									
Note 3: TDI									
Note 4: Color M									
Note 5: Smart 3D									
Note 6: Contrast imaging (Contrast agent for Liver)									
Note 7: iScape View									

K Indications for use

Transducer:	7LT4s								
Intended Use:	Diagnostic ultrasound imaging or fluid flow analysis of the human body as follows:								
	Clinical Application	Mode of Operation							
General (Track 1 Only)	Specific (Track 1 & 3)	B	M	PWD	CWD	Color Doppler	Amplitude Doppler	Combined (specify)	Other (specify)
Ophthalmic	Ophthalmic								
Fetal Imaging & Other	Fetal								
	Abdominal	N	N	N		N	N	N	Note 1,5,7
	Intra-operative (Specify*)	N	N	N		N	N	N	Note 1,5,7
	Intra-operative (Neuro)								
	Laparoscopic								
	Pediatric	N	N	N		N	N	N	Note 1,5,7
	Small Organ (Specify**)	N	N	N		N	N	N	Note 1,5,7
	Neonatal Cephalic	N	N	N		N	N	N	Note 1,5,7
	Adult Cephalic								
	Trans-rectal								
	Trans-vaginal								
	Trans-urethral								
	Trans-esoph. (non-Card.)								
	Musculo-skeletal (Conventional)	N	N	N		N	N	N	Note 1,5,7
	Musculo-skeletal (Superficial)	N	N	N		N	N	N	Note 1,5,7
Intravascular									
Thoracic/Pleural (Specify****)									
Cardiac	Cardiac Adult								
	Cardiac Pediatric								
	Intravascular (Cardiac)								
	Trans-esoph. (Cardiac)								
	Intra-cardiac								
Peripheral vessel	Peripheral vessel	N	N	N		N	N	N	Note 1,5,7
	Other (Specify****)								
N=new indication ; P=previously cleared by FDA ; E=added under Appendix E									
Additional comments: Combined modes--B+M、PW+B、Color + B、Power + B、PW +Color+ B、Power + PW +B.									
*Intraoperative includes abdominal, thoracic, and vascular etc.									
**Small organ-breast, thyroid, testes.									
***Other use includes Urology.									
****For detection of fluid and pleural motion/sliding.									
Note 1: Tissue Harmonic Imaging. The feature does not use contrast agents.									
Note 2: Contrast imaging (Contrast agent for LVO)									
Note 3: TDI									
Note 4: Color M									
Note 5: Smart 3D									
Note 6: Contrast imaging (Contrast agent for Liver)									
Note 7: iScape View									

Transducer:	L14-5sp									
Intended Use:	Diagnostic ultrasound imaging or fluid flow analysis of the human body as follows:									
	Clinical Application	Mode of Operation								
General (Track 1 Only)	Specific (Track 1 & 3)	B	M	PWD	CWD	Color Doppler	Amplitude Doppler	Combined (specify)	Other (specify)	
Ophthalmic	Ophthalmic									
Fetal Imaging & Other	Fetal									
	Abdominal	N	N	N		N	N	N	Note 1,5,7	
	Intra-operative (Specify*)	N	N	N		N	N	N	Note 1,5,7	
	Intra-operative (Neuro)									
	Laparoscopic									
	Pediatric	N	N	N		N	N	N	Note 1,5,7	
	Small Organ (Specify**)	N	N	N		N	N	N	Note 1,5,7	
	Neonatal Cephalic	N	N	N		N	N	N	Note 1,5,7	
	Adult Cephalic									
	Trans-rectal									
	Trans-vaginal									
	Trans-urethral									
	Trans-esoph. (non-Card.)									
	Musculo-skeletal (Conventional)	N	N	N		N	N	N	Note 1,5,7	
	Musculo-skeletal (Superficial)	N	N	N		N	N	N	Note 1,5,7	
	Intravascular									
Thoracic/Pleural (Specify****)										
Cardiac	Cardiac Adult									
	Cardiac Pediatric									
	Intravascular (Cardiac)									
	Trans-esoph. (Cardiac)									
	Intra-cardiac									
Peripheral vessel	Peripheral vessel	N	N	N		N	N	N	Note 1,5,7	
	Other (Specify***)									
N=new indication ; P=previously cleared by FDA ; E=added under Appendix E										
Additional comments: Combined modes--B+M、 PW+B、 Color + B、 Power + B、 PW +Color+ B、 Power + PW +B.										
*Intraoperative includes abdominal, thoracic, and vascular etc.										
**Small organ-breast, thyroid, testes.										
***Other use includes Urology.										
****For detection of fluid and pleural motion/sliding.										
Note 1: Tissue Harmonic Imaging. The feature does not use contrast agents.										
Note 2: Contrast imaging (Contrast agent for LVO)										
Note 3: TDI										
Note 4: Color M										
Note 5: Smart 3D										
Note 6: Contrast imaging (Contrast agent for Liver)										
Note 7: iScape View										

K Indications for use

Transducer:	P10-4s								
Intended Use:	Diagnostic ultrasound imaging or fluid flow analysis of the human body as follows:								
	Clinical Application	Mode of Operation							
General (Track 1 Only)	Specific (Track 1 & 3)	B	M	PWD	CWD	Color Doppler	Amplitude Doppler	Combined (specify)	Other (specify)
Ophthalmic	Ophthalmic								
Fetal Imaging & Other	Fetal								
	Abdominal	N	N	N	N	N	N	N	Note 1,4
	Intra-operative (Specify*)								
	Intra-operative (Neuro)								
	Laparoscopic								
	Pediatric	N	N	N	N	N	N	N	Note 1,4
	Small Organ (Specify**)								
	Neonatal Cephalic	N	N	N	N	N	N	N	Note 1,4
	Adult Cephalic								
	Trans-rectal								
	Trans-vaginal								
	Trans-urethral								
	Trans-esoph. (non-Card.)								
	Musculo-skeletal (Conventional)								
	Musculo-skeletal (Superficial)								
Intravascular									
Thoracic/Pleural (Specify****)									
Cardiac	Cardiac Adult								
	Cardiac Pediatric	N	N	N	N	N	N	N	Note 1, 3,4
	Intravascular (Cardiac)								
	Trans-esoph. (Cardiac)								
Peripheral vessel	Intra-cardiac								
	Peripheral vessel								
	Other (Specify****)								
N=new indication ; P=previously cleared by FDA ; E=added under Appendix E									
Additional comments: Combined modes—B+M、PW+B、Color + B、Power + B、PW +Color+ B、Power + PW +B.									
*Intraoperative includes abdominal, thoracic, and vascular etc.									
**Small organ-breast, thyroid, testes.									
***Other use includes Urology.									
****For detection of fluid and pleural motion/sliding.									
Note 1: Tissue Harmonic Imaging. The feature does not use contrast agents.									
Note 2: Contrast imaging (Contrast agent for LVO)									
Note 3: TDI									
Note 4: Color M									
Note 5: Smart 3D									
Note 6: Contrast imaging (Contrast agent for Liver)									
Note 7: iScape View									

Transducer:	L20-5s								
Intended Use:	Diagnostic ultrasound imaging or fluid flow analysis of the human body as follows:								
	Clinical Application	Mode of Operation							
General (Track 1 Only)	Specific (Track 1 & 3)	B	M	PWD	CWD	Color Doppler	Amplitude Doppler	Combined (specify)	Other (Specify)
Ophthalmic	Ophthalmic	N	N	N		N	N	N	Note 1,5
Fetal Imaging & Other	Fetal								
	Abdominal	N	N	N		N	N	N	Note 1,5,7
	Intra-operative (Specify*)								
	Intra-operative (Neuro)								
	Laparoscopic								
	Pediatric								
	Small Organ (Specify**)	N	N	N		N	N	N	Note 1,5,7
	Neonatal Cephalic								
	Adult Cephalic								
	Trans-rectal								
	Trans-vaginal								
	Trans-urethral								
	Trans-esoph. (non-Card.)								
	Musculo-skeletal (Conventional)	N	N	N		N	N	N	Note 1,5,7
	Musculo-skeletal (Superficial)	N	N	N		N	N	N	Note 1,5,7
Intravascular									
Thoracic/Pleural (Specify****)									
Cardiac	Cardiac Adult								
	Cardiac Pediatric								
	Intravascular (Cardiac)								
	Trans-esoph. (Cardiac)								
	Intra-cardiac								
Peripheral vessel	Peripheral vessel	N	N	N		N	N	N	Note 1,5,7
	Other (Specify***)								
N=new indication ; P=previously cleared by FDA ; E=added under Appendix E									
Additional comments: Combined modes--B+M, PW+B, Color + B, Power + B, PW +Color+ B, Power + PW +B.									
*Intraoperative includes abdominal, thoracic, and vascular.									
**Small organ-breast, thyroid, testes.									
***Other use includes Urology.									
****For detection of fluid and pleural motion/sliding.									
Note 1: Tissue Harmonic Imaging. The feature does not use contrast agents.									
Note 2: Contrast imaging (Contrast agent for LVO)									
Note 3: TDI									
Note 4: Color M									
Note 5: Smart 3D									
Note 6: Contrast imaging (Contrast agent for Liver)									
Note 7: iScape View									

K Indications for use

Transducer:	SC6-1s								
Intended Use:	Diagnostic ultrasound imaging or fluid flow analysis of the human body as follows:								
	Clinical Application	Mode of Operation							
General (Track 1 Only)	Specific (Track 1 & 3)	B	M	PWD	CWD	Color Doppler	Amplitude Doppler	Combined (specify)	Other (specify)
Ophthalmic	Ophthalmic								
Fetal Imaging & Other	Fetal	N	N	N		N	N	N	Note 1,4
	Abdominal	N	N	N		N	N	N	Note 1,4
	Intra-operative (Specify*)								
	Intra-operative (Neuro)								
	Laparoscopic								
	Pediatric	N	N	N		N	N	N	Note 1,4
	Small Organ (Specify**)								
	Neonatal Cephalic								
	Adult Cephalic								
	Trans-rectal								
	Trans-vaginal								
	Trans-urethral								
	Trans-esoph. (non-Card.)								
	Musculo-skeletal (Conventional)	N	N	N		N	N	N	Note 1,4
	Musculo-skeletal (Superficial)								
Intravascular									
Thoracic/Pleural (Specify****)									
Cardiac	Cardiac Adult								
	Cardiac Pediatric								
	Intravascular (Cardiac)								
	Trans-esoph. (Cardiac)								
	Intra-cardiac								
Peripheral vessel	Peripheral vessel	N	N	N		N	N	N	Note 1,4
	Other (Specify***)								
N=new indication ; P=previously cleared by FDA ; E=added under Appendix E									
Additional comments: Combined modes--B+M、PW+B、Color + B、Power + B、PW +Color+ B、Power + PW +B.									
*Intraoperative includes abdominal, thoracic, and vascular etc.									
**Small organ-breast, thyroid, testes.									
***Other use includes Urology.									
****For detection of fluid and pleural motion/sliding.									
Note 1: Tissue Harmonic Imaging. The feature does not use contrast agents.									
Note 2: Contrast imaging (Contrast agent for LVO)									
Note 3: TDI									
Note 4: Color M									
Note 5: Smart 3D									
Note 6: Contrast imaging (Contrast agent for Liver)									
Note 7: iScape View									

Transducer:	SP5-1s								
Intended Use:	Diagnostic ultrasound imaging or fluid flow analysis of the human body as follows:								
	Clinical Application	Mode of Operation							
General (Track 1 Only)	Specific (Track 1 & 3)	B	M	PWD	CWD	Color Doppler	Amplitude Doppler	Combined (specify)	Other (specify)
Ophthalmic	Ophthalmic								
Fetal Imaging & Other	Fetal	N	N	N	N	N	N	N	Note 1,4
	Abdominal	N	N	N	N	N	N	N	Note 1,4
	Intra-operative (Specify*)								
	Intra-operative (Neuro)								
	Laparoscopic								
	Pediatric	N	N	N	N	N	N	N	Note 1,4
	Small Organ (Specify**)								
	Neonatal Cephalic	N	N	N	N	N	N	N	Note 1,4
	Adult Cephalic	N	N	N	N	N	N	N	Note 1,4
	Trans-rectal								
	Trans-vaginal								
	Trans-urethral								
	Trans-esoph. (non-Card.)								
	Musculo-skeletal (Conventional)								
	Musculo-skeletal (Superficial)								
Intravascular									
Thoracic/Pleural (Specify****)	N	N	N			N	N	N	Note 1,4
Cardiac	Cardiac Adult	N	N	N	N	N	N	N	Note 1,2,3,4
	Cardiac Pediatric	N	N	N	N	N	N	N	Note 1,3,4
	Intravascular (Cardiac)								
	Trans-esoph. (Cardiac)								
Peripheral vessel	Intra-cardiac								
	Peripheral vessel								
	Other (Specify***)								
N=new indication ; P=previously cleared by FDA ; E=added under Appendix E									
Additional comments: Combined modes--B+M, PW+B, Color + B, Power + B, PW +Color+ B, Power + PW +B.									
*Intraoperative includes abdominal, thoracic, and vascular etc.									
**Small organ-breast, thyroid, testes.									
***Other use includes Urology.									
****For detection of fluid and pleural motion/sliding.									
Note 1: Tissue Harmonic Imaging. The feature does not use contrast agents.									
Note 2: Contrast imaging (Contrast agent for LVO)									
Note 3: TDI									
Note 4: Color M									
Note 5: Smart 3D									
Note 6: Contrast imaging (Contrast agent for Liver)									
Note 7: iScape View									

K Indications for use

Transducer:	6CV1s								
Intended Use:	Diagnostic ultrasound imaging or fluid flow analysis of the human body as follows:								
Clinical Application	Mode of Operation								
General (Track 1 Only)	Specific (Track 1 & 3)	B	M	PWD	CWD	Color Doppler	Amplitude Doppler	Combined (specify)	Other (Specify)
Ophthalmic	Ophthalmic								
Fetal Imaging & Other	Fetal	N	N	N		N	N	N	Note 1,4
	Abdominal								
	Intra-operative (Specify*)								
	Intra-operative (Neuro)								
	Laparoscopic								
	Pediatric								
	Small Organ (Specify**)								
	Neonatal Cephalic								
	Adult Cephalic								
	Trans-rectal	N	N	N		N	N	N	Note 1,4
	Trans-vaginal	N	N	N		N	N	N	Note 1,4
	Trans-urethral								
	Trans-esoph. (non-Card.)								
	Musculo-skeletal (Conventional)								
	Musculo-skeletal (Superficial)								
Intravascular									
Thoracic/Pleural (Specify****)									
Cardiac	Cardiac Adult								
	Cardiac Pediatric								
	Intravascular (Cardiac)								
	Trans-esoph. (Cardiac)								
	Intra-cardiac								
Peripheral vessel	Peripheral vessel								
	Other (Specify****)	N	N	N		N	N	N	Note 1,4
N=new indication ; P=previously cleared by FDA ; E=added under Appendix E									
Additional comments: Combined modes--B+M、PW+B、Color + B、Power + B、PW +Color+ B、Power + PW +B.									
*Intraoperative includes abdominal, thoracic, and vascular.									
**Small organ-breast, thyroid, testes.									
***Other use includes Urology.									
****For detection of fluid and pleural motion/sliding.									
Note 1: Tissue Harmonic Imaging. The feature does not use contrast agents.									
Note 2: Contrast imaging (Contrast agent for LVO)									
Note 3: TDI									
Note 4: Color M									
Note 5: Smart 3D									
Note 6: Contrast imaging (Contrast agent for Liver)									
Note 7: iScape View									

Transducer:	7L4s									
Intended Use:	Diagnostic ultrasound imaging or fluid flow analysis of the human body as follows:									
Clinical Application		Mode of Operation								
General (Track 1 Only)	Specific (Track 1 & 3)	B	M	PWD	CWD	Color Doppler	Amplitude Doppler	Combined (specify)	Other (Specify)	
Ophthalmic	Ophthalmic									
Fetal Imaging & Other	Fetal									
	Abdominal	N	N	N		N	N	N	Note 1, 5,7	
	Intra-operative (Specify*)									
	Intra-operative (Neuro)									
	Laparoscopic									
	Pediatric	N	N	N		N	N	N	Note 1, 5,7	
	Small Organ (Specify**)	N	N	N		N	N	N	Note 1, 5,7	
	Neonatal Cephalic	N	N	N		N	N	N	Note 1, 5,7	
	Adult Cephalic									
	Trans-rectal									
	Trans-vaginal									
	Trans-urethral									
	Trans-esoph. (non-Card.)									
	Musculo-skeletal (Conventional)	N	N	N		N	N	N	Note 1, 5,7	
	Musculo-skeletal (Superficial)	N	N	N		N	N	N	Note 1, 5,7	
Intravascular										
Thoracic/Pleural (Specify****)										
Cardiac	Cardiac Adult									
	Cardiac Pediatric									
	Intravascular (Cardiac)									
	Trans-esoph. (Cardiac)									
	Intra-cardiac									
Peripheral vessel	Peripheral vessel	N	N	N		N	N	N	Note 1, 5,7	
	Other (Specify***)									
N=new indication ; P=previously cleared by FDA ; E=added under Appendix E										
Additional comments: Combined modes--B+M、 PW+B、 Color + B、 Power + B、 PW +Color+ B、 Power + PW +B.										
*Intraoperative includes abdominal, thoracic, and vascular.										
**Small organ-breast, thyroid, testes.										
***Other use includes Urology.										
****For detection of fluid and pleural motion/sliding.										
Note 1: Tissue Harmonic Imaging. The feature does not use contrast agents.										
Note 2: Contrast imaging (Contrast agent for LVO)										
Note 3: TDI										
Note 4: Color M										
Note 5: Smart 3D										
Note 6: Contrast imaging (Contrast agent for Liver)										
Note 7: iScape View										

K Indications for use

Transducer:		P7-3s							
Intended Use:		Diagnostic ultrasound imaging or fluid flow analysis of the human body as follows:							
Clinical Application		Mode of Operation							
General (Track 1 Only)	Specific (Track 1 & 3)	B	M	PWD	CWD	Color Doppler	Amplitude Doppler	Combined (specify)	Other (specify)
Ophthalmic	Ophthalmic								
Fetal Imaging & Other	Fetal								
	Abdominal	N	N	N	N	N	N	N	Note 1,4
	Intra-operative (Specify*)								
	Intra-operative (Neuro)								
	Laparoscopic								
	Pediatric	N	N	N	N	N	N	N	Note 1,4
	Small Organ (Specify**)								
	Neonatal Cephalic	N	N	N	N	N	N	N	Note 1,4
	Adult Cephalic	N	N	N	N	N	N	N	Note 1,4
	Trans-rectal								
	Trans-vaginal								
	Trans-urethral								
	Trans-esoph. (non-Card.)								
	Musculo-skeletal (Conventional)								
	Musculo-skeletal (Superficial)								
Intravascular									
Thoracic/Pleural (Specify****)	N	N	N			N	N	N	Note 1,4
Cardiac	Cardiac Adult	N	N	N	N	N	N	N	Note 1,3,4
	Cardiac Pediatric	N	N	N	N	N	N	N	Note 1,3,4
	Intravascular (Cardiac)								
	Trans-esoph. (Cardiac)								
Peripheral vessel	Intra-cardiac								
	Peripheral vessel								
	Other (Specify***)								
N=new indication ; P=previously cleared by FDA ; E=added under Appendix E									
Additional comments: Combined modes--B+M、 PW+B、 Color + B、 Power + B、 PW +Color+ B、 Power + PW +B.									
*Intraoperative includes abdominal, thoracic, and vascular etc.									
**Small organ-breast, thyroid, testes.									
***Other use includes Urology.									
****For detection of fluid and pleural motion/sliding.									
Note 1: Tissue Harmonic Imaging. The feature does not use contrast agents.									
Note 2: Contrast imaging (Contrast agent for LVO)									
Note 3: TDI									
Note 4: Color M									
Note 5: Smart 3D									
Note 6: Contrast imaging (Contrast agent for Liver)									
Note 7: iScape View									

Transducer:	C5-1s								
Intended Use:	Diagnostic ultrasound imaging or fluid flow analysis of the human body as follows:								
	Clinical Application	Mode of Operation							
General (Track 1 Only)	Specific (Track 1 & 3)	B	M	PWD	CWD	Color Doppler	Amplitude Doppler	Combined (specify)	Other (specify)
Ophthalmic	Ophthalmic								
Fetal Imaging & Other	Fetal	N	N	N		N	N	N	Note 1,4
	Abdominal	N	N	N		N	N	N	Note 1,6
	Intra-operative (Specify*)								
	Intra-operative (Neuro)								
	Laparoscopic								
	Pediatric	N	N	N		N	N	N	Note 1,4
	Small Organ (Specify**)								
	Neonatal Cephalic								
	Adult Cephalic								
	Trans-rectal								
	Trans-vaginal								
	Trans-urethral								
	Trans-esoph. (non-Card.)								
	Musculo-skeletal (Conventional)								
	Musculo-skeletal (Superficial)								
	Intravascular								
Thoracic/Pleural (Specify****)	N	N	N		N	N	N	Note 1,4	
Cardiac	Cardiac Adult								
	Cardiac Pediatric								
	Intravascular (Cardiac)								
	Trans-esoph. (Cardiac)								
	Intra-cardiac								
Peripheral vessel	Peripheral vessel	N	N	N		N	N	N	Note 1,4
	Other (Specify***)								
N=new indication ; P=previously cleared by FDA ; E=added under Appendix E									
Additional comments: Combined modes--B+M, PW+B, Color + B, Power + B, PW +Color+ B, Power + PW +B.									
*Intraoperative includes abdominal, thoracic, and vascular									
**Small organ-breast, thyroid, testes.									
***Other use includes Urology.									
****For detection of fluid and pleural motion/sliding.									
Note 1: Tissue Harmonic Imaging. The feature does not use contrast agents.									
Note 2: Contrast imaging (Contrast agent for LVO)									
Note 3: TDI									
Note 4: Color M									
Note 5: Smart 3D									
Note 6: Contrast imaging (Contrast agent for Liver)									
Note 7: iScape View									

K Indications for use

Transducer:	C4-1s								
Intended Use:	Diagnostic ultrasound imaging or fluid flow analysis of the human body as follows:								
	Clinical Application				Mode of Operation				
General (Track 1 Only)	Specific (Track 1 & 3)	B	M	PWD	CWD	Color Doppler	Amplitude Doppler	Combined (specify)	Other (specify)
Ophthalmic	Ophthalmic								
Fetal Imaging & Other	Fetal	N	N	N	N	N	N	N	Note 1,4
	Abdominal	N	N	N	N	N	N	N	Note 1,4,6
	Intra-operative (Specify*)								
	Intra-operative (Neuro)								
	Laparoscopic								
	Pediatric	N	N	N		N	N	N	Note 1,4
	Small Organ (Specify**)								
	Neonatal Cephalic								
	Adult Cephalic								
	Trans-rectal								
	Trans-vaginal								
	Trans-urethral								
	Trans-esoph. (non-Card.)								
	Musculo-skeletal (Conventional)	N	N	N		N	N	N	Note 1,4
	Musculo-skeletal (Superficial)								
Intravascular									
Thoracic/Pleural (Specify****)	N	N	N		N	N	N	Note 1,4	
Cardiac	Cardiac Adult	N	N	N		N	N	N	Note 1,4
	Cardiac Pediatric								
	Intravascular (Cardiac)								
	Trans-esoph. (Cardiac)								
	Intra-cardiac								
Peripheral vessel	Peripheral vessel								
	Other (Specify***)								
N=new indication ; P=previously cleared by FDA ; E=added under Appendix E									
Additional comments: Combined modes--B+M、 PW+B、 Color + B、 Power + B、 PW +Color+ B、 Power + PW +B.									
*Intraoperative includes abdominal, thoracic, and vascular									
**Small organ-breast, thyroid, testes.									
***Other use includes Urology.									
****For detection of fluid and pleural motion/sliding.									
Note 1: Tissue Harmonic Imaging. The feature does not use contrast agents.									
Note 2: Contrast imaging (Contrast agent for LVO)									
Note 3: TDI									
Note 4: Color M									
Note 5: Smart 3D									
Note 6: Contrast imaging (Contrast agent for Liver)									
Note 7: iScape View									

Transducer:	L9-3s								
Intended Use:	Diagnostic ultrasound imaging or fluid flow analysis of the human body as follows:								
	Clinical Application	Mode of Operation							
General (Track 1 Only)	Specific (Track 1 & 3)	B	M	PWD	CWD	Color Doppler	Amplitude Doppler	Combined (specify)	Other (specify)
Ophthalmic	Ophthalmic								
Fetal Imaging & Other	Fetal	N	N	N		N	N	N	Note 1,5,7
	Abdominal	N	N	N		N	N	N	Note 1,5,7
	Intra-operative (Specify*)								
	Intra-operative (Neuro)								
	Laparoscopic								
	Pediatric	N	N	N		N	N	N	Note 1,5,7
	Small Organ (Specify**)	N	N	N		N	N	N	Note 1,5,7
	Neonatal Cephalic								
	Adult Cephalic								
	Trans-rectal								
	Trans-vaginal								
	Trans-urethral								
	Trans-esoph. (non-Card.)								
	Musculo-skeletal (Conventional)	N	N	N		N	N	N	Note 1,5,7
	Musculo-skeletal (Superficial)	N	N	N		N	N	N	Note 1,5,7
Intravascular									
Thoracic/Pleural (Specify****)	N	N	N		N	N	N	Note 1,5,7	
Cardiac	Cardiac Adult								
	Cardiac Pediatric								
	Intravascular (Cardiac)								
	Trans-esoph. (Cardiac)								
	Intra-cardiac								
Peripheral vessel	Peripheral vessel	N	N	N		N	N	N	Note 1,5,7
	Other (Specify***)								
N=new indication ; P=previously cleared by FDA ; E=added under Appendix E									
Additional comments: Combined modes--B+M, PW+B, Color + B, Power + B, PW +Color+ B, Power + PW +B.									
*Intraoperative includes abdominal, thoracic, and vascular									
**Small organ-breast, thyroid, testes.									
***Other use includes Urology.									
****For detection of fluid and pleural motion/sliding.									
Note 1: Tissue Harmonic Imaging. The feature does not use contrast agents.									
Note 2: Contrast imaging (Contrast agent for LVO)									
Note 3: TDI									
Note 4: Color M									
Note 5: Smart 3D									
Note 6: Contrast imaging (Contrast agent for Liver)									
Note 7: iScape View									

K Indications for use

Transducer:	L11-3VNs								
Intended Use:	Diagnostic ultrasound imaging or fluid flow analysis of the human body as follows:								
	Clinical Application	Mode of Operation							
General (Track 1 Only)	Specific (Track 1 & 3)	B	M	PWD	CWD	Color Doppler	Amplitude Doppler	Combined (specify)	Other (specify)
Ophthalmic	Ophthalmic	N	N	N		N	N	N	Note 1,5
Fetal Imaging & Other	Fetal								
	Abdominal	N	N	N		N	N	N	Note 1,5,7
	Intra-operative (Specify*)								
	Intra-operative (Neuro)								
	Laparoscopic								
	Pediatric	N	N	N		N	N	N	Note 1,5,7
	Small Organ (Specify**)	N	N	N		N	N	N	Note 1,5,7
	Neonatal Cephalic								
	Adult Cephalic								
	Trans-rectal								
	Trans-vaginal								
	Trans-urethral								
	Trans-esoph. (non-Card.)								
	Musculo-skeletal (Conventional)	N	N	N		N	N	N	Note 1,5,7
	Musculo-skeletal (Superficial)	N	N	N		N	N	N	Note 1,5,7
Intravascular									
Thoracic/Pleural (Specify****)	N	N	N		N	N	N	Note 1,5,7	
Cardiac	Cardiac Adult								
	Cardiac Pediatric								
	Intravascular (Cardiac)								
	Trans-esoph. (Cardiac)								
	Intra-cardiac								
Peripheral vessel	Peripheral vessel	N	N	N		N	N	N	Note 1,5,7
	Other (Specify***)								
N=new indication ; P=previously cleared by FDA ; E=added under Appendix E									
Additional comments: Combined modes--B+M, PW+B, Color + B, Power + B, PW +Color+ B, Power + PW +B.									
*Intraoperative includes abdominal, thoracic, and vascular etc.									
**Small organ-breast, thyroid, testes.									
***Other use includes Urology.									
****For detection of fluid and pleural motion/sliding.									
Note 1: Tissue Harmonic Imaging. The feature does not use contrast agents.									
Note 2: Contrast imaging (Contrast agent for LVO)									
Note 3: TDI									
Note 4: Color M									
Note 5: Smart 3D									
Note 6: Contrast imaging (Contrast agent for Liver)									
Note 7: iScape View									

Transducer:	L12-3RCs								
Intended Use:	Diagnostic ultrasound imaging or fluid flow analysis of the human body as follows:								
	Clinical Application	Mode of Operation							
General (Track 1 Only)	Specific (Track 1 & 3)	B	M	PWD	CWD	Color Doppler	Amplitude Doppler	Combined (specify)	Other (specify)
Ophthalmic	Ophthalmic	N	N	N		N	N	N	Note 1,5
Fetal Imaging & Other	Fetal								
	Abdominal	N	N	N		N	N	N	Note 1,5,7
	Intra-operative (Specify*)								
	Intra-operative (Neuro)								
	Laparoscopic								
	Pediatric	N	N	N		N	N	N	Note 1,5,7
	Small Organ (Specify**)	N	N	N		N	N	N	Note 1,5,7
	Neonatal Cephalic								
	Adult Cephalic								
	Trans-rectal								
	Trans-vaginal								
	Trans-urethral								
	Trans-esoph. (non-Card.)								
	Musculo-skeletal (Conventional)	N	N	N		N	N	N	Note 1,5,7
	Musculo-skeletal (Superficial)	N	N	N		N	N	N	Note 1,5,7
Intravascular									
Thoracic/Pleural (Specify****)	N	N	N		N	N	N	Note 1,5,7	
Cardiac	Cardiac Adult								
	Cardiac Pediatric								
	Intravascular (Cardiac)								
	Trans-esoph. (Cardiac)								
	Intra-cardiac								
Peripheral vessel	Peripheral vessel	N	N	N		N	N	N	Note 1,5,7
	Other (Specify***)								
N=new indication ; P=previously cleared by FDA ; E=added under Appendix E									
Additional comments: Combined modes--B+M, PW+B, Color + B, Power + B, PW +Color+ B, Power + PW +B.									
*Intraoperative includes abdominal, thoracic, and vascular etc.									
**Small organ-breast, thyroid, testes.									
***Other use includes Urology.									
****For detection of fluid and pleural motion/sliding.									
Note 1: Tissue Harmonic Imaging. The feature does not use contrast agents.									
Note 2: Contrast imaging (Contrast agent for LVO)									
Note 3: TDI									
Note 4: Color M									
Note 5: Smart 3D									
Note 6: Contrast imaging (Contrast agent for Liver)									
Note 7: iScape View									

K Indications for use

Transducer:	L14-5Ws								
Intended Use:	Diagnostic ultrasound imaging or fluid flow analysis of the human body as follows:								
	Clinical Application	Mode of Operation							
General (Track 1 Only)	Specific (Track 1 & 3)	B	M	PWD	CWD	Color Doppler	Amplitude Doppler	Combined (specify)	Other (specify)
Ophthalmic	Ophthalmic								
Fetal Imaging & Other	Fetal								
	Abdominal	N	N	N		N	N	N	Note 1,5,7
	Intra-operative (Specify*)								
	Intra-operative (Neuro)								
	Laparoscopic								
	Pediatric	N	N	N		N	N	N	Note 1,5,7
	Small Organ (Specify**)	N	N	N		N	N	N	Note 1,5,7
	Neonatal Cephalic								
	Adult Cephalic								
	Trans-rectal								
	Trans-vaginal								
	Trans-urethral								
	Trans-esoph. (non-Card.)								
	Musculo-skeletal (Conventional)	N	N	N		N	N	N	Note 1,5,7
	Musculo-skeletal (Superficial)	N	N	N		N	N	N	Note 1,5,7
Intravascular									
Thoracic/Pleural (Specify****)	N	N	N		N	N	N	Note 1,5,7	
Cardiac	Cardiac Adult								
	Cardiac Pediatric								
	Intravascular (Cardiac)								
	Trans-esoph. (Cardiac)								
	Intra-cardiac								
Peripheral vessel	Peripheral vessel	N	N	N		N	N	N	Note 1,5,7
	Other (Specify***)								
N=new indication ; P=previously cleared by FDA ; E=added under Appendix E									
Additional comments: Combined modes--B+M, PW+B, Color + B, Power + B, PW +Color+ B, Power + PW +B.									
*Intraoperative includes abdominal, thoracic, and vascular etc.									
**Small organ-breast, thyroid, testes.									
***Other use includes Urology.									
****For detection of fluid and pleural motion/sliding.									
Note 1: Tissue Harmonic Imaging. The feature does not use contrast agents.									
Note 2: Contrast imaging (Contrast agent for LVO)									
Note 3: TDI									
Note 4: Color M									
Note 5: Smart 3D									
Note 6: Contrast imaging (Contrast agent for Liver)									
Note 7: iScape View									

Transducer:	L12-3VNs								
Intended Use:	Diagnostic ultrasound imaging or fluid flow analysis of the human body as follows:								
	Clinical Application	Mode of Operation							
General (Track 1 Only)	Specific (Track 1 & 3)	B	M	PWD	CWD	Color Doppler	Amplitude Doppler	Combined (specify)	Other (specify)
Ophthalmic	Ophthalmic	N	N	N		N	N	N	Note 1,5
Fetal Imaging & Other	Fetal								
	Abdominal	N	N	N		N	N	N	Note 1,5,7
	Intra-operative (Specify*)								
	Intra-operative (Neuro)								
	Laparoscopic								
	Pediatric	N	N	N		N	N	N	Note 1,5,7
	Small Organ (Specify**)	N	N	N		N	N	N	Note 1,5,7
	Neonatal Cephalic								
	Adult Cephalic								
	Trans-rectal								
	Trans-vaginal								
	Trans-urethral								
	Trans-esoph. (non-Card.)								
	Musculo-skeletal (Conventional)	N	N	N		N	N	N	Note 1,5,7
	Musculo-skeletal (Superficial)	N	N	N		N	N	N	Note 1,5,7
Intravascular									
Thoracic/Pleural (Specify****)	N	N	N		N	N	N	Note 1,5,7	
Cardiac	Cardiac Adult								
	Cardiac Pediatric								
	Intravascular (Cardiac)								
	Trans-esoph. (Cardiac)								
	Intra-cardiac								
Peripheral vessel	Peripheral vessel	N	N	N		N	N	N	Note 1,5,7
	Other (Specify***)								
N=new indication ; P=previously cleared by FDA ; E=added under Appendix E									
Additional comments: Combined modes--B+M, PW+B, Color + B, Power + B, PW +Color+ B, Power + PW +B.									
*Intraoperative includes abdominal, thoracic, and vascular etc.									
**Small organ-breast, thyroid, testes.									
***Other use includes Urology.									
****For detection of fluid and pleural motion/sliding.									
Note 1: Tissue Harmonic Imaging. The feature does not use contrast agents.									
Note 2: Contrast imaging (Contrast agent for LVO)									
Note 3: TDI									
Note 4: Color M									
Note 5: Smart 3D									
Note 6: Contrast imaging (Contrast agent for Liver)									
Note 7: iScape View									

K Indications for use

Transducer:	LAP13-4Cs								
Intended Use:	Diagnostic ultrasound imaging or fluid flow analysis of the human body as follows:								
	Clinical Application	Mode of Operation							
General (Track 1 Only)	Specific (Track 1 & 3)	B	M	PWD	CWD	Color Doppler	Amplitude Doppler	Combined (specify)	Other (specify)
Ophthalmic	Ophthalmic								
Fetal Imaging & Other	Fetal								
	Abdominal								
	Intra-operative (Specify*)								
	Intra-operative (Neuro)								
	Laparoscopic	N	N	N		N	N	N	Note 1,6
	Pediatric								
	Small Organ (Specify**)								
	Neonatal Cephalic								
	Adult Cephalic								
	Trans-rectal								
	Trans-vaginal								
	Trans-urethral								
	Trans-esoph. (non-Card.)								
	Musculo-skeletal (Conventional)								
	Musculo-skeletal (Superficial)								
Intravascular									
Thoracic/Pleural (Specify****)									
Cardiac	Cardiac Adult								
	Cardiac Pediatric								
	Intravascular (Cardiac)								
	Trans-esoph. (Cardiac)								
	Intra-cardiac								
Peripheral vessel	Peripheral vessel								
	Other (Specify***)								
N=new indication ; P=previously cleared by FDA ; E=added under Appendix E									
Additional comments: Combined modes--B+M、 PW+B、 Color + B、 Power + B、 PW +Color+ B、 Power + PW +B.									
*Intraoperative includes abdominal, thoracic, and vascular etc.									
**Small organ-breast, thyroid, testes.									
***Other use includes Urology.									
****For detection of fluid and pleural motion/sliding.									
Note 1: Tissue Harmonic Imaging. The feature does not use contrast agents.									
Note 2: Contrast imaging (Contrast agent for LVO)									
Note 3: TDI									
Note 4: Color M									
Note 5: Smart 3D									
Note 6: Contrast imaging (Contrast agent for Liver)									
Note 7: iScape View									

Transducer:	C9-3Ts								
Intended Use:	Diagnostic ultrasound imaging or fluid flow analysis of the human body as follows:								
	Clinical Application	Mode of Operation							
General (Track 1 Only)	Specific (Track 1 & 3)	B	M	PWD	CWD	Color Doppler	Amplitude Doppler	Combined (specify)	Other (specify)
Ophthalmic	Ophthalmic								
Fetal Imaging & Other	Fetal	N	N	N		N	N	N	Note1,4
	Abdominal	N	N	N		N	N	N	Note1,4,6
	Intra-operative (Specify*)	N	N	N		N	N	N	Note1,4
	Intra-operative (Neuro)								
	Laparoscopic								
	Pediatric	N	N	N		N	N	N	Note1,4
	Small Organ (Specify**)	N	N	N		N	N	N	Note1,4
	Neonatal Cephalic								
	Adult Cephalic								
	Trans-rectal								
	Trans-vaginal								
	Trans-urethral								
	Trans-esoph. (non-Card.)								
	Musculo-skeletal (Conventional)	N	N	N		N	N	N	Note1,4
	Musculo-skeletal (Superficial)	N	N	N		N	N	N	Note1,4
Intravascular									
Thoracic/Pleural (Specify****)									
Cardiac	Cardiac Adult								
	Cardiac Pediatric								
	Intravascular (Cardiac)								
	Trans-esoph. (Cardiac)								
	Intra-cardiac								
Peripheral vessel	Peripheral vessel	N	N	N		N	N	N	Note1,4
	Other (Specify***)								
N=new indication ; P=previously cleared by FDA ; E=added under Appendix E									
Additional comments: Combined modes--B+M, PW+B, Color + B, Power + B, PW +Color+ B, Power + PW +B.									
*Intraoperative includes abdominal, thoracic, and vascular etc.									
**Small organ-breast, thyroid, testes.									
***Other use includes Urology.									
****For detection of fluid and pleural motion/sliding.									
Note 1: Tissue Harmonic Imaging. The feature does not use contrast agents.									
Note 2: Contrast imaging (Contrast agent for LVO)									
Note 3: TDI									
Note 4: Color M									
Note 5: Smart 3D									
Note 6: Contrast imaging (Contrast agent for Liver)									
Note 7: iScape View									

K Indications for use

Transducer:	P8-3Ts								
Intended Use:	Diagnostic ultrasound imaging or fluid flow analysis of the human body as follows:								
	Clinical Application	Mode of Operation							
General (Track 1 Only)	Specific (Track 1 & 3)	B	M	PWD	CWD	Color Doppler	Amplitude Doppler	Combined (specify)	Other (specify)
Ophthalmic	Ophthalmic								
Fetal Imaging & Other	Fetal								
	Abdominal								
	Intra-operative (Specify*)								
	Intra-operative (Neuro)								
	Laparoscopic								
	Pediatric								
	Small Organ (Specify**)								
	Neonatal Cephalic								
	Adult Cephalic								
	Trans-rectal								
	Trans-vaginal								
	Trans-urethral								
	Trans-esoph. (non-Card.)								
	Musculo-skeletal (Conventional)								
	Musculo-skeletal (Superficial)								
Intravascular									
Thoracic/Pleural (Specify****)									
Cardiac	Cardiac Adult								
	Cardiac Pediatric								
	Intravascular (Cardiac)								
	Trans-esoph. (Cardiac)	N	N	N	N	N	N	N	Note 1,3,4
	Intra-cardiac								
Peripheral vessel	Peripheral vessel								
	Other (Specify****)								
N=new indication ; P=previously cleared by FDA ; E=added under Appendix E									
Additional comments: Combined modes--B+M、PW+B、Color + B、Power + B、PW +Color+ B、Power + PW +B.									
*Intraoperative includes abdominal, thoracic, and vascular etc.									
**Small organ-breast, thyroid, testes.									
***Other use includes Urology.									
****For detection of fluid and pleural motion/sliding.									
Note 1: Tissue Harmonic Imaging. The feature does not use contrast agents.									
Note 2: Contrast imaging (Contrast agent for LVO)									
Note 3: TDI									
Note 4: Color M									
Note 5: Smart 3D									
Note 6: Contrast imaging (Contrast agent for Liver)									
Note 7: iScape View									

Transducer:	P8-2Ts								
Intended Use:	Diagnostic ultrasound imaging or fluid flow analysis of the human body as follows:								
	Clinical Application			Mode of Operation					
General (Track 1 Only)	Specific (Track 1 & 3)	B	M	PWD	CWD	Color Doppler	Amplitude Doppler	Combined (specify)	Other (specify)
Ophthalmic	Ophthalmic								
Fetal Imaging & Other	Fetal								
	Abdominal								
	Intra-operative (Specify*)								
	Intra-operative (Neuro)								
	Laparoscopic								
	Pediatric								
	Small Organ (Specify**)								
	Neonatal Cephalic								
	Adult Cephalic								
	Trans-rectal								
	Trans-vaginal								
	Trans-urethral								
	Trans-esoph. (non-Card.)								
	Musculo-skeletal (Conventional)								
	Musculo-skeletal (Superficial)								
Intravascular									
Thoracic/Pleural (Specify****)									
Cardiac	Cardiac Adult								
	Cardiac Pediatric								
	Intravascular (Cardiac)								
	Trans-esoph. (Cardiac)	N	N	N	N	N	N	N	Note 1,3,4
Peripheral vessel	Intra-cardiac								
	Peripheral vessel								
	Other (Specify***)								
N=new indication ; P=previously cleared by FDA ; E=added under Appendix E									
Additional comments: Combined modes--B+M, PW+B, Color + B, Power + B, PW +Color+ B, Power + PW +B.									
*Intraoperative includes abdominal, thoracic, and vascular etc.									
**Small organ-breast, thyroid, testes.									
***Other use includes Urology.									
****For detection of fluid and pleural motion/sliding.									
Note 1: Tissue Harmonic Imaging. The feature does not use contrast agents.									
Note 2: Contrast imaging (Contrast agent for LVO)									
Note 3: TDI									
Note 4: Color M									
Note 5: Smart 3D									
Note 6: Contrast imaging (Contrast agent for Liver)									
Note 7: iScape View									

K Indications for use

Transducer:	SP5-1Ns								
Intended Use:	Diagnostic ultrasound imaging or fluid flow analysis of the human body as follows:								
	Clinical Application	Mode of Operation							
General (Track 1 Only)	Specific (Track 1 & 3)	B	M	PWD	CWD	Color Doppler	Amplitude Doppler	Combined (specify)	Other (specify)
Ophthalmic	Ophthalmic								
Fetal Imaging & Other	Fetal	N	N	N	N	N	N	N	Note 1,4
	Abdominal	N	N	N	N	N	N	N	Note 1,4
	Intra-operative (Specify*)								
	Intra-operative (Neuro)								
	Laparoscopic								
	Pediatric	N	N	N	N	N	N	N	Note 1,4
	Small Organ (Specify**)								
	Neonatal Cephalic	N	N	N	N	N	N	N	Note 1,4
	Adult Cephalic	N	N	N	N	N	N	N	Note 1,4
	Trans-rectal								
	Trans-vaginal								
	Trans-urethral								
	Trans-esoph. (non-Card.)								
	Musculo-skeletal (Conventional)								
	Musculo-skeletal (Superficial)								
Intravascular									
Thoracic/Pleural (Specify****)	N	N	N			N	N	N	Note 1,4
Cardiac	Cardiac Adult	N	N	N	N	N	N	N	Note 1,2,3,4
	Cardiac Pediatric	N	N	N	N	N	N	N	Note 1,3,4
	Intravascular (Cardiac)								
	Trans-esoph. (Cardiac)								
	Intra-cardiac								
Peripheral vessel	Peripheral vessel								
	Other (Specify***)								
N=new indication ; P=previously cleared by FDA ; E=added under Appendix E									
Additional comments: Combined modes--B+M、 PW+B、 Color + B、 Power + B、 PW +Color+ B、 Power + PW +B.									
*Intraoperative includes abdominal, thoracic, and vascular etc.									
**Small organ-breast, thyroid, testes.									
***Other use includes Urology.									
****For detection of fluid and pleural motion/sliding.									
Note 1: Tissue Harmonic Imaging. The feature does not use contrast agents.									
Note 2: Contrast imaging (Contrast agent for LVO)									
Note 3: TDI									
Note 4: Color M									
Note 5: Smart 3D									
Note 6: Contrast imaging (Contrast agent for Liver)									
Note 7: iScape View									

Transducer:	SC5-1Ns								
Intended Use:	Diagnostic ultrasound imaging or fluid flow analysis of the human body as follows:								
	Clinical Application	Mode of Operation							
General (Track 1 Only)	Specific (Track 1 & 3)	B	M	PWD	CWD	Color Doppler	Amplitude Doppler	Combined (specify)	Other (specify)
Ophthalmic	Ophthalmic								
Fetal Imaging & Other	Fetal	N	N	N		N	N	N	Note 1,4
	Abdominal	N	N	N		N	N	N	Note 1,4,6
	Intra-operative (Specify*)								
	Intra-operative (Neuro)								
	Laparoscopic								
	Pediatric	N	N	N		N	N	N	Note 1,4
	Small Organ (Specify**)								
	Neonatal Cephalic								
	Adult Cephalic								
	Trans-rectal								
	Trans-vaginal								
	Trans-urethral								
	Trans-esoph. (non-Card.)								
	Musculo-skeletal (Conventional)								
	Musculo-skeletal (Superficial)								
	Intravascular								
Thoracic/Pleural (Specify****)	N	N	N			N	N	N	Note 1,4
Cardiac	Cardiac Adult								
	Cardiac Pediatric								
	Intravascular (Cardiac)								
	Trans-esoph. (Cardiac)								
	Intra-cardiac								
Peripheral vessel	Peripheral vessel	N	N	N		N	N	N	Note 1,4
	Other (Specify***)								
N=new indication ; P=previously cleared by FDA ; E=added under Appendix E									
Additional comments: Combined modes--B+M, PW+B, Color + B, Power + B, PW +Color+ B, Power + PW +B.									
*Intraoperative includes abdominal, thoracic, and vascular									
**Small organ-breast, thyroid, testes.									
***Other use includes Urology.									
****For detection of fluid and pleural motion/sliding.									
Note 1: Tissue Harmonic Imaging. The feature does not use contrast agents.									
Note 2: Contrast imaging (Contrast agent for LVO)									
Note 3: TDI									
Note 4: Color M									
Note 5: Smart 3D									
Note 6: Contrast imaging (Contrast agent for Liver)									
Note 7: iScape View									

This page intentionally left blank.

